



40711





### **Get excited about our new packaging!**

We're switching from plastic to paper-based packaging. That's why you might find a mix of paper and plastic in our boxes!

### **Nos nouveaux emballages vous emballeront !**

Nous passons des emballages en plastique aux emballages à base de papier. C'est pourquoi vous pourriez trouver un mélange de papier et de plastique dans nos boîtes !

### **¡Te presentamos nuestros nuevos empaques!**

Estamos sustituyendo las bolsas de plástico por bolsas con base de papel. ¡Por eso, puedes encontrar una mezcla de papel y de plástico en nuestras cajas!

**[LEGO.com/sustainable-packaging](https://www.lego.com/sustainable-packaging)**

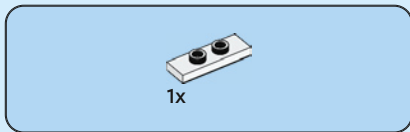

1





2x

2

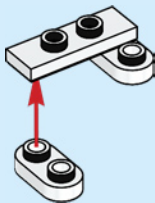





1x

3



1x



2x

4

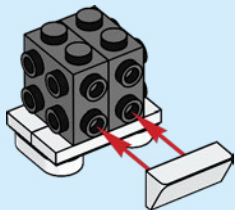



2x

5

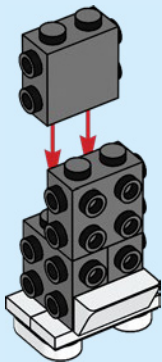

6





2x

6

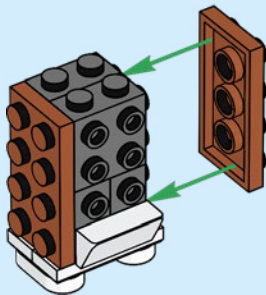

2x

7



2x

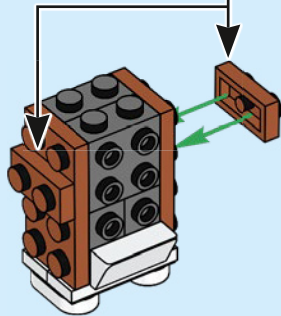



1x



1x



2x



1x

8

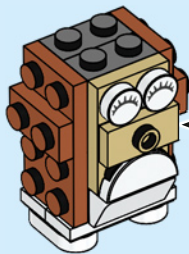

1



2





2x



2x

9

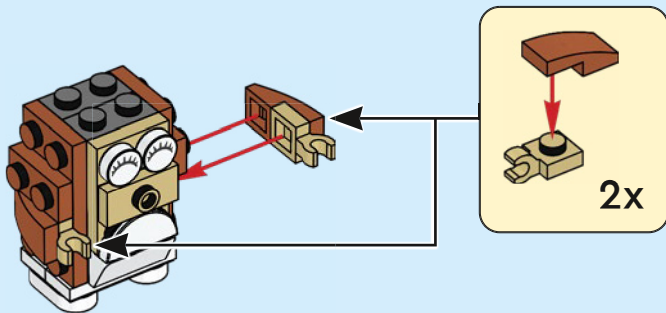



1x



1x

10

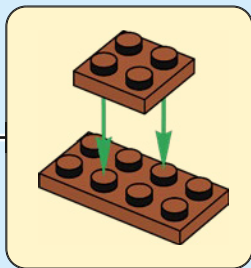
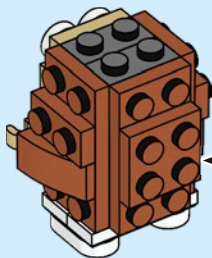

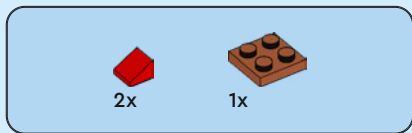

11

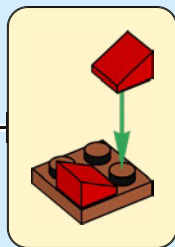
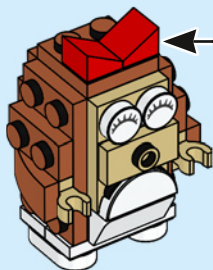



1x



1x

# 12

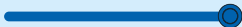
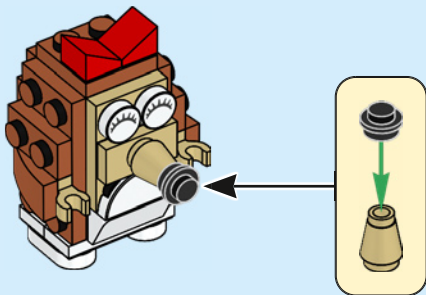





1x



1x

# 13



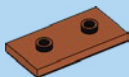

1x

14

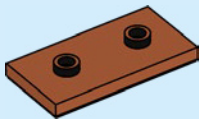

14



2x

15

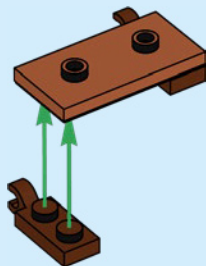



2x

16

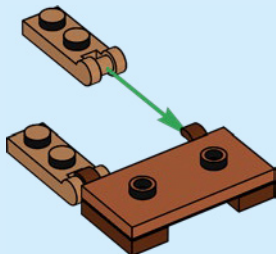

2x

17

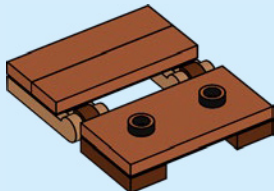



2x

18

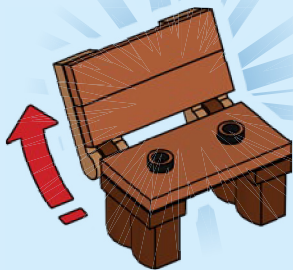

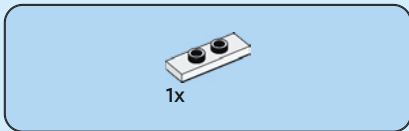
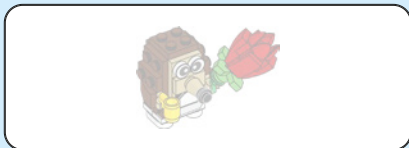

1

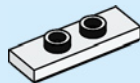



2x

2

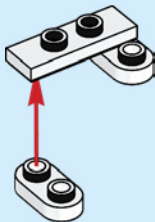



1x

3



1x



2x

4

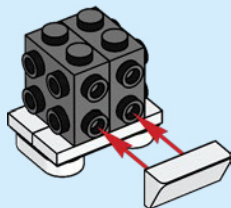



2x

5

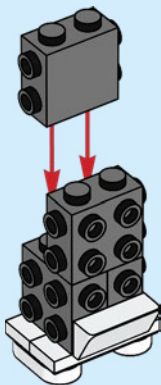





2x

6

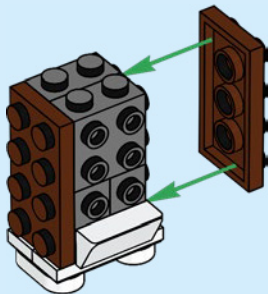

2x

7



2x

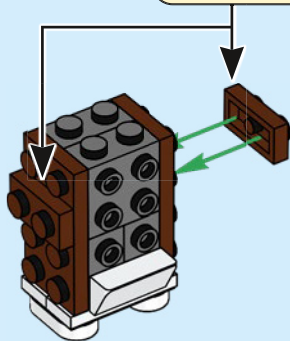



1x



1x



2x



1x

8

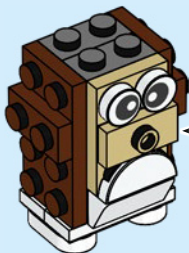

1



2





2x



2x

9

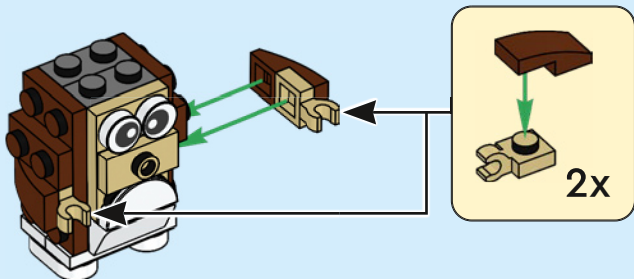



1x



1x

10

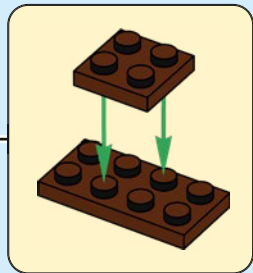
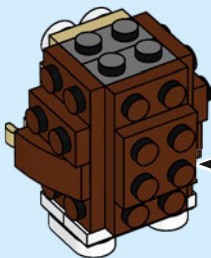



1x

11

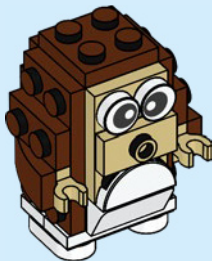



1x



1x



1x

# 12

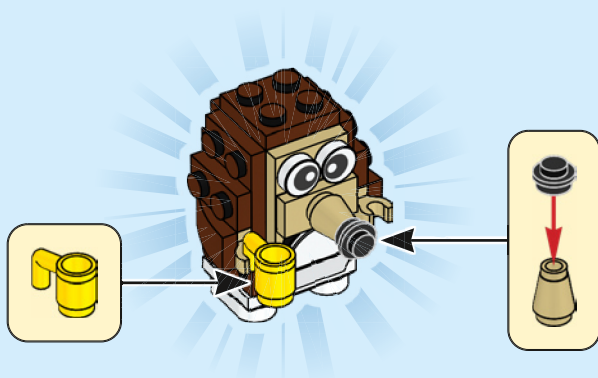



1x



1x

# 13

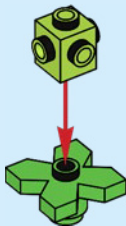

1x

# 14

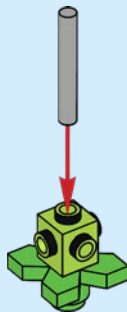



1x

15







4x



4x

16

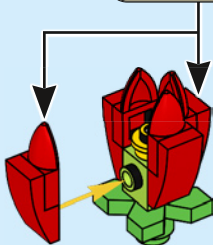
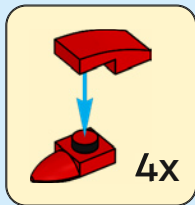

1x

17

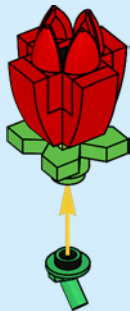

18

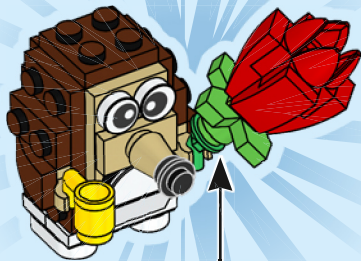



1x

19

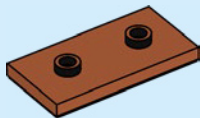

2x

20

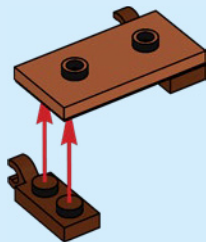



2x

21

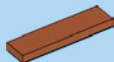
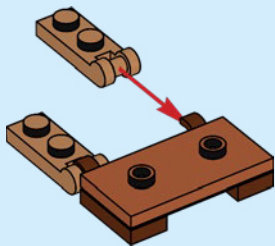

2x

22

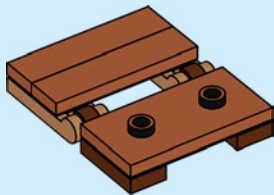



2x

23

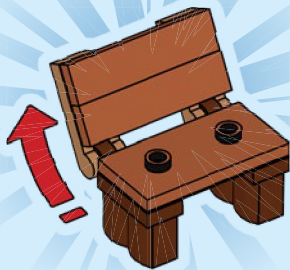



1x



1x



1x

# 24

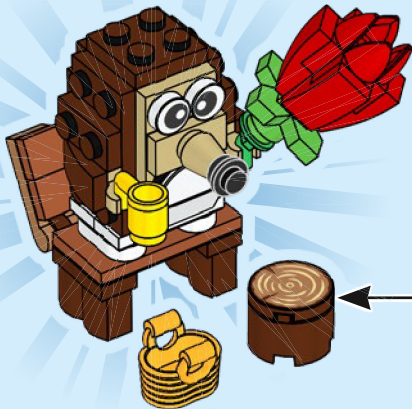

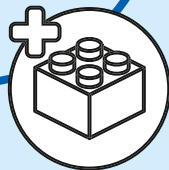
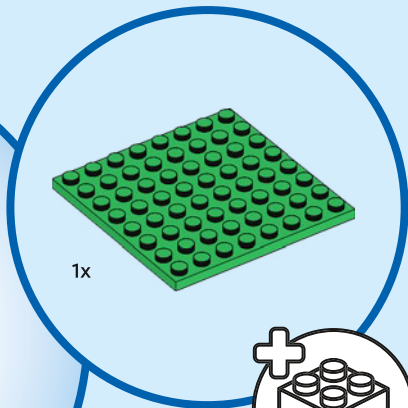

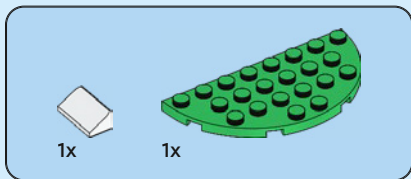

1

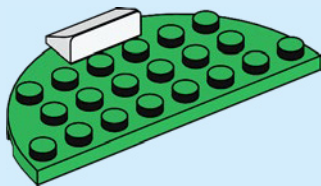





2x



1x

2

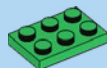
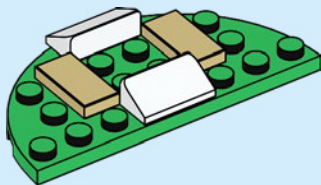

2x

3

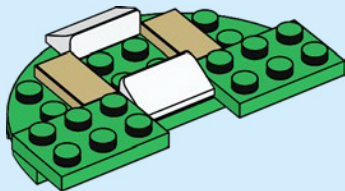

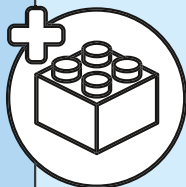
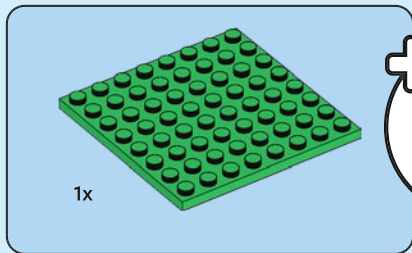

4

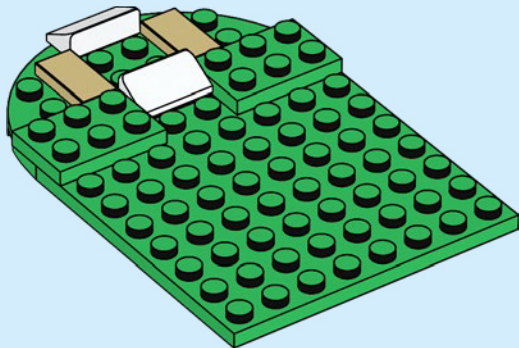

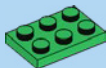

1x



1x

5

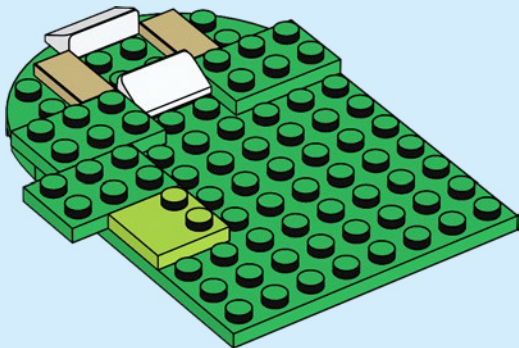

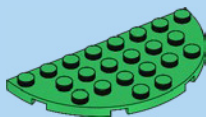

1x

6

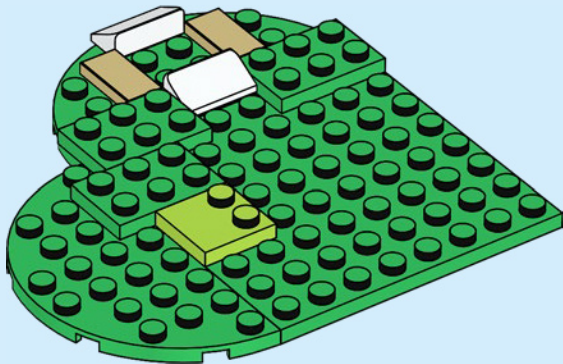



1x



2x

7

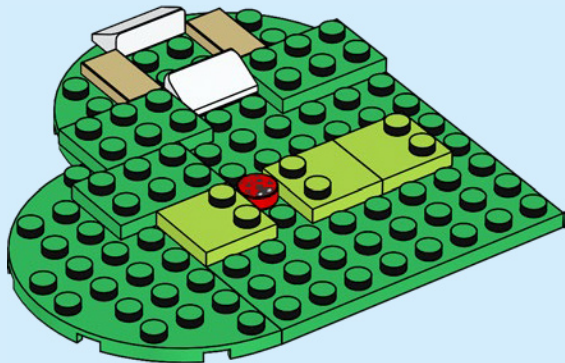

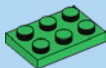

1x



1x

8

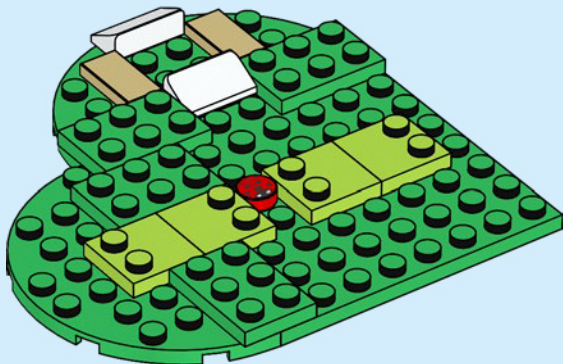



3x



3x

9

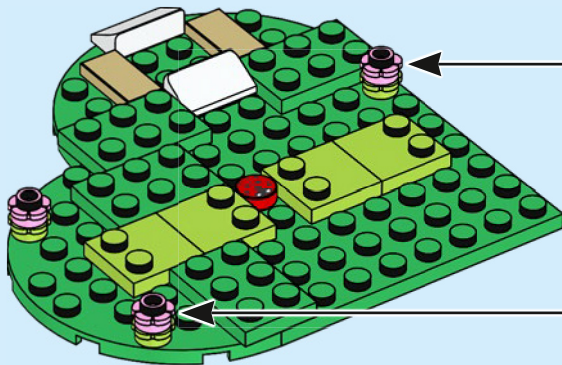

3x



1x



1x



1x

# 10

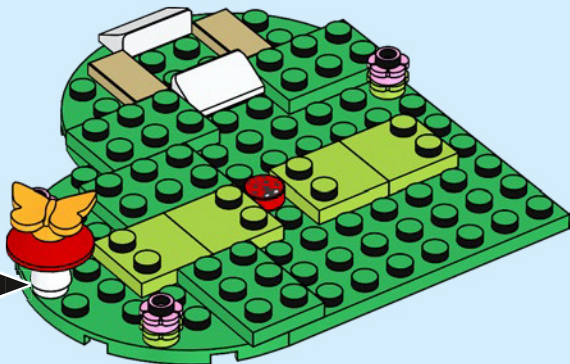
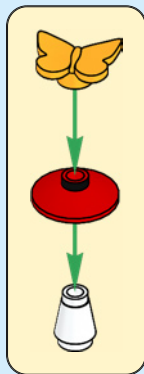





1x



2x

11

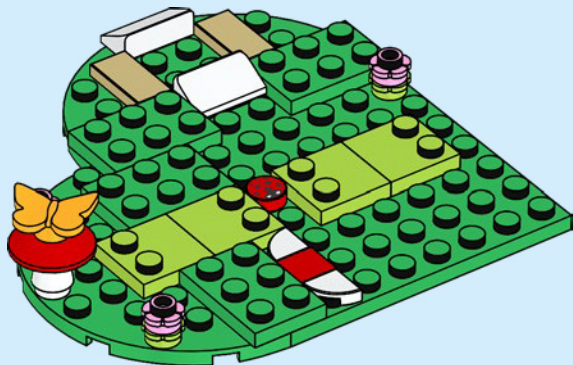

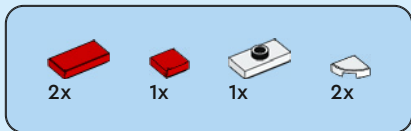

12

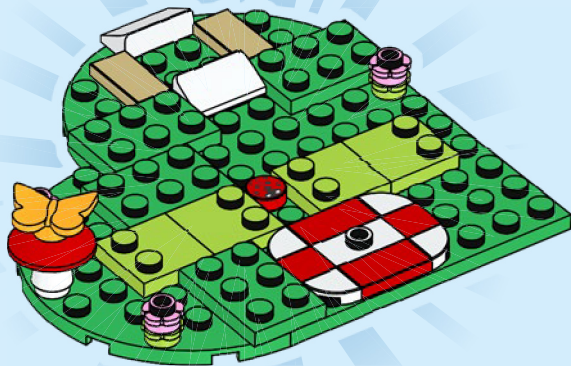

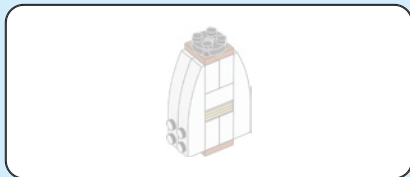

13





2x

14



1x

15





1x

16

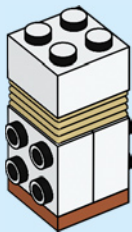

2x

17

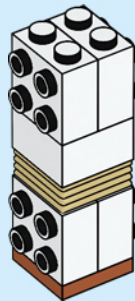



4x

18

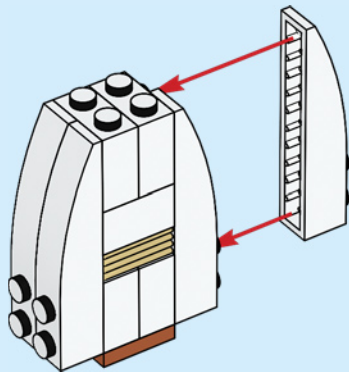

1x



1x

19

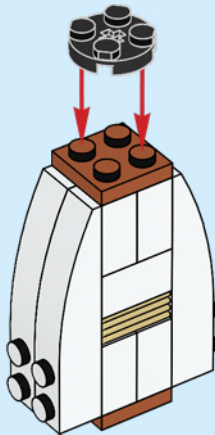

20

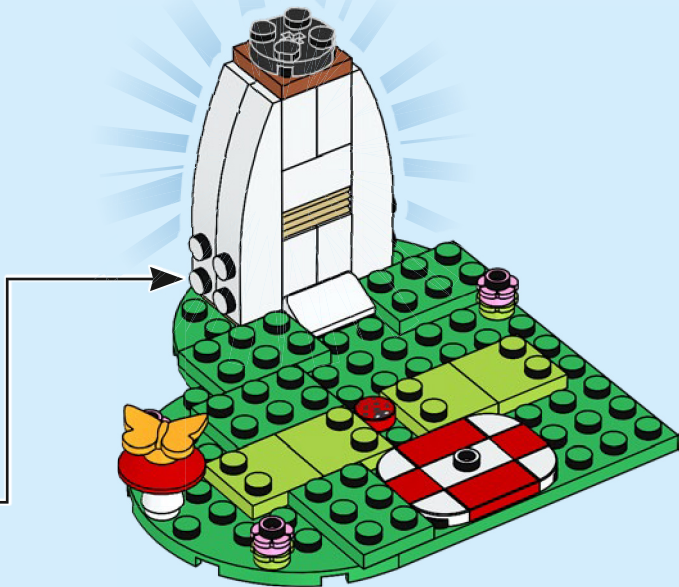

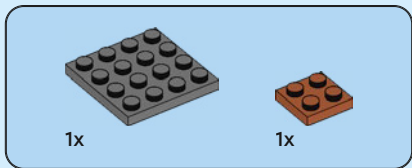
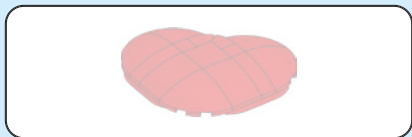

21

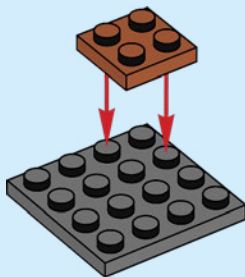



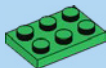

2x



1x

# 22

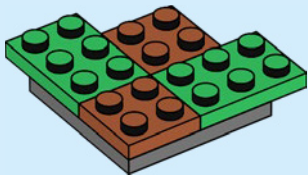

1x

# 23

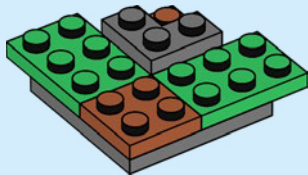



1x

24

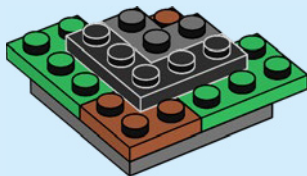



1x

25

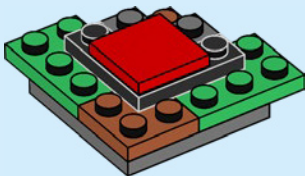



2x

26

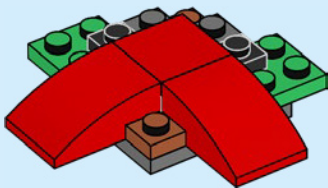

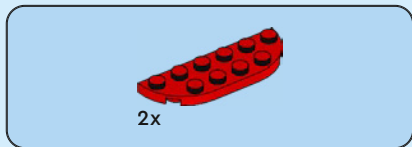

27

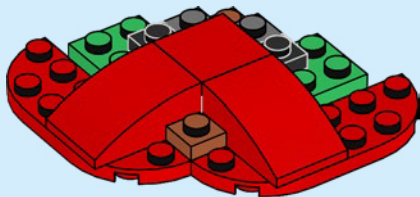



2x



1x

# 28

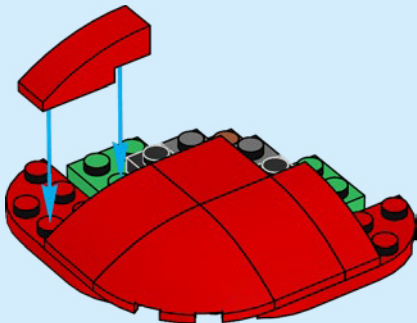



2x

29

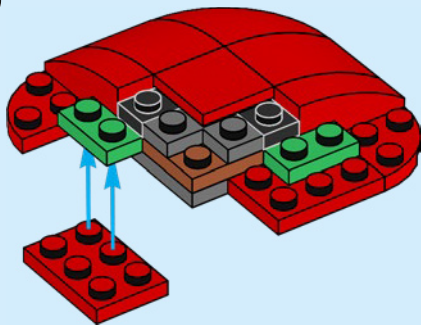



2x



1x



1x

# 30

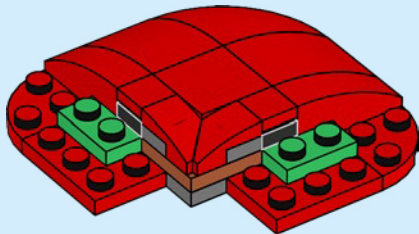





2x

# 31

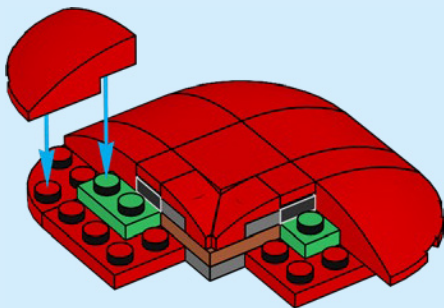



2x

32

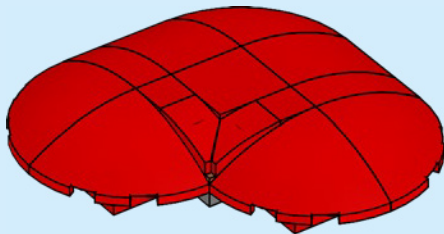

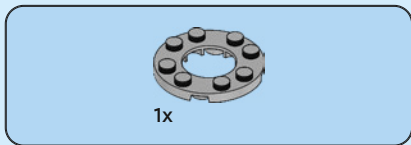

33

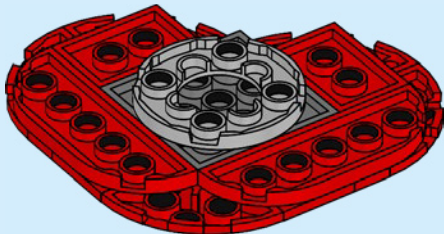

34

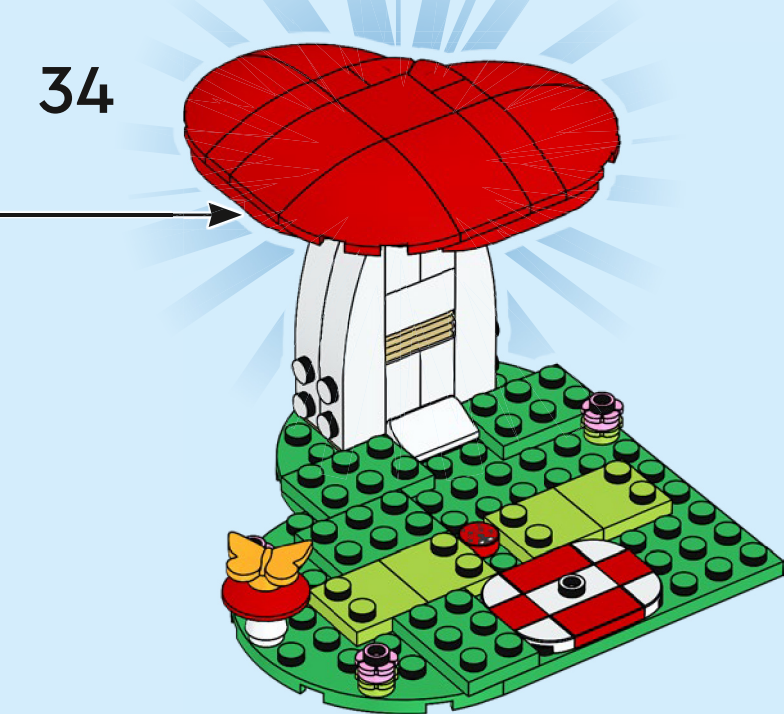



  
2x  
6284599

  
1x  
4518400

  
2x  
6284604

  
4x  
6172366

  
2x  
6400114

  
4x  
6210272

  
4x  
4547489

  
4x  
6218823

  
1x  
6051511

**66**

  
1x  
300301

  
4x  
6195371

  
4x  
4160387

  
2x  
4529237

  
4x  
6347292

  
2x  
6092587

  
2x  
4114026

  
1x  
6330903

  
2x  
4118790

  
1x  
6449709

  
4x  
307021

  
1x  
6177505

  
2x  
4504379

  
4x  
6078640

  
1x  
6177507

  
1x  
4585146

  
4x  
6029946

  
2x  
306921

  
1x  
306821

  
5x  
6435045

  
2x  
4251162

  
2x  
302121

  
2x  
6132210

  
2x  
6108802

  
1x  
6168644

  
2x  
389924

  
2x  
614126

  
1x  
403226

  
1x  
6439175

  
2x  
4570877

  
2x  
6186009

  
6x  
4615606

  
4x  
6074893



2x  
6288614



3x  
4535928



1x  
4143562



6x  
302128



2x  
6133767

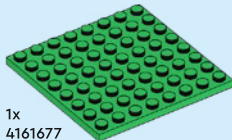

1x  
4161677



1x  
6382575



3x  
6209692



1x  
6174006



4x  
6472552



1x  
6096091



1x  
6370534



1x  
6182435



1x  
4211166



4x  
4211180



2x  
4211150



2x  
6069984



1x  
6139435



4x  
6338135



2x  
4216695



3x  
4211186



1x  
6093527



1x  
6167798



8x  
6314192



1x  
4210635



1x  
4243831



3x  
6212501



4x  
6167699



[LEGO.com/service](https://www.LEGO.com/service)

YOU COULD  
**WIN**



Scan this QR code or go to  
**LEGO.COM/PRODUCTFEEDBACK** and give us  
your short feedback about this LEGO® set  
for a chance to win a cool LEGO prize.

Terms and Conditions apply\*

**EN: YOU COULD WIN.** Terms and Conditions apply\* **DE: Du könntest GEWINNEN.** Es gelten die Teilnahmebedingungen\* **FR: Tu pourrais GAGNER.** Des conditions s'appliquent\* **IT: Potresti VINCERE tu.** Termini e condizioni sono applicabili\* **ES: Puedes GANAR.** Aplican términos y condiciones\* **PT: Poderá GANHAR.** Aplicam-se termos e condições\* **ZH: 轻松获奖.** 条款和条件适用\* **PL: Szansa na WYGRANĄ.** Obowiązują warunki korzystania\* **CS: Máte šanci VYHRÁT.** Platí všeobecné smluvní podmínky\* **SK: Máte šancu VYHRÁT.** Platia všeobecné zmluvné podmienky\* **HU: TE IS NYERHETSZ.** Felhasználási feltételek érvényesek\* **RO: Ai putea CÂȘTIGA.** Se aplică termenii și condiții\* **BG: Можете да СПЕЧЕЛИТЕ.** Има определени правила и условия\* **LV: Tu vari LAIMĒT.** Ir spēkā noteikumi un nosacījumi.\* **ET: Sul on võimalus VÕITA.** Kehtivad tingimused\* **LT: Jūs galite LAIMĖTI.** Taikomos sąlygos\*

\*[LEGO.com/productfeedback-terms](https://www.lego.com/productfeedback-terms)

LEGO and the LEGO logo are trademarks of the/son des marques de commerce du/  
son marcas registradas de LEGO Group. ©2024 The LEGO Group.

6490266