

# Friends



41007

1



2



3



4



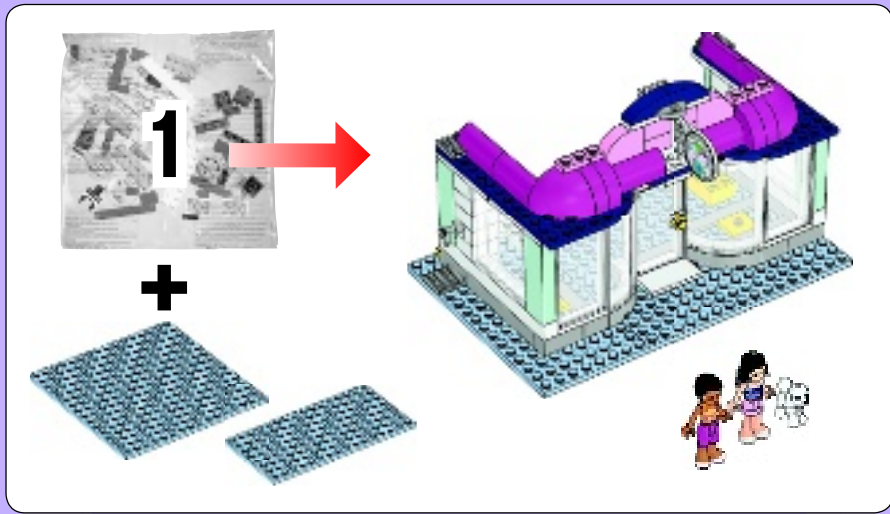

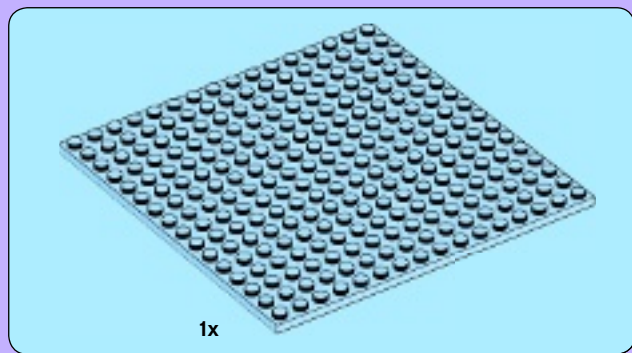

1

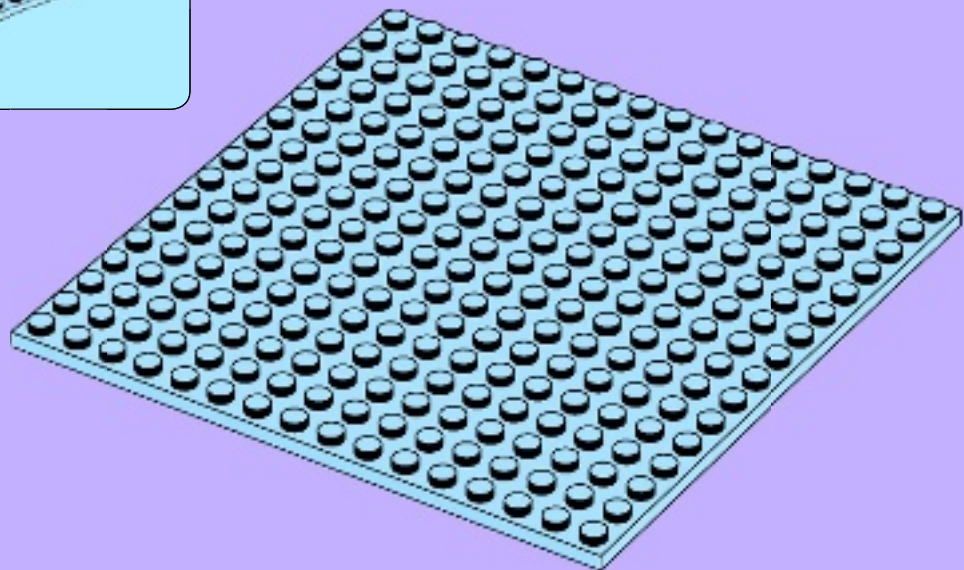

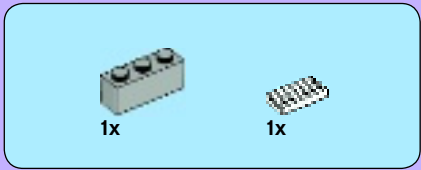

2

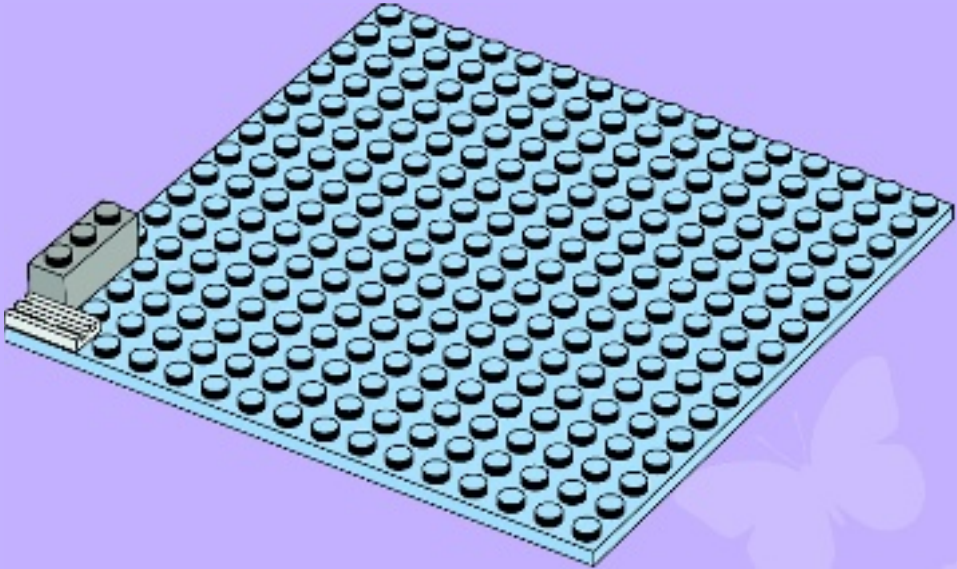

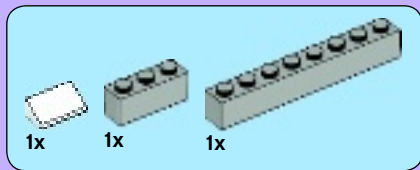

3

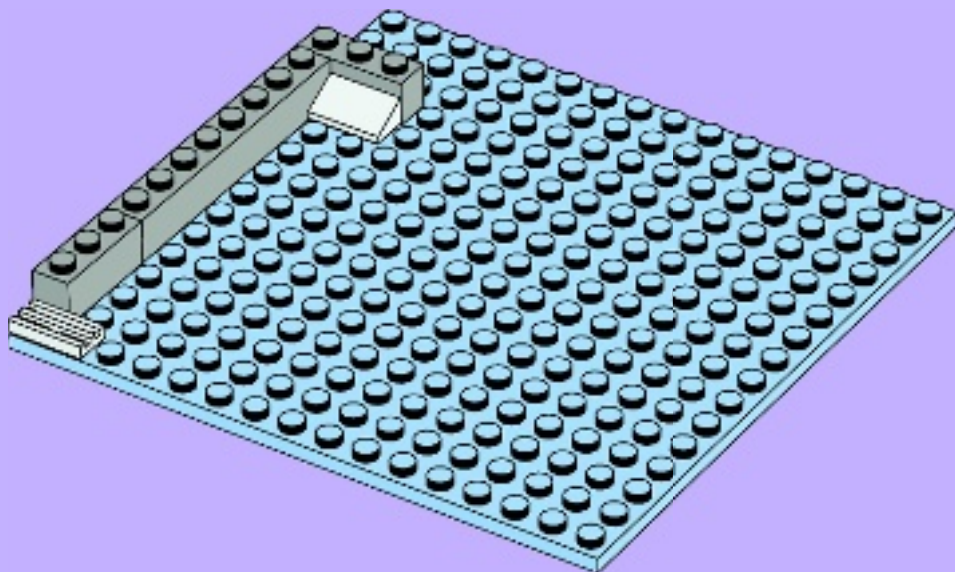

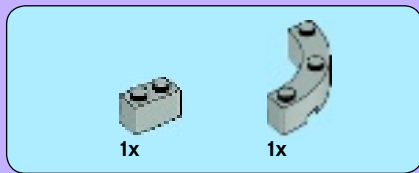

4

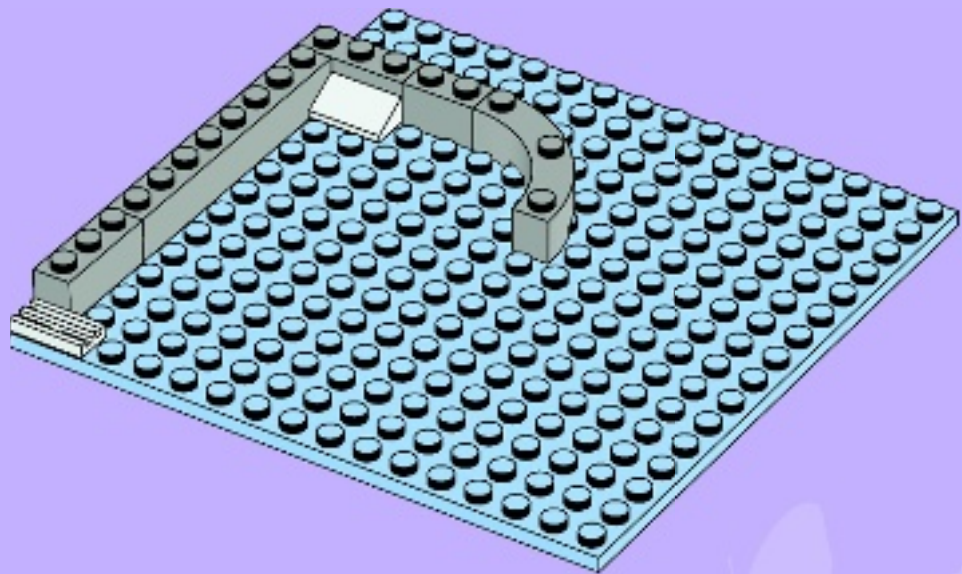

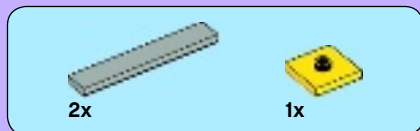

5

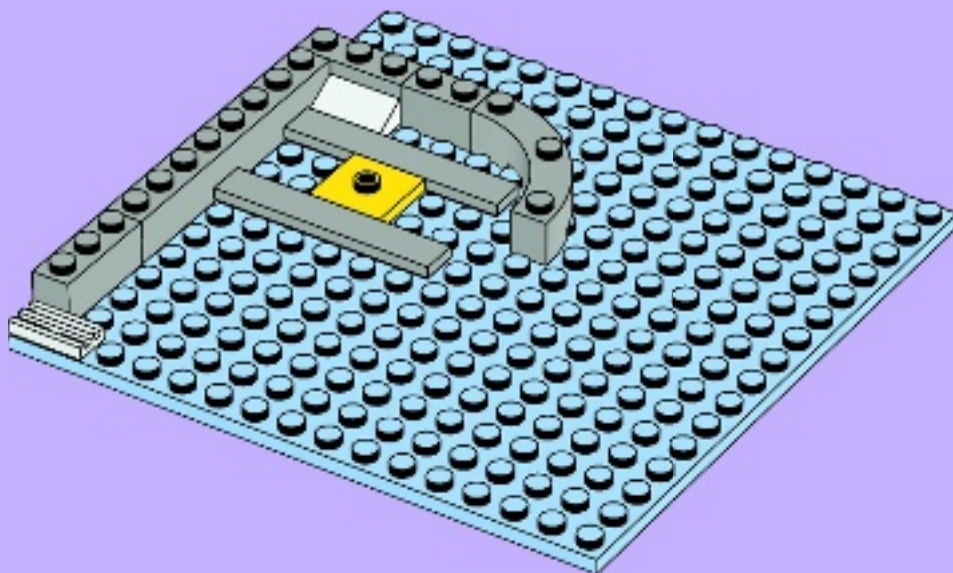





6

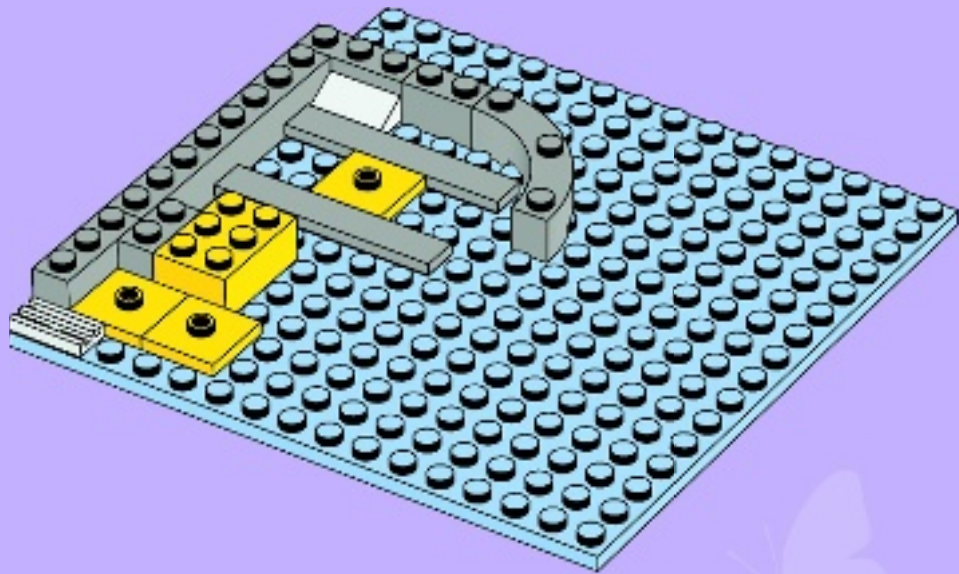

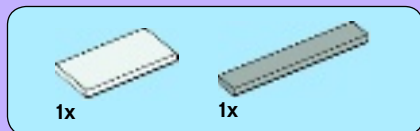

7

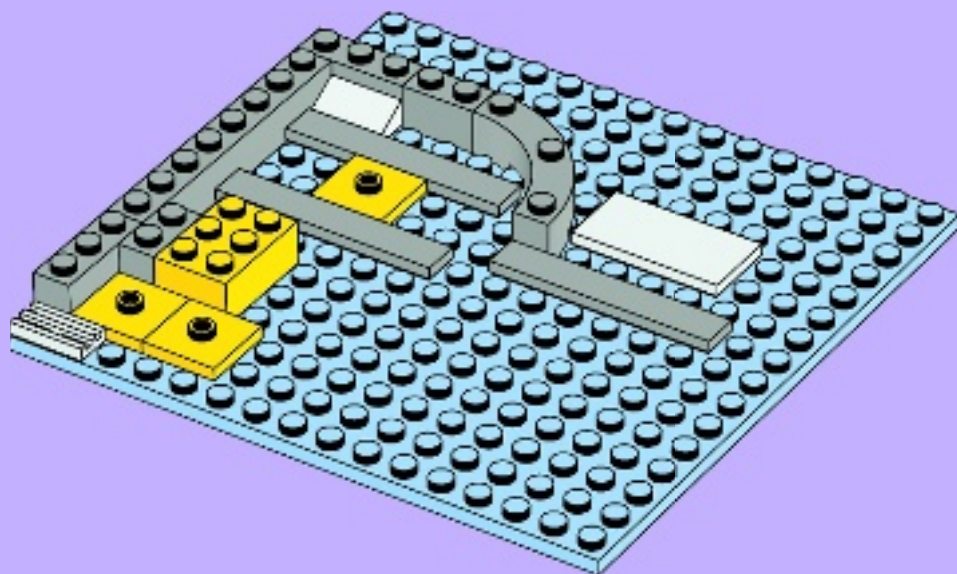

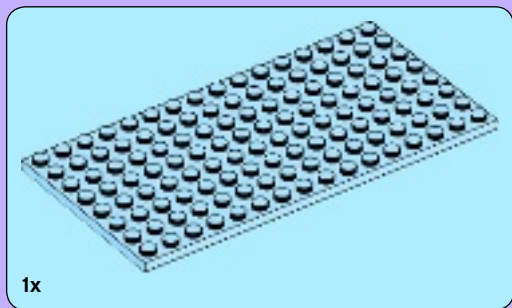

8

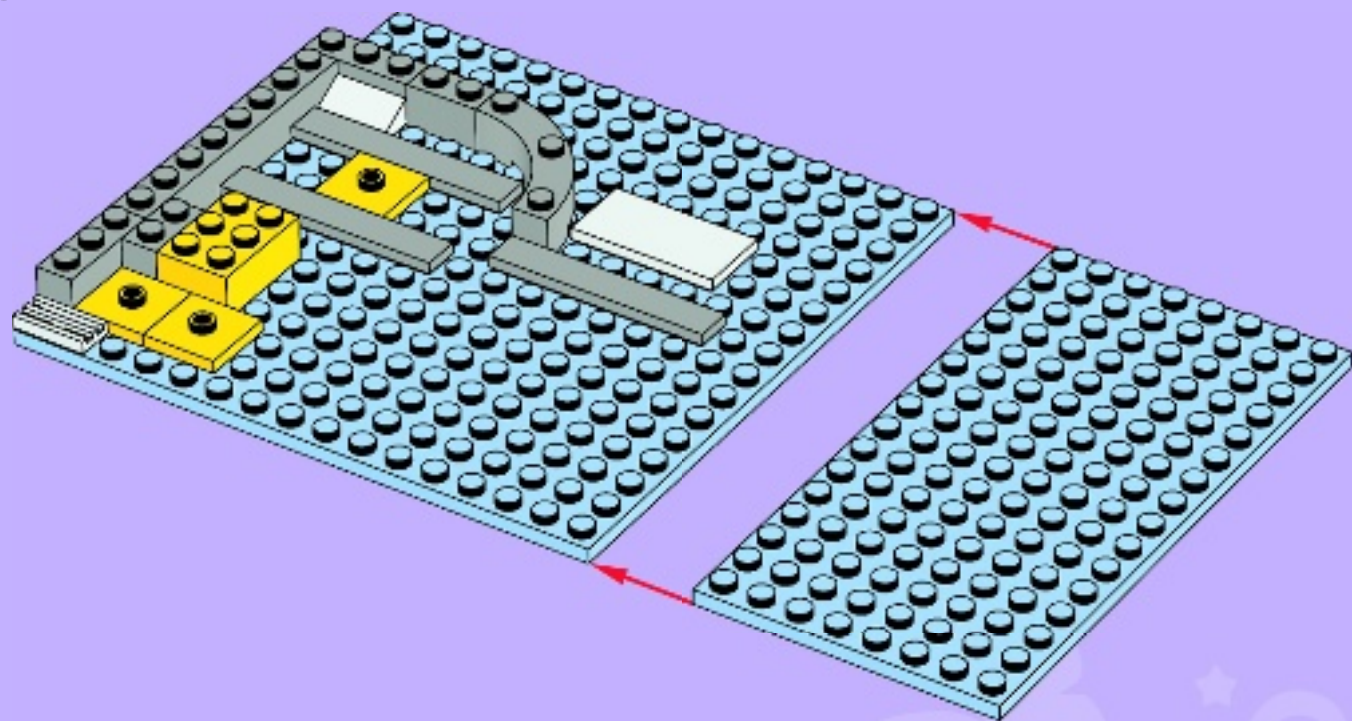

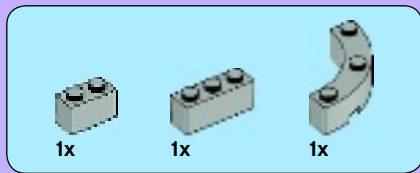

9

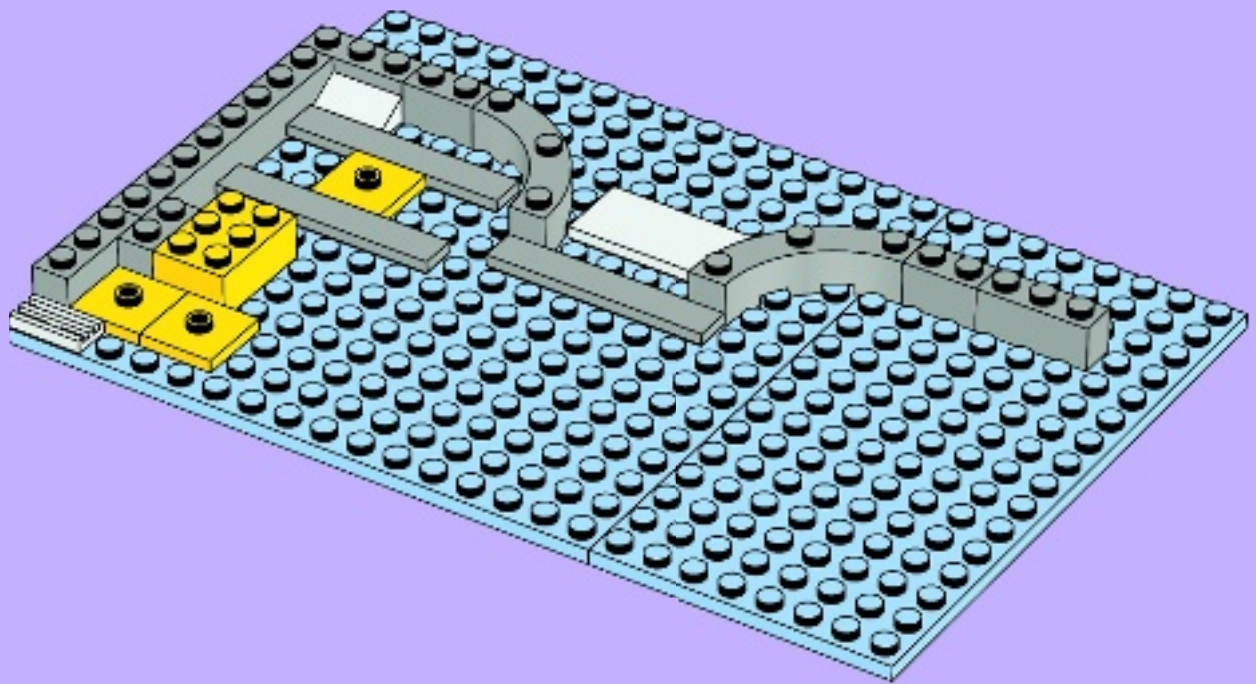

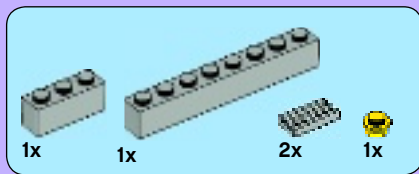

10

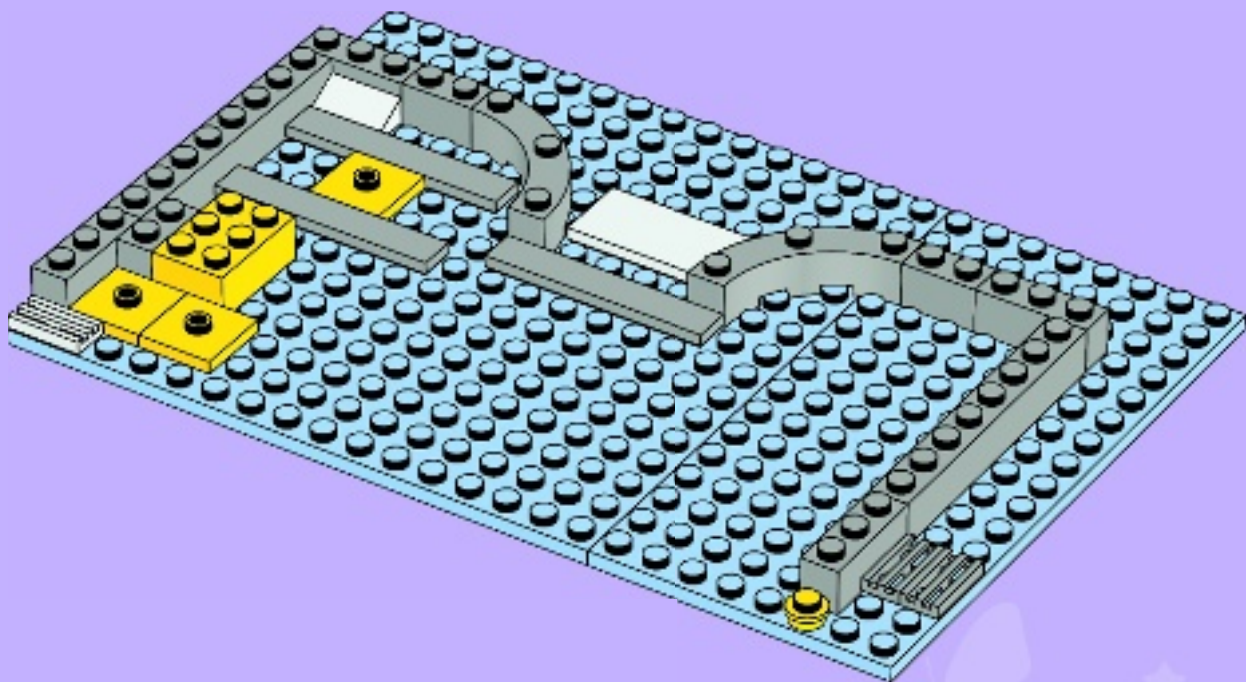

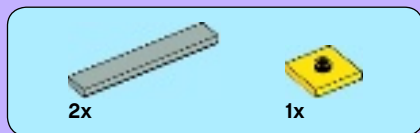

# 11

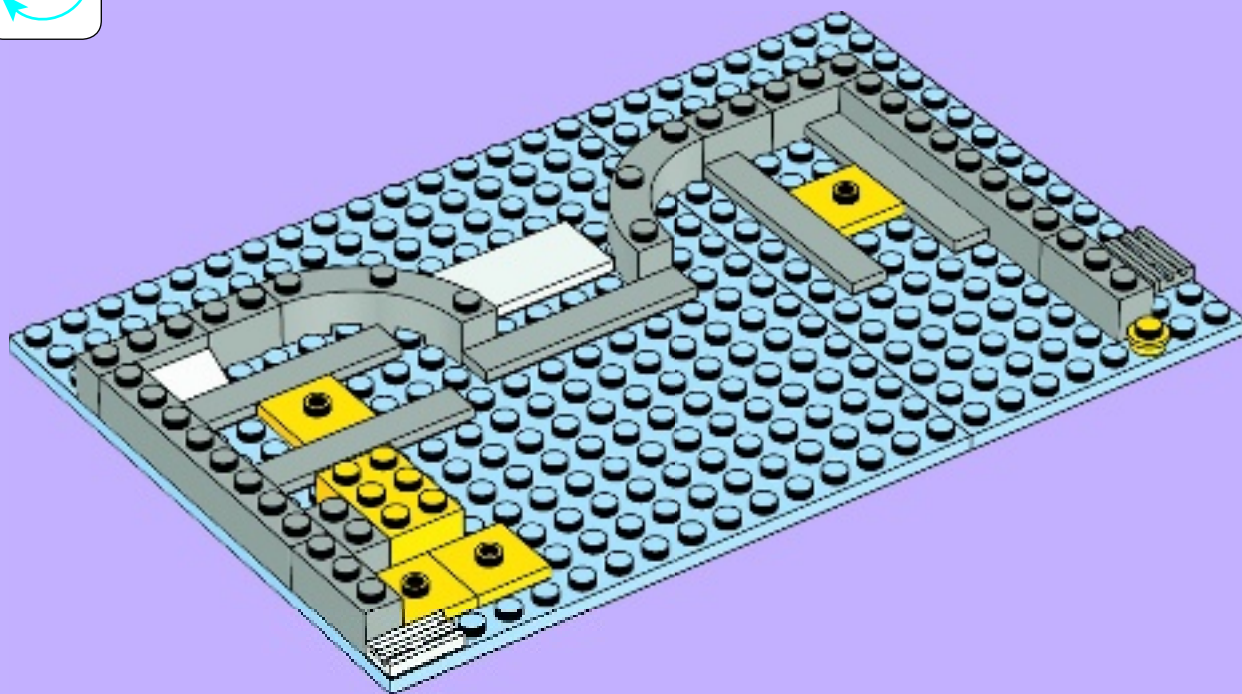
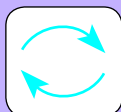

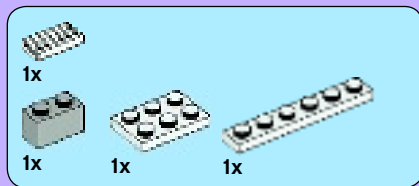

# 12

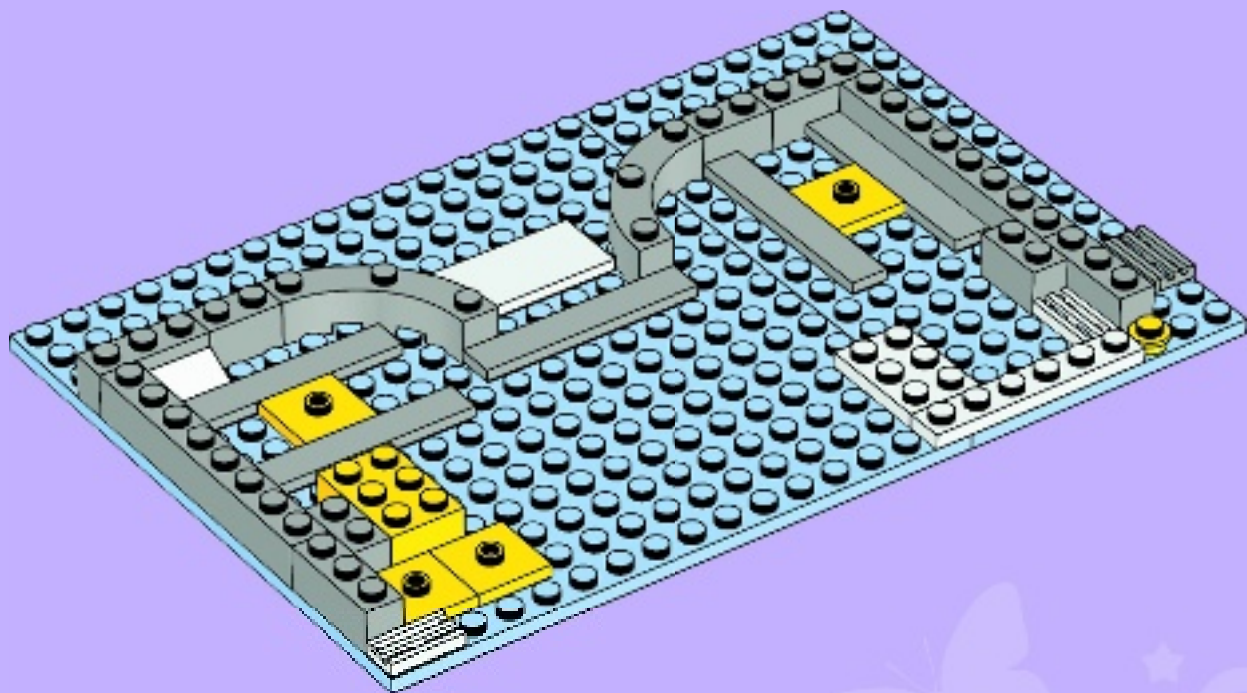

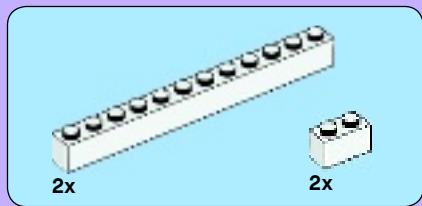

13

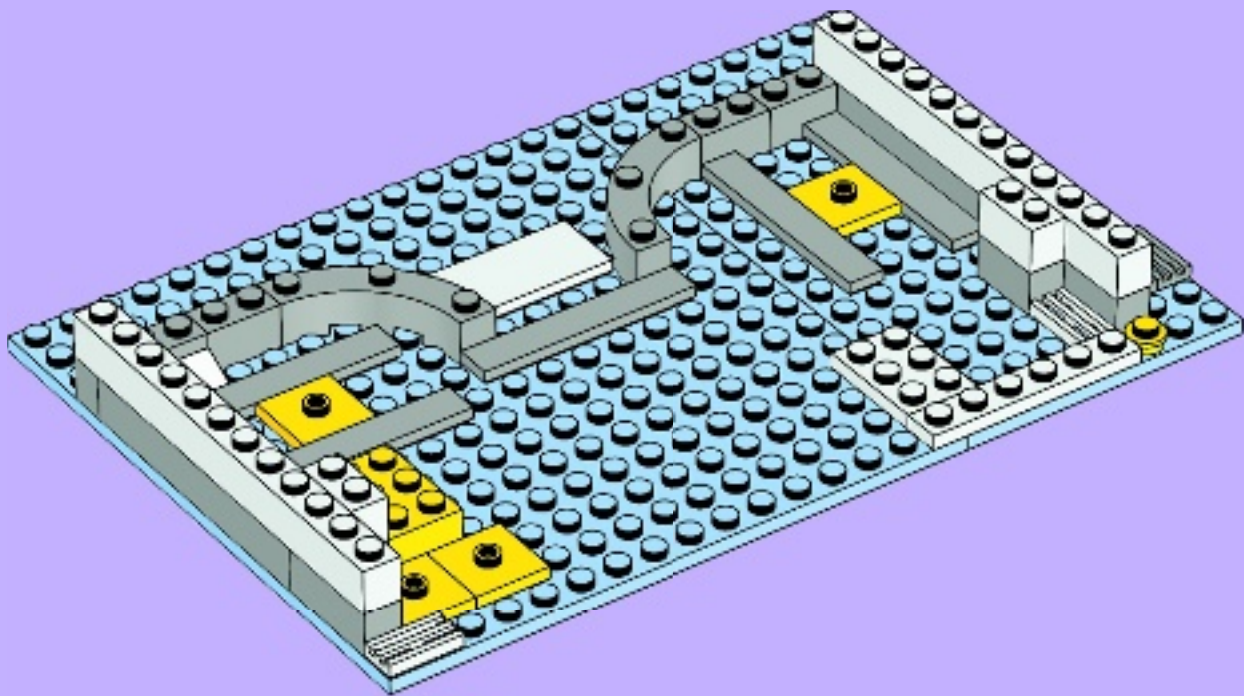



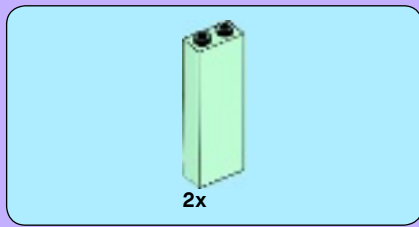

14

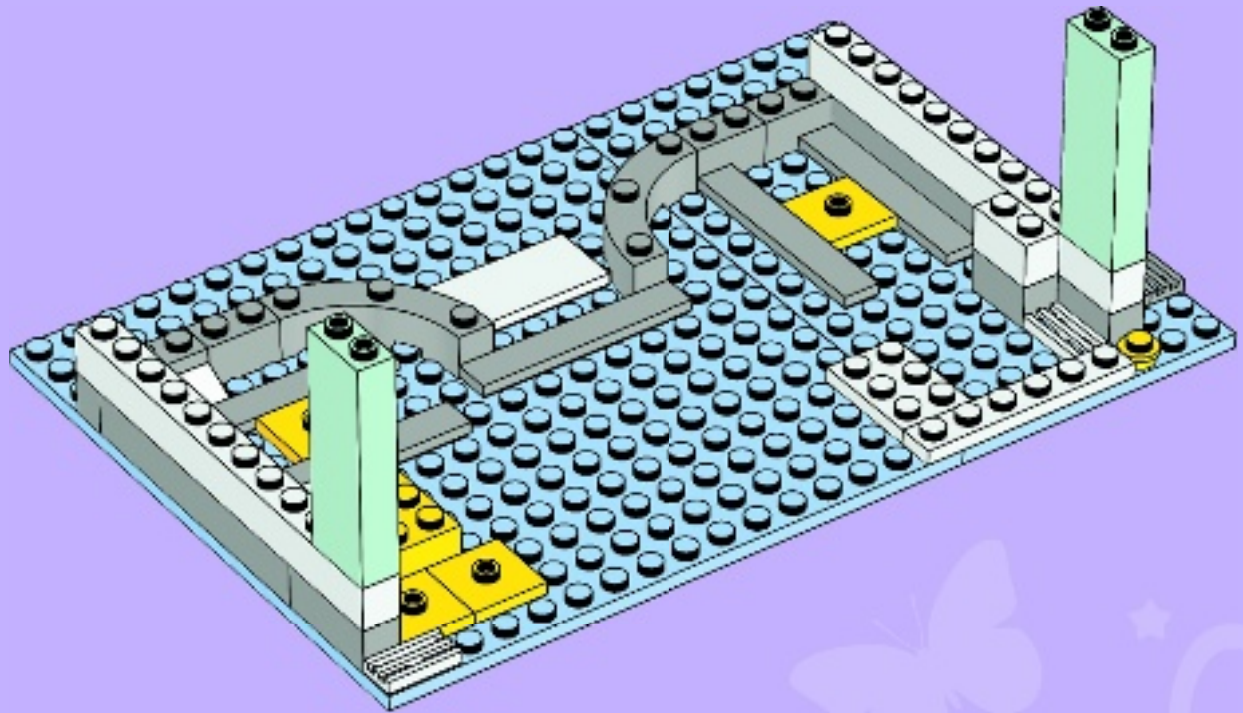



# 15

1

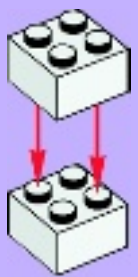

2

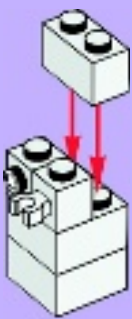

3

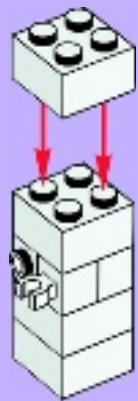

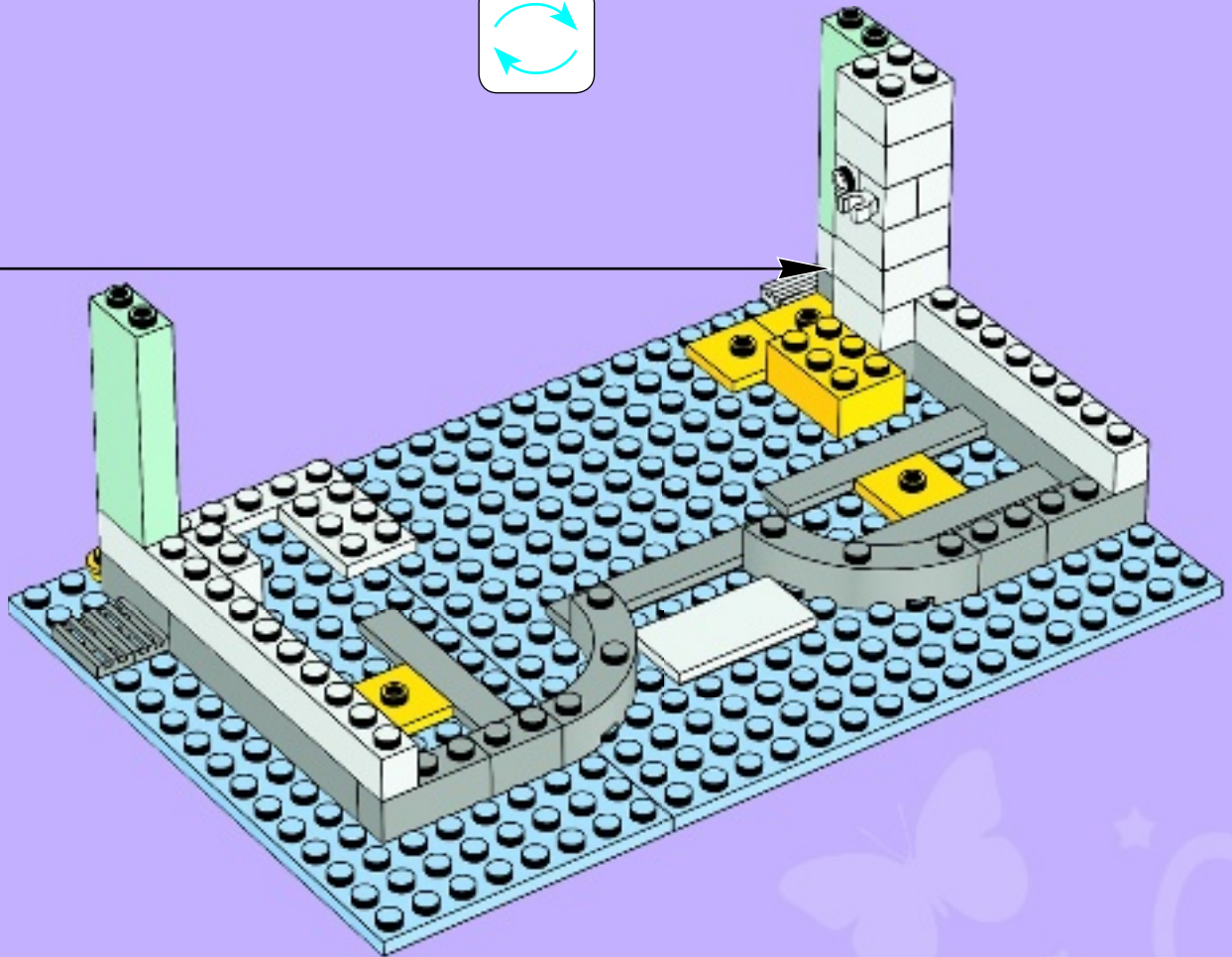
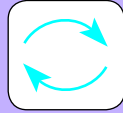

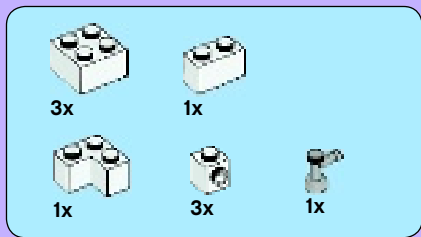

# 16

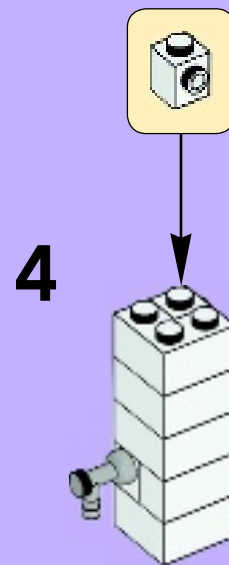
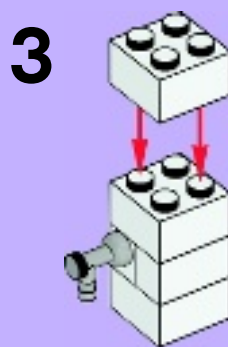
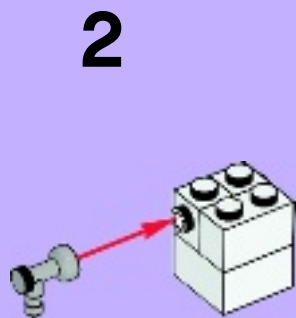
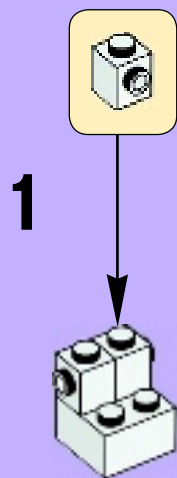

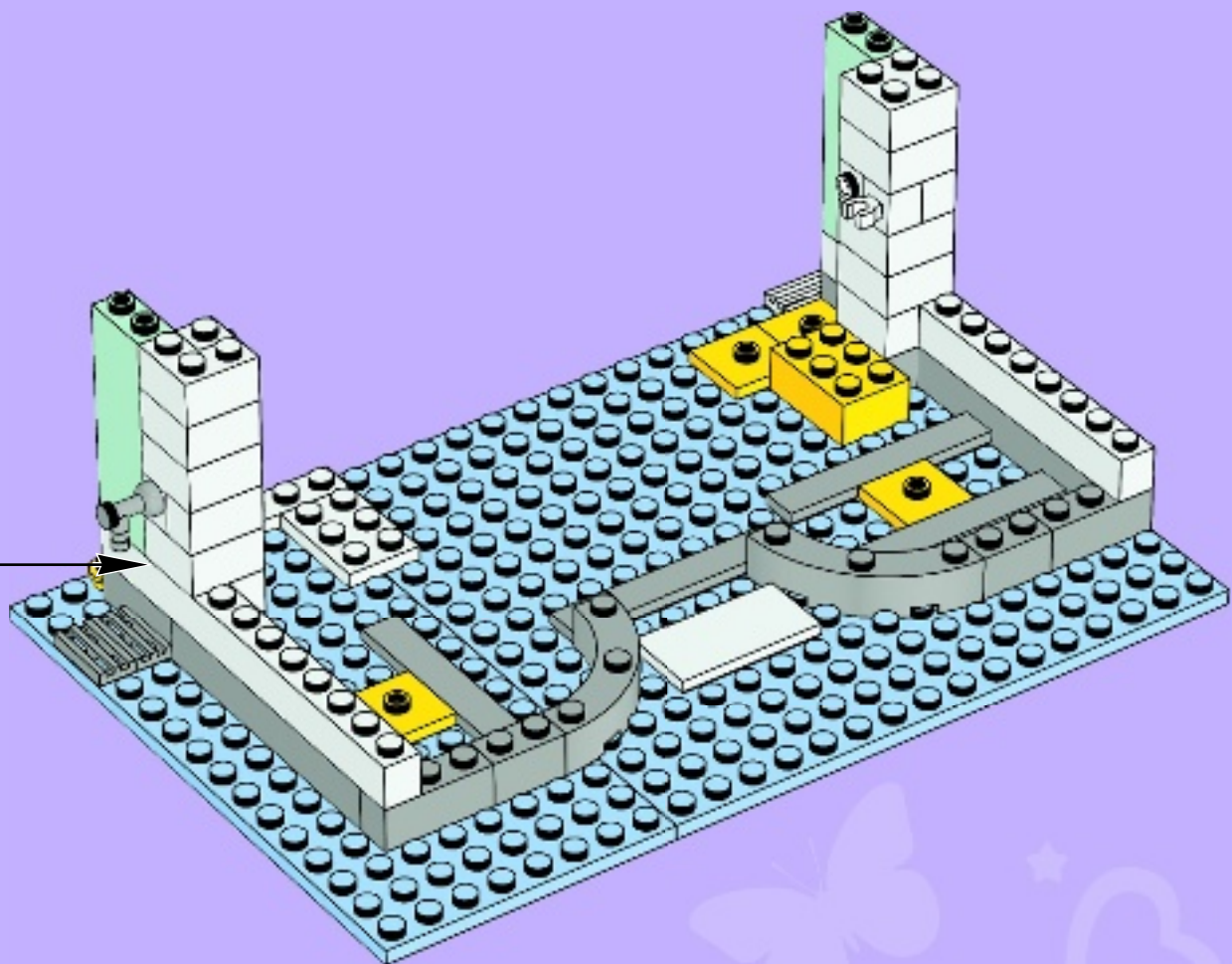

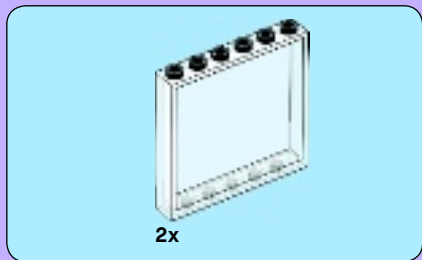

17

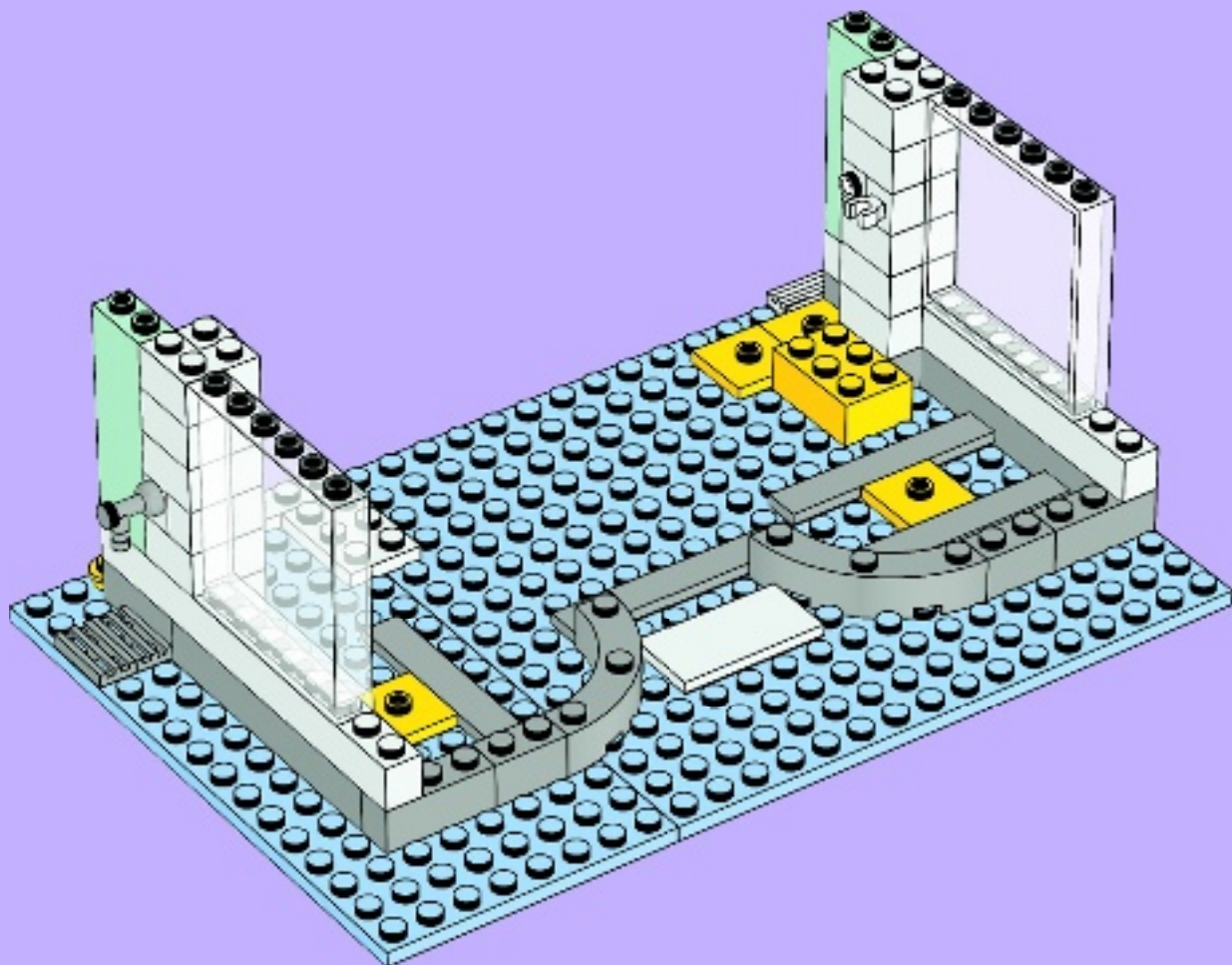

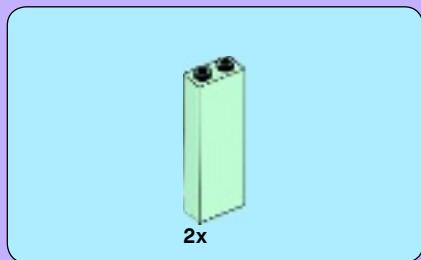

18

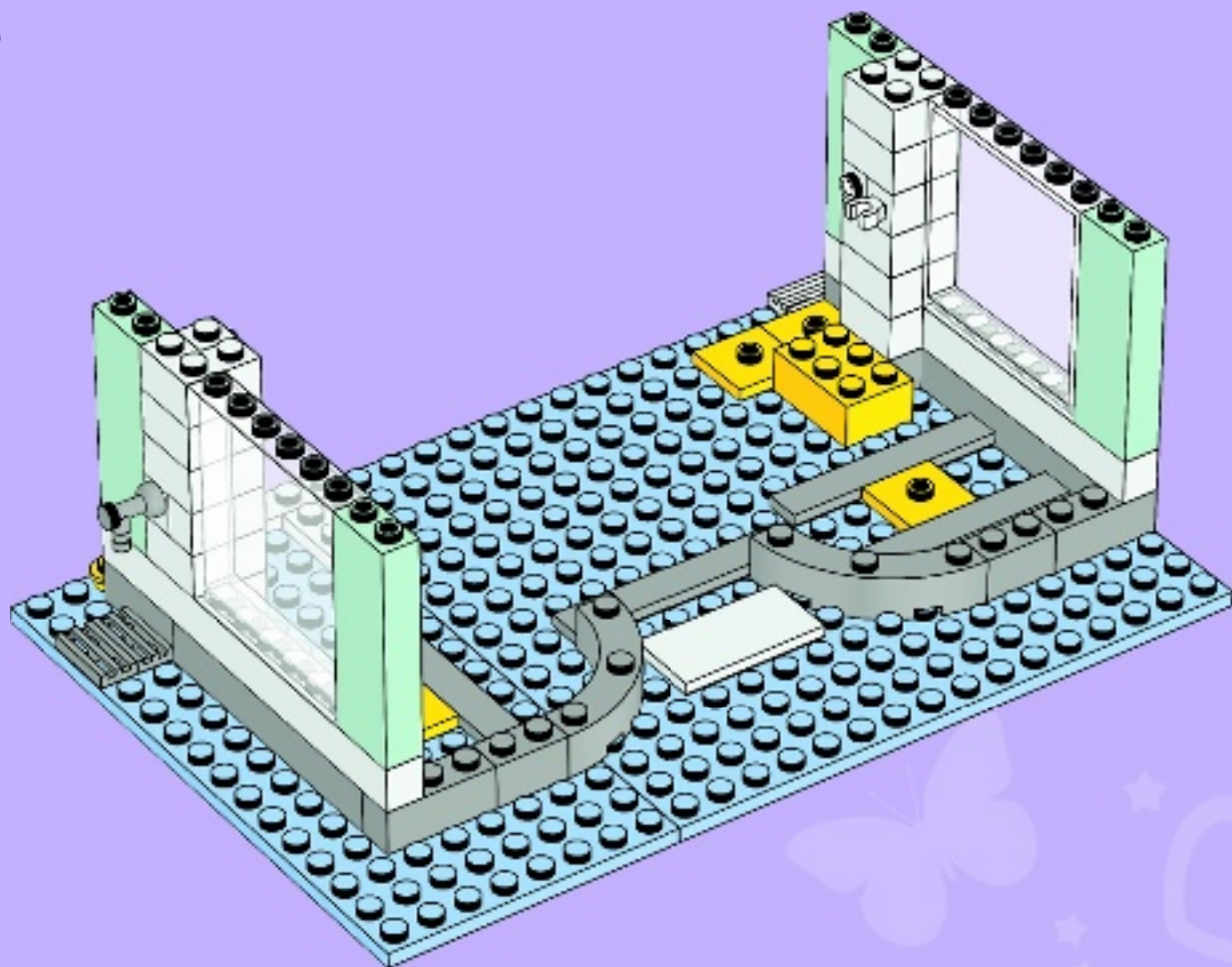

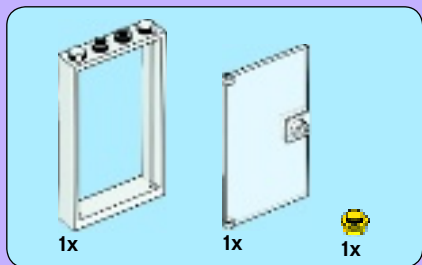

# 19

**1**

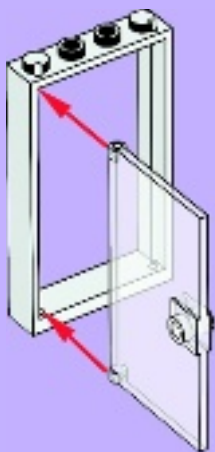

**2**

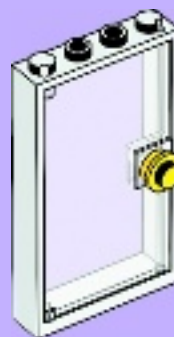



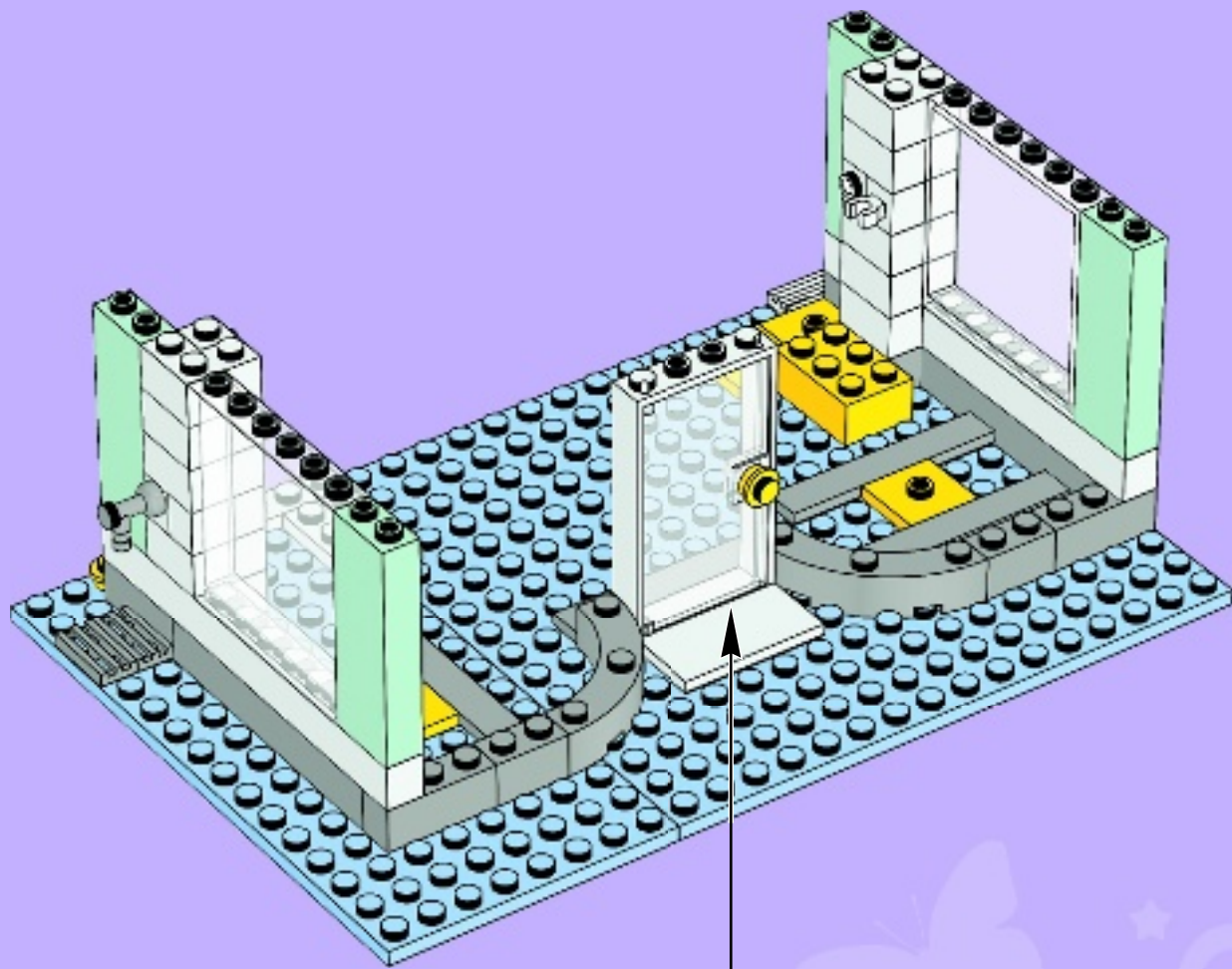

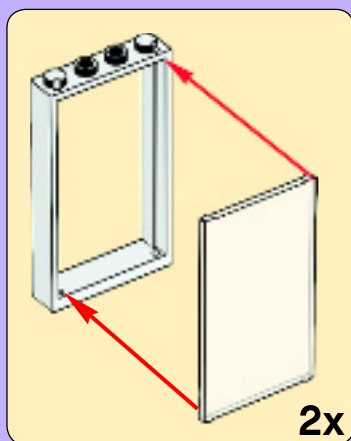
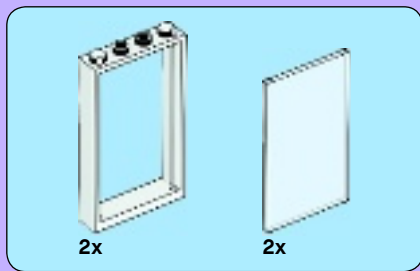

20

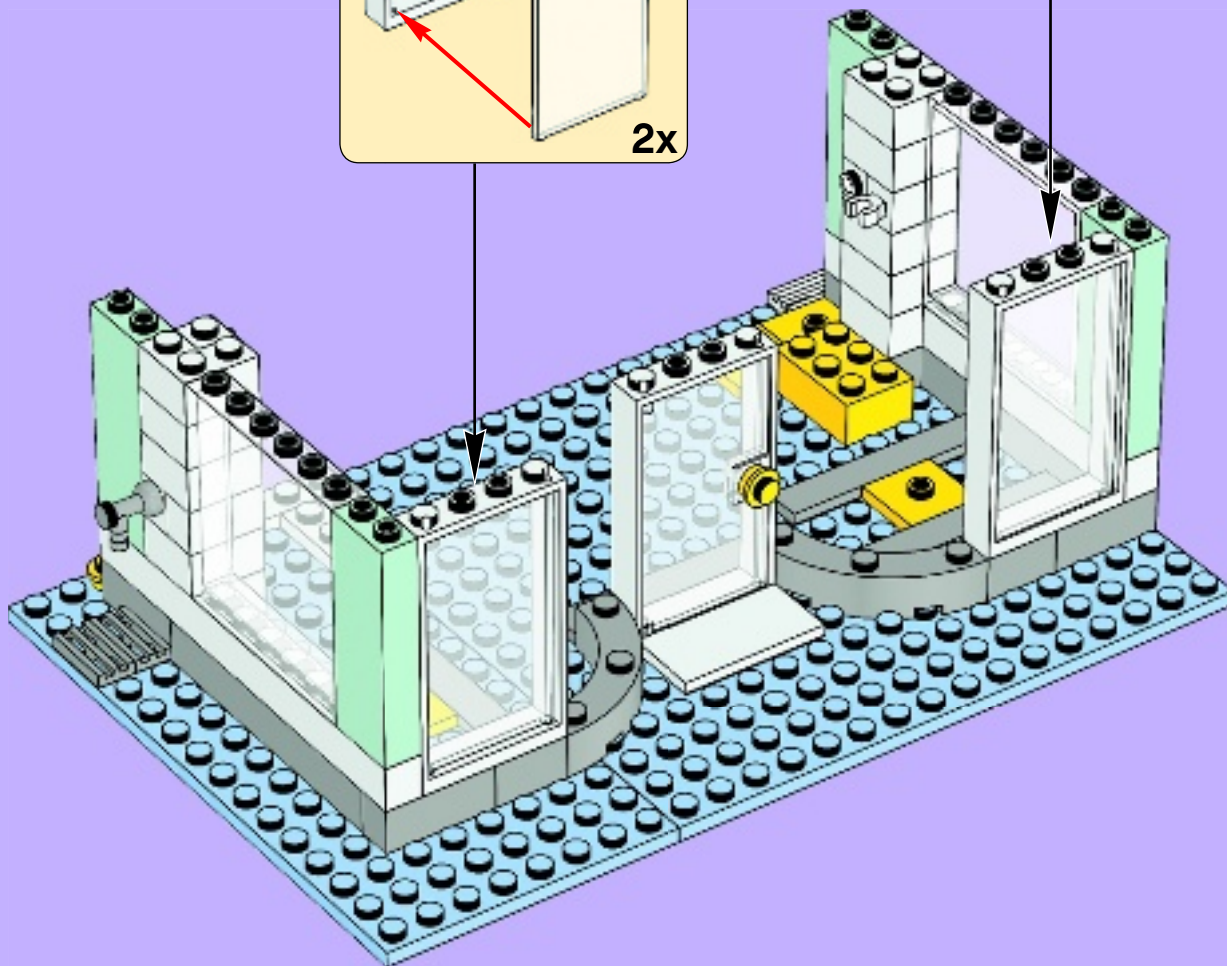



21

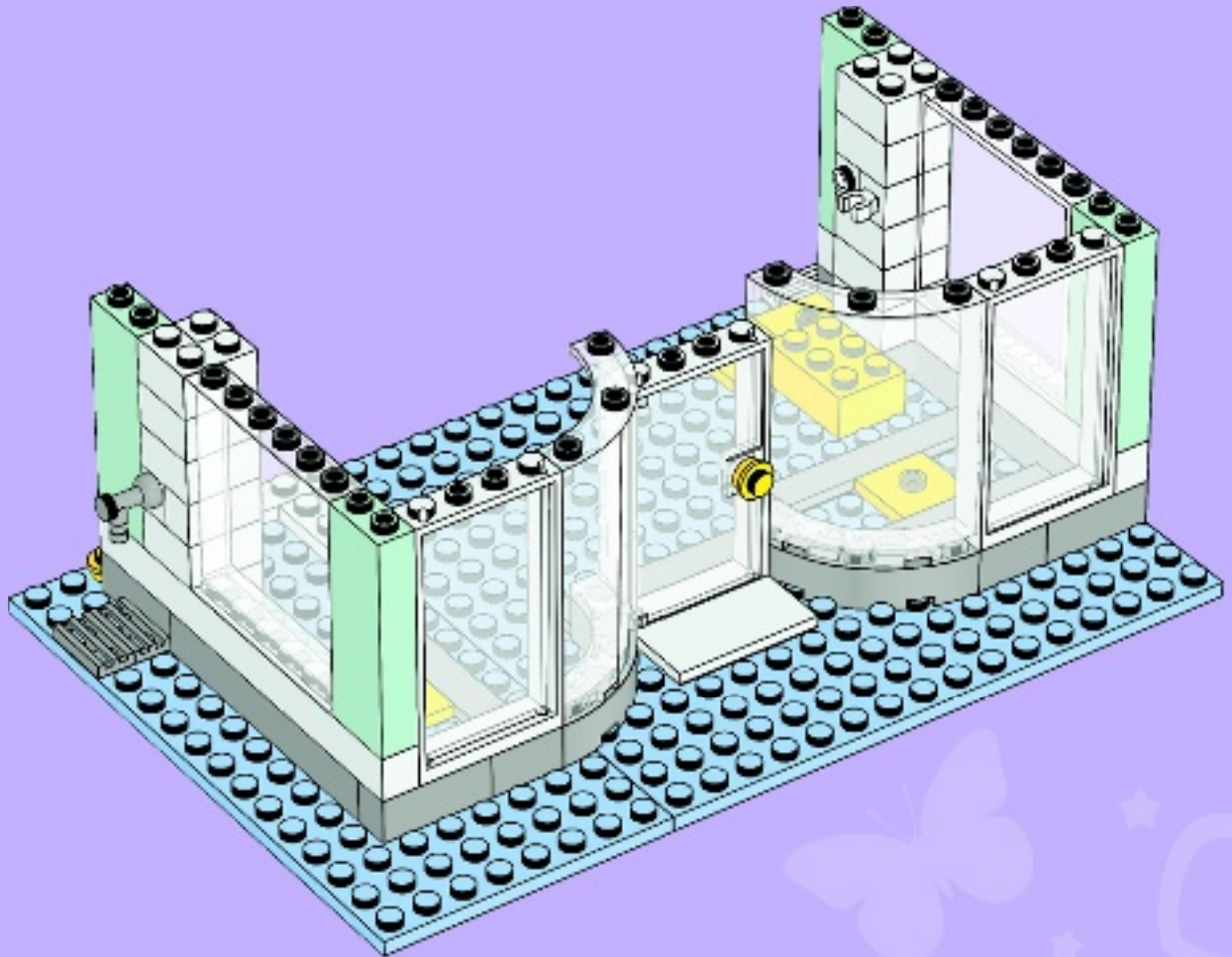





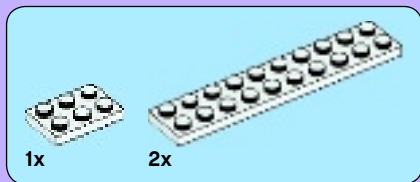

24

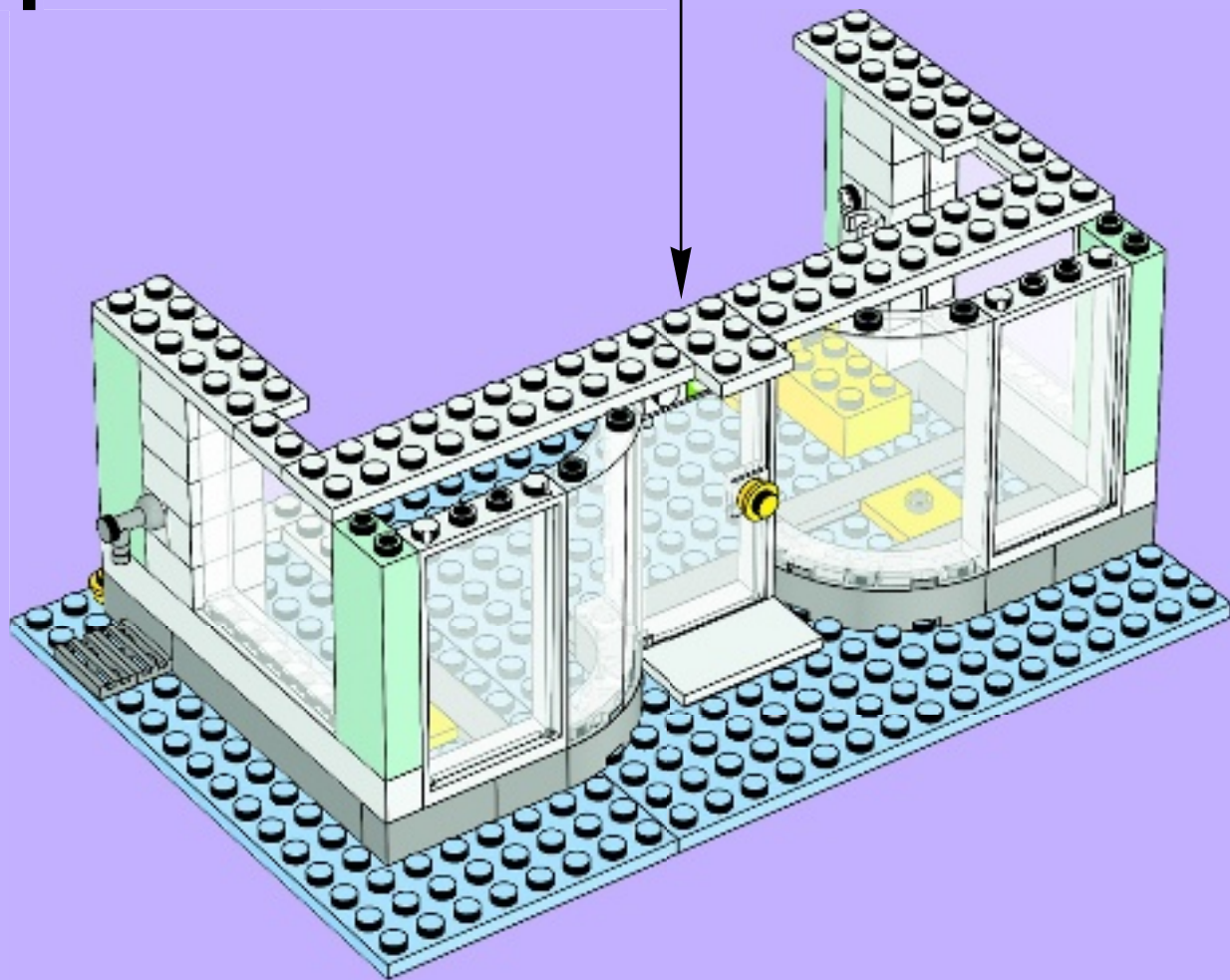



2x

# 25

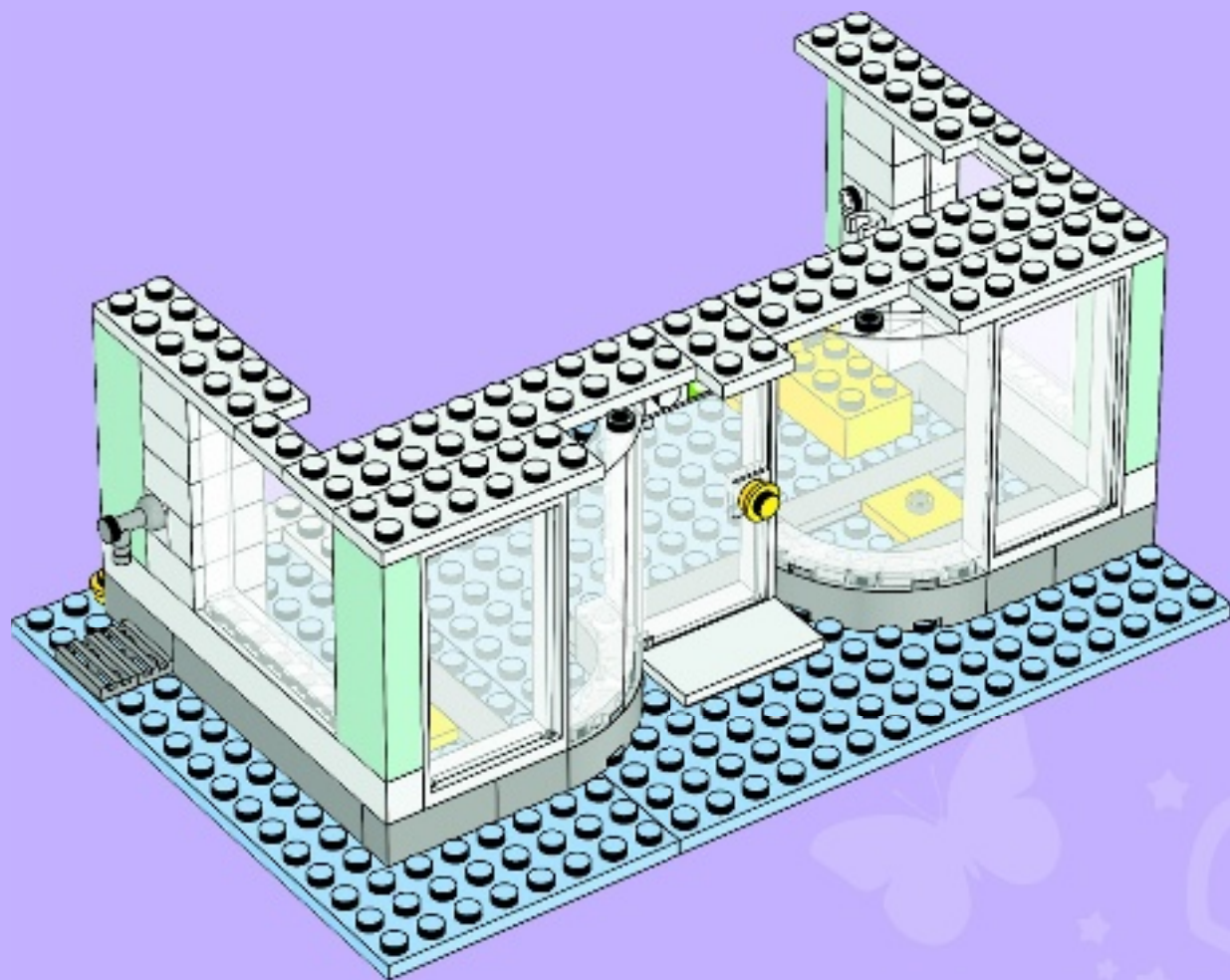

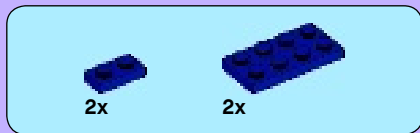

26

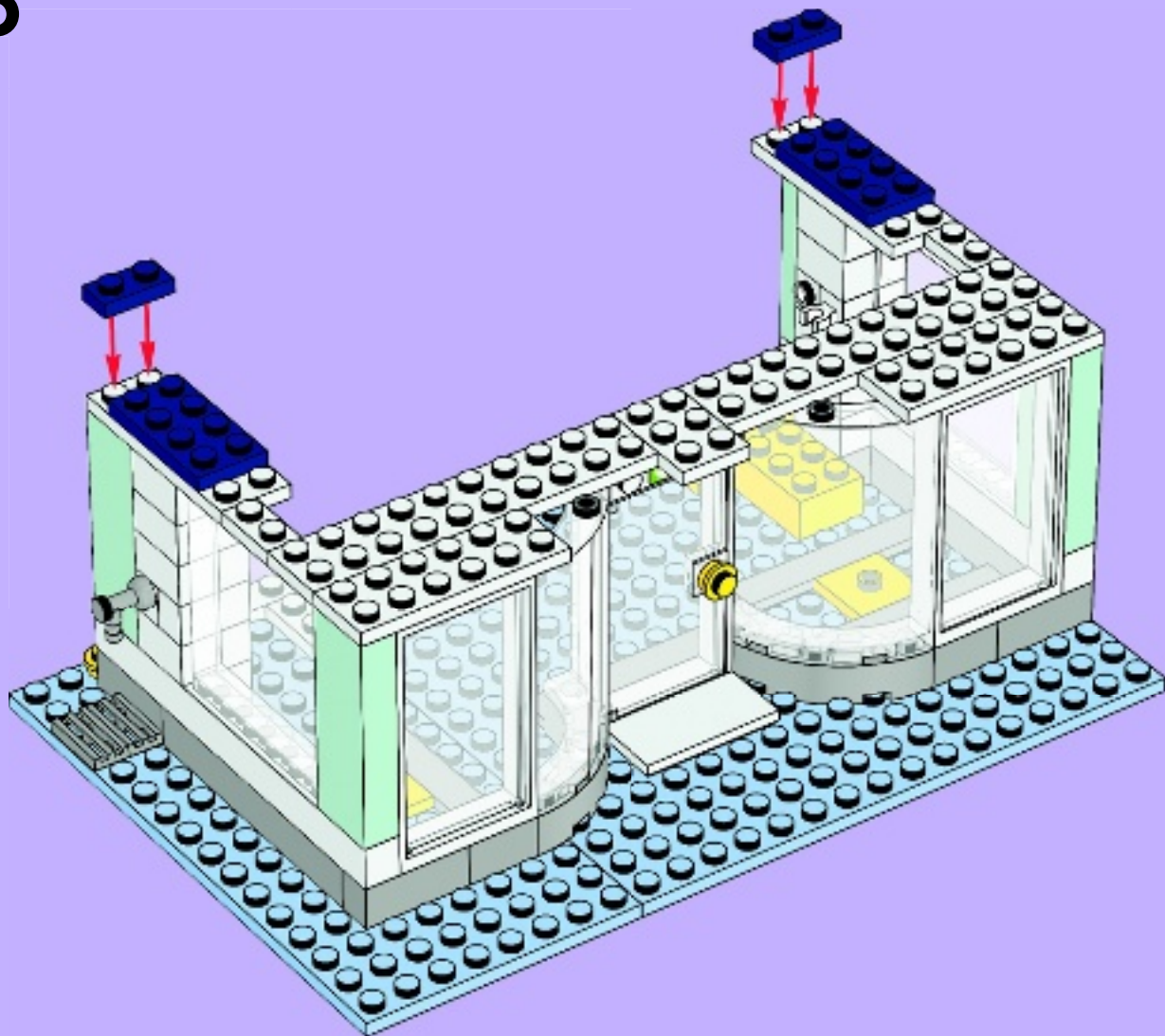





4x

# 27

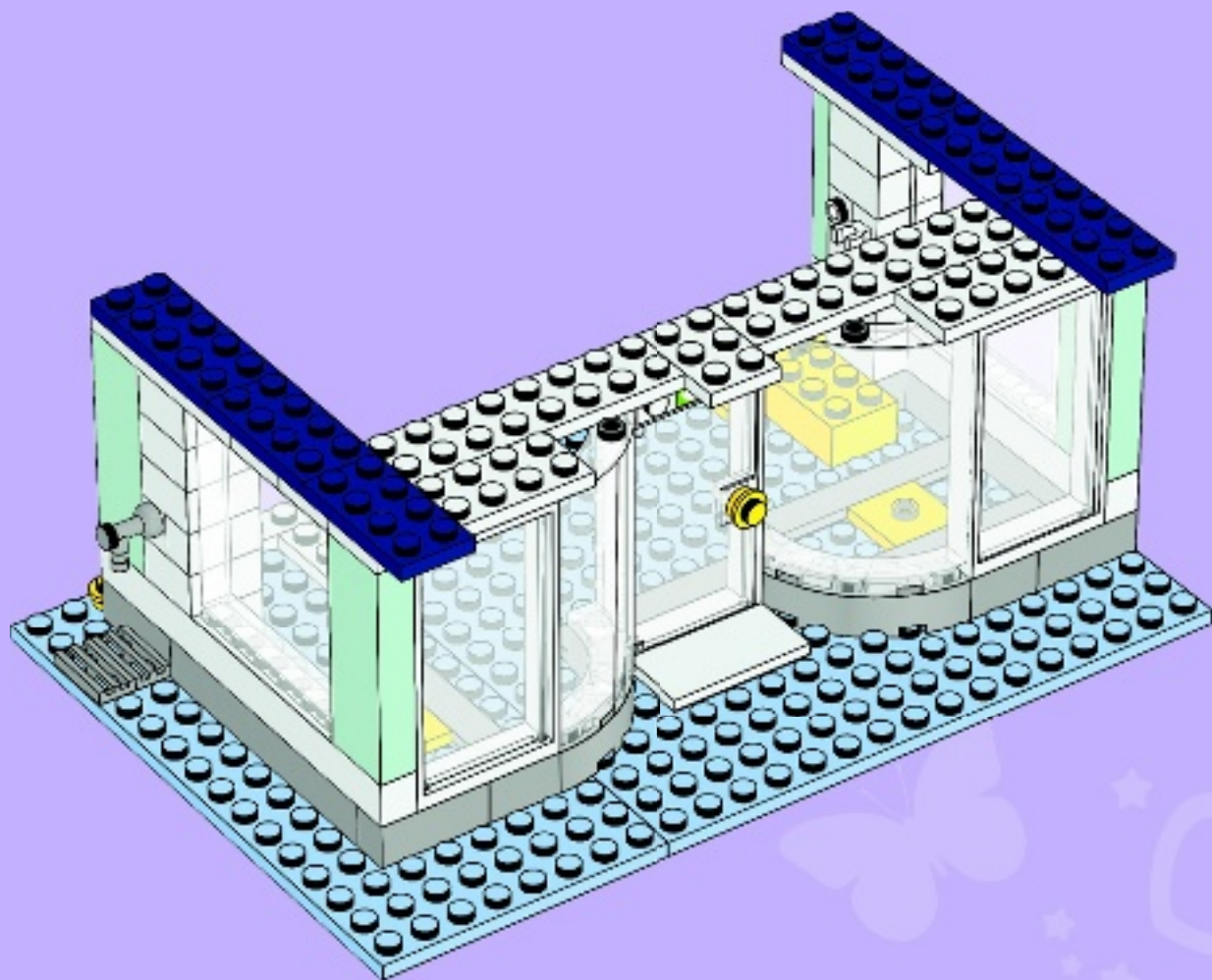

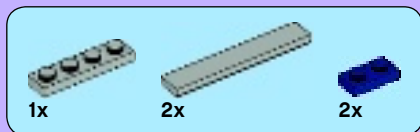

# 28

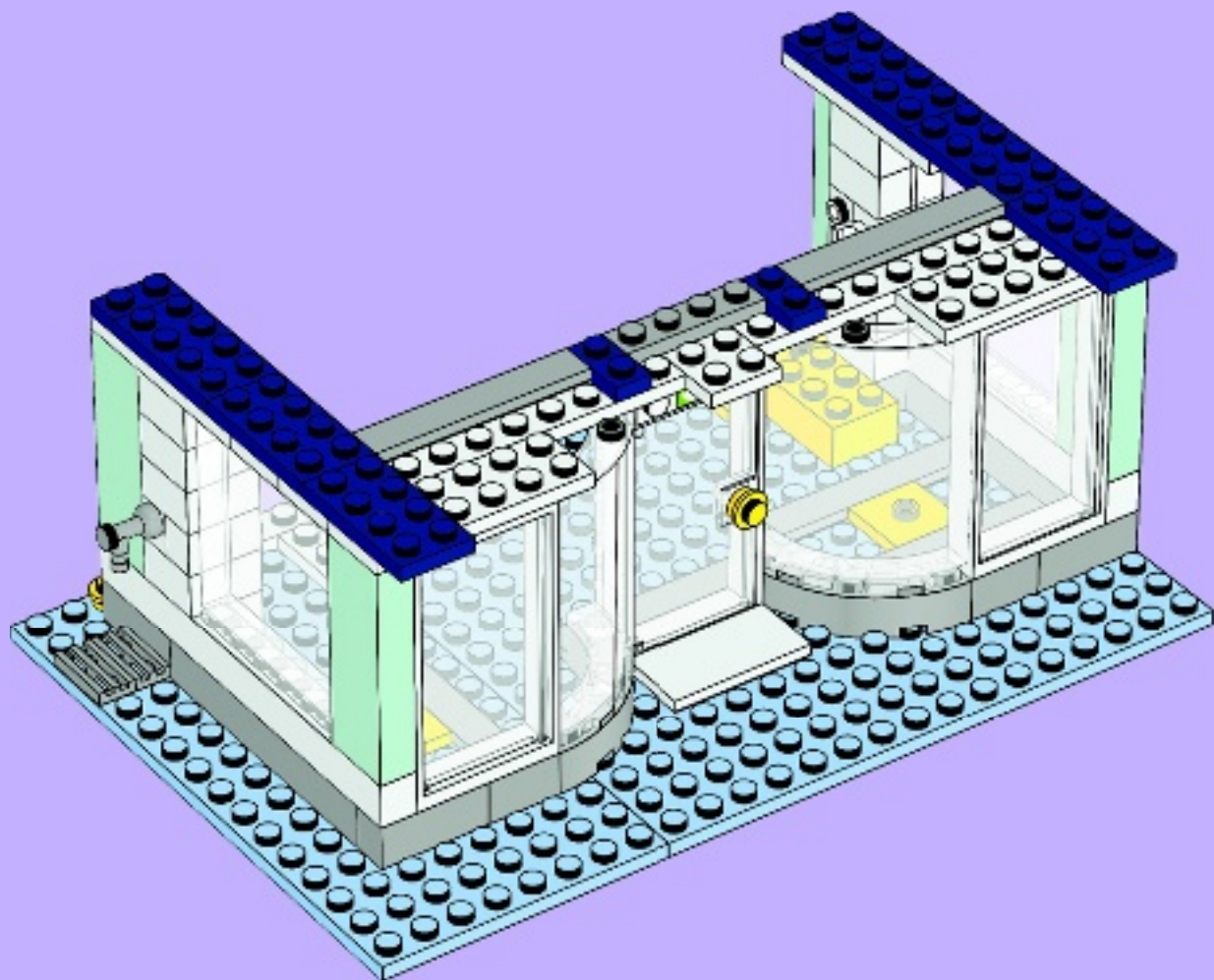

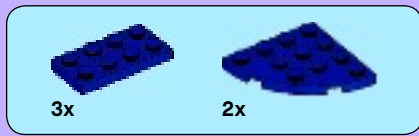

# 29

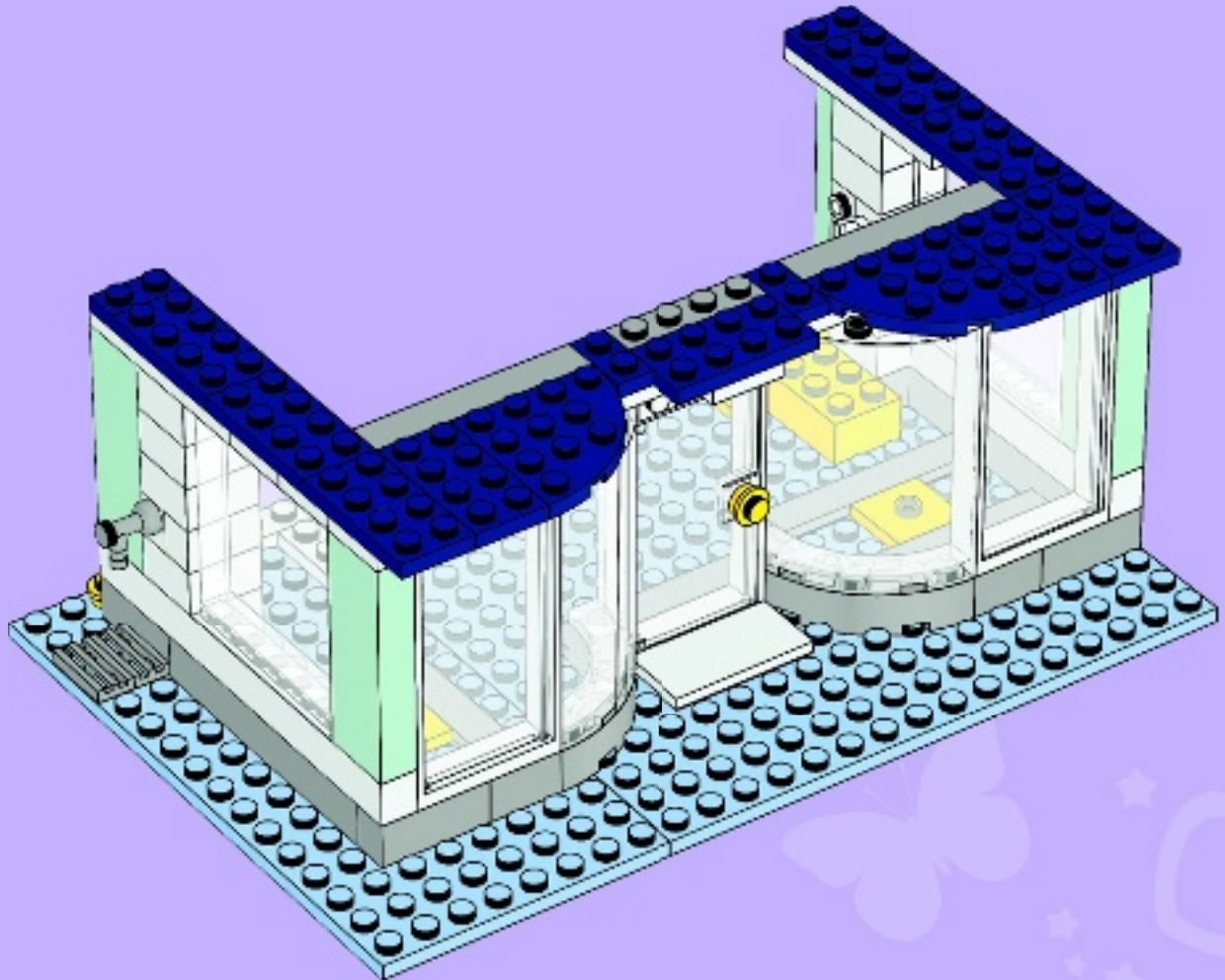



2x



2x

# 30

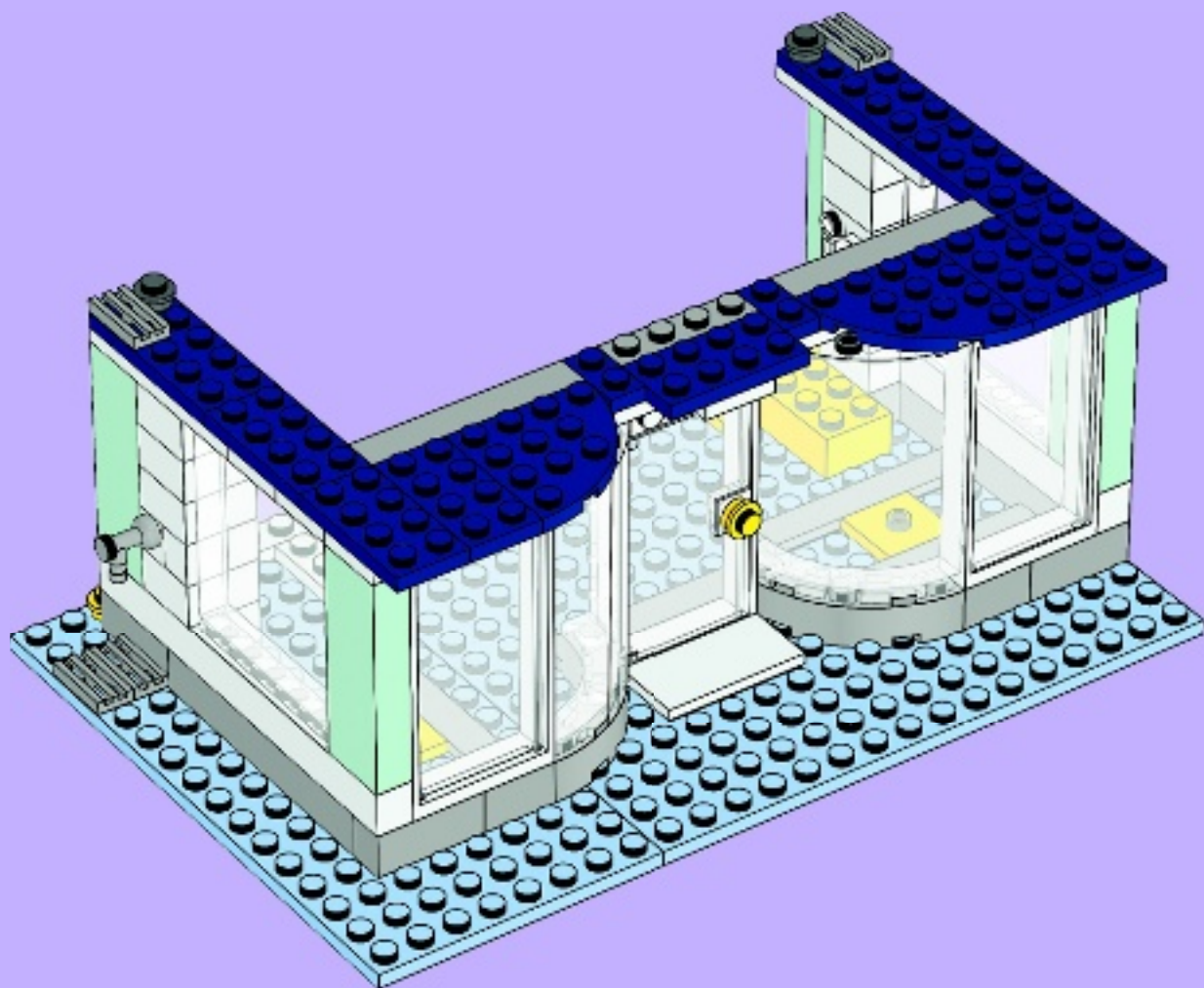



4x

# 31

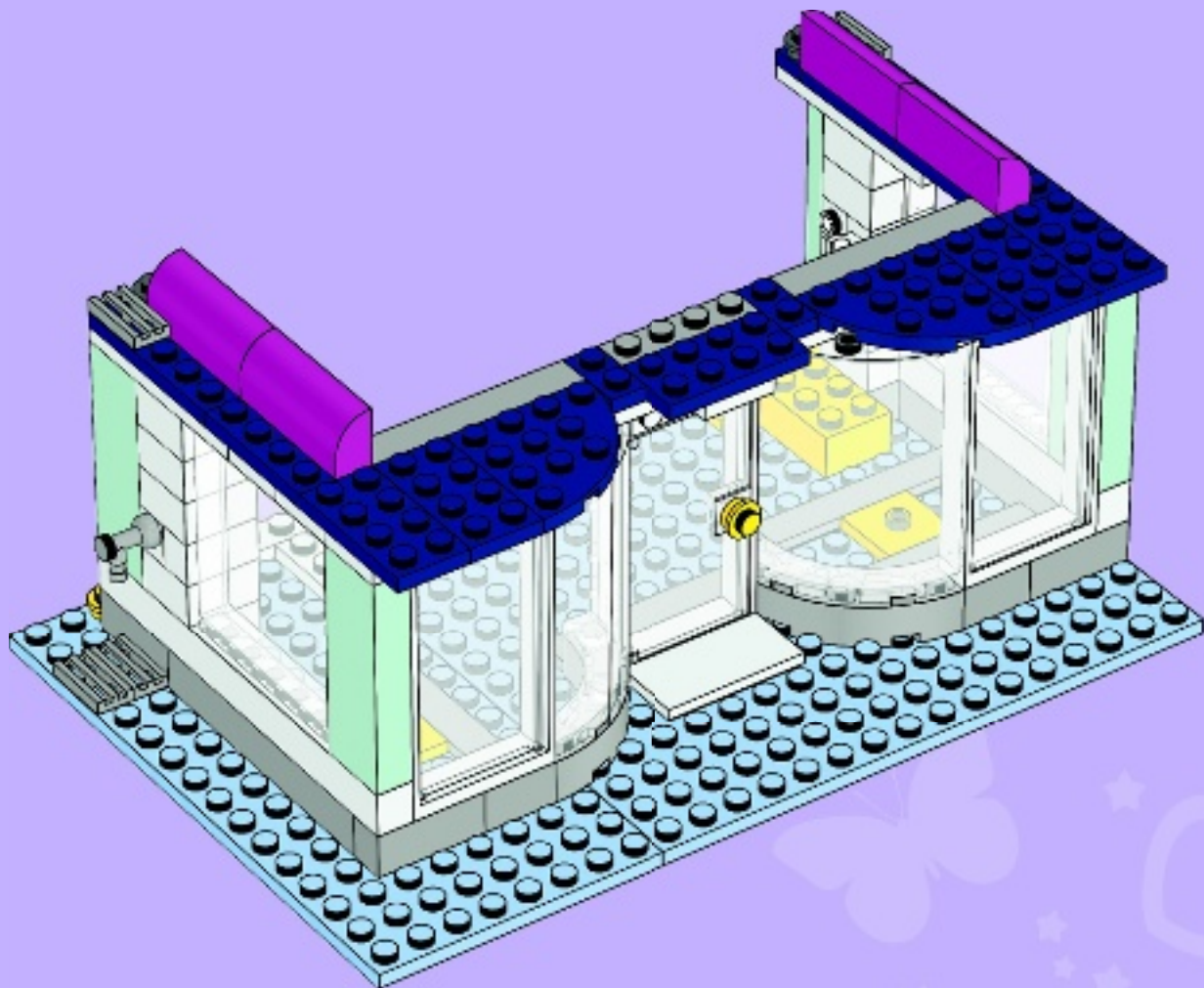



2x

32

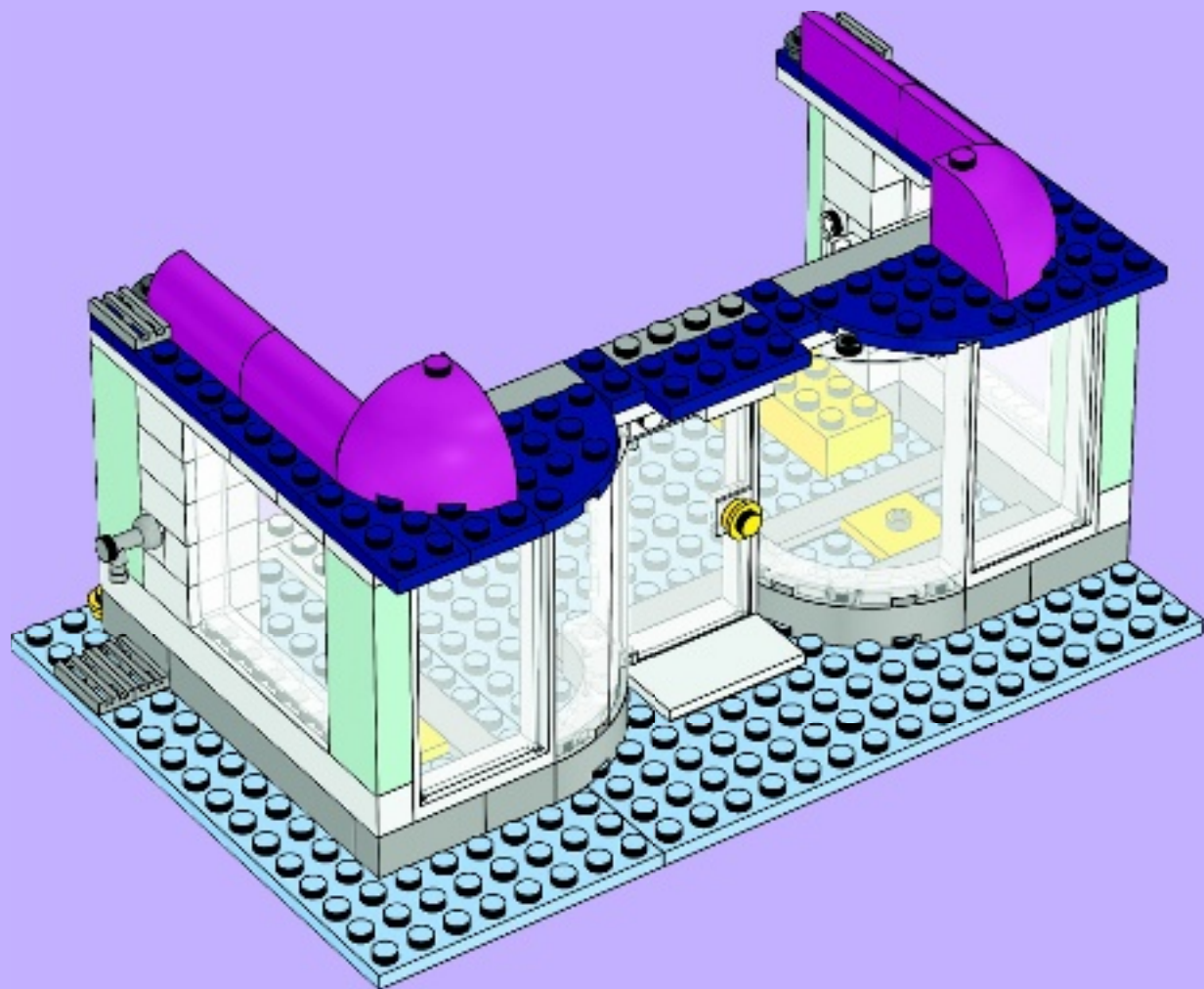

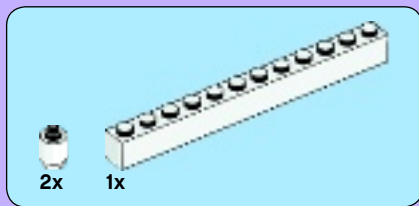

# 33

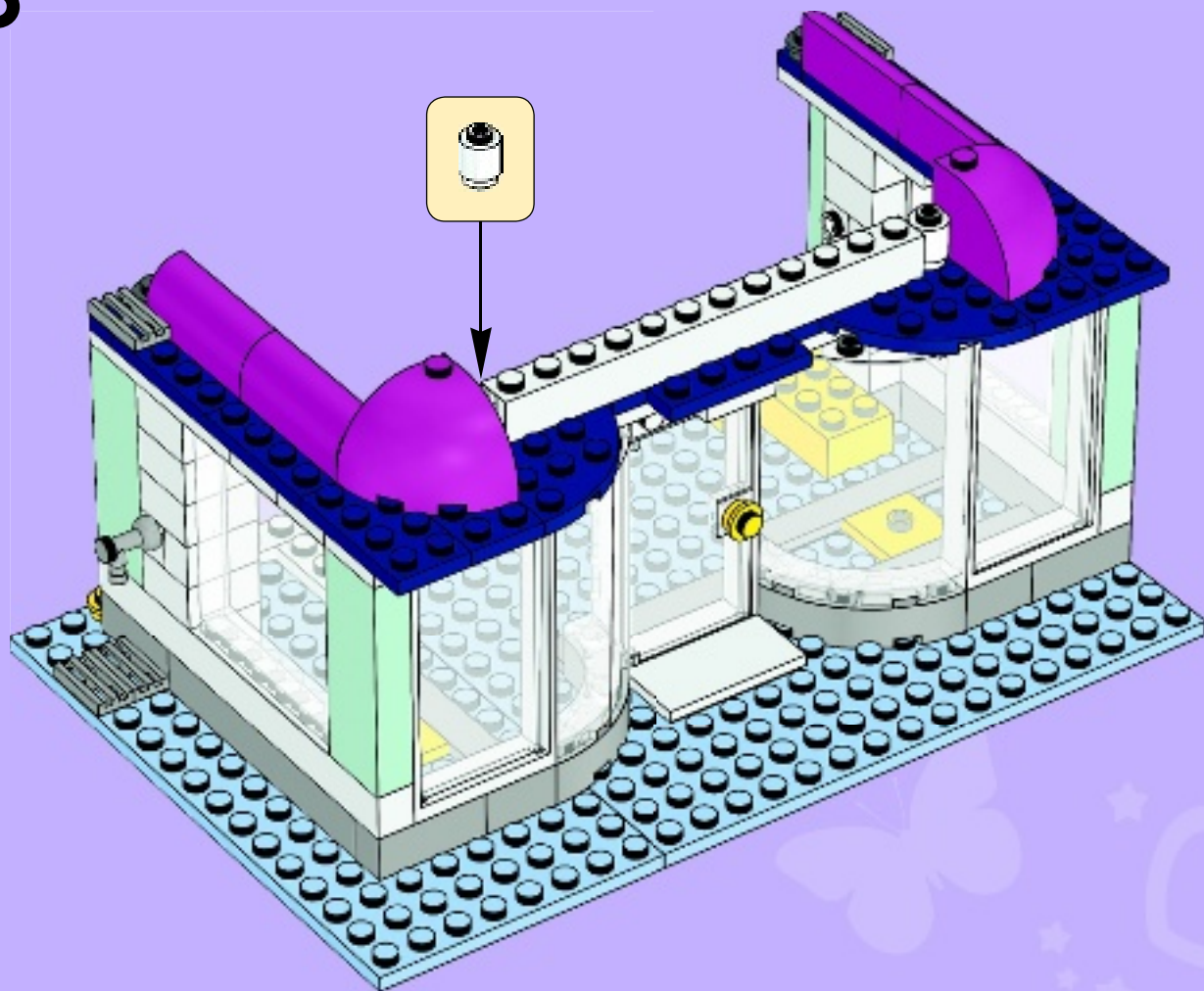

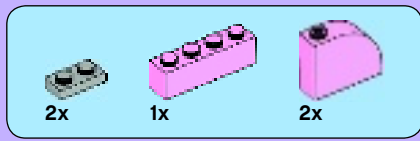

# 34

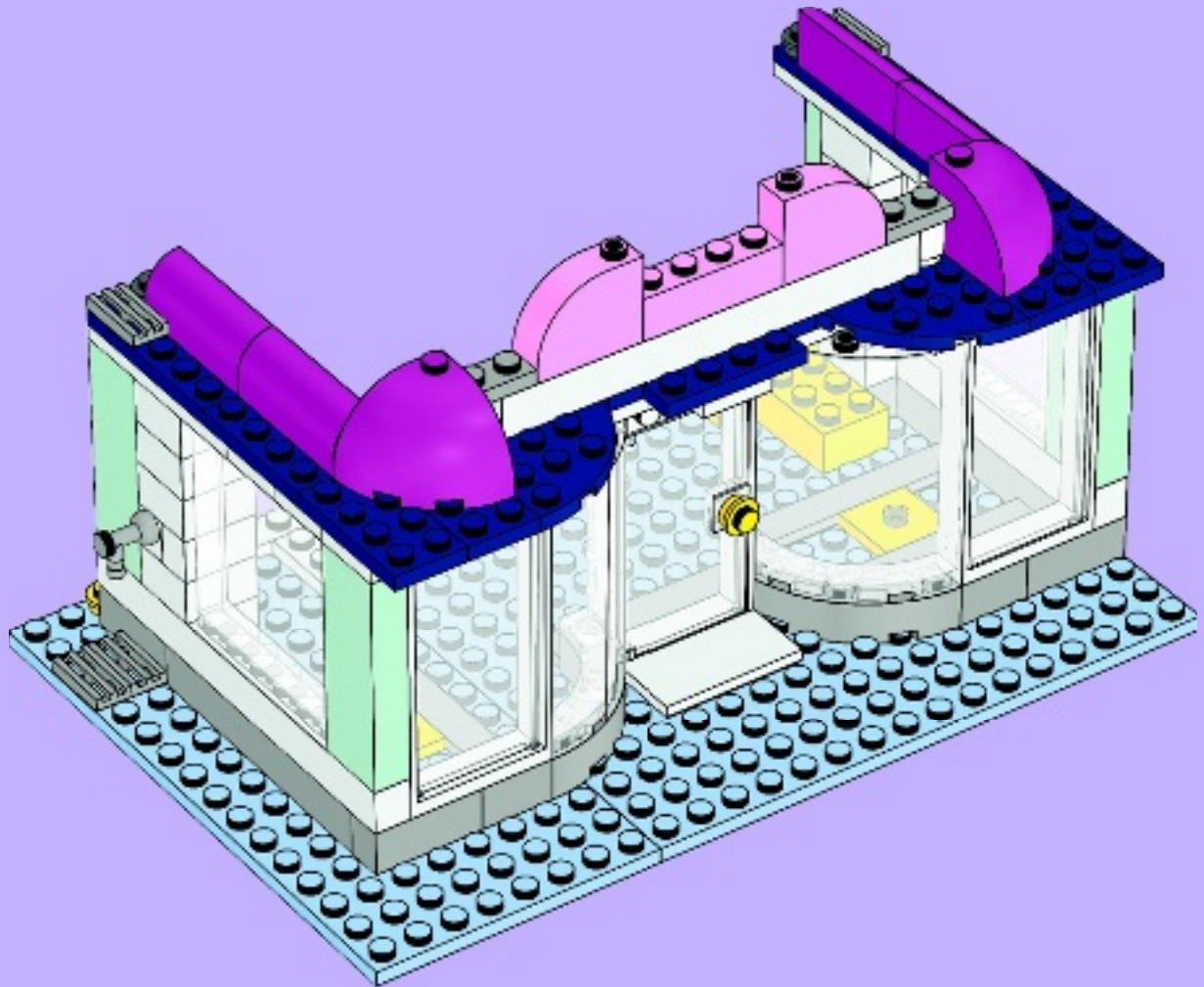





4x

# 35

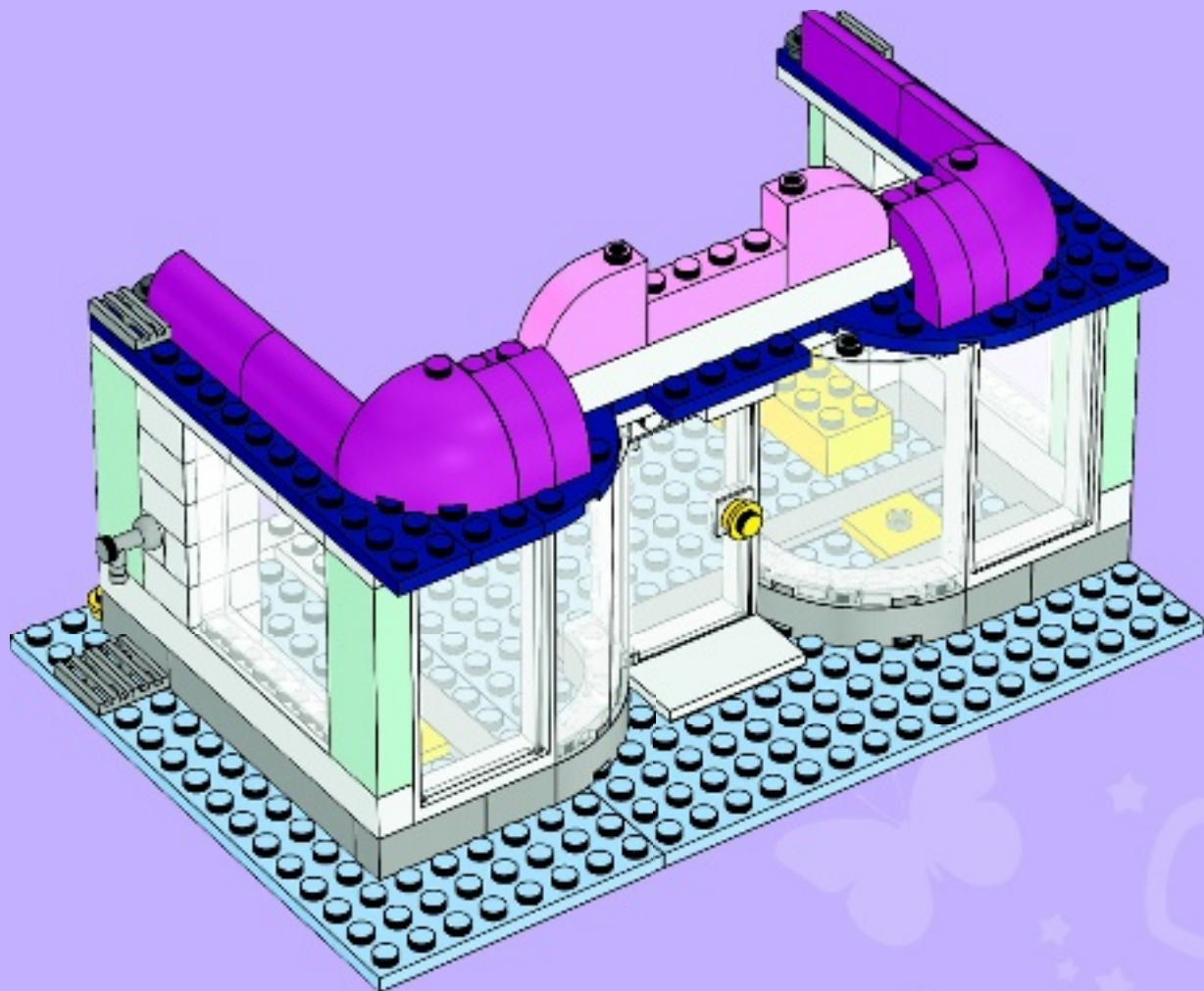



2x



1x

# 36

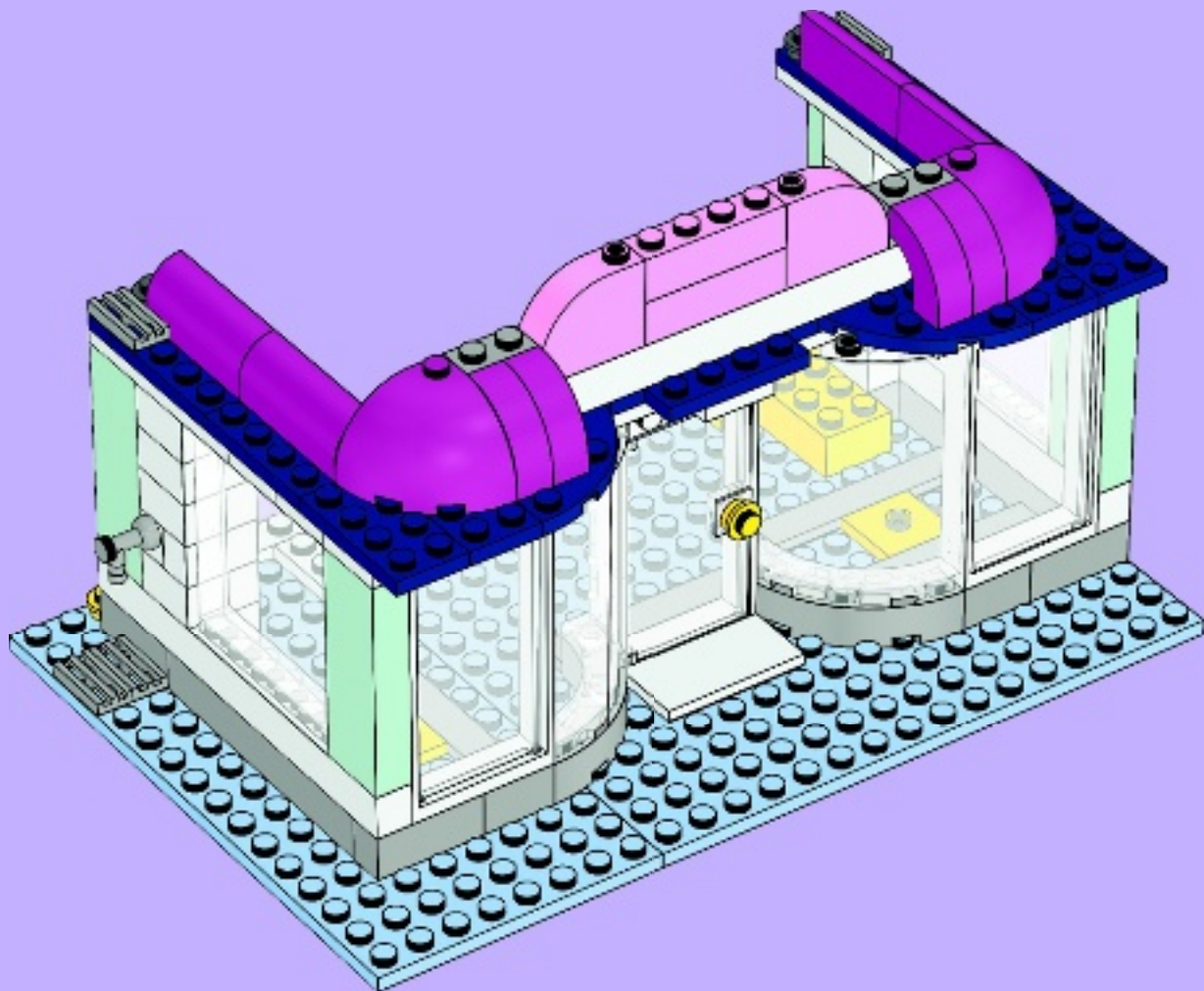



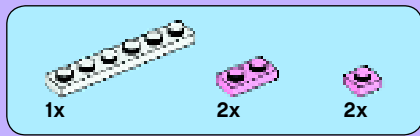

# 38

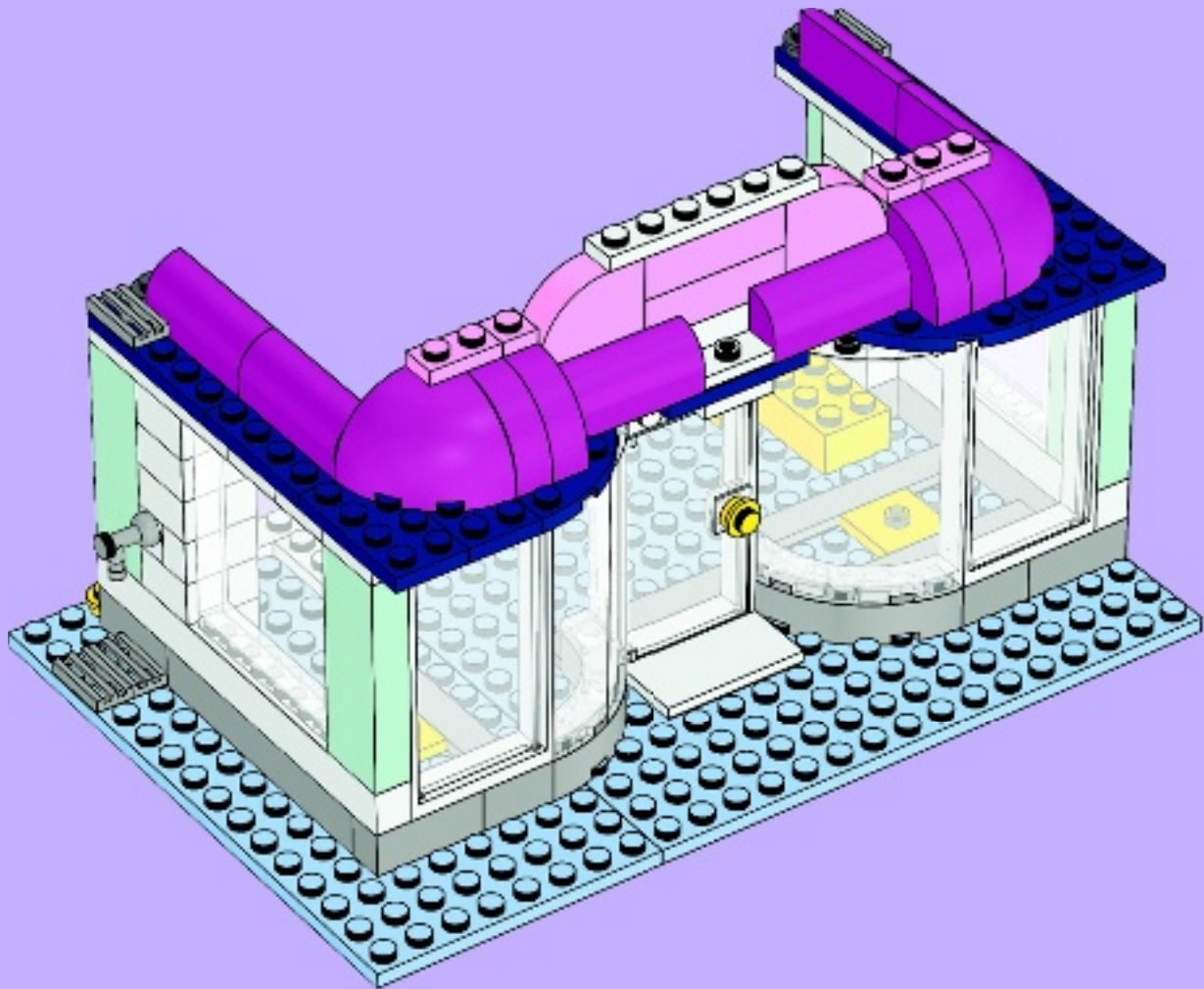

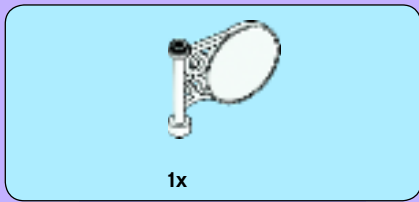

39

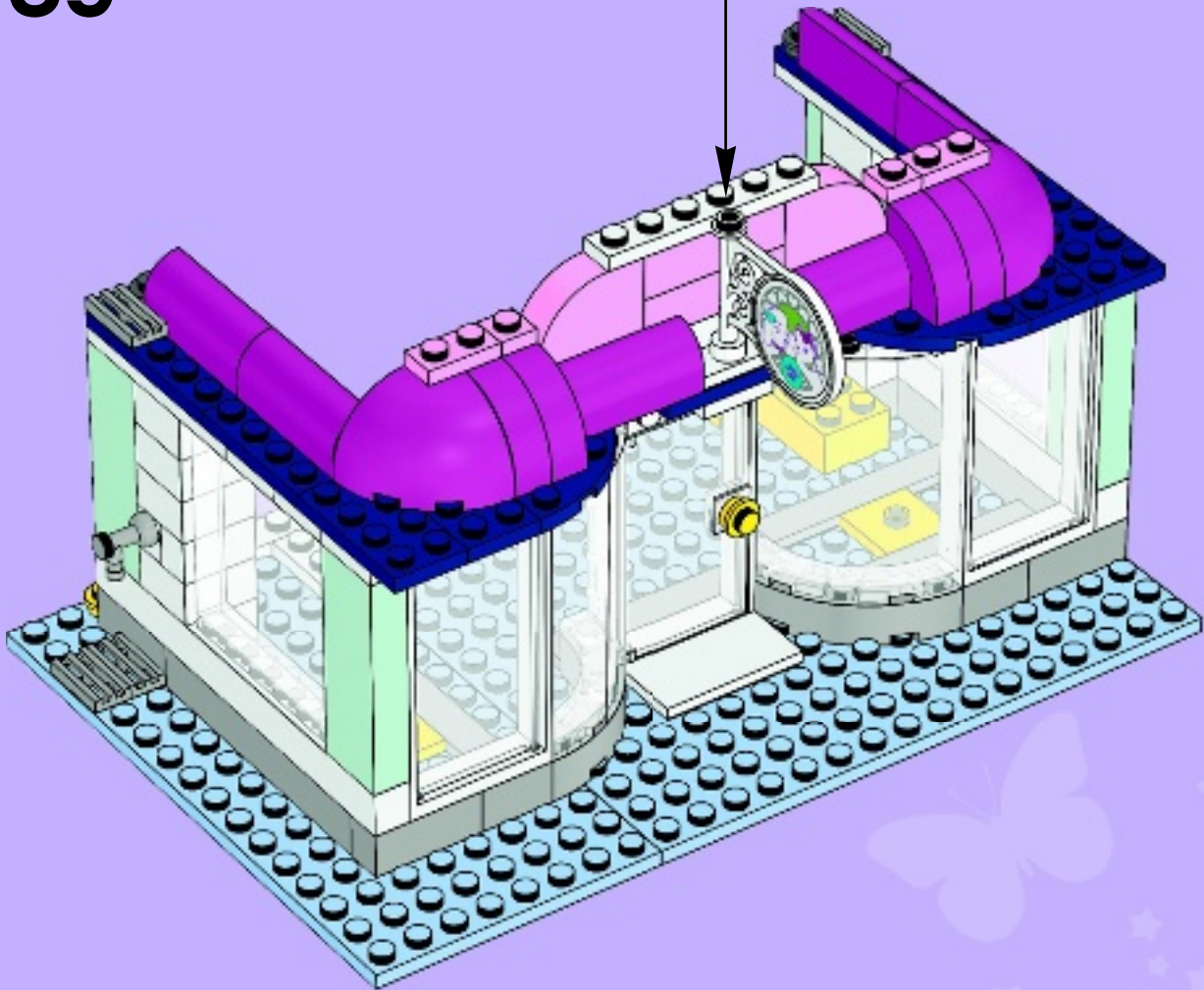

1x

1x

# 40

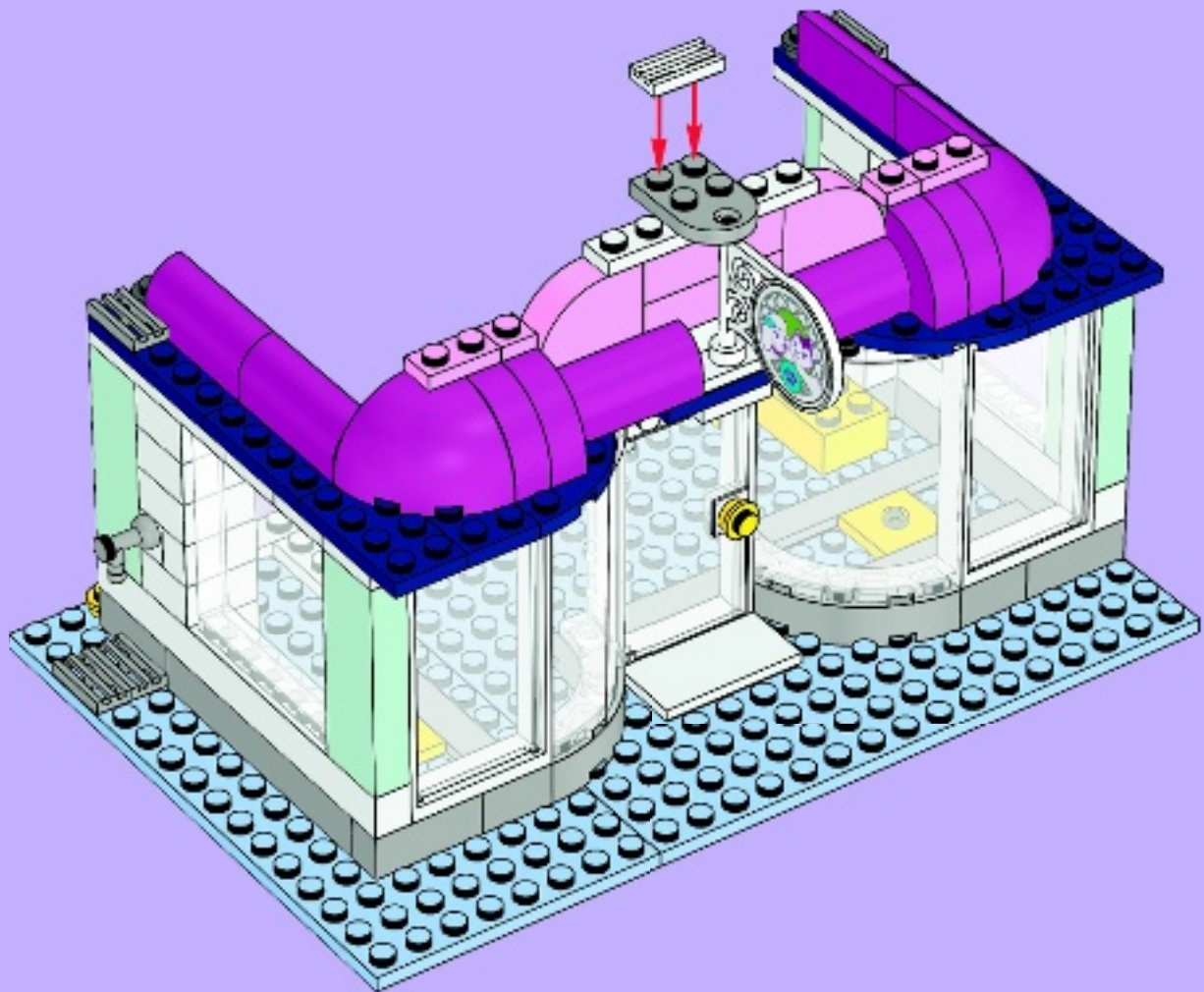



2x

# 41

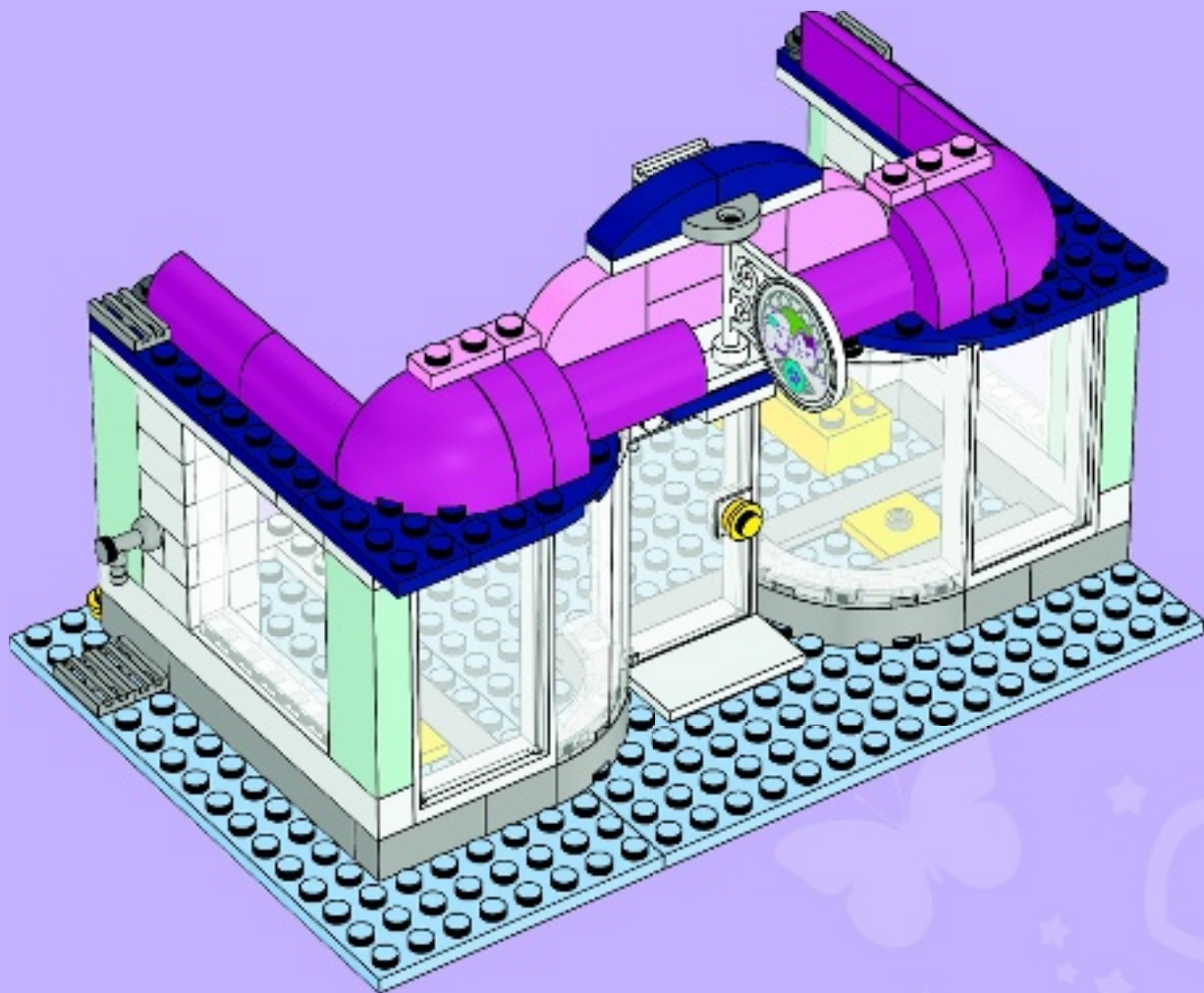

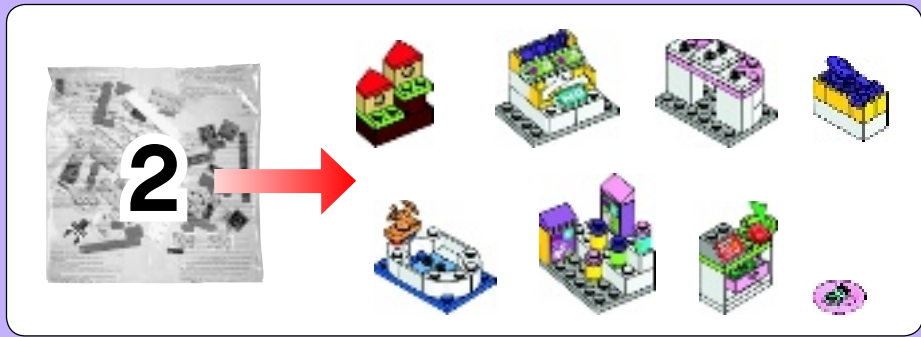

42

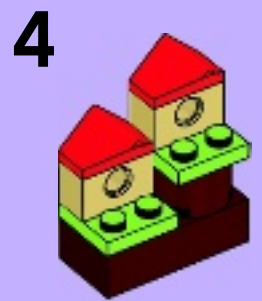
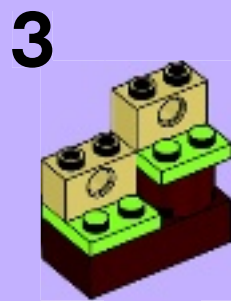
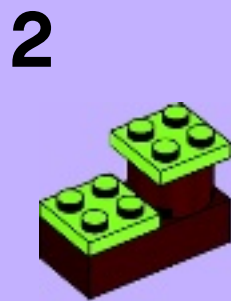
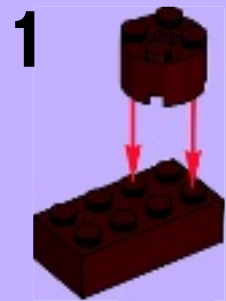



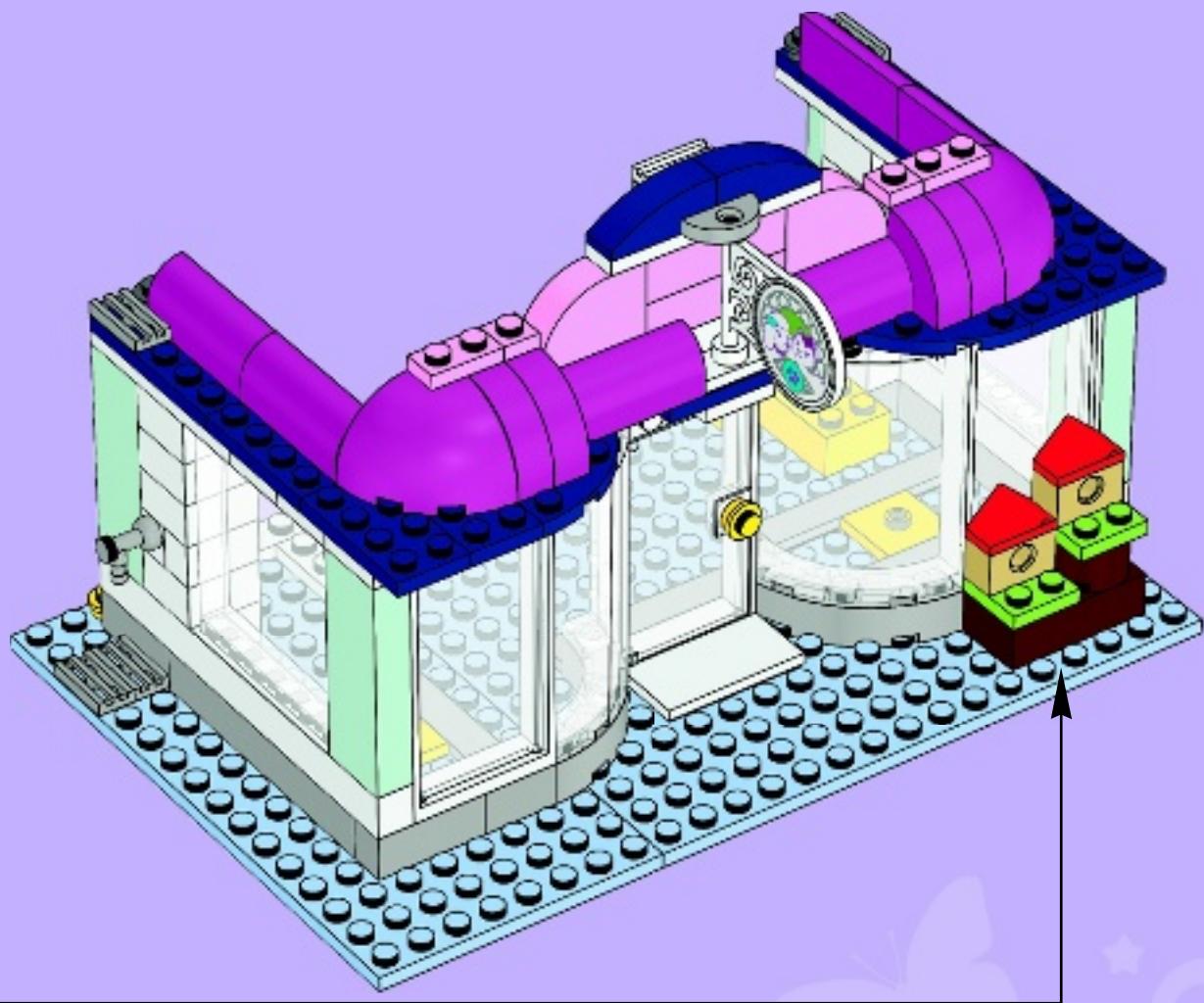



# 43

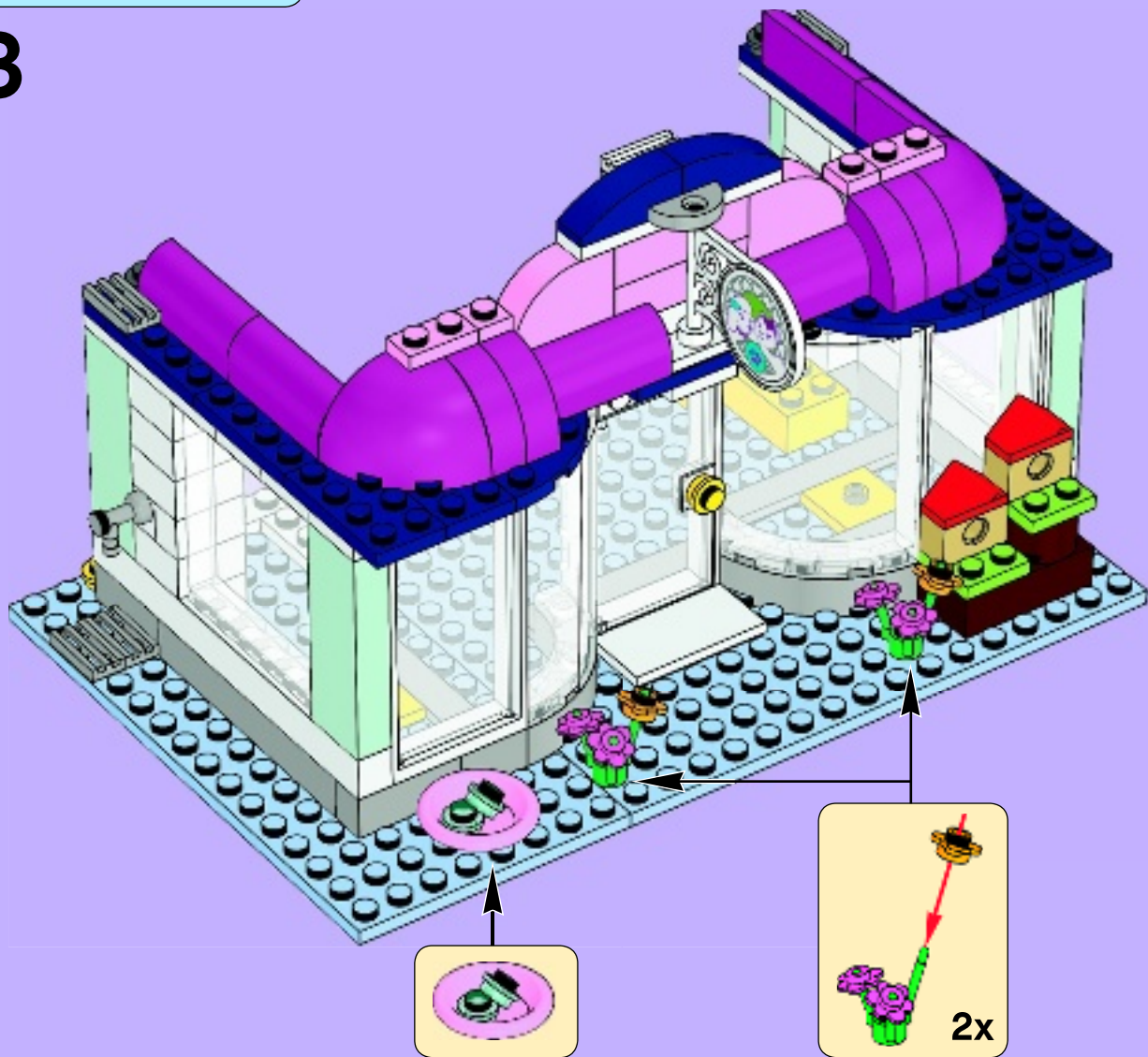

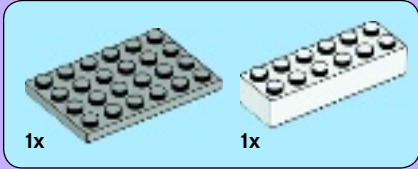

**1**

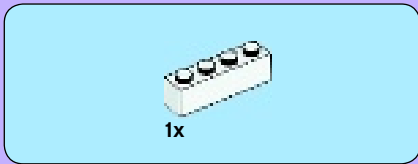
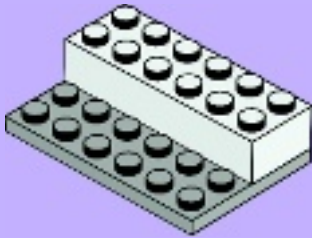

**2**

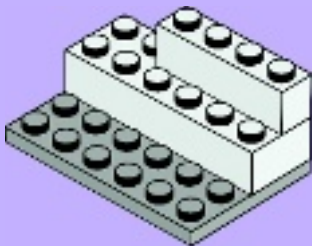

**3**

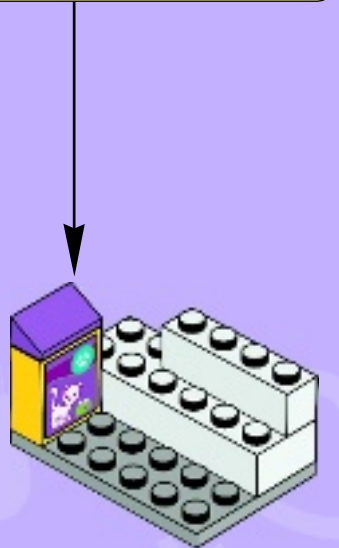
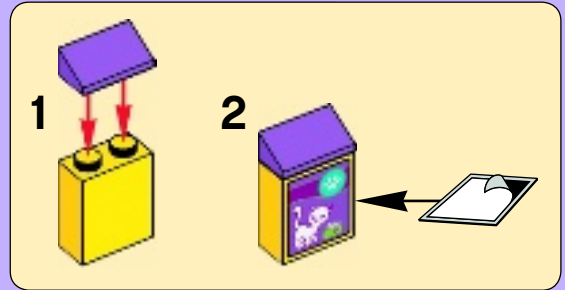



1x



1x

# 4

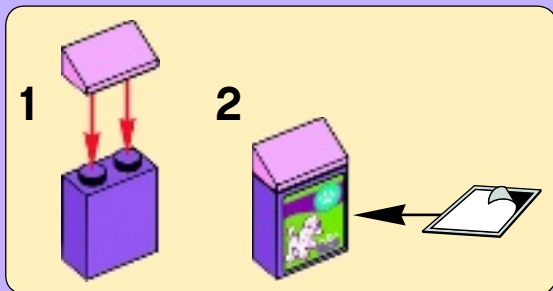

2x



2x



2x



1x



1x

# 5



44

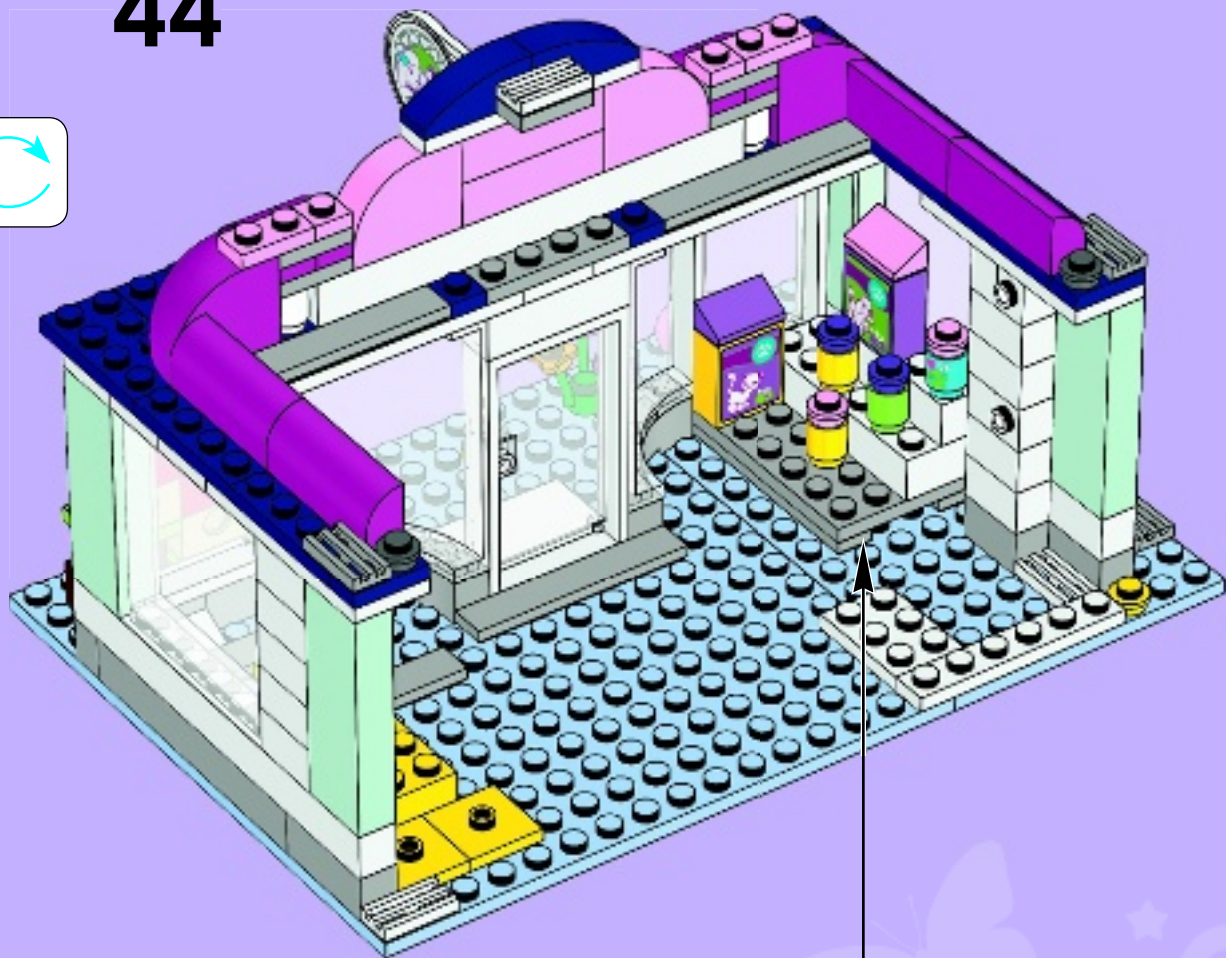
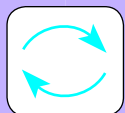



# 45

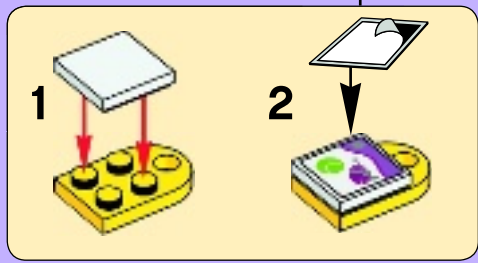
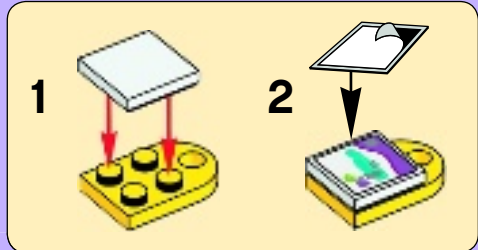



1x

1



1x



1x

2



1x

3



1x



1x



1x

4





1x

5



1x



1x

6





# 46

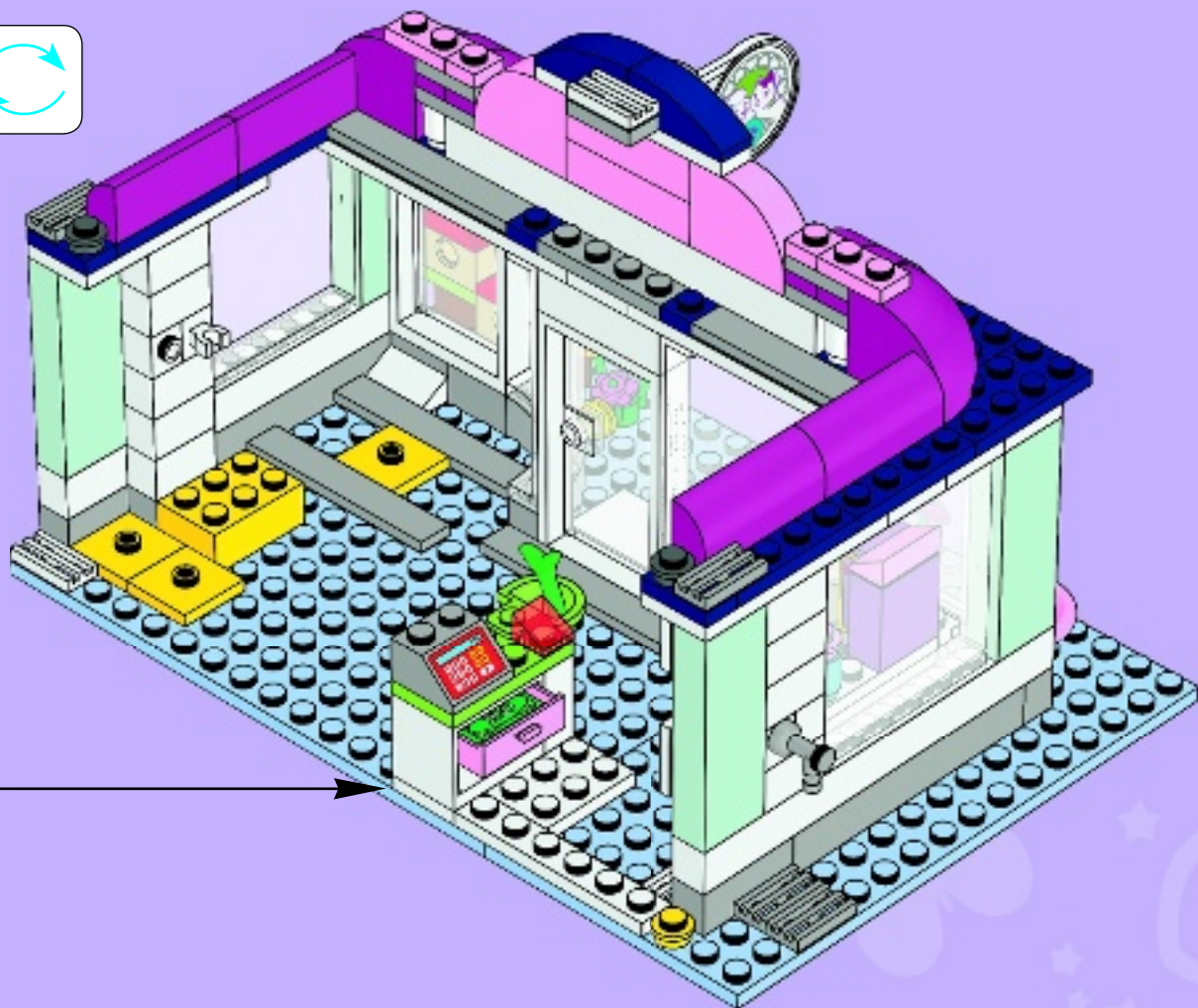
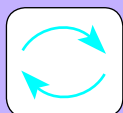



1



2



3

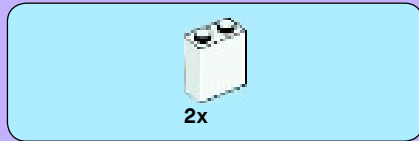

4





47





1x

# 48



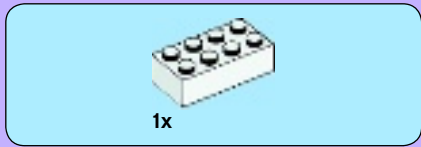

1

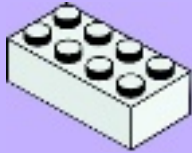

2

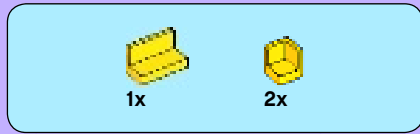
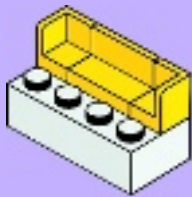

3

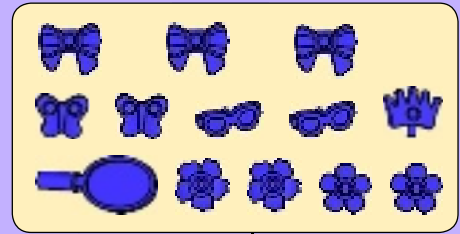
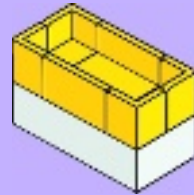

4



49



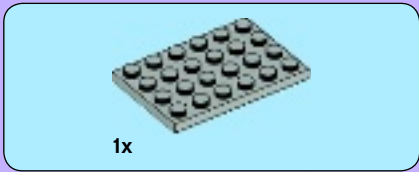

1

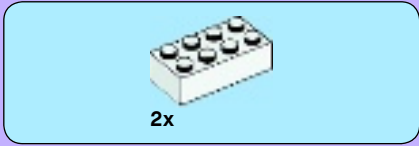

2

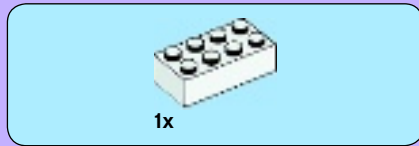

3



4

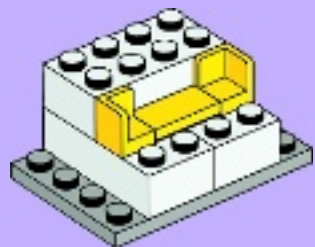





2x



1x

5



3x

6

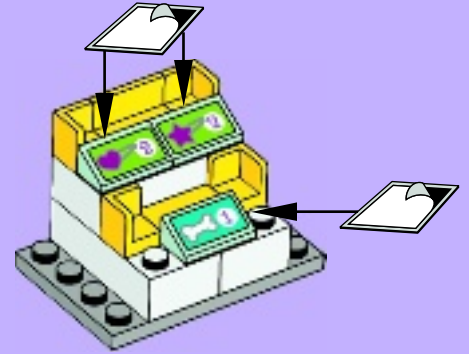
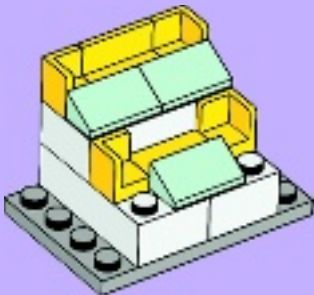

7



2x

8



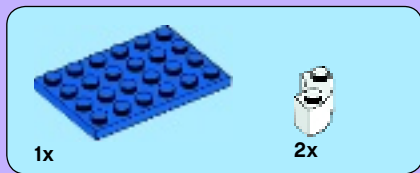

1

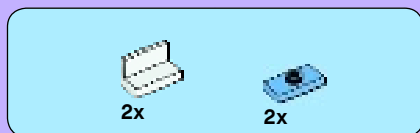

2



3



4

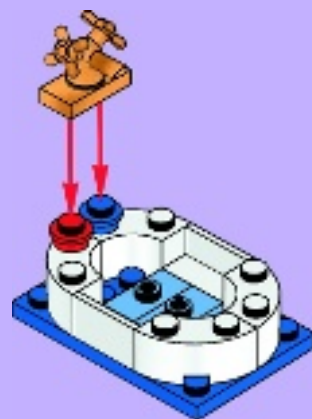





41002



41003



41004



41007



41008



41011



41000



41001

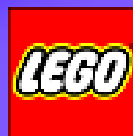

Friends

# Heartlake City



Friends





41007



41008

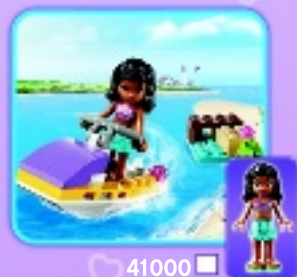

41000



41004



41001



41002



41003



41011





# Friends



LEGO.com/friends



Available on the App Store



Emma

Stephanie

Olivia

Andrea

Mia



1



LEGO.com/clubFriends 

2



3



**Free! Gratis!  
Gratuit!**



**club**™

LEGO.com/clubfriends

\*Paid subscription in Australia and New Zealand.  
\*Abonnement payant en Australie et Nouvelle-Zélande.

©2013 The LEGO Group.



4x  
4113261



4x  
300401



7x  
300301



1x  
235701



1x  
301001



4x  
300101



1x  
4181142



3x  
611201



4x  
4558952



1x  
4533763



1x  
4143254

74



2x  
306201



8x  
4567449



1x  
4547489



5x  
379401



2x  
302301



2x  
302101



1x  
4597131



1x  
302001



2x  
366601



4x  
379501



2x  
383201



3x  
241201



2x  
306801



1x  
4560178



2x  
486501



3x  
4541956



1x  
4619665



1x  
6033016



2x  
4600294



1x  
6023093



1x  
368001



2x  
4258056



1x  
614121



1x  
303223



1x  
614123



1x  
4121625



1x  
300224



2x  
306224



4x  
4565386



1x  
306924



2x  
4188313



2x  
614124



8x  
4201587



3x  
486524



2x  
6017000



1x  
4596243



1x  
4295260



2x  
374128



1x  
4119479



2x  
4639698



1x  
4521504



2x  
4504229



2x  
4599452



2x  
4163917



2x  
4617013



1x  
4212454



2x  
4537937



1x  
4537936



1x  
4520810





# Win!

Go to [www.LEGOsurvey.com/product](http://www.LEGOsurvey.com/product) to fill out a survey for a chance to win a cool LEGO® Product.

No purchase necessary.  
Open to all residents where not prohibited.



## [www.LEGOsurvey.com/product](http://www.LEGOsurvey.com/product)

### Gewinne!

Nimm an der Umfrage auf [www.LEGOsurvey.com/product](http://www.LEGOsurvey.com/product) teil und hab die Chance ein cooles LEGO® Produkt zu gewinnen!  
Die Teilnahme am Gewinnspiel führt zu keinerlei Kaufverpflichtungen. Teilnahme in allen nicht ausgeschlossenen Ländern möglich.

6042869 / 6042870

### Win!

Ga naar [www.LEGOsurvey.com/product](http://www.LEGOsurvey.com/product) product, vul een enquêteformulier in en maak kans op een cool LEGO® product.  
Geen aankoopverplichting. Iedereen mag deelnemen, uitgezonderd ingezetenden van landen waar een enquêteverbod geldt.

### Gagne!

Visite [www.LEGOsurvey.com/product](http://www.LEGOsurvey.com/product) pour répondre à un questionnaire et avoir une chance de gagner un produit LEGO® très cool !  
Aucune obligation d'achat. Ouvert à tous les résidents des pays autorisés.

### 当てよう!

[www.LEGOsurvey.com/product](http://www.LEGOsurvey.com/product) にアクセスして、アンケートにご記入ください。当選者にはレゴ製品を差し上げます。  
お買い上げの必要はありません。  
禁止されていない限り、すべての皆様にご利用いただけます。

LEGO and the LEGO logo are trademarks of the/son des marques de commerce de/son marcas registradas de LEGO Group. ©2013 The LEGO Group.