

Friends



41037





1

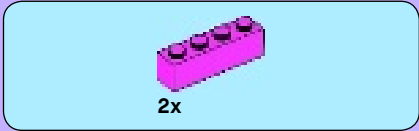

2



2



3

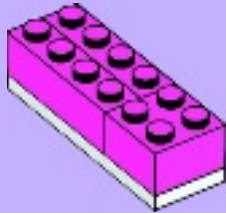

4





1x

5



2x

6

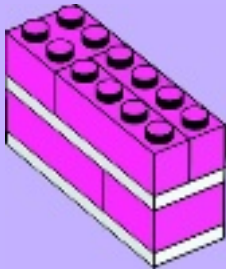

2x

7

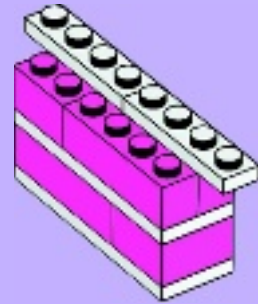

1x

8



51

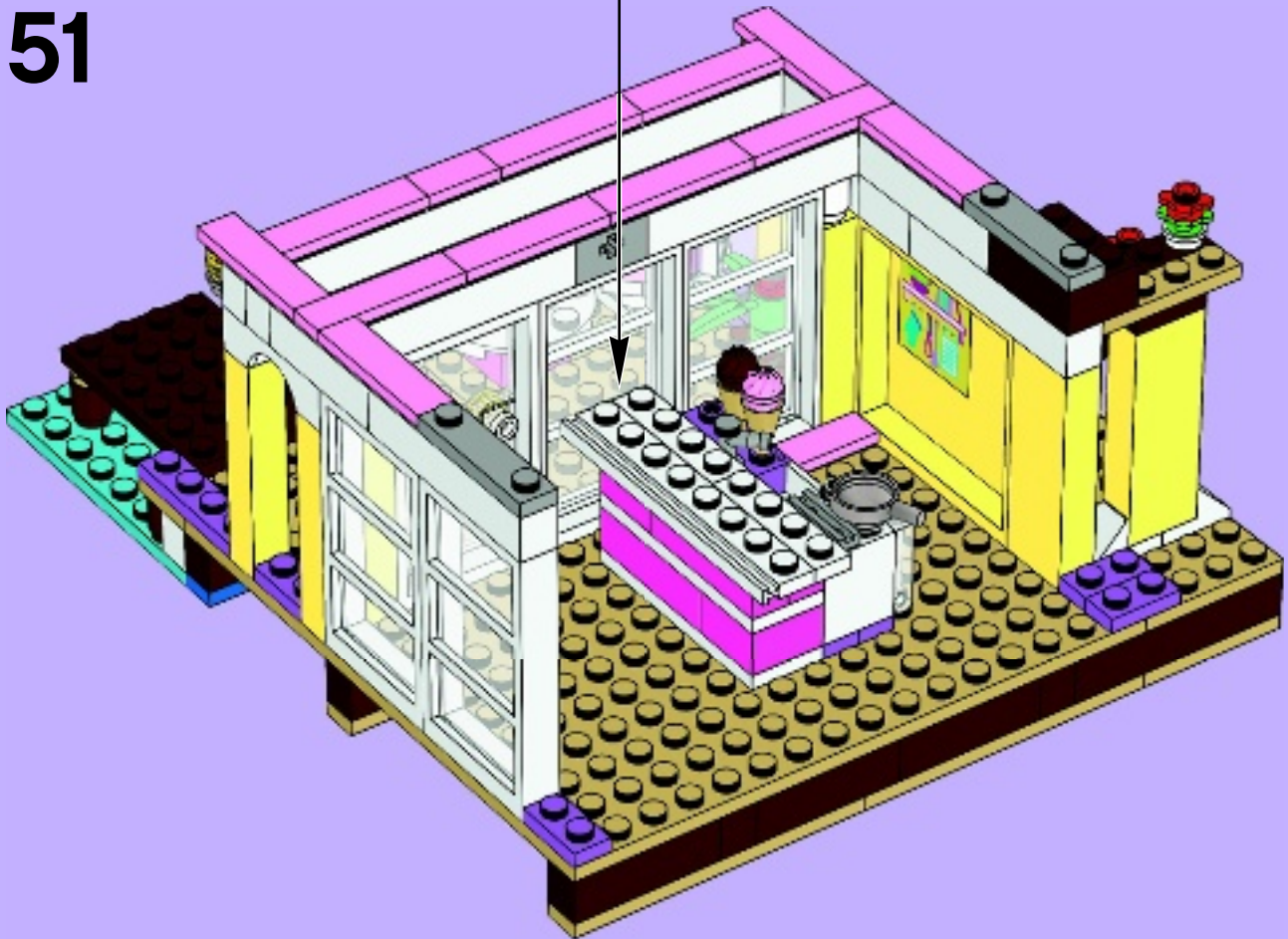



2x



2x

52

1



2



2x

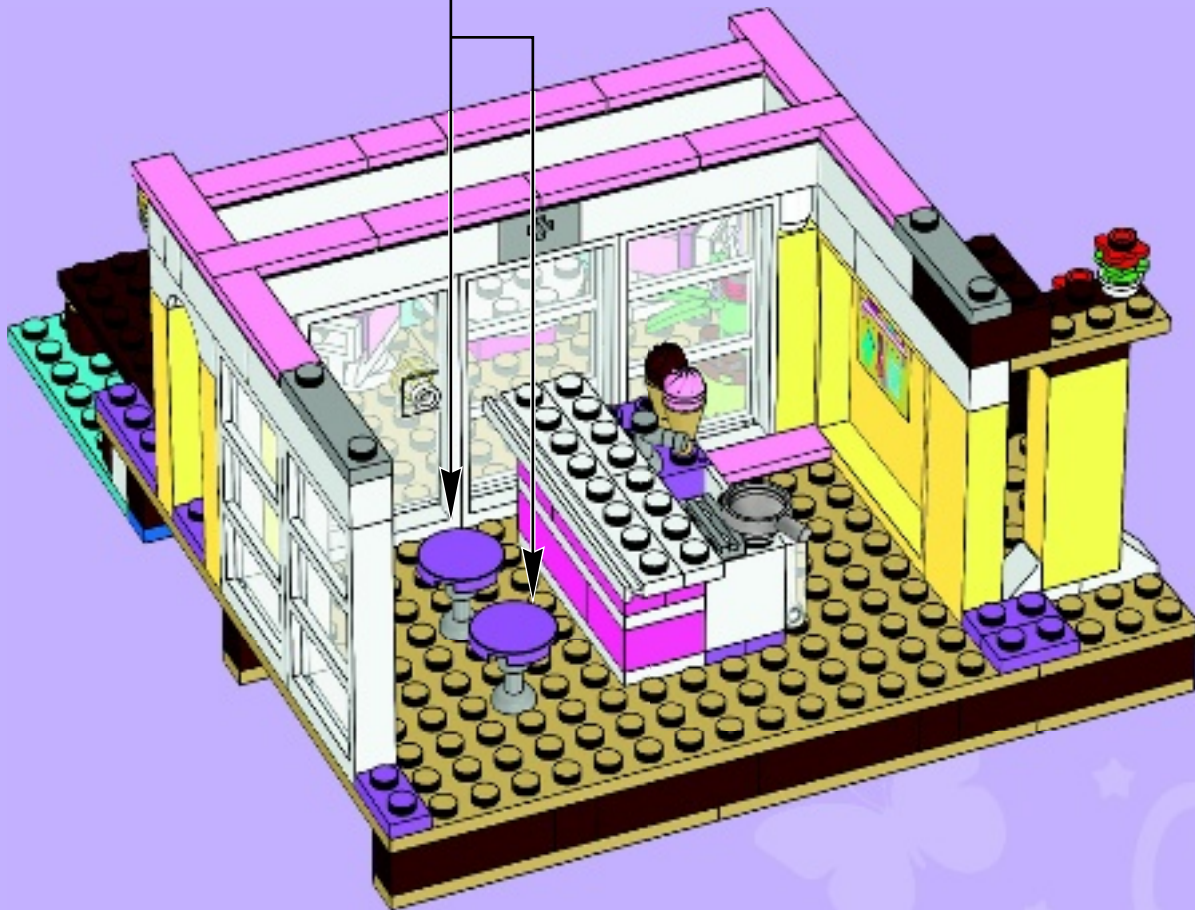



53



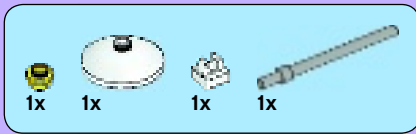

54

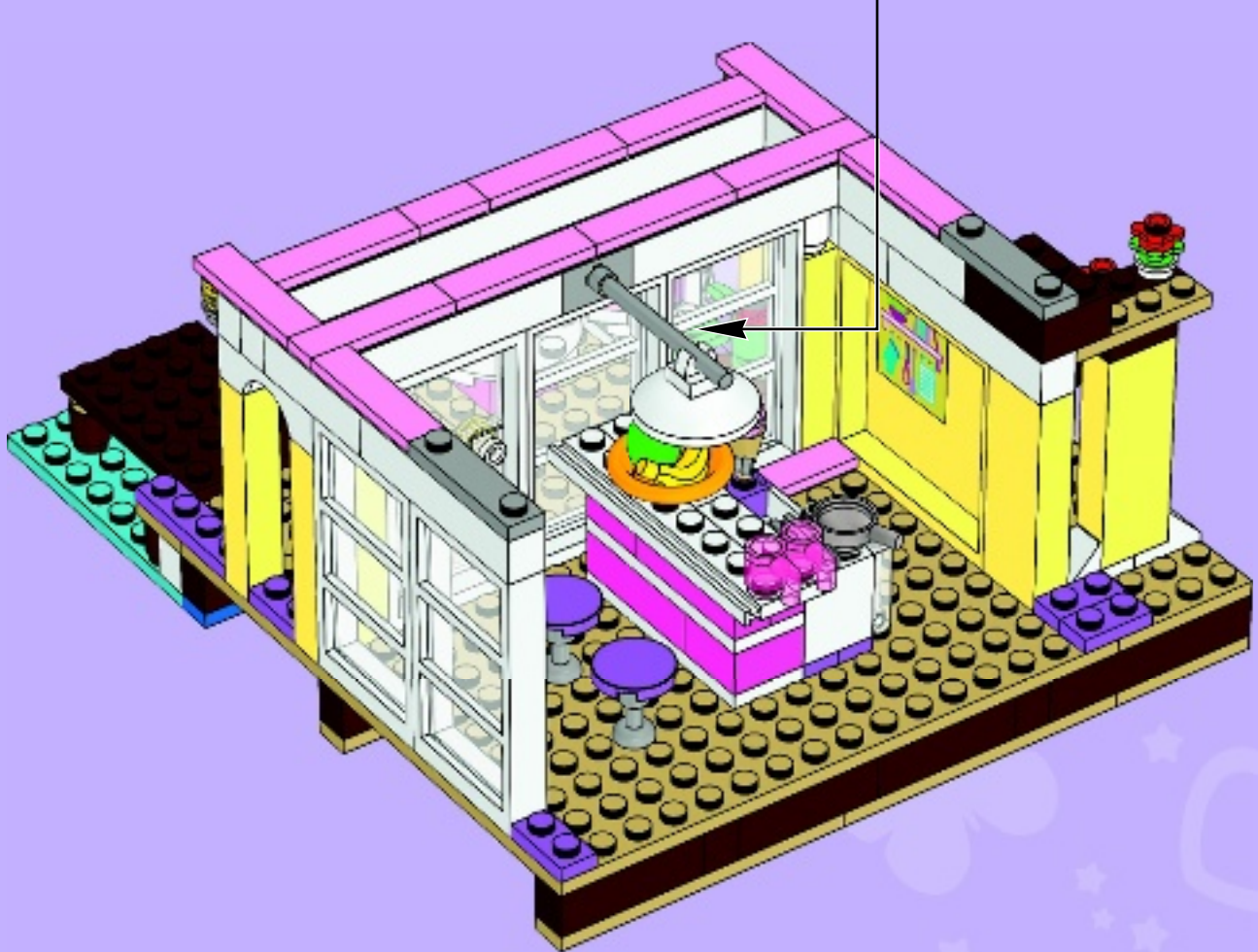
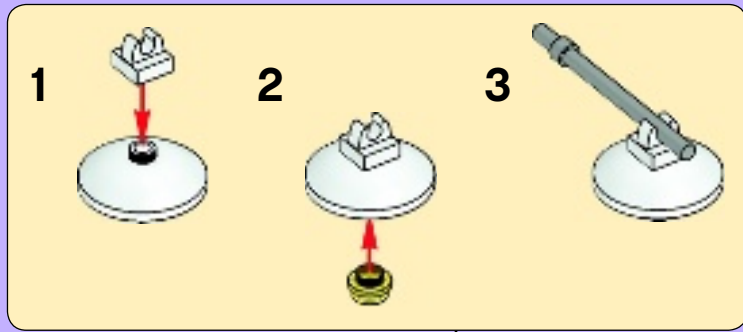



+

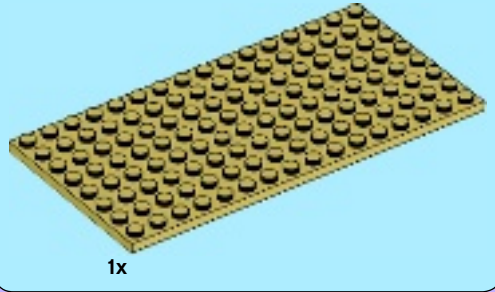
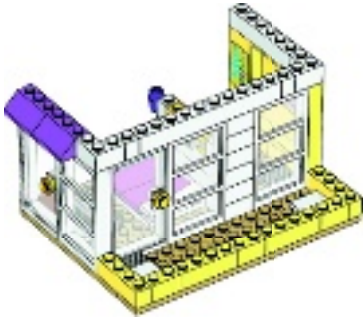
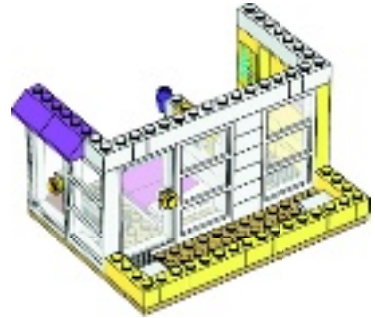

1

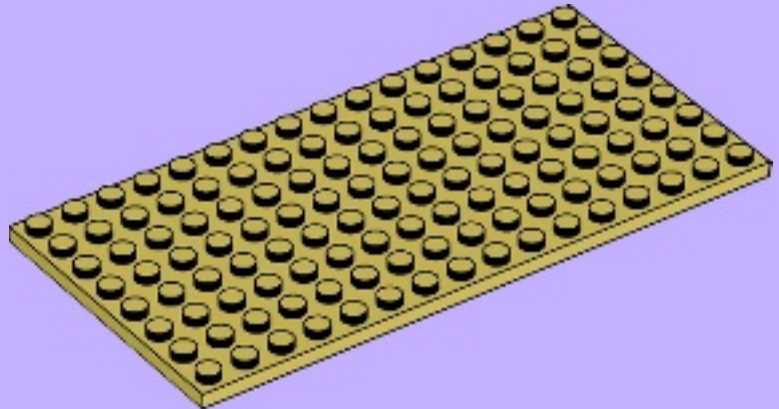

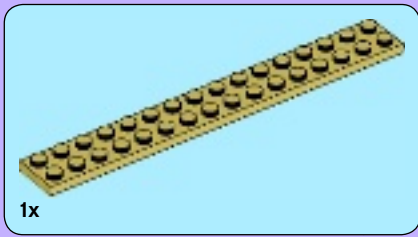

2

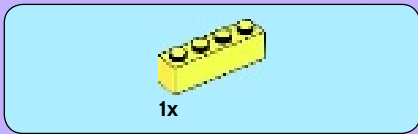
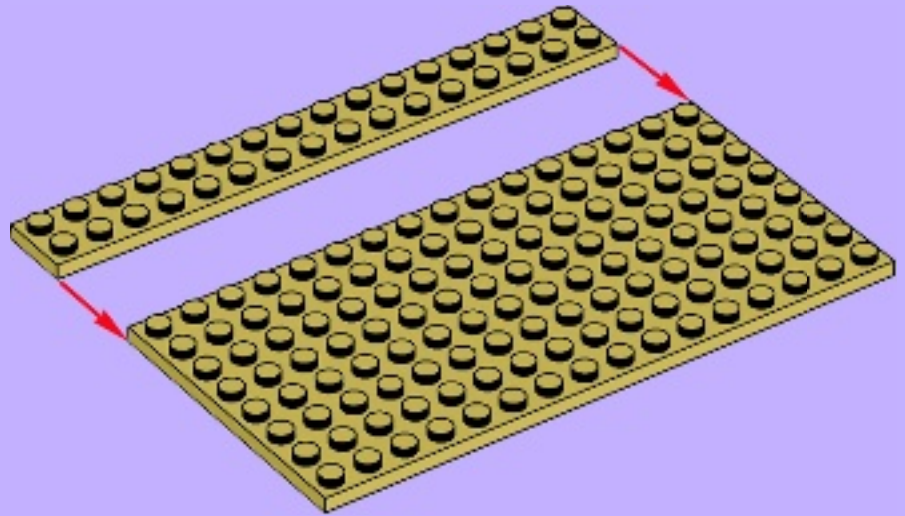

3

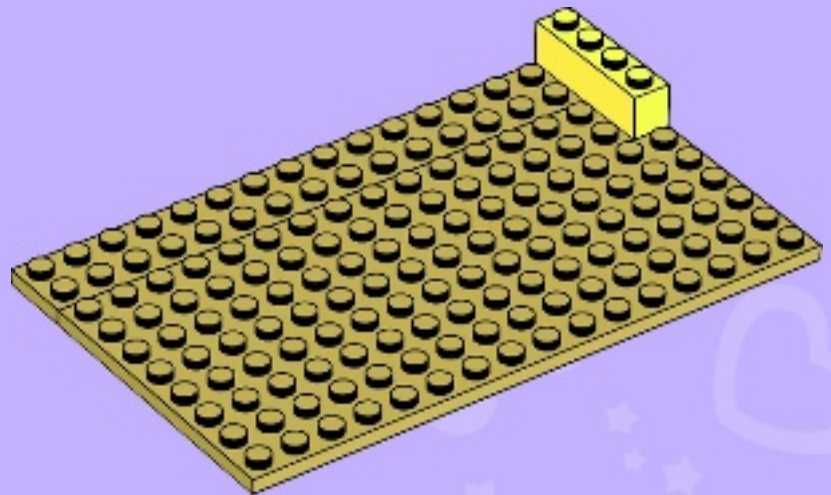

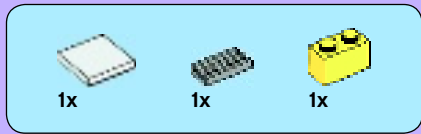

4

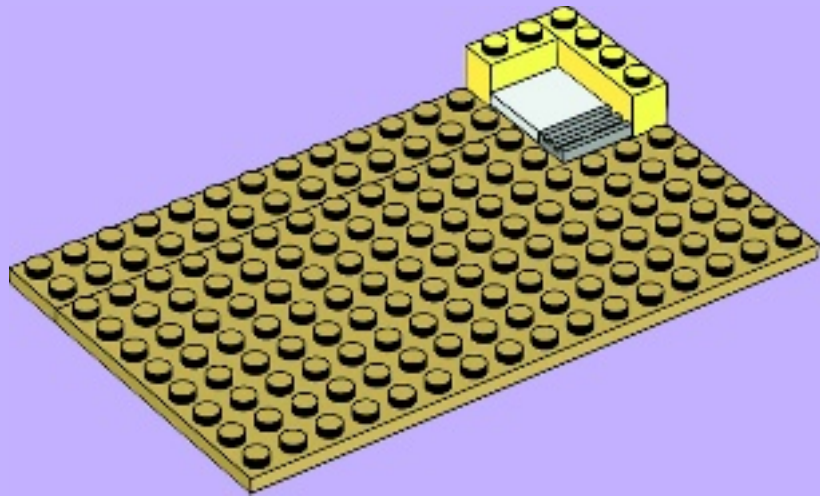



5

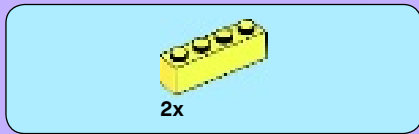
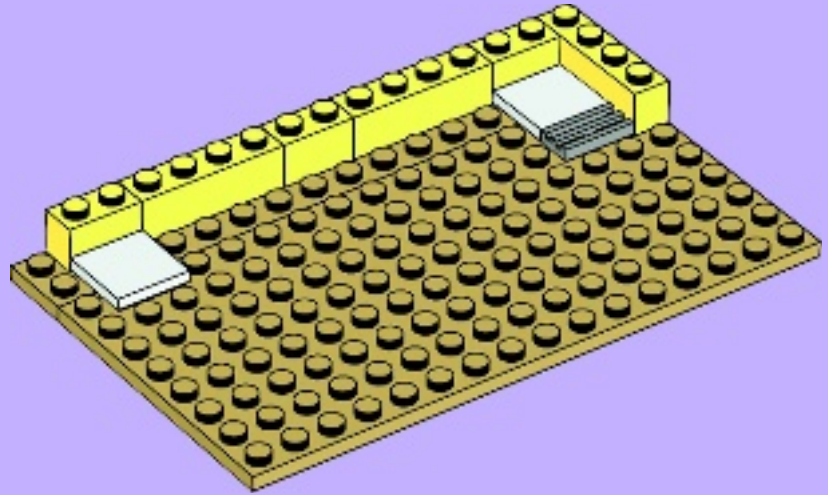

6

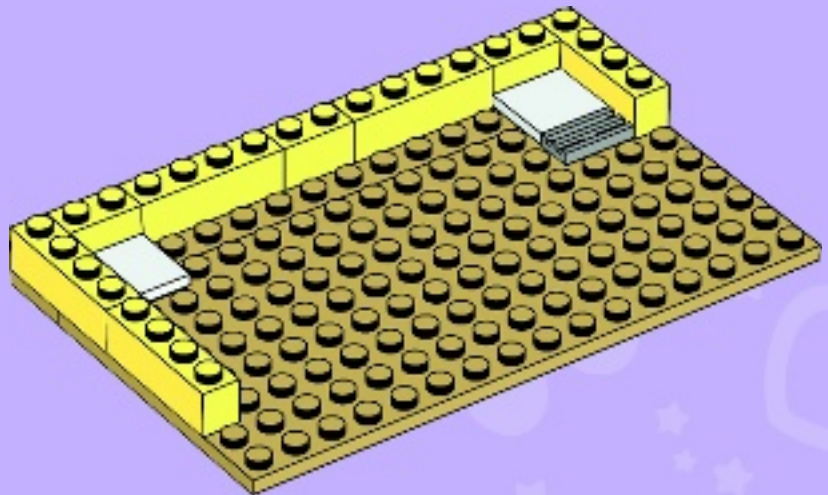

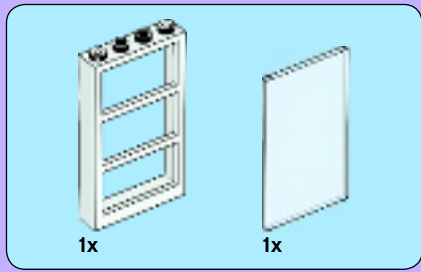

7

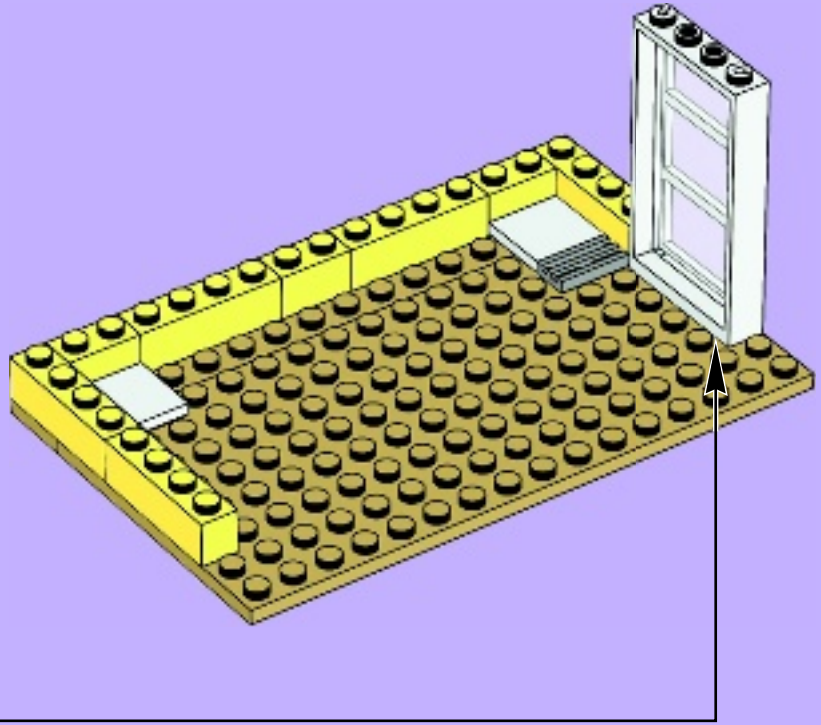
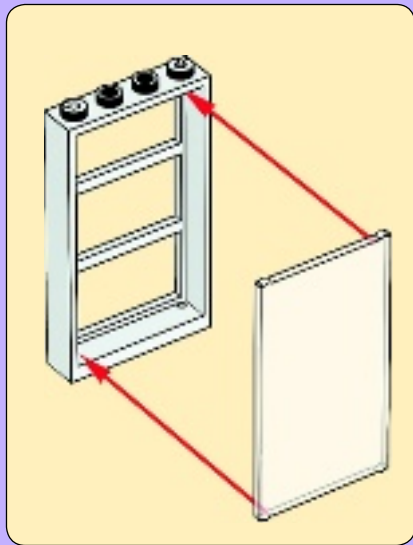

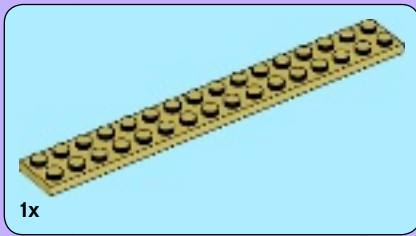

8

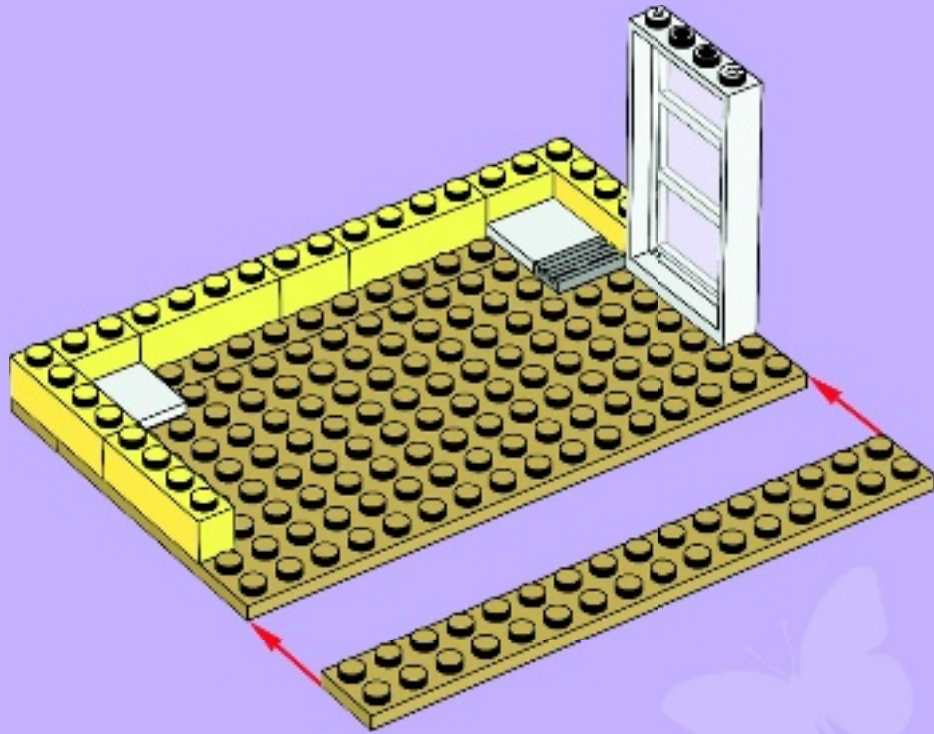



1x

9

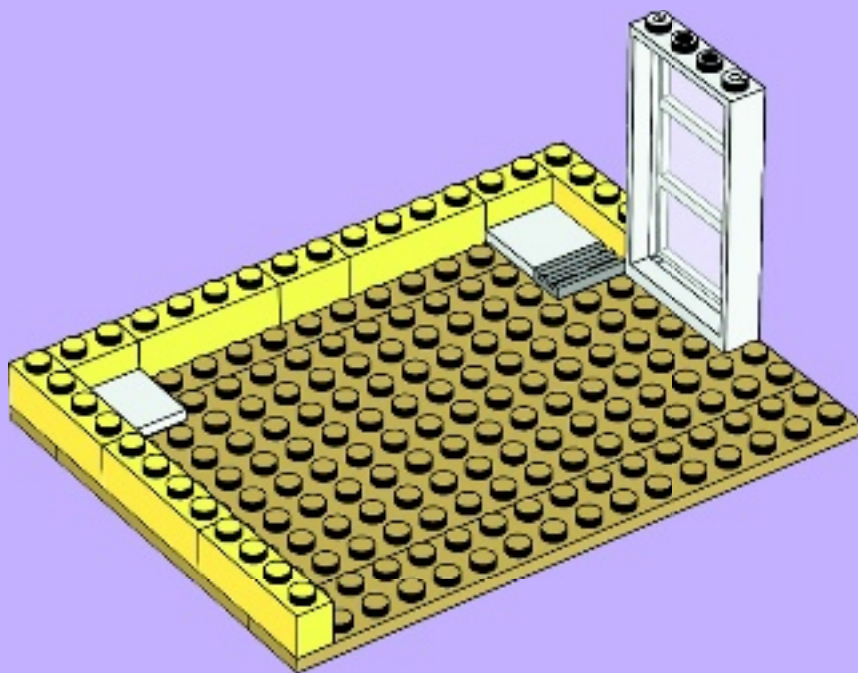

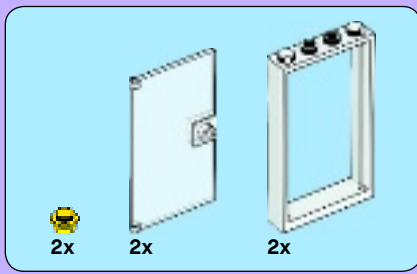

10

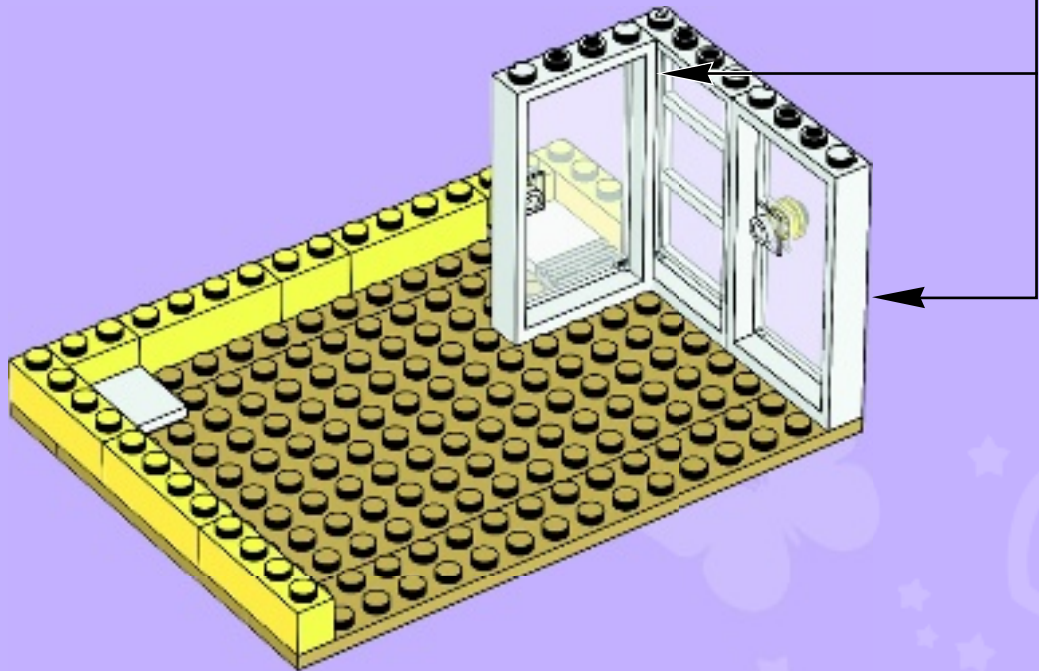
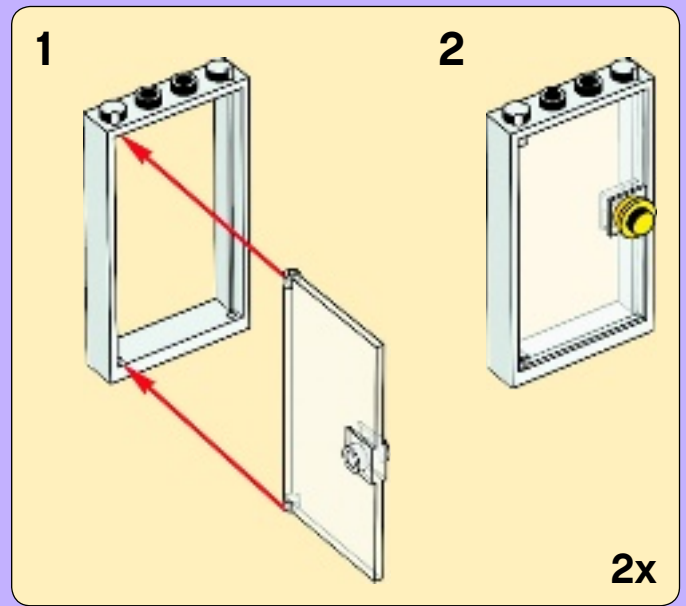

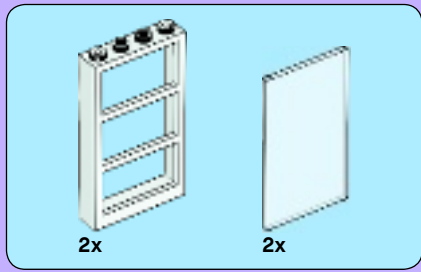

11

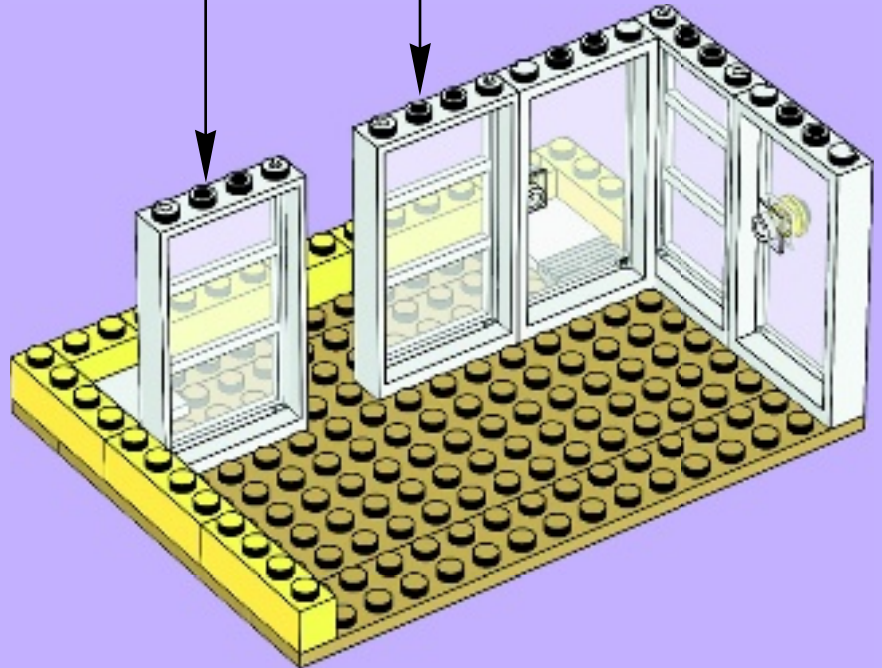
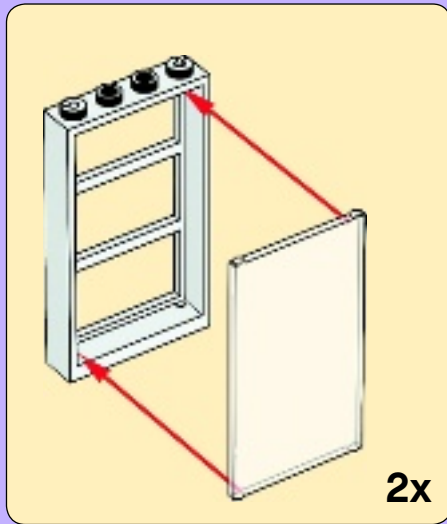

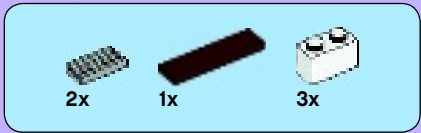

12

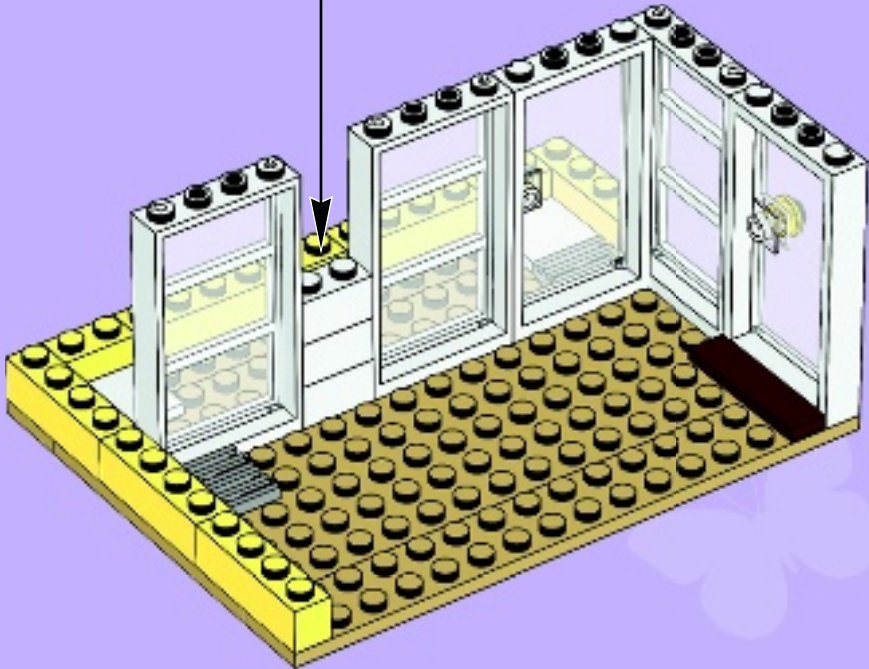
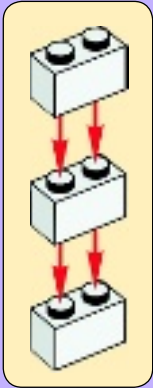



13

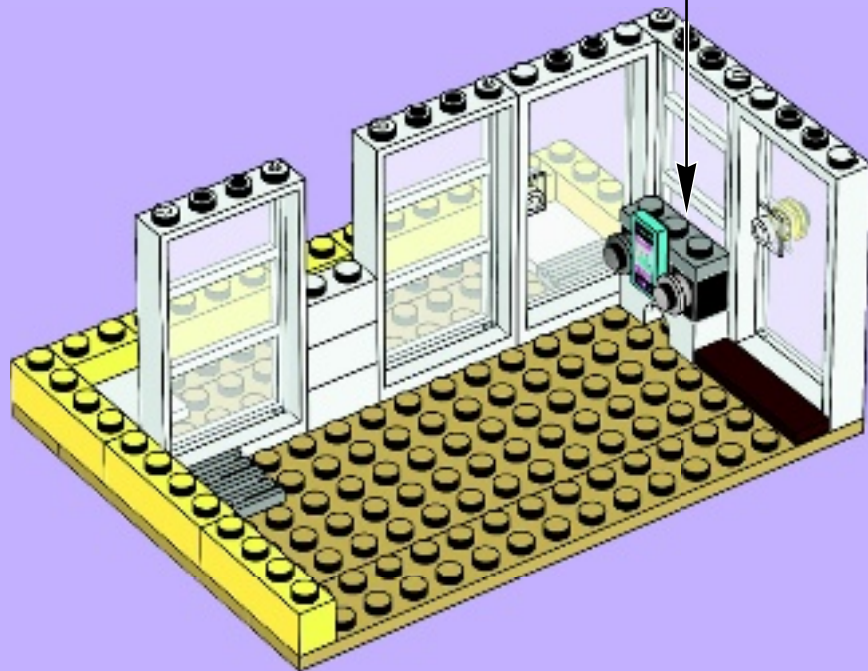
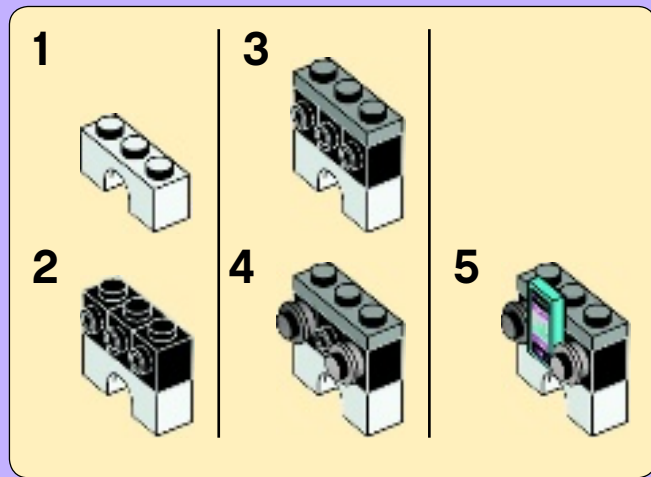

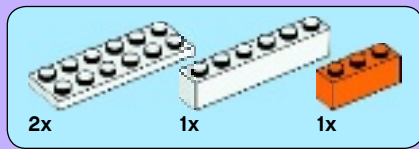

14

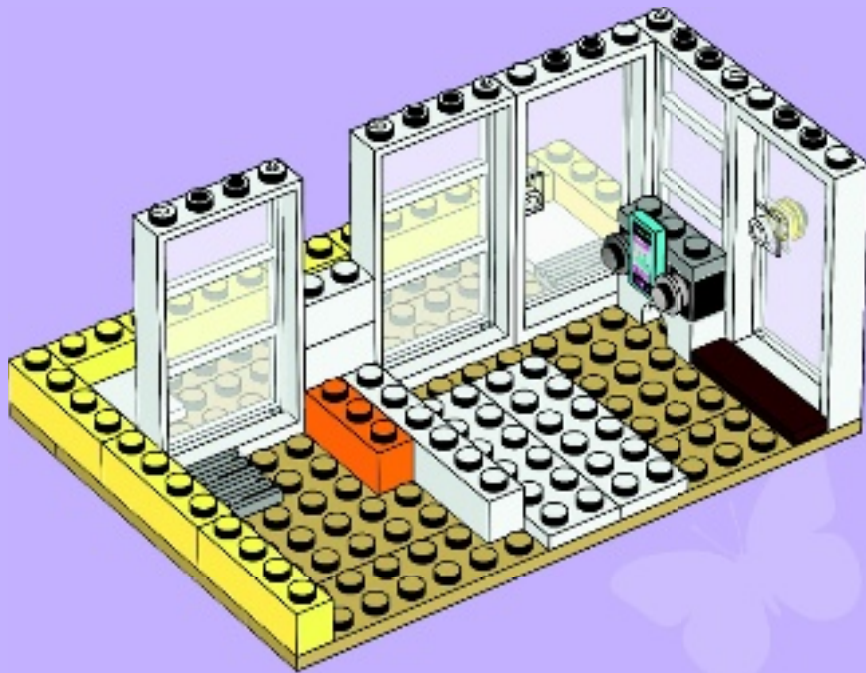



2x

15

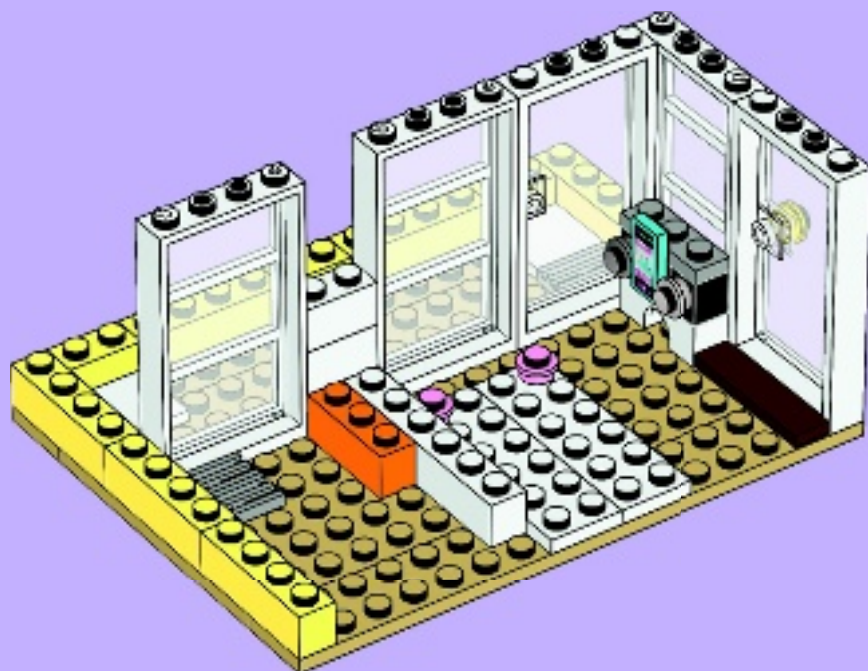



2x

16

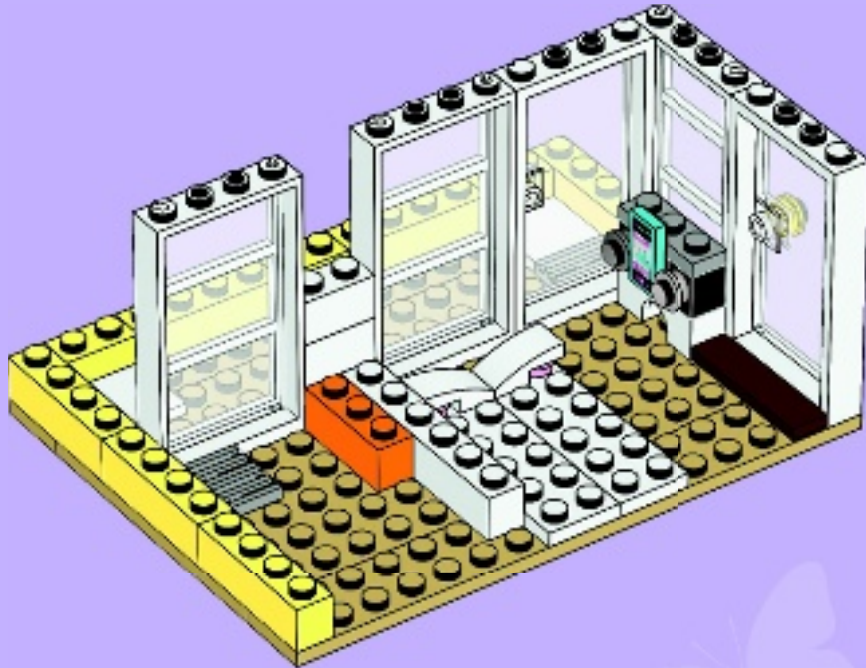

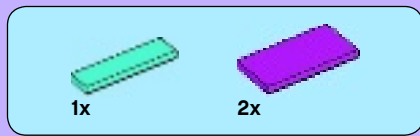

17

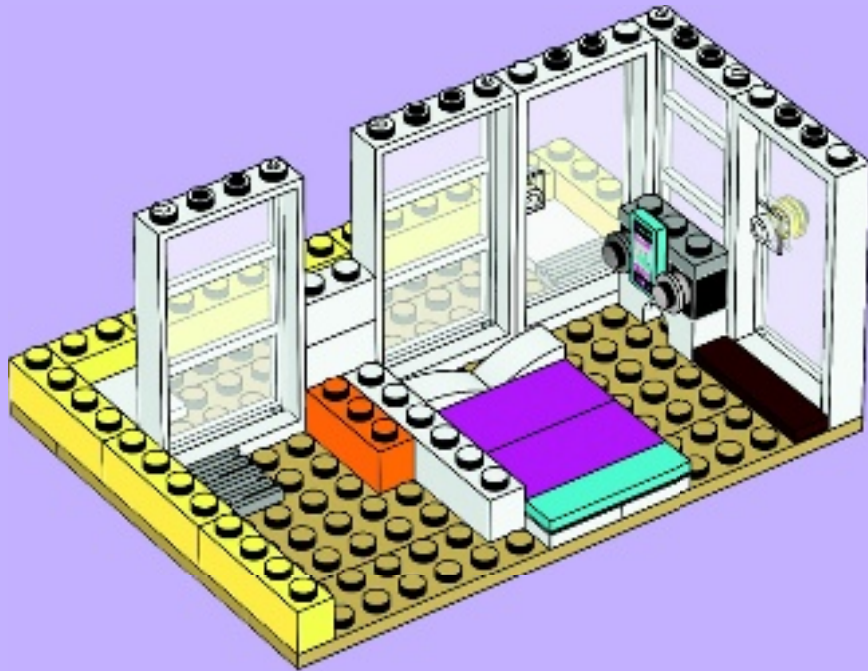



2x

18

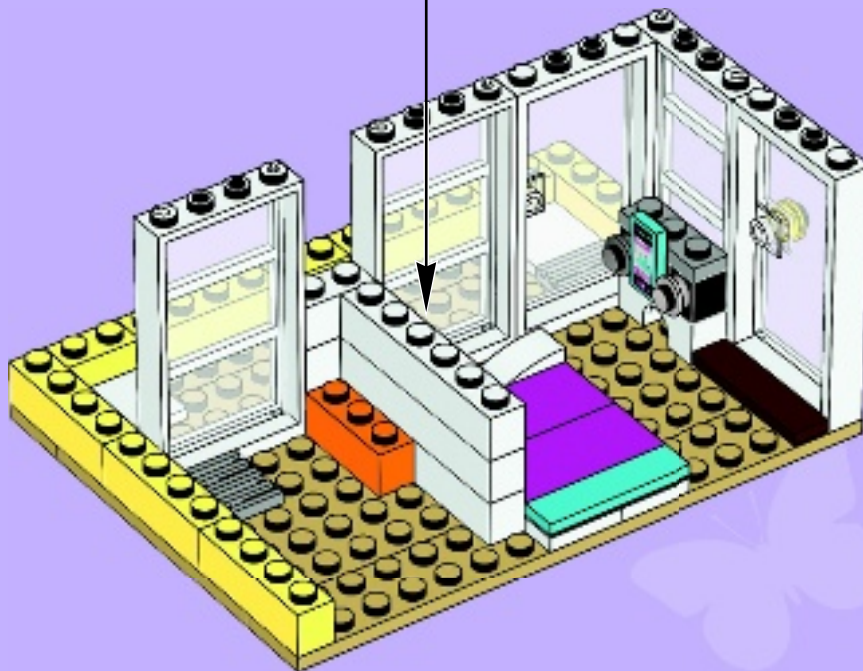
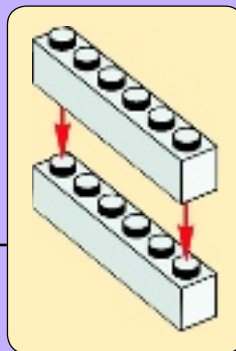



2x



1x

19

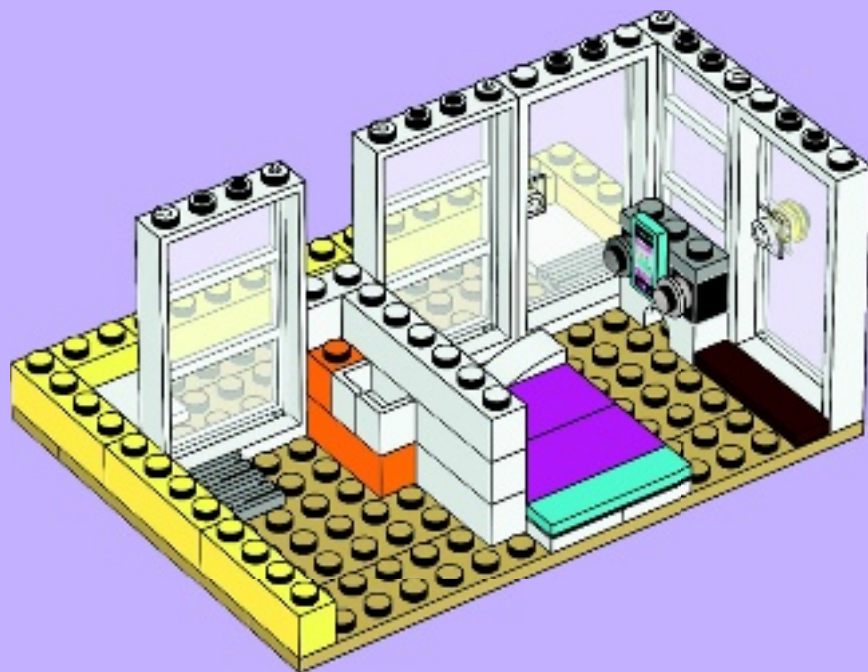



20

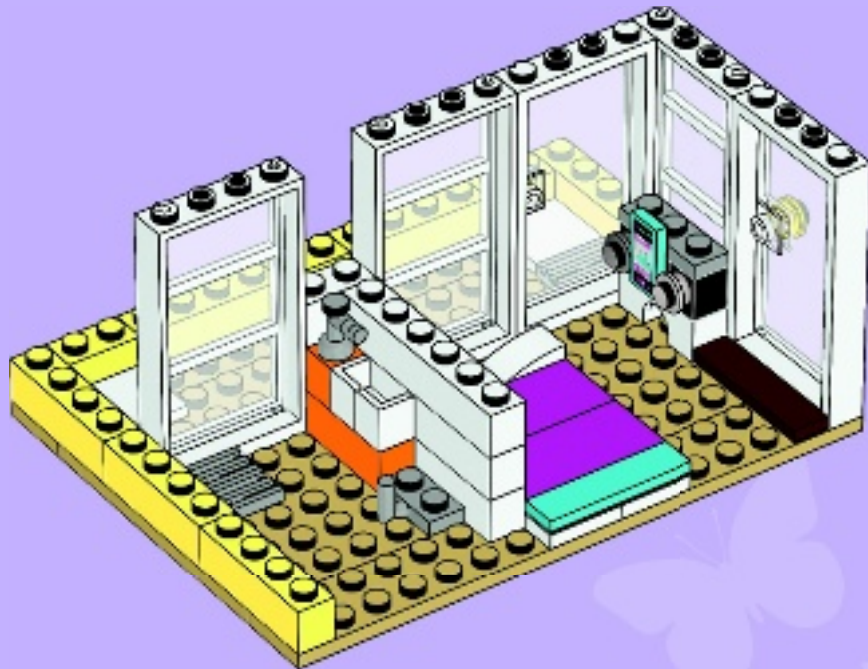



1x



1x

21

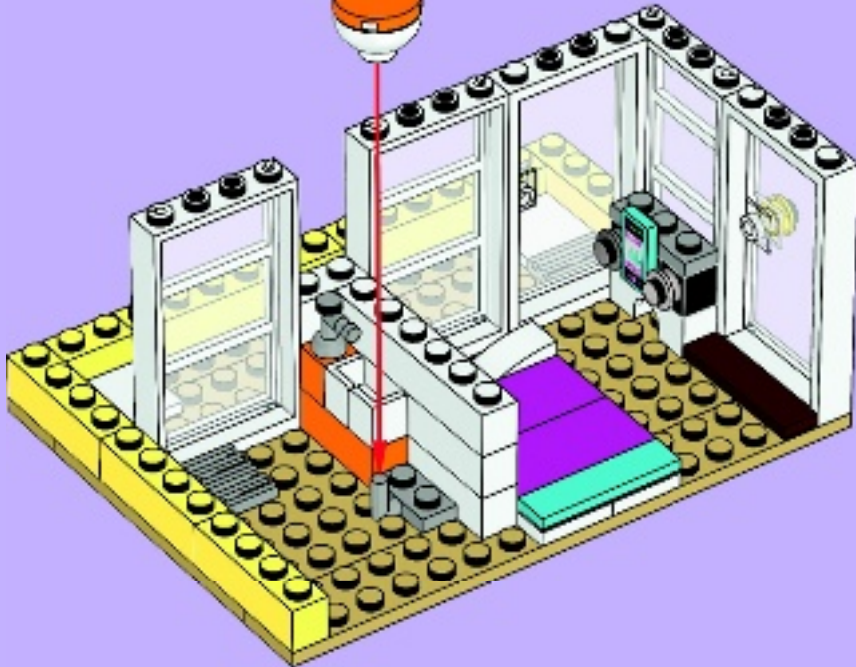
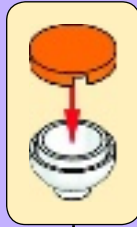



1x

22

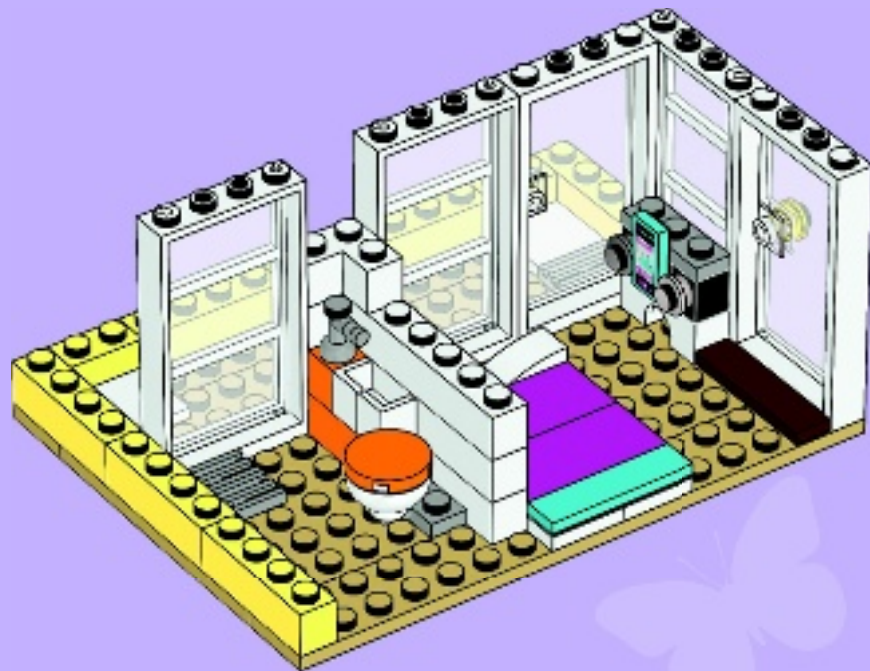



2x

23

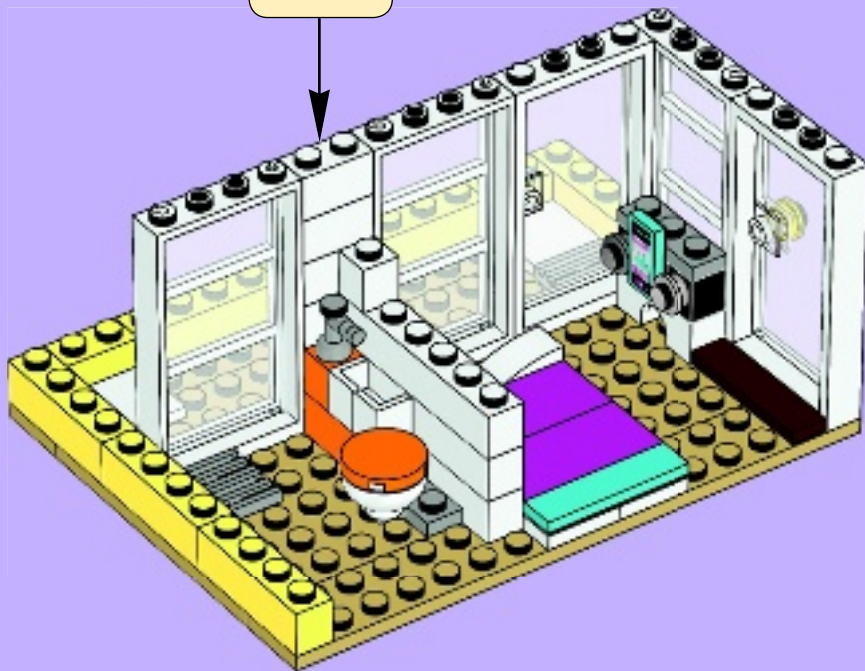
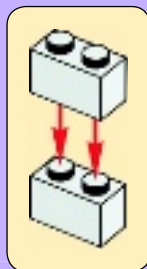



24

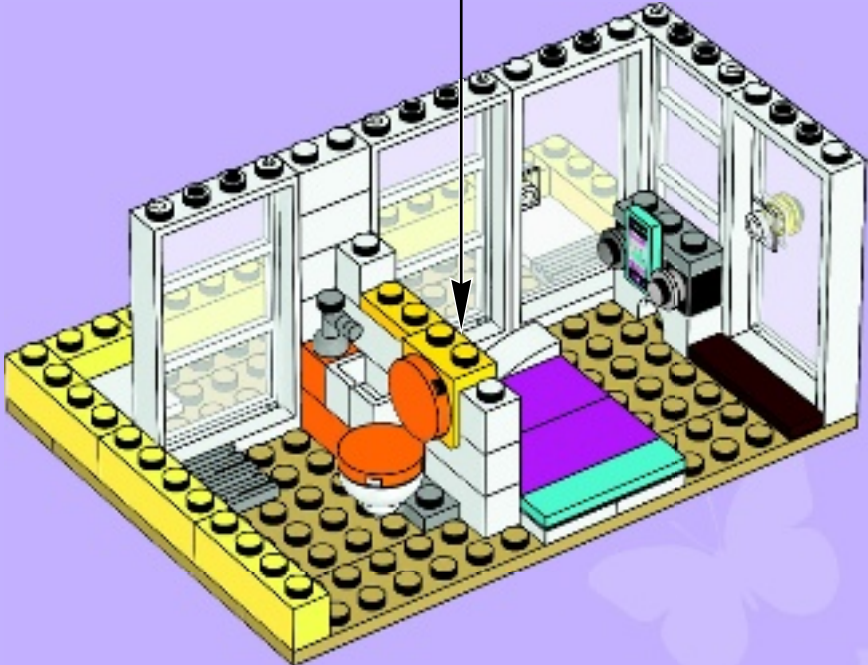
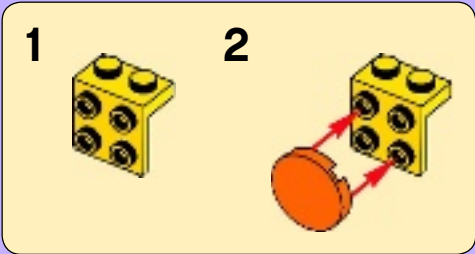



2x

25

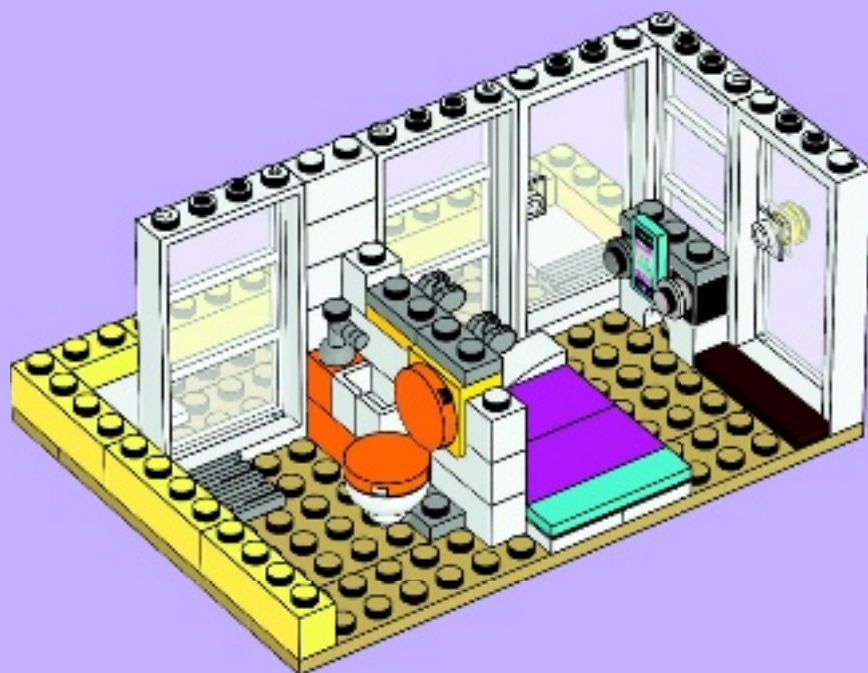



1x



1x

26

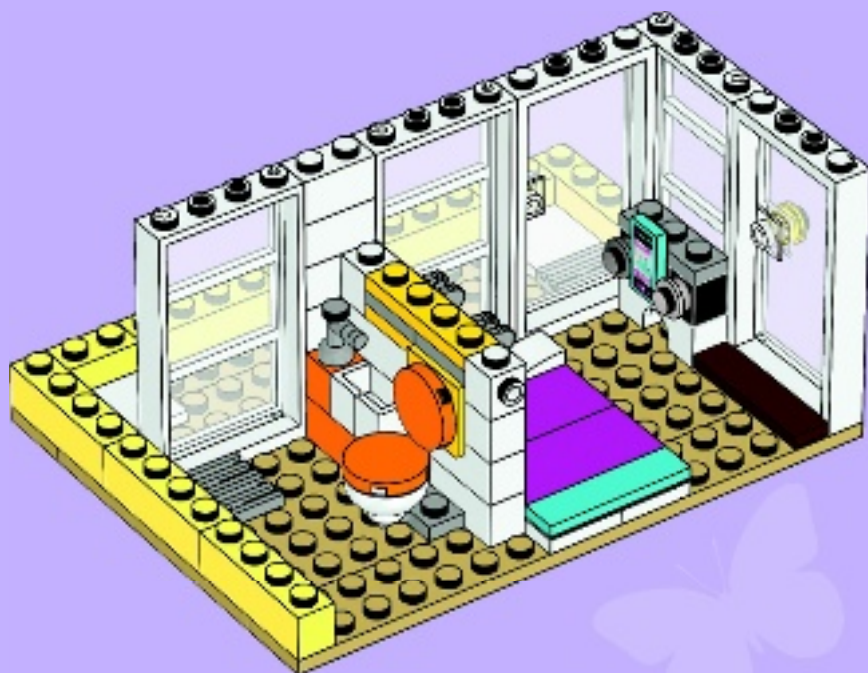

27

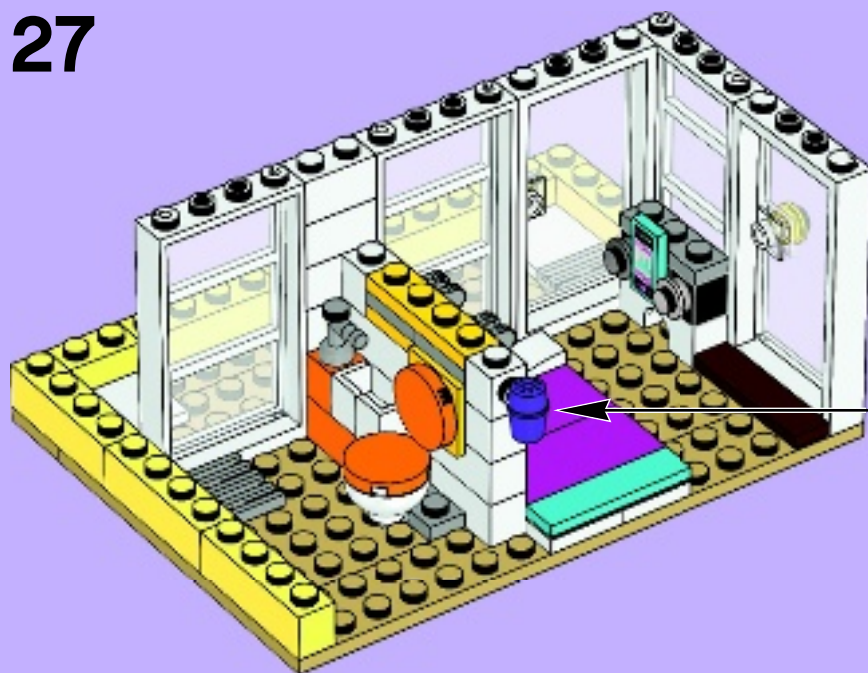

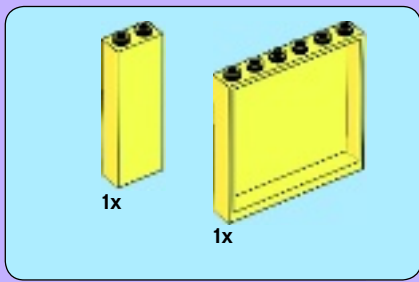

28

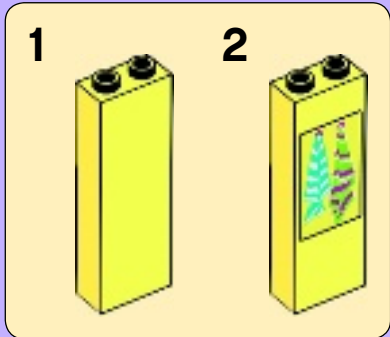
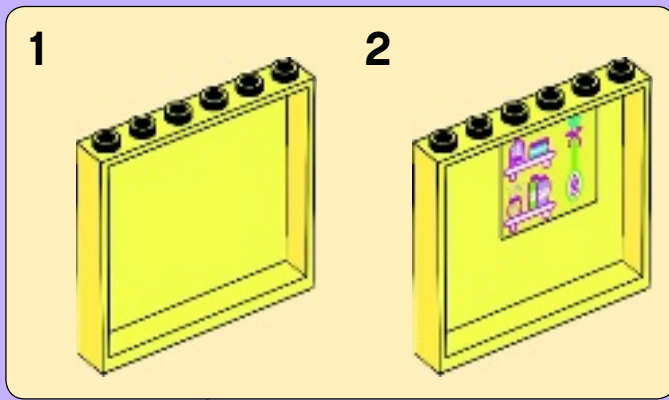
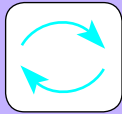

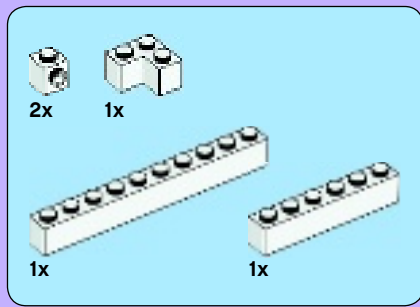

29

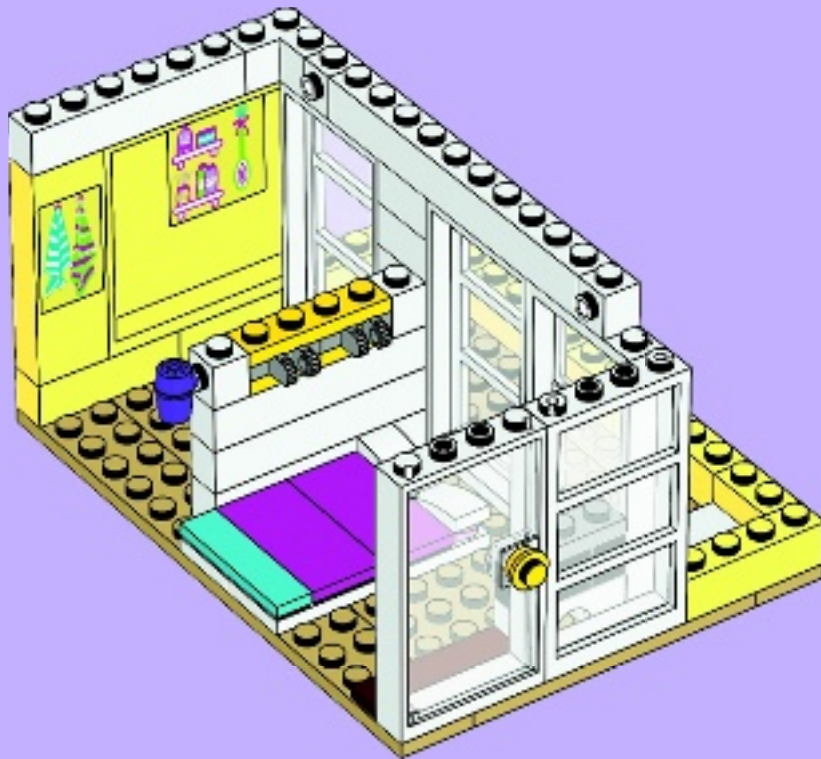



1x



2x

30



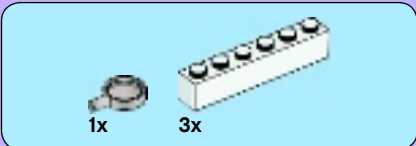
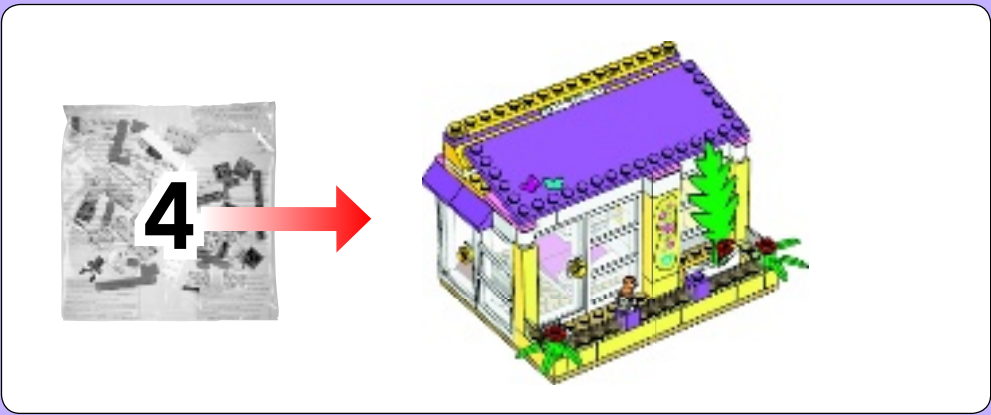

31

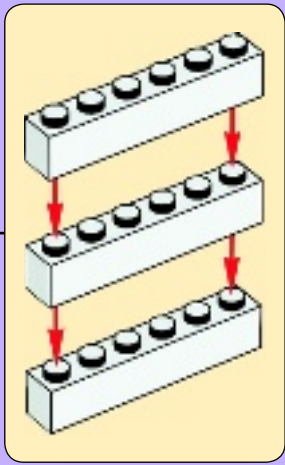



1x

1

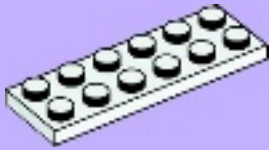

1x

2

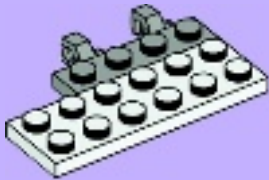

2x

3

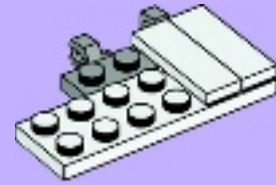

1x

4

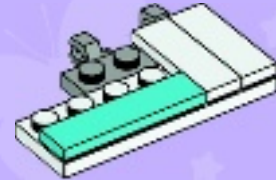

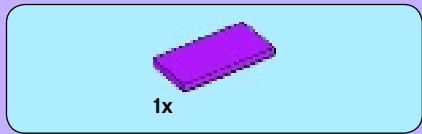

5

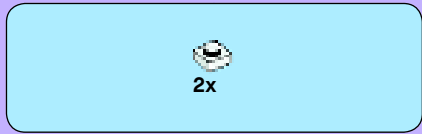
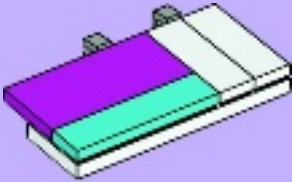

6

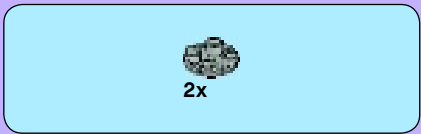
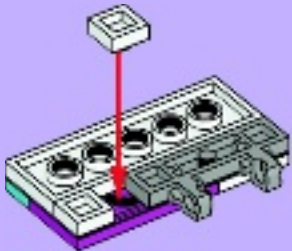

7



8

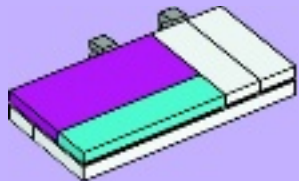

32

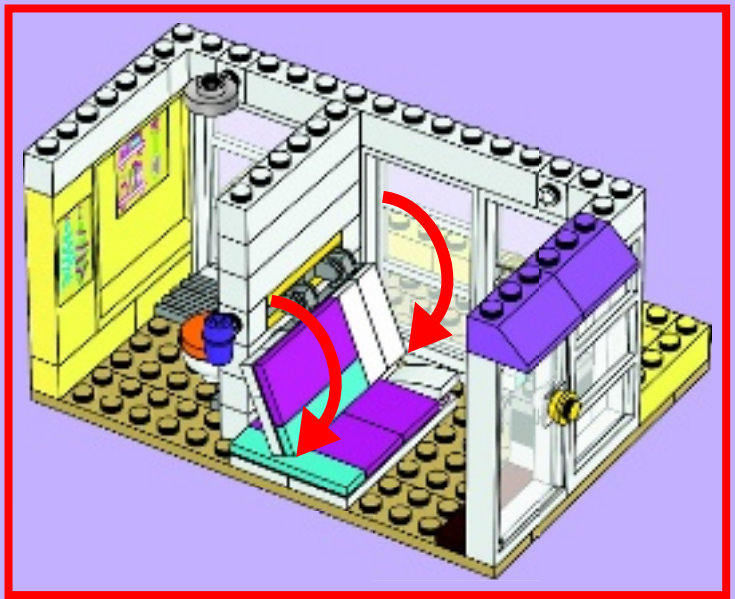

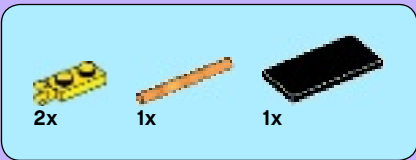

33

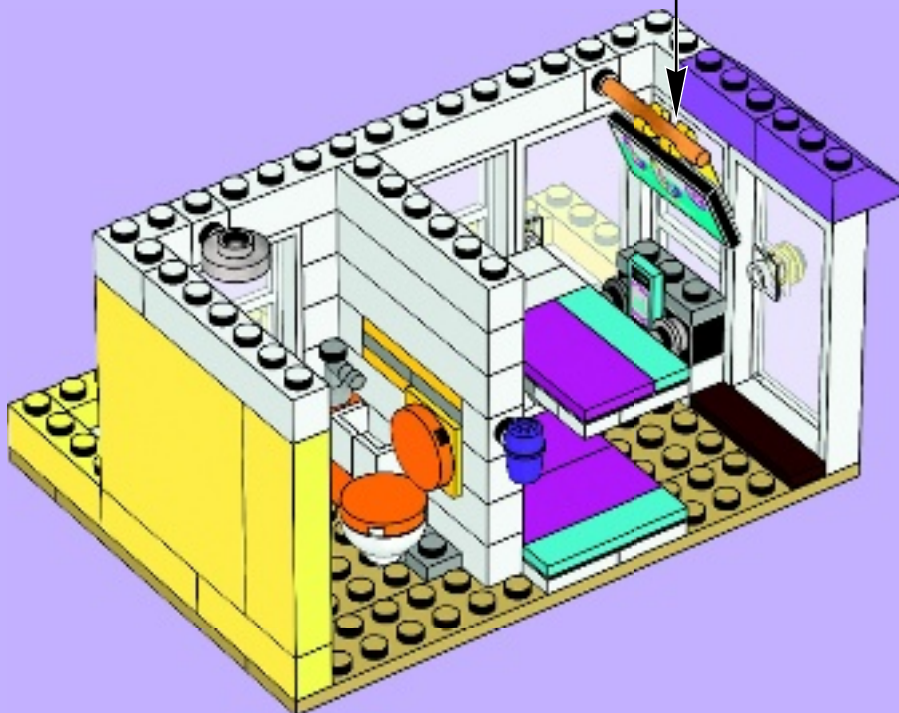
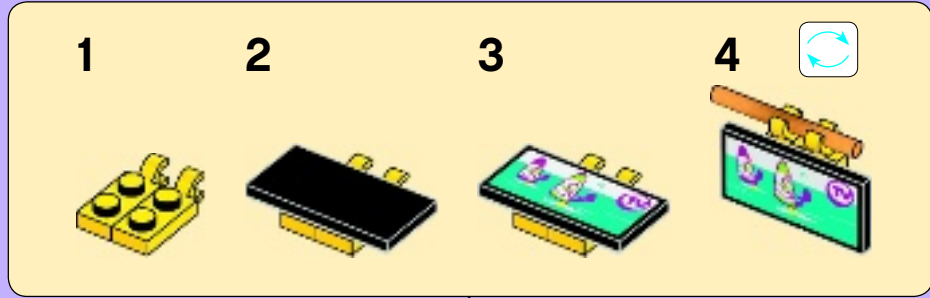
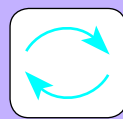

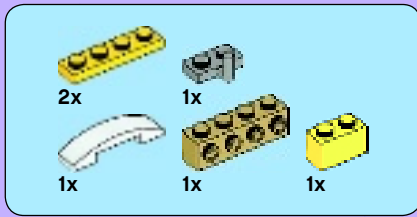

34

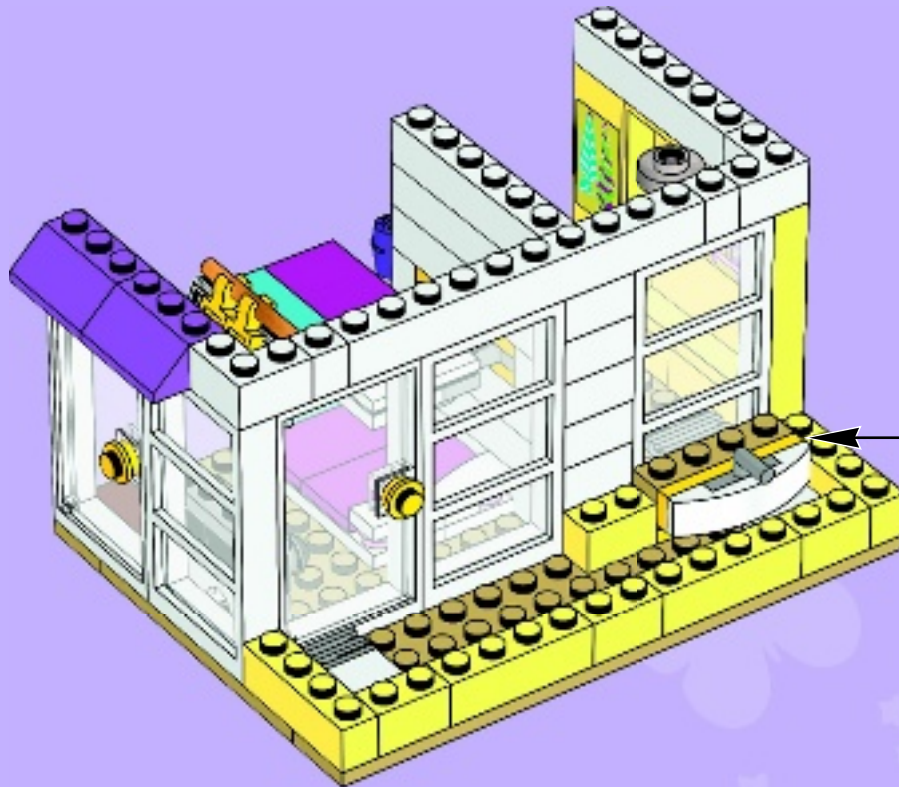
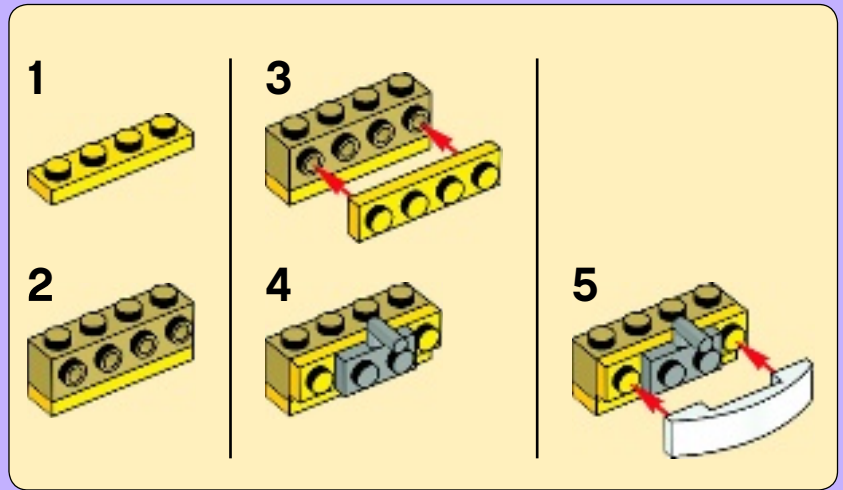

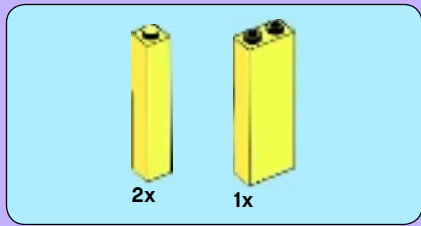

35

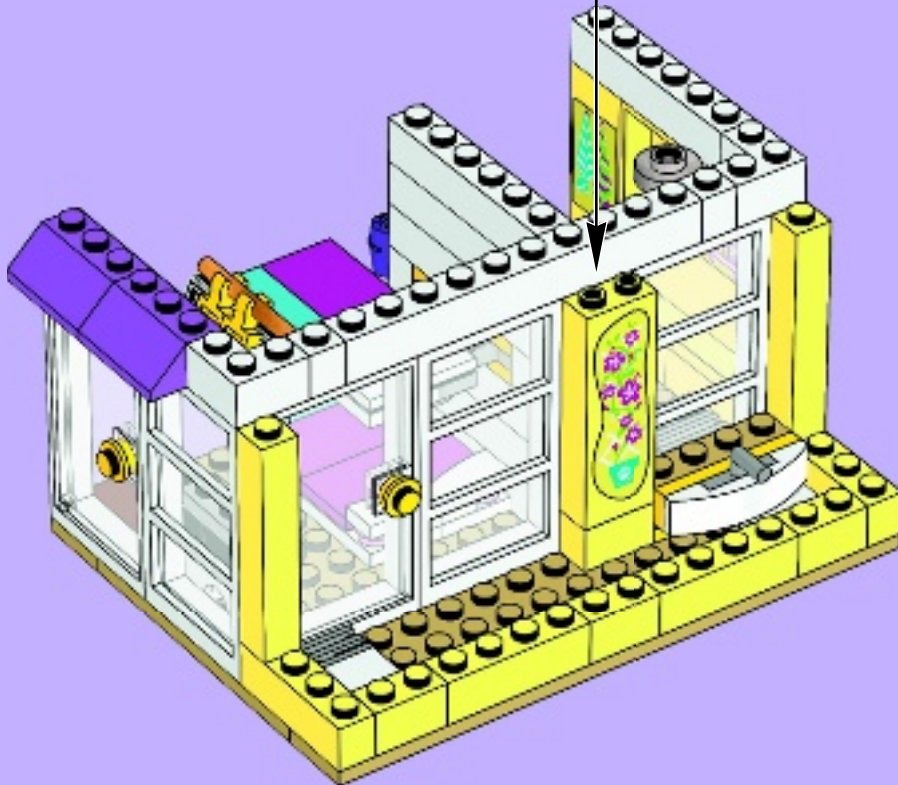
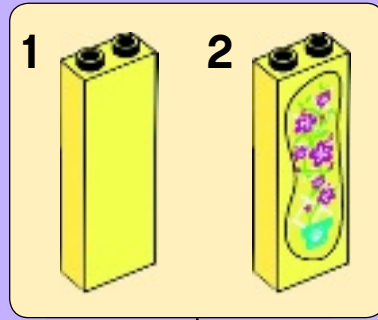



1x



2x

36

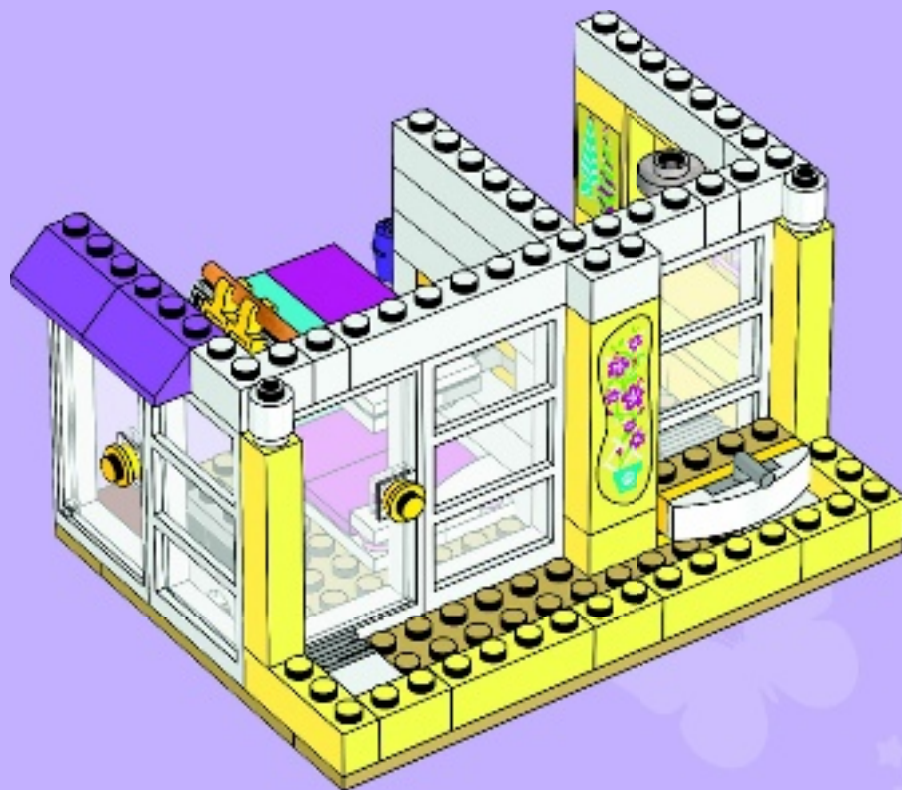

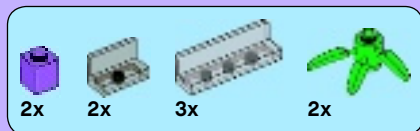

37

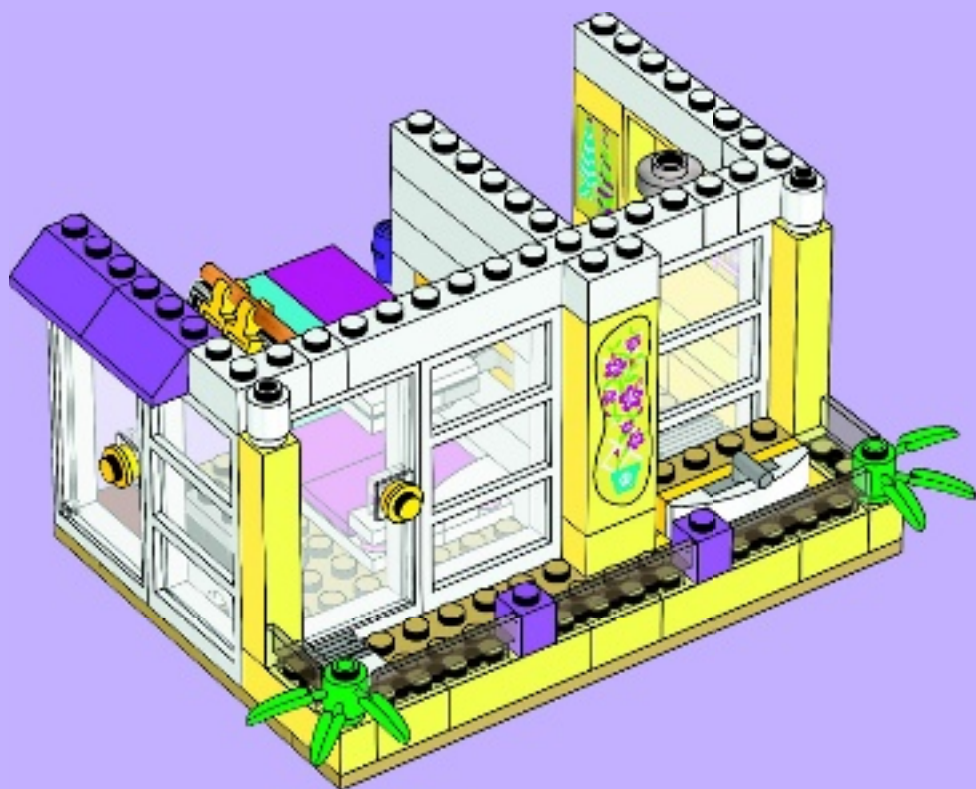



2x



1x

38

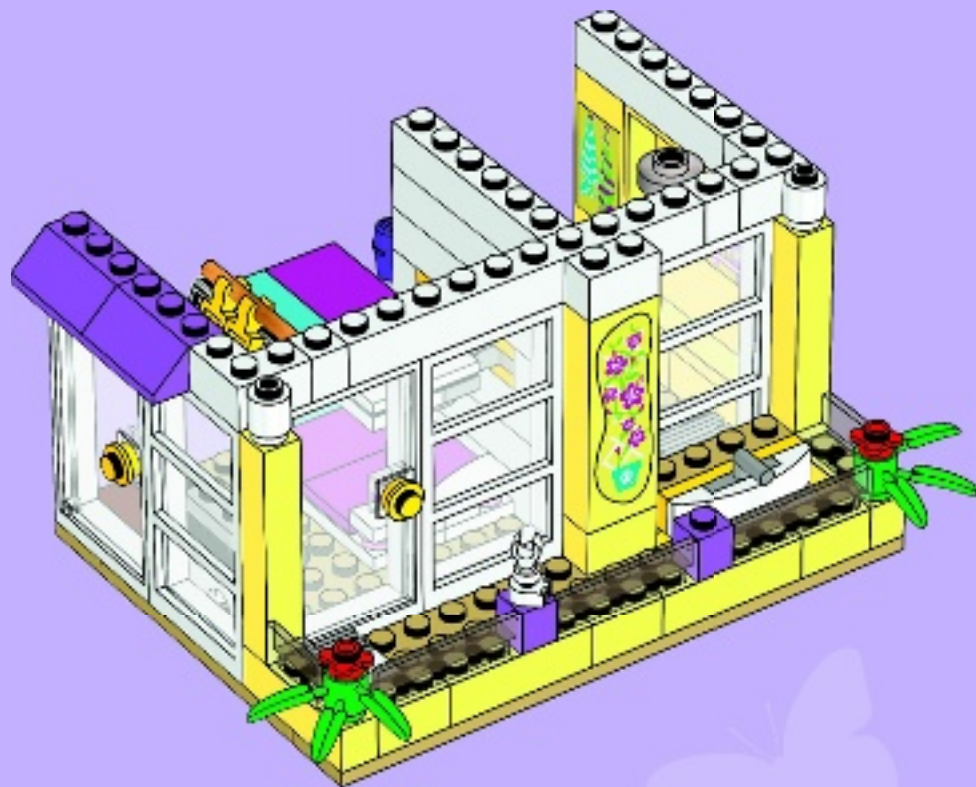



1x



1x

39

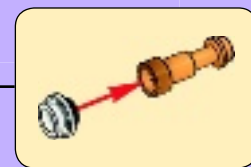

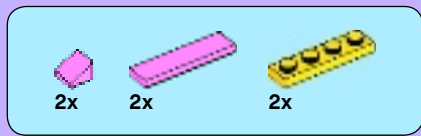

40

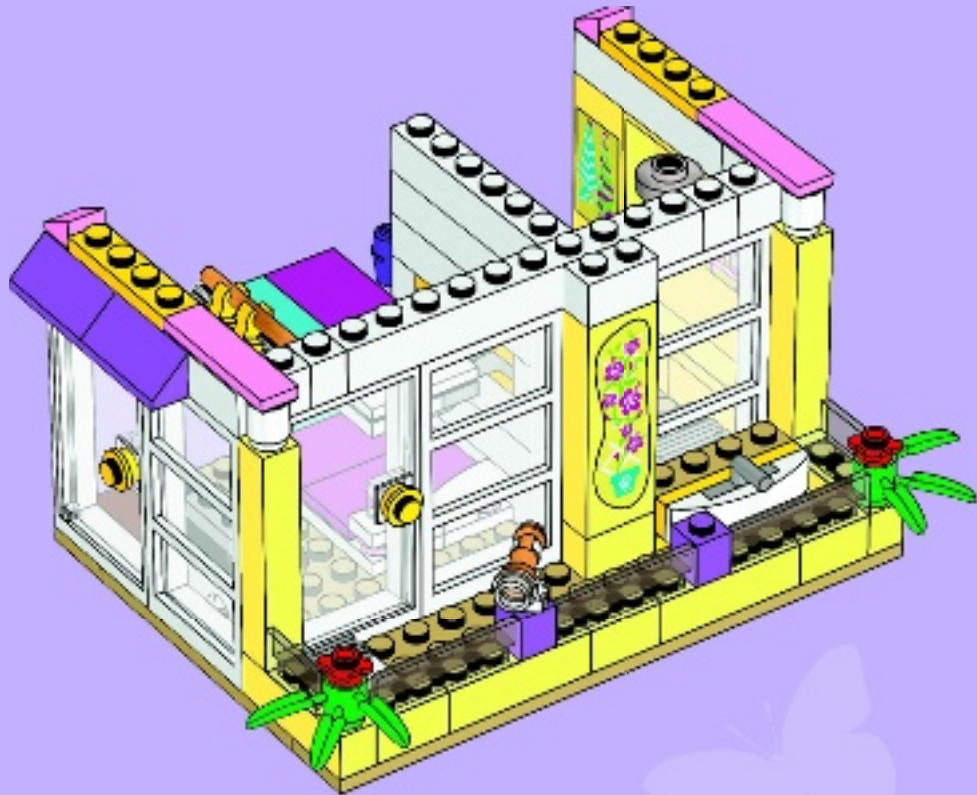

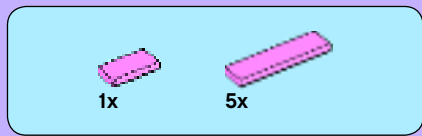

41

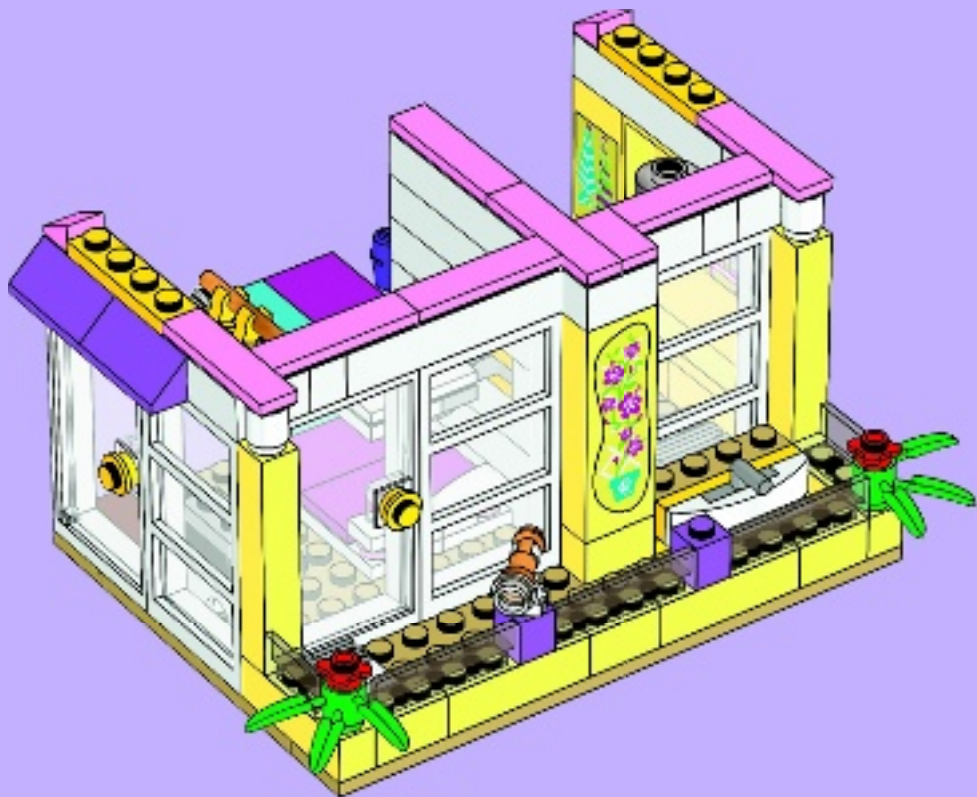

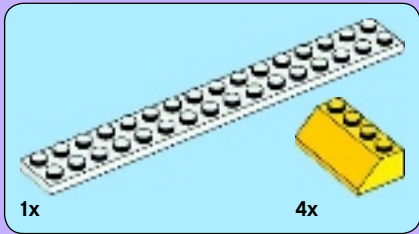
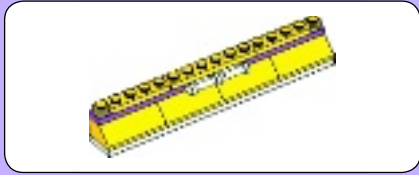
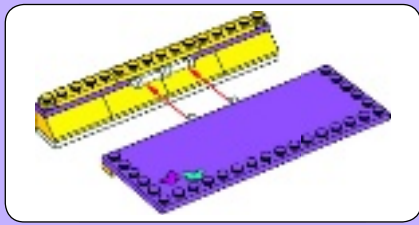

1

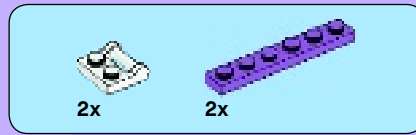
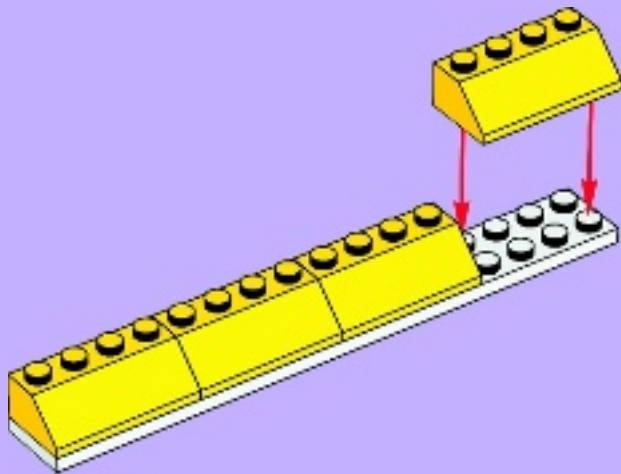

2

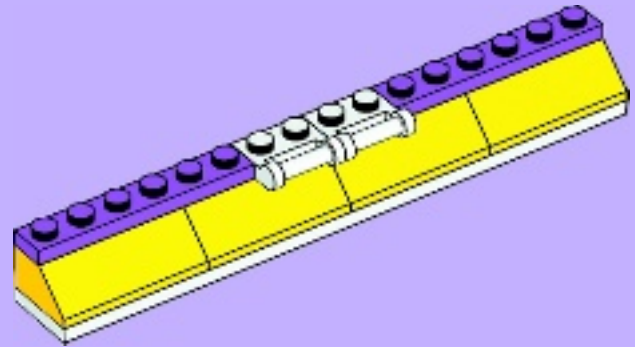

3

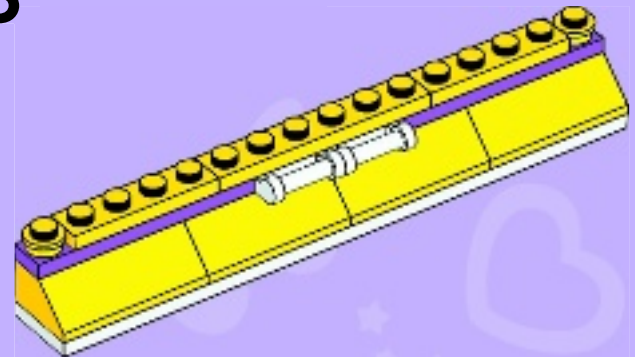

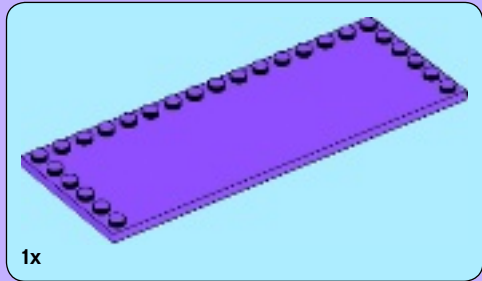
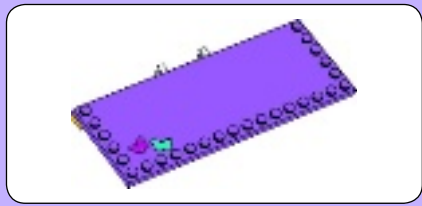

1

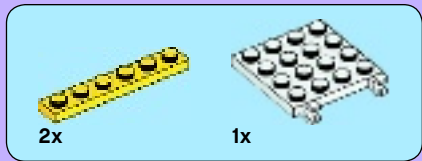
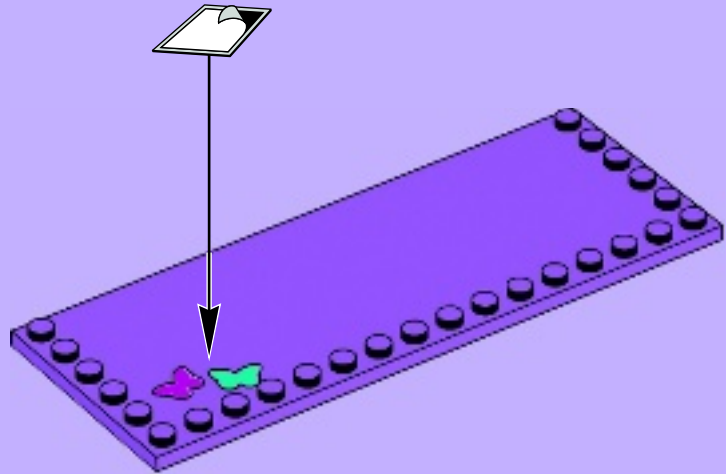

2

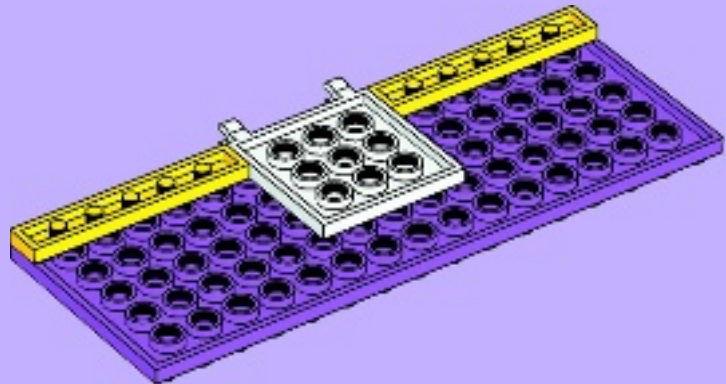
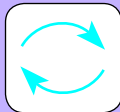

3

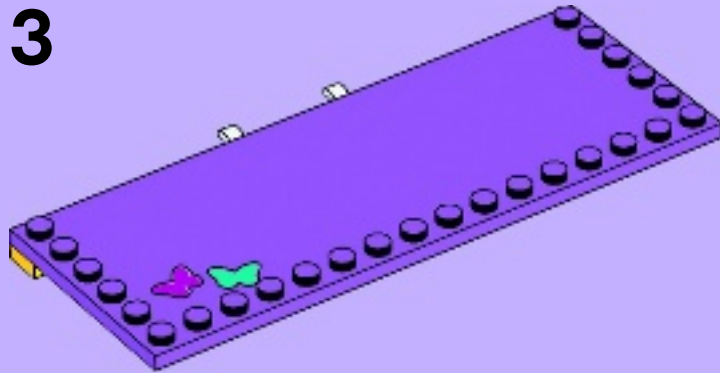

4

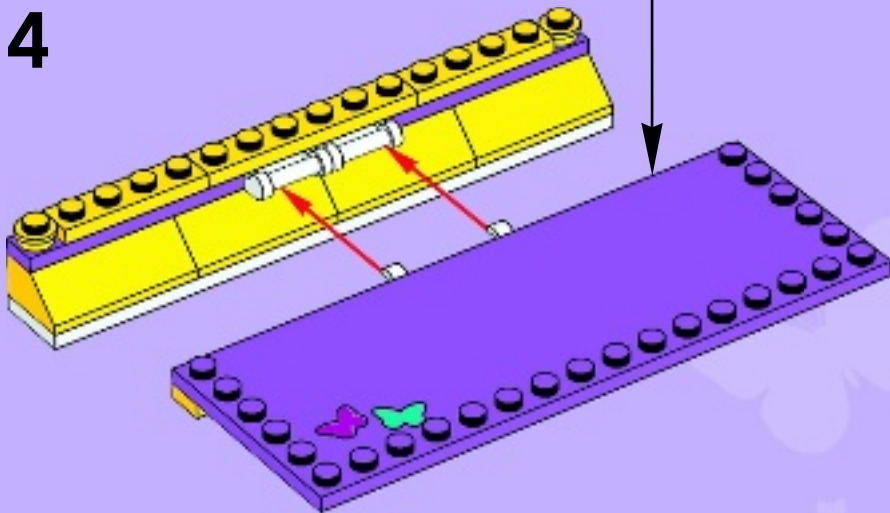

42

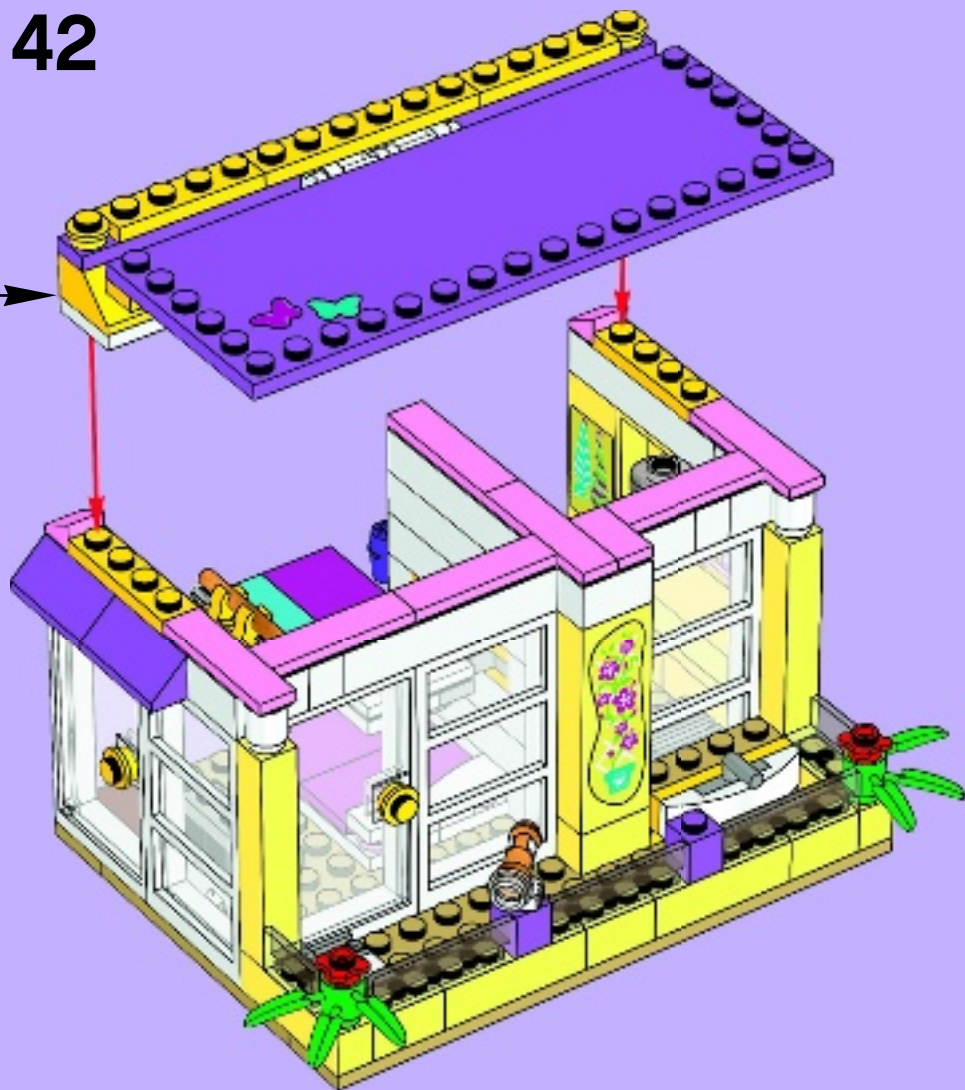



43

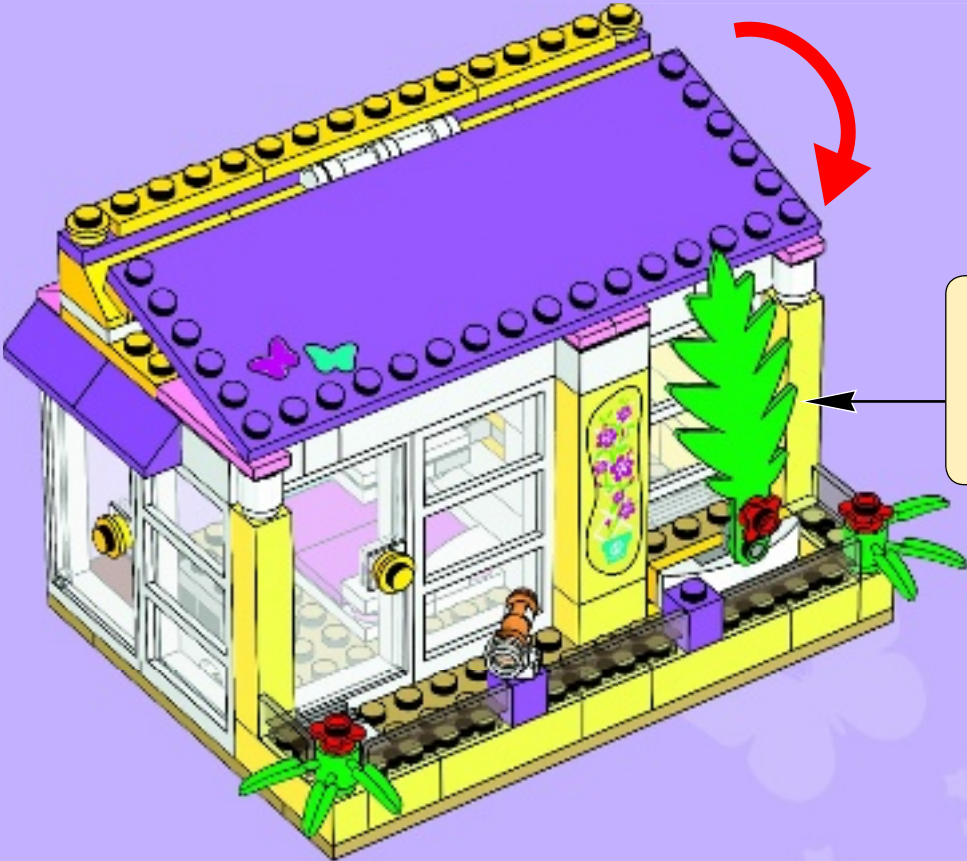

55







1x
4216668

11x
4211225

4x
4211193

8x
4211183

2x
4211252

1x
4211194

1x
4271874

1x
4211159

1x
4277751

1x
6060731

2x
4624705

1x
6038640

1x
4233493

4x
4211350

1x
4211429

2x
4599498

2x
4515341

2x
4611702

1x
4211840

2x
4278273

2x
4211503

1x
6061535

2x
4261919

2x
4540203

1x
6022010

2x
4599538

2x
4580010

19x
4621552

2x
4517996

4x
4619591

1x
6060795

4x
6036239

4x
6022083

6x
6036236

6x
6036232

2x
6036235

1x
6053803

1x
6034644

1x
4600345

1x
4600267

1x
4538126

1x
6035734

1x
6049231

1x
6021476

4x
4633691

1x
6052293

2x
6062386

1x
6035703

1x
6018848

2x
4651903

2x
6036782

7x
4619512

2x
4619524

2x
4649745

1x
6052293

2x
6062386

1x
6035703

1x
4219773

1x
4218499

2x
4143404

2x
4624615

2x
3000240

2x
4113988

1x
6037834

2x
6030980

1x
4609726

1x
4611414

1x
4611414

1x
4611414

1x
4611414

1x
4611414

3x
4113233

1x
4201062

6x
4114324

Customer Service

Kundenservice

Service Consommateurs

Servicio Al Consumidor

LEGO.com/service or dial



: 00800 5346 5555

: 1-800-422-5346



Friends

Heartlake City

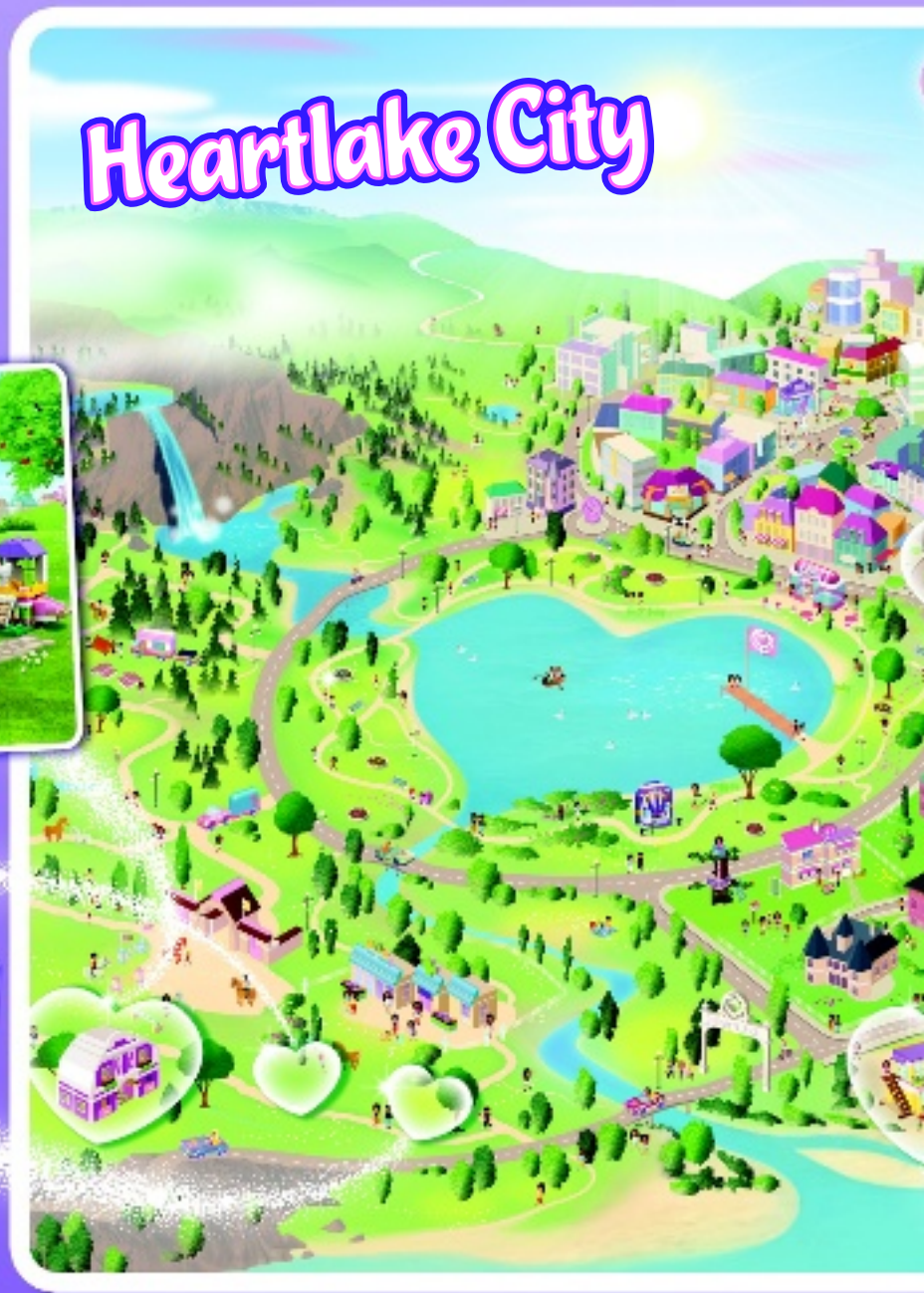



41035



41027



41028



41037





■ 41035



■ 41027



■ 41037



■ 41026



■ 41029



■ 41028



■ 41039

LEGO

Friends



Friends

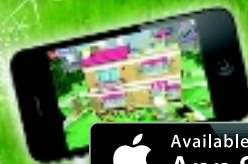

LEGO.com/friends

iPhone, iPad and iPod touch are trademarks of Apple Inc., registered in the U.S. and other countries.
iPad, iPhone et iPod touch sont des marques déposées d'Apple Inc., enregistrées aux États-Unis et dans d'autres pays.
iPhone, iPad e iPod touch son marcas comerciales de Apple Inc., registradas en EE. UU. y otros países.



Friends



NINTENDO 3DS NINTENDO DS

© 2014 The LEGO Group. TM & © WBEL (s14) "3DS", "DS" TM & © 2014 Nintendo. All rights reserved/Tous droits réservés/Todos los derechos reservados.

WB GAMES LOGO, WBIE LOGO, WB SHIELD: TM & © Warner Bros. Entertainment Inc. (s14)





CREATOR

31019



LEGO.com/creator



Win!

Go to LEGO.com/productfeedback to fill out a survey for a chance to win a cool LEGO® Product.

No purchase necessary.
Open to all residents
where not prohibited.



LEGO.com/productfeedback

Gewinne!

Nimm an der Umfrage auf LEGO.com/productfeedback teil und hab die Chance ein cooles LEGO® Produkt zu gewinnen!

Die Teilnahme am Gewinnspiel führt zu keinerlei Kaufverpflichtungen. Teilnahme in allen nicht ausgeschlossenen Ländern möglich.

Win!

Ga naar LEGO.com/productfeedback, vul een enquêteformulier in en maak kans op een cool LEGO® product.

Geen aankoopverplichting. Ledereen mag deelnemen, uitgezonderd ingezetenden van landen waar een enquêteverbod geldt.

Gagne!

Visite LEGO.com/productfeedback pour répondre à un questionnaire et avoir une chance de gagner un produit LEGO® très cool!

Aucune obligation d'achat. Ouvert à tous les résidents des pays autorisés.

当てよう!

LEGO.com/productfeedbackにアクセスして、アンケートにご記入ください。当選者にはレゴ®製品を差し上げます。

お買い上げの必要はありません。

禁止されていない限り、すべての皆様にご利用いただけます。

 LEGO.com

6073877 / 6073878

LEGO and the LEGO logo are trademarks of the/sont des marques de commerce de/son marcas registradas de LEGO Group. ©2014 The LEGO Group.