



Friends



41058



LEGO.com/friends



WARNING: CHOKING HAZARD.
Toy contains small parts and a small ball.
Not for children under 3 years.

1



2



3



4

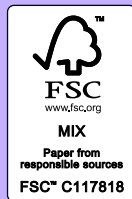

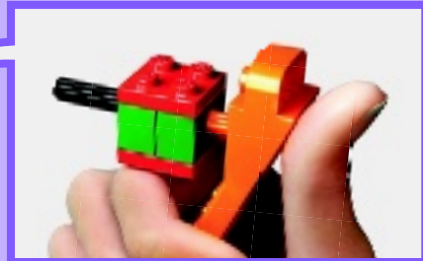
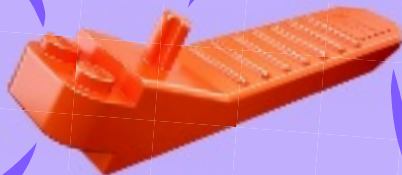
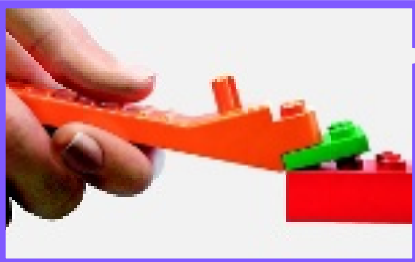

LEGO.com/brickseparator



AVERTISSEMENT : RISQUE D'ÉTOUFFEMENT.
Le jouet contient des petites pièces ainsi qu'une petite boule.
Il ne convient pas aux enfants de moins de 3 ans.



ADVERTENCIA: PELIGRO DE ASFIXIA.
Juguete que contiene partes pequeñas y una pelota pequeña.
No recomendado para niños menores de 3 años.





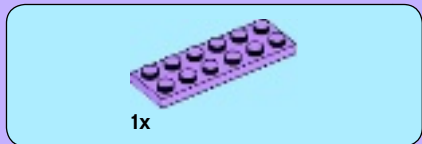

1

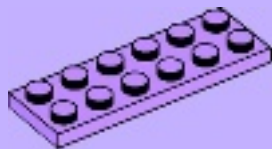

2

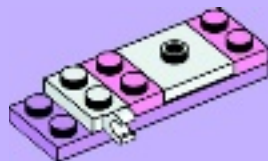



2x

3

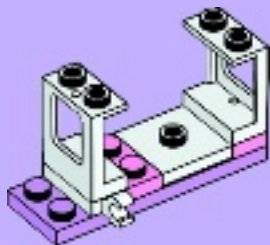

1x



1x

4

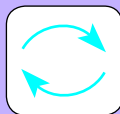



2x



2x

5

1



2

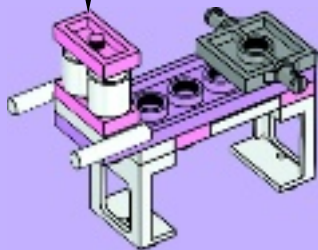

8



2x

6

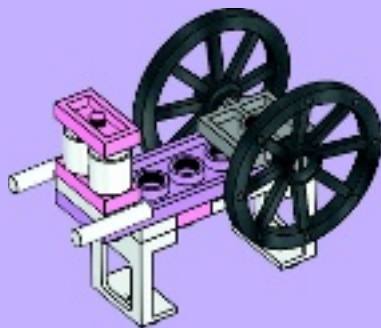



1x



1x



1x

7

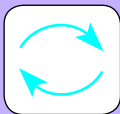

1x

1

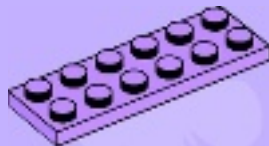



2

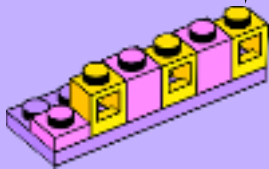

3

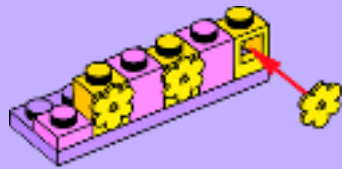



1x



1x



1x



1x

4

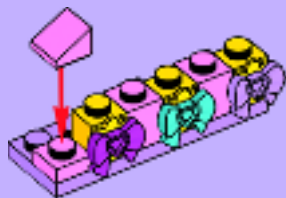

8

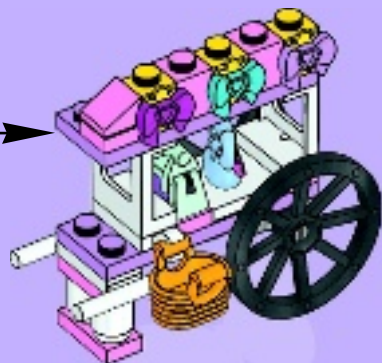

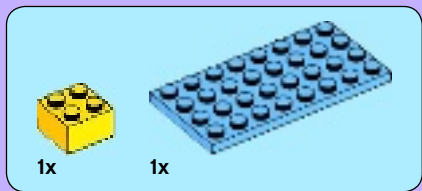

1



2

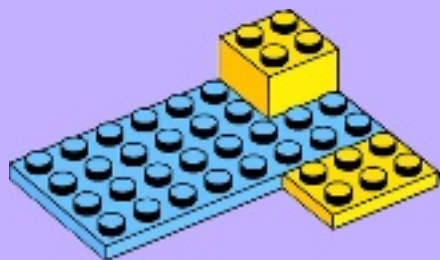



2x

3

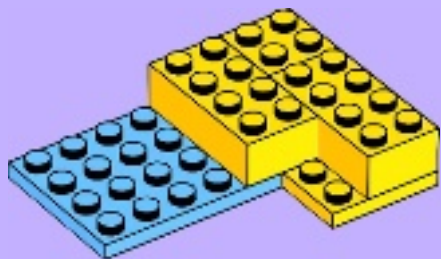

1x

4

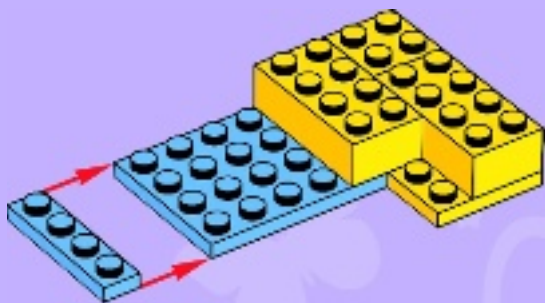

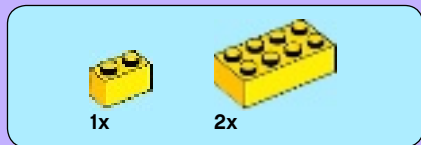

5

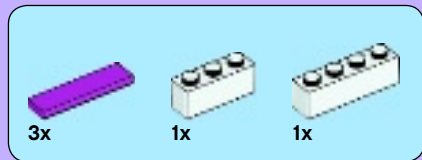
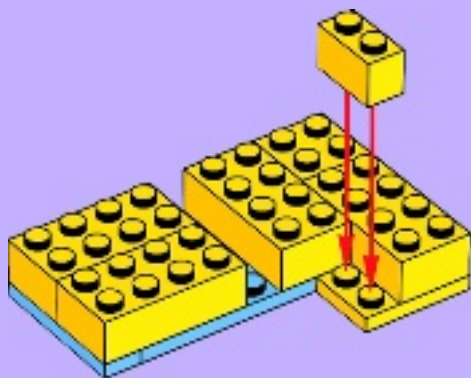

6

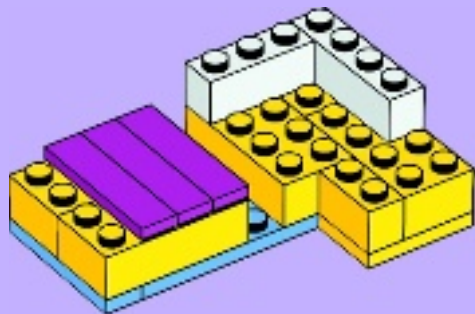



1x



1x



1x

7

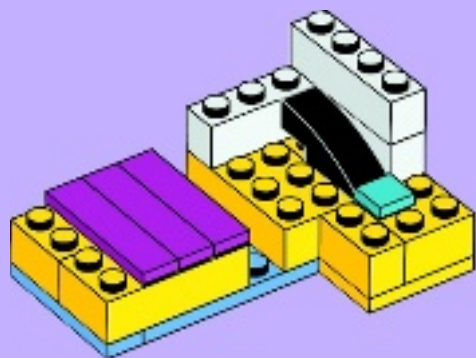

1x



2x

8

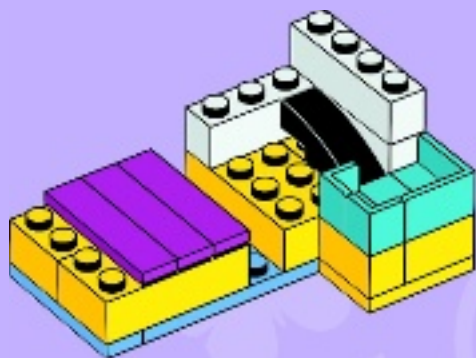



1x



1x

9

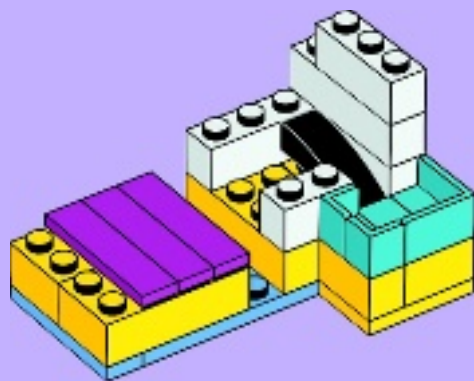



10

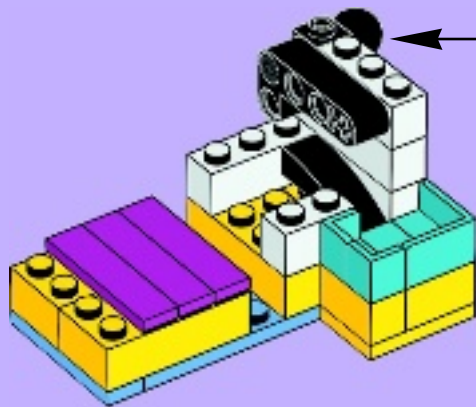
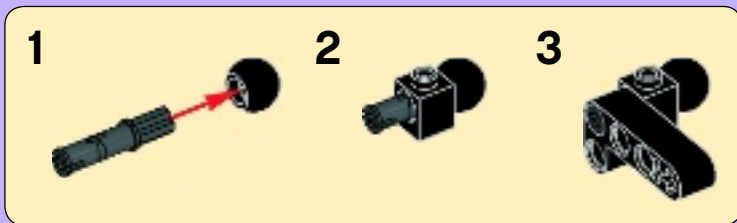



11

1



2

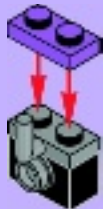

3



4



5





1x



1x

12

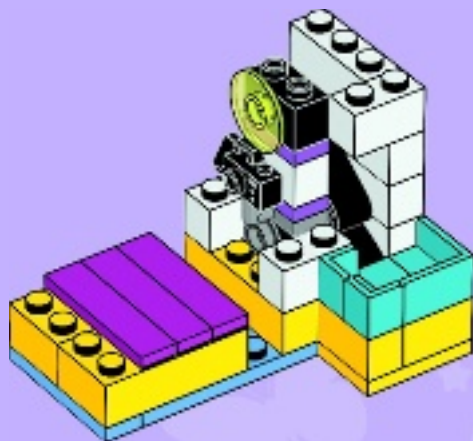
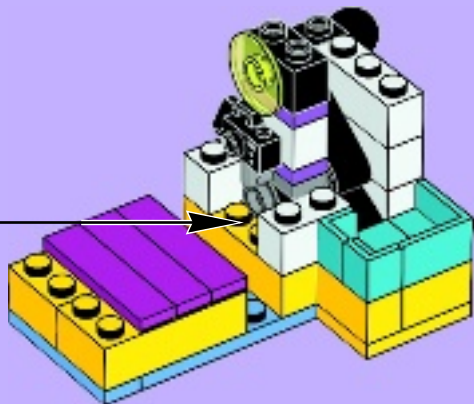



13

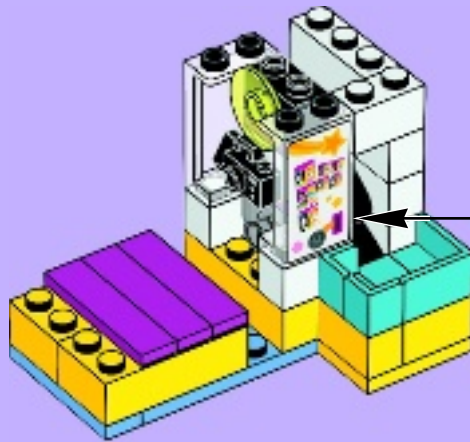

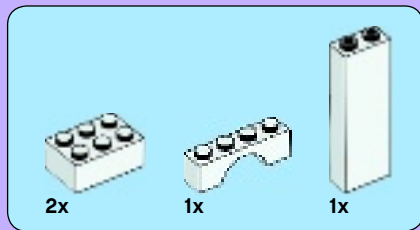

14

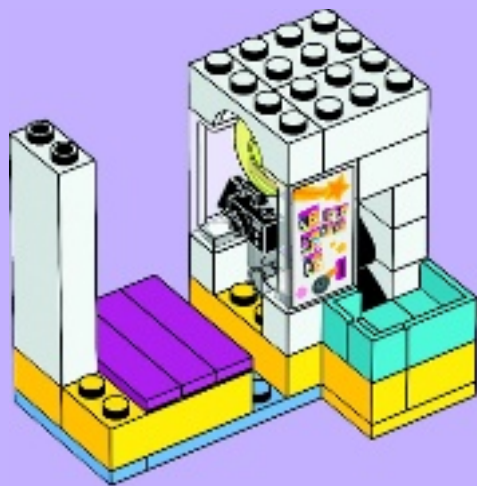

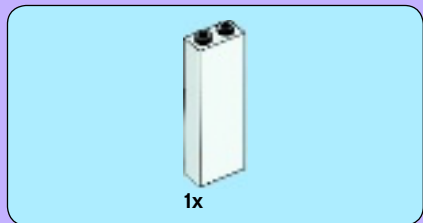

15

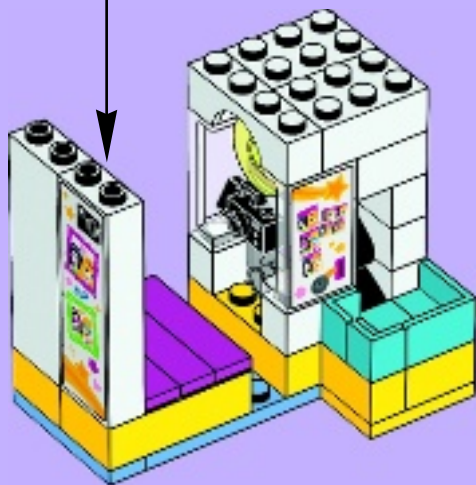
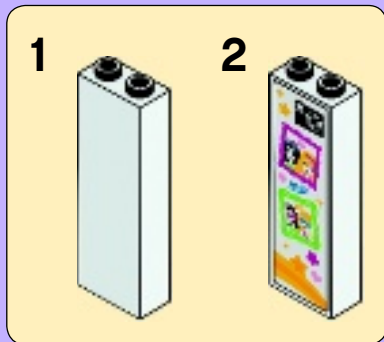



1x



2x

16



1x



2x

17





1x

18

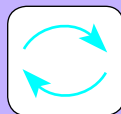
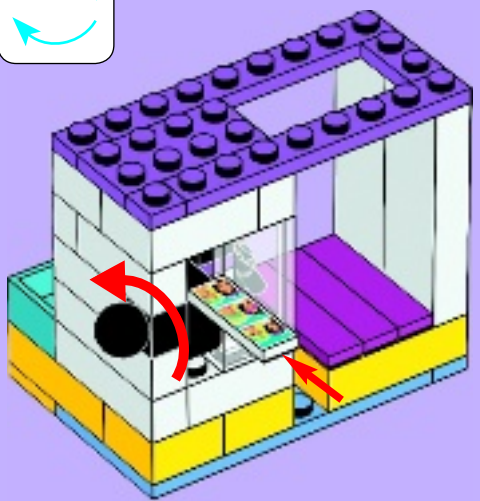
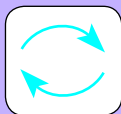

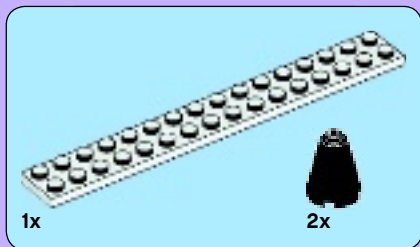

1

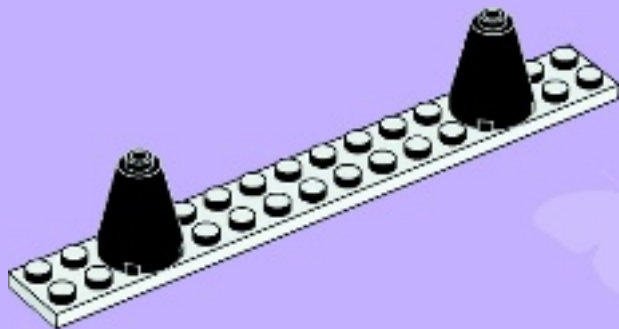



2

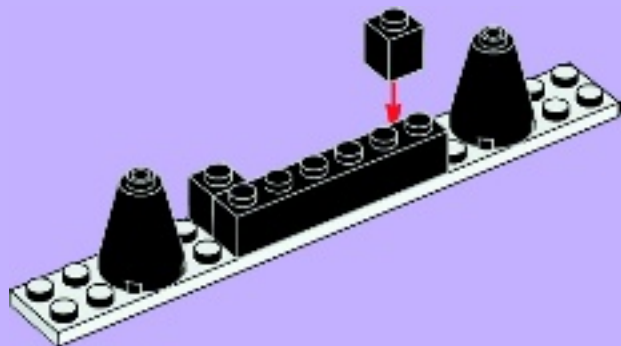

3

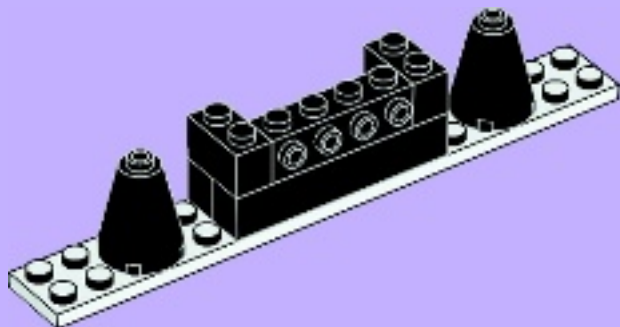

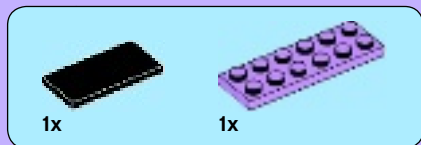

4

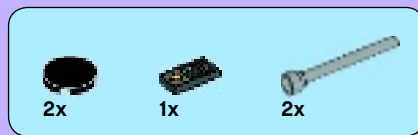
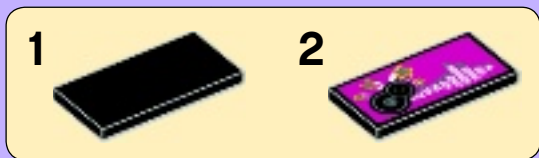

5



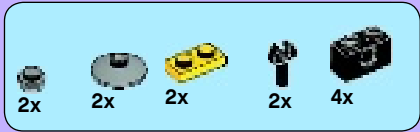

6

1



2



3



4



2x

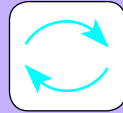



1x

7

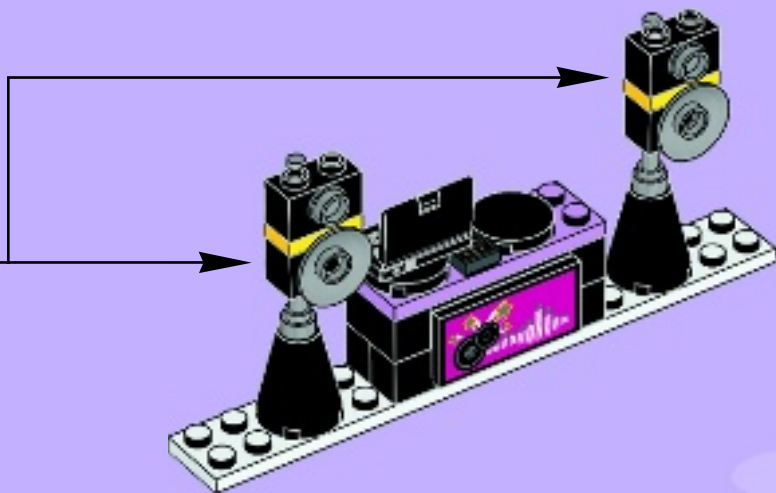

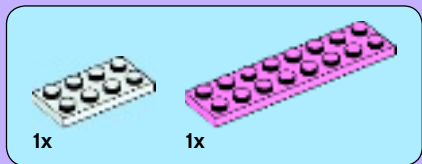

1

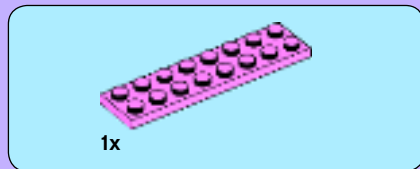
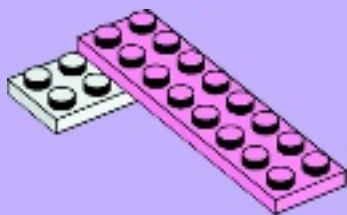

2

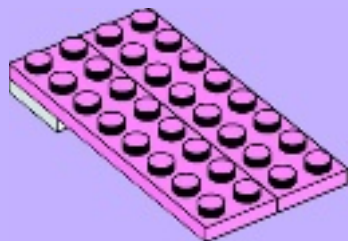



3

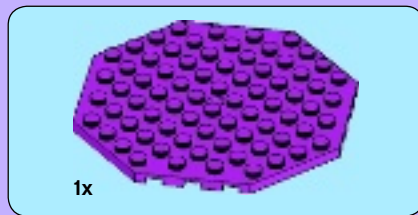
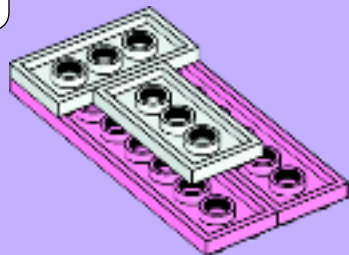
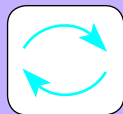

4

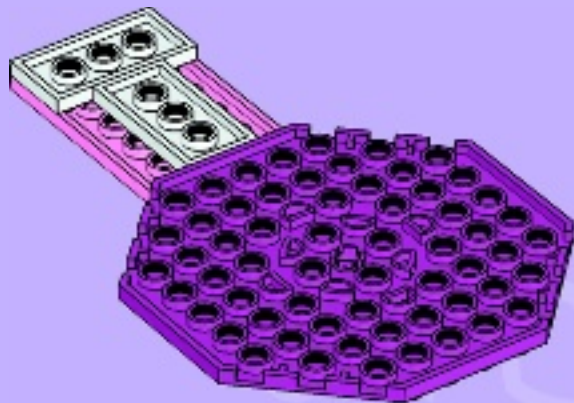

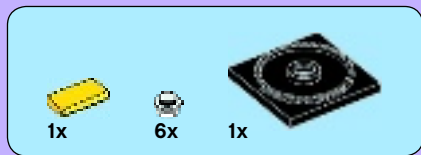

5

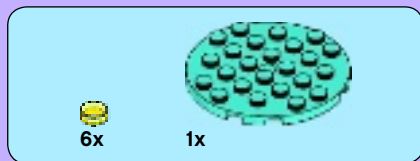
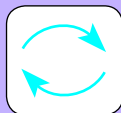

6

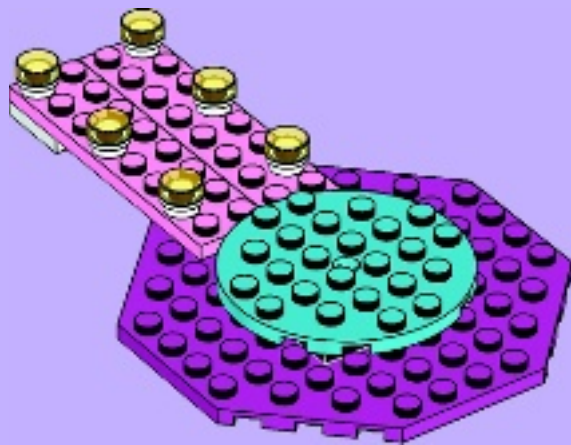

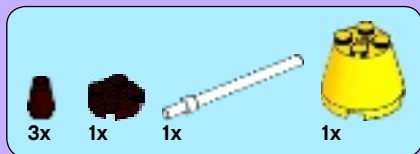

1



2



3





2

1



2



3



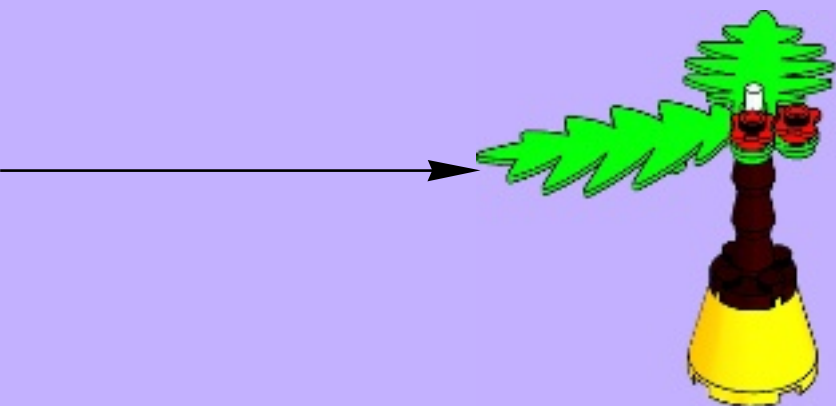

2x





1x



1x

1

1

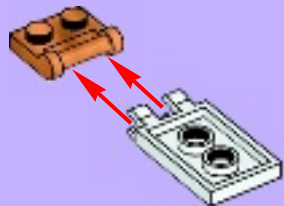

2



1x



1x

2

1

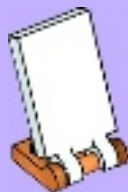

2



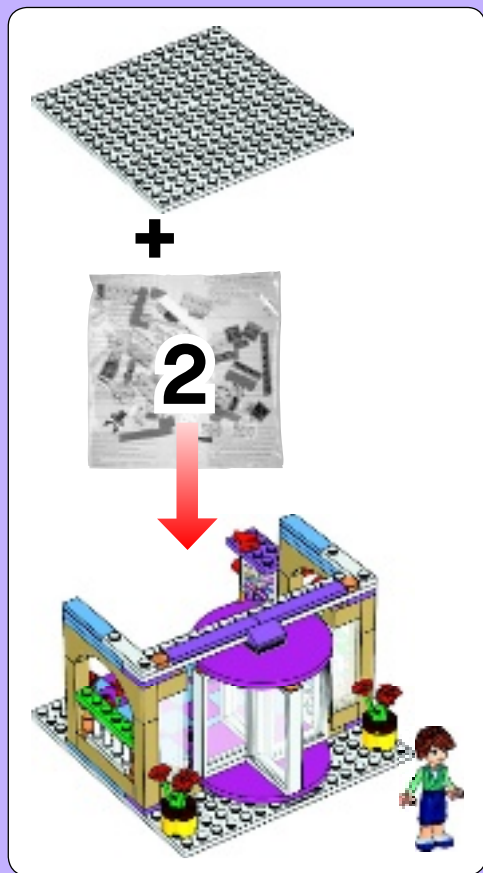



1x

1

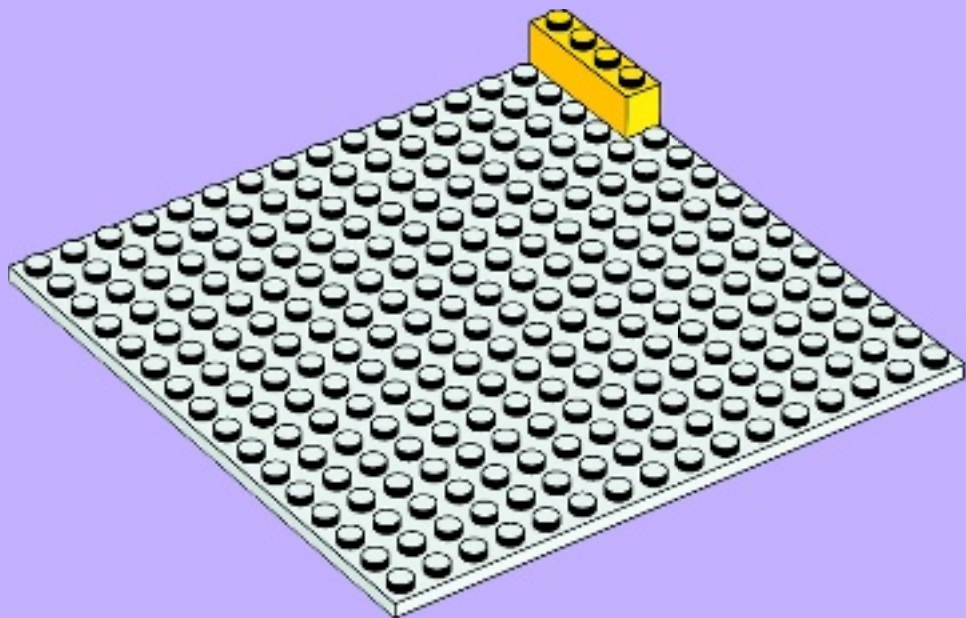



2

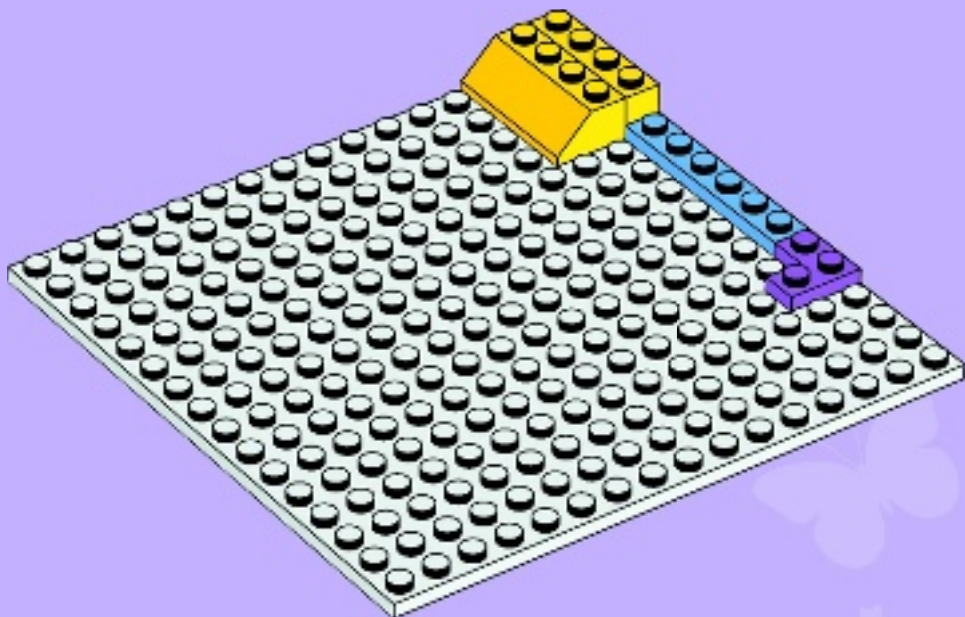



3x



2x



1x

3

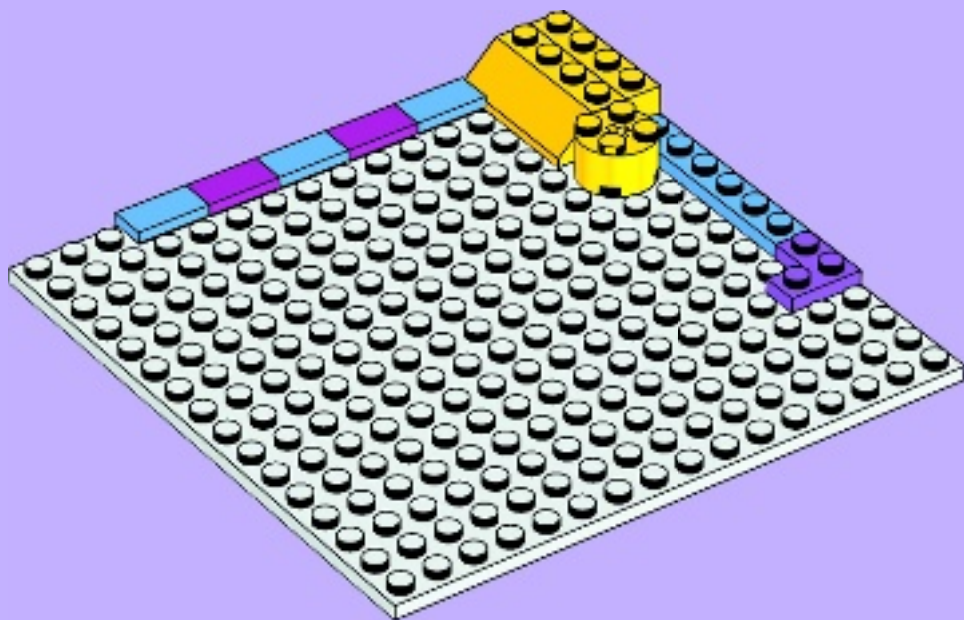



10x



10x

4

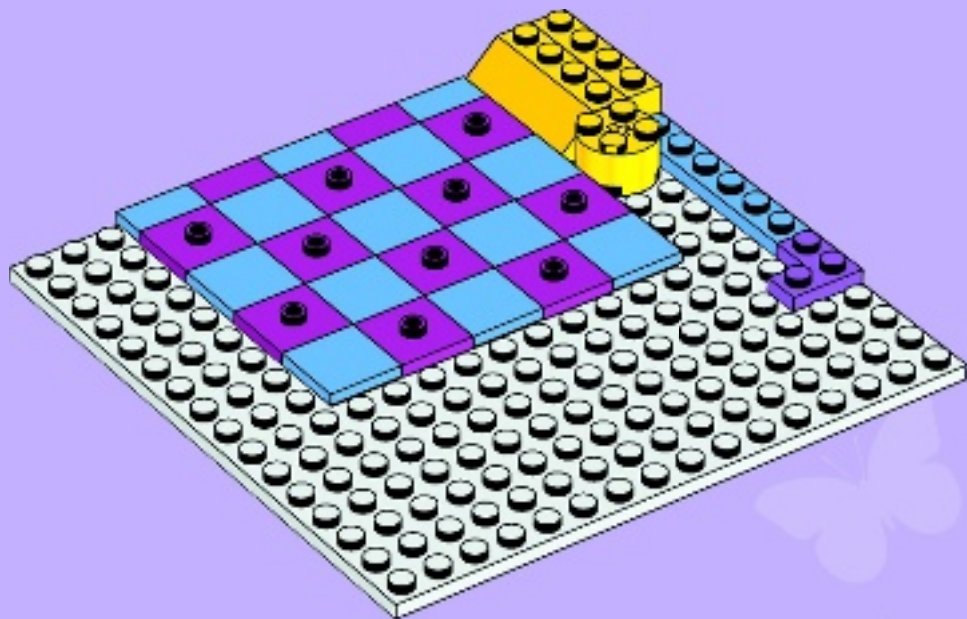

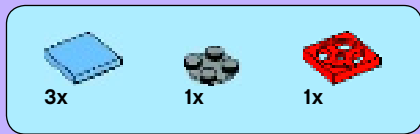

5

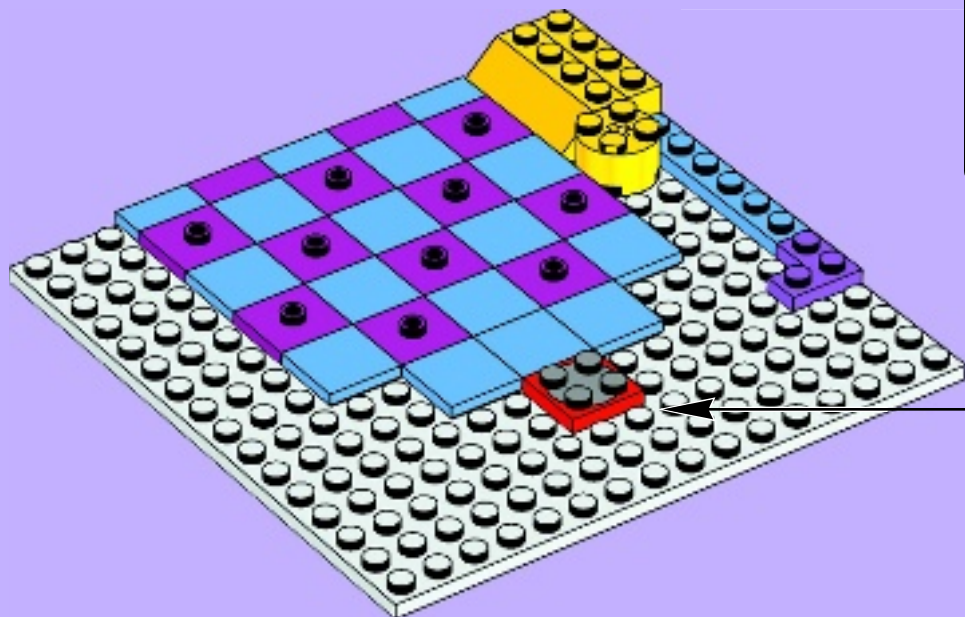

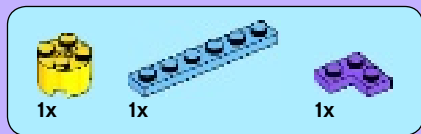

7

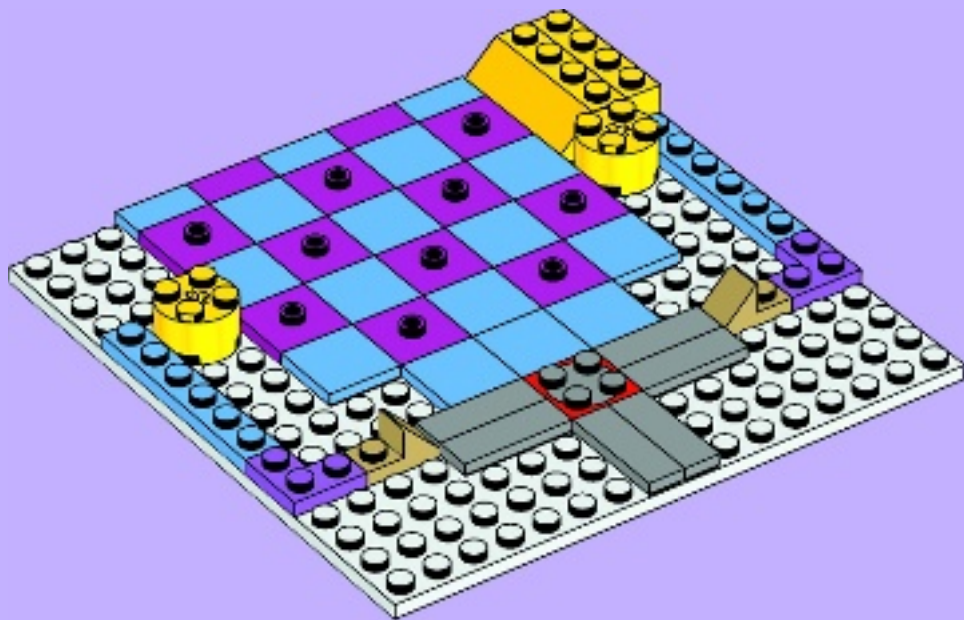



2x



1x

8

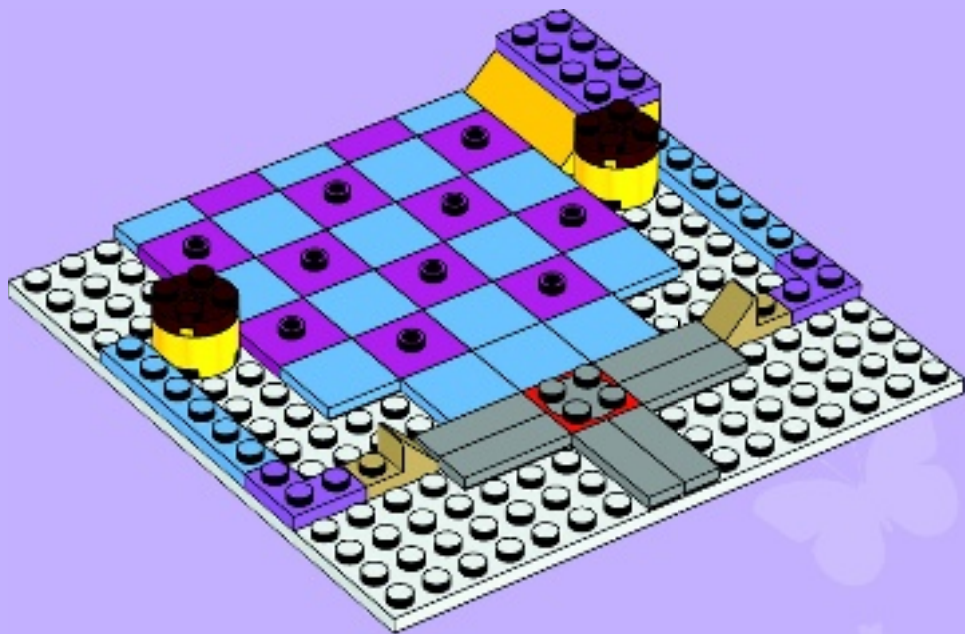



9

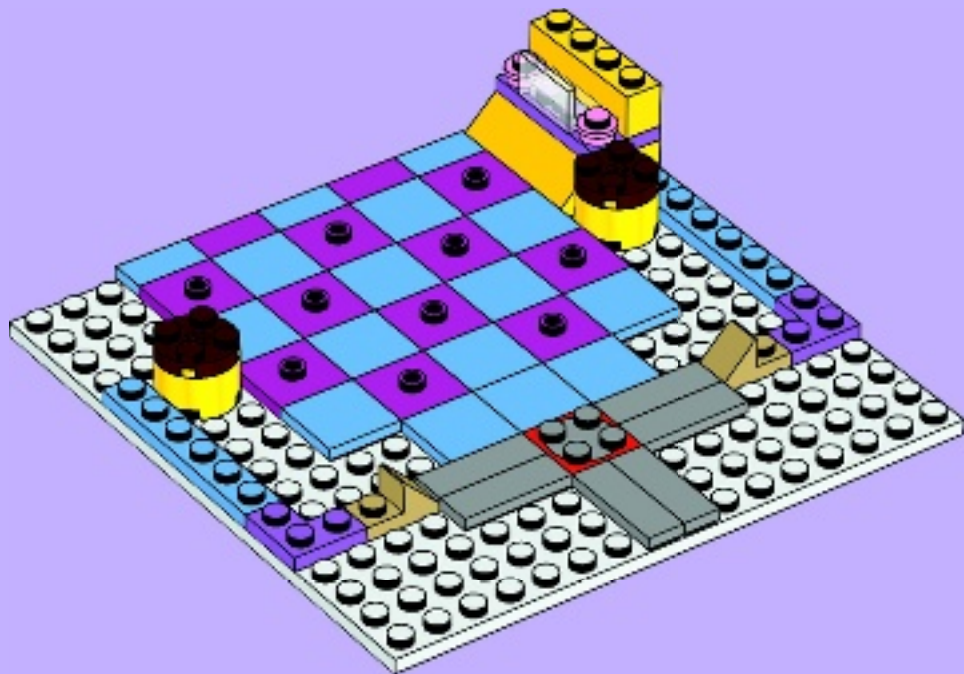

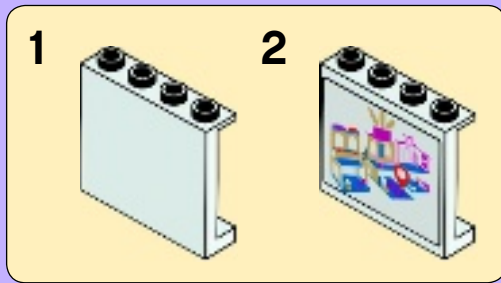
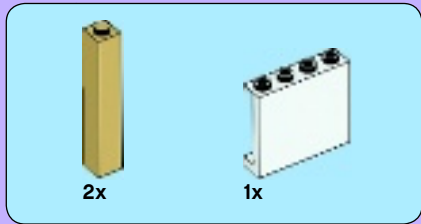

10



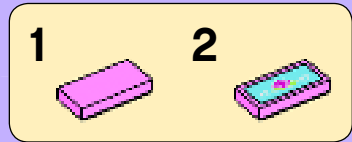
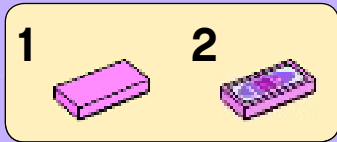
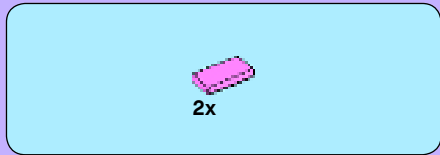

11

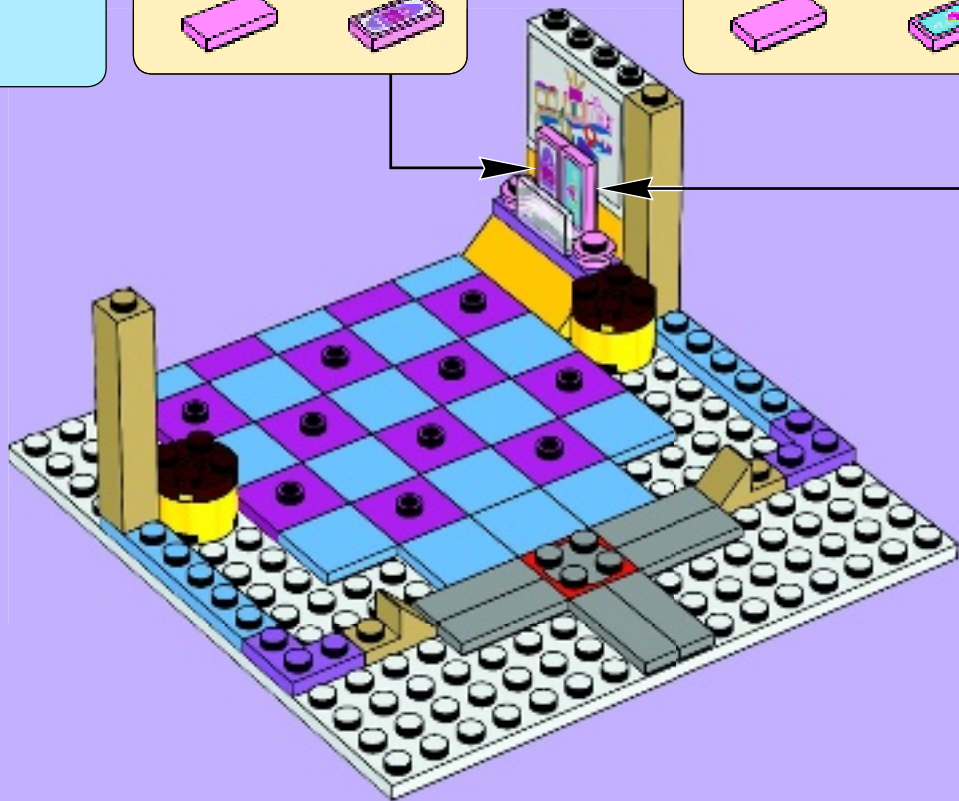

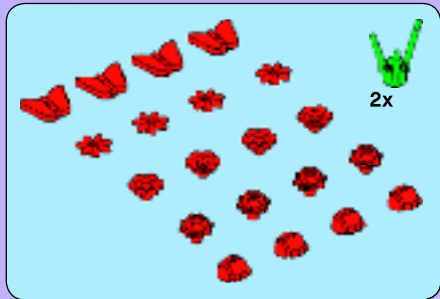

12

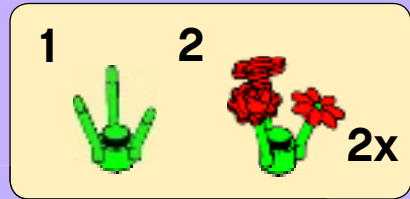

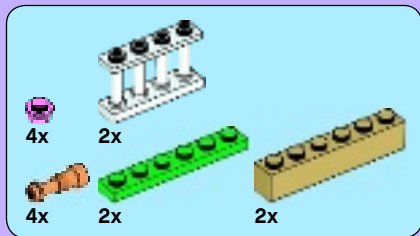

13

1

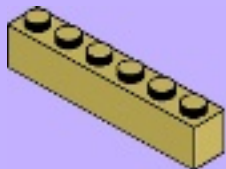

2



3



4



2x

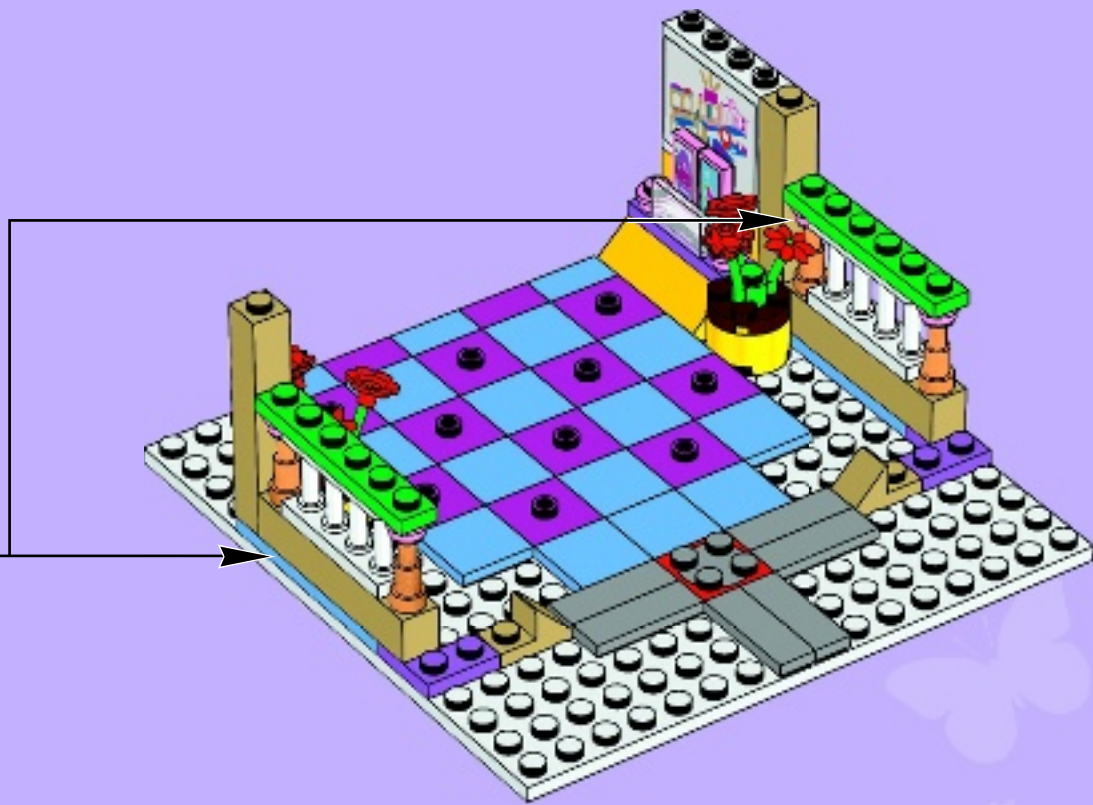

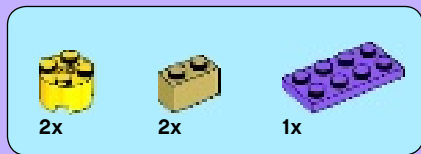

14





15



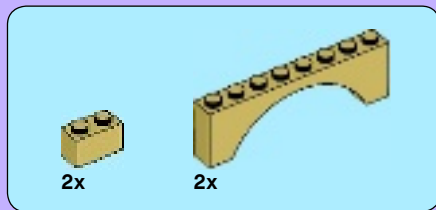

16





17

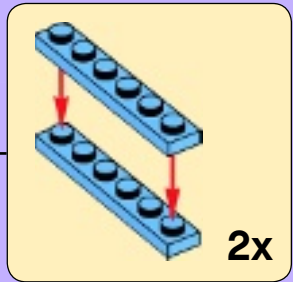
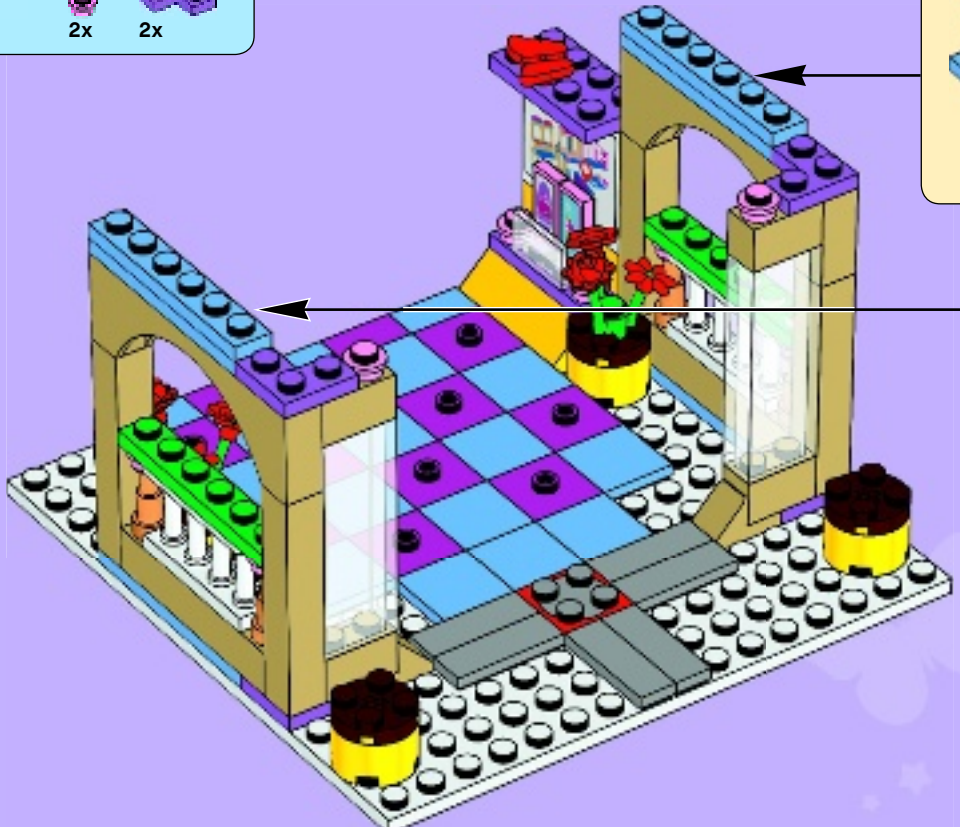



1



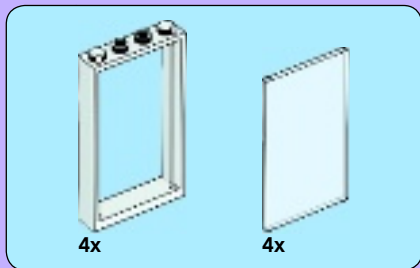

2

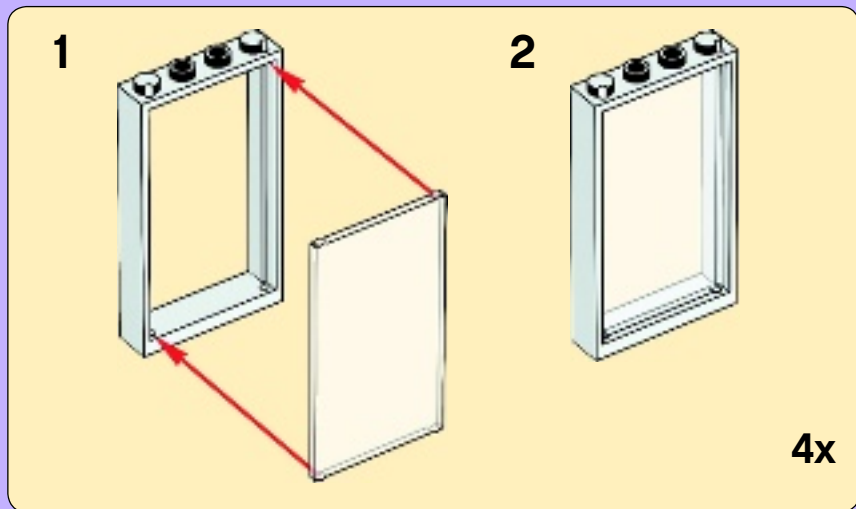

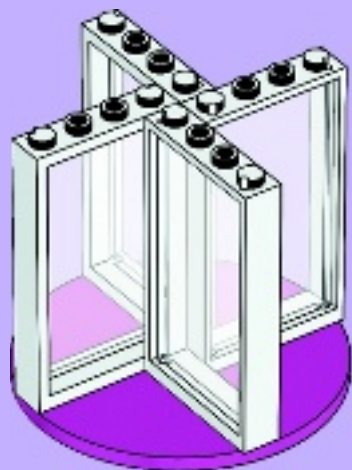

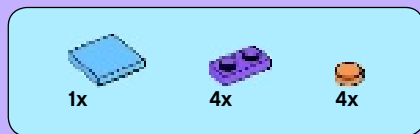

3



4





1x



1x

5



1x

6



18

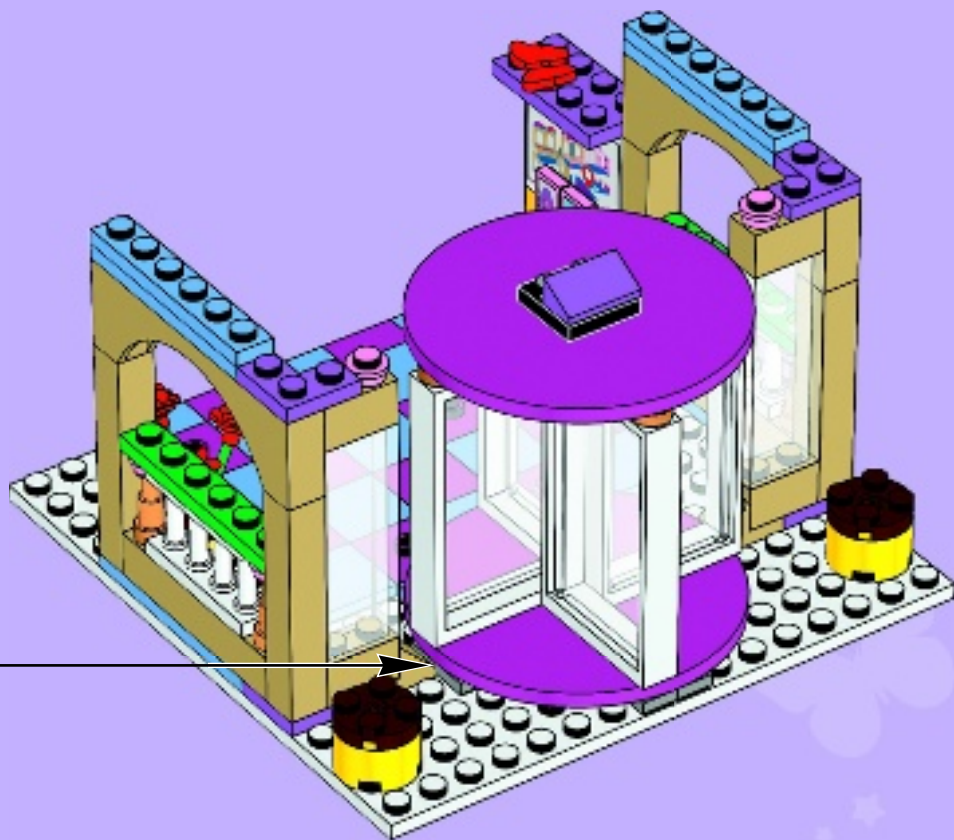

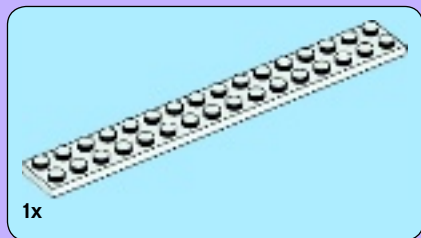

19



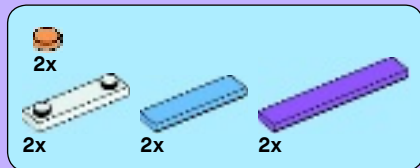

20





2x

21

1



2



2x

