



Friends



41105



WARNING: CHOKING HAZARD.
Toy contains small parts and a small ball.
Not for children under 3 years.

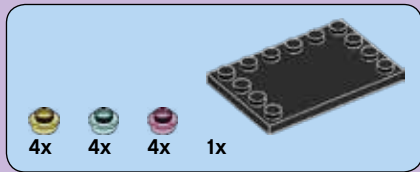

41

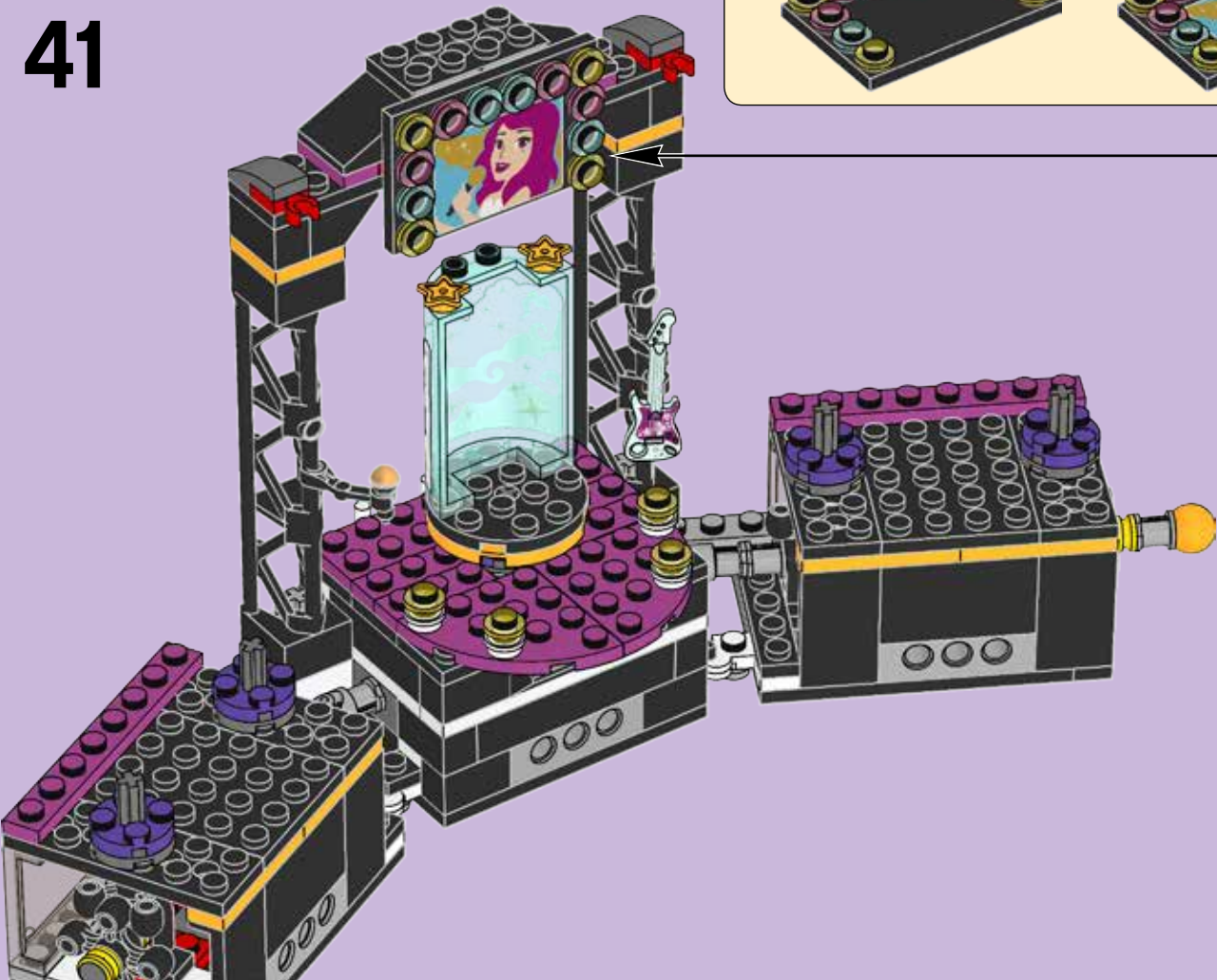
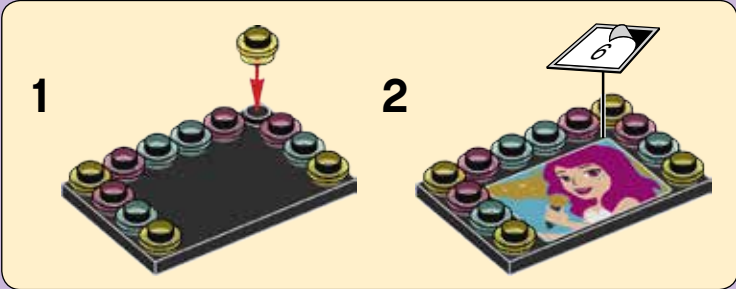



42

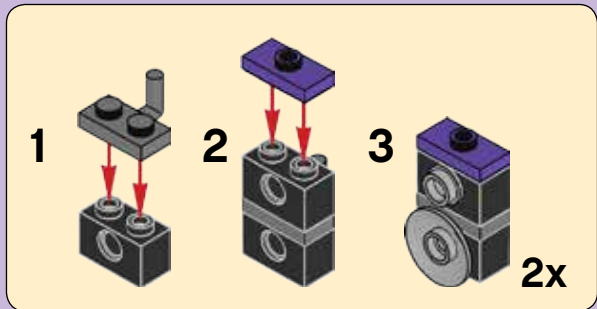
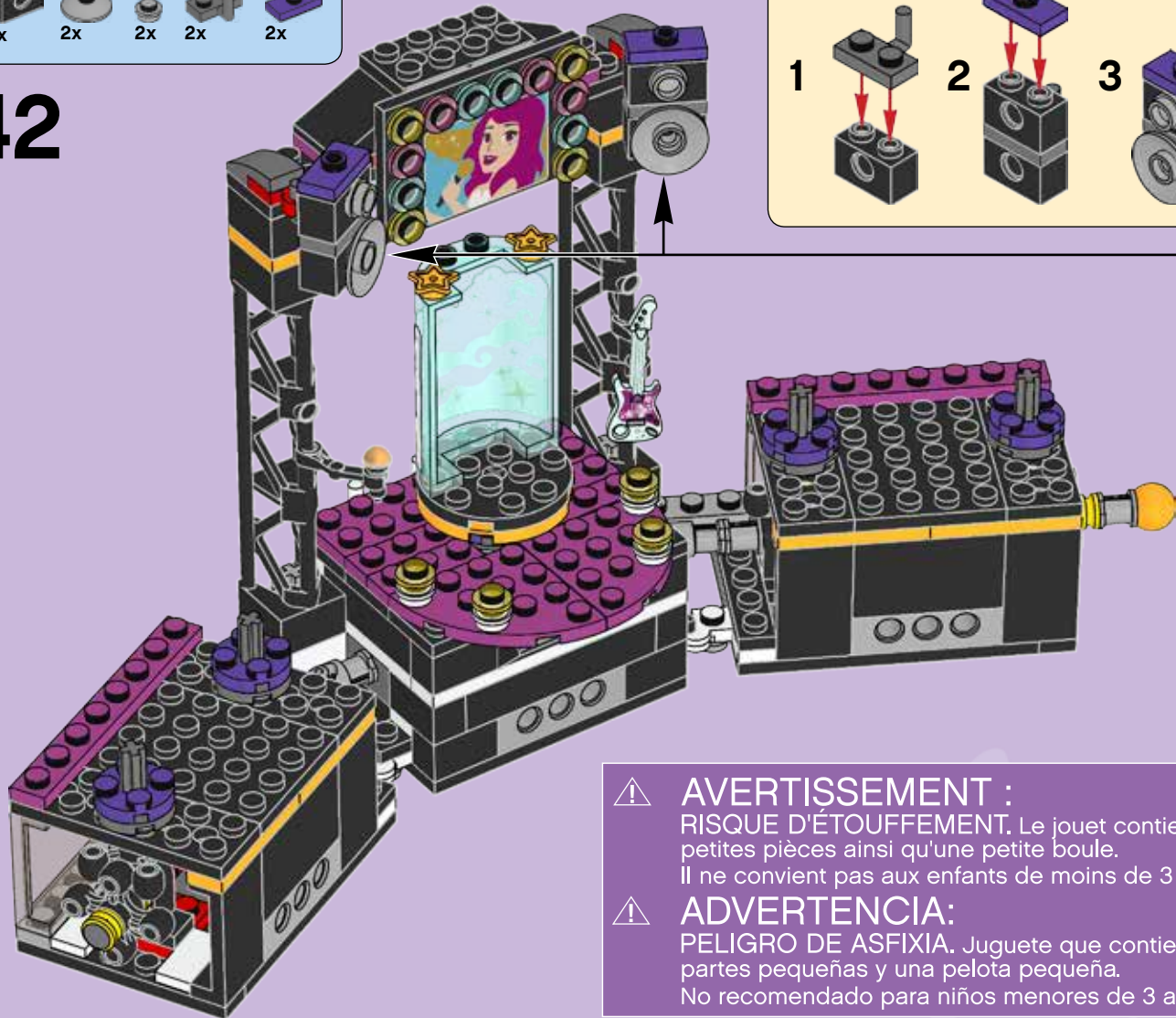

⚠ **AVERTISSEMENT :**
 RISQUE D'ÉTOUFFEMENT. Le jouet contient des petites pièces ainsi qu'une petite boule. Il ne convient pas aux enfants de moins de 3 ans.

⚠ **ADVERTENCIA:**
 PELIGRO DE ASFIXIA. Juguete que contiene partes pequeñas y una pelota pequeña. No recomendado para niños menores de 3 años.



2x



2x



2x



4x



2x



2x



2x

43

1



2



1



2



3



4



2x



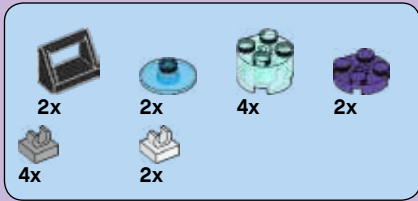

44

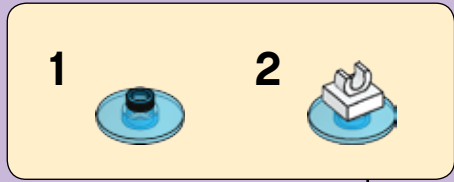
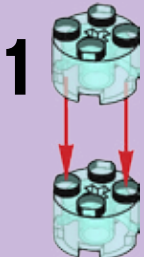

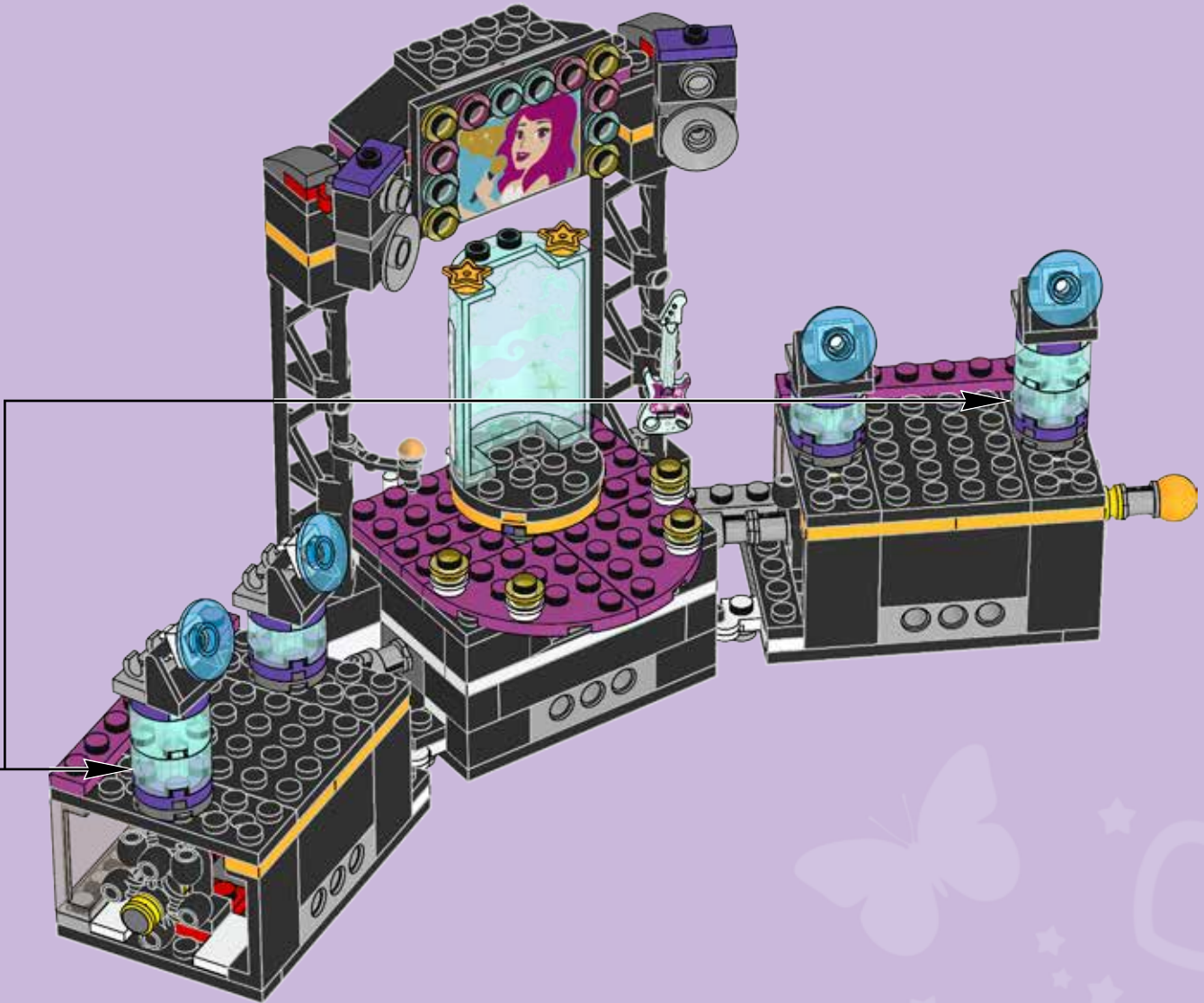

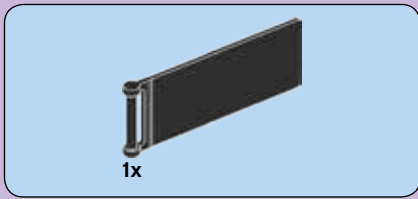

45

1

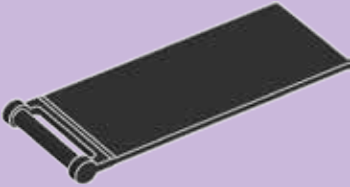

2

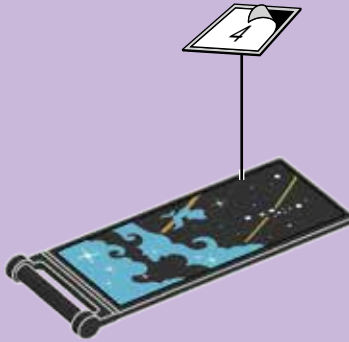

3

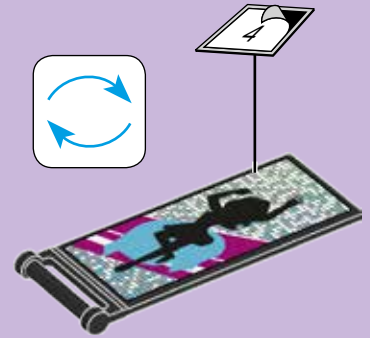
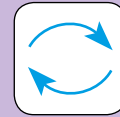

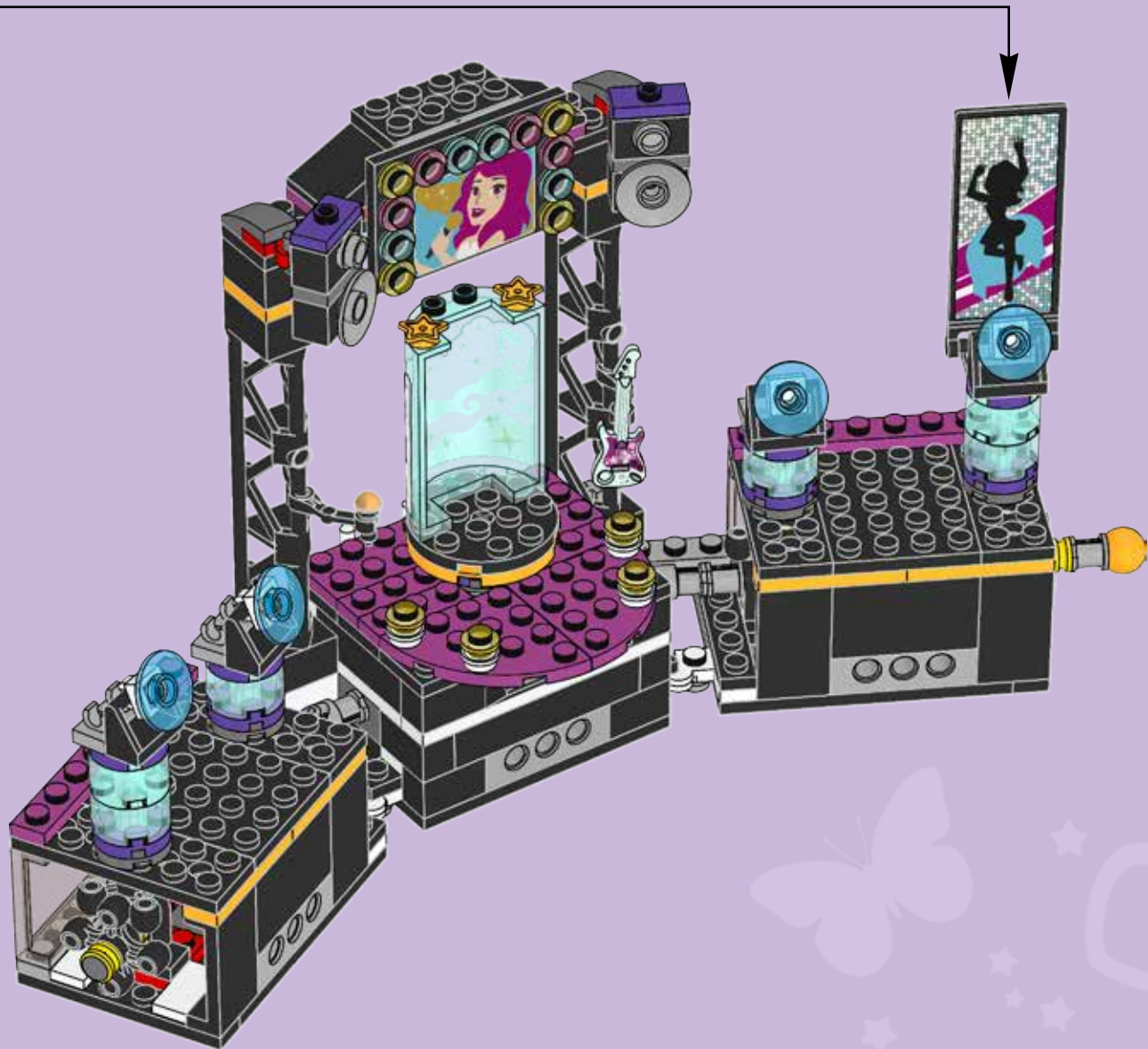

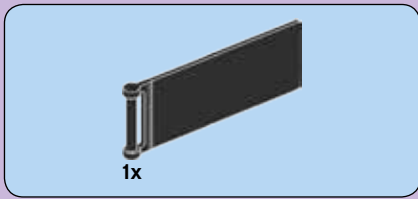

46

1

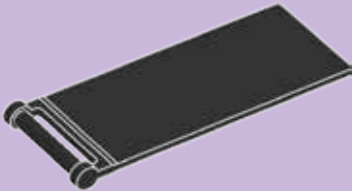

2

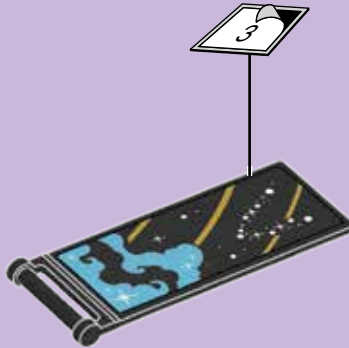

3

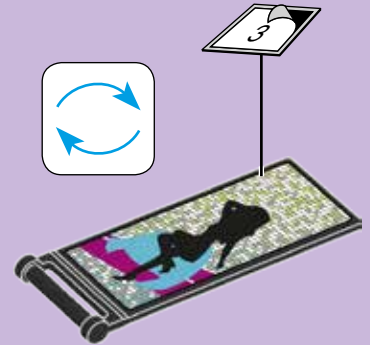
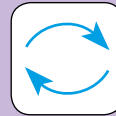



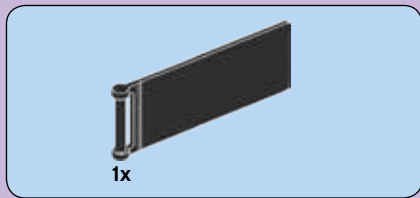

47

1

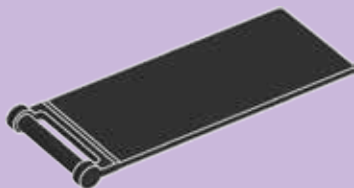

2

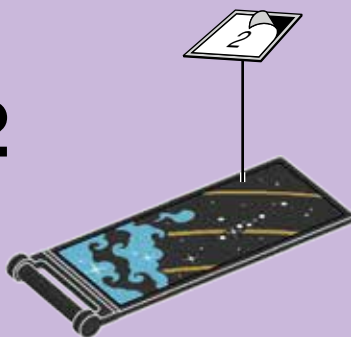

3

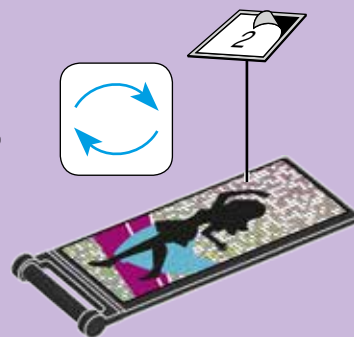



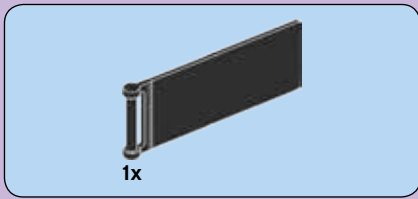

48

1

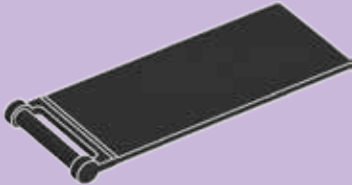

2

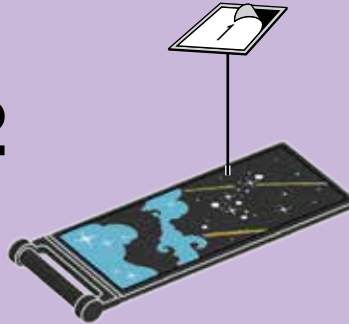

3

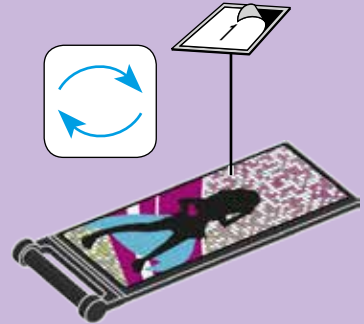



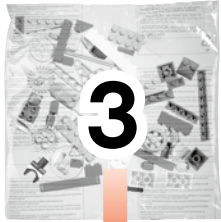

2x



1x

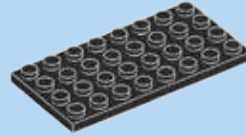

1x

1

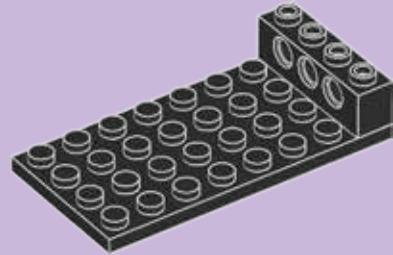

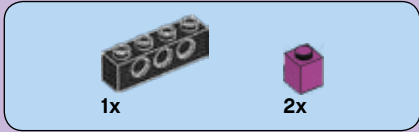

2

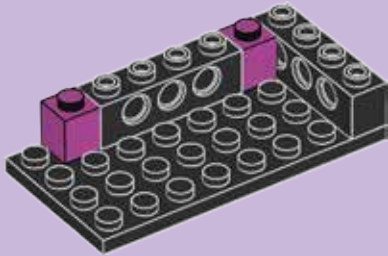

3



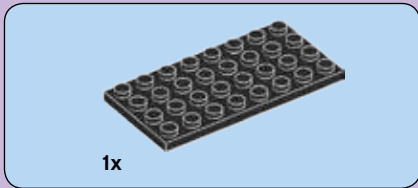

4

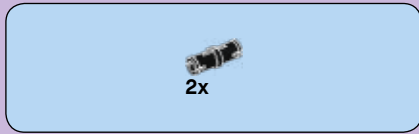
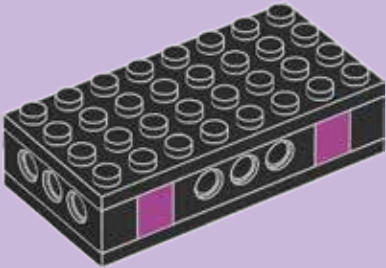

5

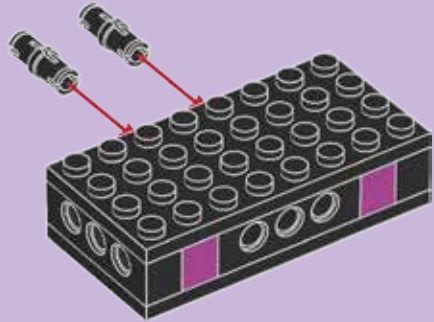



4x

6

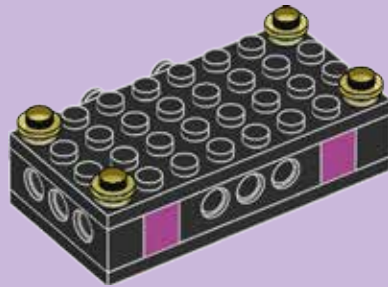

2x

49

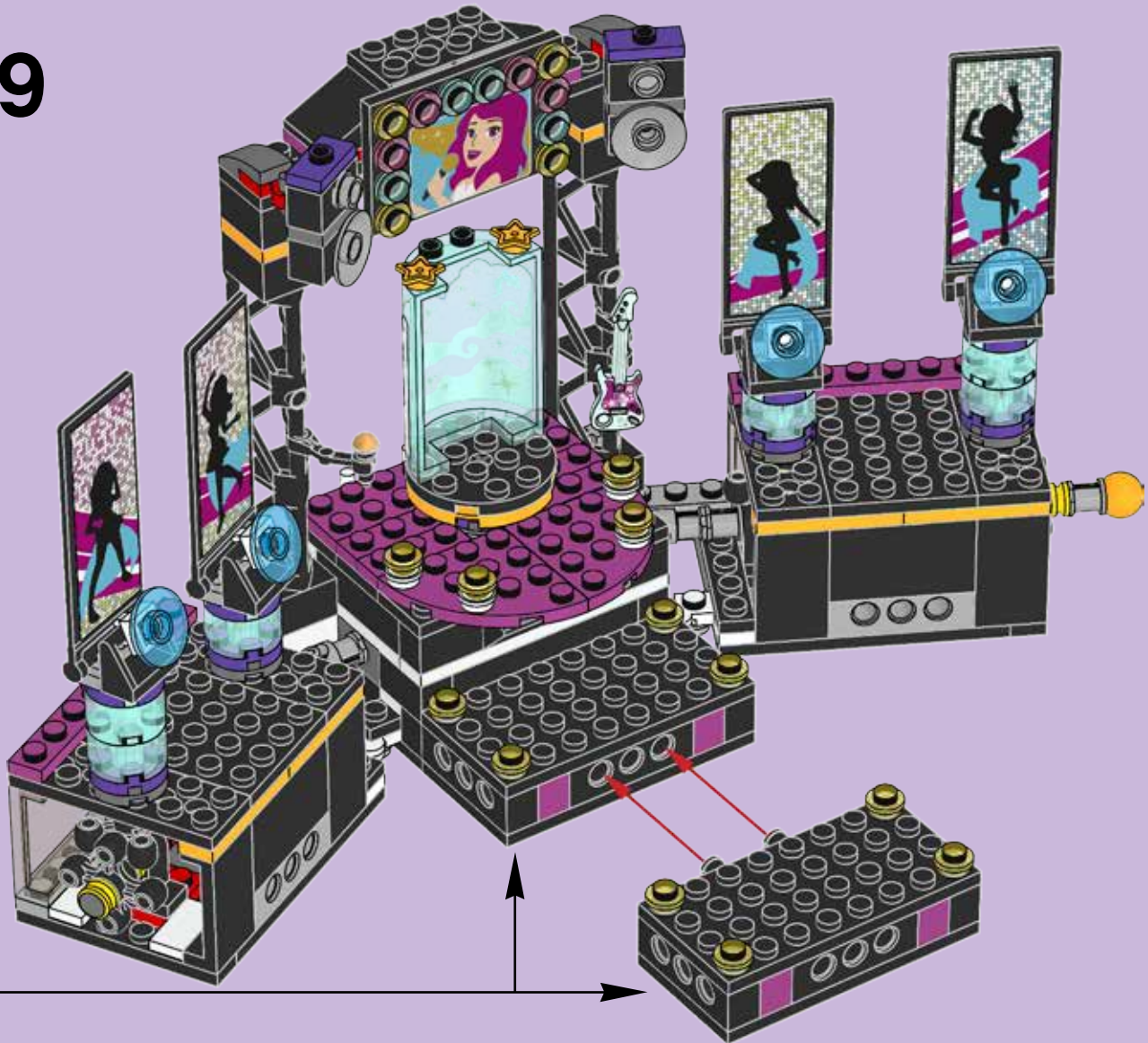

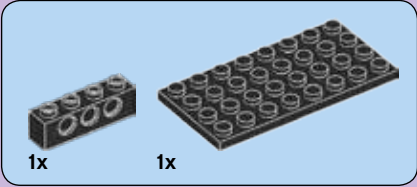

1

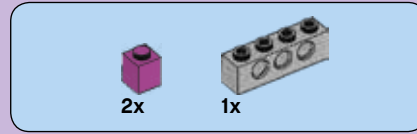
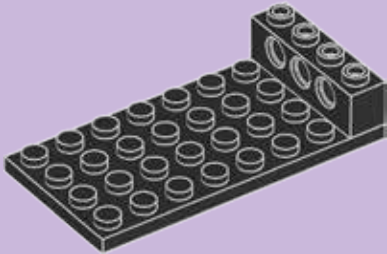

2





3

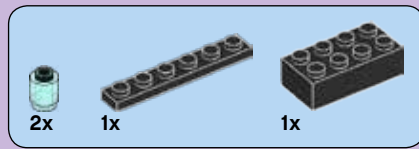
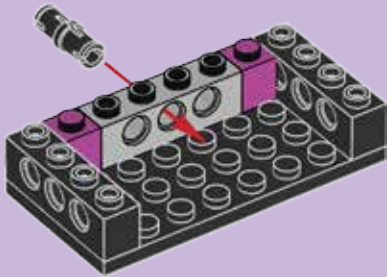

4

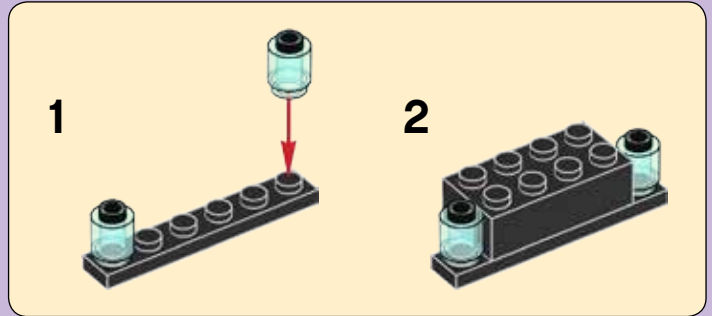

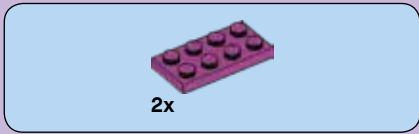

5

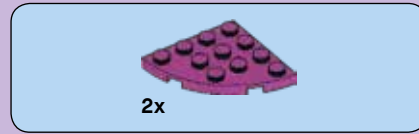
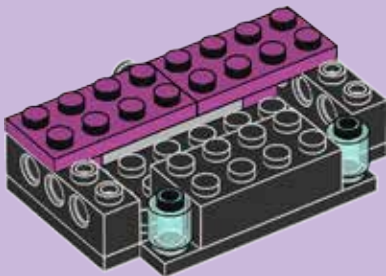

6





7

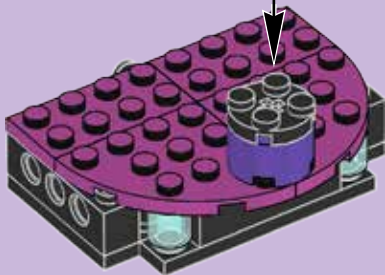
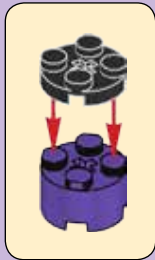

8

1

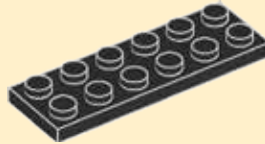

2

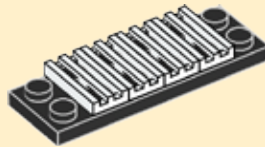

3

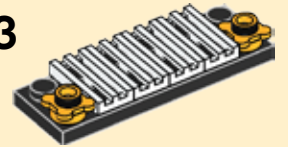

4

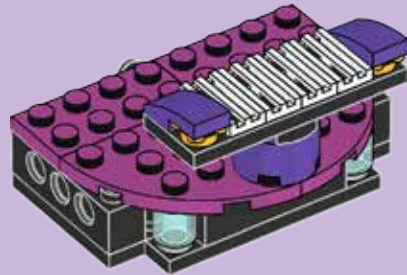
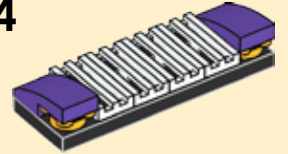

50



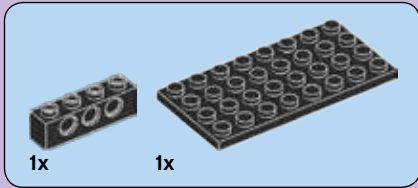

1

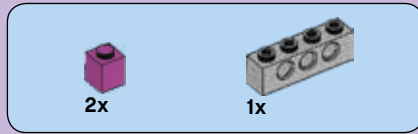
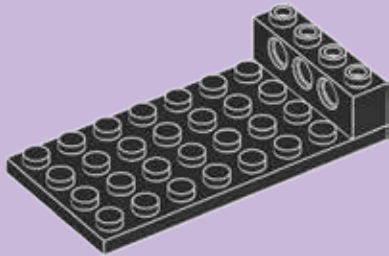

2



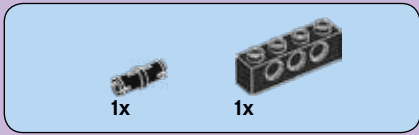

3

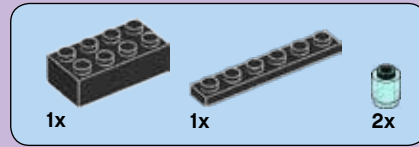
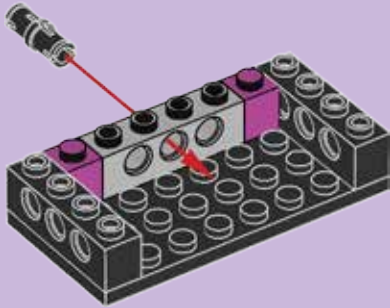

4

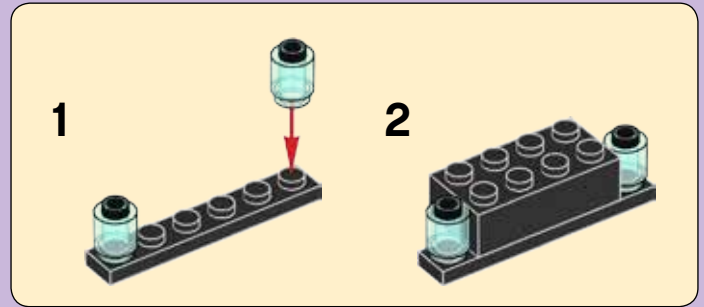



2x

5

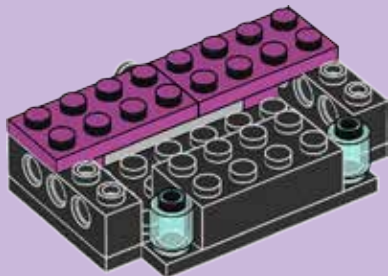

2x

6





7

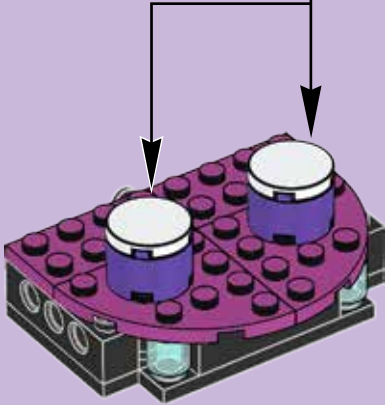
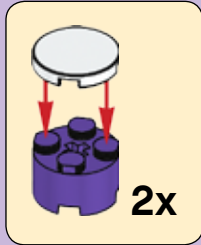

8

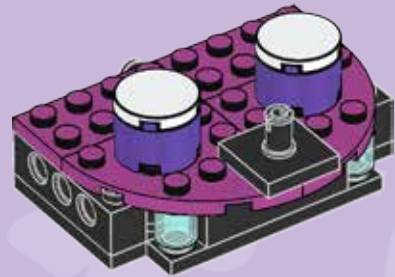

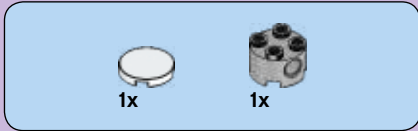

9

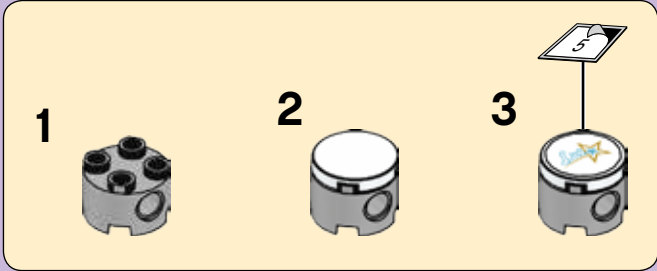



10

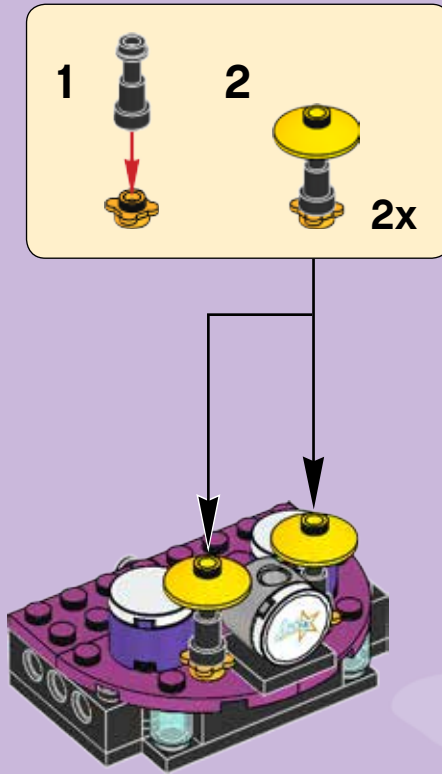

51



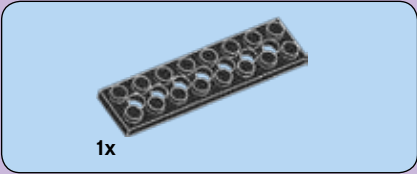

1

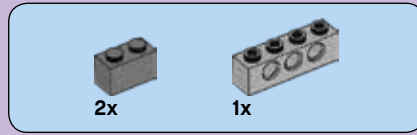
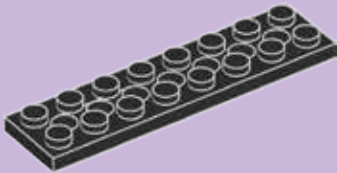

2

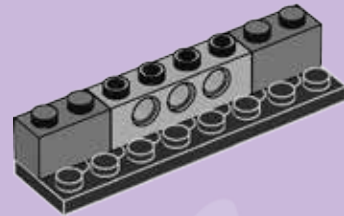

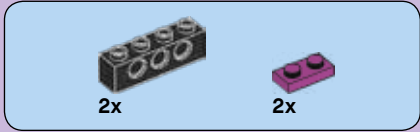

3

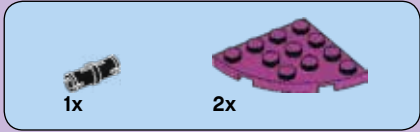
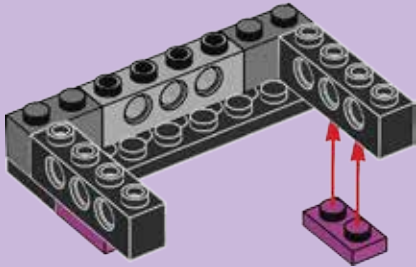

4

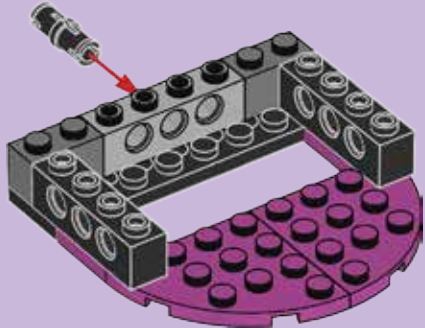



5



6

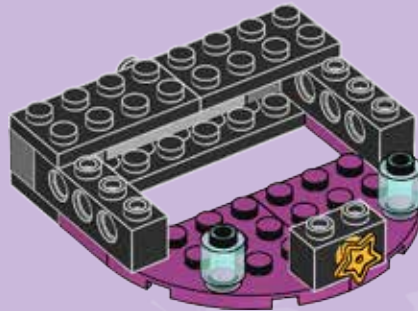

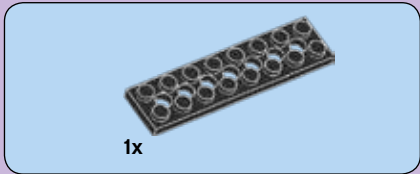

1x

1

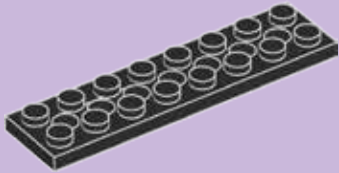

3x

2

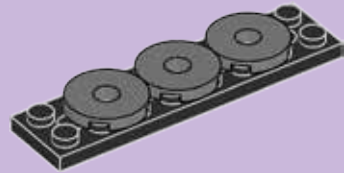



3

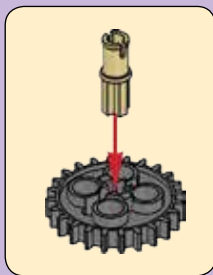
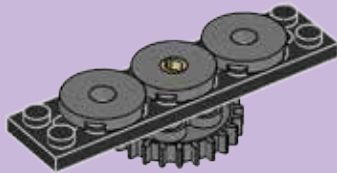

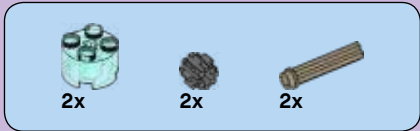

4

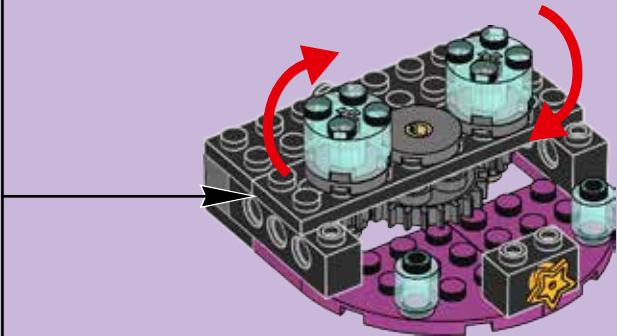
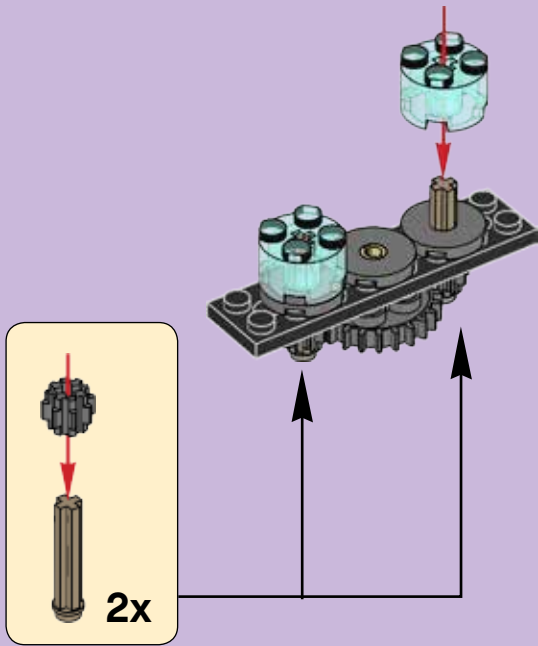

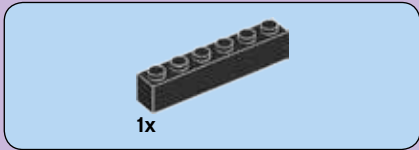

5

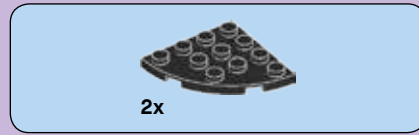

6

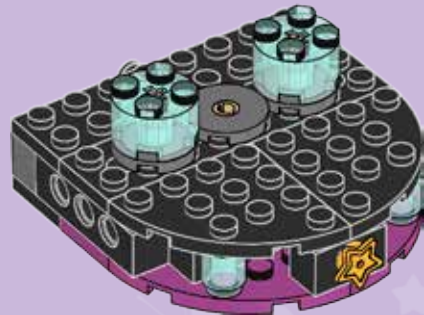



5x



1x

7



2x



2x



1x

8

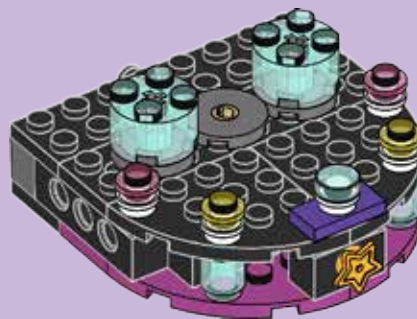

52





1

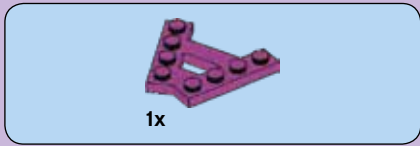
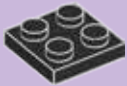

2

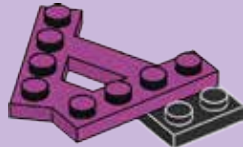

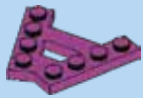

1x

3

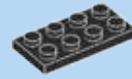
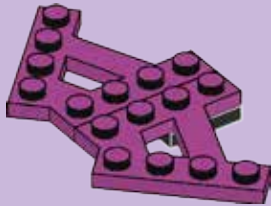

2x

4

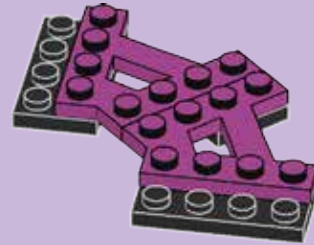

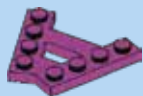

2x

5

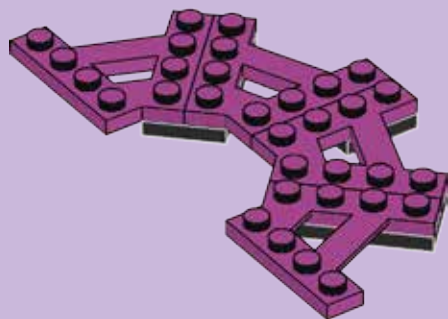

3x



3x

6

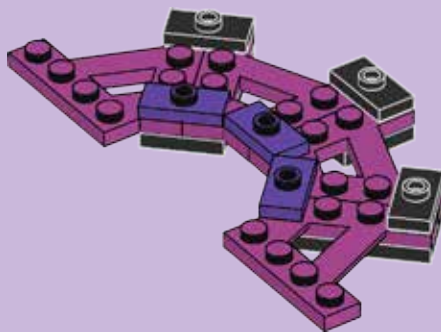



7

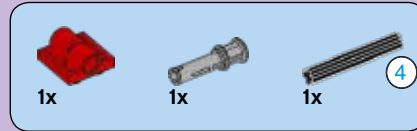
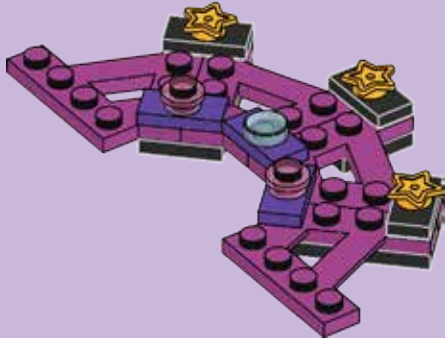

8

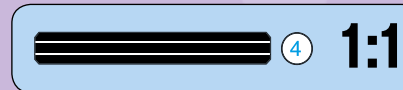
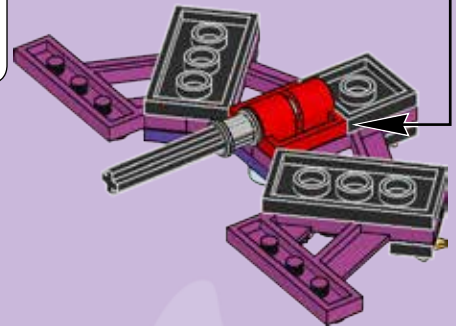
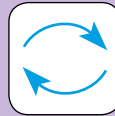
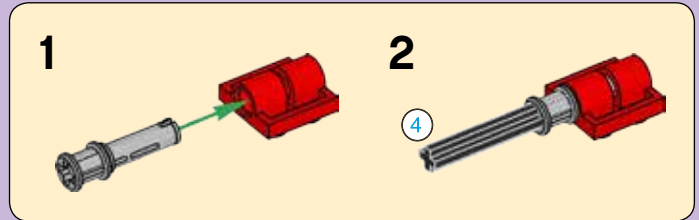

53





2x

54













6x
4183544

8x
4178398

2x
6022171

4x
4163917

1x
4639346

2x
6031821

18x
3005744

8x
4599535

12x
6022035

5x
6103415

4x
6022048

6x
6037658

2x
6109929

4x
6097522

8x
6109934

6x
6017001

1x
6071608

2x
6003033

4x
6020073

1x
6115115

4x
4624184

3x
4211622

1x
6078985

6x
4211441

4x
4211429

4x
4211395

2x
4211425

8x
6071229

2x
4654580

6x
4211525

2x
4211512

1x
4211567

3x
4211815

1x
4211865

2x
4525904

2x
4211088

4x
4211111

2x
6029948

2x
4211043

1x
4211065

2x
4611703

8x
6055313

2x
4551044

6x
6083620

2x
6012451

1x
4514558

4x
4570398

1x
6112648

1x
6112879

1x
6112903

1x
6113081

1x
6096113

1x
6112913

1x
6017034

1x
6114314

2x
6093529

1x
6018580

4x
3006343

3x
4622176

2x
6057390

6x
6092604

1x
6112922

9x
6030534

1x
6112570

1x
6112923

Customer Service
Kundenservice
Service Consommateurs
Servicio Al Consumidor
LEGO.com/service or dial

 : 00800 5346 5555
: 1-800-422-5346



Friends

41106



LEGO.com/popstar



LEGO.com/popstar



Apple, the Apple logo and iPad are trademarks of Apple Inc./Apple, le logo Apple et iPad sont des marques de commerce d'Apple Inc./Apple, el logotipo de Apple e iPad son marcas comerciales de Apple Inc.
Google Play is a trademark of Google Inc./Google Play est une marque de commerce de Google Inc./Google Play es una marca comercial de Google Inc.



Friends

41101



41100



41098



Friends

41100



Heartlake City

41099



41098



41101





ELVES





CREATOR



31035



31036



31038



3 IN 1

LEGO.com/creator



Friends



Livi

Music Maker



LEGO.com/popstar

Apple, the Apple logo and iPad are trademarks of Apple Inc./Apple, le logo Apple et iPad sont des marques de commerce d'Apple Inc./Apple, el logotipo de Apple e iPad son marcas comerciales de Apple Inc. Google Play is a trademark of Google Inc./Google Play est une marque de commerce de Google Inc./Google Play es una marca comercial de Google Inc.

LEGO and the LEGO logo are trademarks of the/sont des marques de commerce du/son marcas registradas de LEGO Group. ©2015 The LEGO Group. 6129218