



Mixels

41510



WARNING: CHOKING HAZARD.
Toy contains small parts and a small ball.
Not for children under 3 years.



AVERTISSEMENT : RISQUE D'ÉTOUFFEMENT.
Le jouet contient des petites pièces ainsi qu'une petite boule.
Il ne convient pas aux enfants de moins de 3 ans.



ADVERTENCIA: PELIGRO DE ASFIXIA.
Juguete que contiene partes pequeñas y una pelota pequeña.
No recomendado para niños menores de 3 años.

1



2

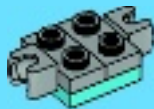

3

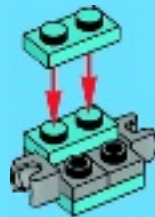

4

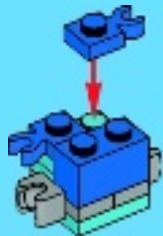

5



6



7



1

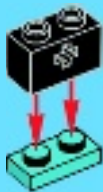

2

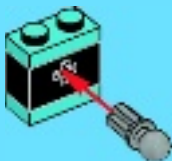

3



4



8

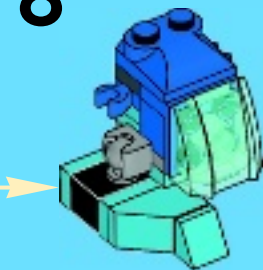

1

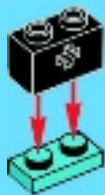

2

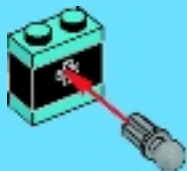

3



4



9

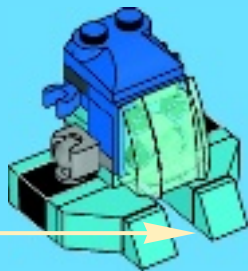

1

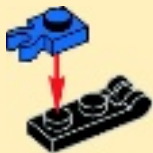

2



2x

10

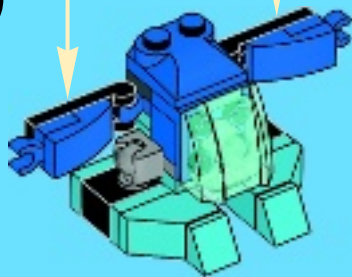

1

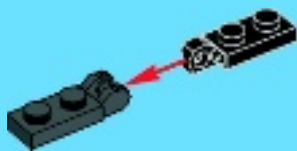

2

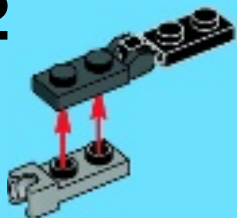

3

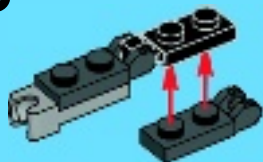

4

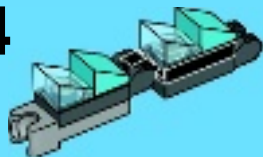

11

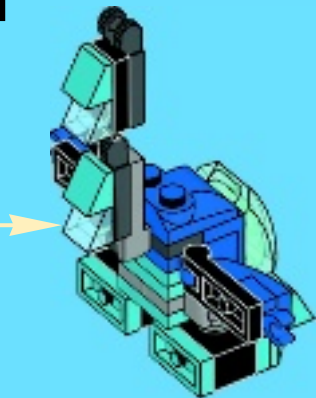



1



2



3



4

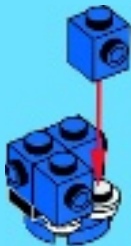

5



6



7



12

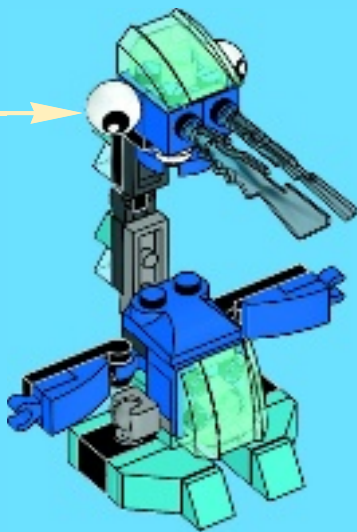



2x
4233487



2x
4515368



1x
6043639



4x
4619520



4x
4583862



1x
300423



1x
6039479



1x
4185620



1x
4183043



2x
6043656



2x
4619655



2x
6055065



1x
4496366



2x
4210884



2x
4211375



1x
4625032



1x
6037412



1x
403223



2x
6022109



Customer Service

Kundenservice

Service Consommateurs

Servicio Al Consumidor

LEGO.com/service or dial



00800 5346 5555 :



1-800-422-5346 :



6x
4619511



4x
4613257



2x
6056225



2x
614101



2x
4611464



2x
6064345



**41509
SLUMBO**



**41511
FLURR**



**41510
LUNK**



**FROSTICONS
MAX!**



LEGO.com/mixels





Mixels



41500
FLAIN



41501
VULK



41502
ZORCH



41509
SLUMBO



41510
LUNK



41511
FLURR



41518
GLOOM



41519
GLURT



41520
TORTS



41503
KRADER



41504
SEISMO



41505
SHUFF



41512
CHOMLY



41513
GOBBA



41514
JAWG



41521
FOOTI



41522
SCORPI



41523
HOOGI



41506
TESLO



41507
ZAPTOR



41508
VOLECTRO



41515
KRAW



41516
TENTRO



41517
BALK



41524
MESMO



41525
MAGNIFO



41526
WIZWUZ



LEGO.com/mixels



Mixels

CALLING ALL MIXELS
APPEL À TOUS LES MIXELS !
¡LLAMANDO A TODOS LOS MIXELS!



YOU CAN BUY THE GAME!
TU PEUX ACHETER LE JEU !
¡PUEDES COMPRAR EL JUEGO!

IC2D6VER

IN GAME CODE!
CODE DANS LE JEU !
¡CÓDIGO PARA EL JUEGO!



Available on the
App Store



ANDROID APP ON
Google play

Apple, the Apple logo, iPad, iPhone and iPod touch are trademarks of Apple Inc., registered in the U.S. and other countries. App Store is a service mark of Apple Inc.

Apple, le logo Apple, iPad, iPhone et iPod touch sont des marques de commerce d'Apple Inc., déposées aux États-Unis et dans d'autres pays. App Store est une marque de service d'Apple Inc.

Apple, el logotipo de Apple, iPad, iPhone e iPod touch son marcas comerciales de Apple Inc. registradas en EE. UU. y otros países. App Store es una marca de servicio de Apple Inc.

Google Play is a trademark of Google Inc.

Google Play est une marque de commerce de Google Inc.

Google Play es una marca comercial de Google Inc.



WIN!

Go to LEGO.com/productfeedback to fill out a survey for a chance to win a cool LEGO® Product.

No purchase necessary.

Open to all residents where not prohibited.



LEGO.com/productfeedback

GEWINNE!

Nimm an der Umfrage auf LEGO.com/productfeedback teil und hab die Chance ein cooles LEGO® Produkt zu gewinnen!

Die Teilnahme am Gewinnspiel führt zu keinerlei Kaufverpflichtungen. Teilnahme in allen nicht ausgeschlossenen Ländern möglich.

WIN!

Ga naar LEGO.com/productfeedback, vul een enquêteformulier in en maak kans op een cool LEGO® product.

Geen aankoopverplichting. Ledereen mag deelnemen, uitgezonderd ingezetenden van landen waar een enquêteverbod geldt.

GAGNE !

Visite LEGO.com/productfeedback pour répondre à un questionnaire et avoir une chance de gagner un produit LEGO® très cool !

Aucune obligation d'achat. Ouvert à tous les résidents des pays autorisés.

当てよう!

LEGO.com/productfeedback にアクセスして、アンケートにご記入ください。当選者にはレゴ®製品を差し上げます。

お買い上げの必要はありません。禁止されていない限り、すべての皆様にご利用いただけます。

 LEGO.com

LEGO, the LEGO logo and MIXELS are trademarks and/or copyrights of the/sont des marques de commerce et/ou copyrights du/son marcas registradas, algunas de ellas protegidas por derechos de autor, de LEGO Group.

©2014 The LEGO Group. All rights reserved/Tous droits réservés/Todos los derechos reservados.

TM & © 2014 Cartoon Network

6072663