



# Mixels

41533  
GLOBERT



# MAX!



41535  
BOOGLY



41534  
VAMPOS



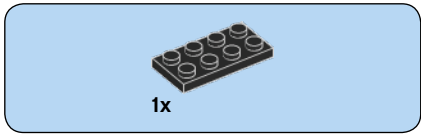

1

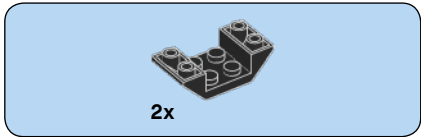
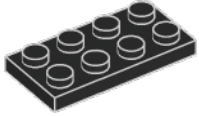

2

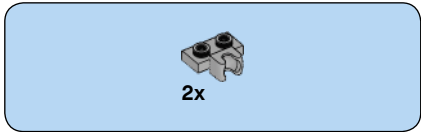
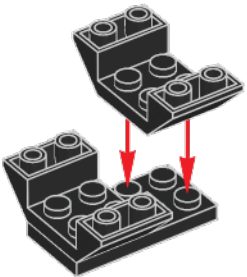

3

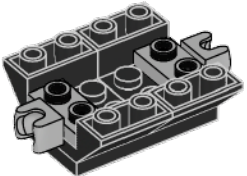

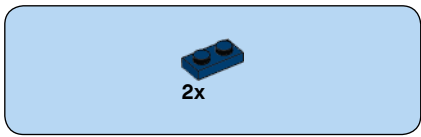

4

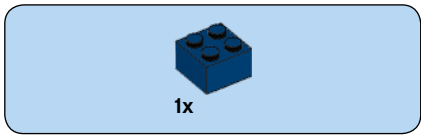
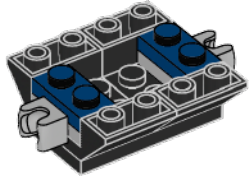

5

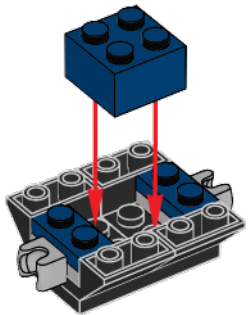

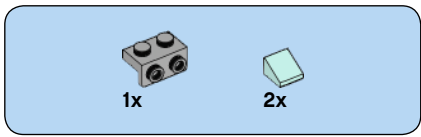

6

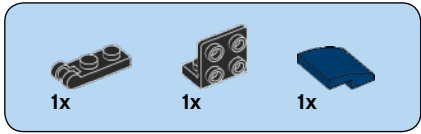
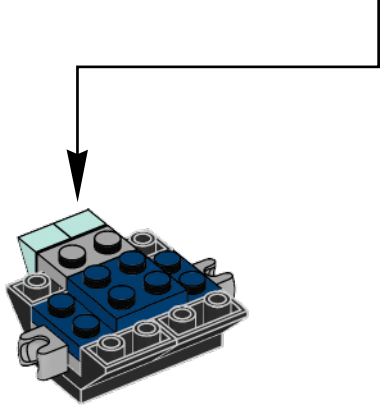
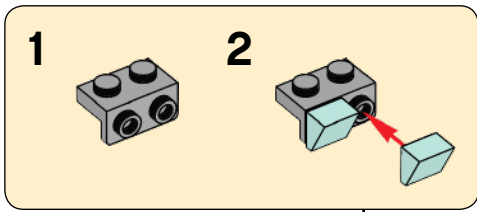

7

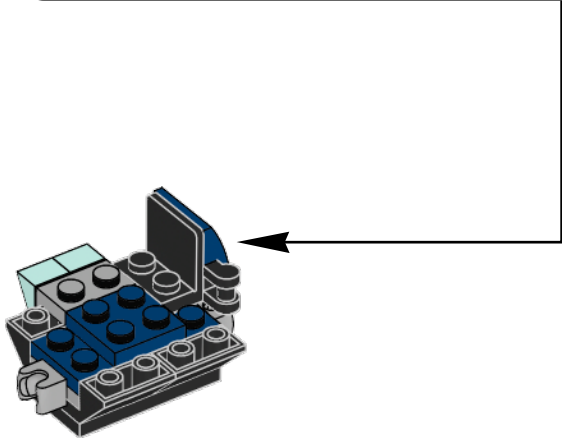
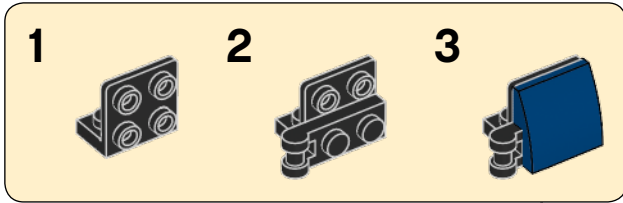

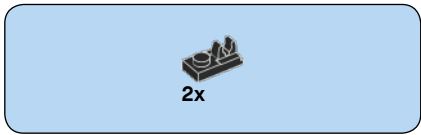

8

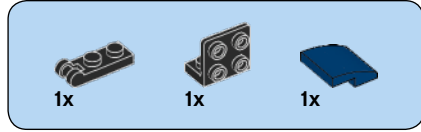
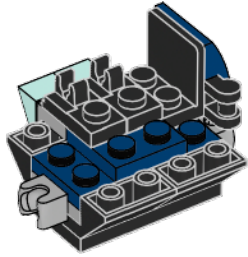

9

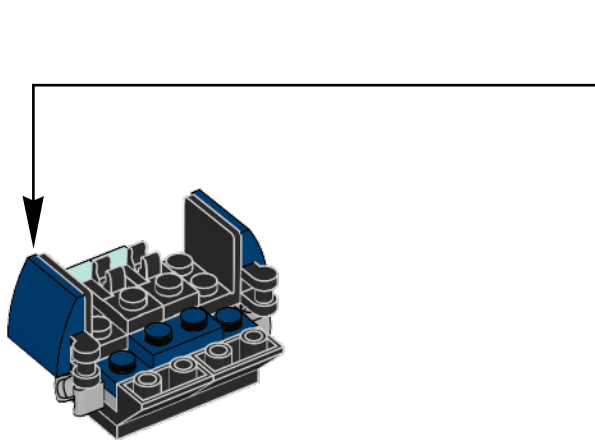
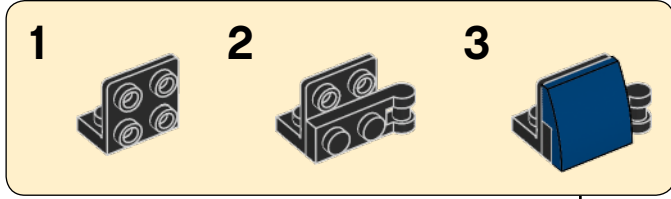

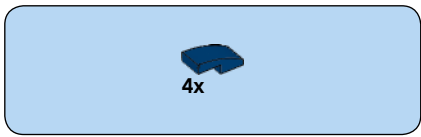

10

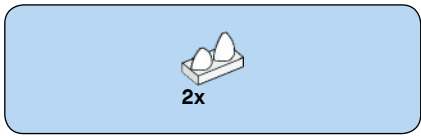
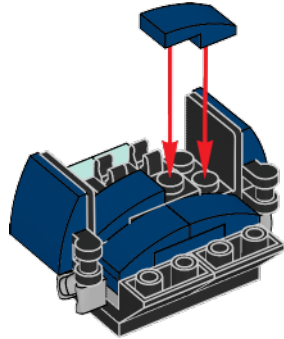

11

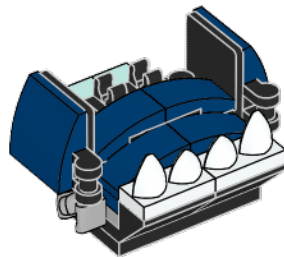

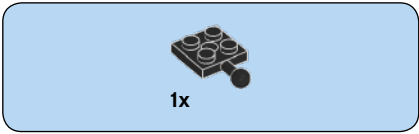
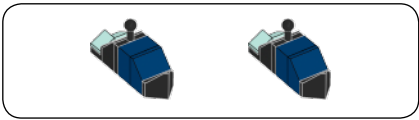

**1**

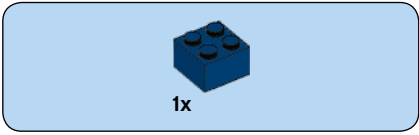
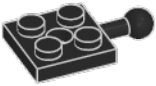

**2**

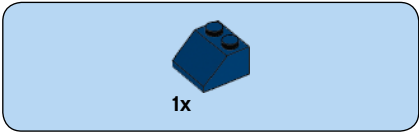
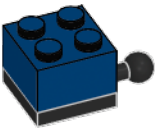

**3**

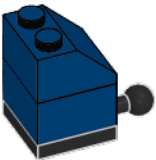

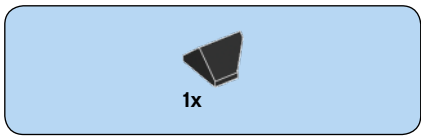

4

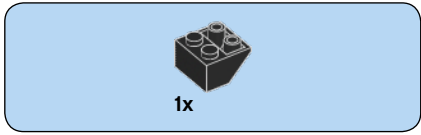

5

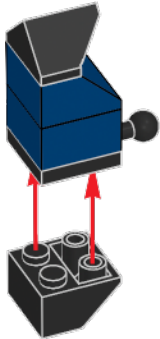



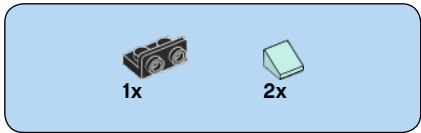

6

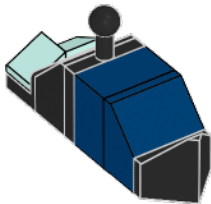
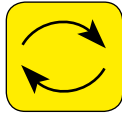
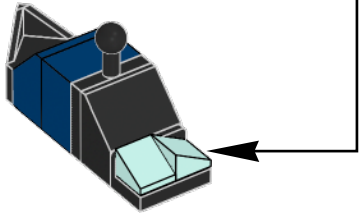
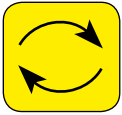
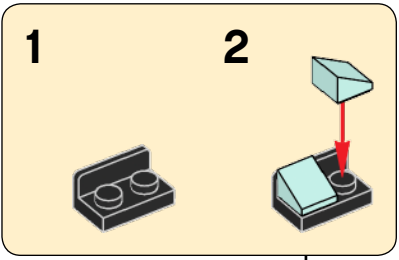

2x

12

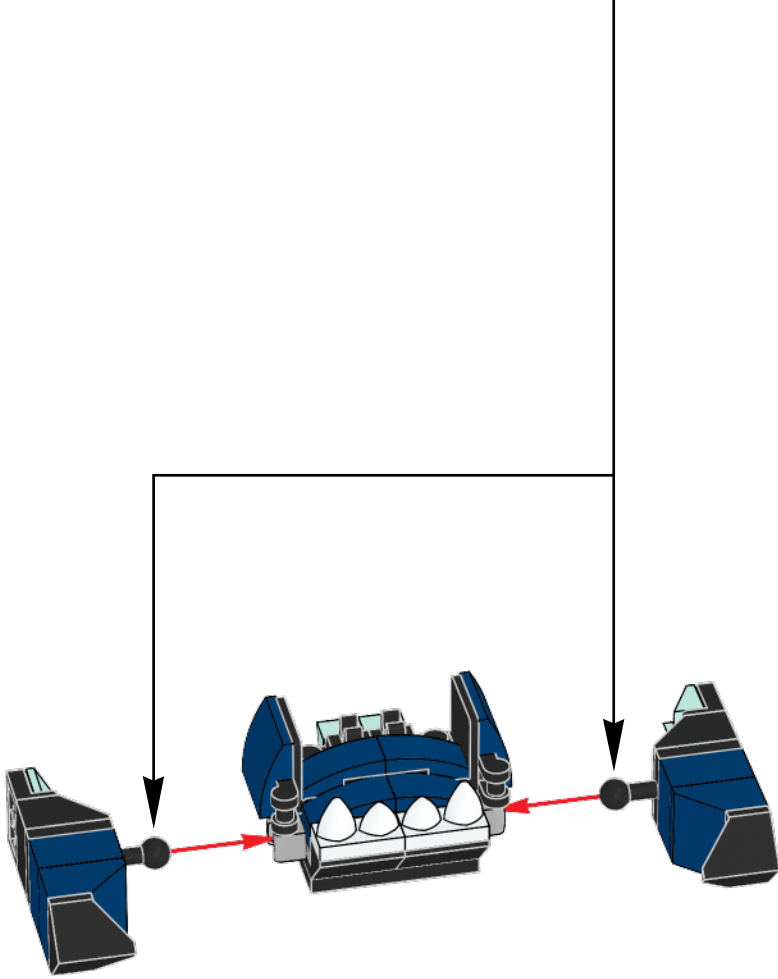

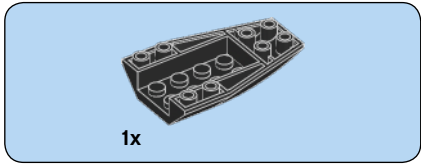
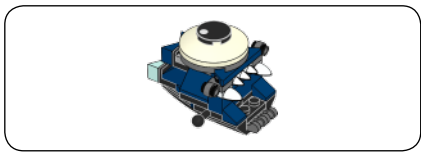

1

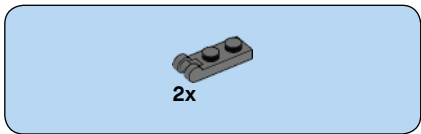
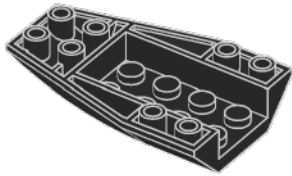

2

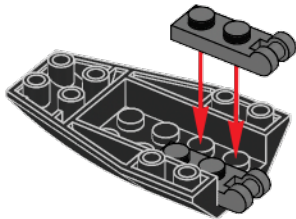



3

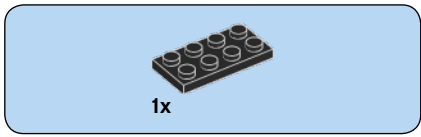
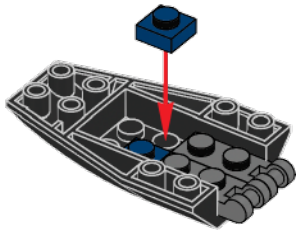

4

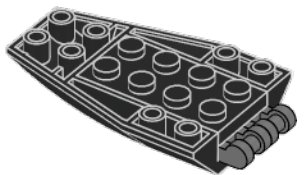

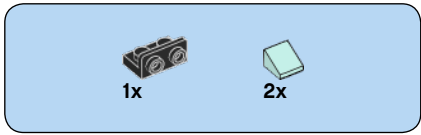

5

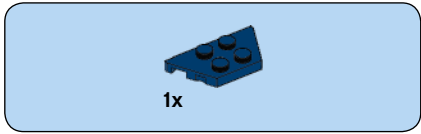
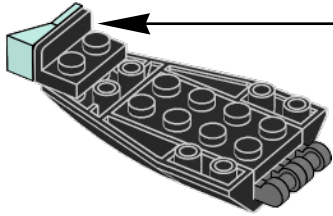
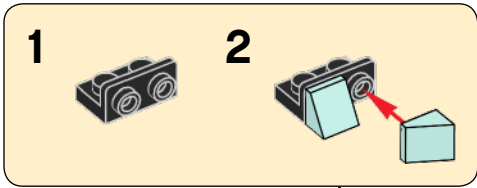

6

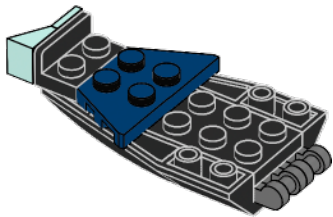

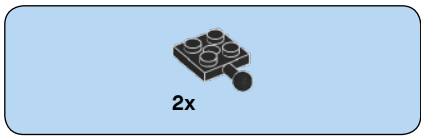

7

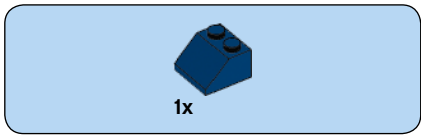
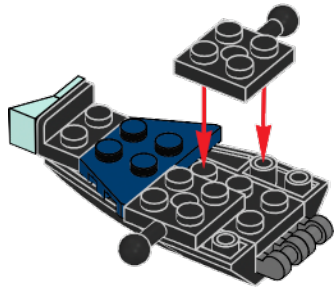

8

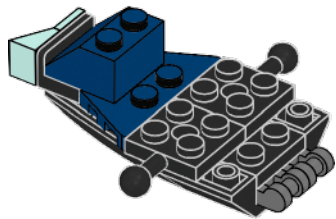

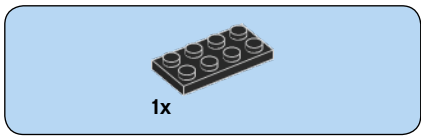

9

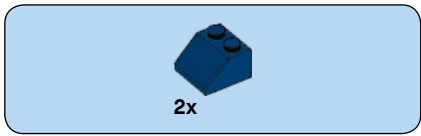
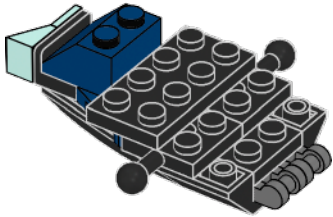

10

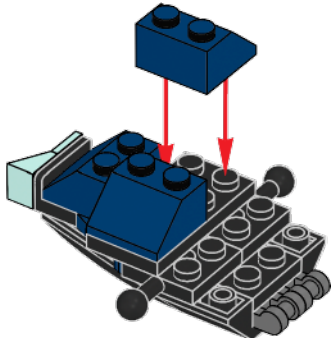

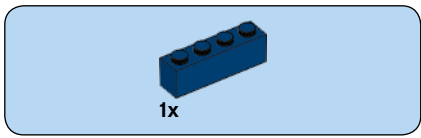

11

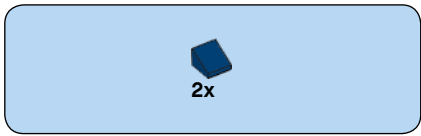
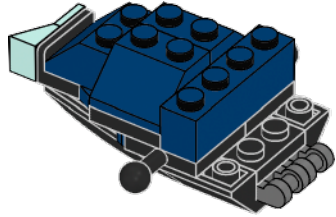

12

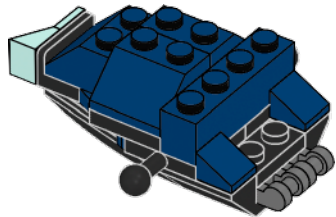



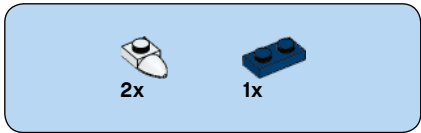

13

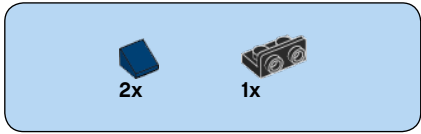
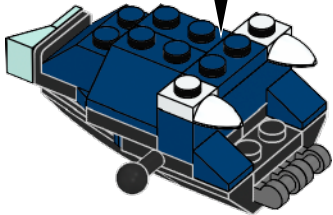
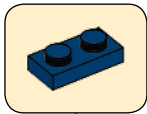

14

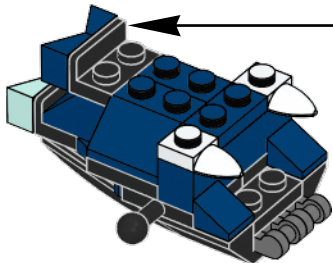
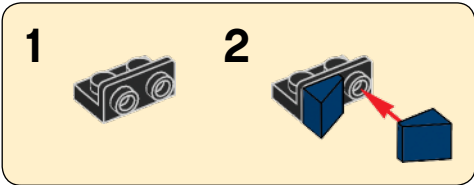

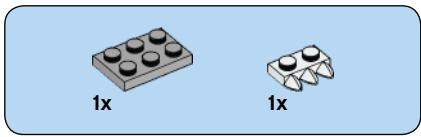

15

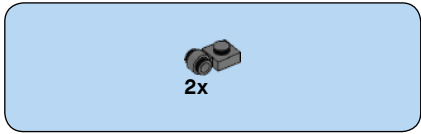
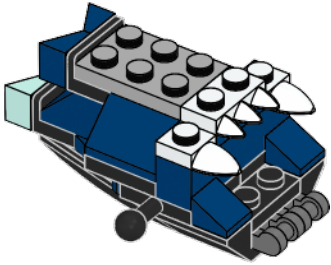

16

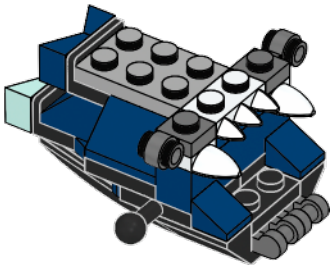

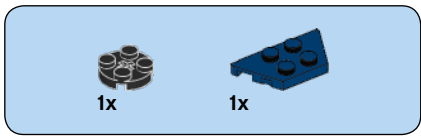

17

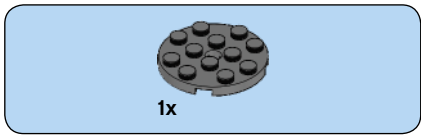
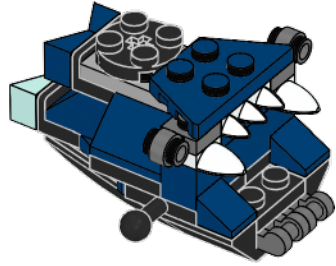

18

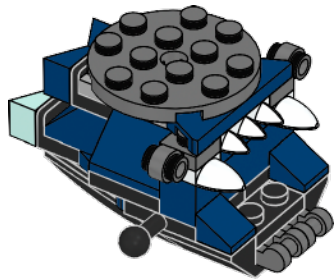

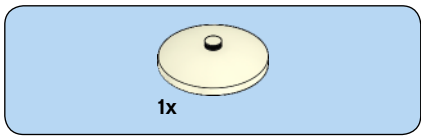

19

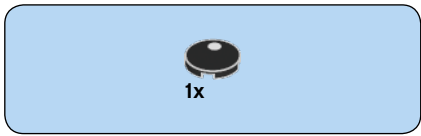
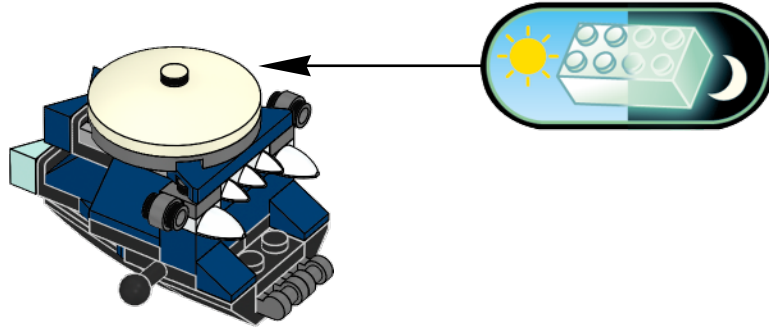

20

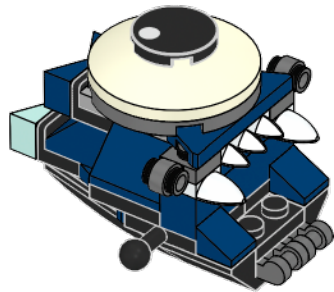

21

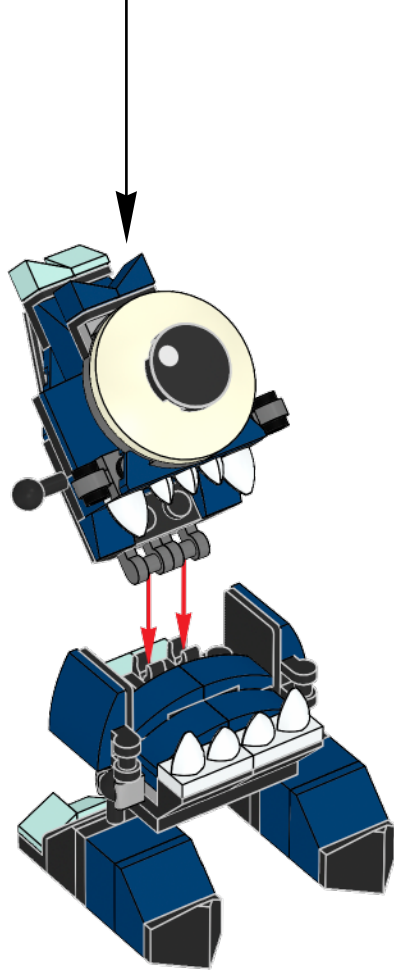

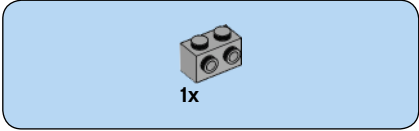

**1**

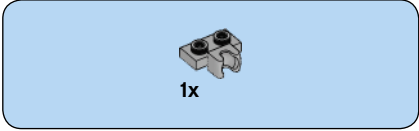
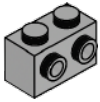

**2**

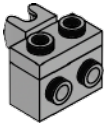

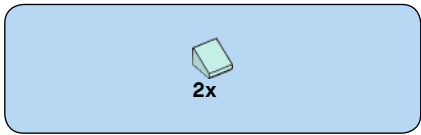

3

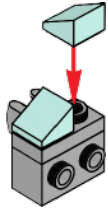

4

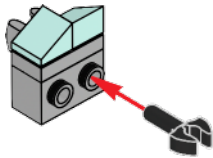

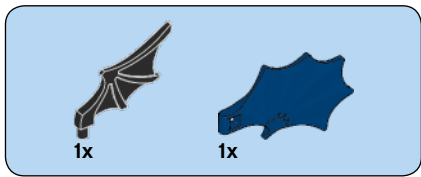

5



22

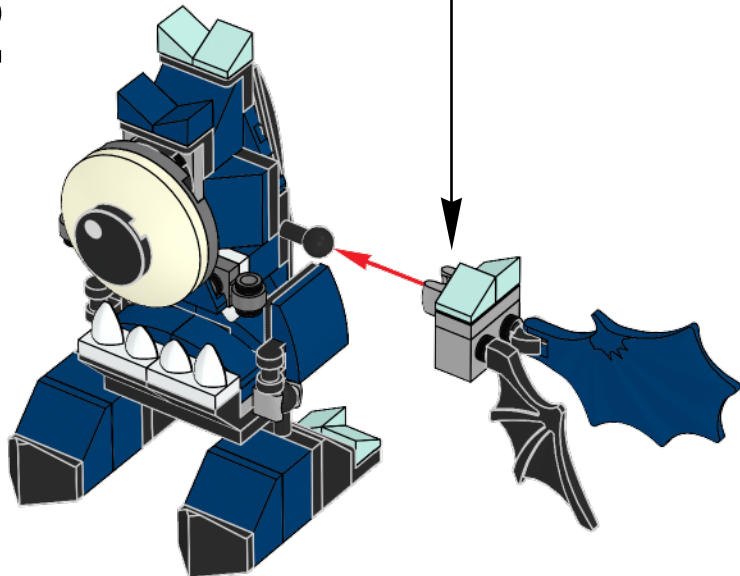



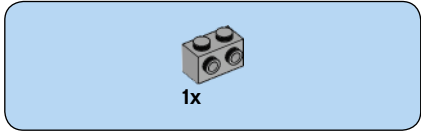
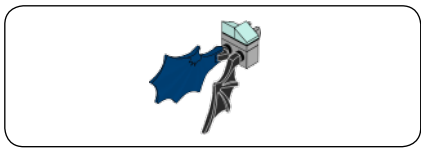

**1**

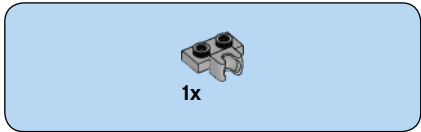
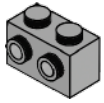

**2**

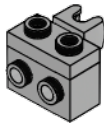

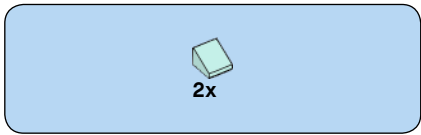

3

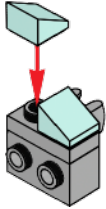

4

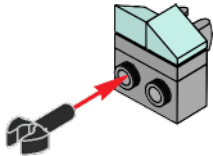

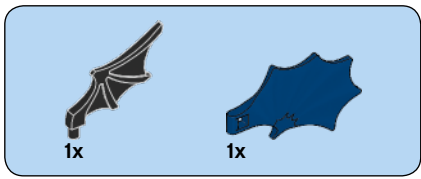

5

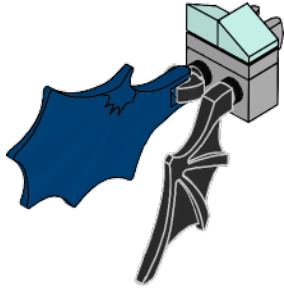

23

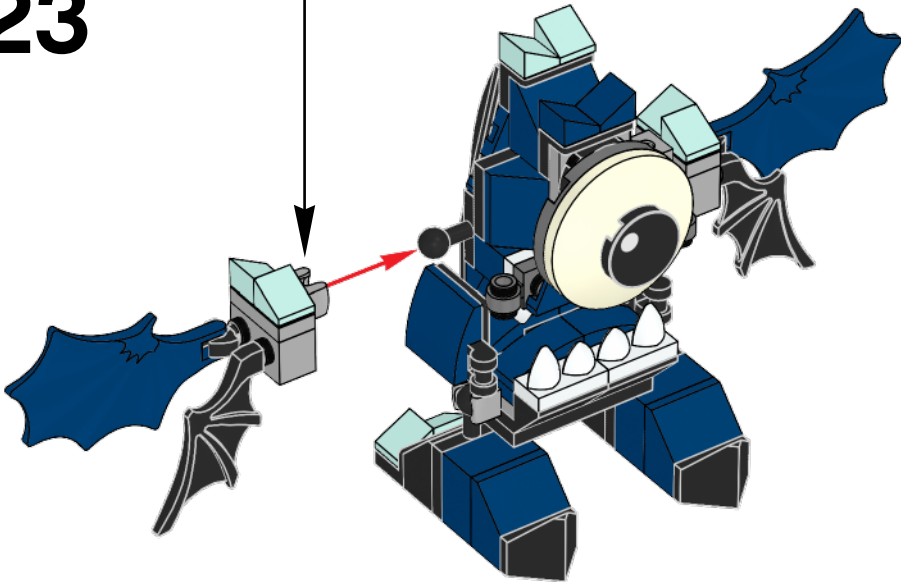

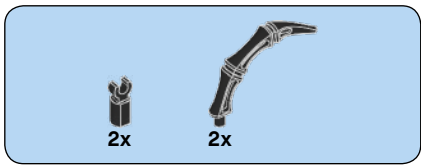

24

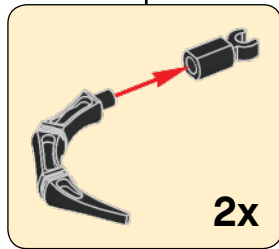
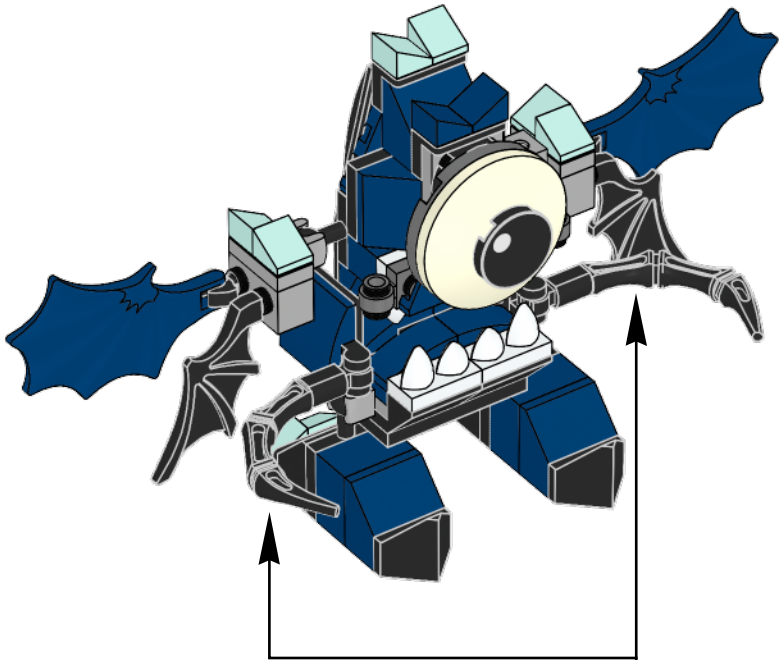

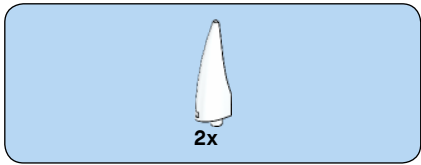

25

