



# Mixels™



41539



 [LEGO.com](http://LEGO.com)

6126514

1



2



**3**

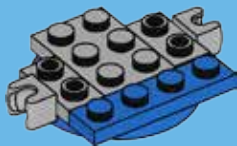

**4**

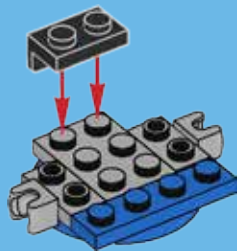

5

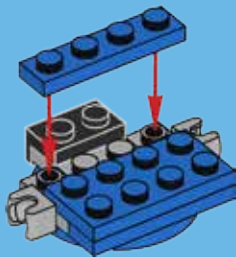

6

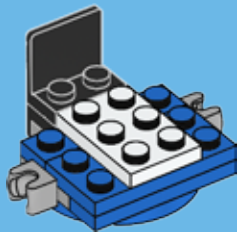

7



8

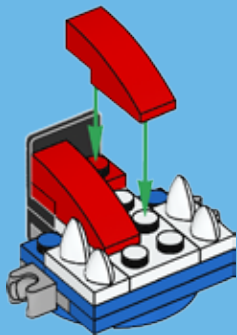

9

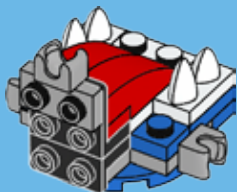

10

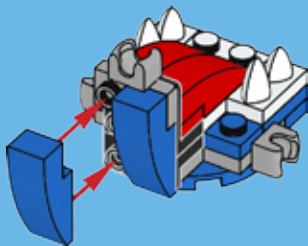



11

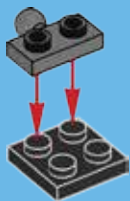

12



13

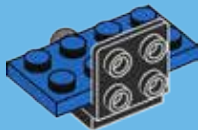

14

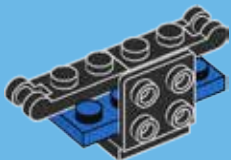

15

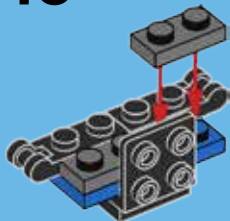

16

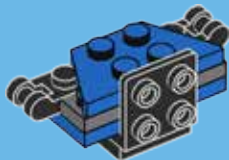



17

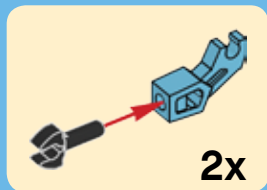
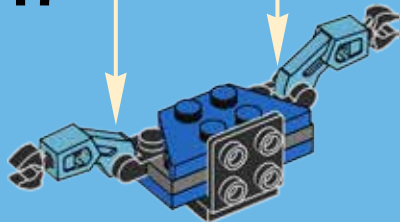

2x



18



19



20



21



22

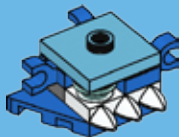

23

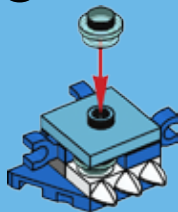

24

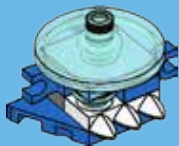

25



26



27

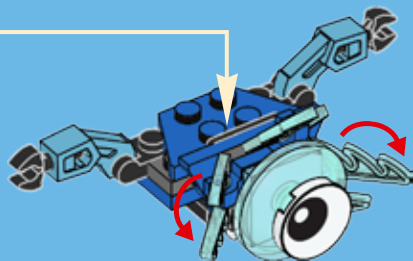



28

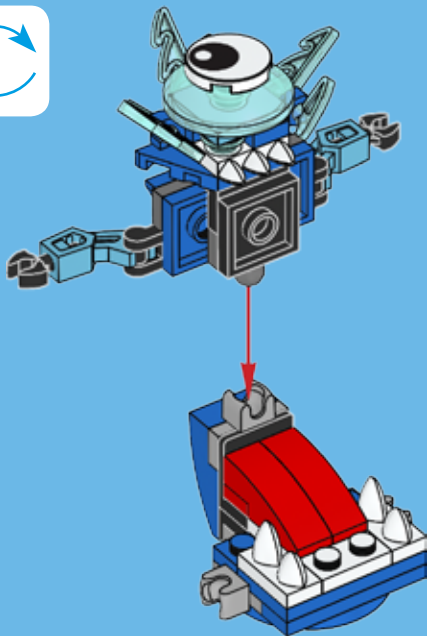

# 29

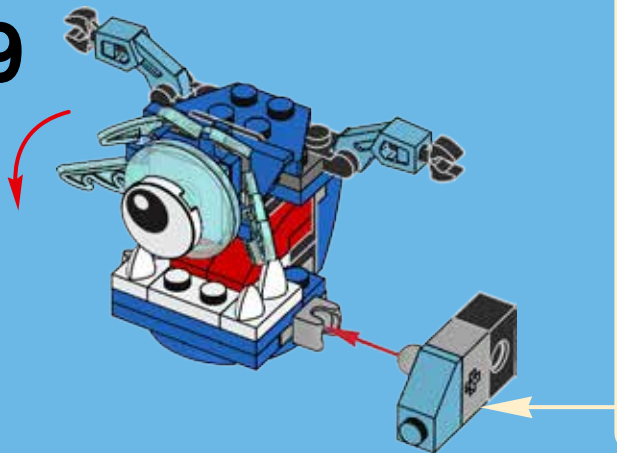

1



2

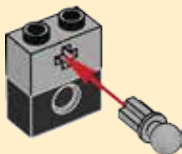

3



1



2

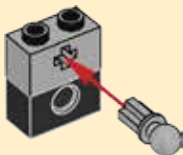

3



30

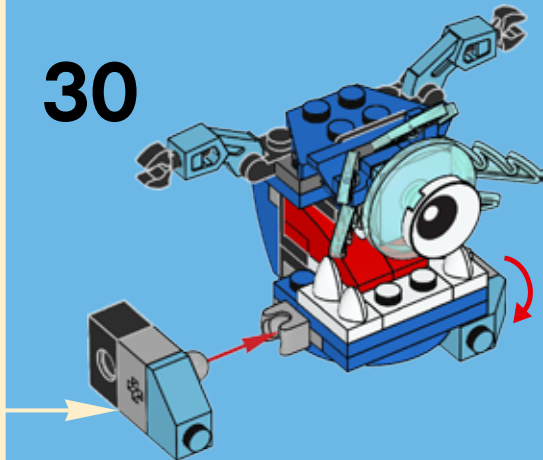



31

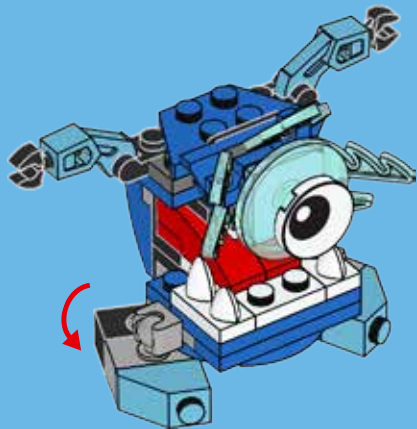



**1**

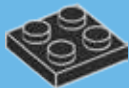

**2**



**3**

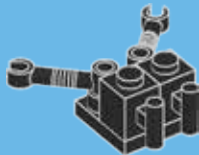

4

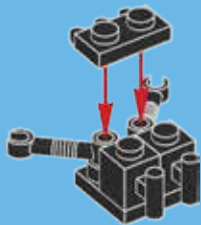

5

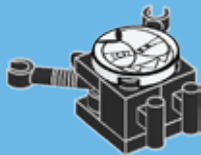

6





2x  
6104486



1x  
302101



2x  
4163917



2x  
302226



3x  
4520946



2x  
4251162



2x  
4619655



1x  
6060732



1x  
6060829



1x  
6016172



2x  
371023



3x  
4211063



1x  
6060734



3x  
6021974



2x  
6000650



2x  
302023



1x  
6039479



1x  
6003008



2x  
6046384



2x  
292126



2x  
4515368



2x  
4609454



2x  
4211375



1x  
6046381



2x  
370026



1x  
6094141



1x  
4581501



2x  
4233493

**Customer Service**

**Kundenservice**

**Service Consommateurs**

**Servicio Al Consumidor**

**LEGO.com/service or dial**



**00800 5346 5555 :**

**1-800-422-5346 :**



2x  
4289538



2x  
4543998



1x  
4211396



2x  
4141580



1x  
302321



3x  
6043656



**KROG  
41539**



**FROSTICONS  
MAX!**



**CHILBO  
41540**



**SNOOF  
41541**



[LEGO.com/mixels](http://LEGO.com/mixels)





# Mixels



41536  
GOX



41537  
JINKY



41538  
KAMZO



41539  
KROG



41540  
CHILBO



41541  
SNOOF



41542  
SPUGG



41543  
TURG

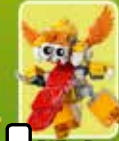

41544  
TUNGSTER



[LEGO.com/mixels](http://LEGO.com/mixels)





**YOU CAN BUY THE GAME!  
TU PEUX ACHETER LE JEU!  
¡PUEDES COMPRAR EL JUEGO!**

**CHI11YCHO3P**

**IN GAME CODE!  
CODE DANS LE JEU!  
¡CÓDIGO PARA EL JUEGO!**



Apple, the Apple logo, iPad, iPhone and iPod touch are trademarks of Apple Inc. Apple, le logo Apple, iPad, iPhone et iPod touch sont des marques de commerce d'Apple Inc.

Apple, el logotipo de Apple, iPad, iPhone e iPod touch son marcas comerciales de Apple Inc.

# Mixels RUSH



Google Play is a trademark of Google Inc.

Google Play est une marque de commerce de Google Inc.

Google Play es una marca comercial de Google Inc.