



# Mixels™

41550



 [LEGO.com](http://LEGO.com)

6126519

1

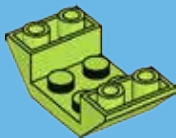

2

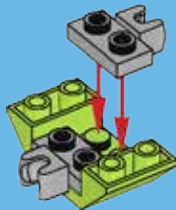

**3**

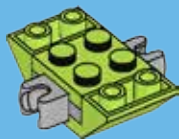

**4**

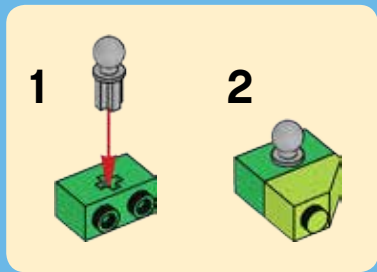
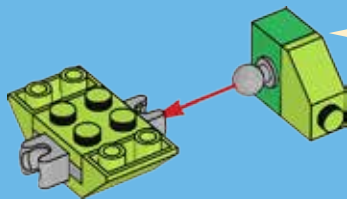

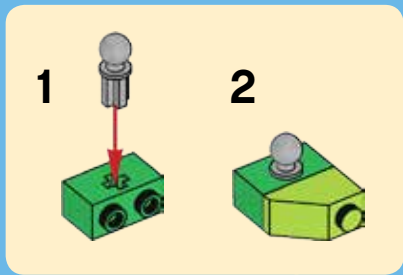

5

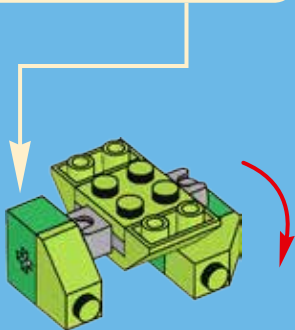

6

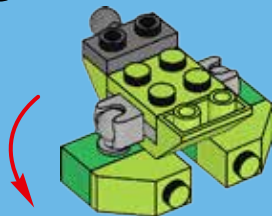

7

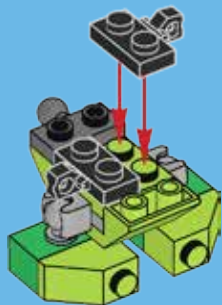

8

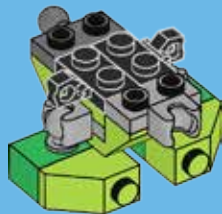

9

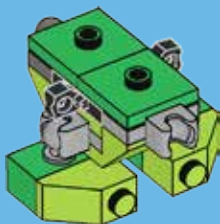

10

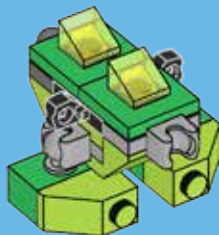



11

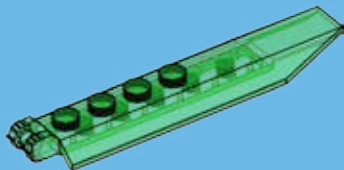

12

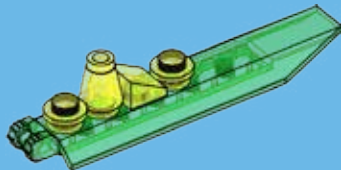

2x

13

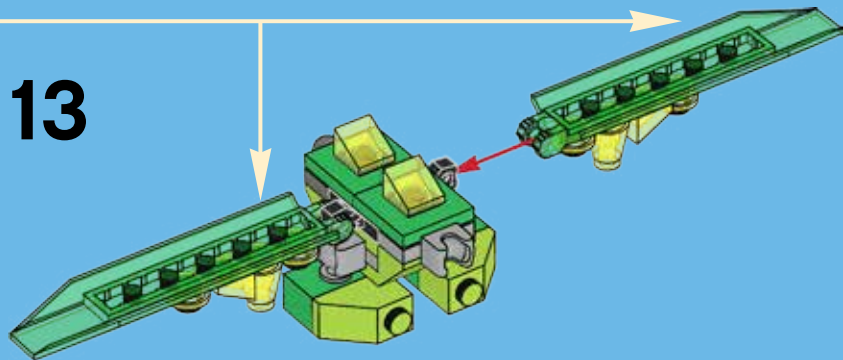





14

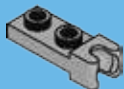

15

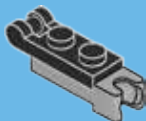

16

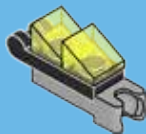

1

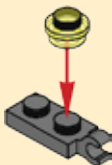

2

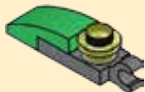

17

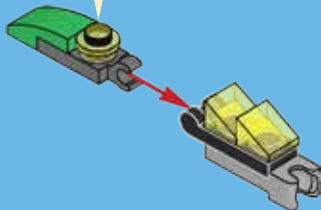

18

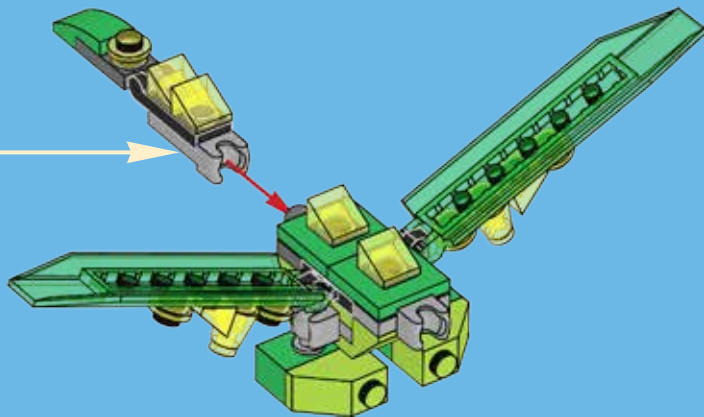



19

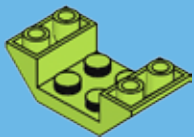

20

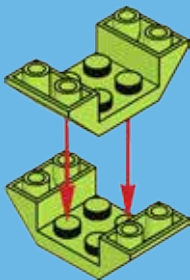

21

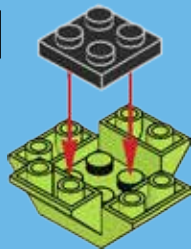

22

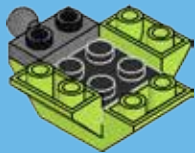

23

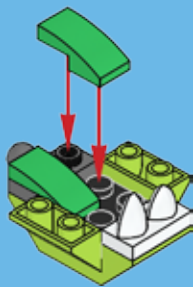

24

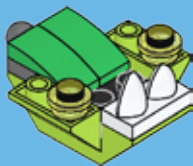

25

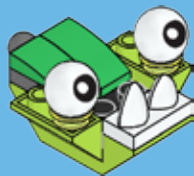

26

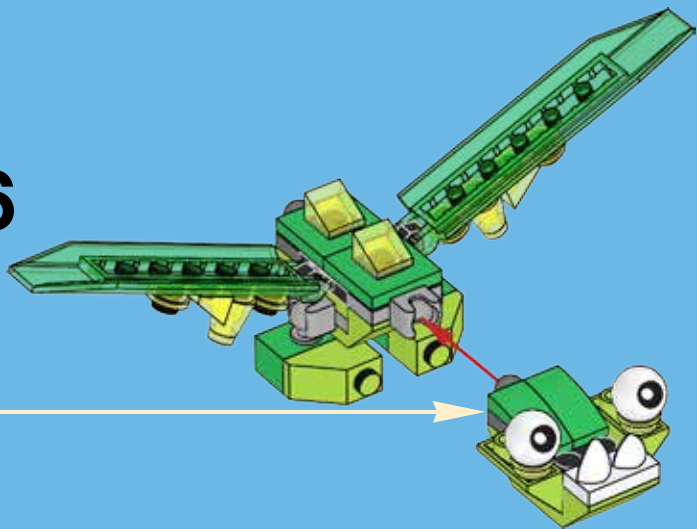

27

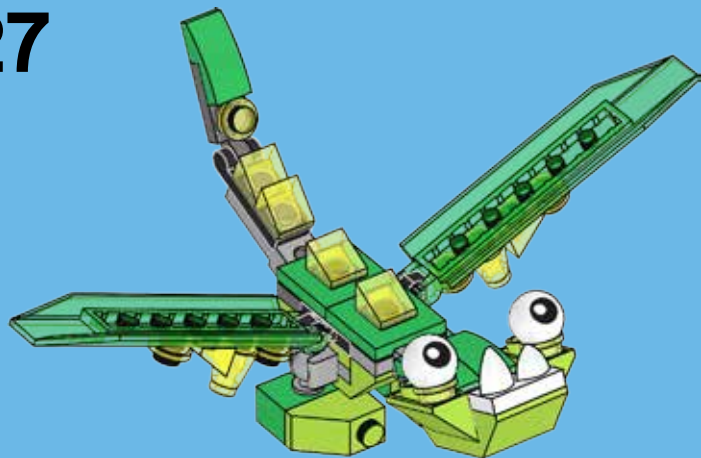





28

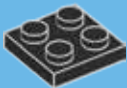

29



30

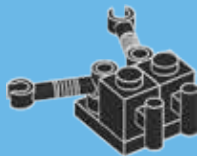

**31**

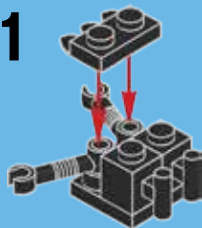

**32**



**33**



  
2x  
4567334

  
2x  
4565321

  
2x  
292126

  
2x  
4537925

  
1x  
6060732

  
3x  
6043656

  
6x  
6076751

  
2x  
4233489

  
2x  
302226

  
1x  
4537937

  
1x  
6046384

  
1x  
6043639

  
7x  
3005749

  
3x  
6047426

  
1x  
4515368

  
3x  
6110067

  
2x  
6056225

  
2x  
4211375

  
2x  
6040339

  
2x  
6039479

  
2x  
4185620

  
1x  
6094141

  
1x  
4581225

  
2x  
4141580



**Customer Service**

**Kundenservice**

**Service Consommateurs**

**Servicio Al Consumidor**

**LEGO.com/service or dial**

  
 : 00800 5346 5555  
 : 1-800-422-5346



# Mixels™

SERIES  
**6**



**41545  
KRAMM**



**41546  
FORX**



**41547  
WUZZO**



**41548  
DRIBBAL**



**41549  
GURGGLE**



**41550  
SLUSHO**



**41551  
SNAX**



**41552  
BERP**



**41553  
VAKA-WAKA**



[LEGO.com/mixels](http://LEGO.com/mixels)





**DRIBBAL  
41548**



**GLORP CORP  
MAX!**



**GURGGLE  
41549**



**SLUSHO  
41550**



[LEGO.com/mixels](http://LEGO.com/mixels)





**LEGO.com/mixels**





**YOU CAN  
BUY THE  
GAME!**

# MIXELS RUSH

**G008TRO08ER**

**IN GAME CODE!**



Apple, the Apple logo, iPad, iPhone and iPod touch are trademarks of Apple Inc., registered in the U.S. and other countries. App Store is a service mark of Apple Inc. Google Play is a trademark of Google Inc.