



# Mixels

## CAMILLOT

41557



 [LEGO.com](http://LEGO.com)

6150692

1

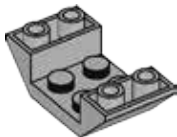

2

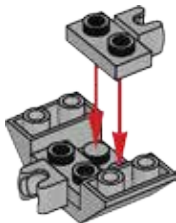

**3**

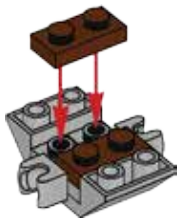

**4**



5



6



7

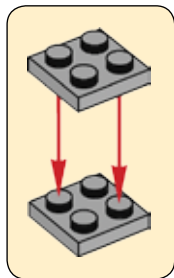

8

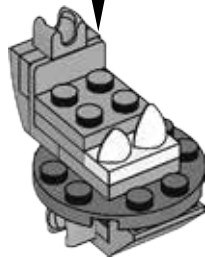
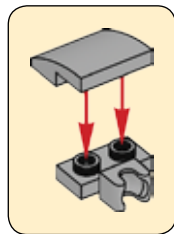

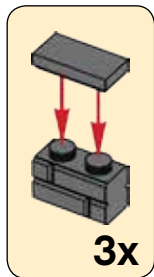

9

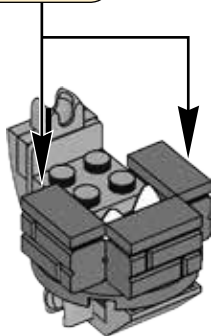

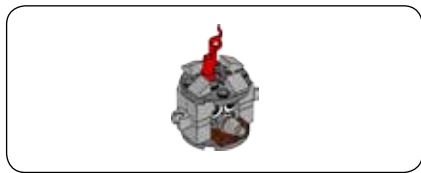

10

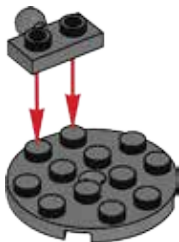

11



12

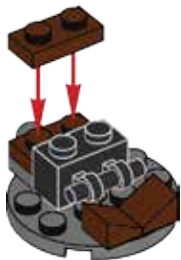

1



2



13





1



2

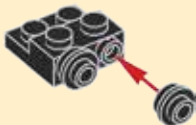

3



14



15



16

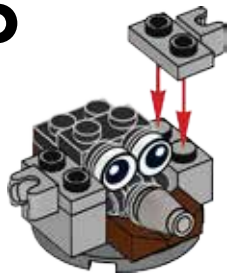

17

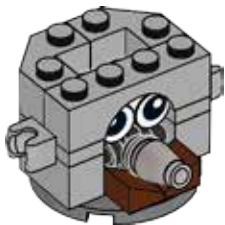

18



19



20



**21**

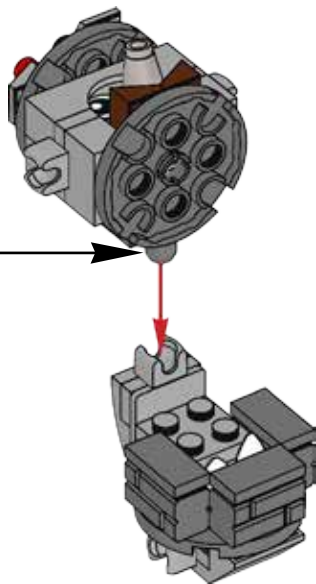

22

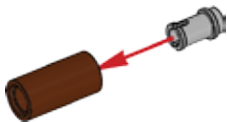

23



24



25

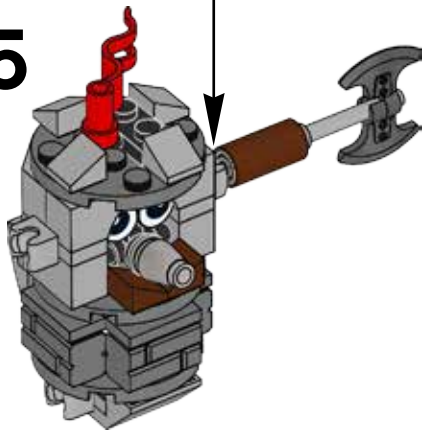

26

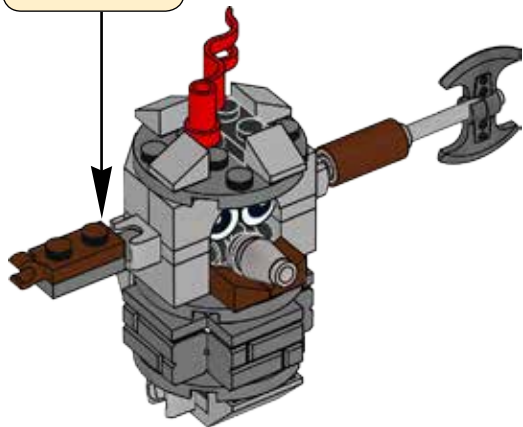
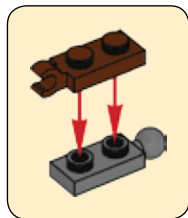





27

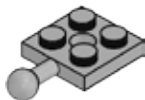

28



29

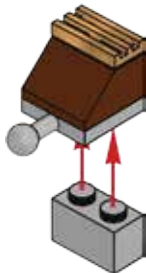

30



2x

**31**

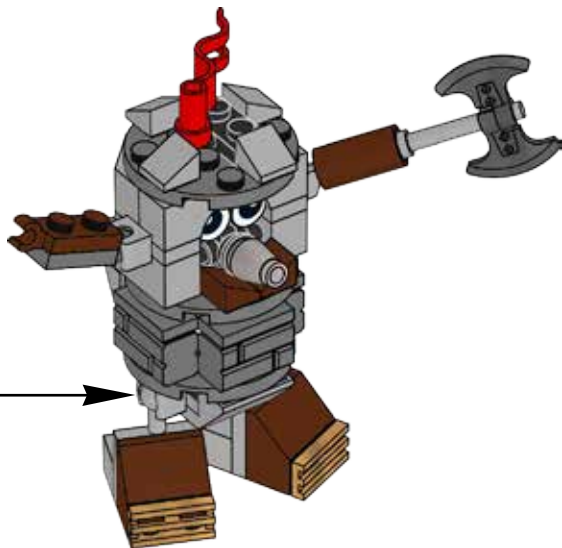



2x  
6029156



3x  
6100627



1x  
4288212



4x  
4211150



4x  
4521921



3x  
4211397



1x  
6039479



1x  
6046384



1x  
4289538



1x  
6052126



1x  
6008297



5x  
6043656



1x  
6102357



3x  
6000311



1x  
6121350



1x  
4184169



2x  
4504376



2x  
4211202



4x  
4211388



2x  
6063611



1x  
6123814



2x  
4490599



1x  
4569733



1x  
6055781



1x  
4211483



1x  
4654580



1x  
4211435



3x  
4528323



**Customer Service**

**Kundenservice**

**Service Consommateurs**

**Servicio Al Consumidor**

**LEGO.com/service or dial**



**00800 5346 5555 :**



**1-800-422-5346 :**



2x  
4651063



1x  
4211517



2x  
4613958



1x  
6116608



3x  
4211052



1x  
449521



**CAMILLOT  
41557**



**MIXADEL  
41558**



**PALADUM  
41559**

**MEDIVALS  
MAX!**

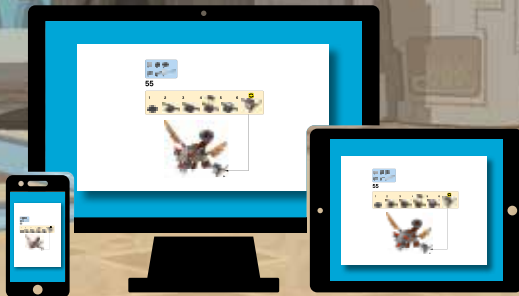

**LEGO.com/mixels**



SERIE 7

7<sup>E</sup> SÉRIE  
SERIE 7

WELCOME TO  
BIENVENUE A - BIENVENIDO A  
**MIXOPOLIS**

**PALADUM**  
41559

**TAPSY**  
41561

**TRUMPSY**  
41562

**CAMILLOT**  
41557

**JAMZY**  
41560

**BUSTO**  
41555

**TIKETZ**  
41556

**KUFFS**  
41554

**MIXADEL**  
41558



[LEGO.com/mixels](http://LEGO.com/mixels)



# Mixels™

WELCOME TO  
BIENVENUE À • BIENVENIDO A

MIXOPOLIS

