



PIRATES of the CARIBBEAN



4184



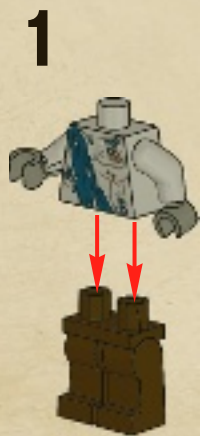
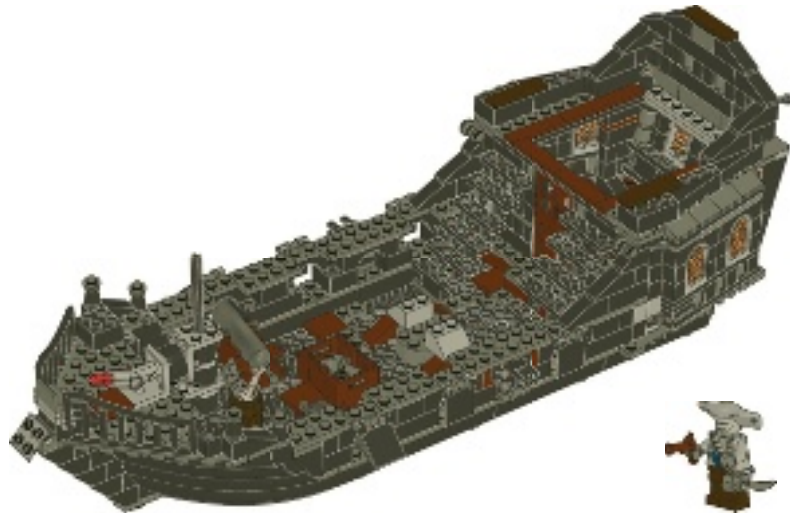



65

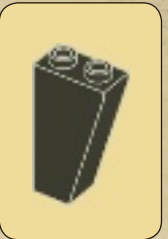
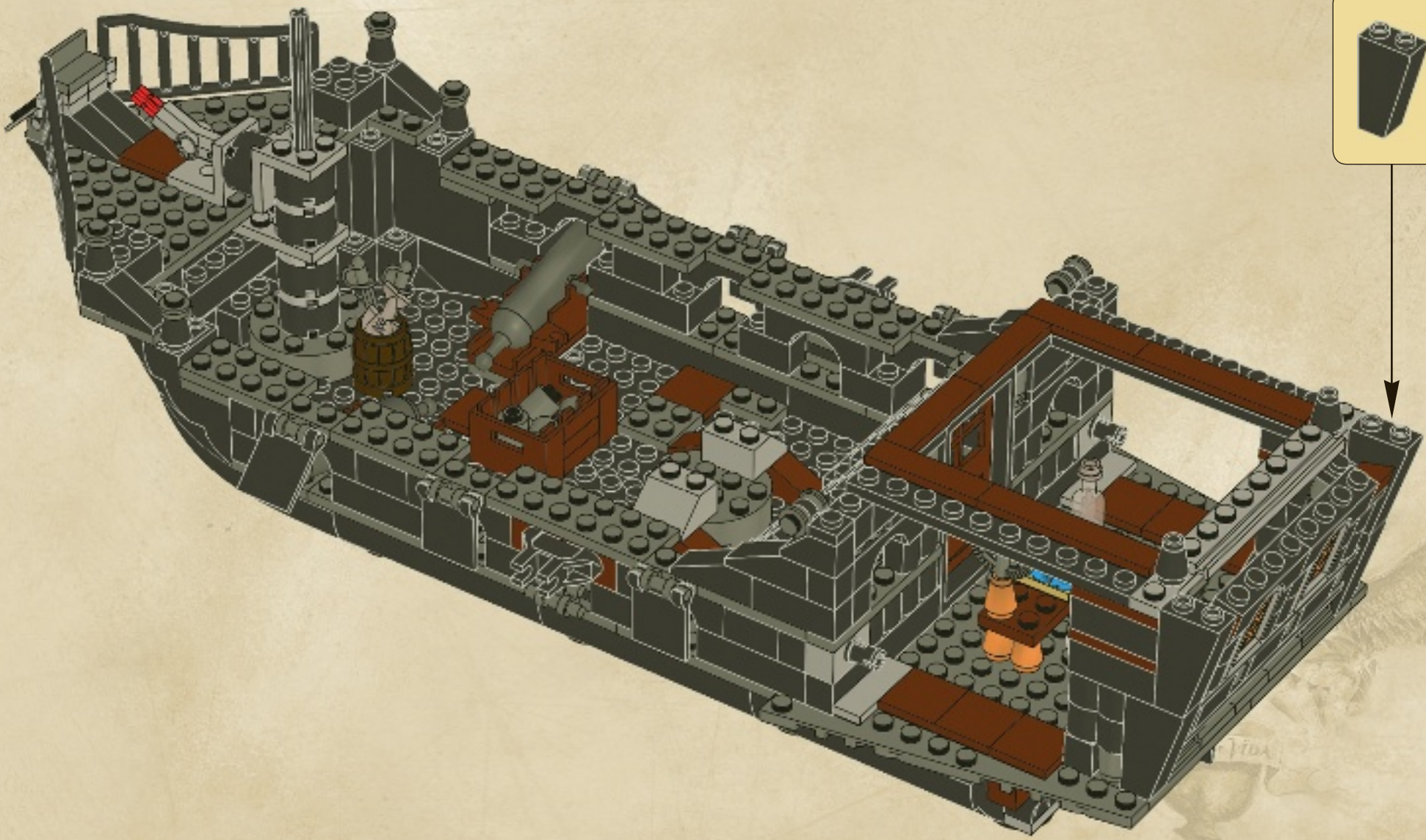

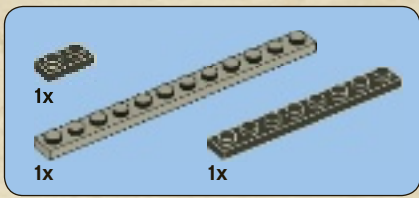

66

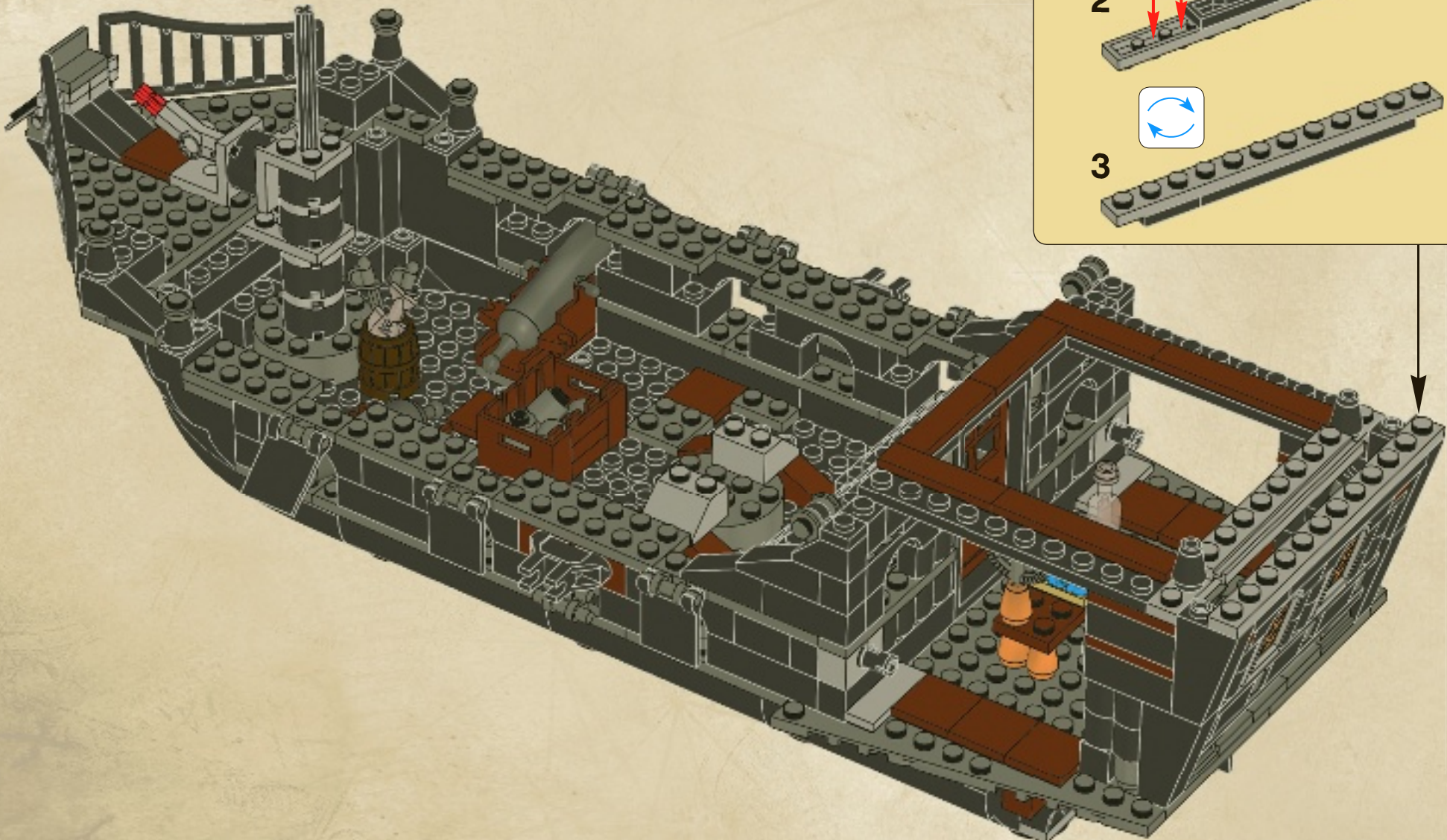
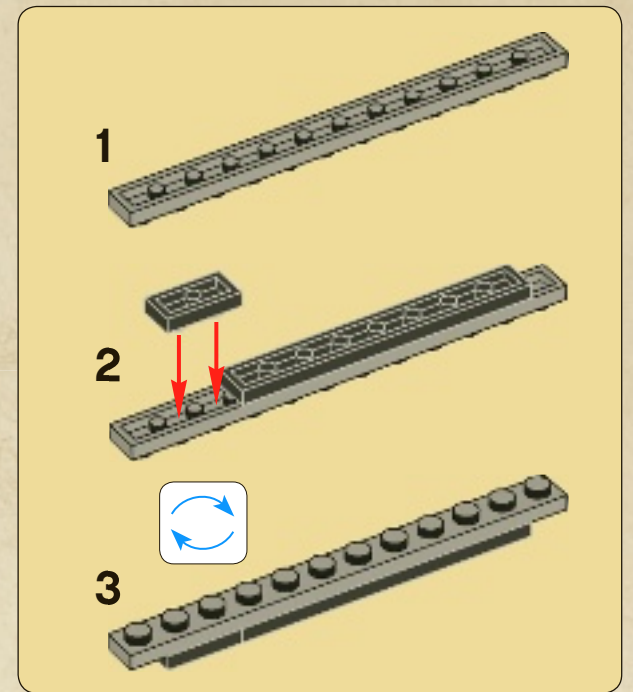

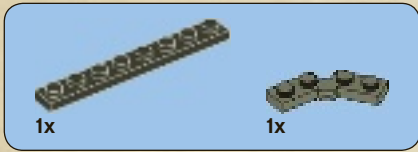

1

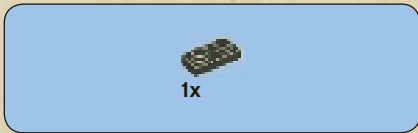
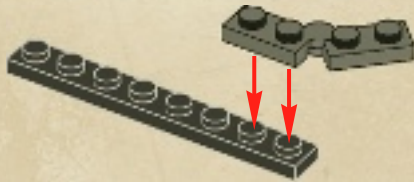

2

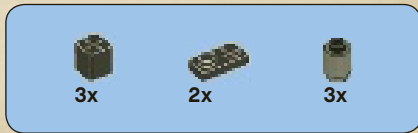
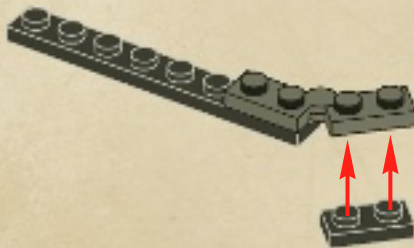

3

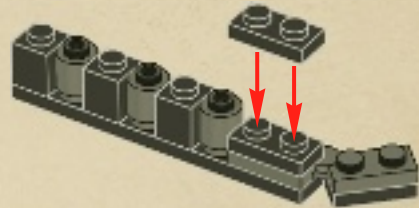

4

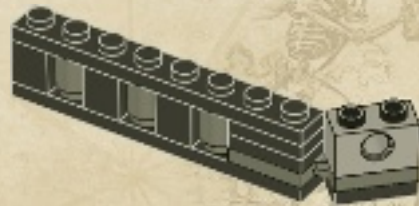



5

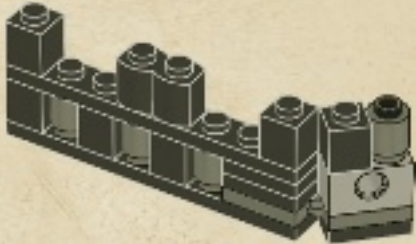

6

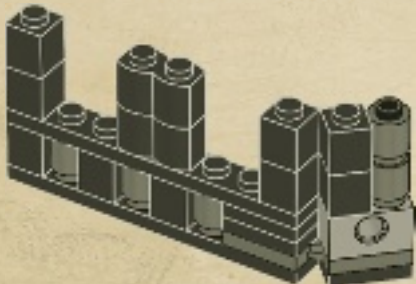

7

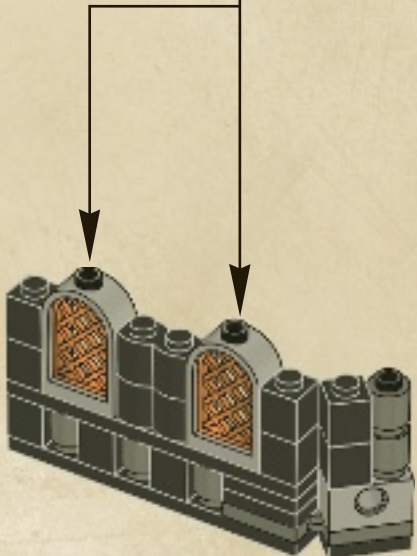
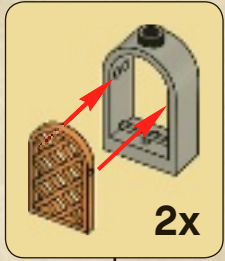



8



10

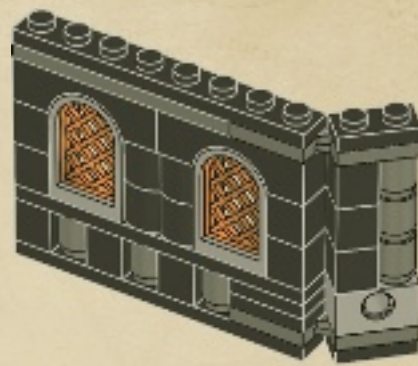

9

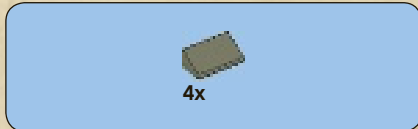
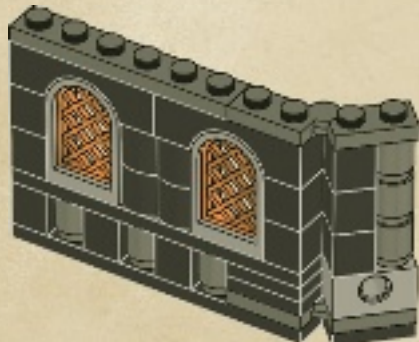

11



67

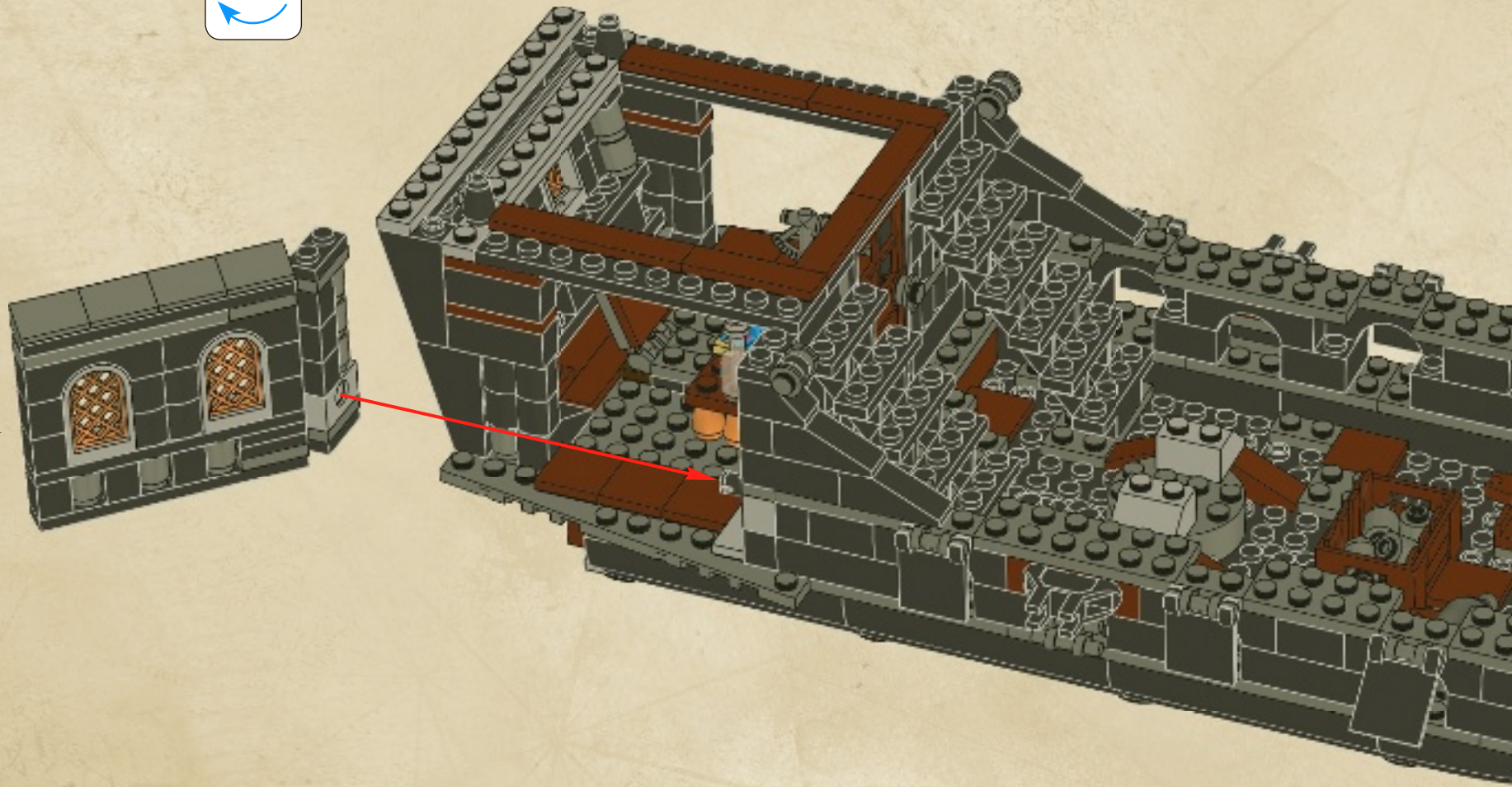



1x

68

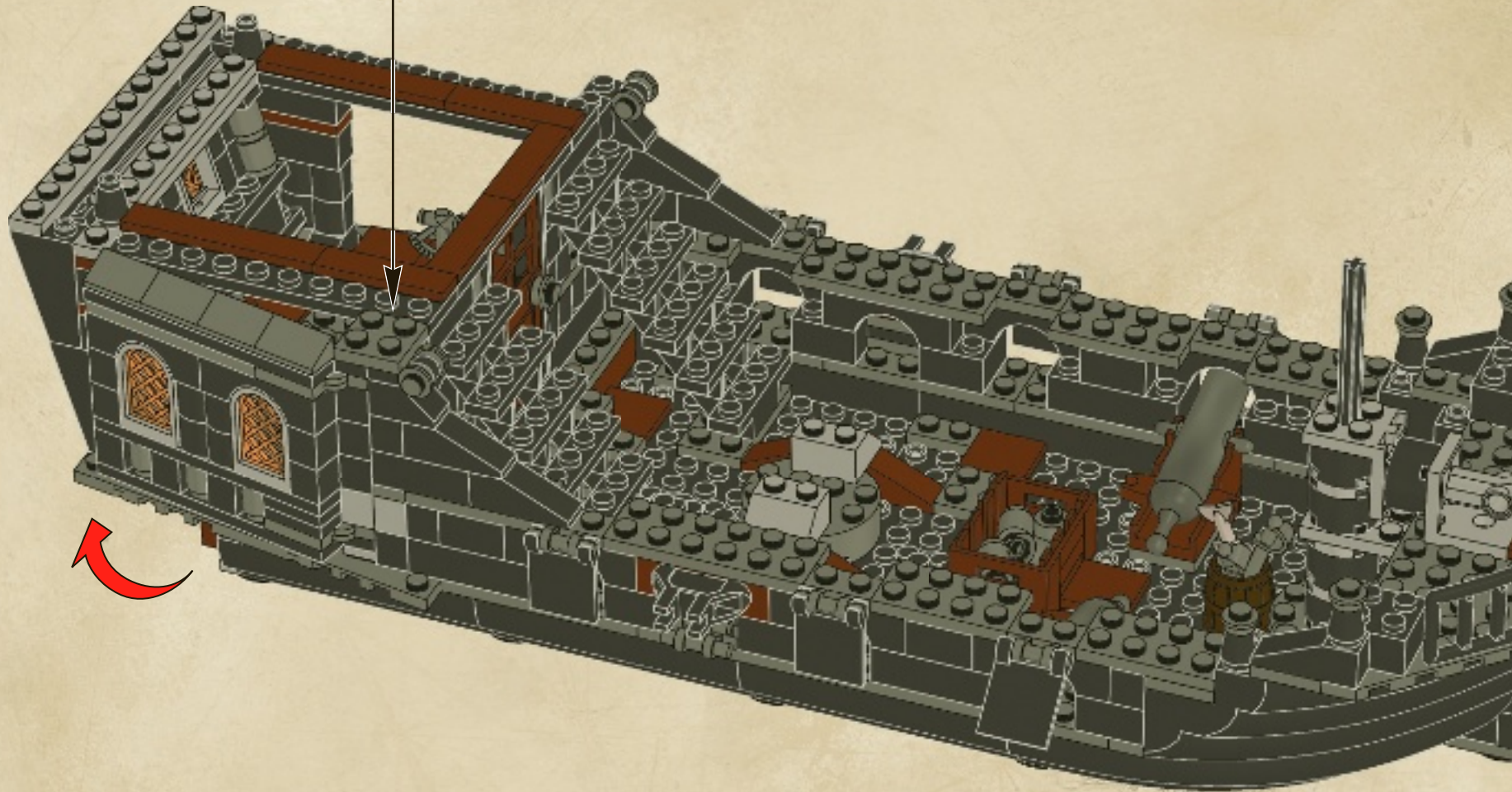

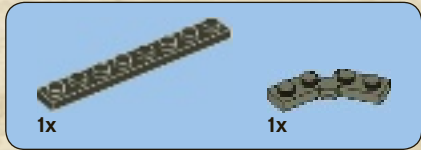

1

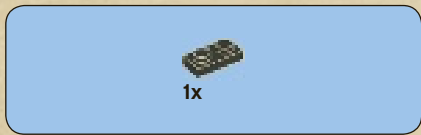
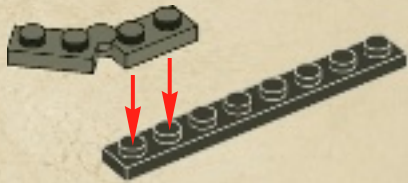

2

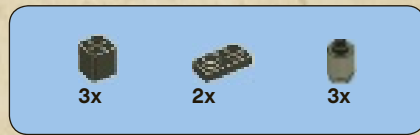
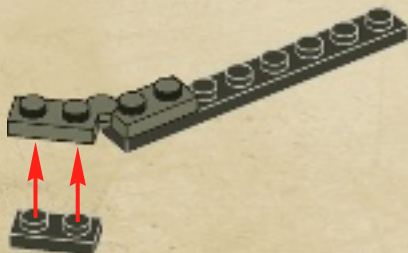

3

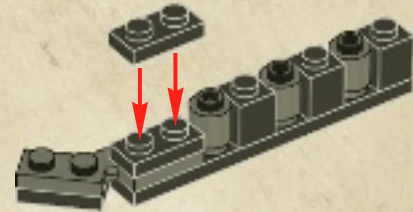

4

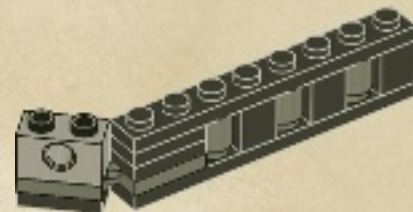



5

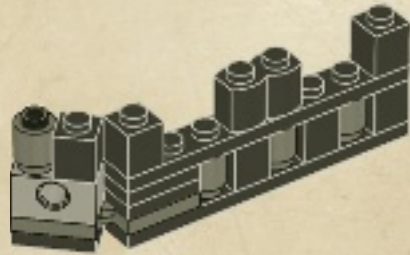

6

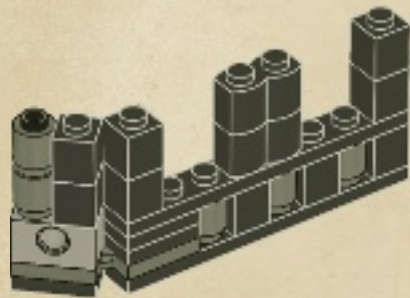

7

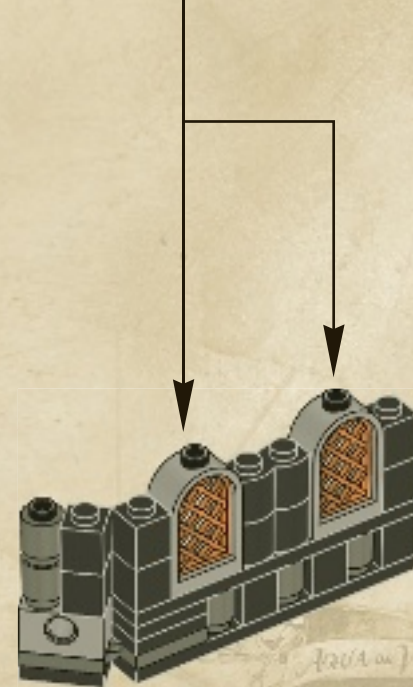

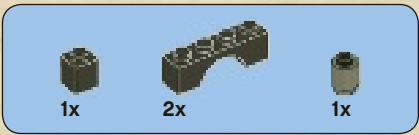

8

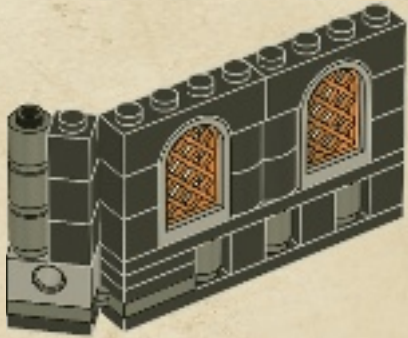

9

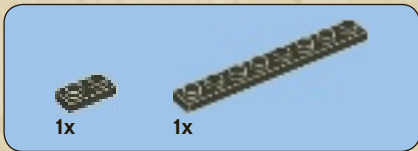
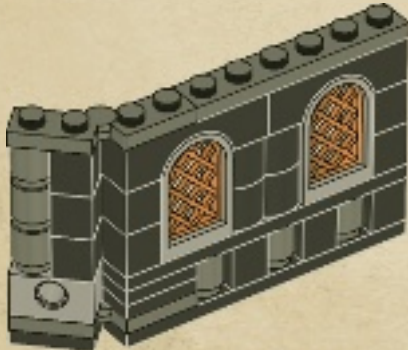

10

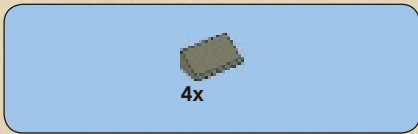

11

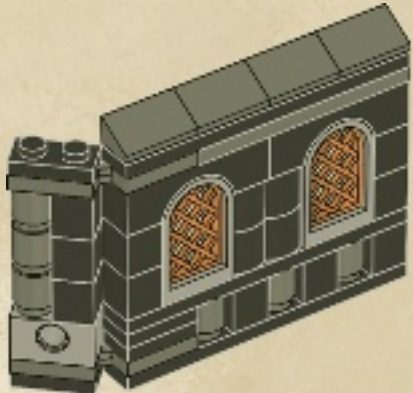

69

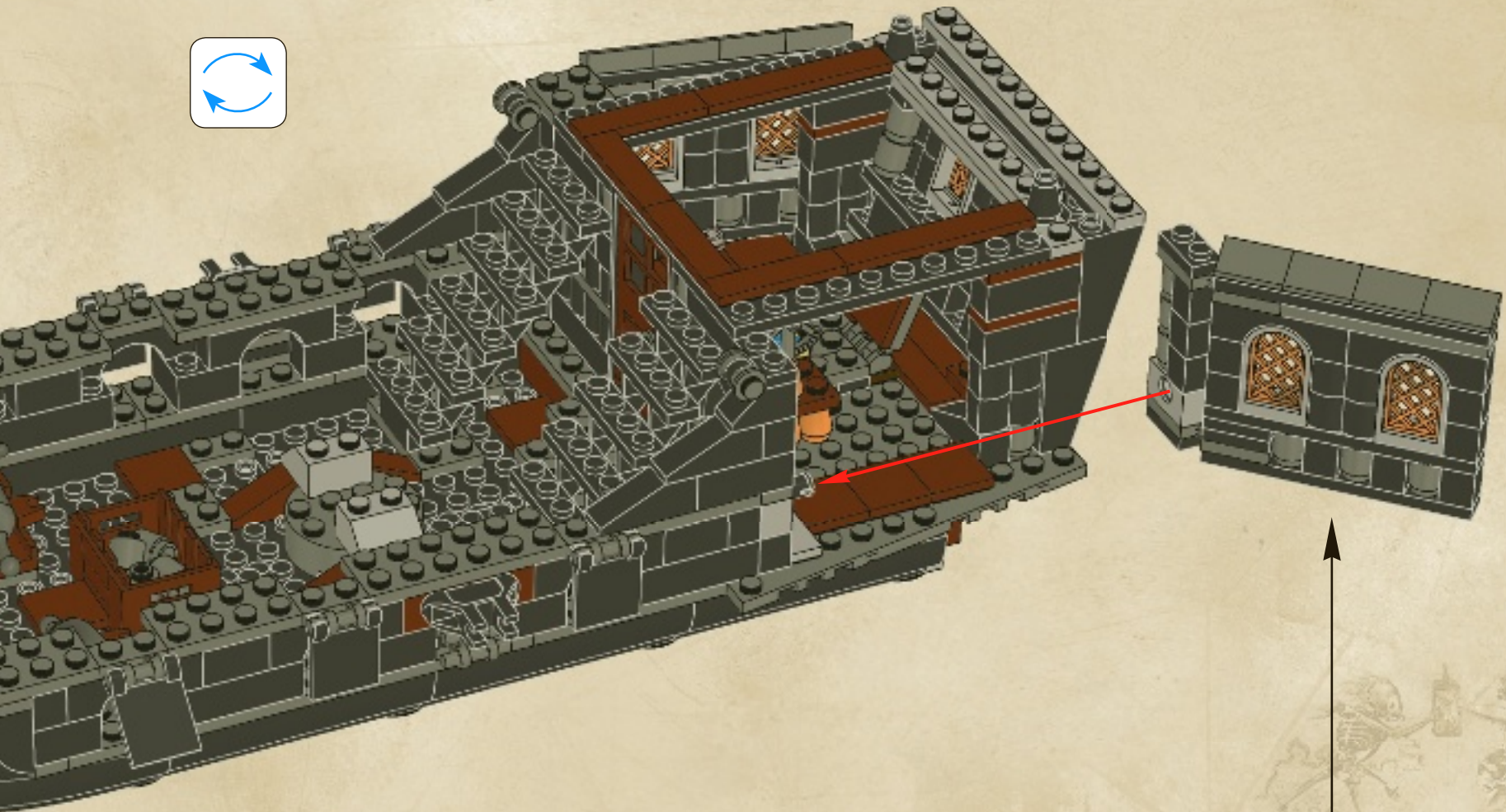

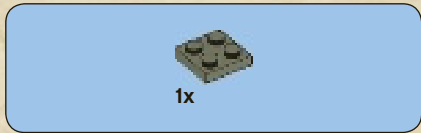

70

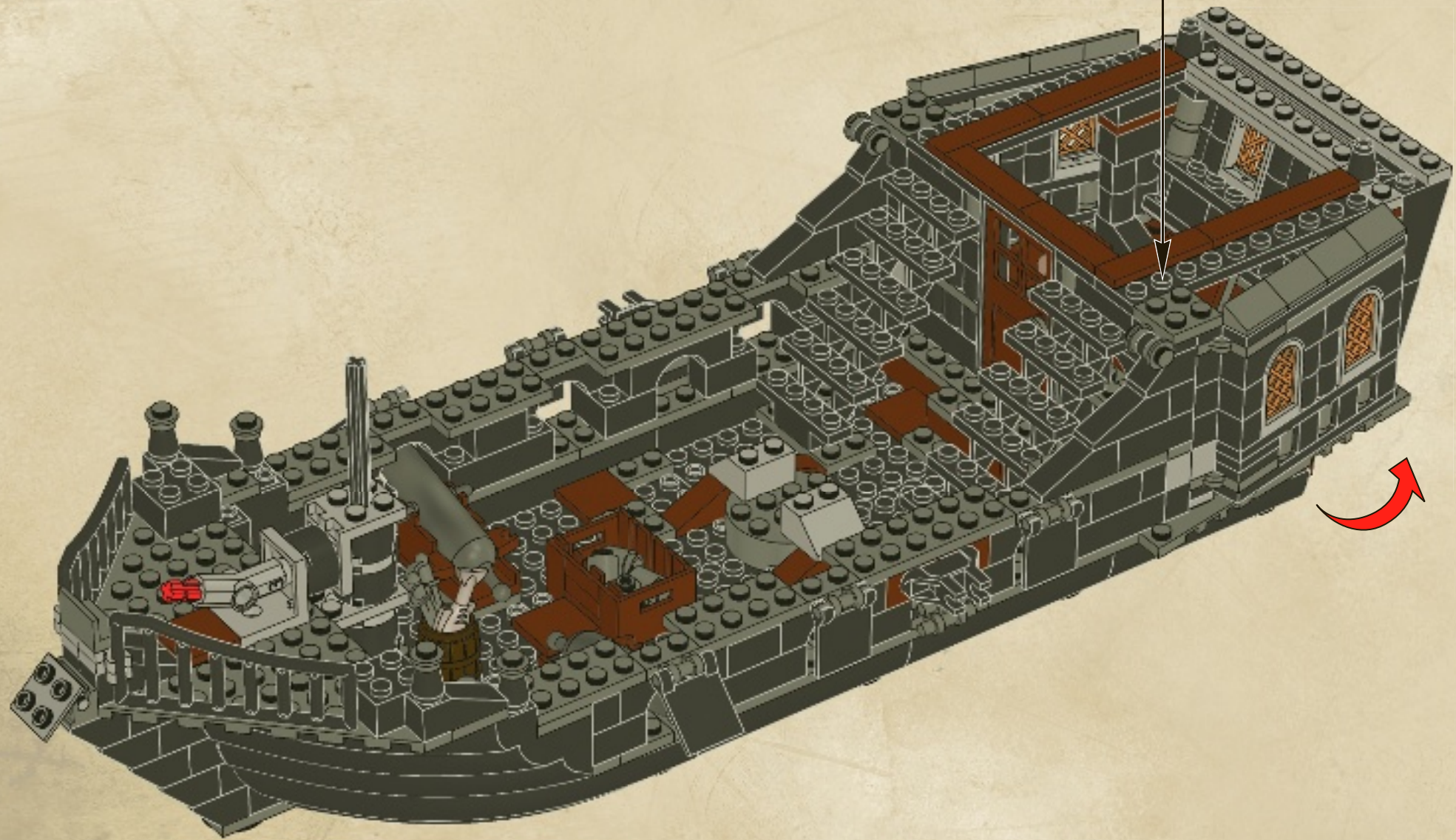
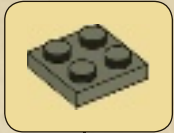

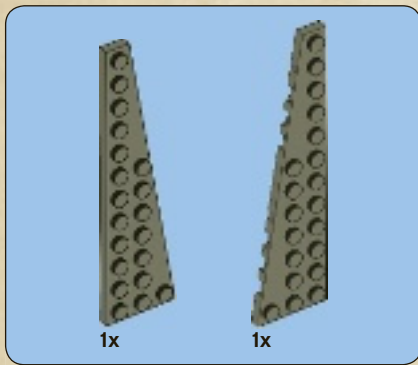

71

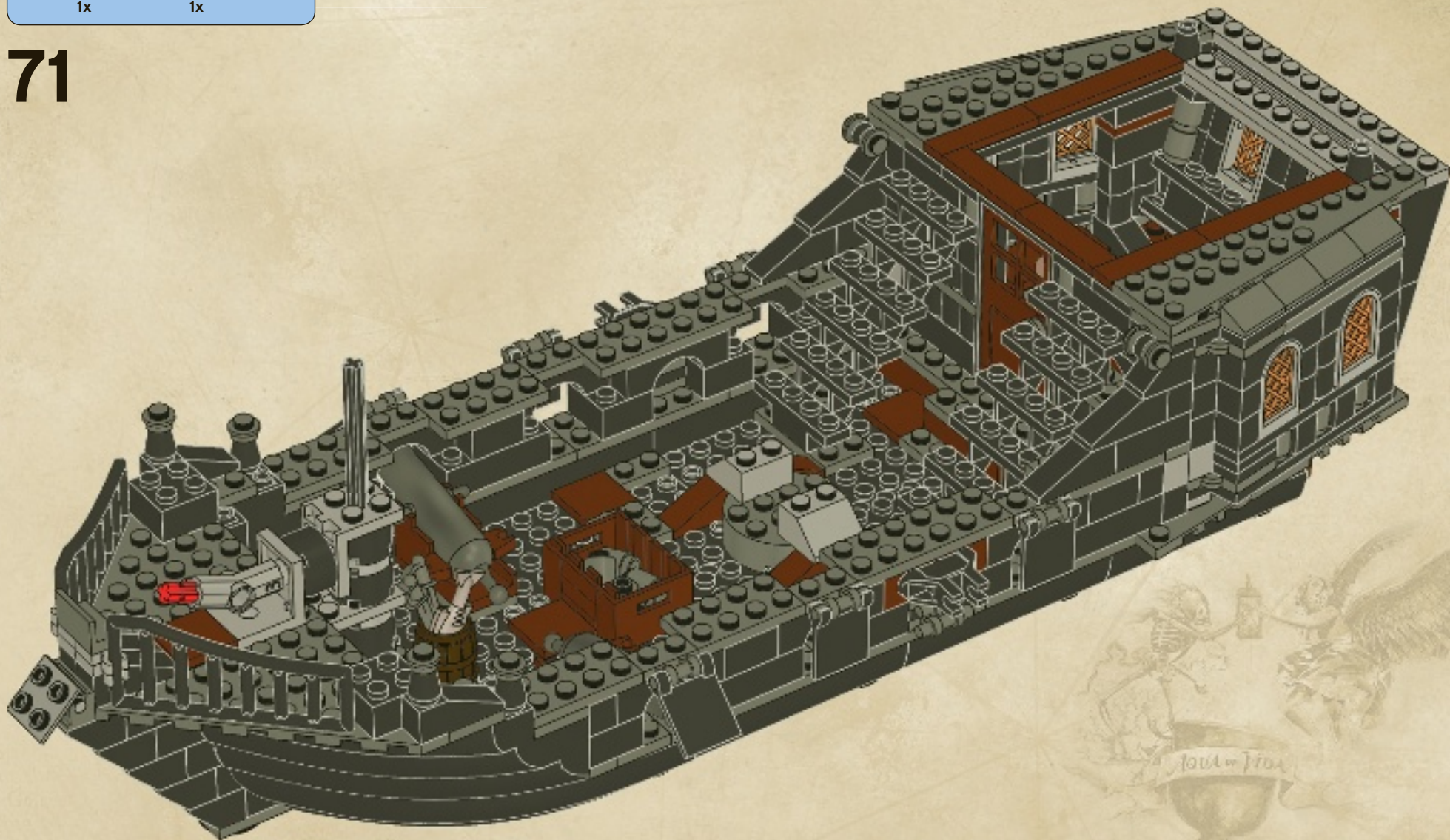

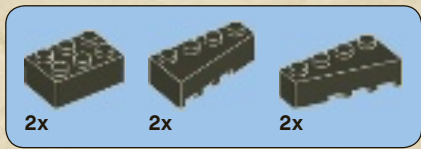

72

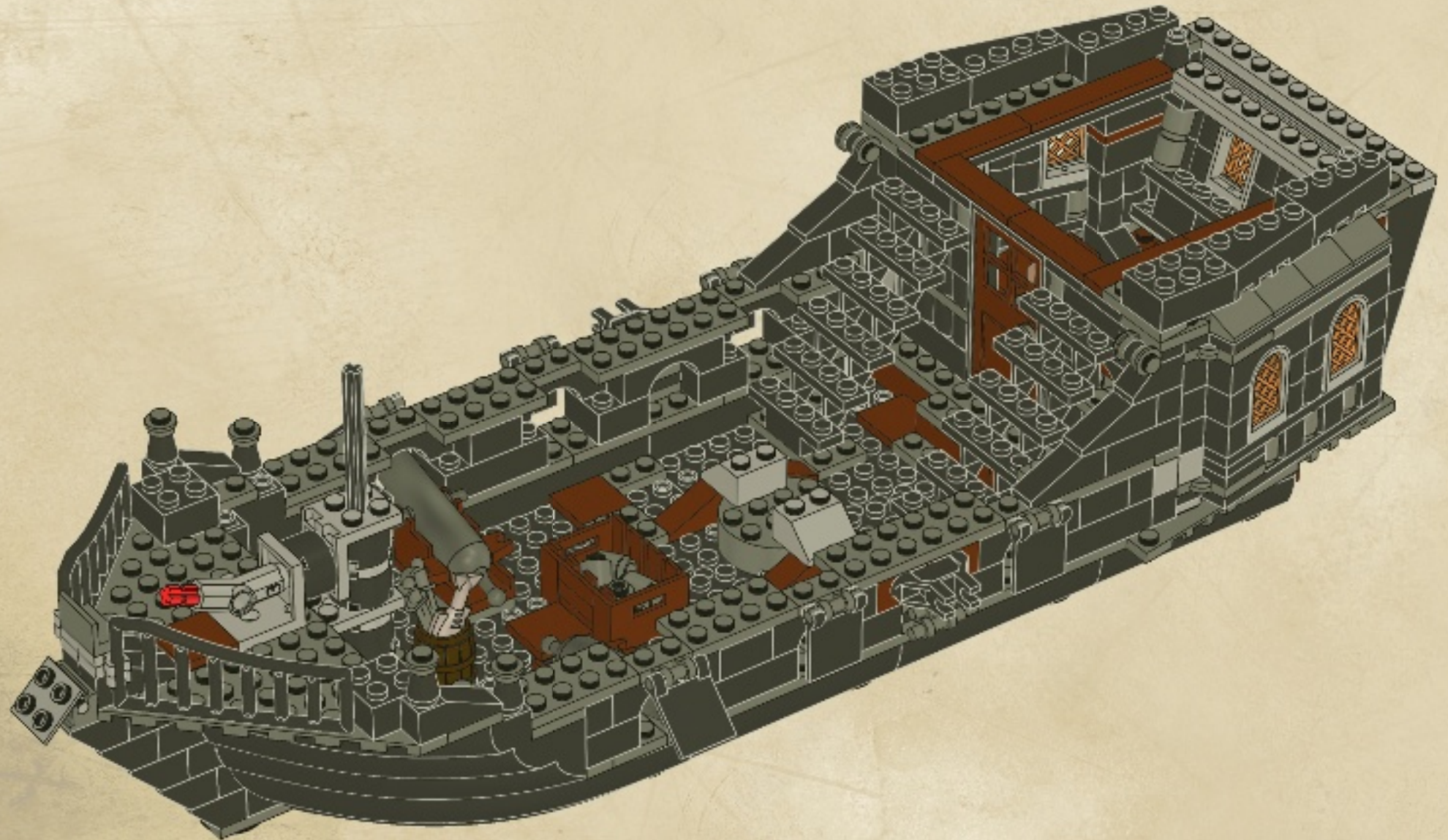



73

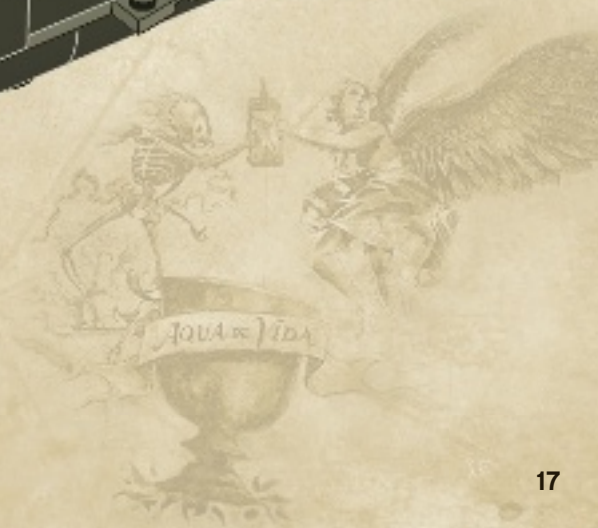
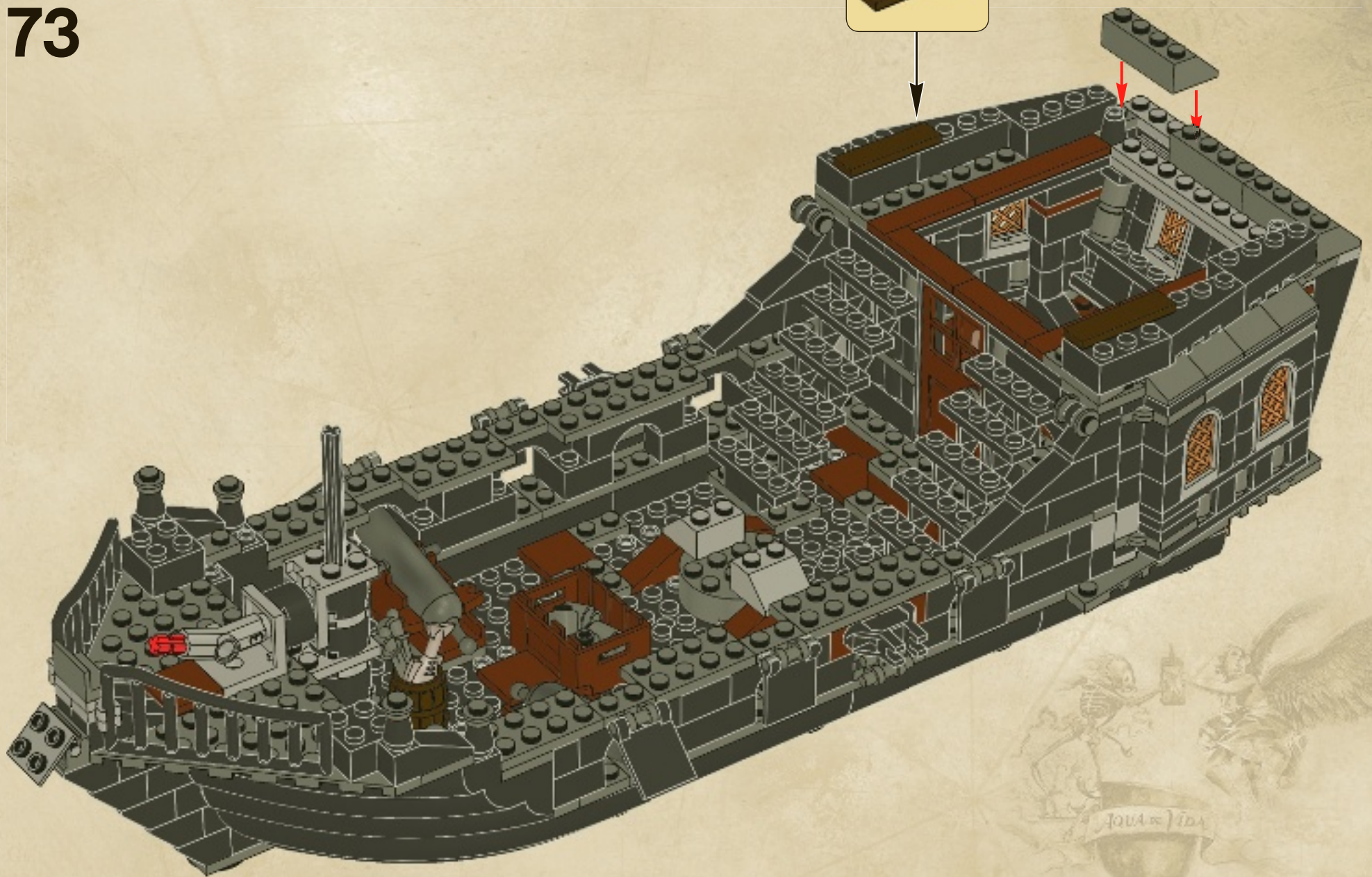
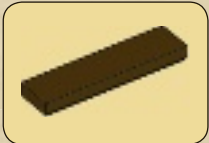

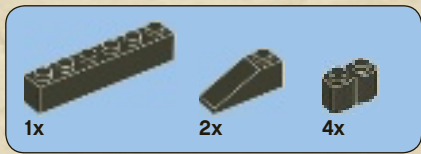

74

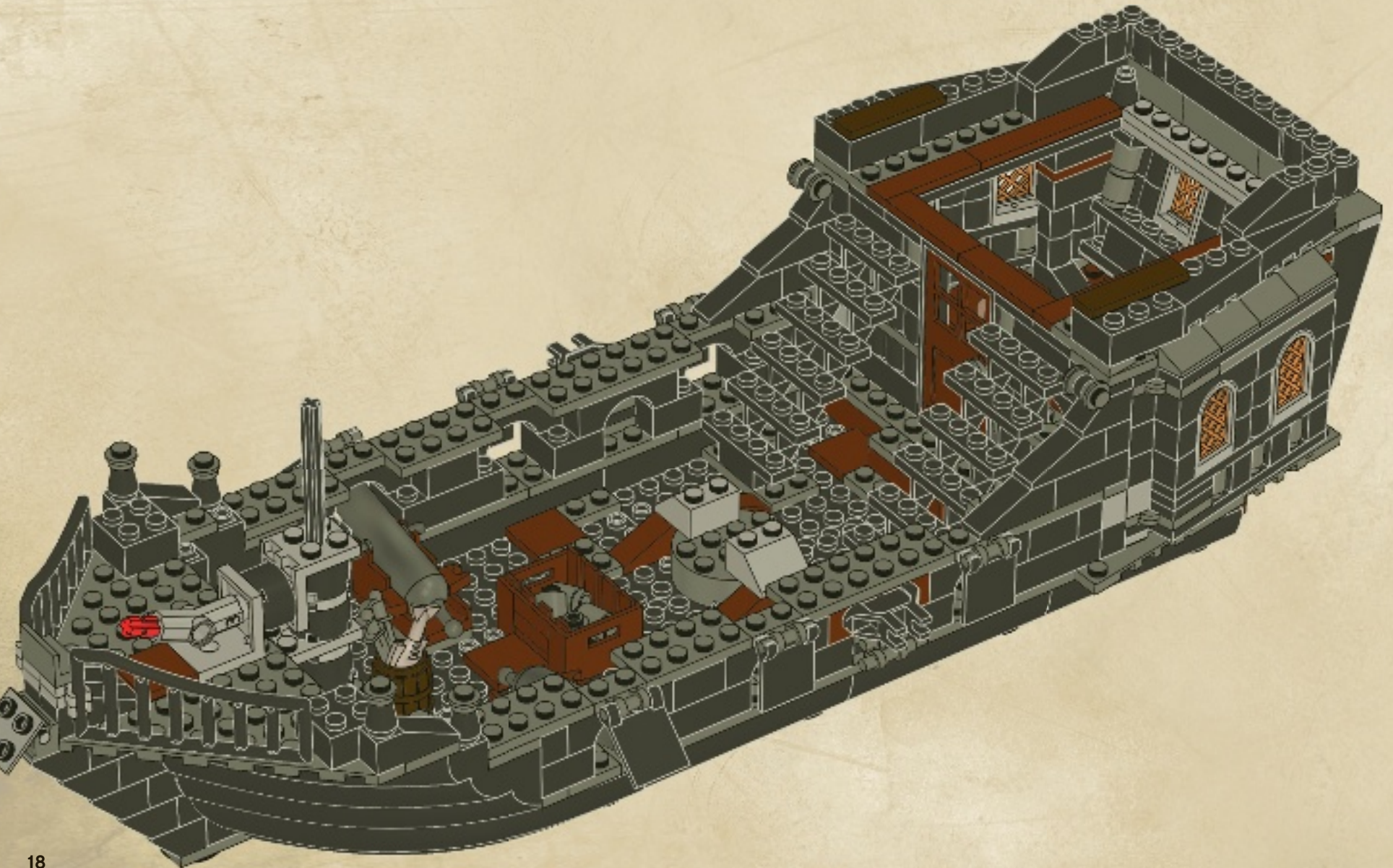

- 2x
- 2x
- 3x
- 2x

75

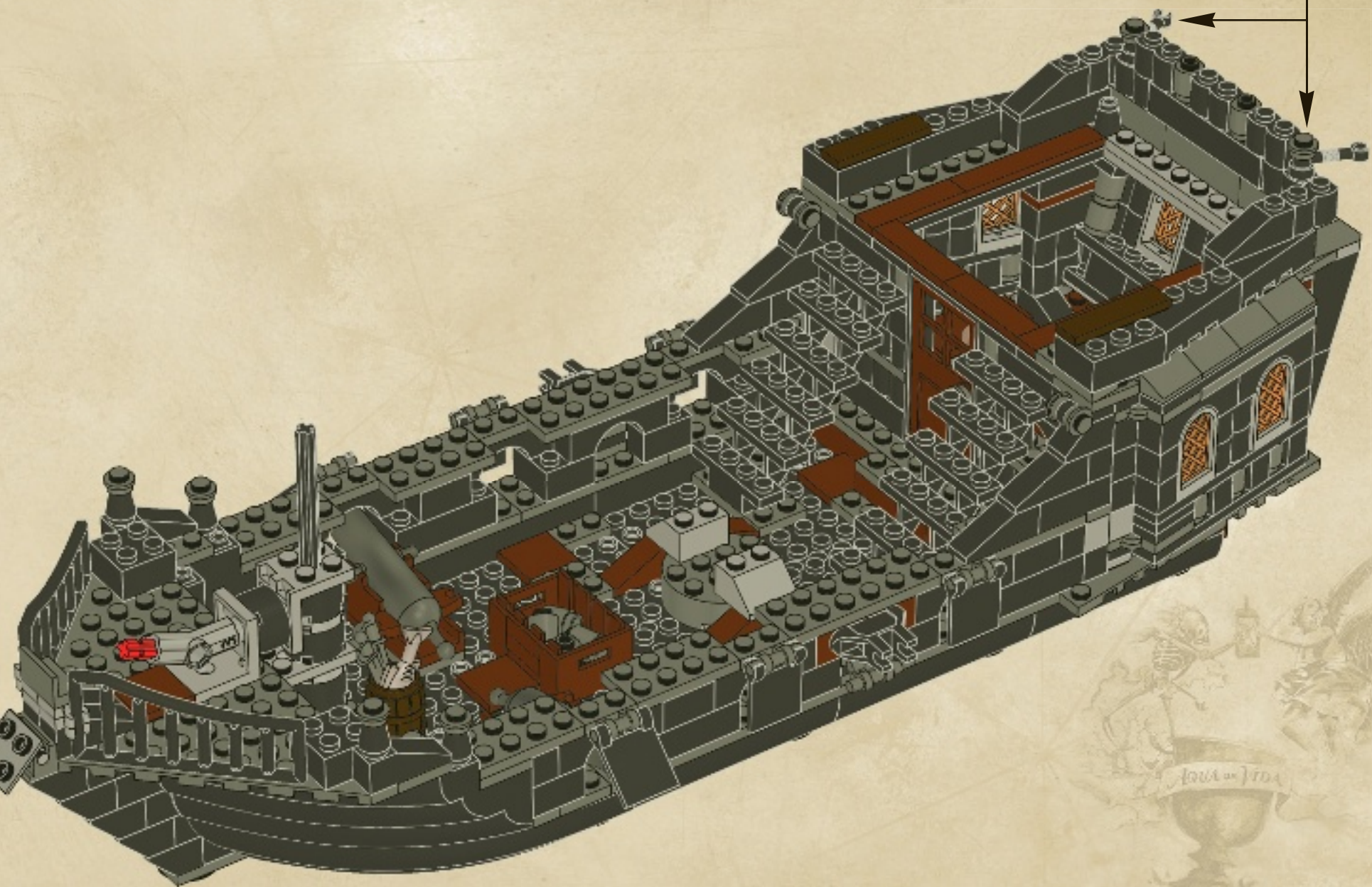
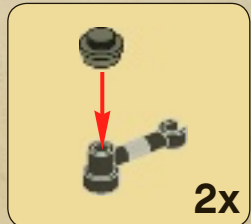



2x

76

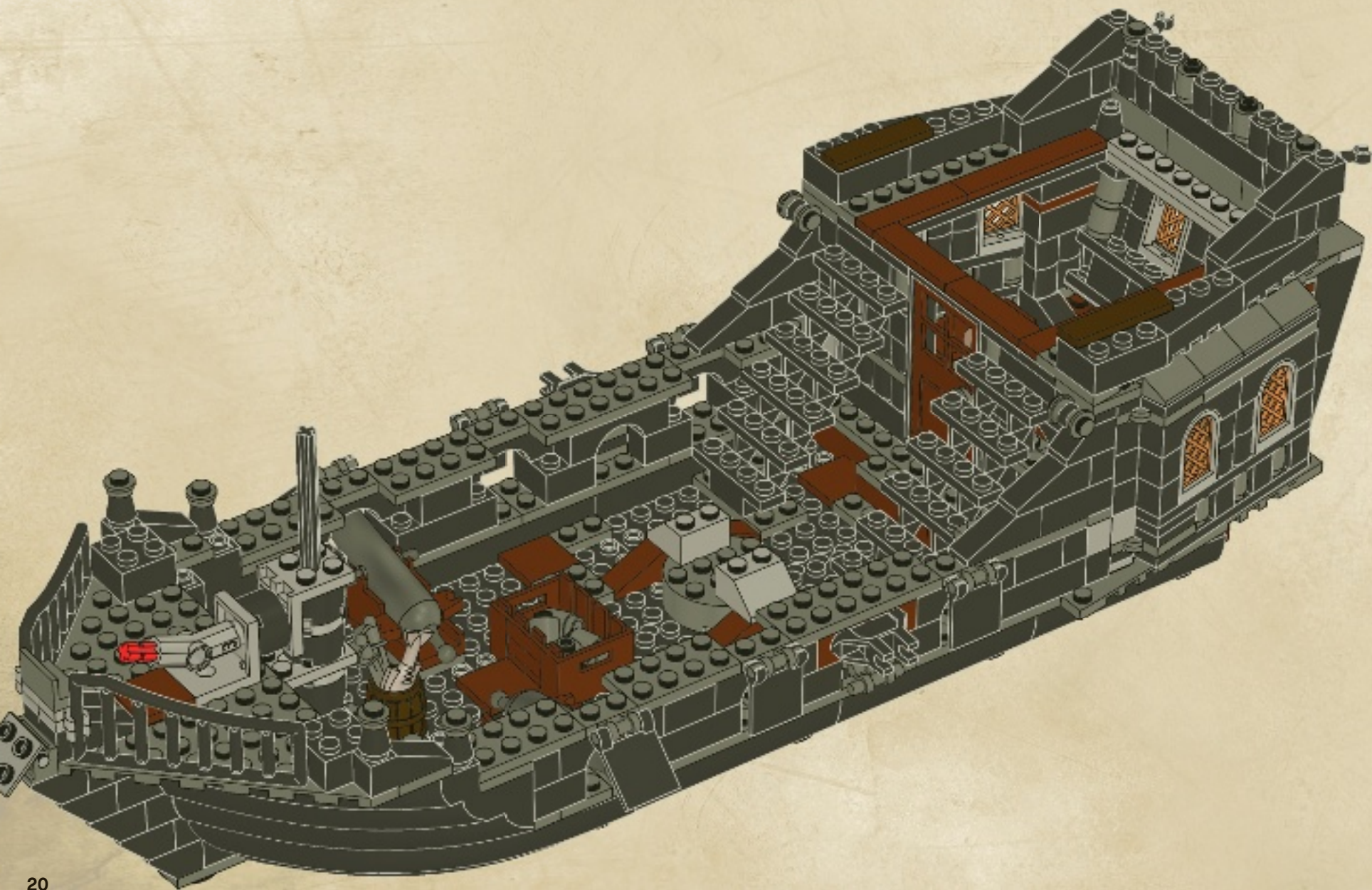

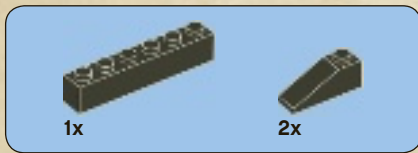

77

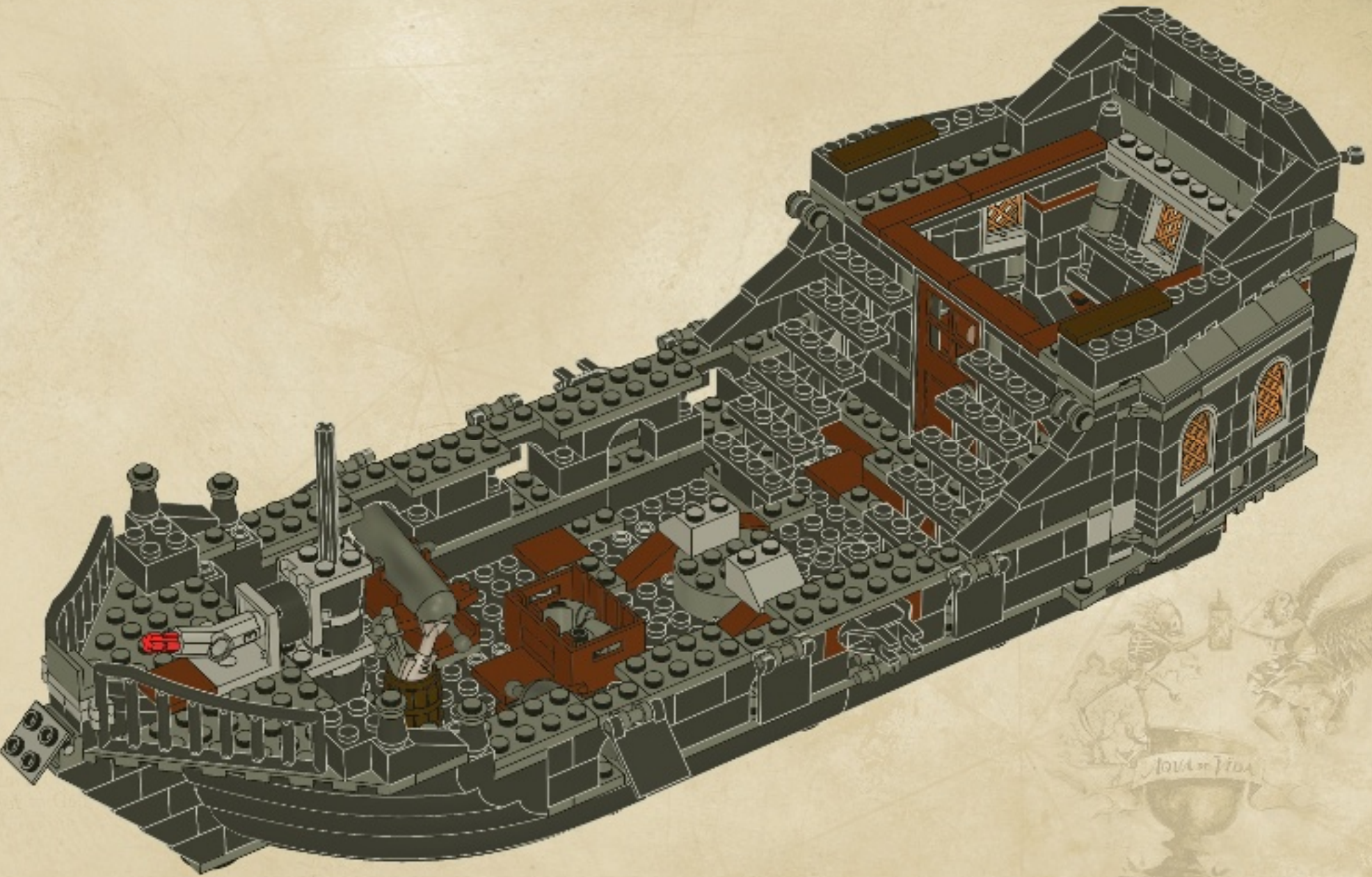

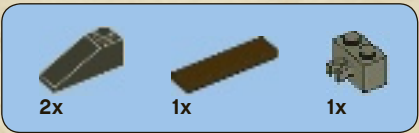

78

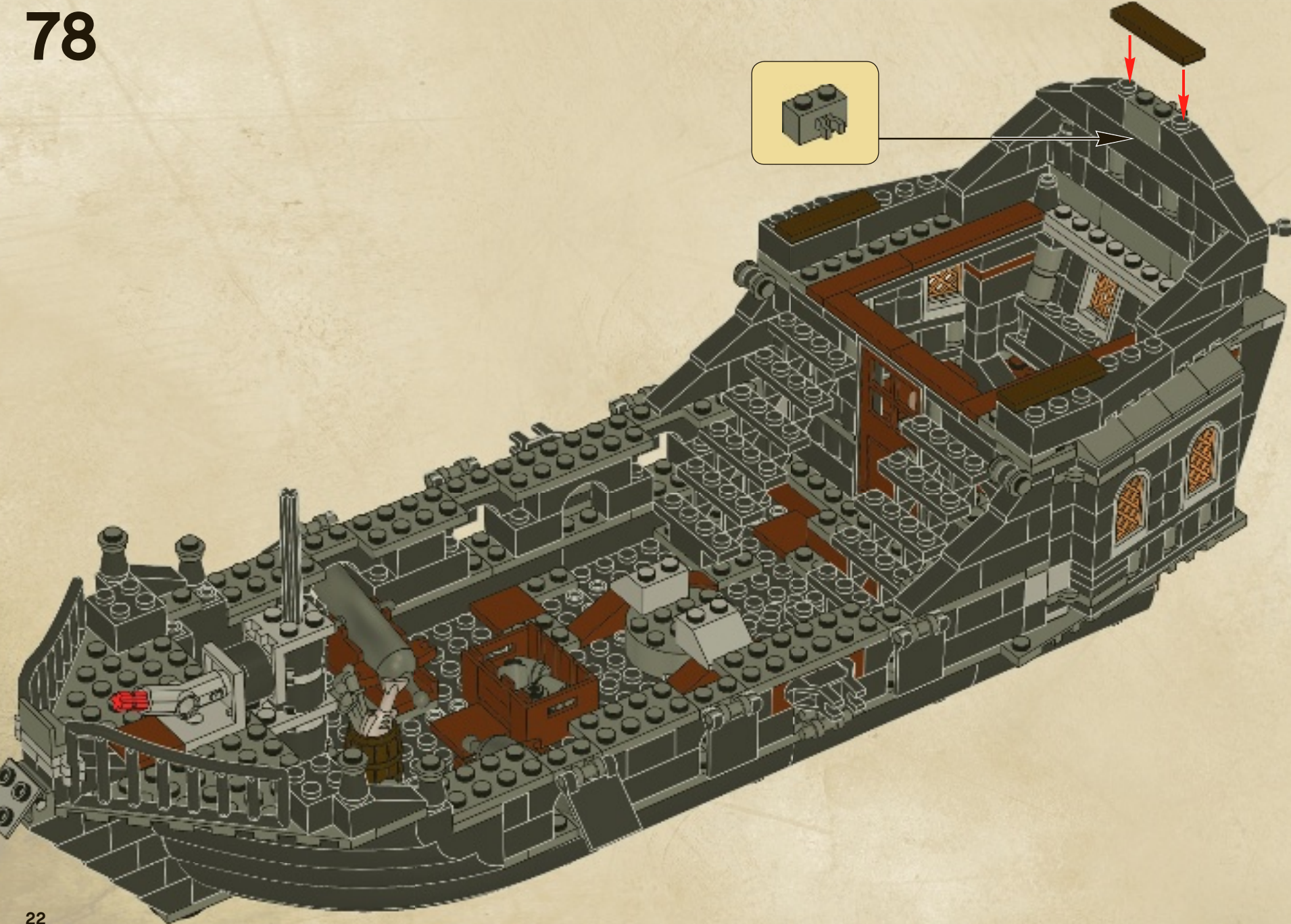



+

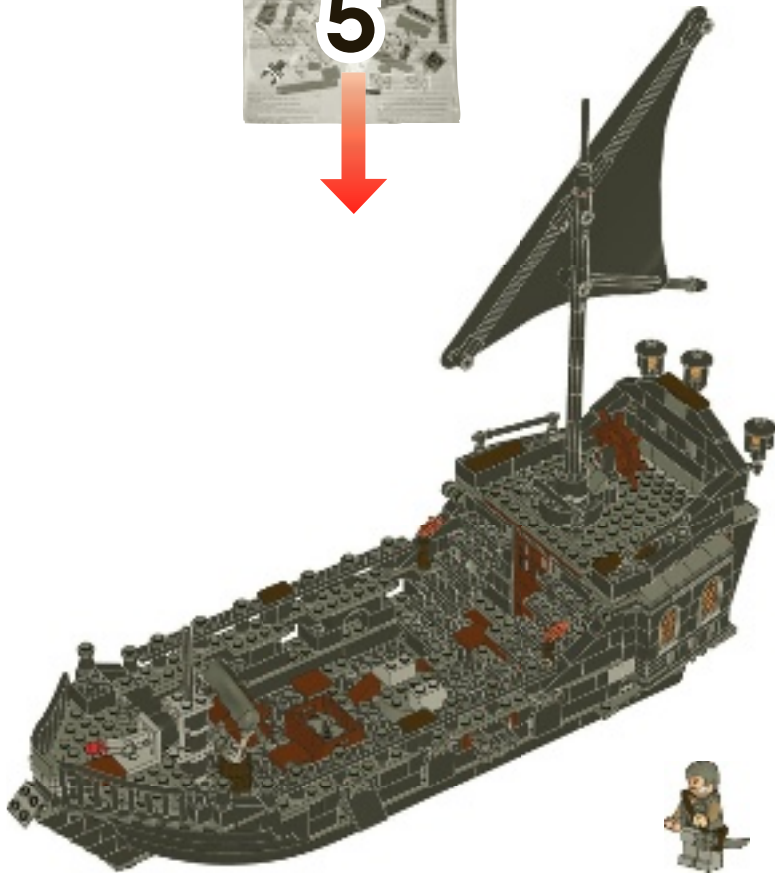

1

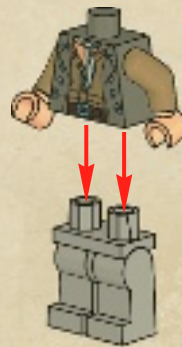

2

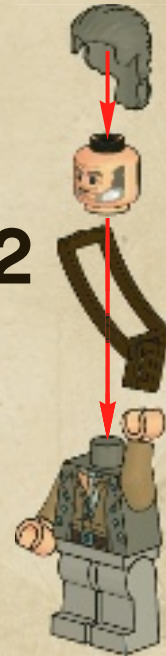

3





4x

79

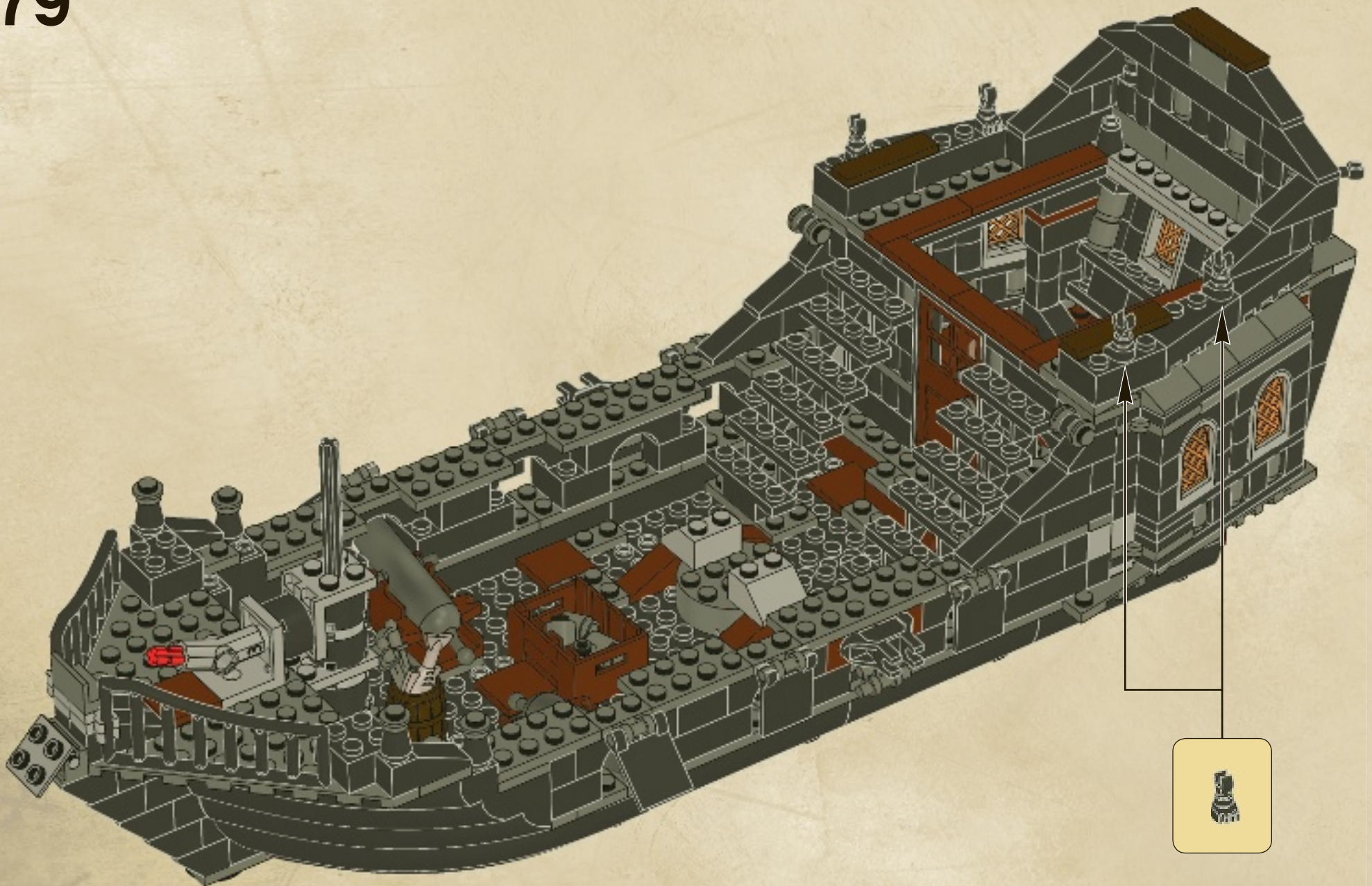

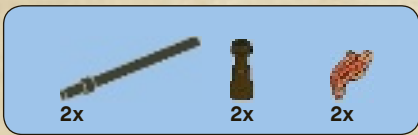

80

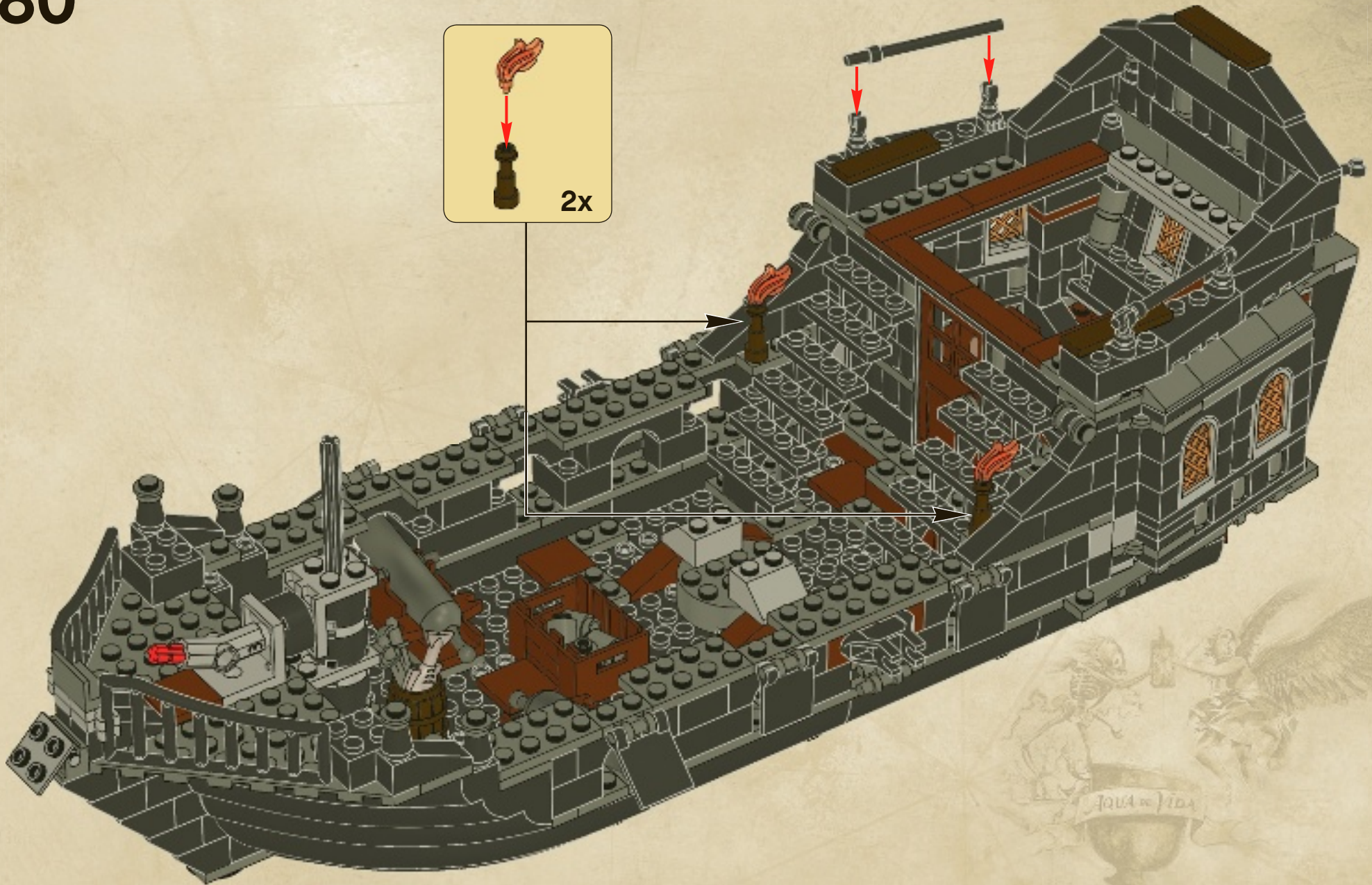

12x 2x

81

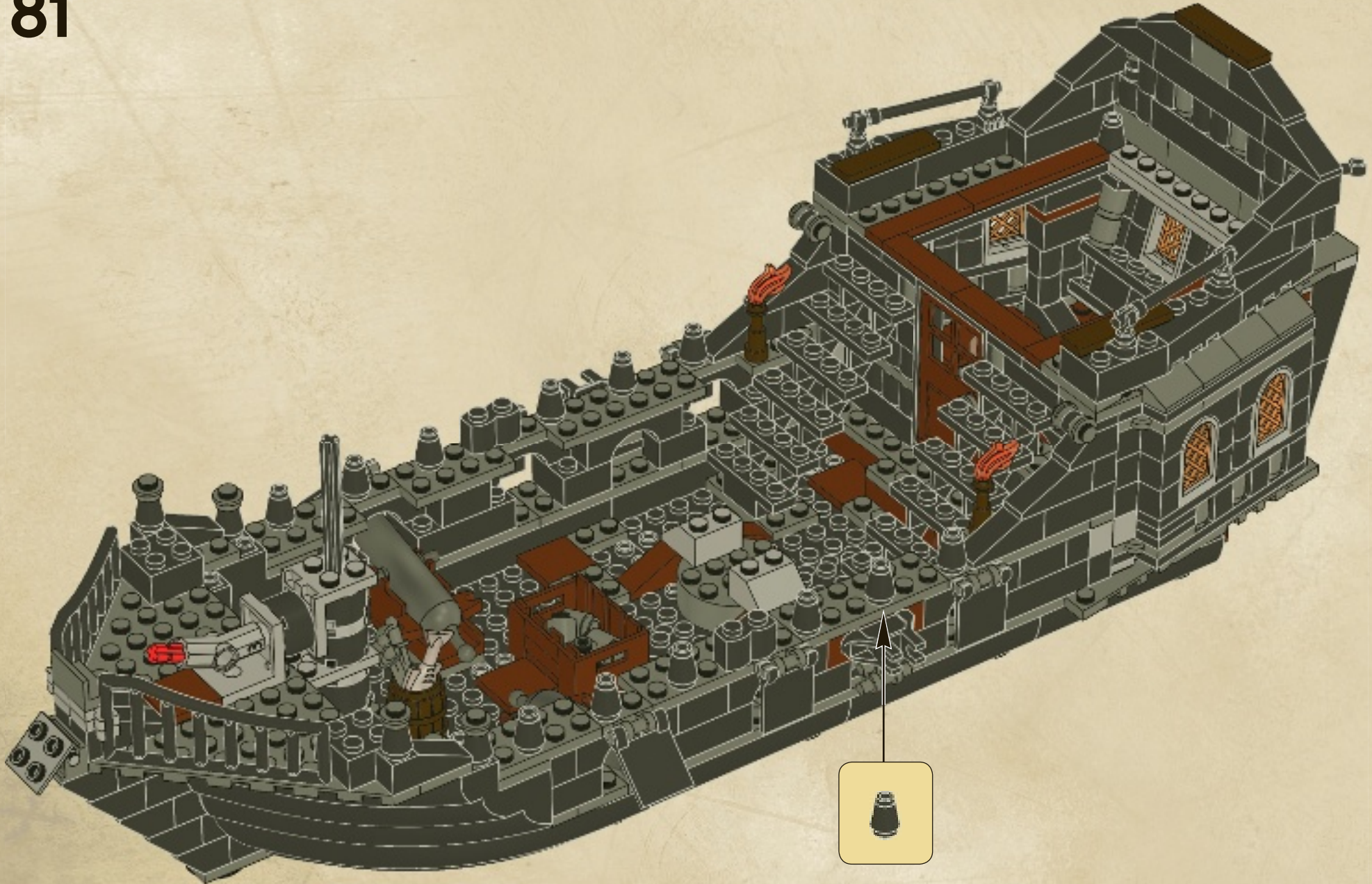



82

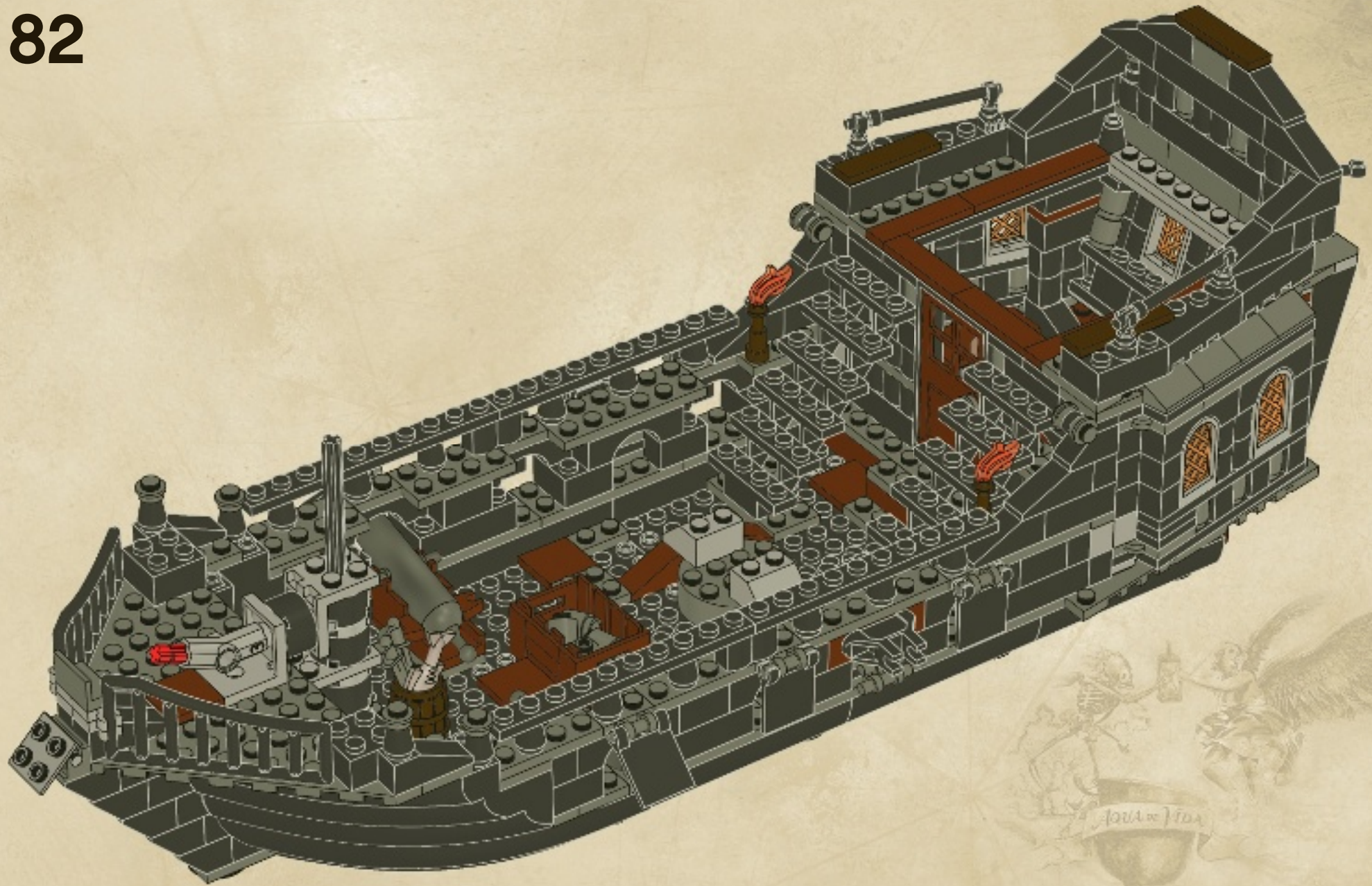

12x

2x

83

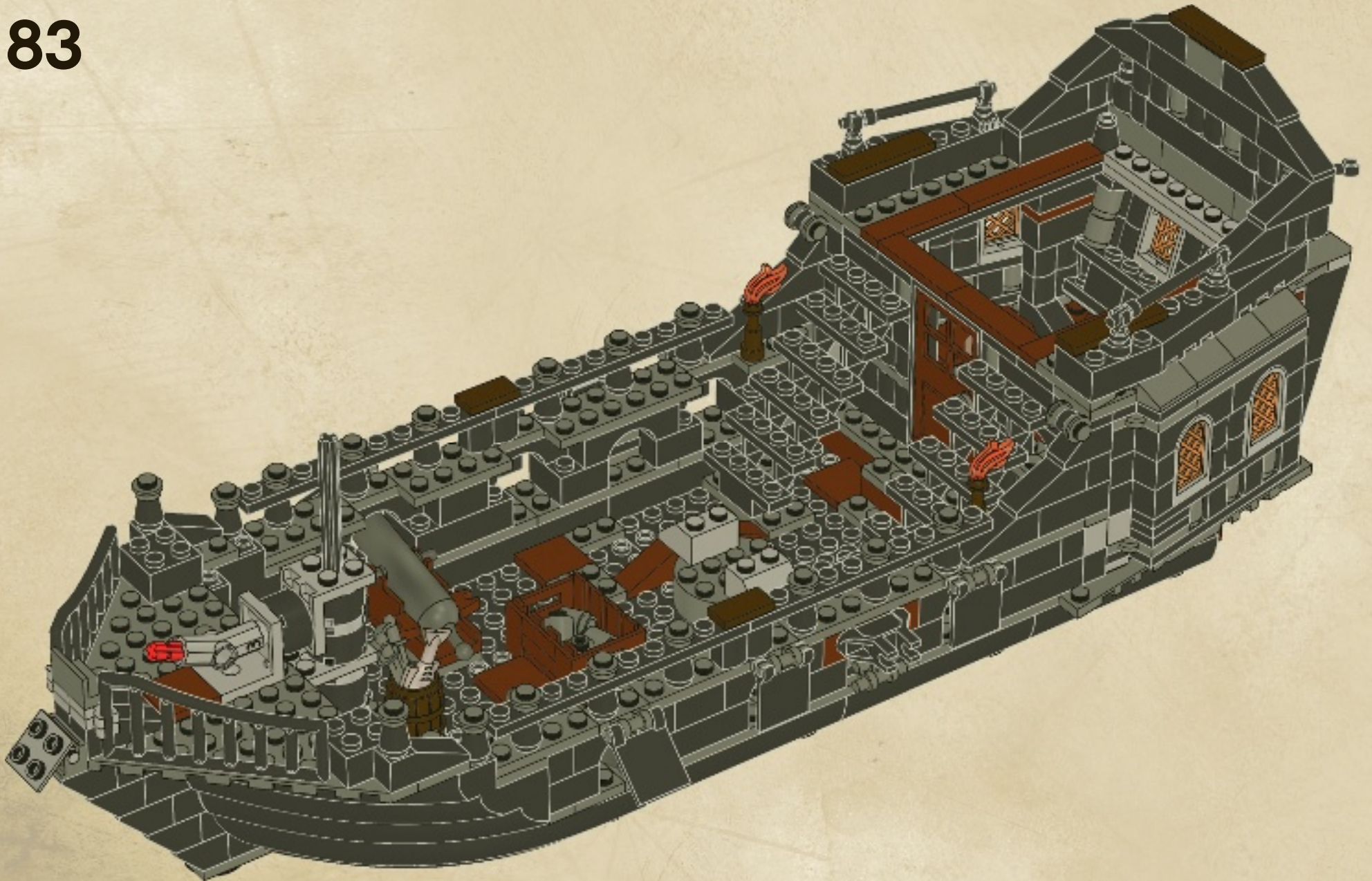

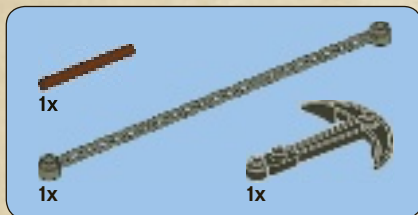

84

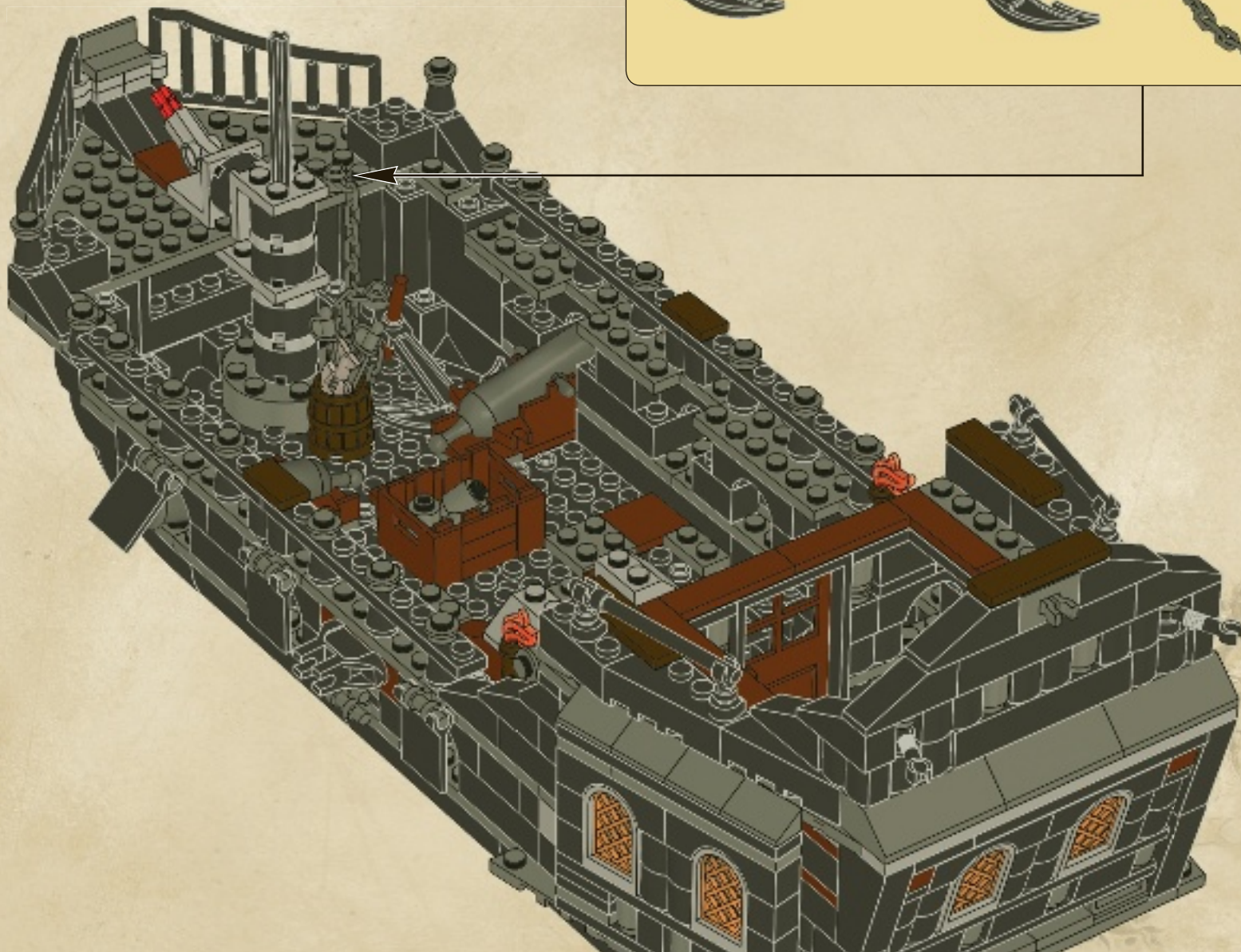

3x 3x 3x

85

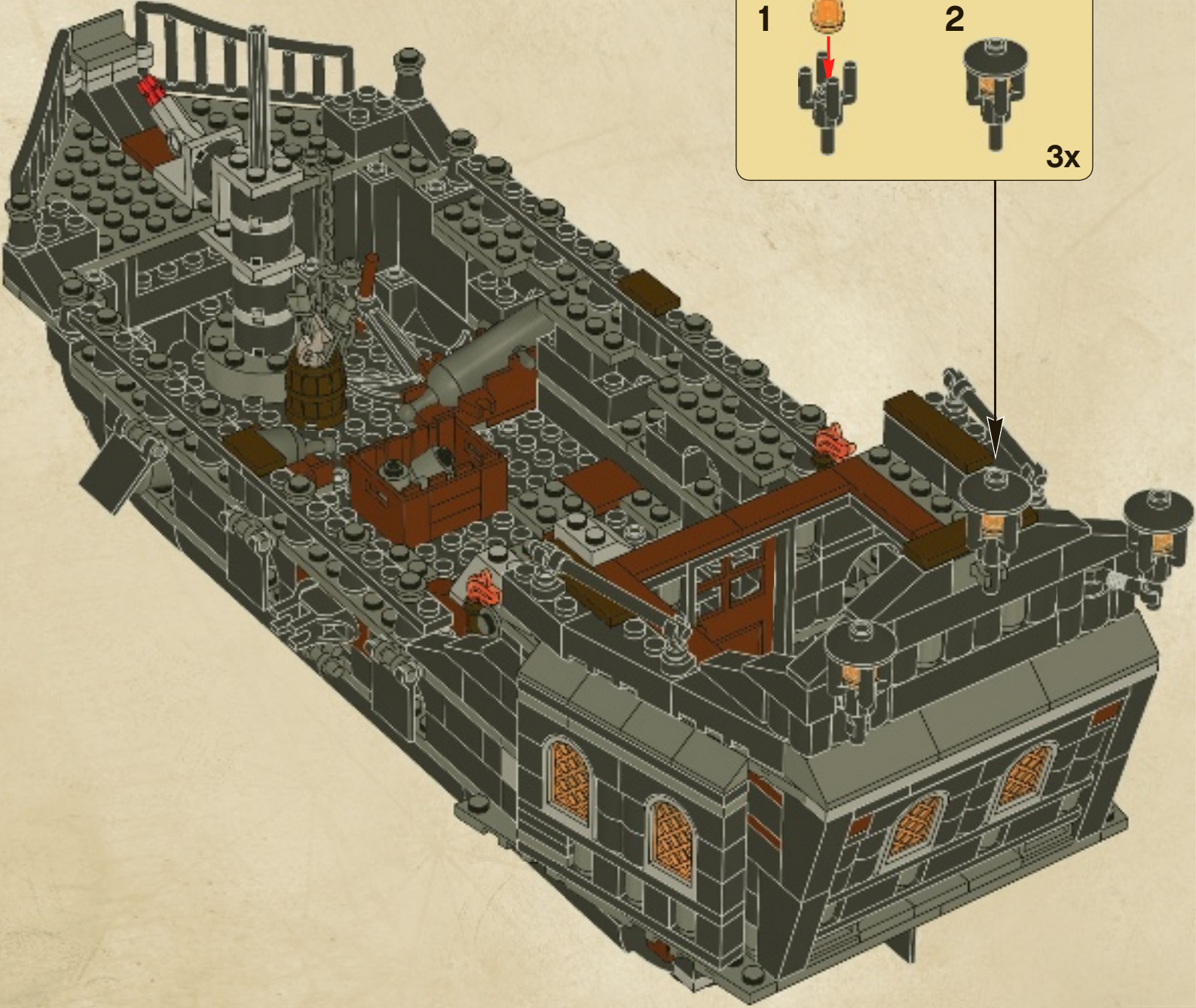

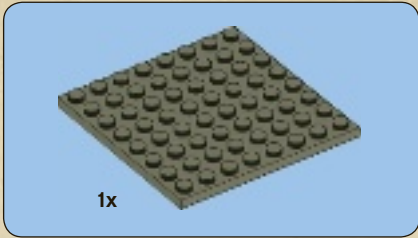
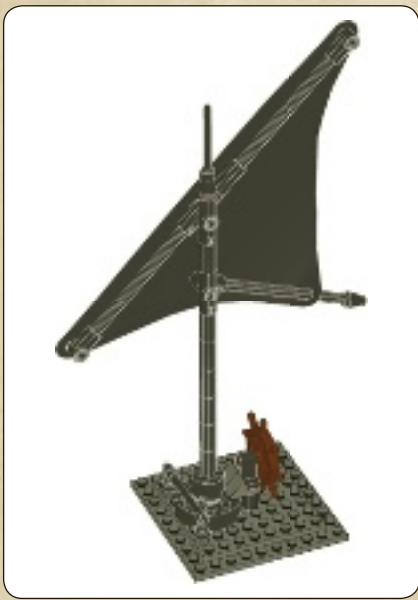

1

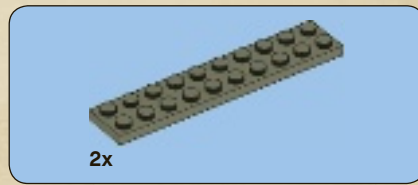

2

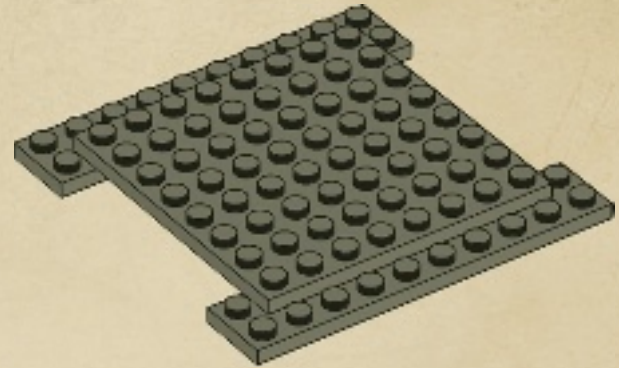

3

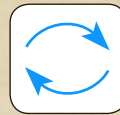



4x

4

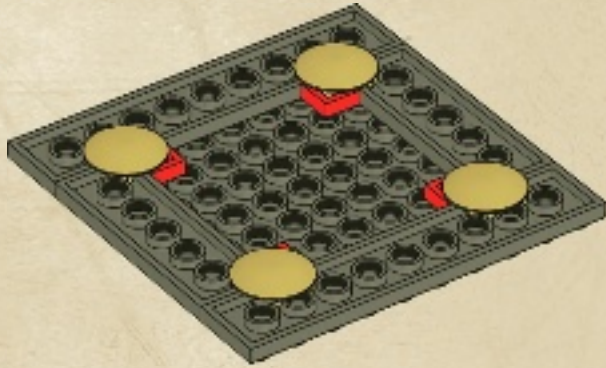

1x



1x

5

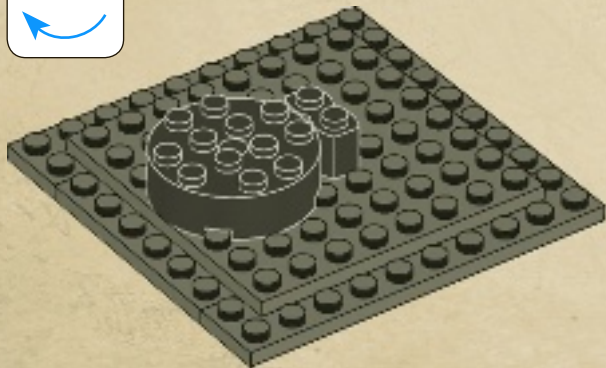

1x



2x

6

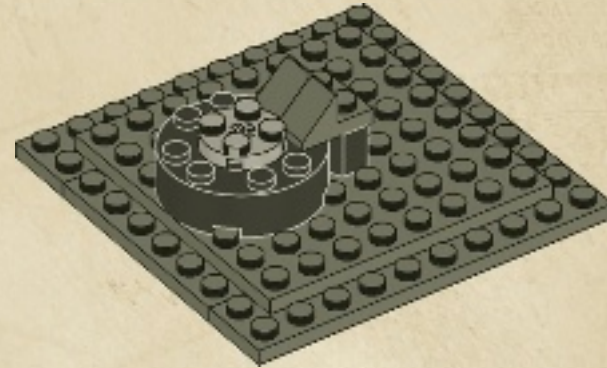

1x





1x

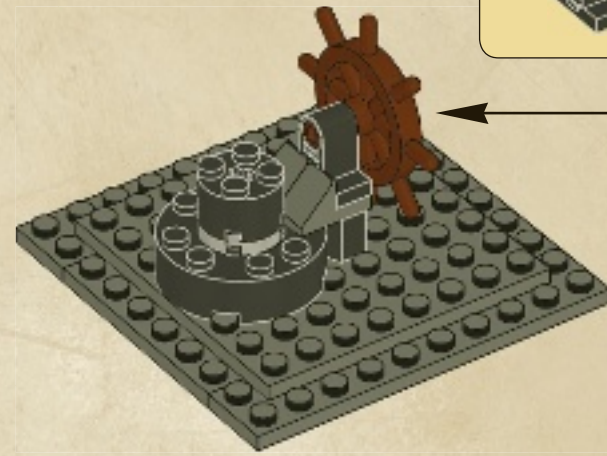
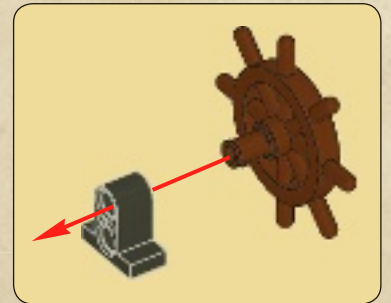

1x

7





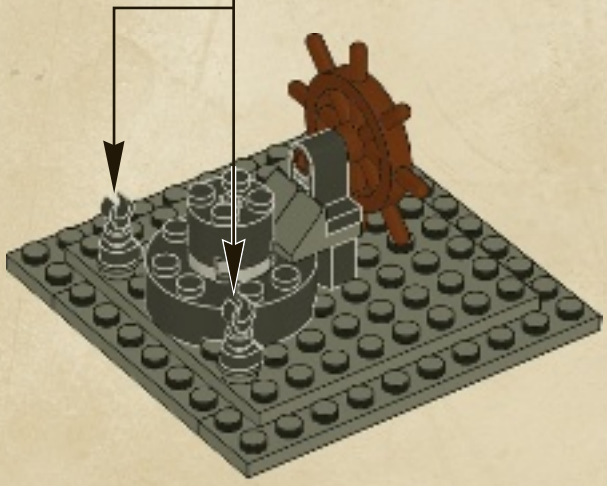

2x  2x 

8



  2x



1x  1x  4  1x 

 4 1:1

9

   4

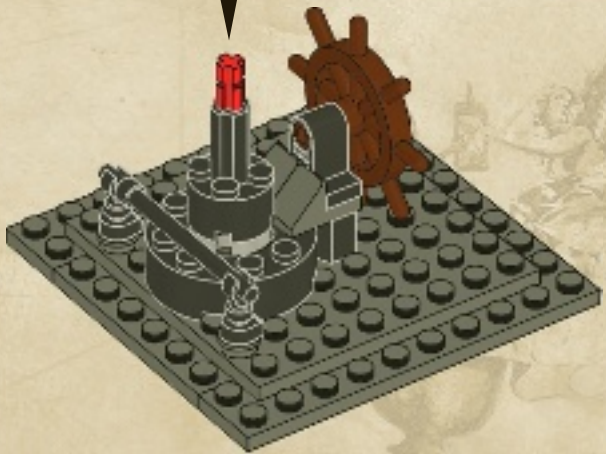

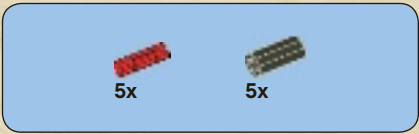

10

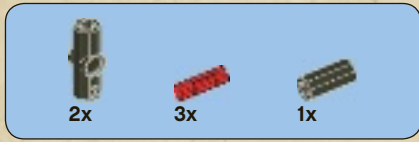
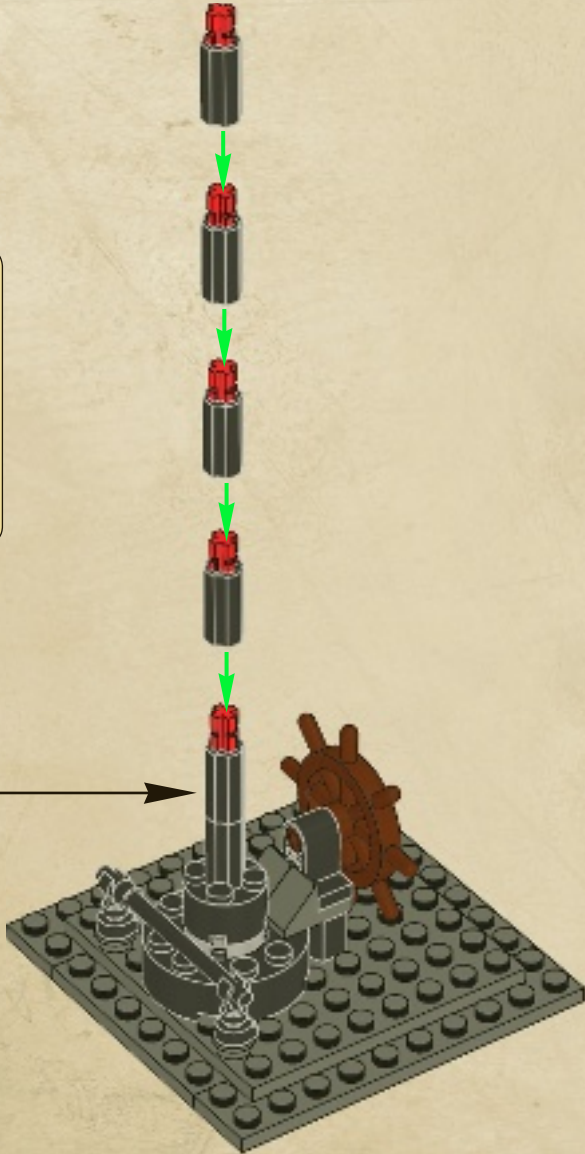
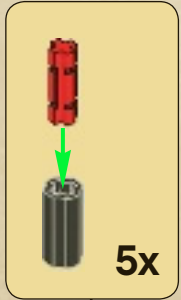

11

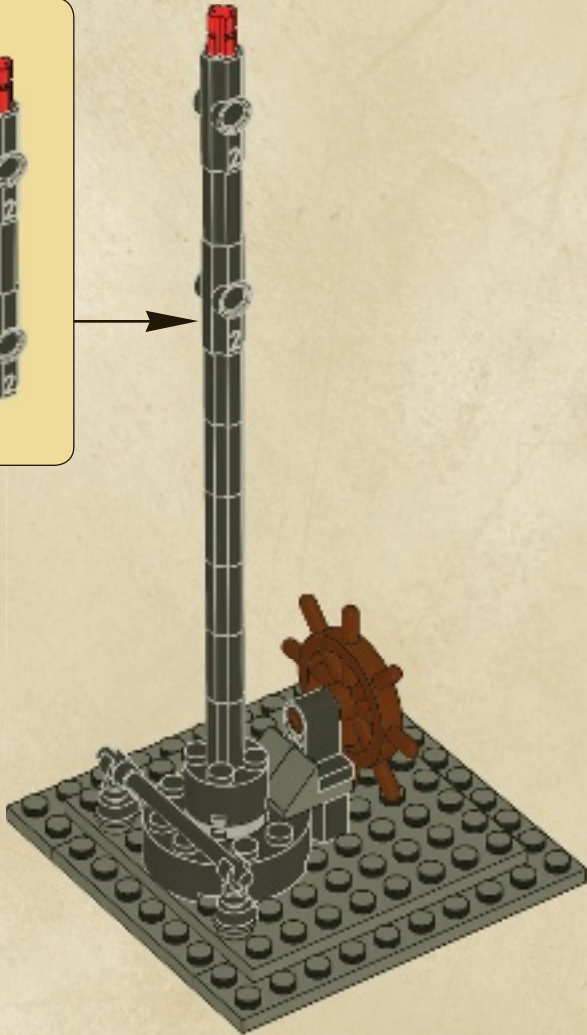
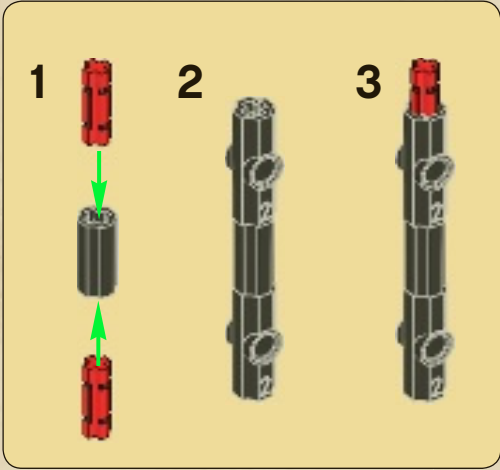



12

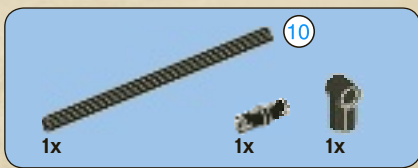

13

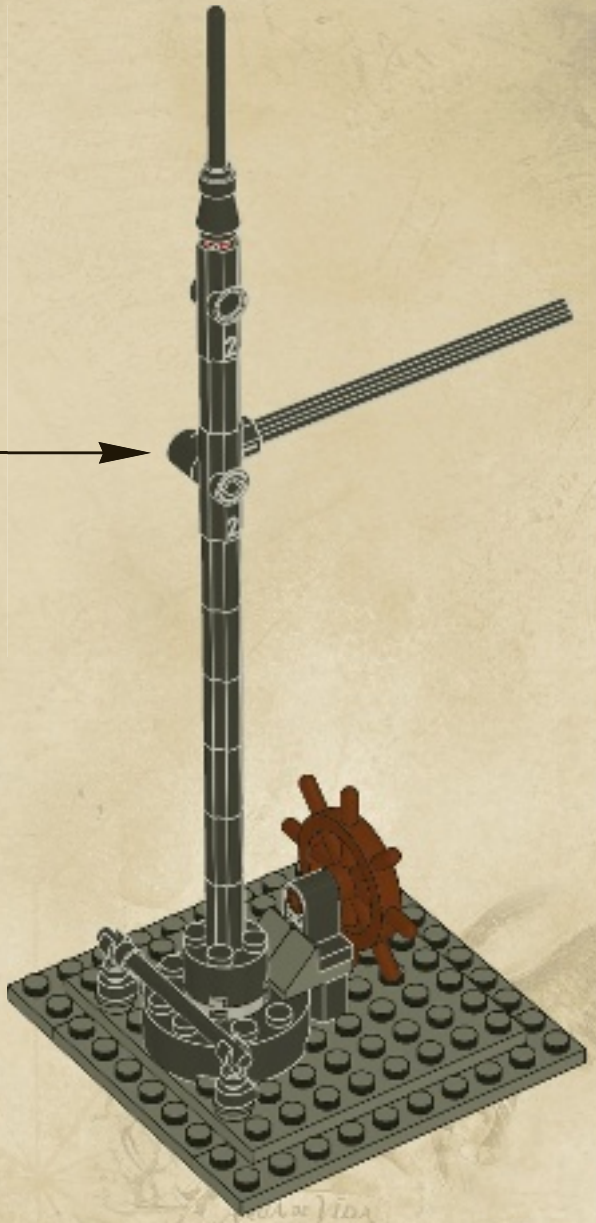
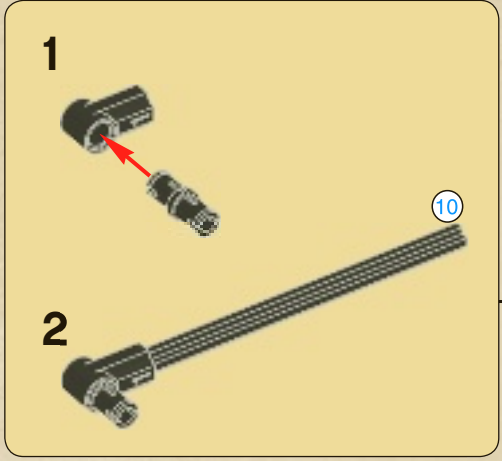

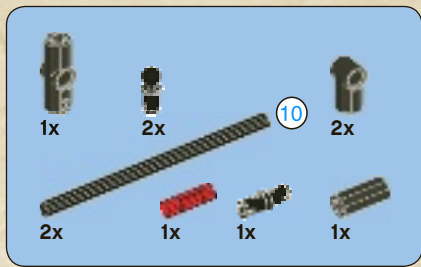

14

1



2

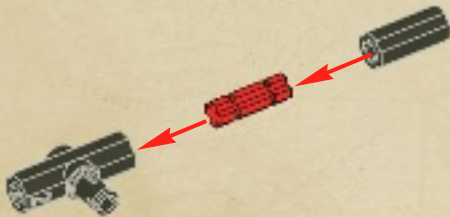

3

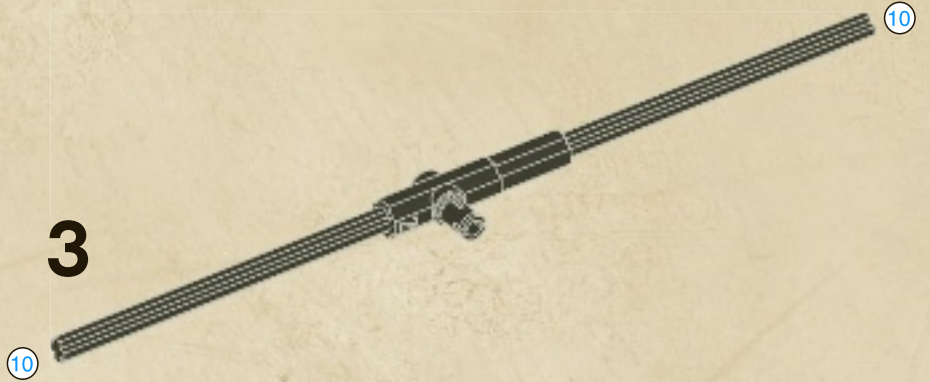

4

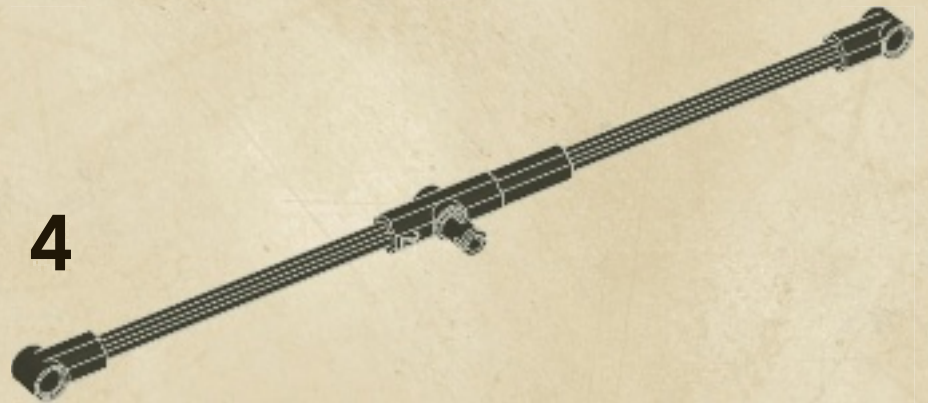

5

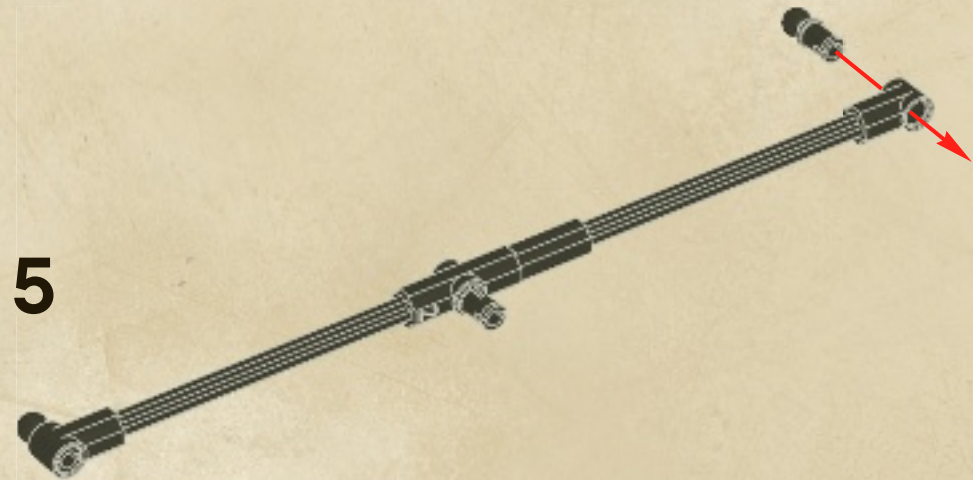

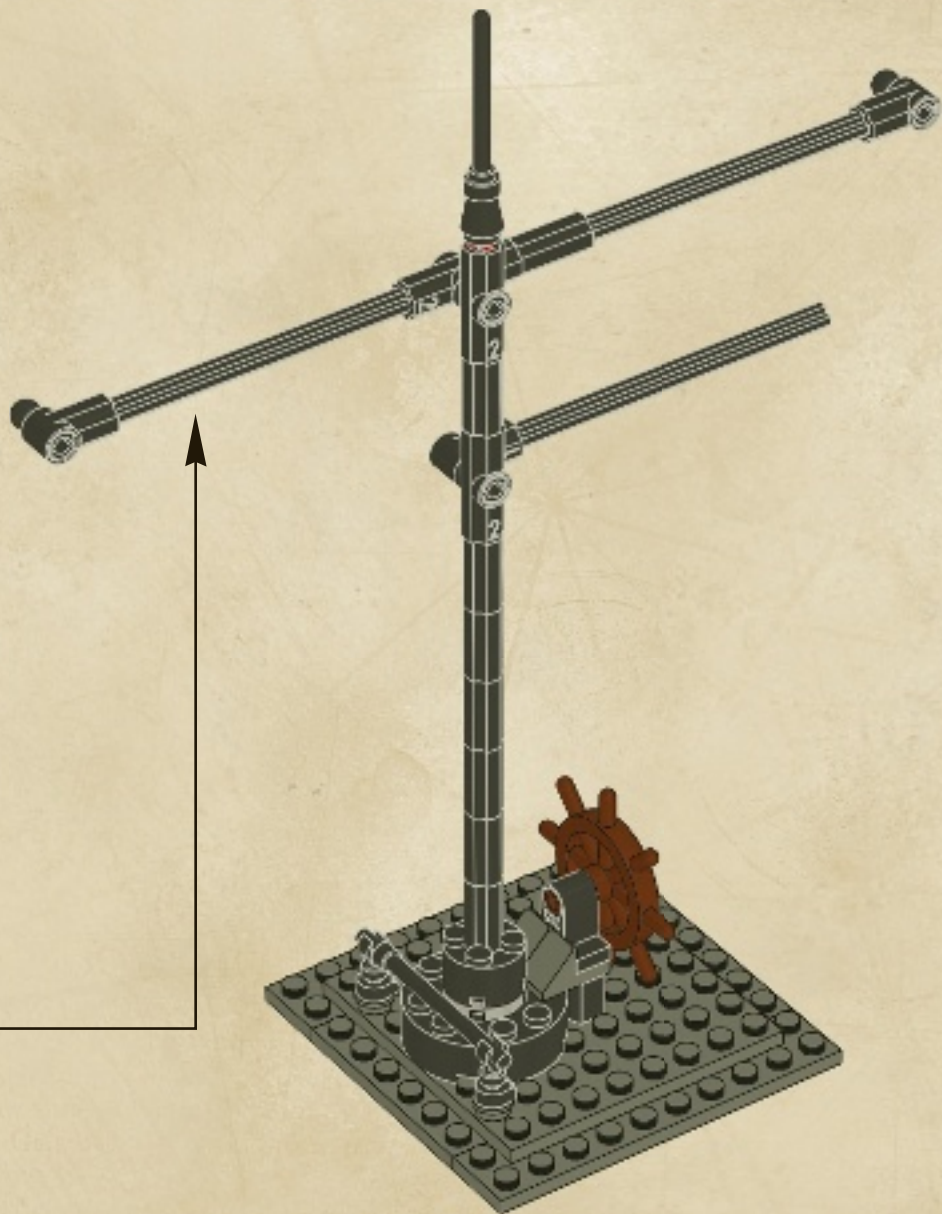

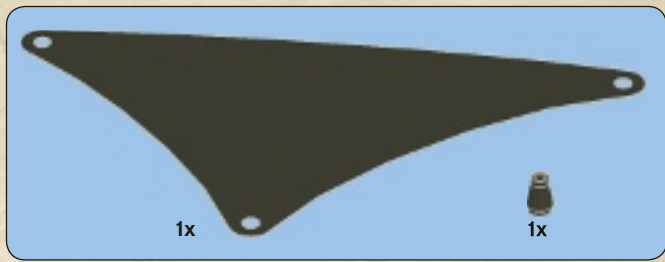

16

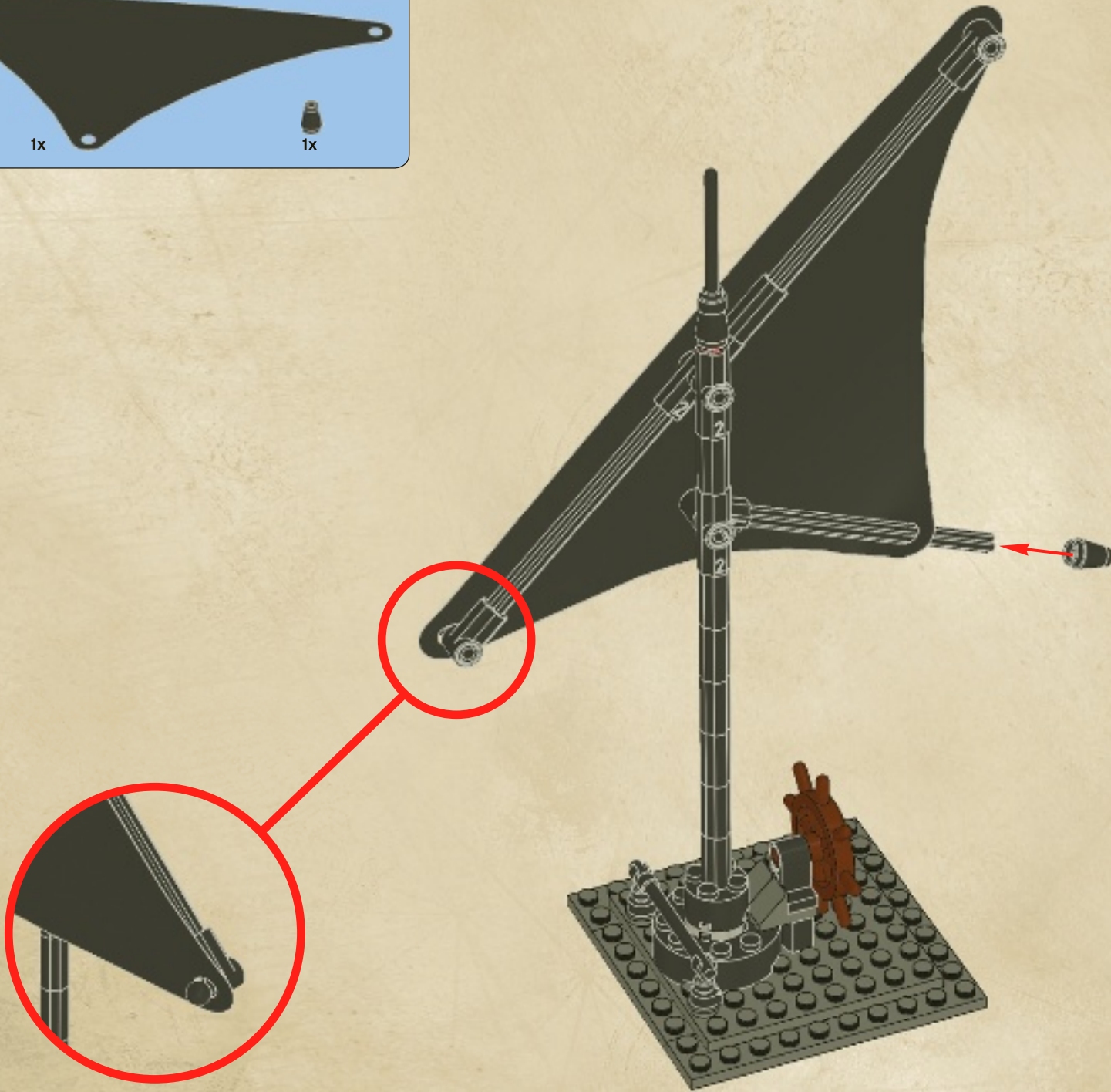

86

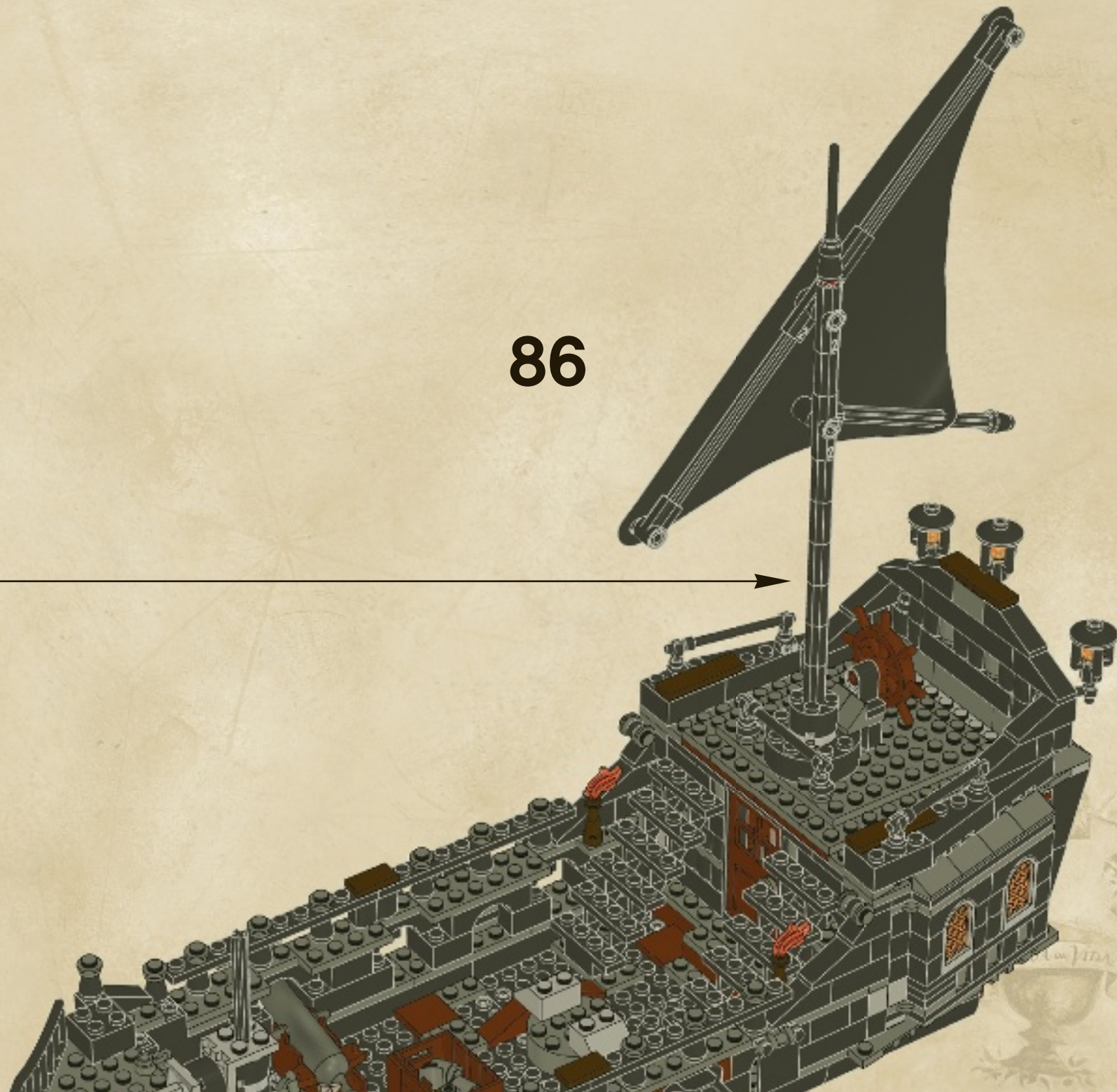

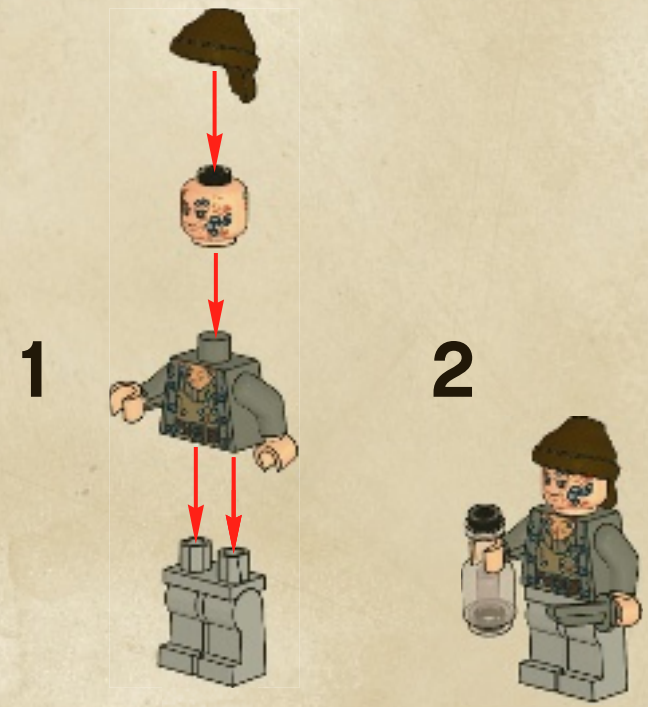
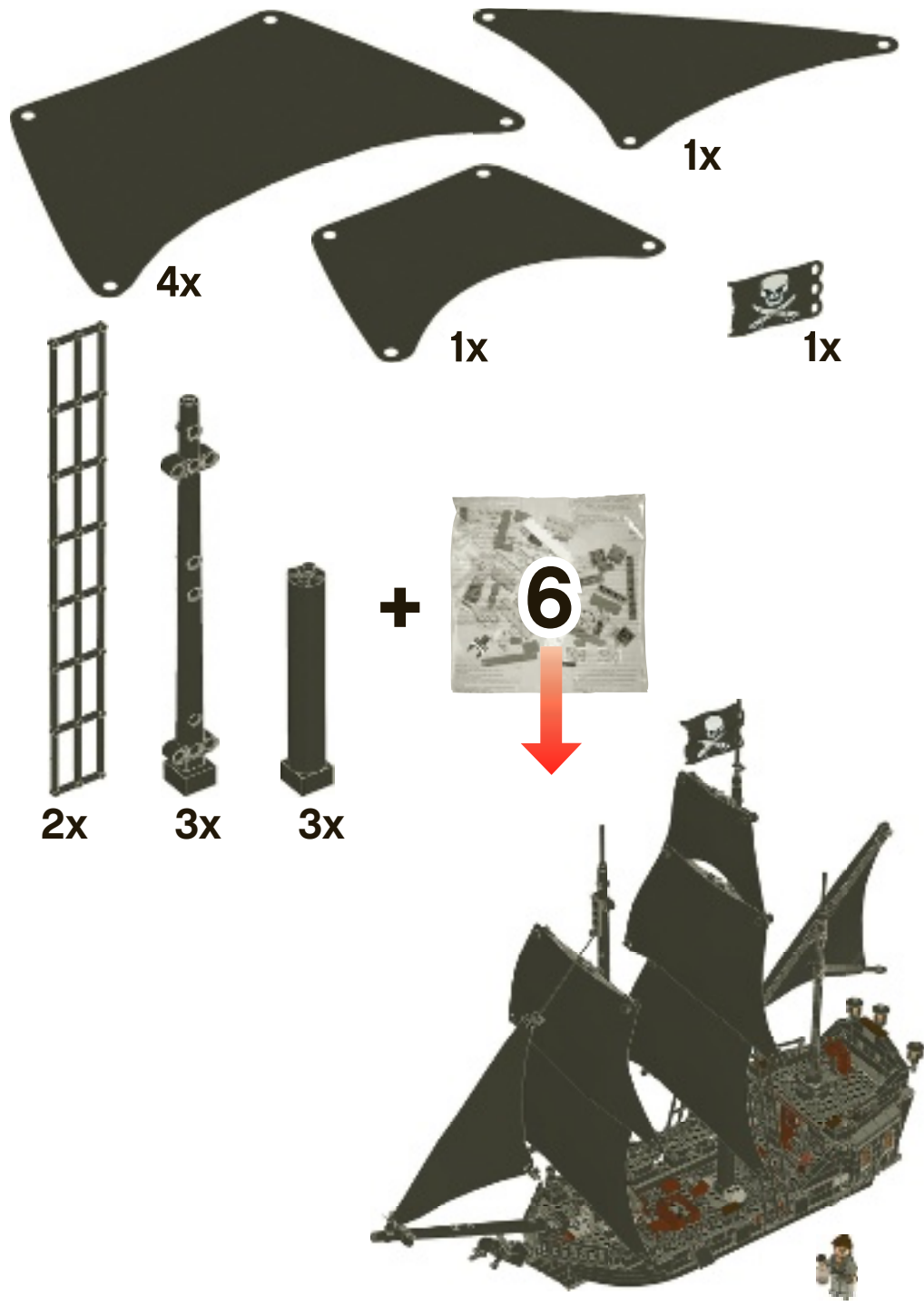

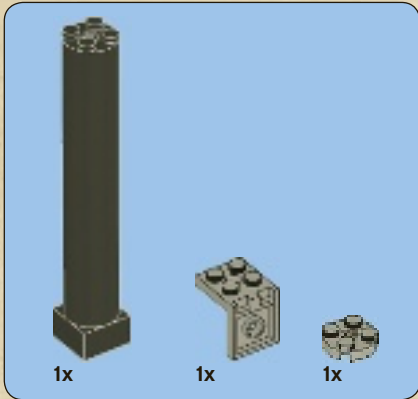
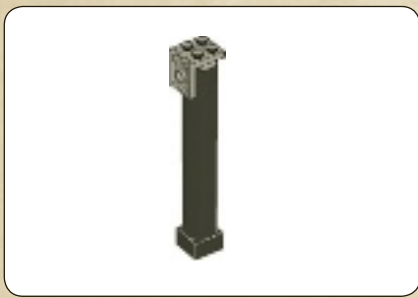

87

1



2

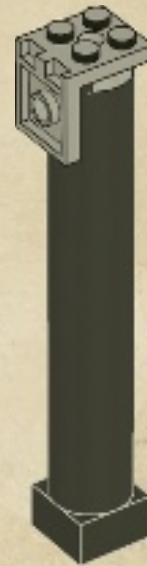

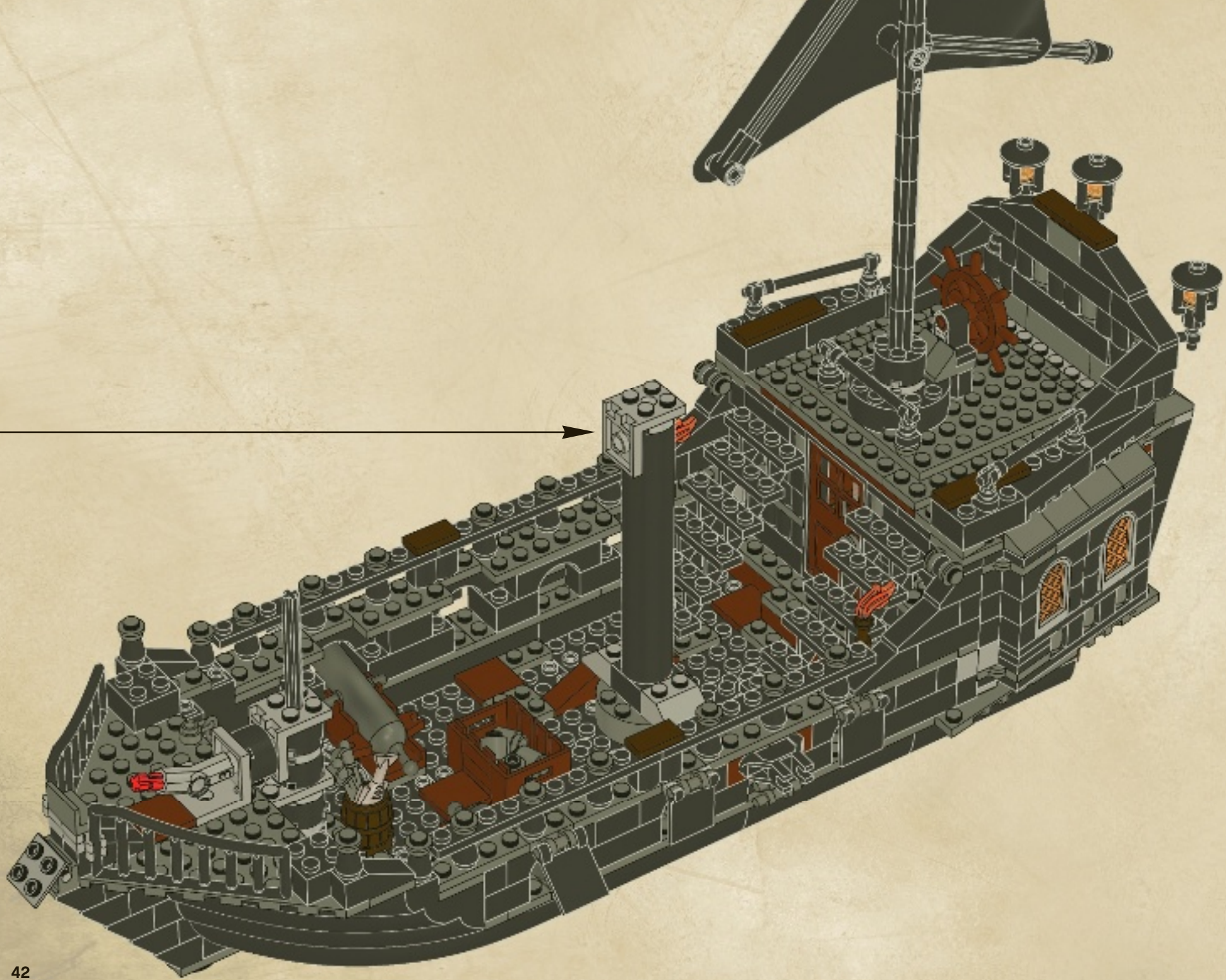

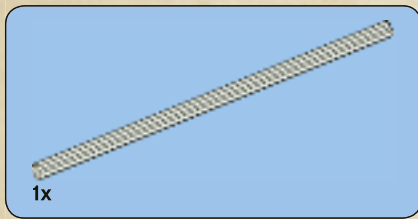

88

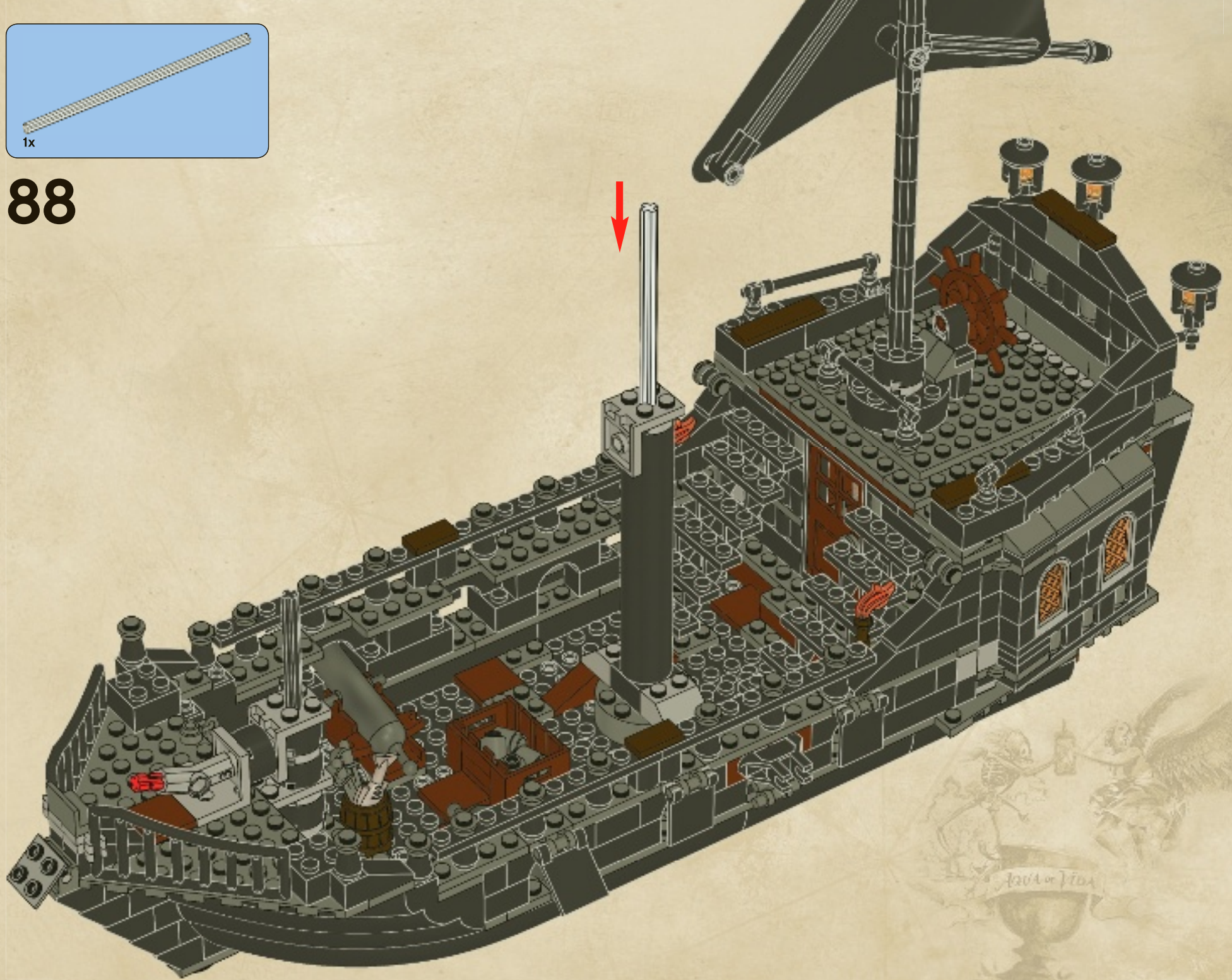

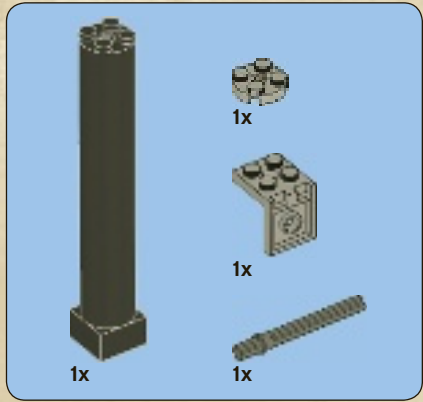

89

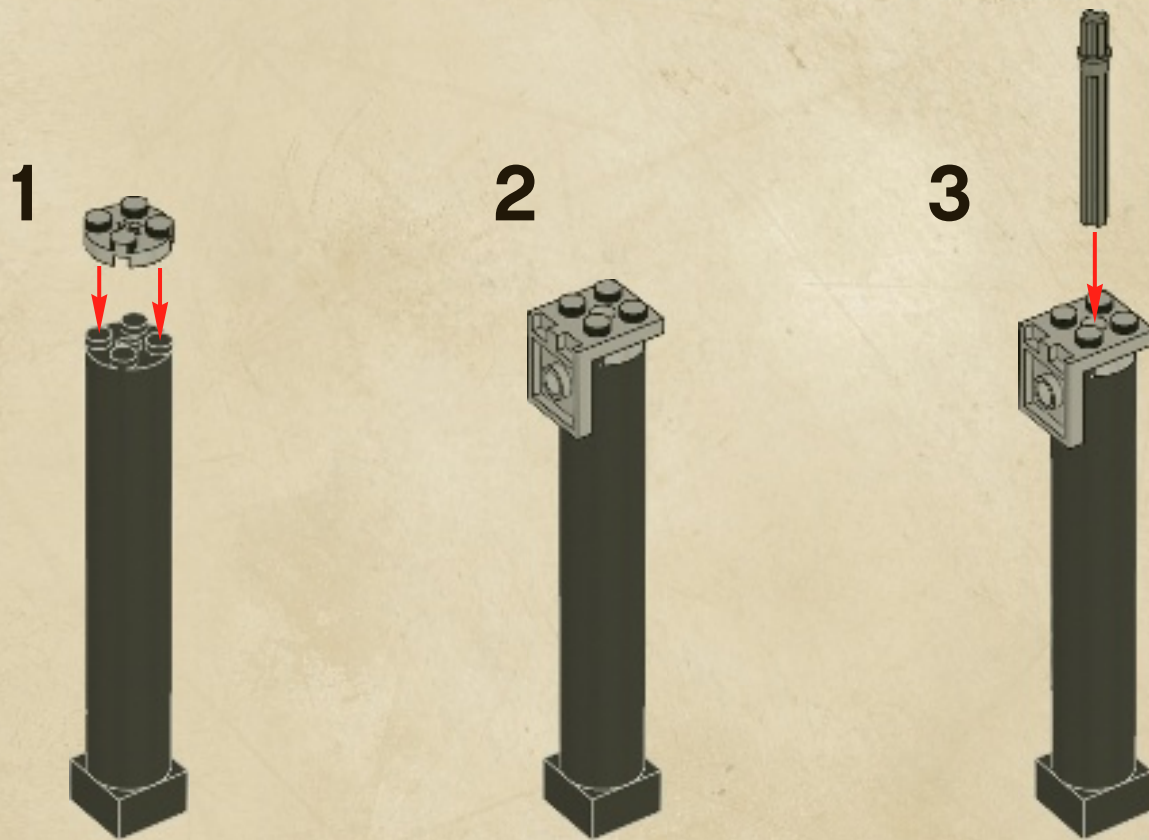

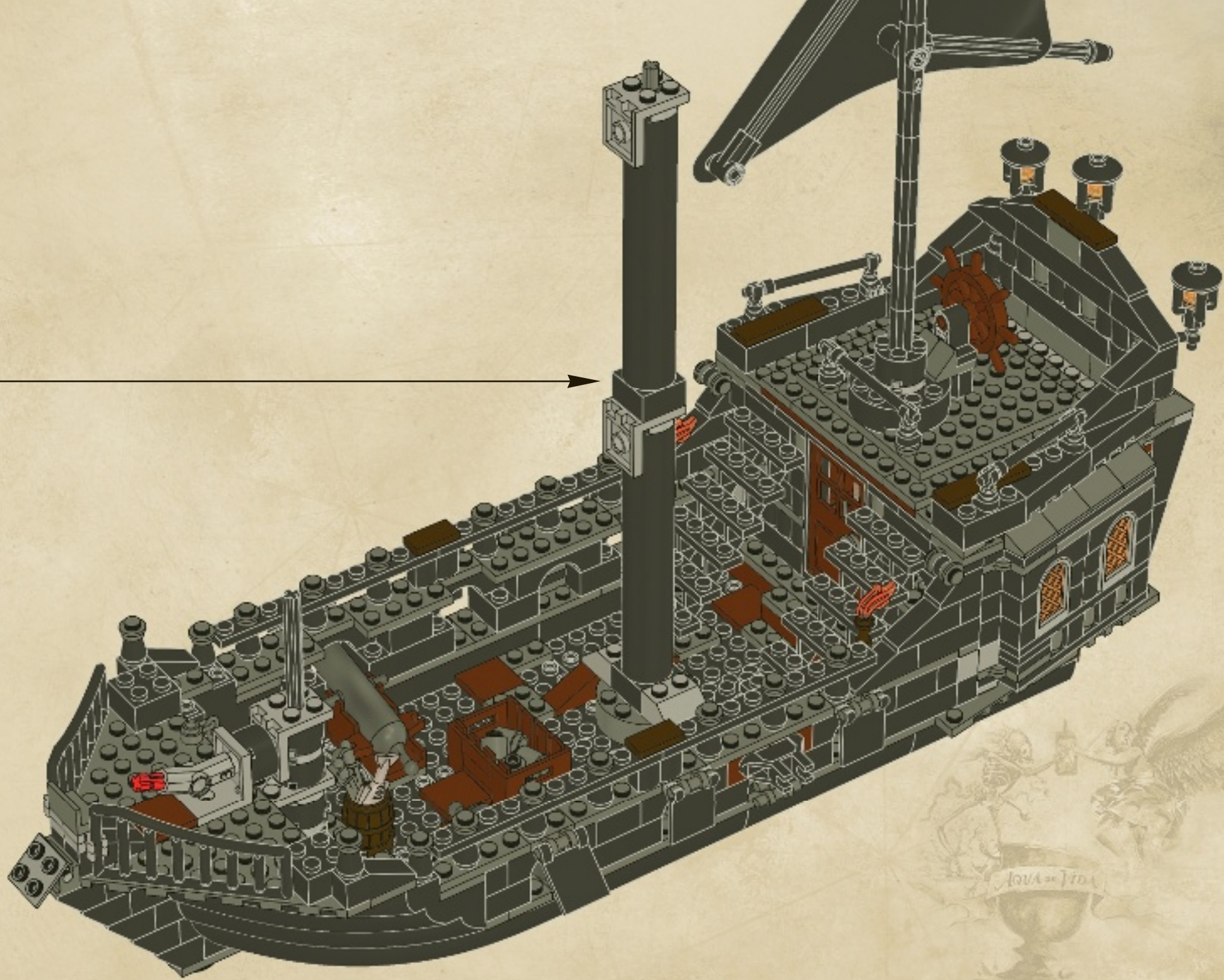

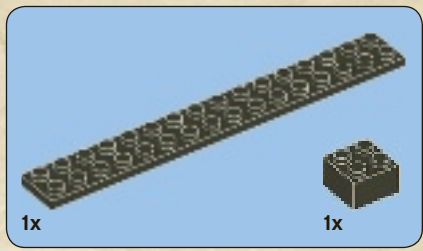

90

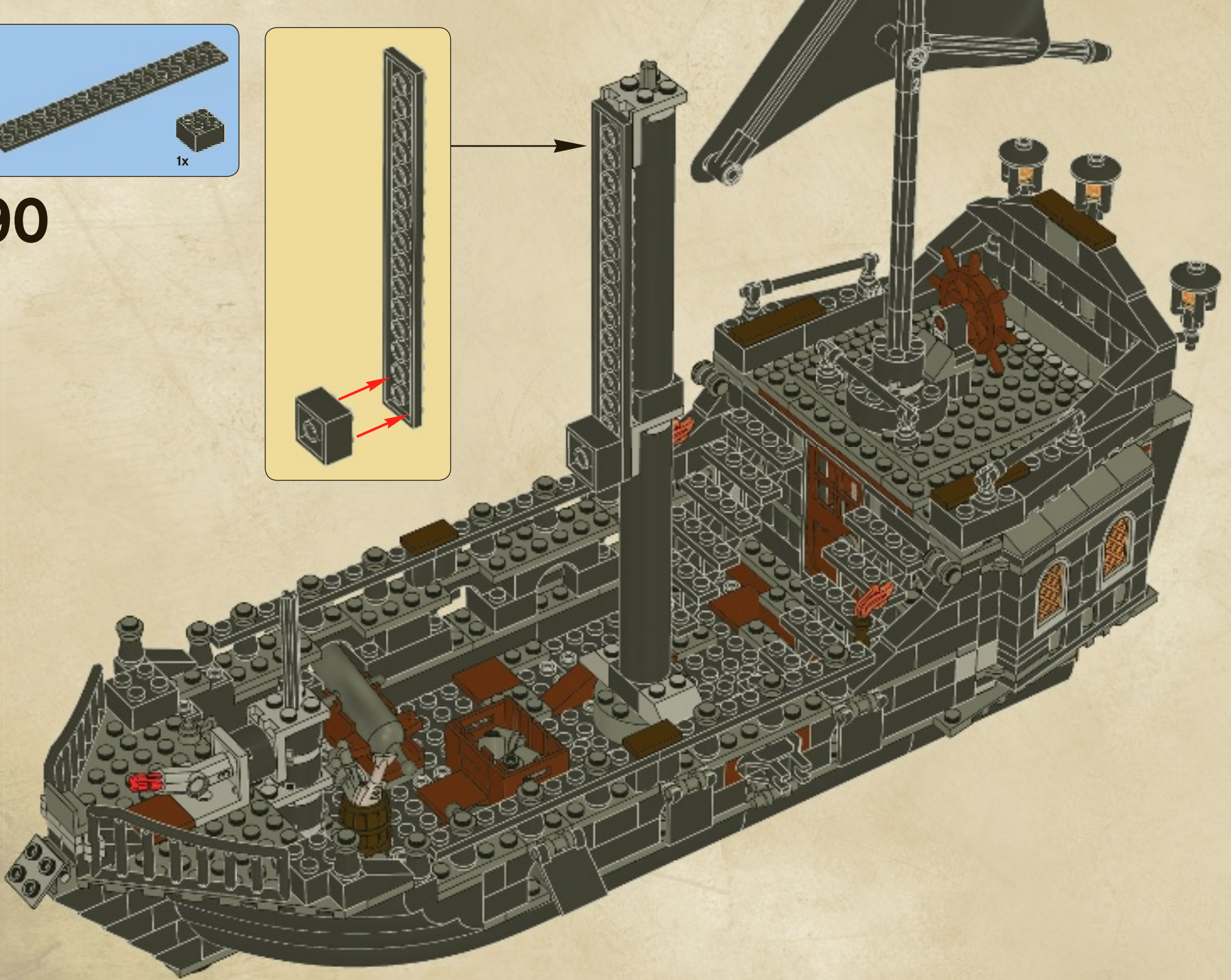

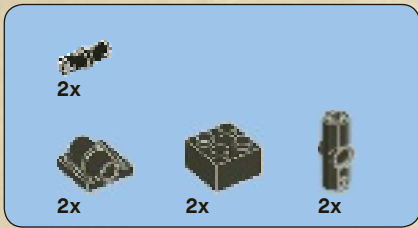

91

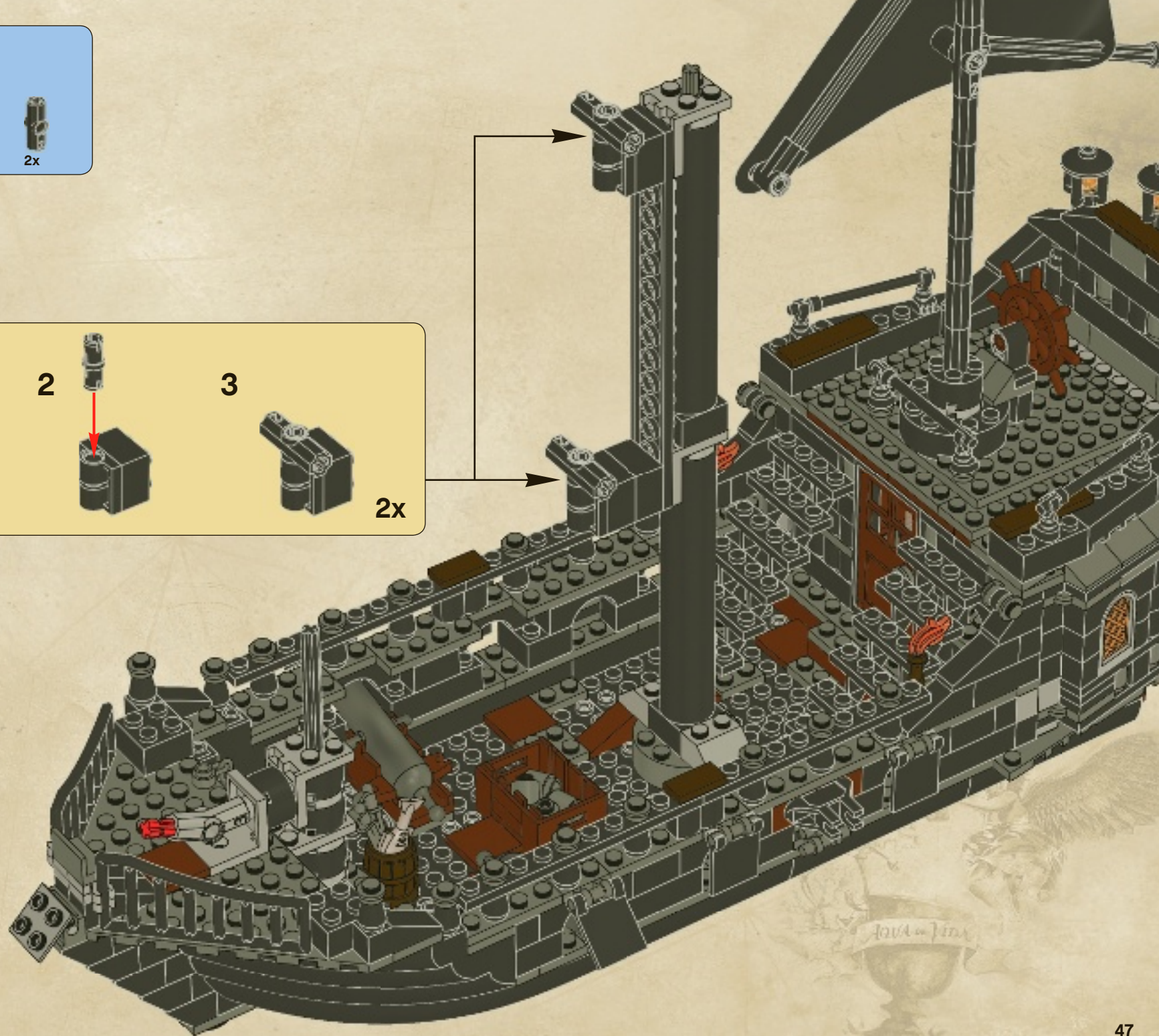
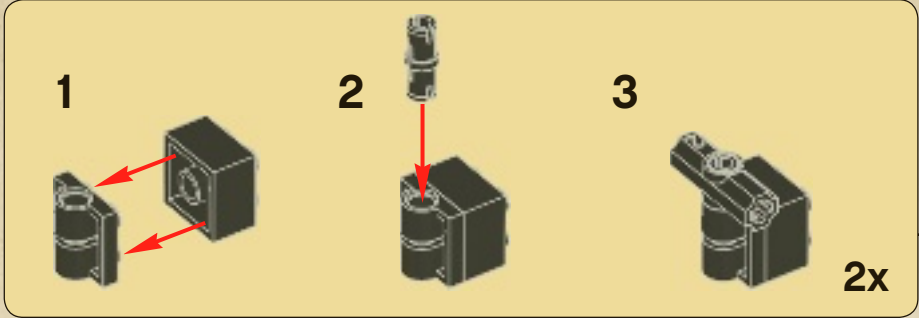

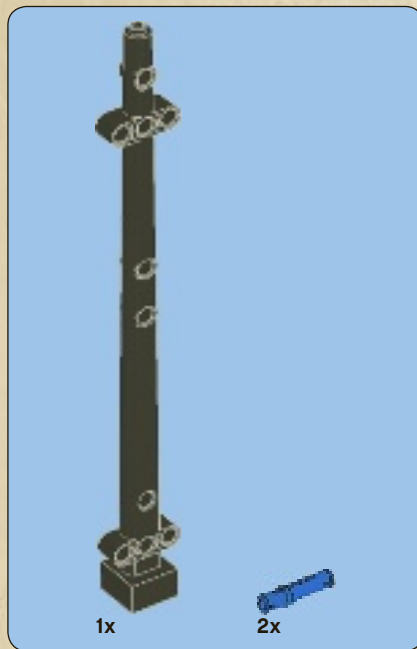
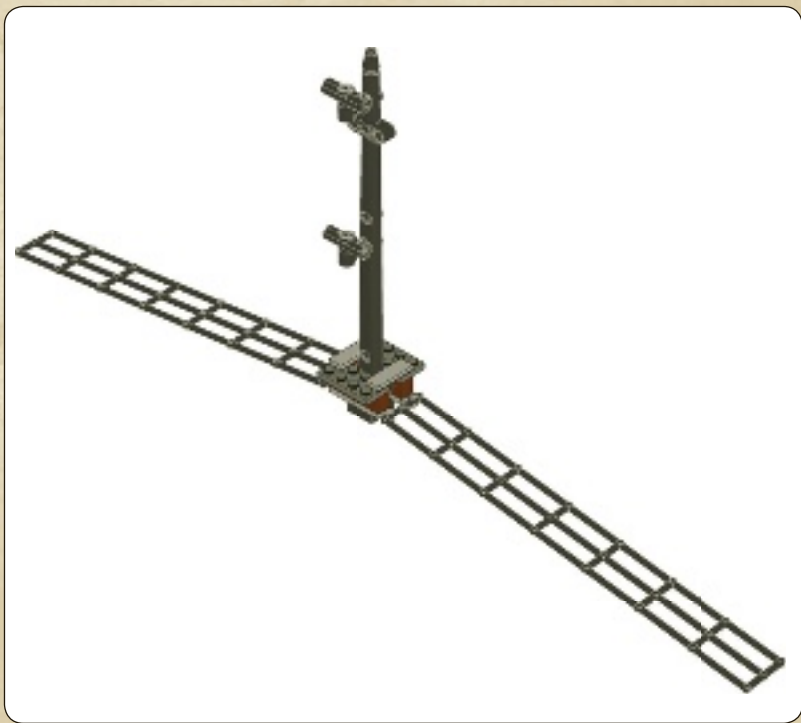

1



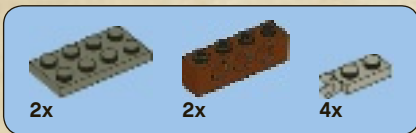

2

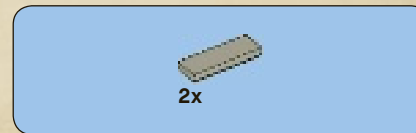
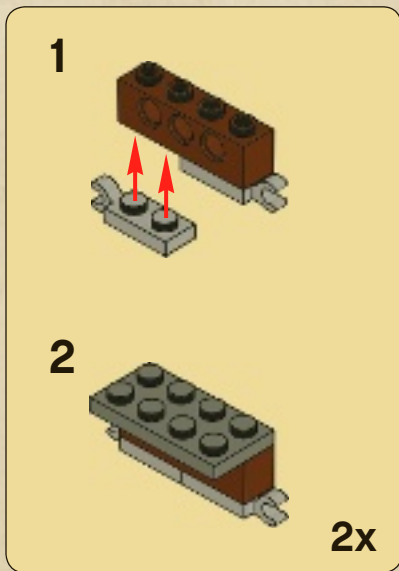

3





4

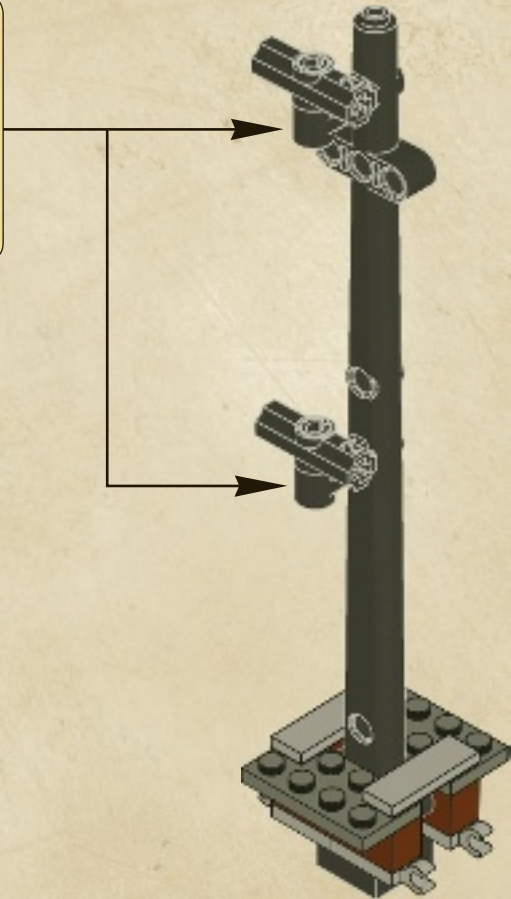
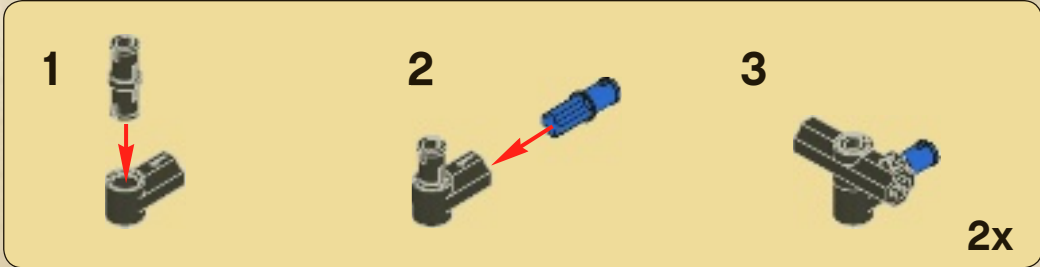

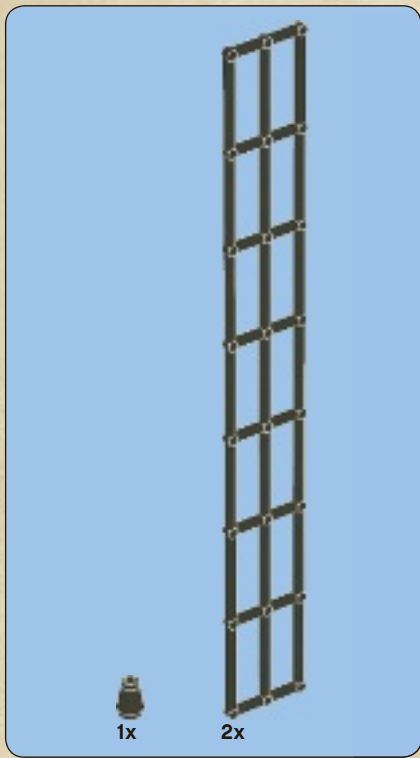

5

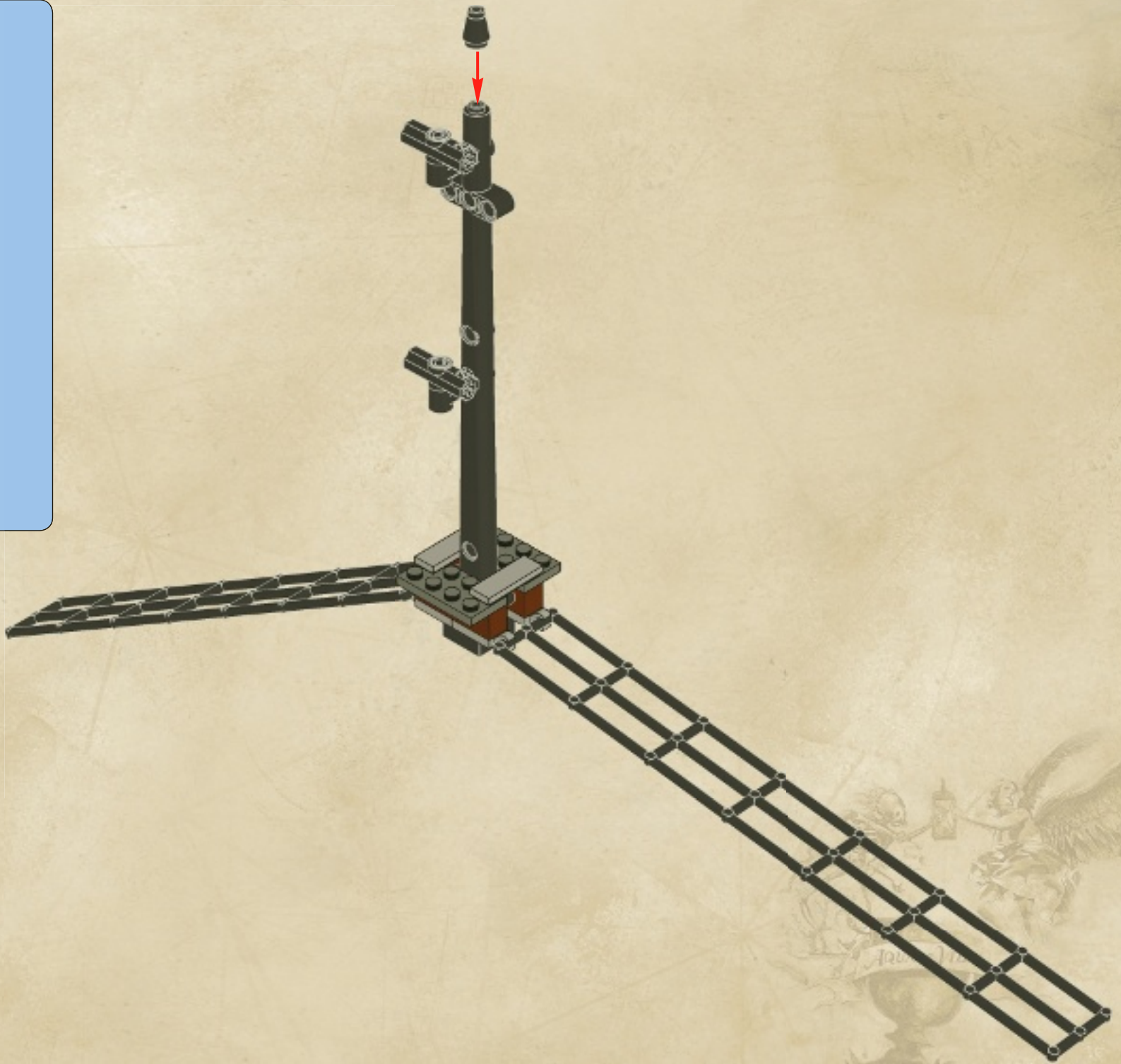

92

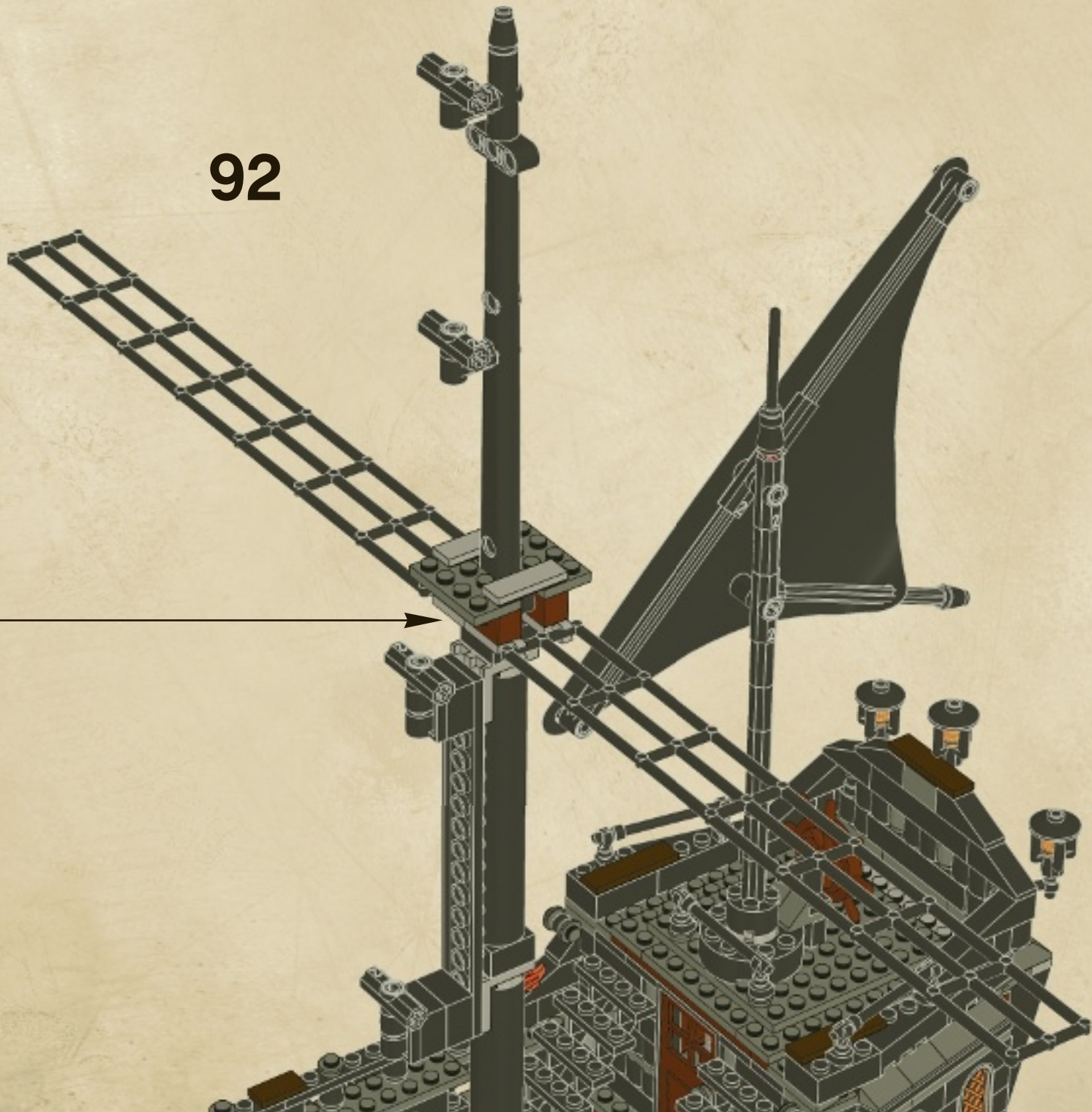

93

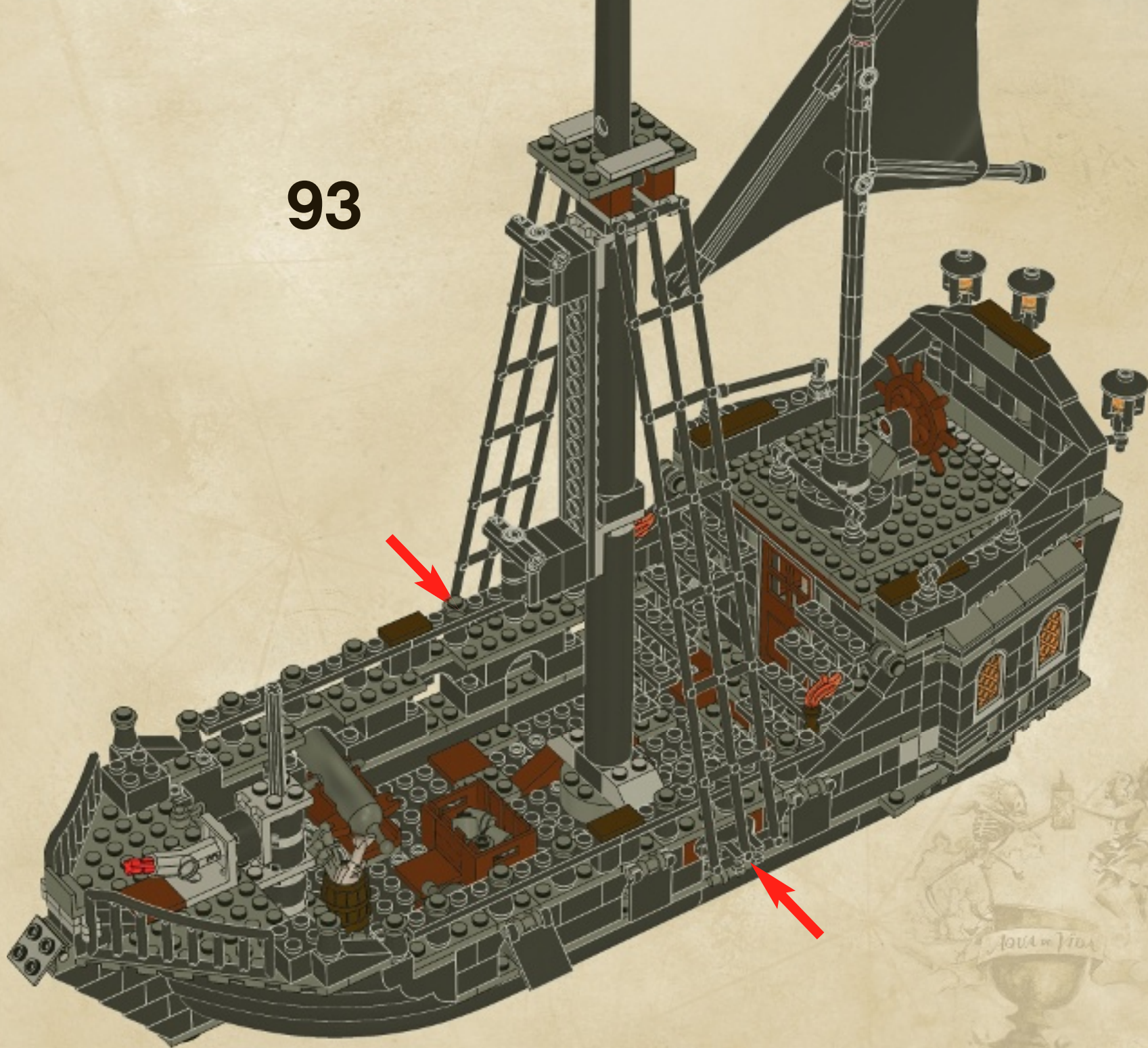

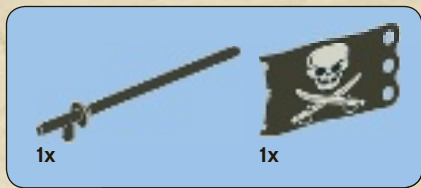

94

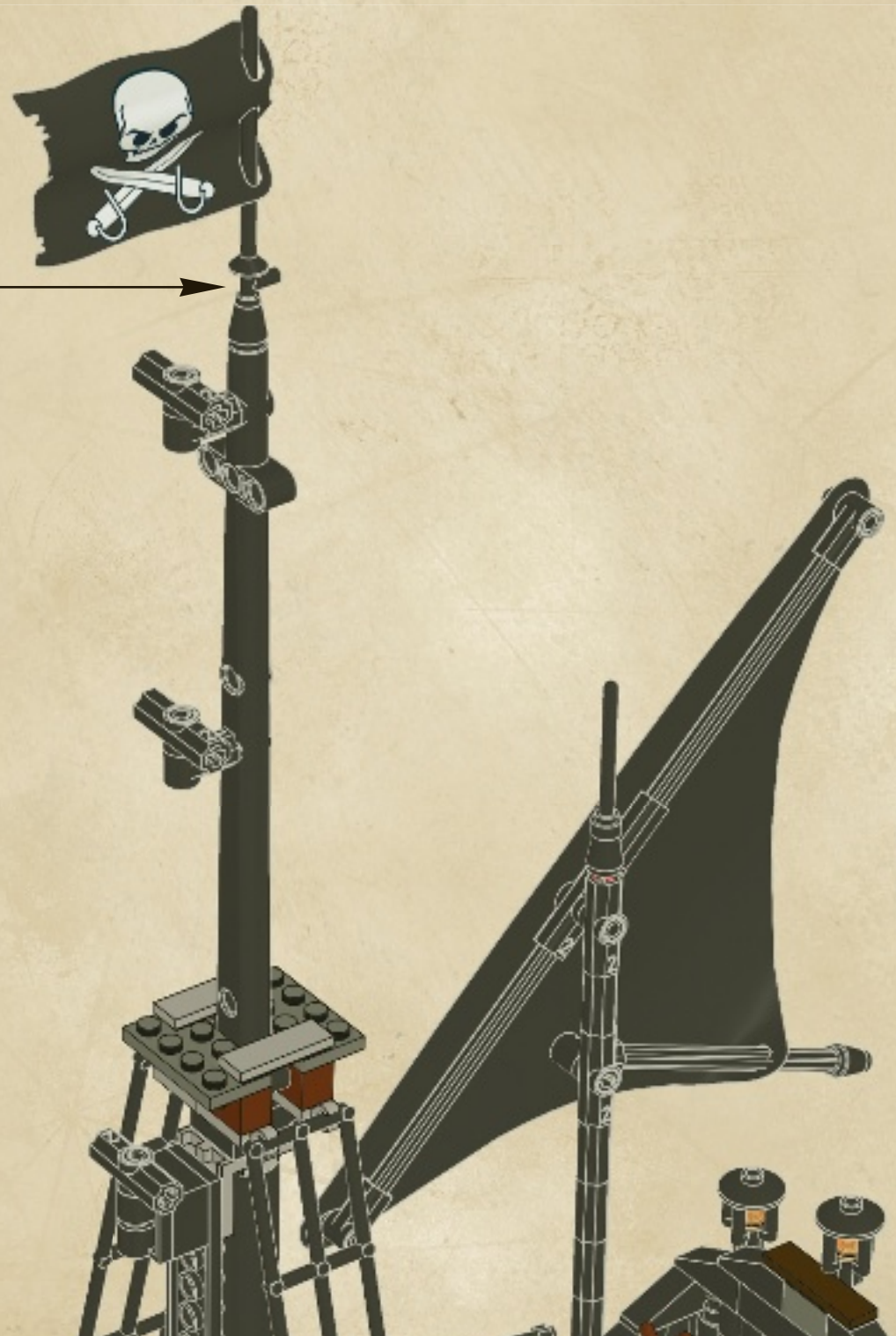



95

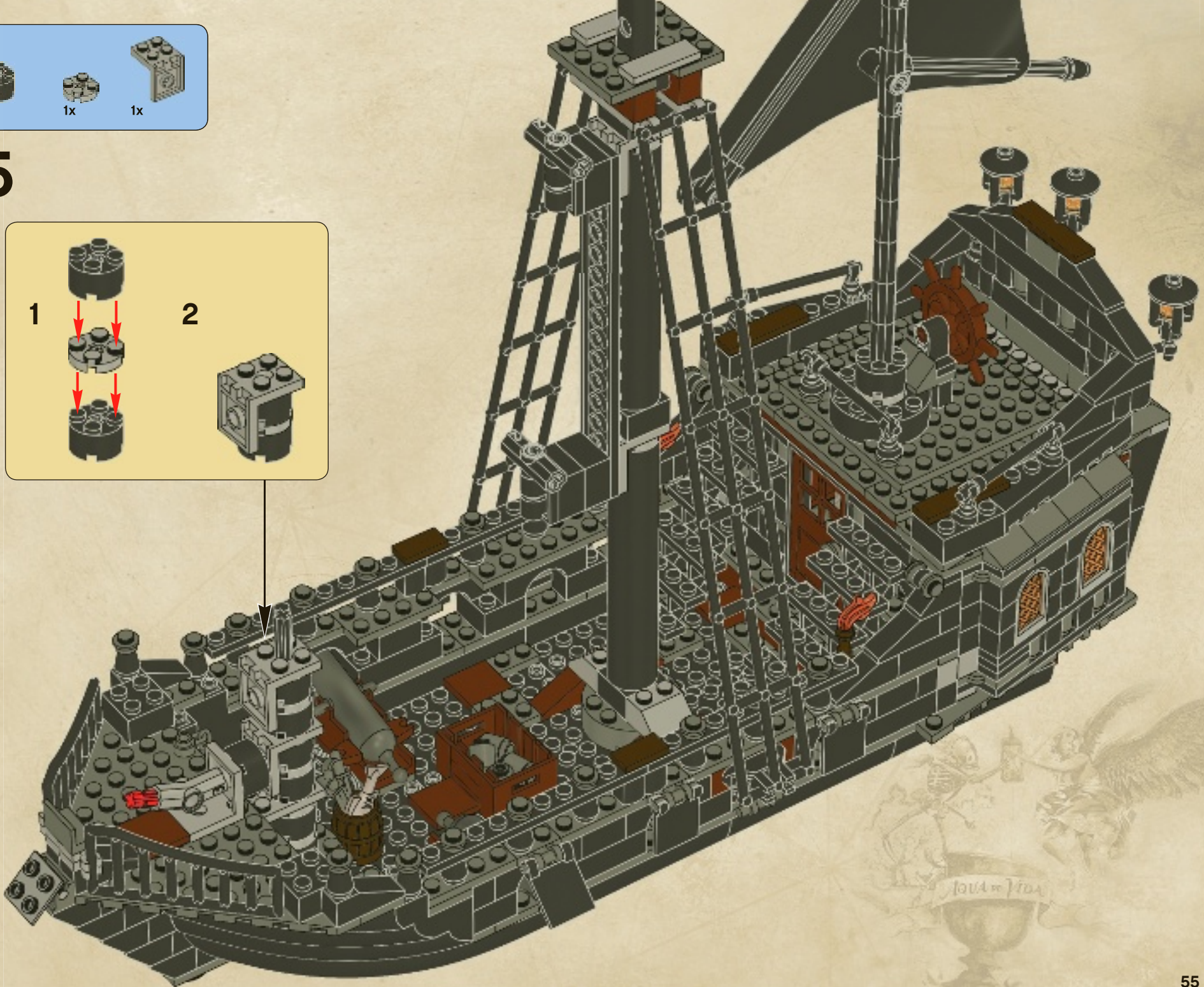
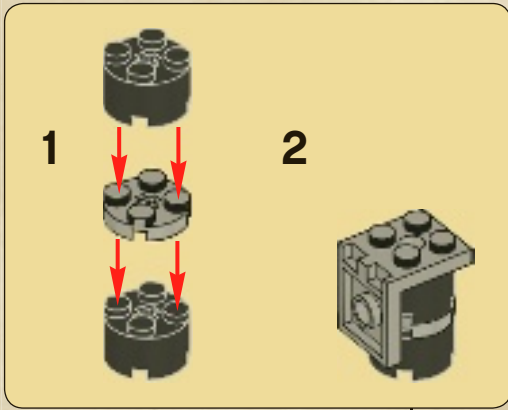

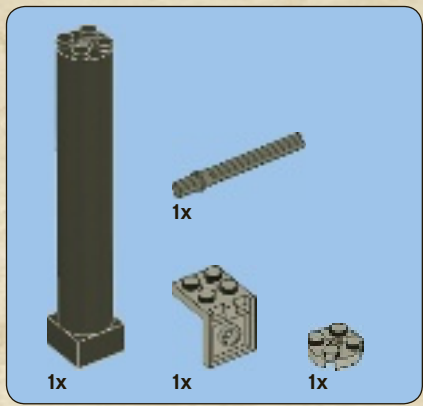

96

1



2



3

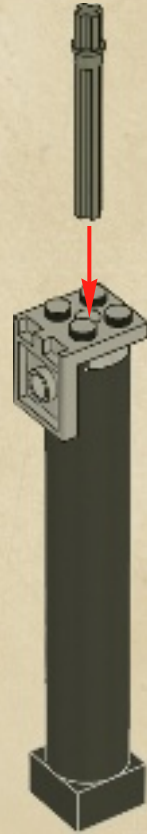

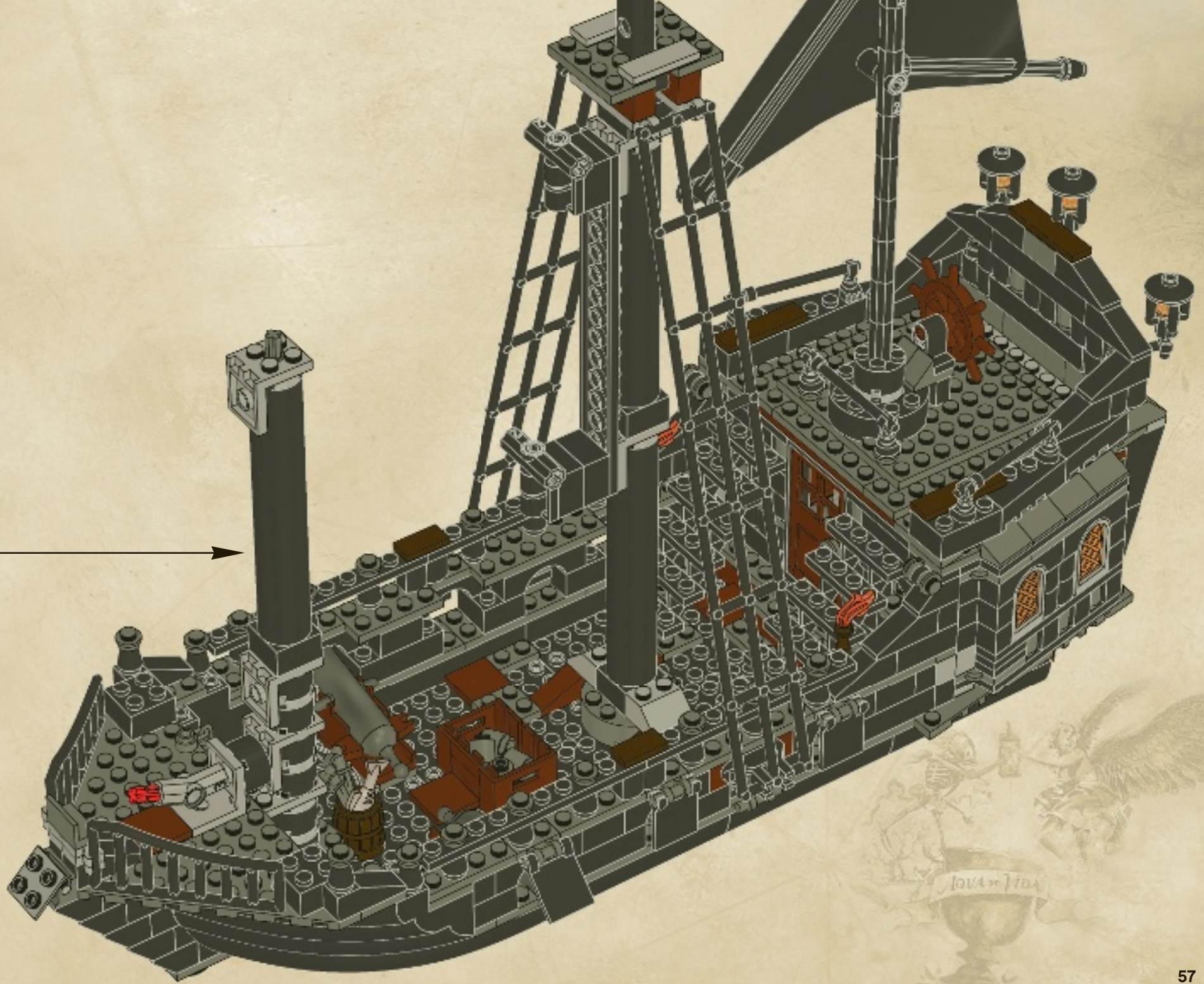

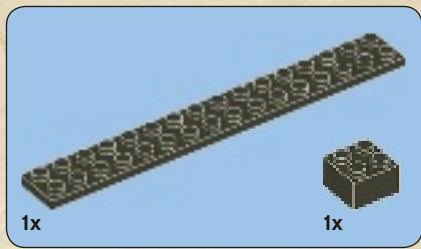

97

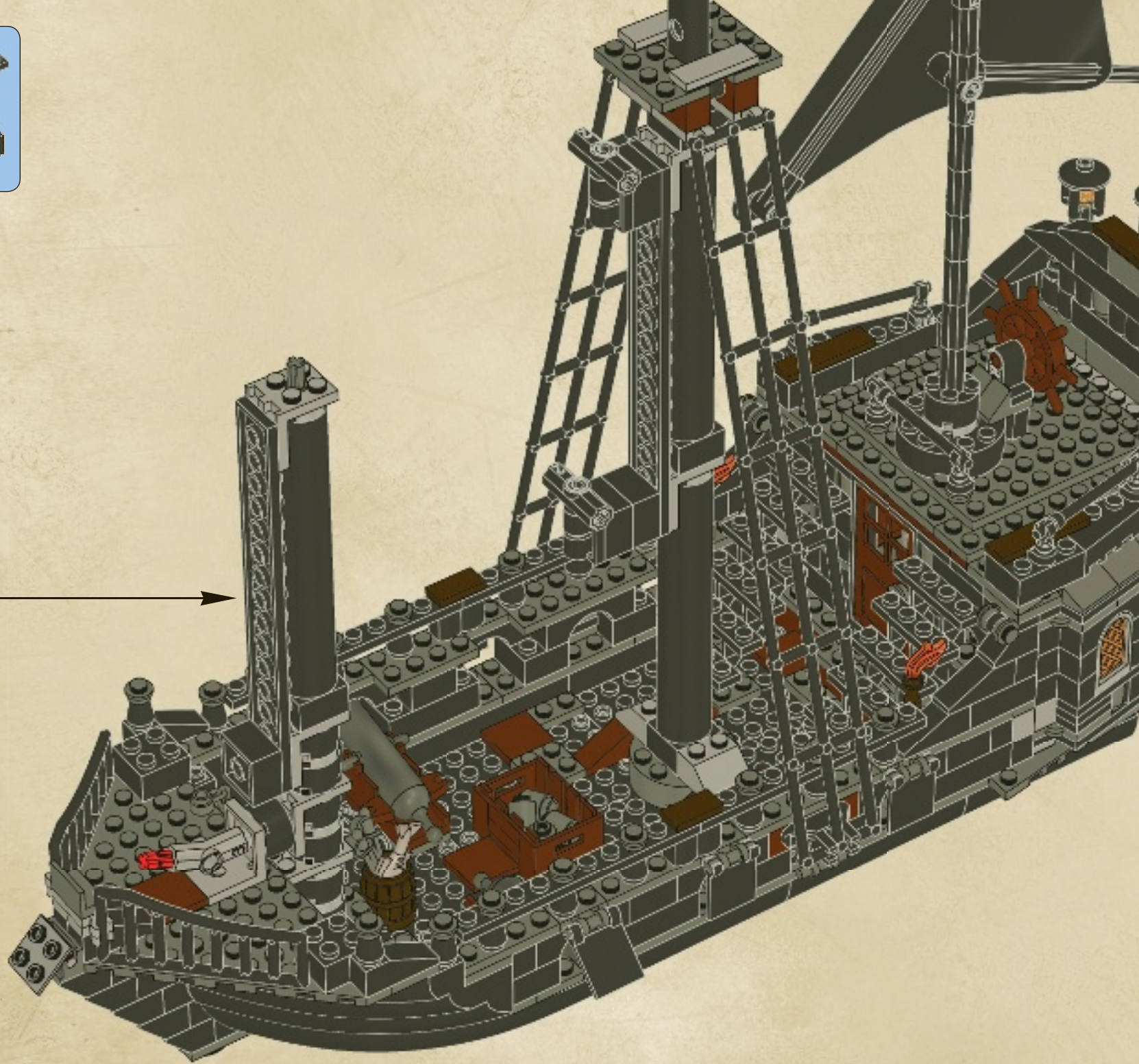
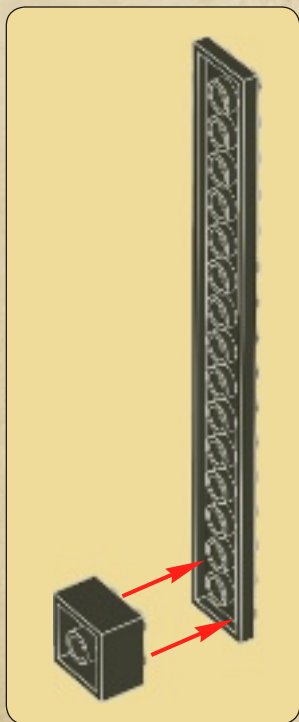



98

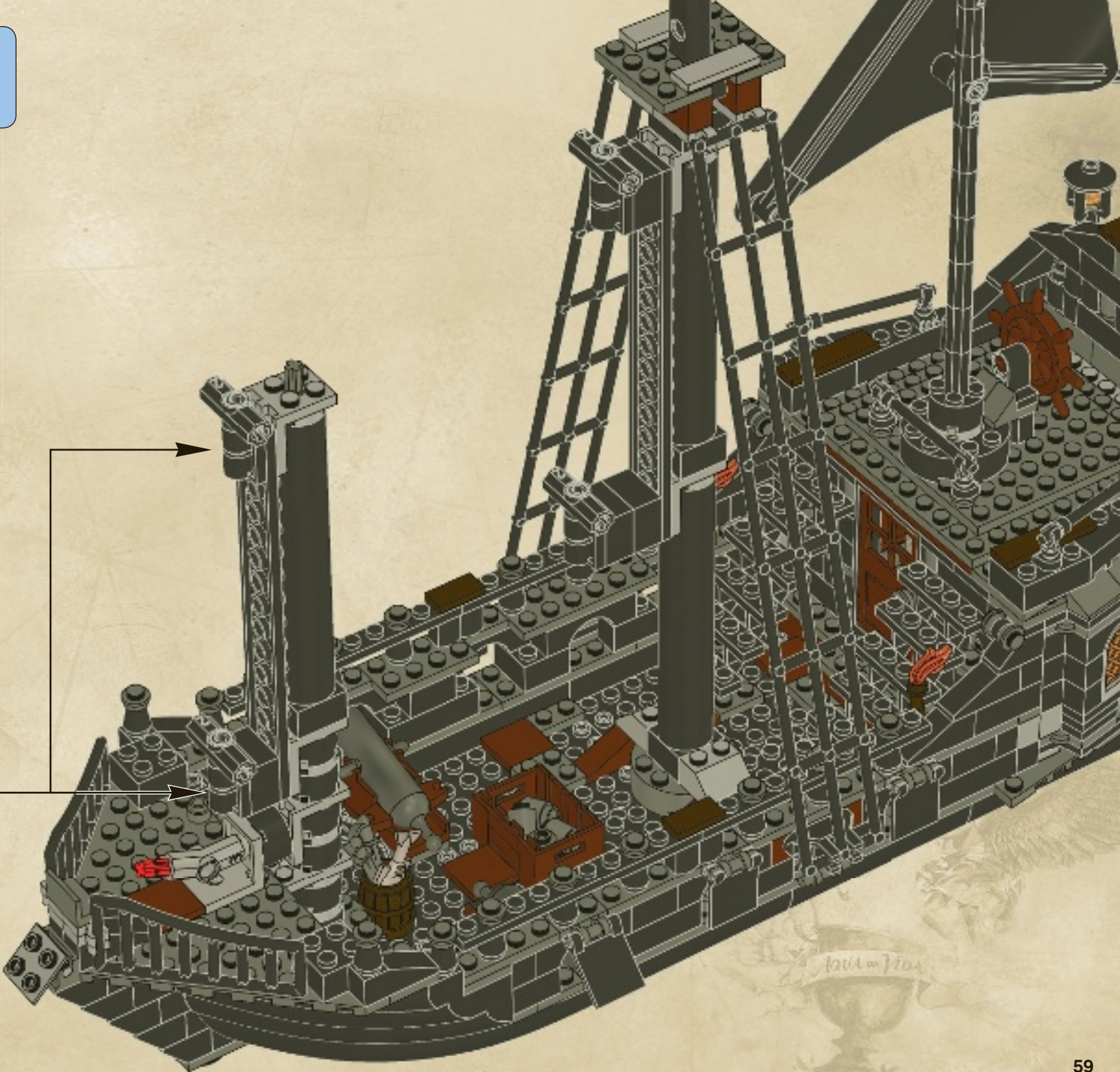
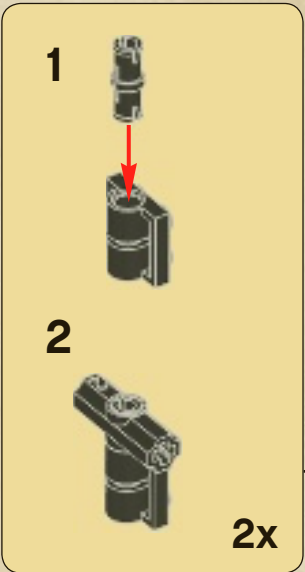

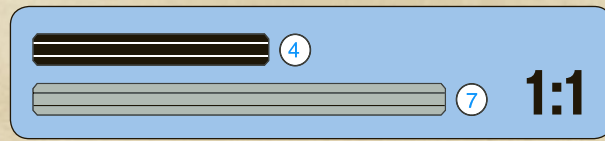
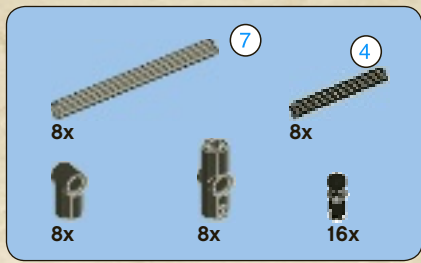

99

1

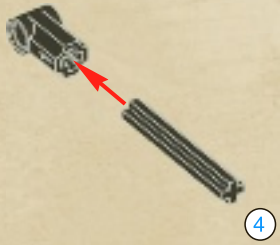

2



3

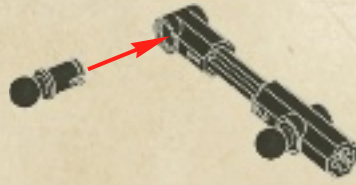

4



8x

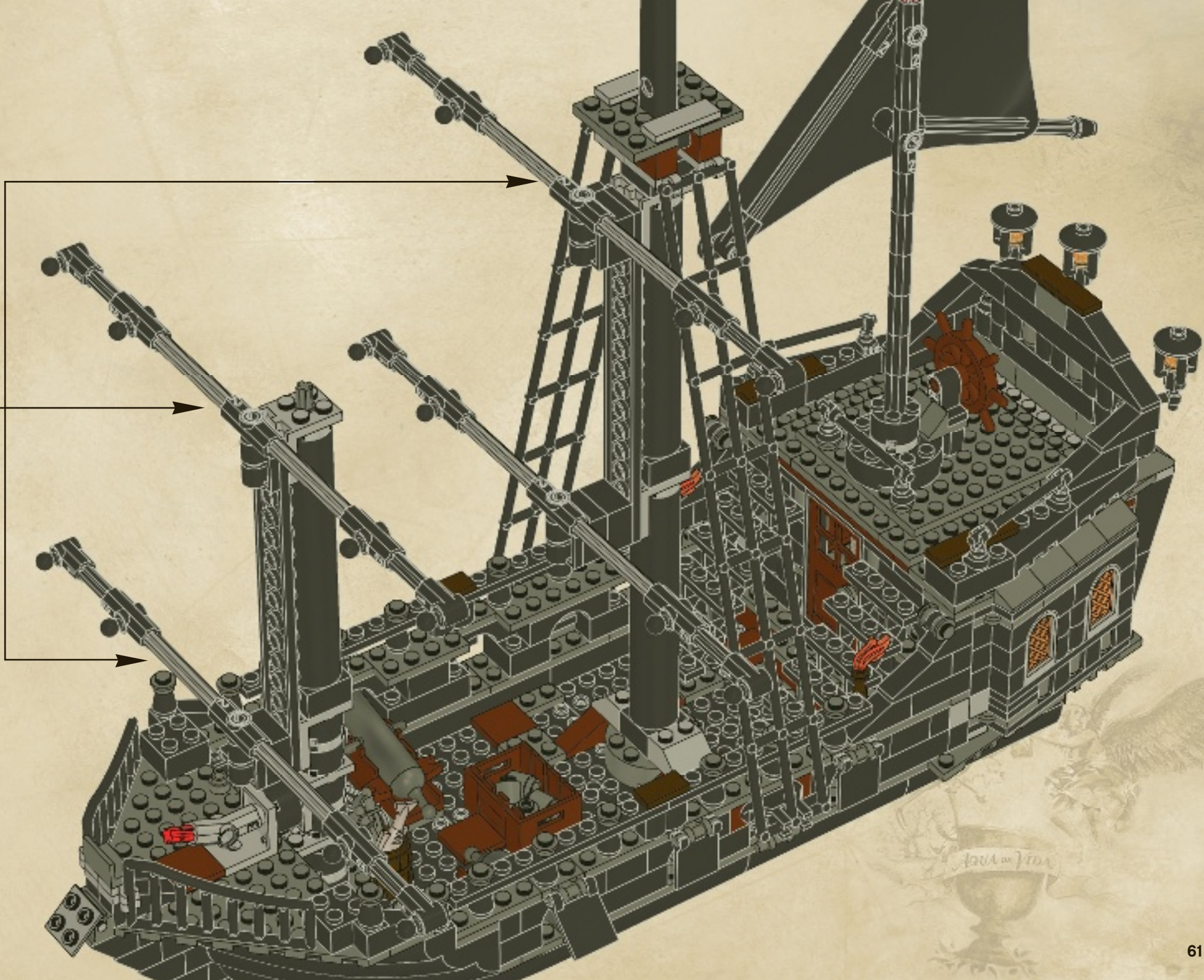

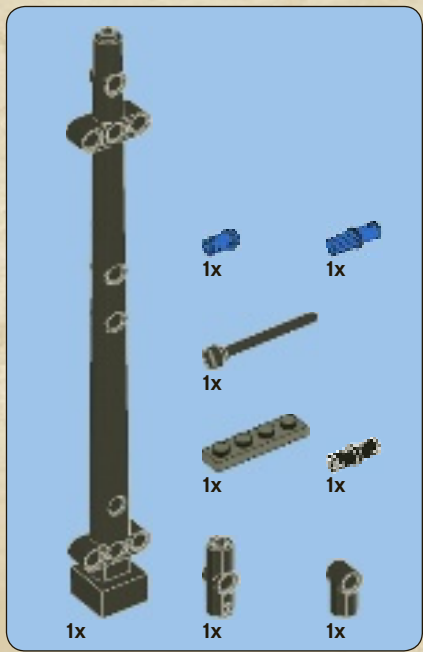

100

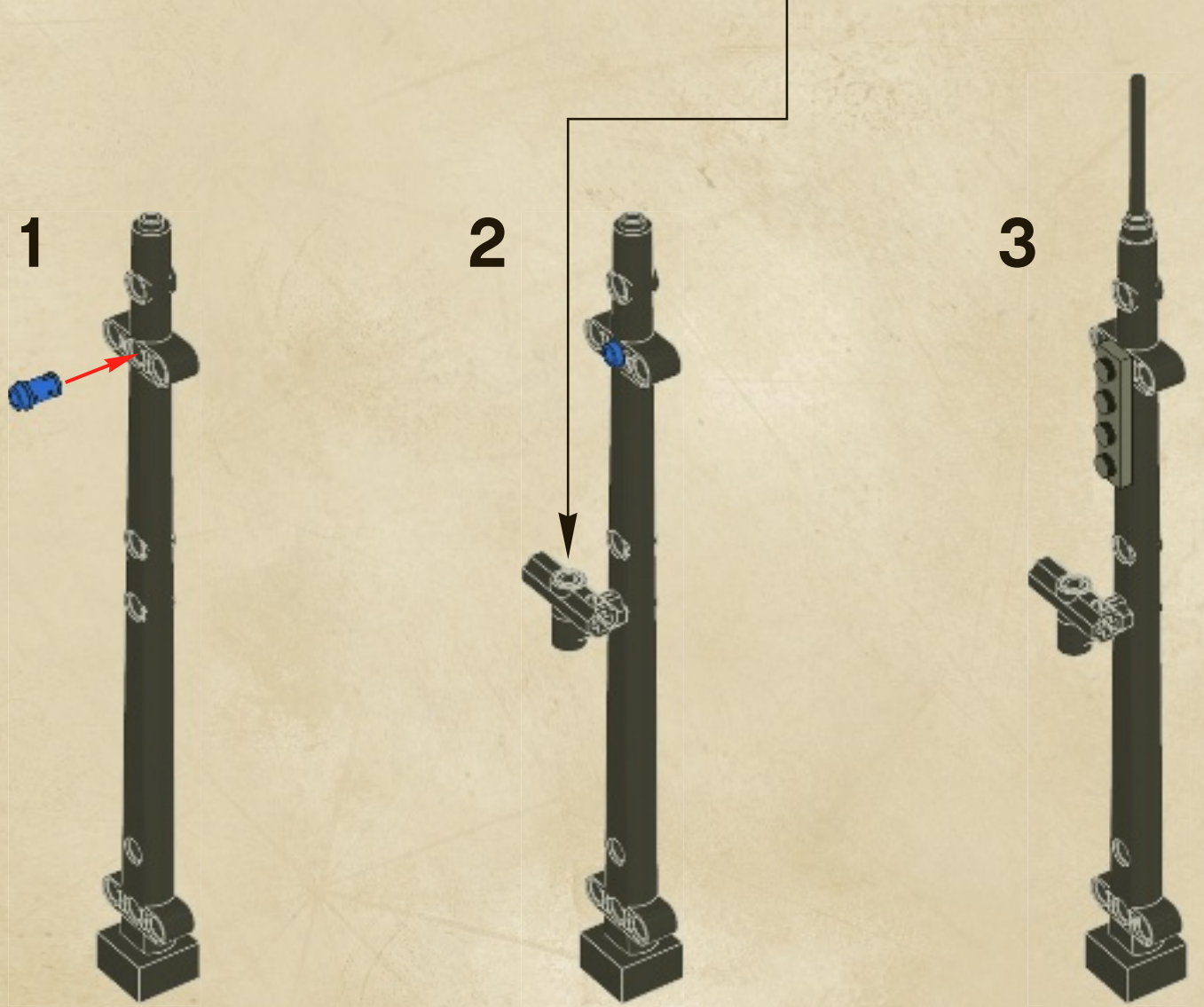
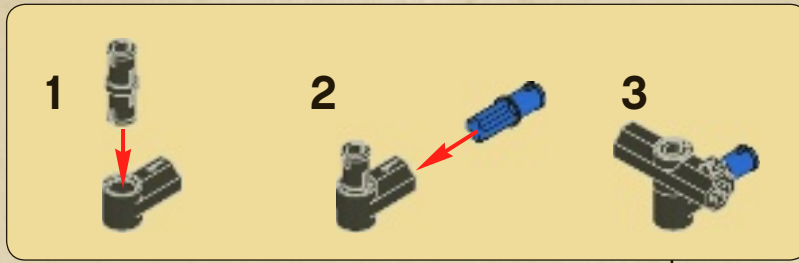



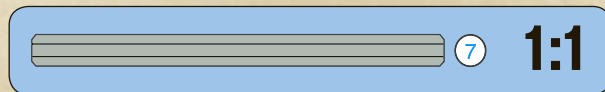
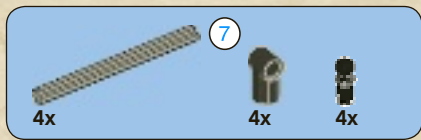

101

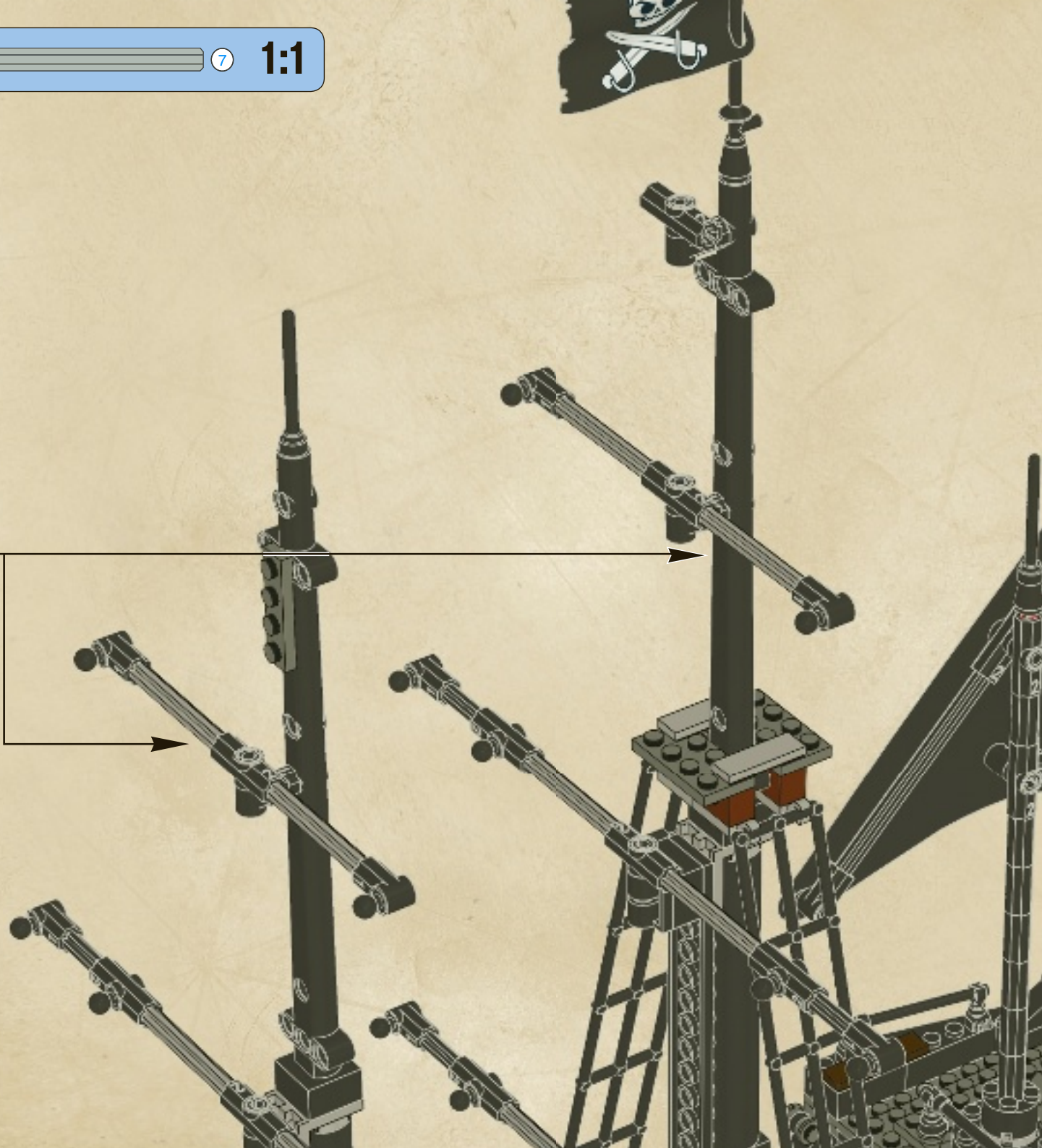
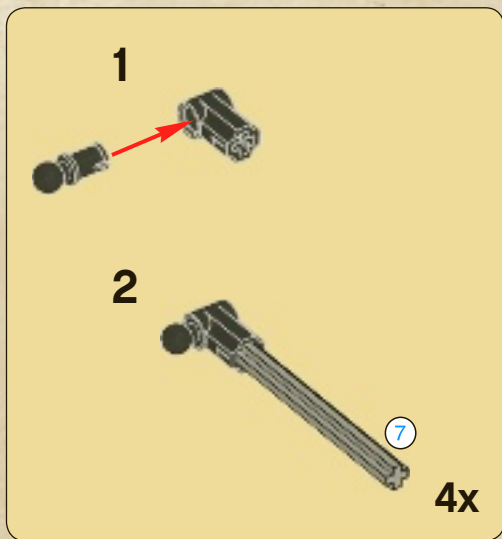

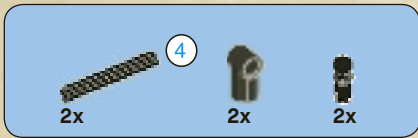

102

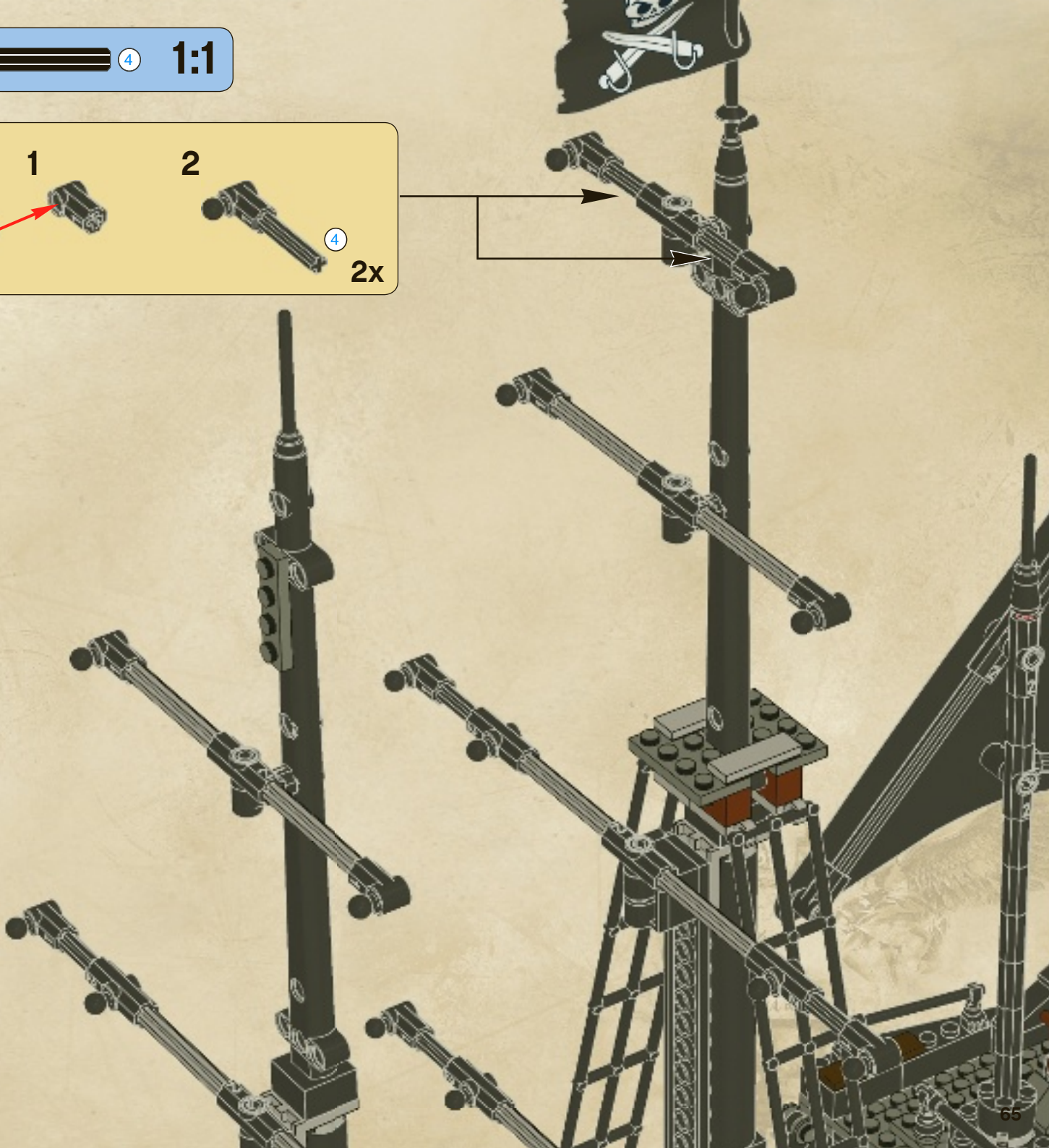
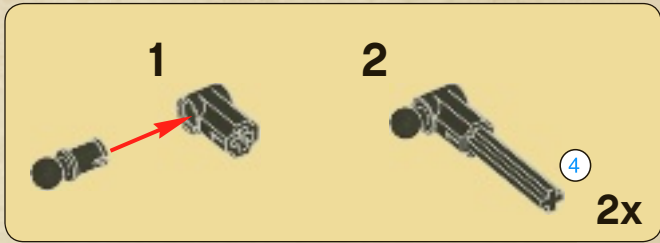

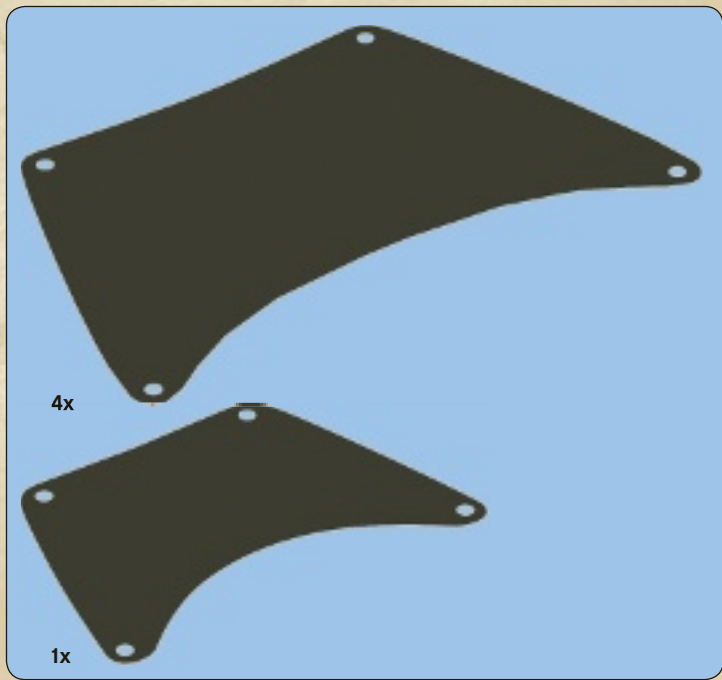

103



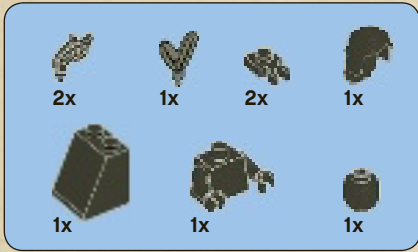

104

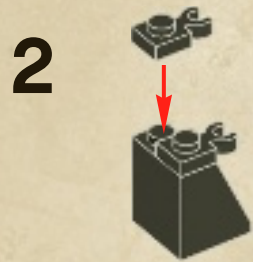



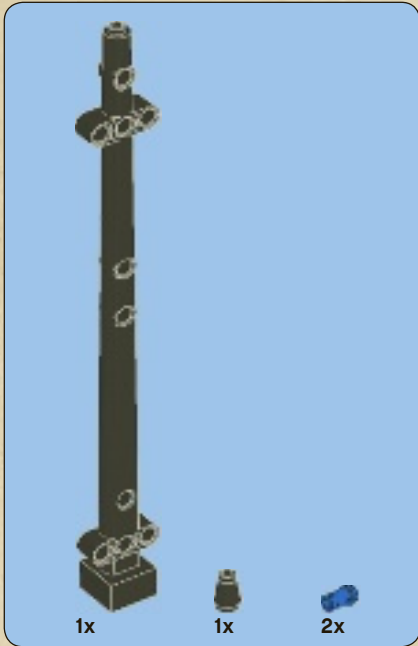

105

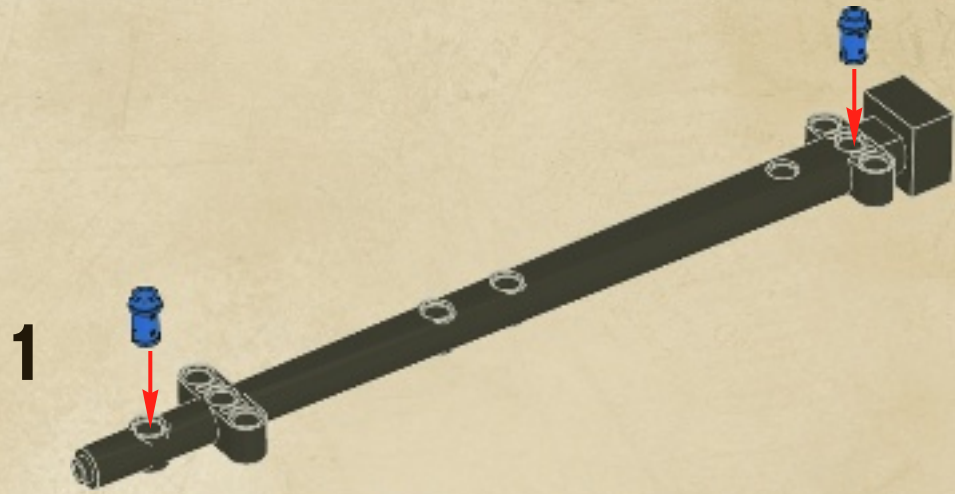

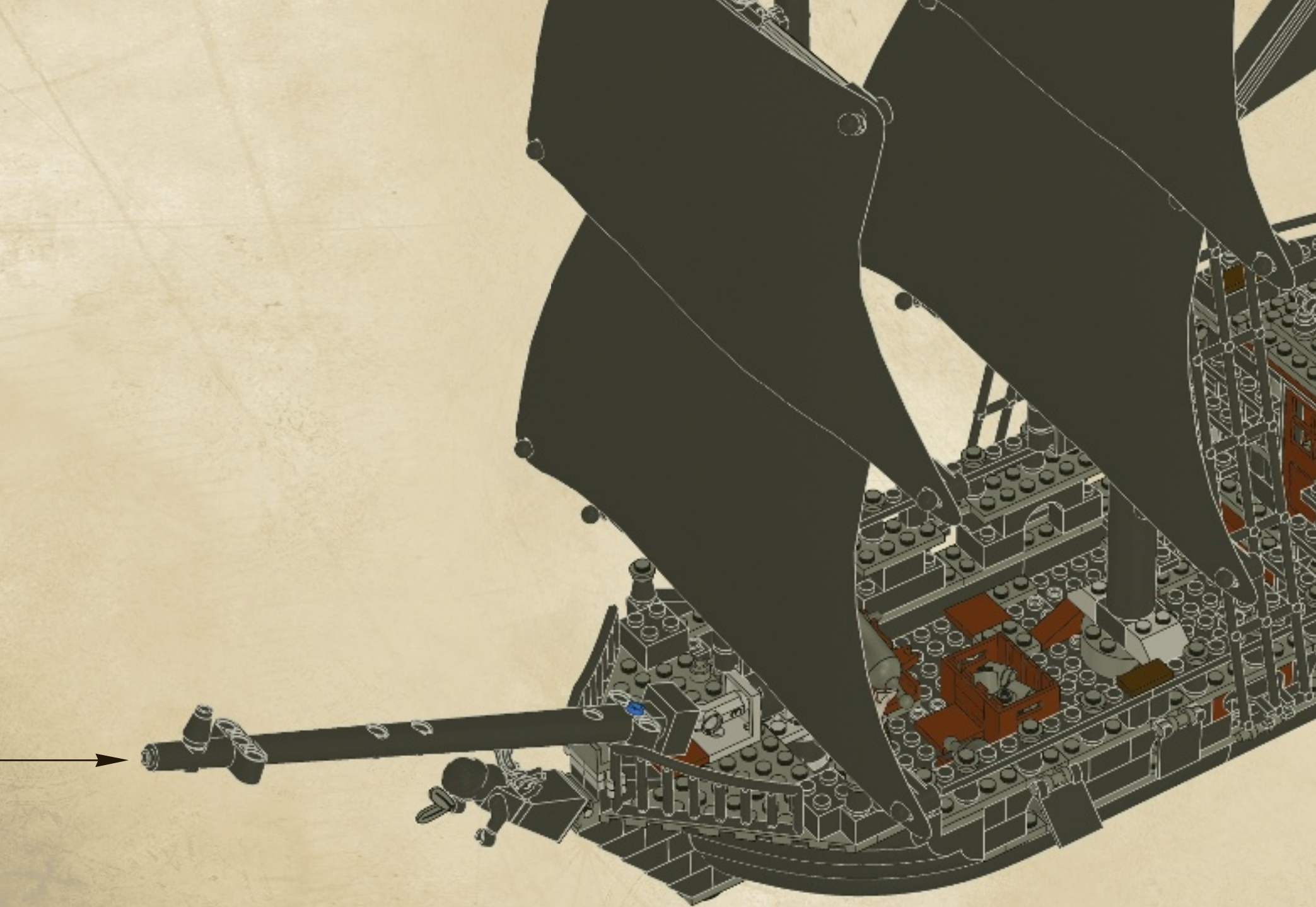

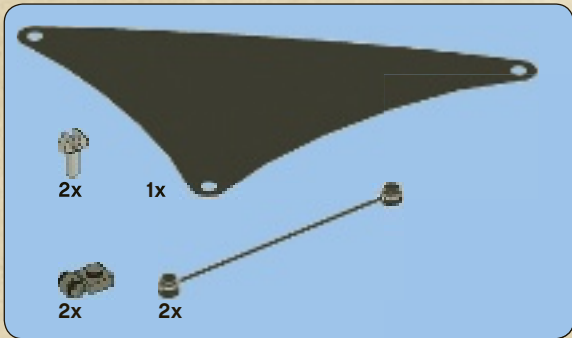
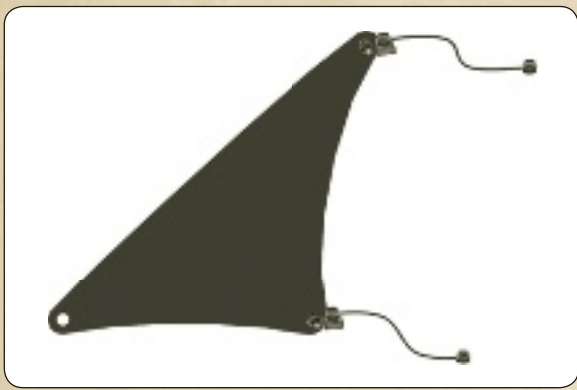

106

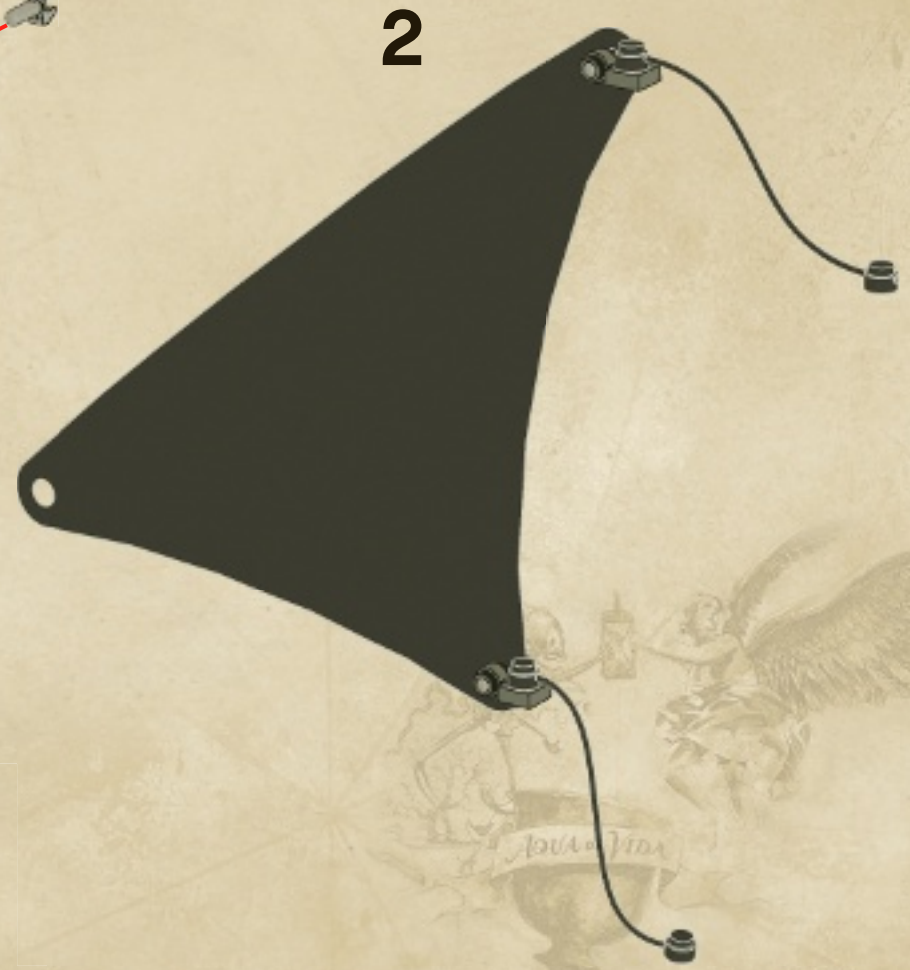
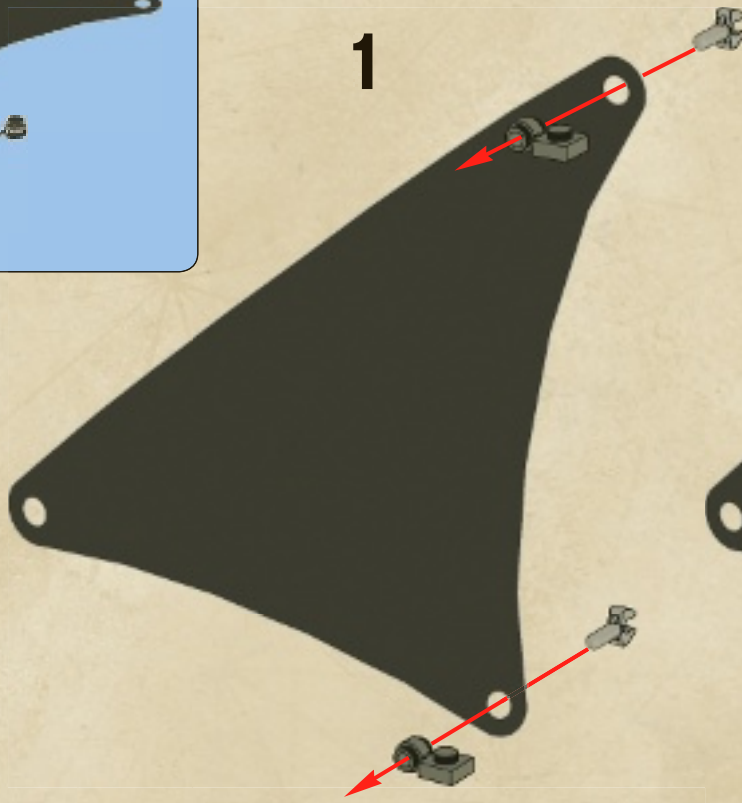

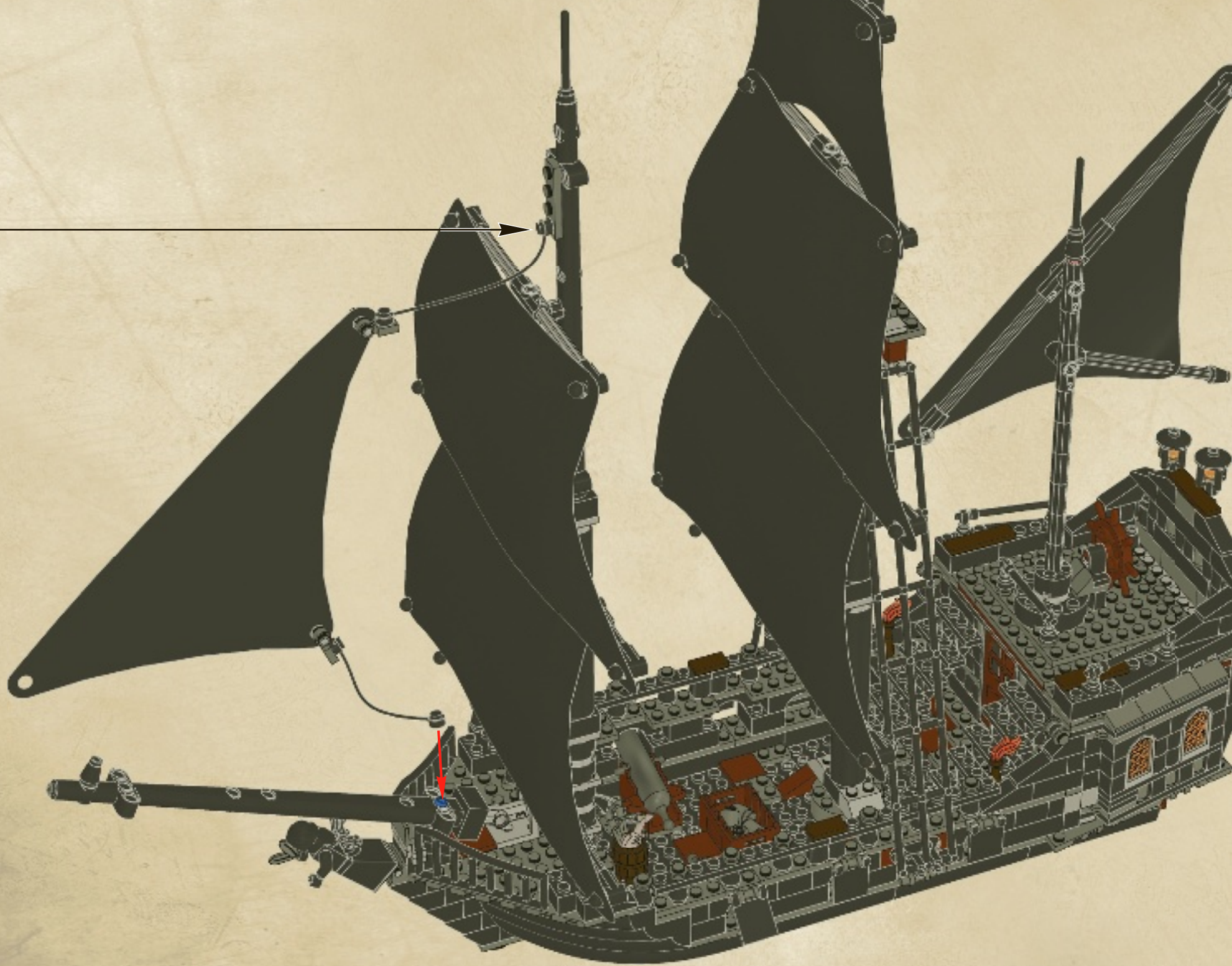



1x

107

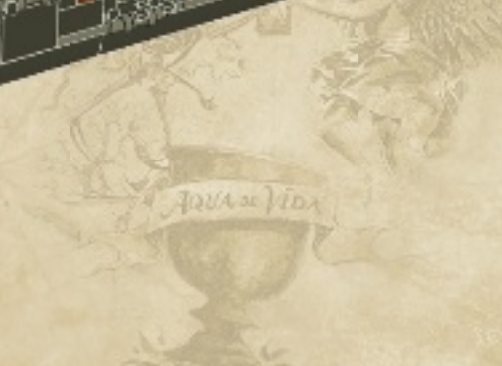



- 2x 300301
- 1x 4233225
- 1x 4645700
- 1x 4645701
- 1x 4585203
- 14x 4278422
- 4x 302421
- 11x 4142865
- 3x 4143005
- 3x 4206482
- 2x 4514553
- 32x 300526
- 24x 300326
- 2x 300226
- 4x 300126
- 8x 362226
- 4x 300926
- 30x 4644456
- 3x 4541890
- 2x 4644754
- 1x 4558957
- 2x 4644755
- 2x 4121966
- 4x 4636202
- 1x 4273703
- 5x 366026
- 18x 428626
- 10x 4581280
- 16x 365926
- 17x 302326
- 2x 4550017
- 2x 4632571
- 1x 4144024
- 4x 281726
- 3x 474026
- 1x 4647383
- 6x 4249857
- 1x 362626
- 1x 4515122
- 8x 614326
- 22x 4529236

- 1x 4535834
- 2x 4541896
- 2x 4620385
- 2x 4279270
- 7x 4523405
- 2x 395726
- 3x 4538722
- 1x 46263506
- 1x 4620400
- 3x 4532220
- 2x 4141580
- 1x 4647422
- 1x 4649785
- 2x 4647128
- 1x 384926
- 1x 4626967

- 11x 370526
- 3x 373726
- 1x 370826
- 7x 346026
- 4x 447726
- 4x 383226
- 2x 428226
- 2x 4528331
- 24x 4184169
- 18x 4107783
- 20x 4107085
- 17x 4121715
- 8x 4512363
- 2x 4220098

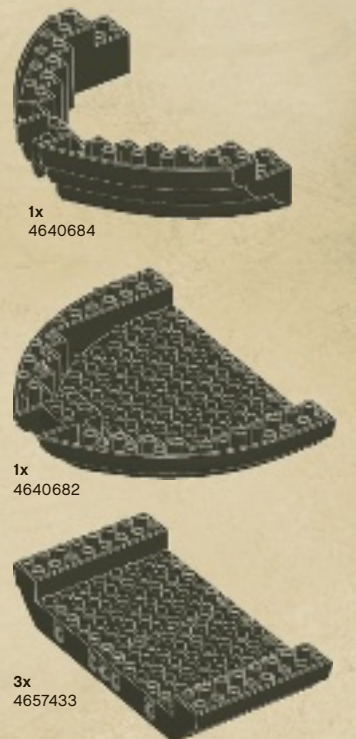



Disney PIRATES of the CARIBBEAN THE VIDEO GAME



The Pirates of the Caribbean © 2011 Disney. The Videogame software
© 2011 TT Games Publishing Ltd. Produced by TT Games under license from the Lego Group and Disney.
LEGO, the LEGO logo, the Brick and the Knob configurations and the Minifigure are trademarks of the LEGO Group. © 2011 The LEGO Group.

The Pirates of the Caribbean © 2011 Disney. Le logiciel du jeu Vidéo.
© 2011 TT Games Publishing Ltd. Produidido por TT Games sous licence du Groupe LEGO et Disney.
LEGO, le logo LEGO, les configurations de la brique et du tenon ainsi que la figurine sont des marques de commerce du Groupe LEGO. © 2011 Le Groupe LEGO.

Los Piratas del Caribe © 2011 Disney. El software del Videojuego
© 2011 TT Games Publishing Ltd. Producido por TT Games bajo licencia de the Lego Group y Disney.
LEGO, el logo LEGO, y las configuraciones del Brick y el Perno y la Minifigura son marcas registradas de the LEGO Group. © 2011 The LEGO Group.



videogames.LEGO.com





NINJAGO

Masters of Spinjitzu



2012



www.LEGOclub.com



LEGO® Club Email



LEGO® Club Magazine

LEGO club™

FREE! GRATIS! GRATUIT!

SIGN UP ONLINE!
www.LEGOclub.com

VISIT THE WORLD'S
BIGGEST LEGO® SHOP!
www.LEGOshop.com

GO TO
www.LEGOclub.com

00800 5346 5555*

1-866-534-6258 • 1-877-518-5346

US & Canada only

Canada seulement



- * Freephone. Mobile charges may apply.
- * Numéro sans frais. Des frais peuvent s'appliquer avec les téléphones cellulaires.
- * Gebührenfrei, Kosten für Anrufe aus Mobilfunknetzen können abweichen.
- * Gratis telefoonnummer vanaf vaste lijn.
- * Det er et gratis nummer, når du ringer fra fasttelefon.
- * Det är gratis, när du ringer från en fast telefon.
- * Numéro sans frais. Des frais peuvent s'appliquer avec les téléphones portables.

