

44012\_44013

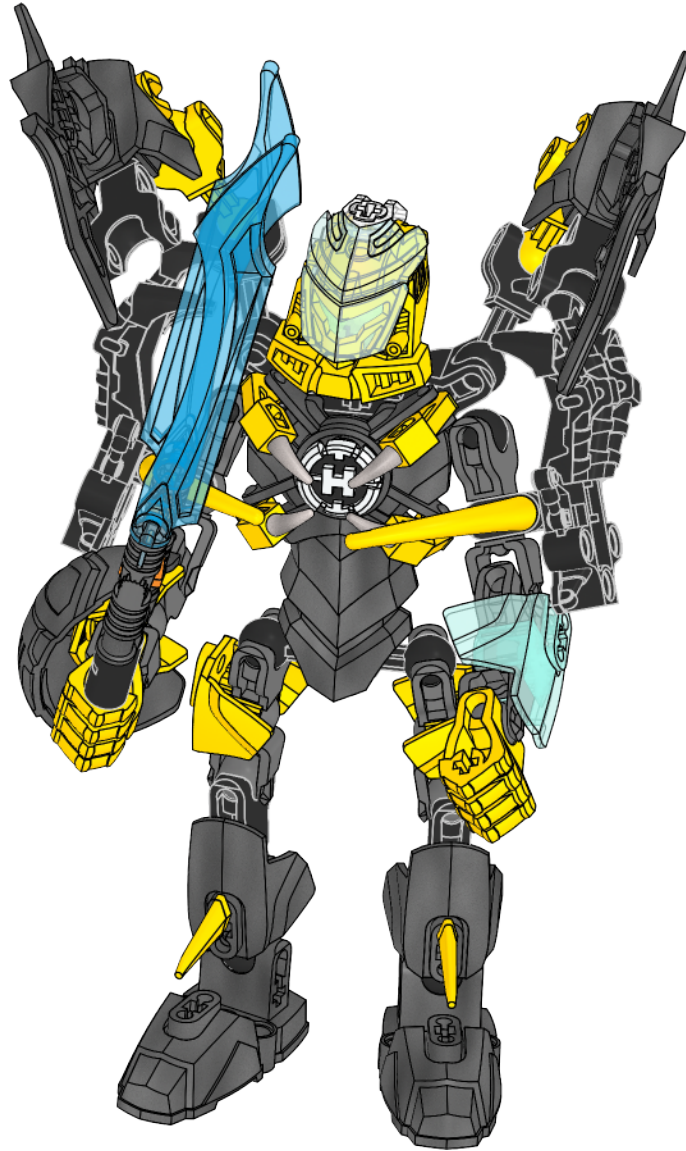

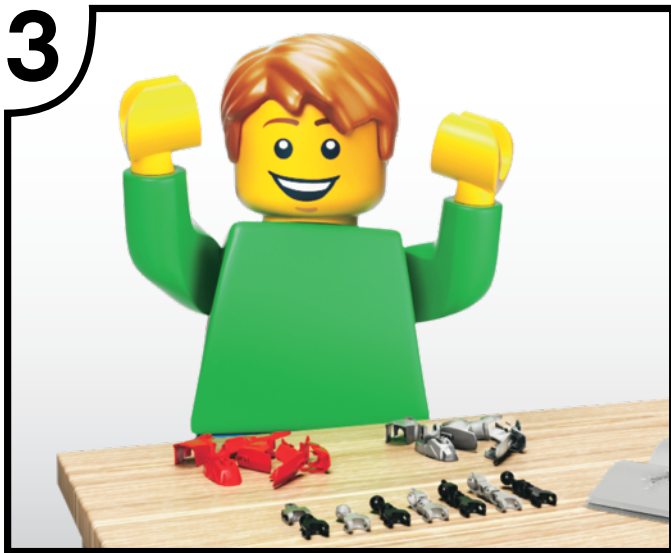

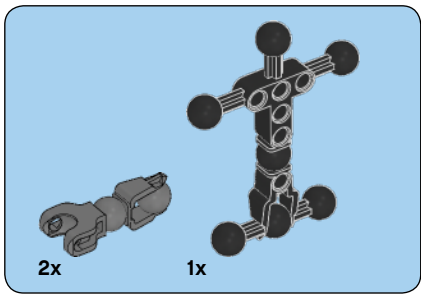

1

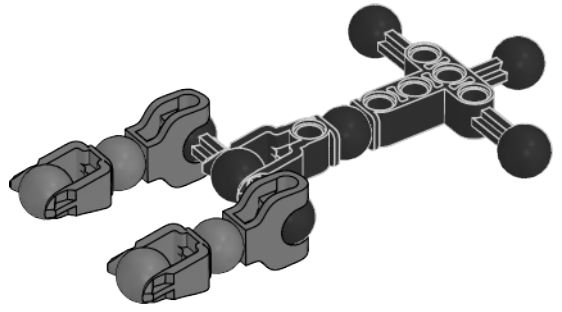

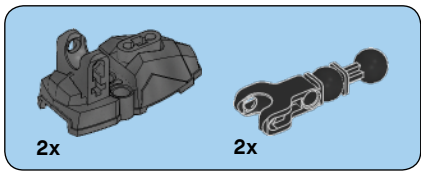

2

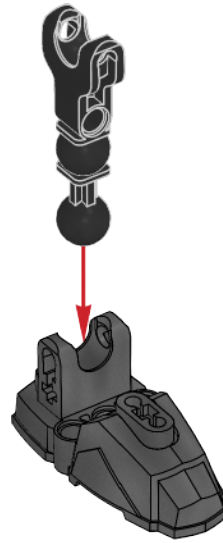

2x

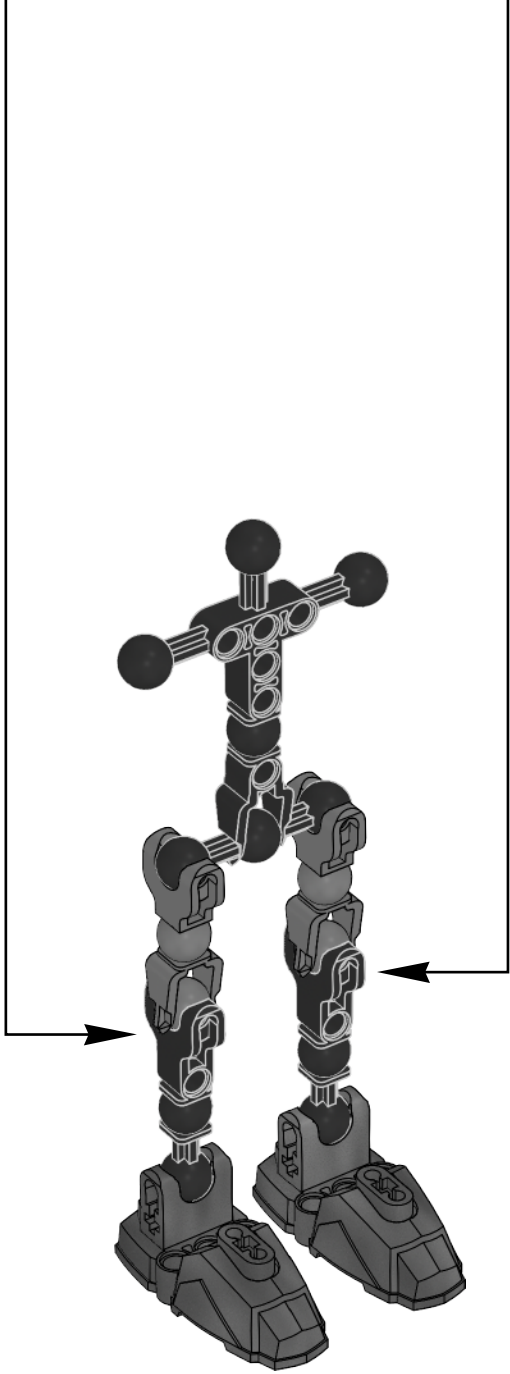

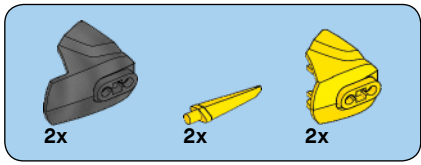

3

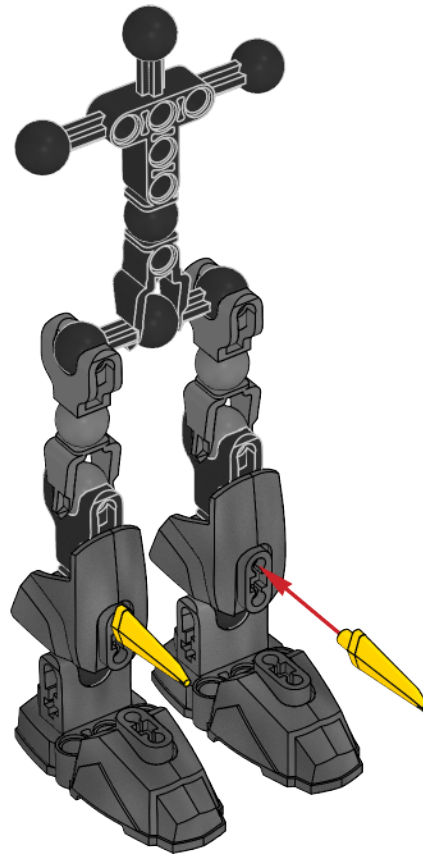

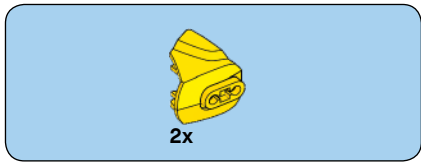

4

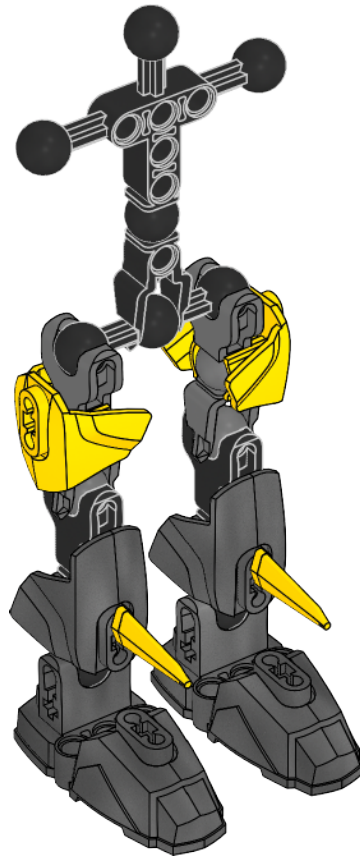

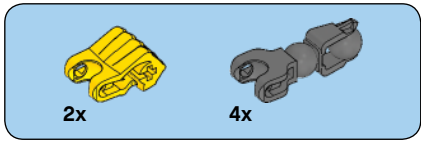

5

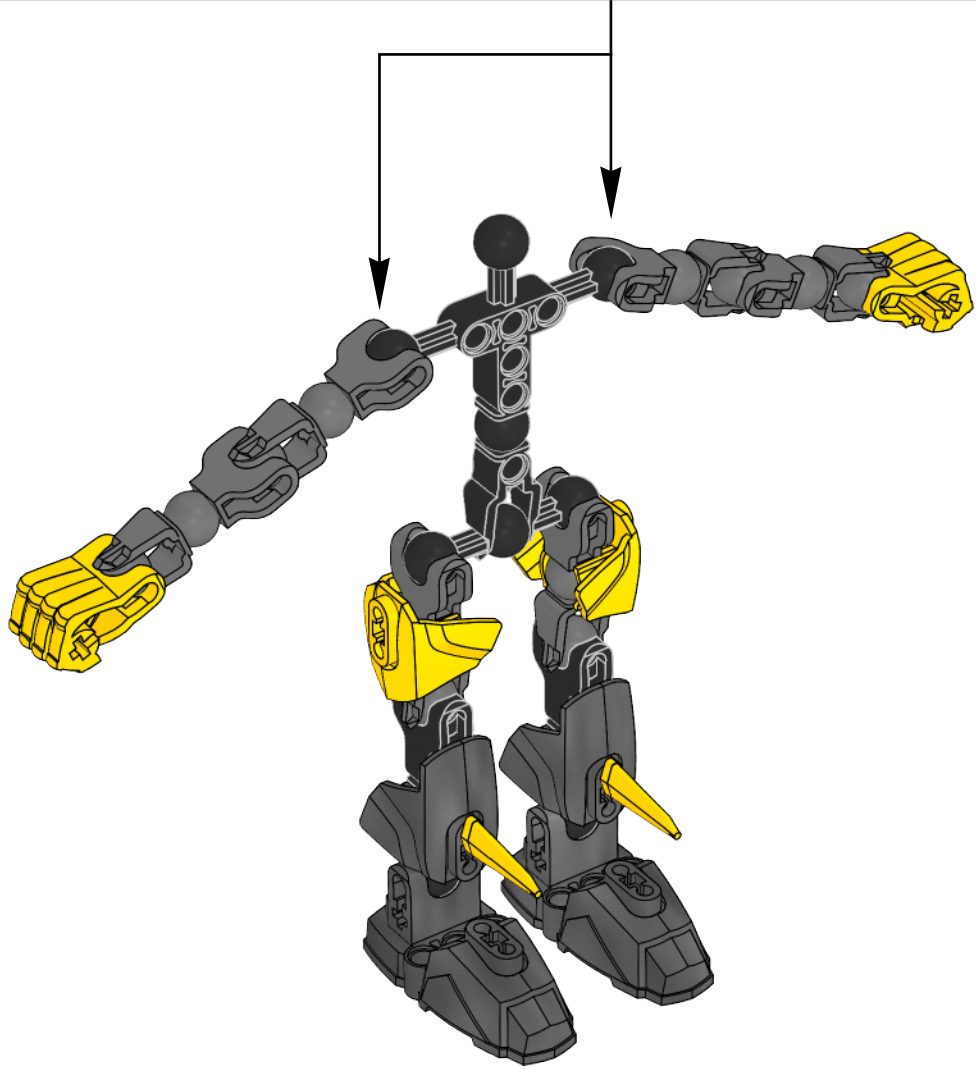
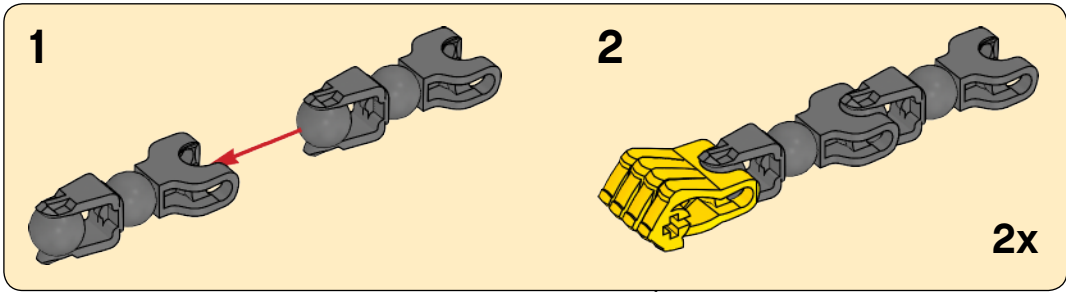



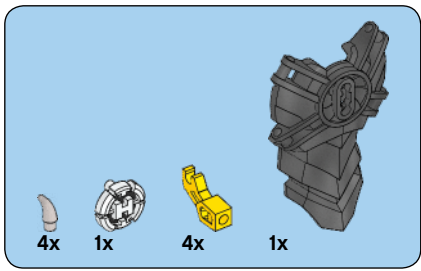

6

1

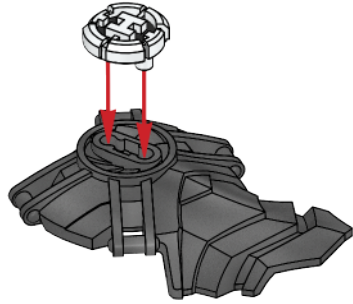

2

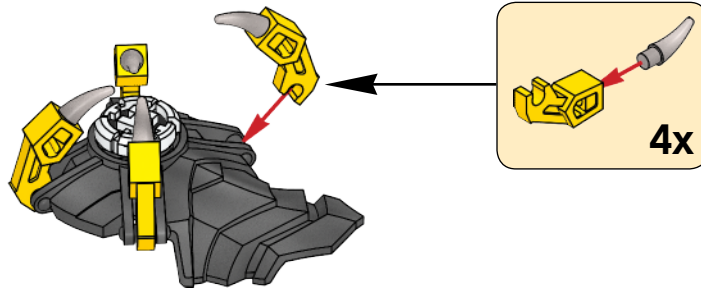

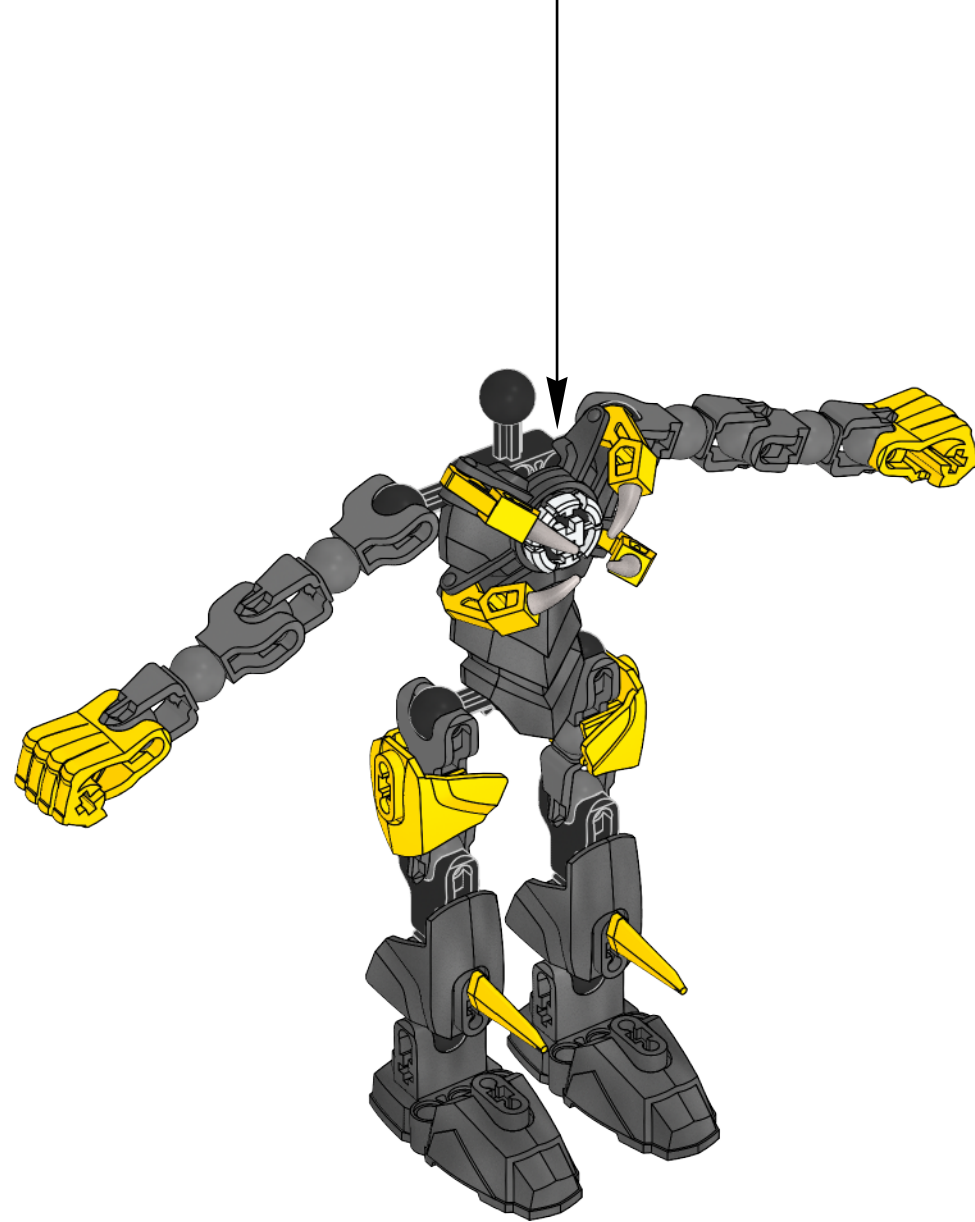

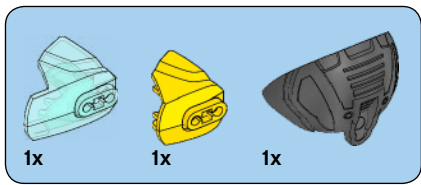

7

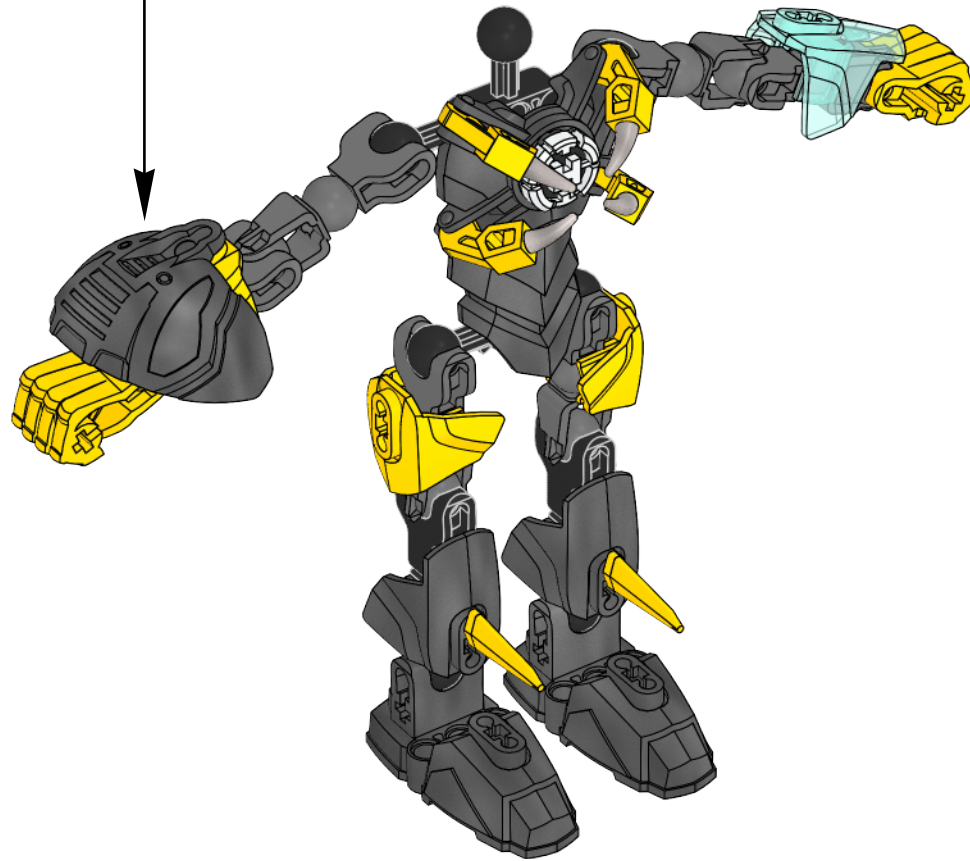
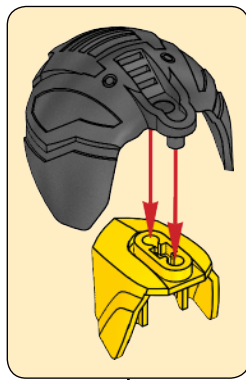

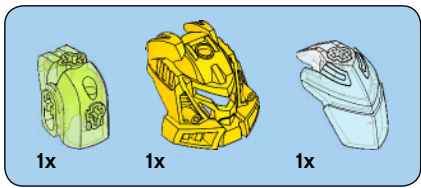

8

1

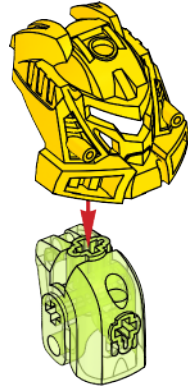

2

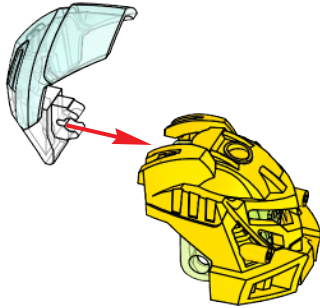

3

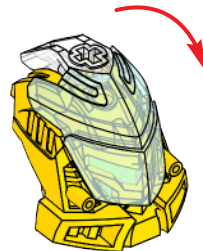

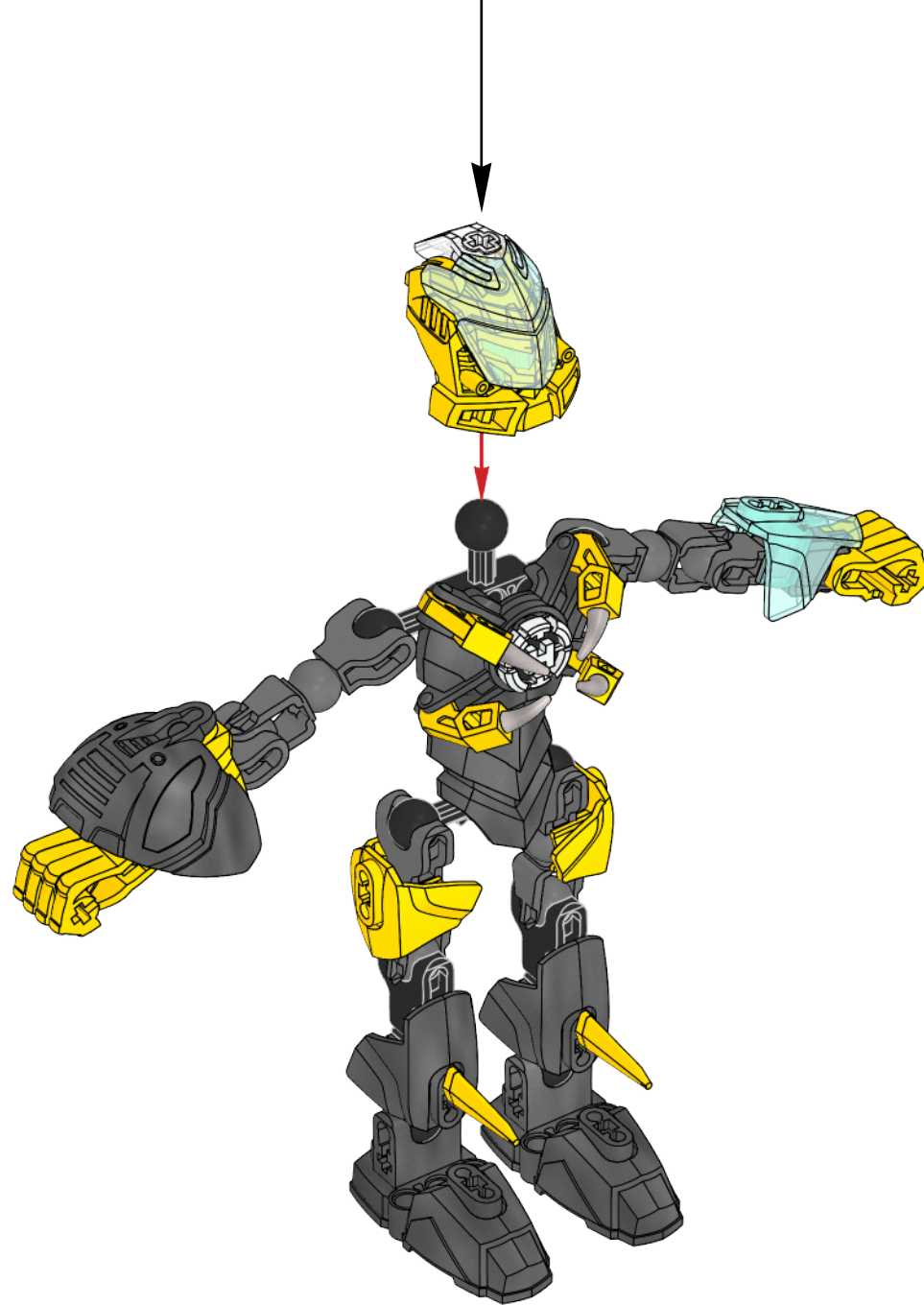

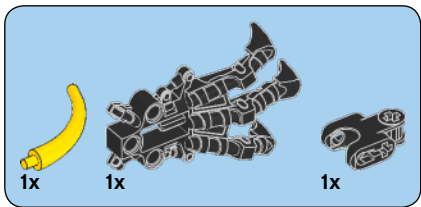

9

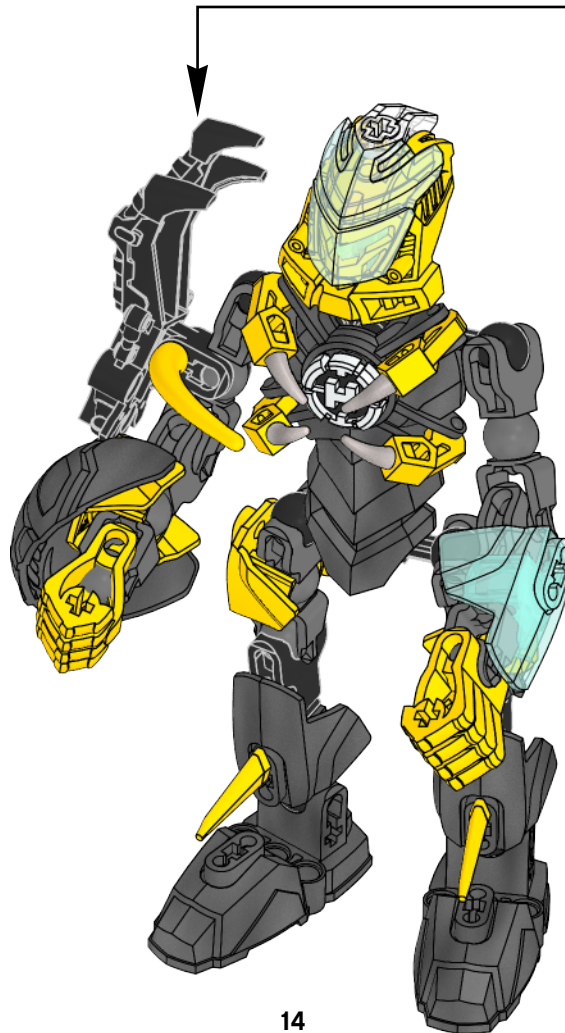
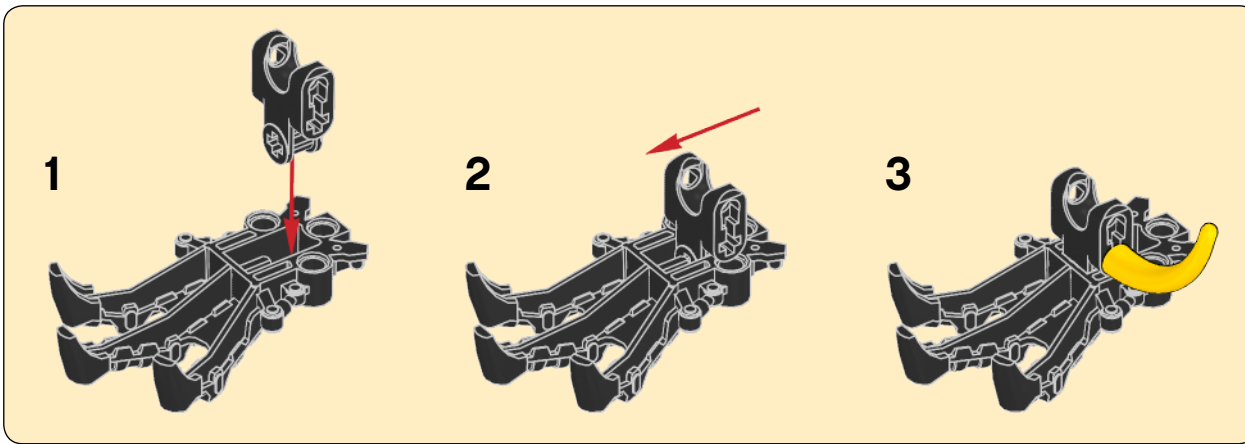

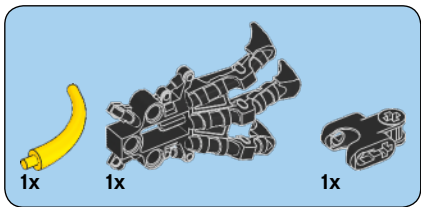

10

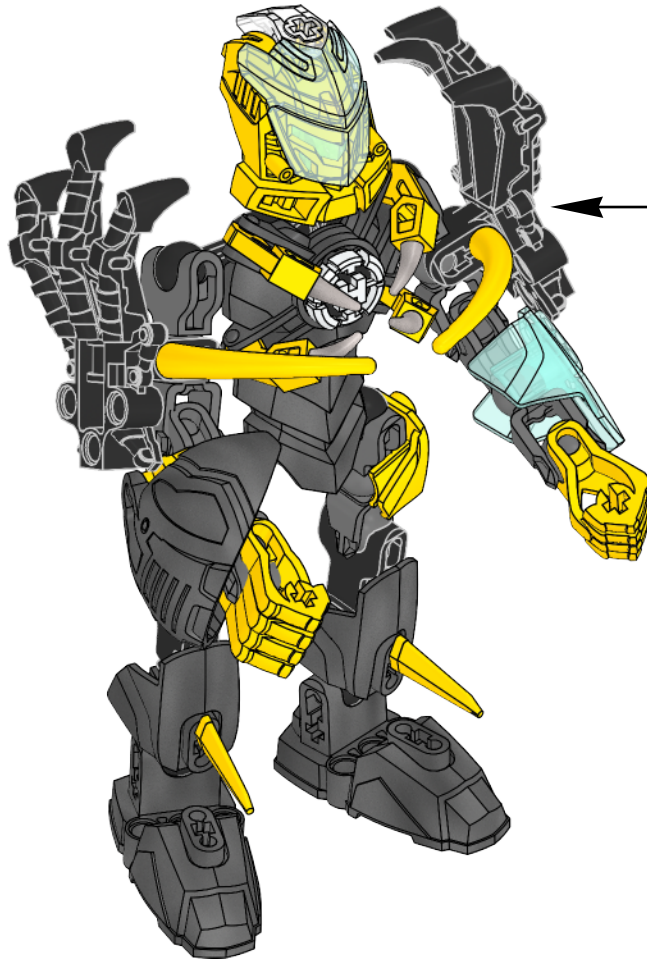
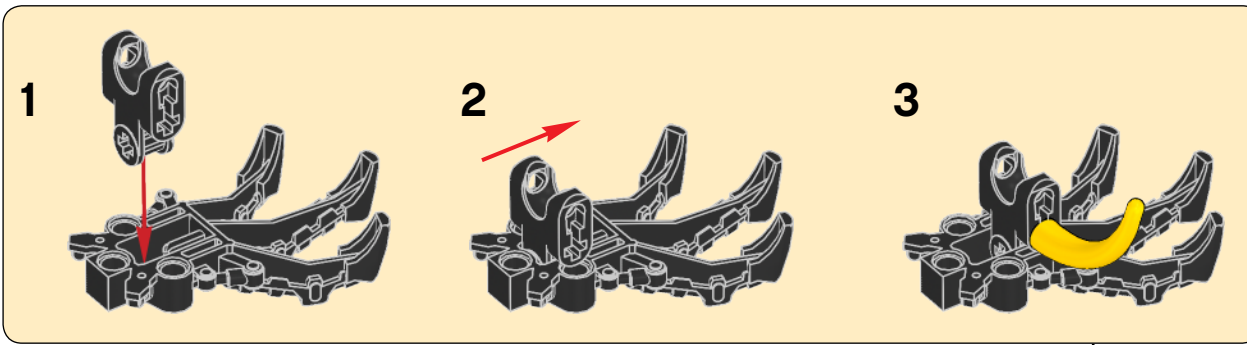

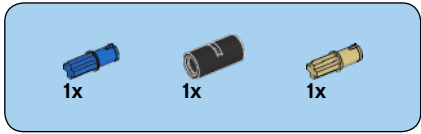
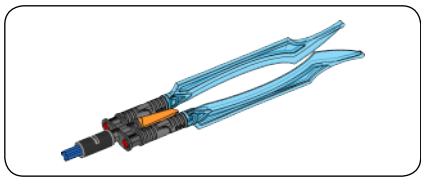

**1**

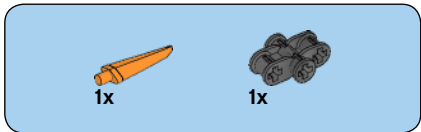
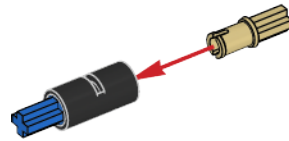

**2**

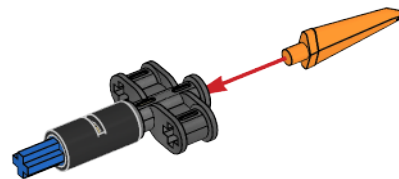



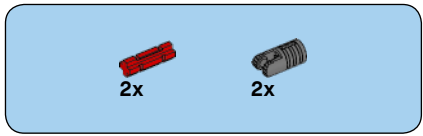

3

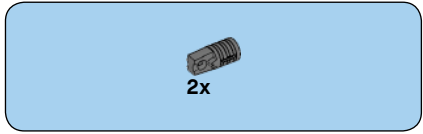
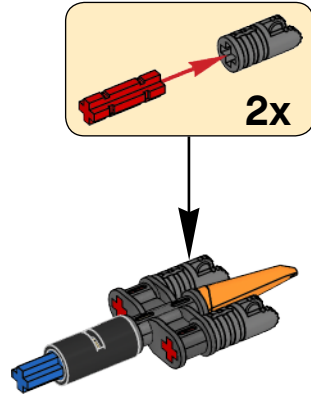

4

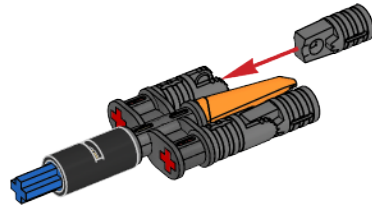

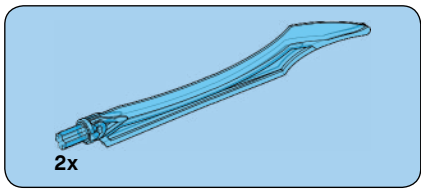

5

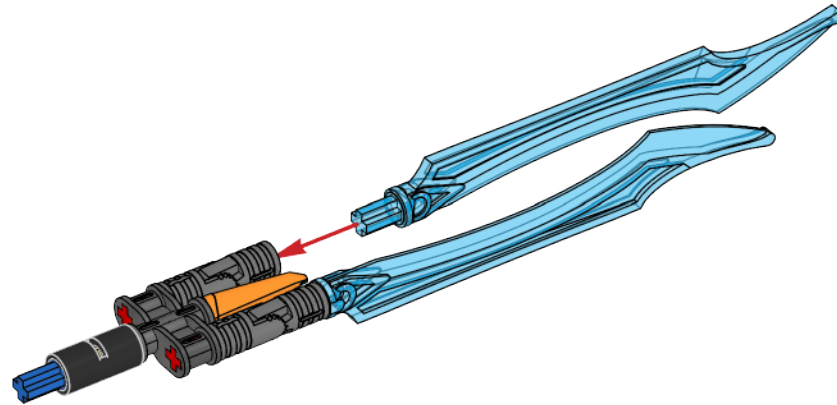

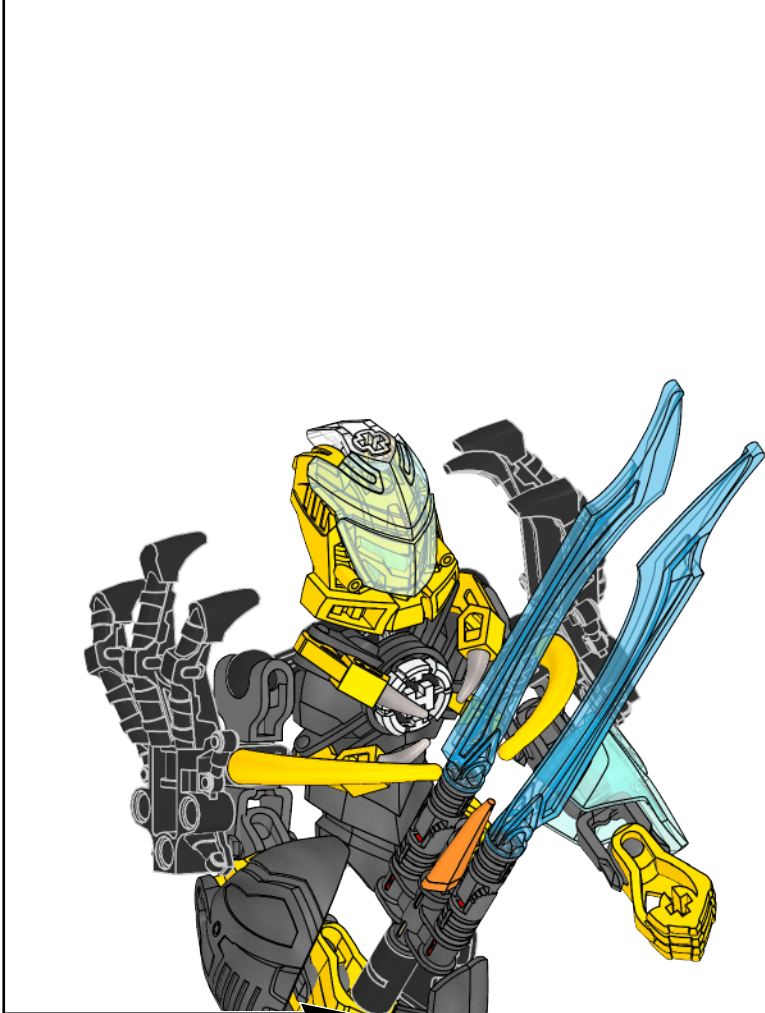

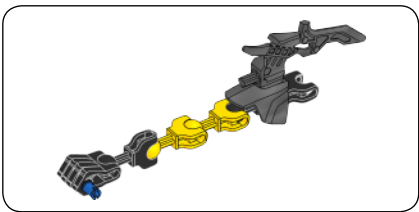

1

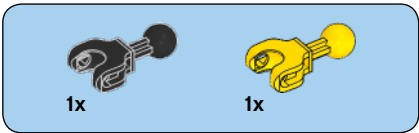
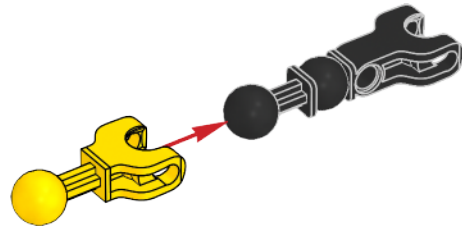

2

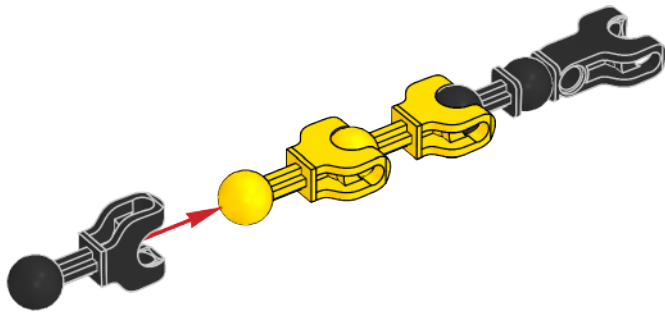

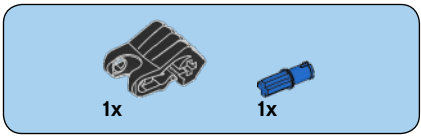

3

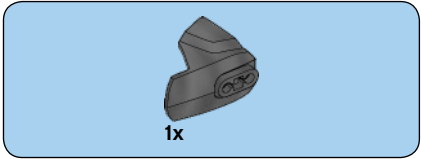
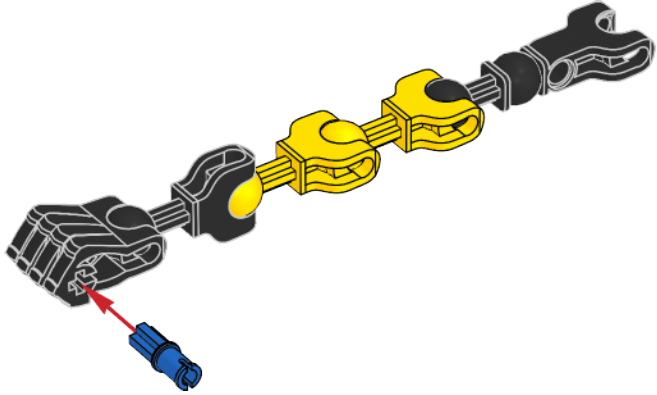

4

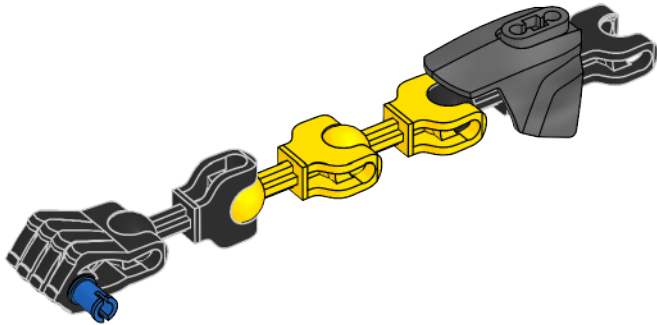

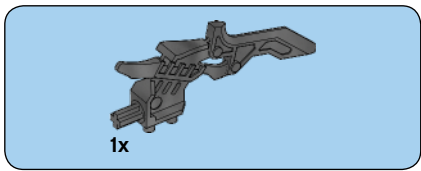

5

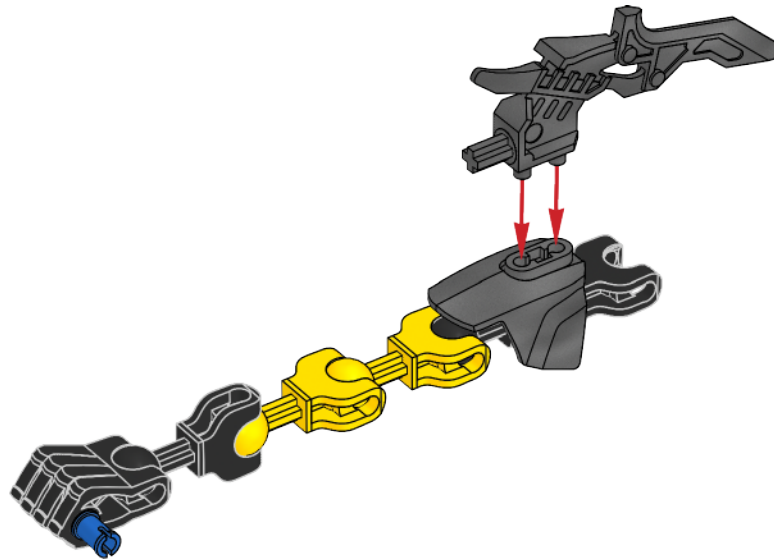

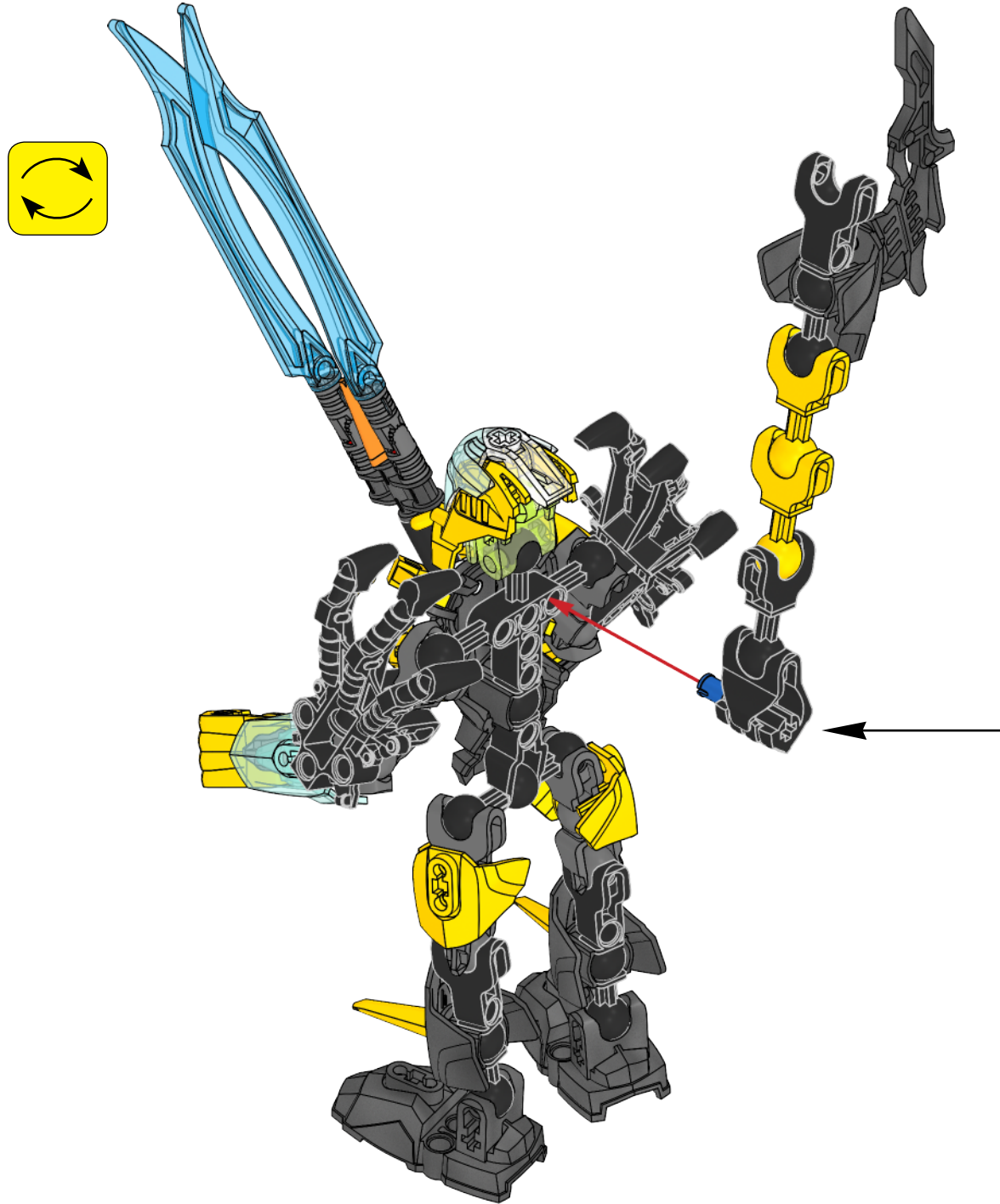

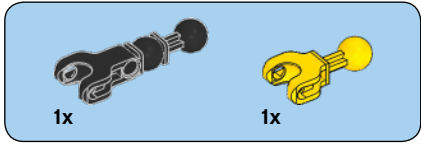
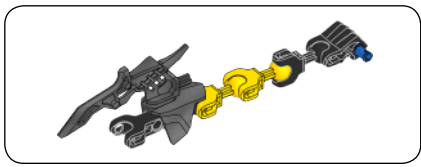

1

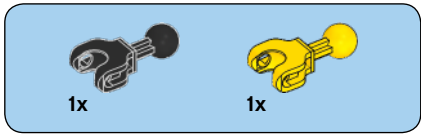
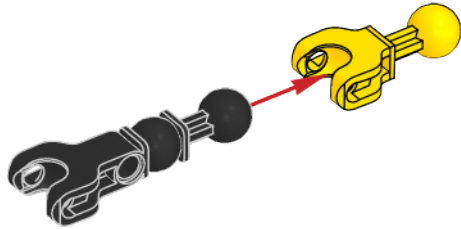

2

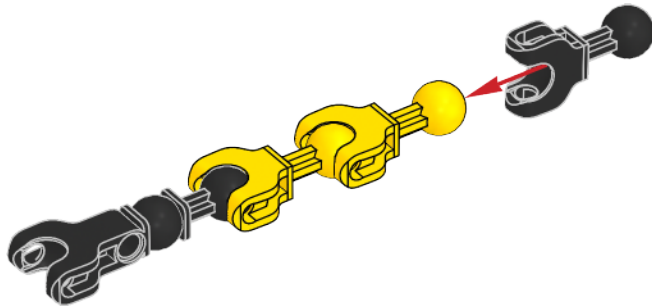



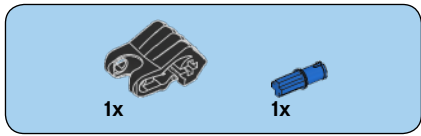

3

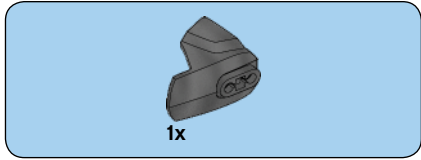
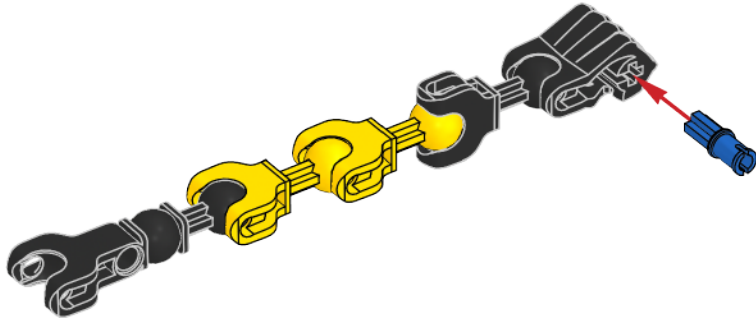

4

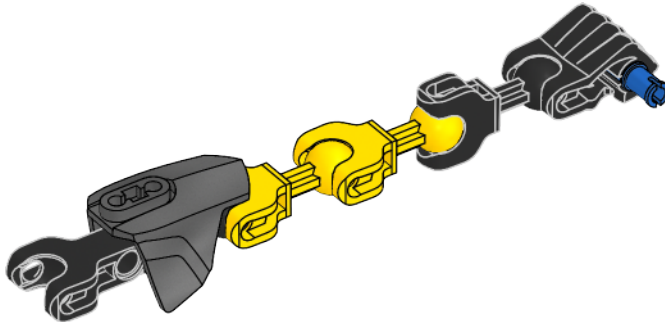

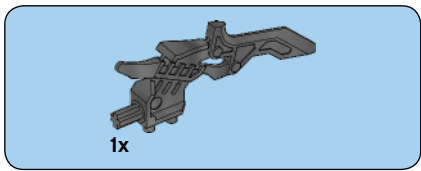

5

