

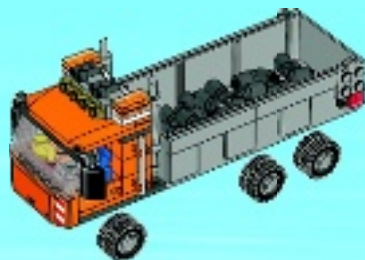

CITY

4434





1

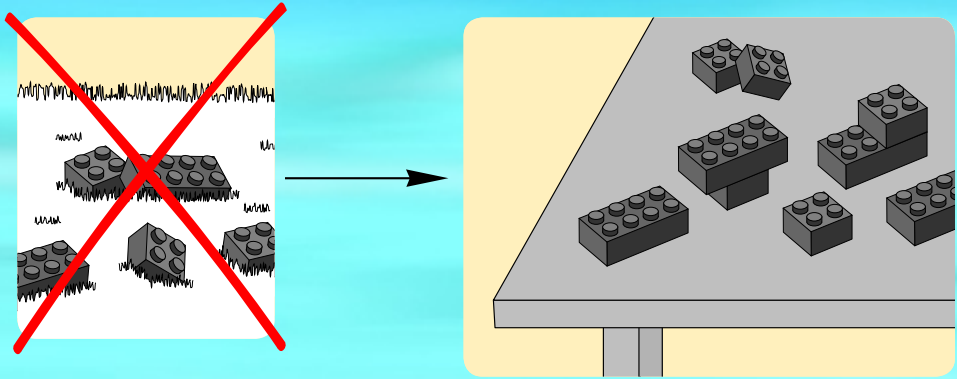

2

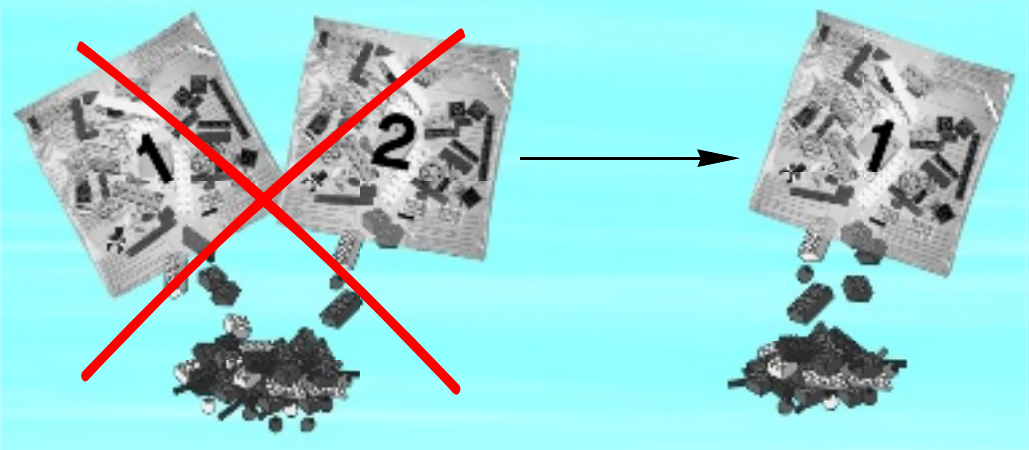

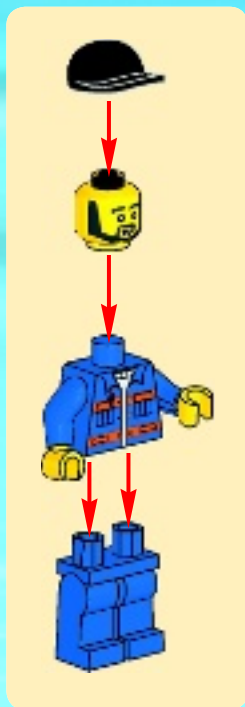
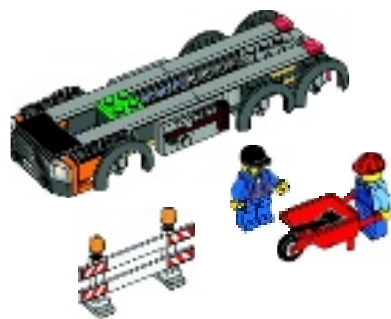

1



2



3



1

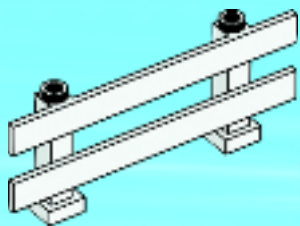

2

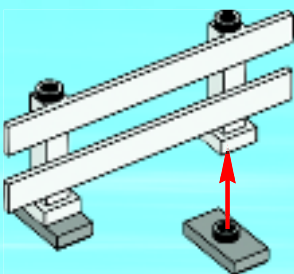

3

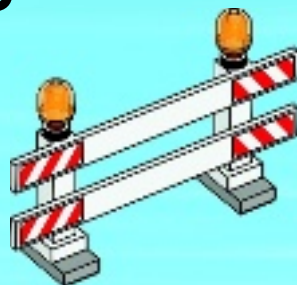



1

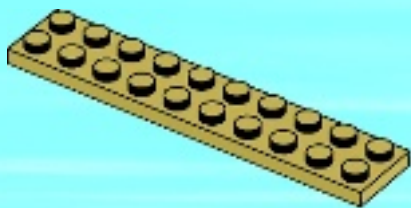

2

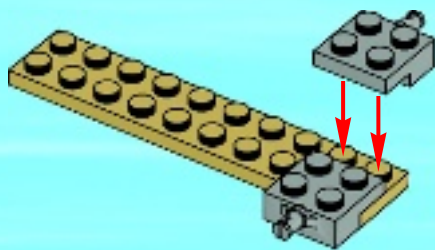

3

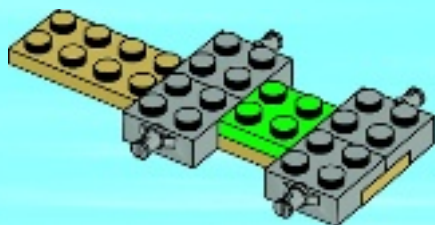

4

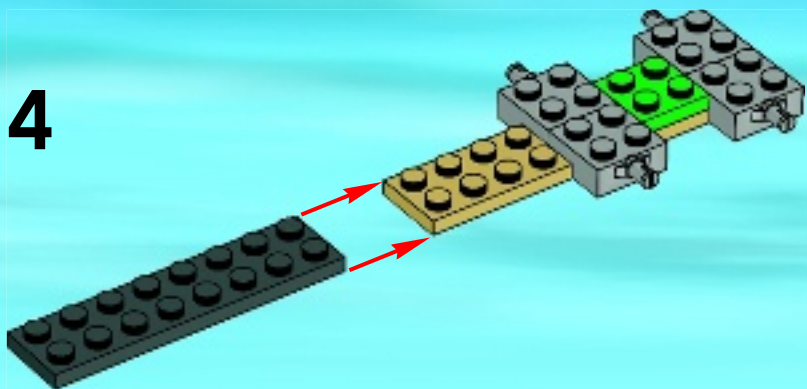

5

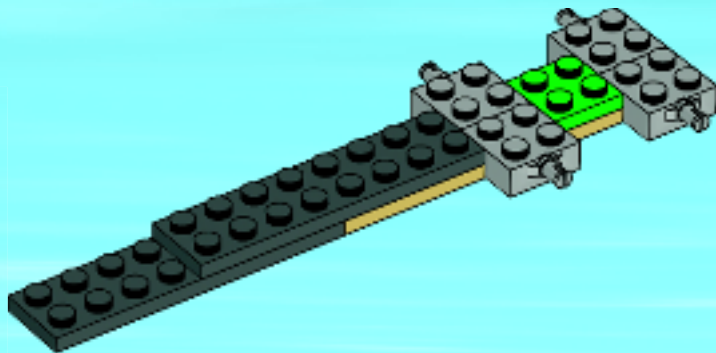

6

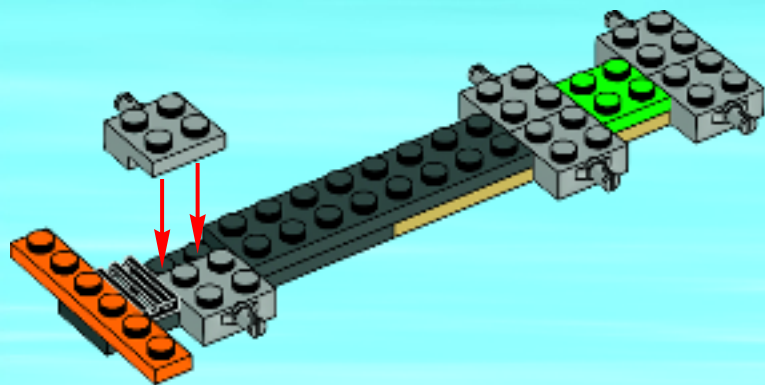

7

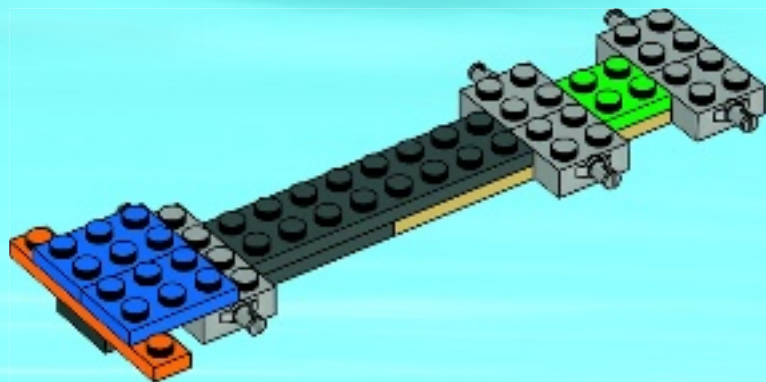

8

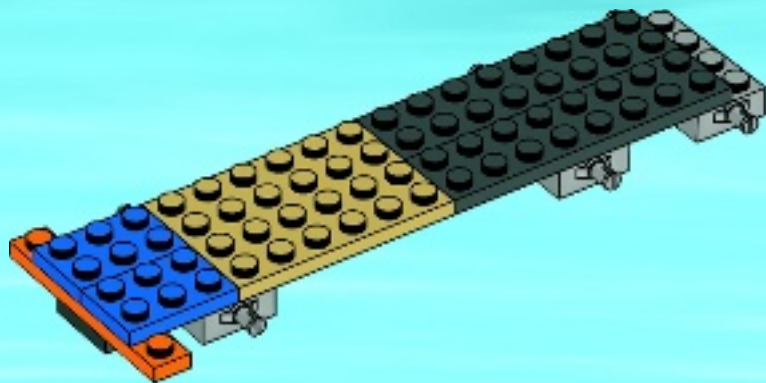

9

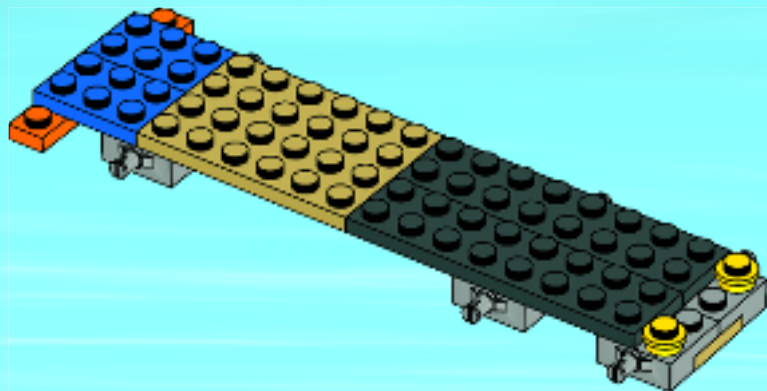

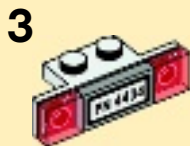
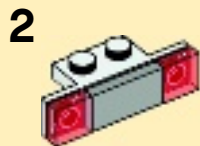
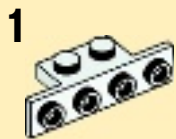

10

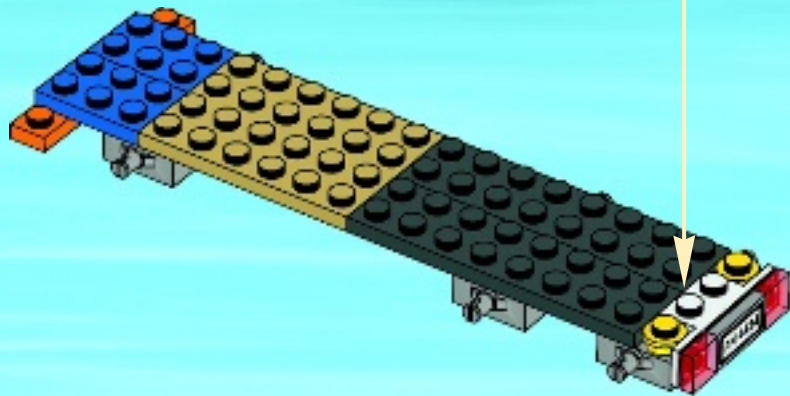

11

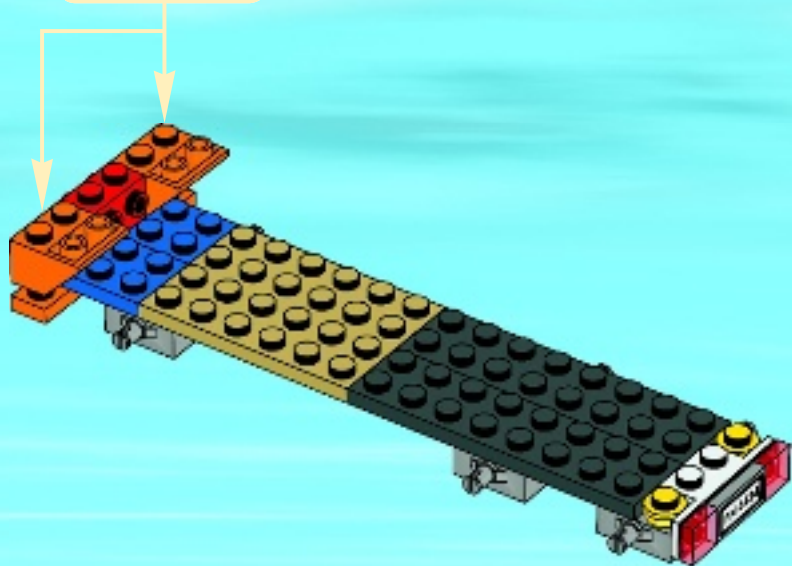

12

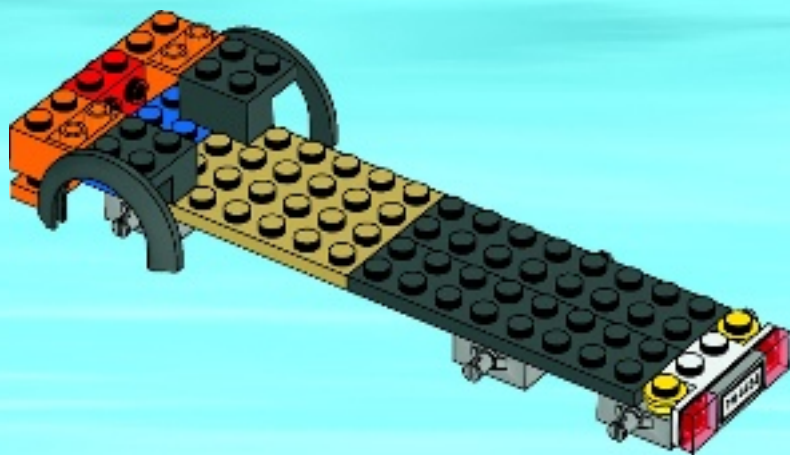

13

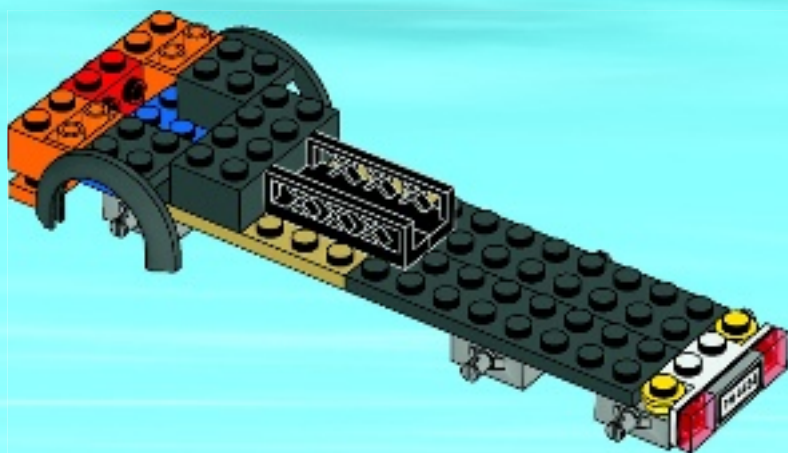

14

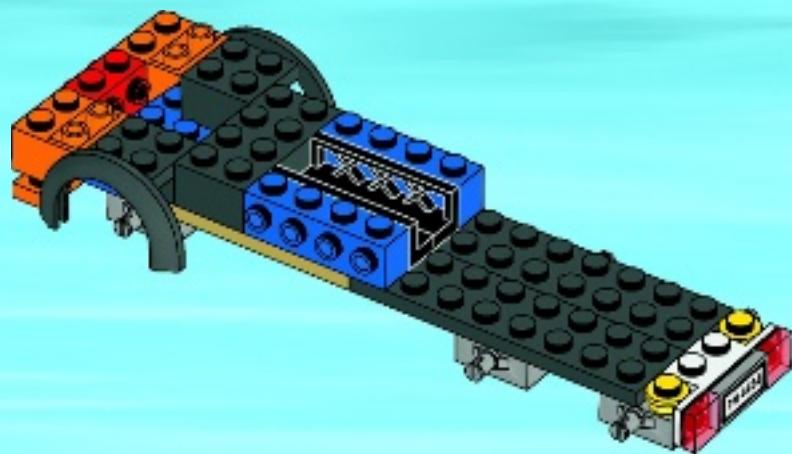

15

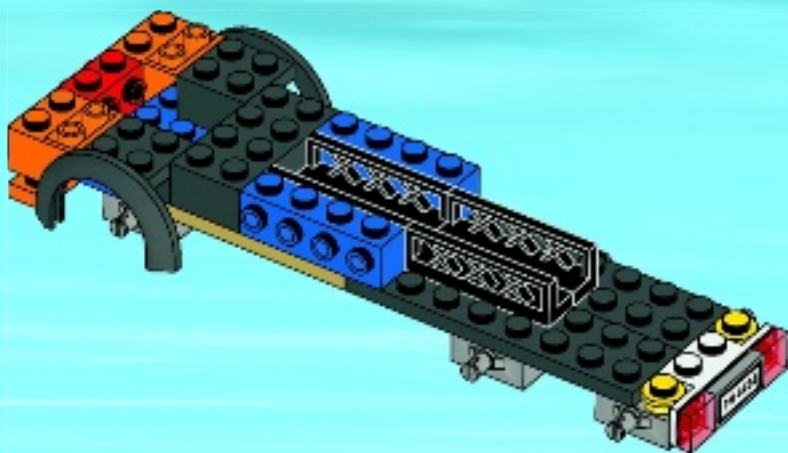

16

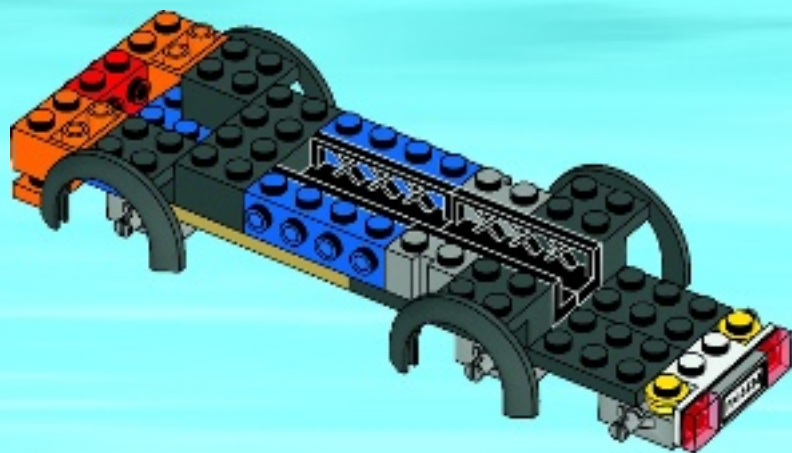

1

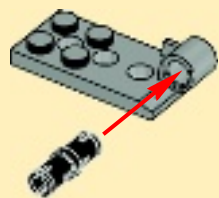

2

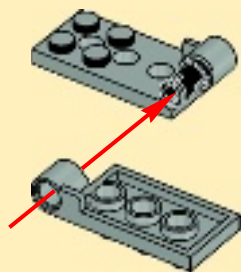

3

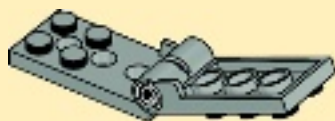

17

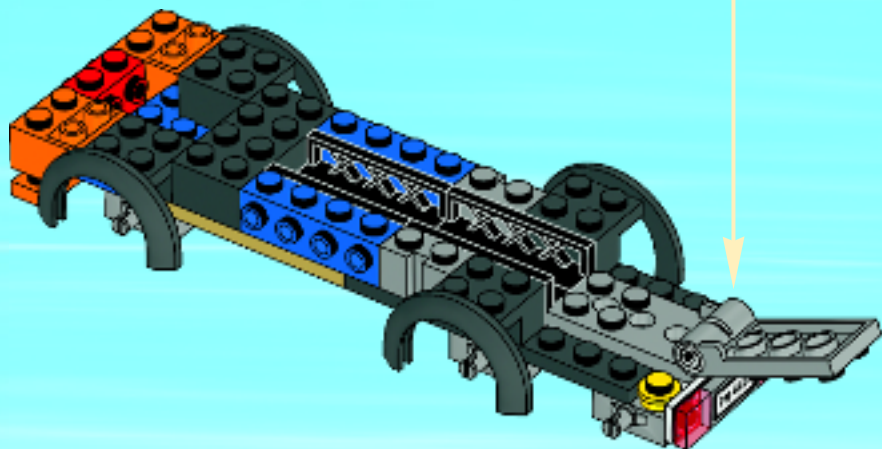

18

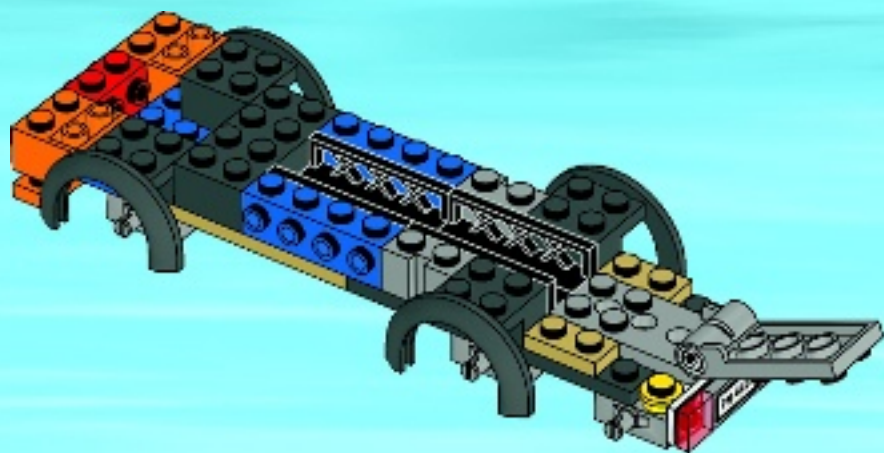

19

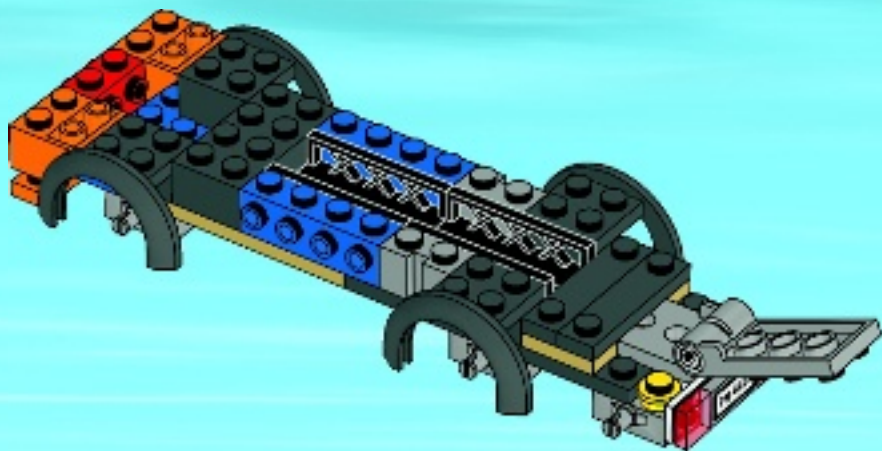

20

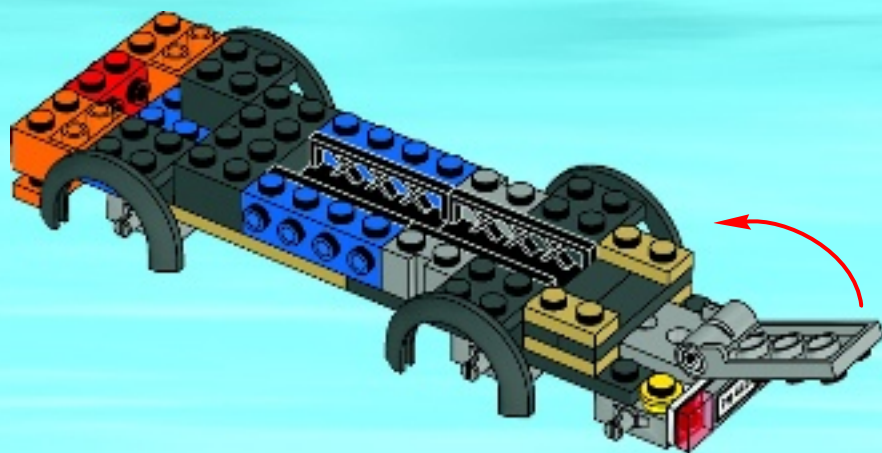

21

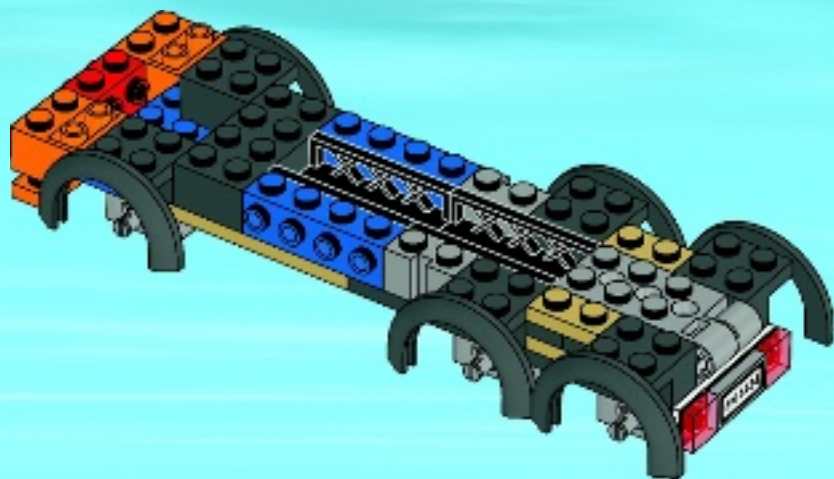

1

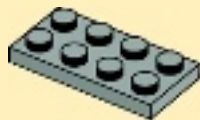

2

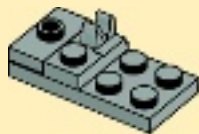

3

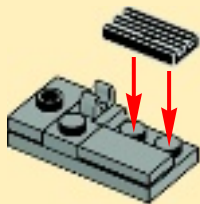

2x

22

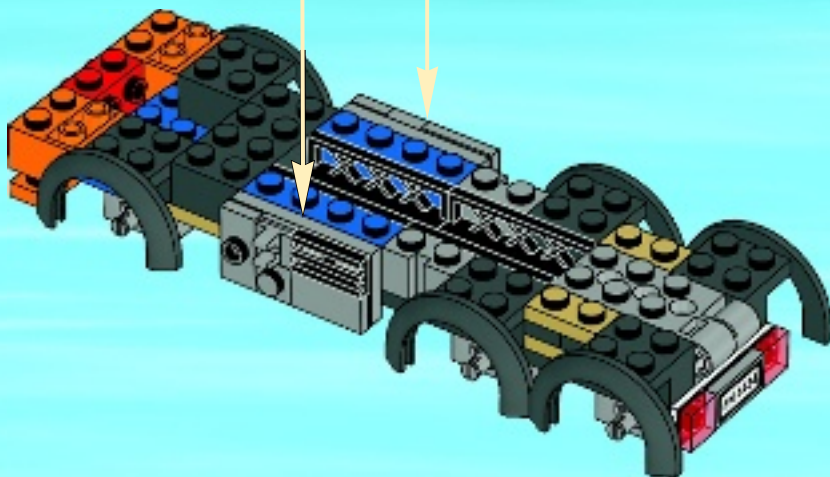

1



2



3

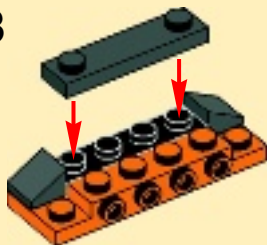

4



23

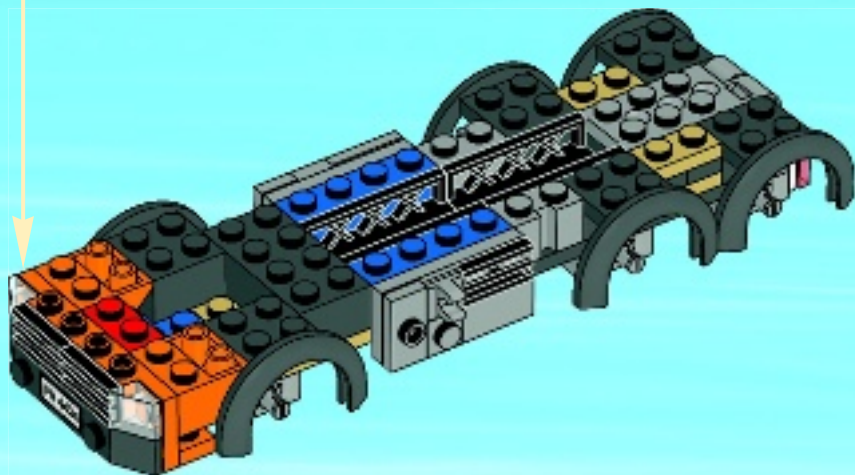

24

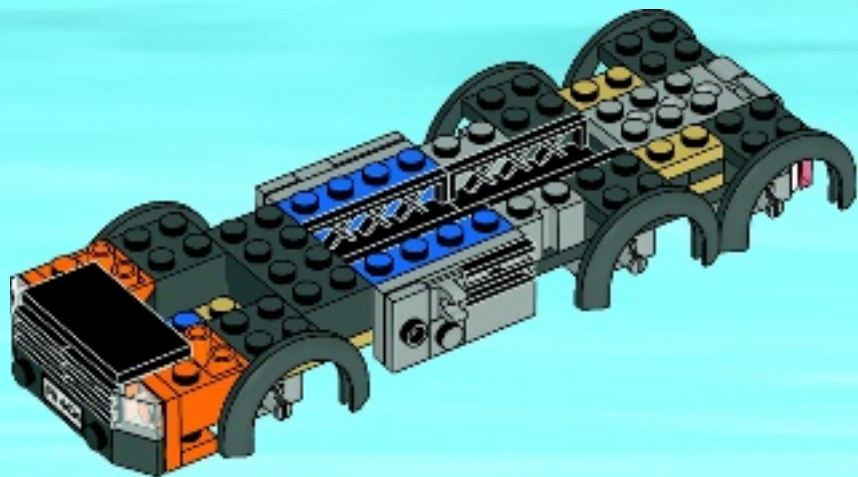

25

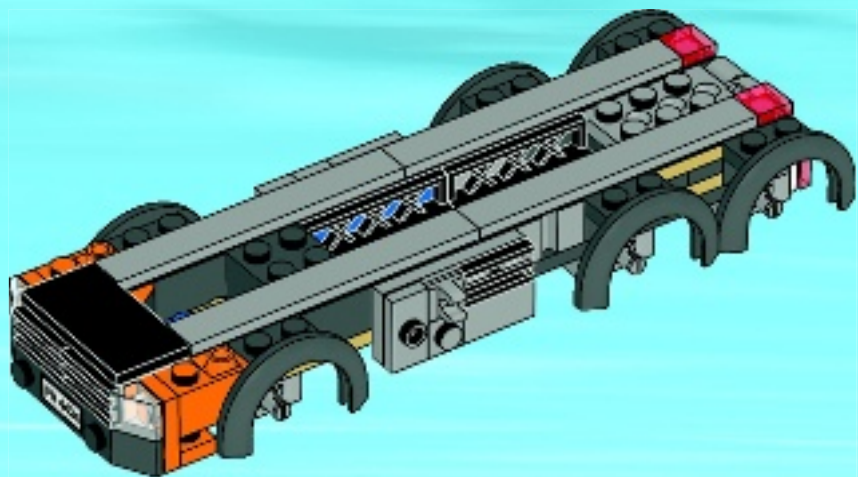

26

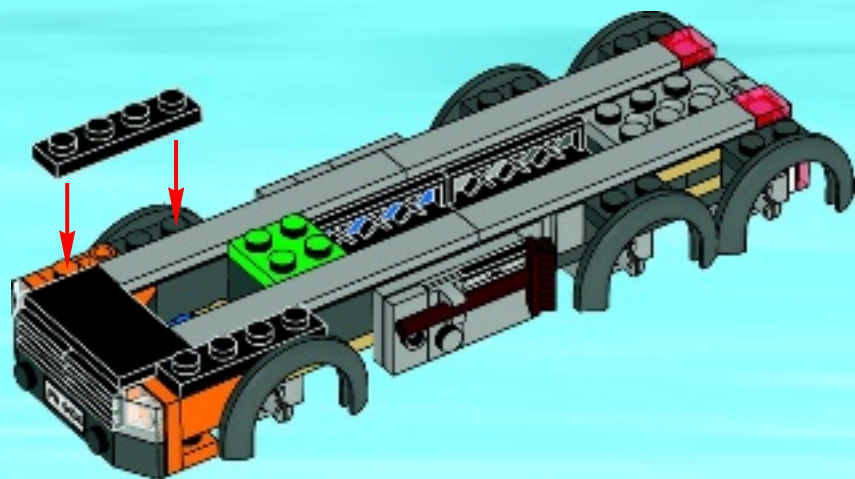



1



2



3



4



5

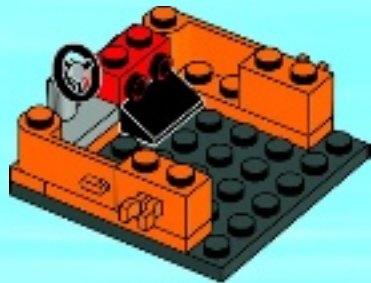

6



7



8

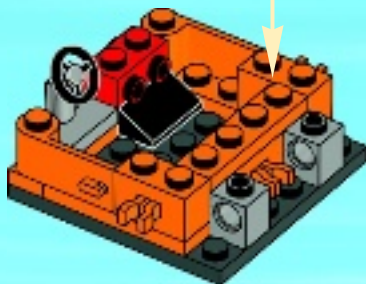

1



2



3

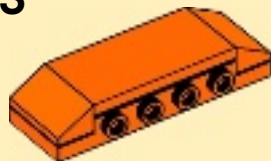

4



9



10



11

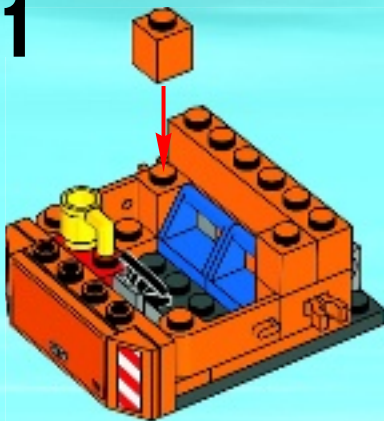

12

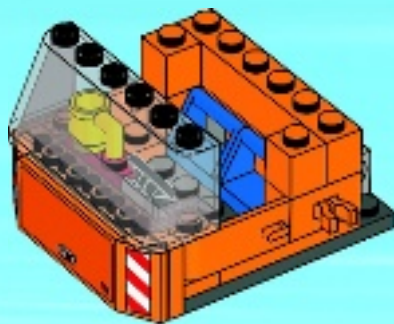

13

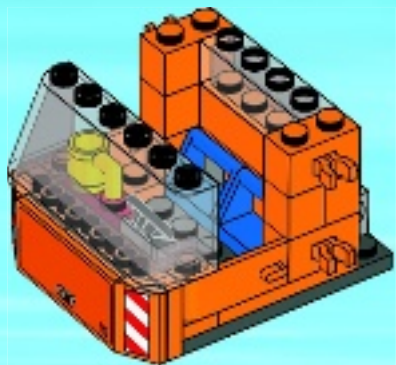

14

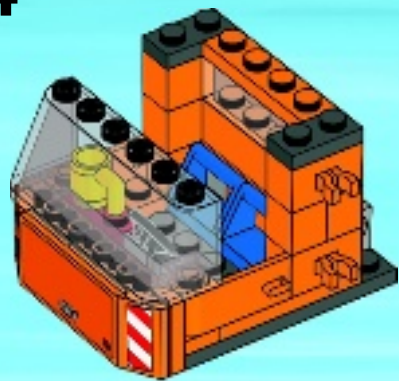

15

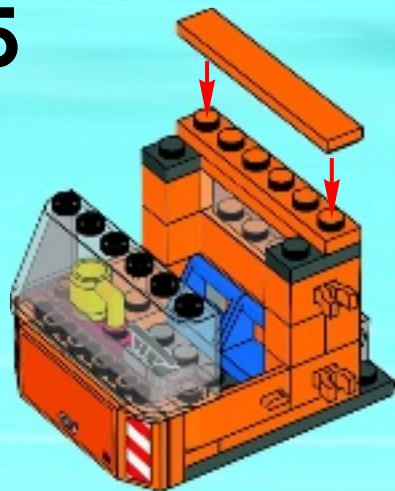

16

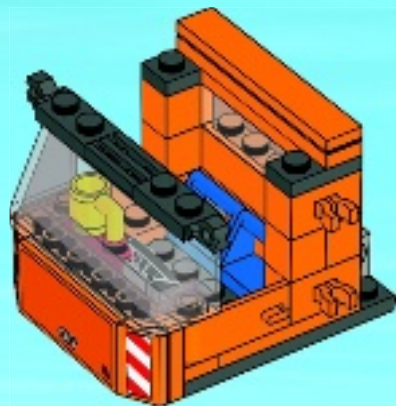

17



18

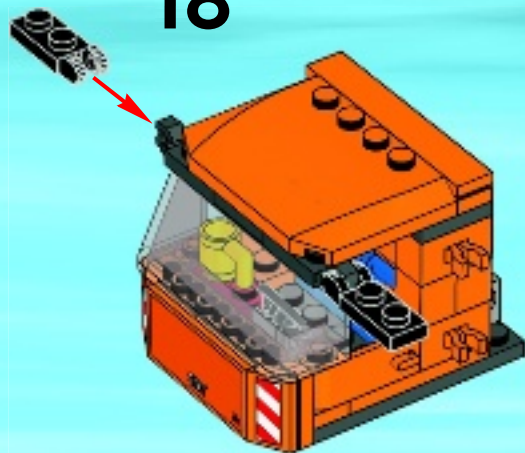

19

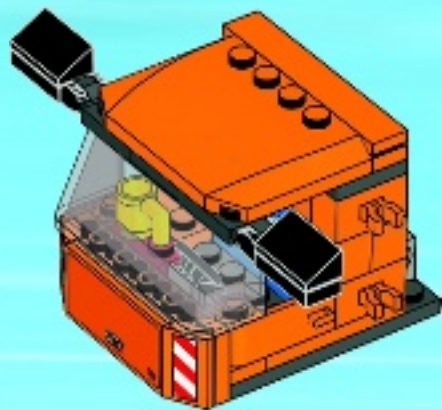

20

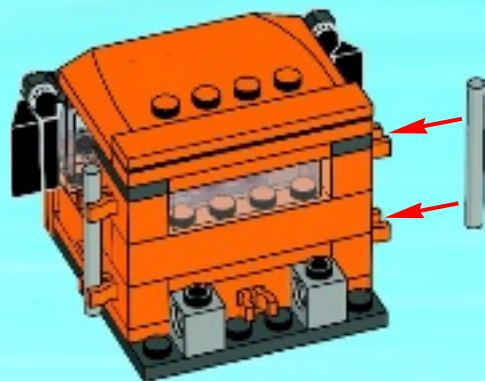

21

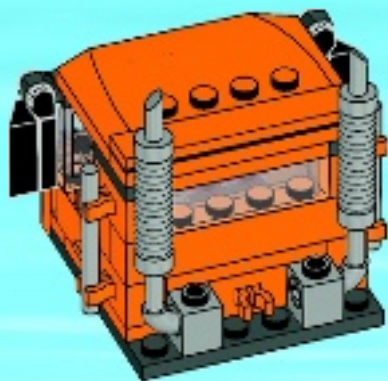

22

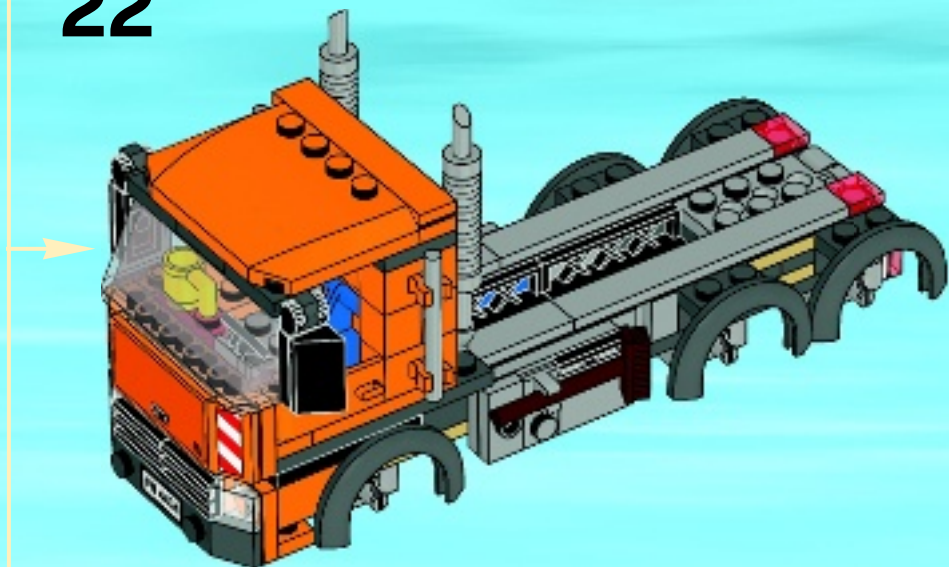



1

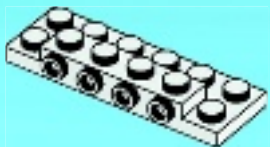

2

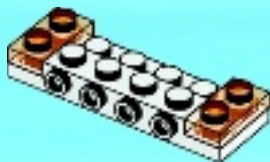

3

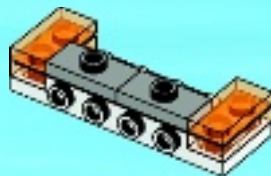

4

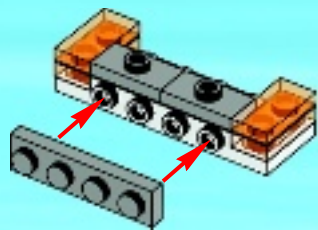

5



6



23

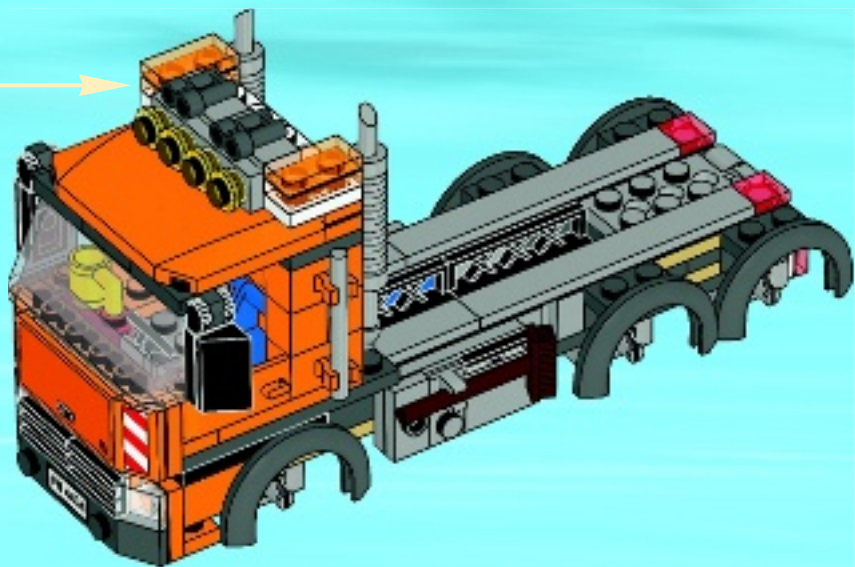

24

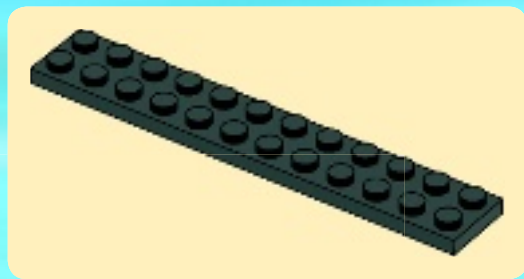
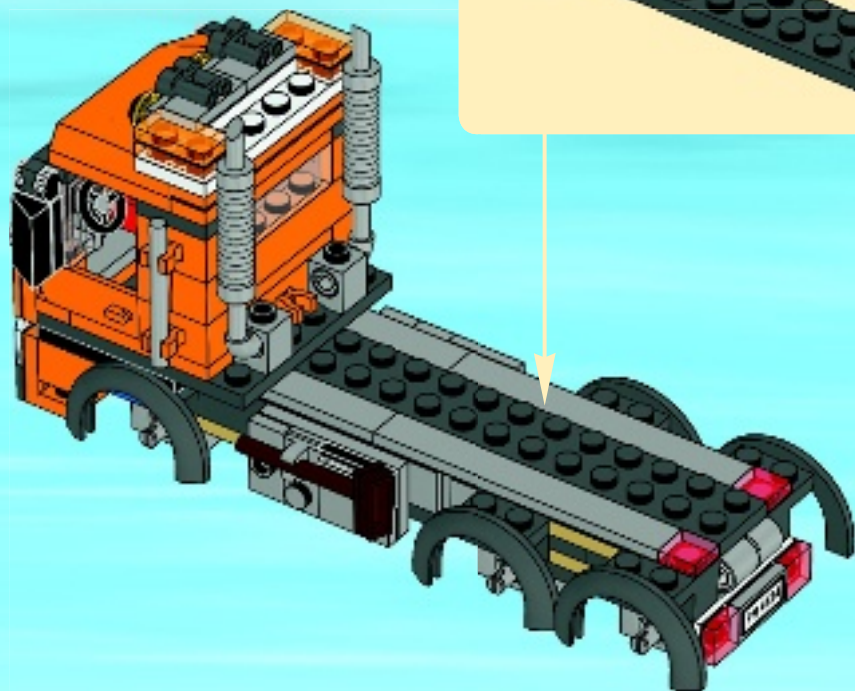

25

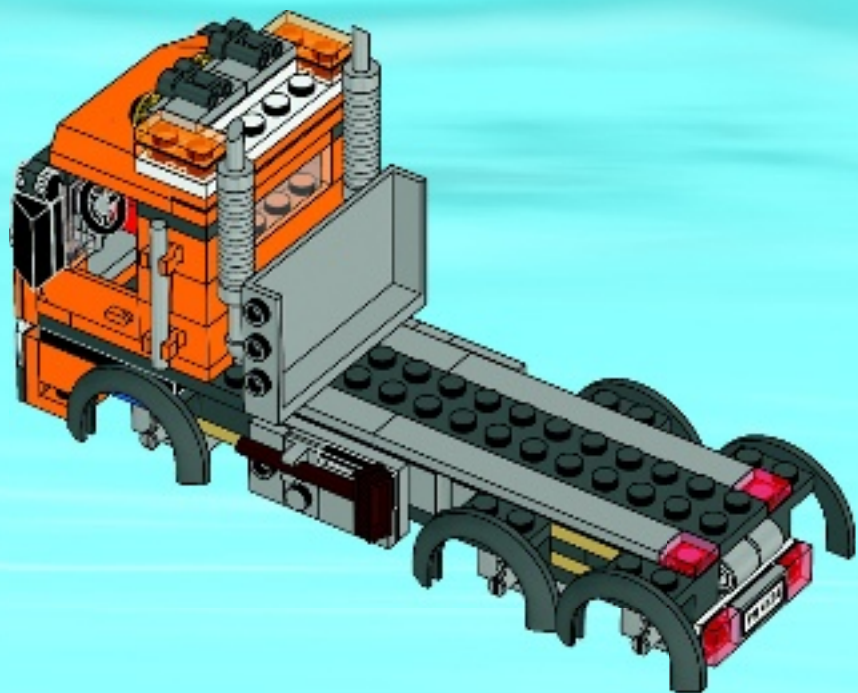

26

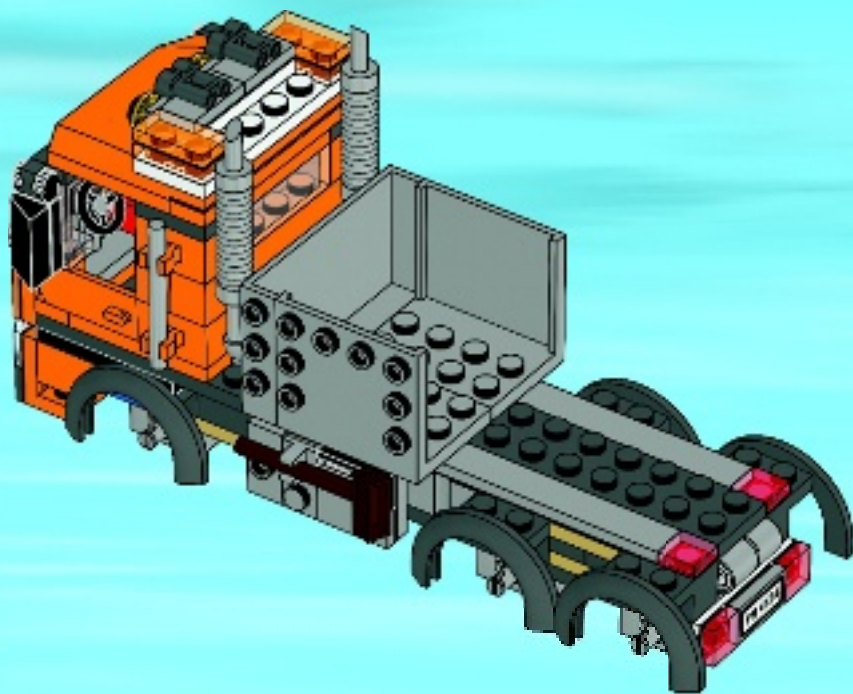

27

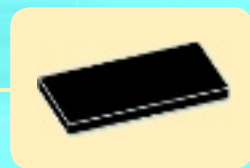
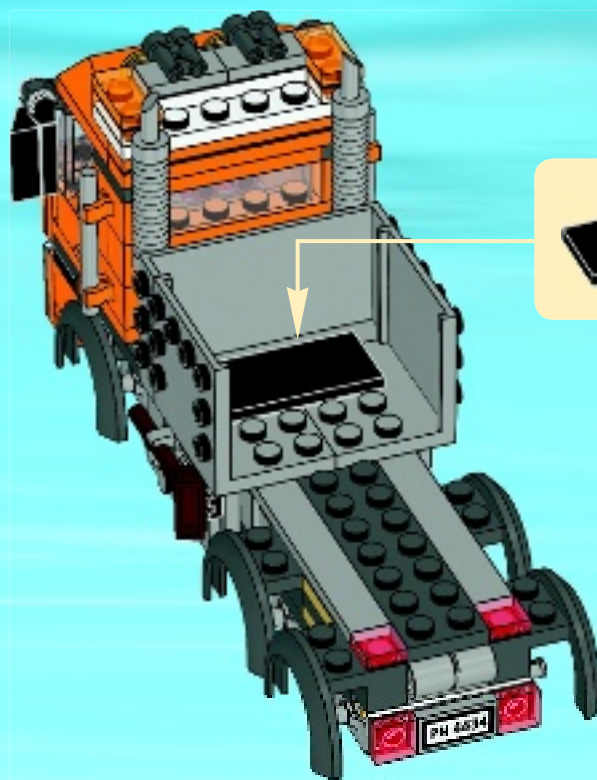

28

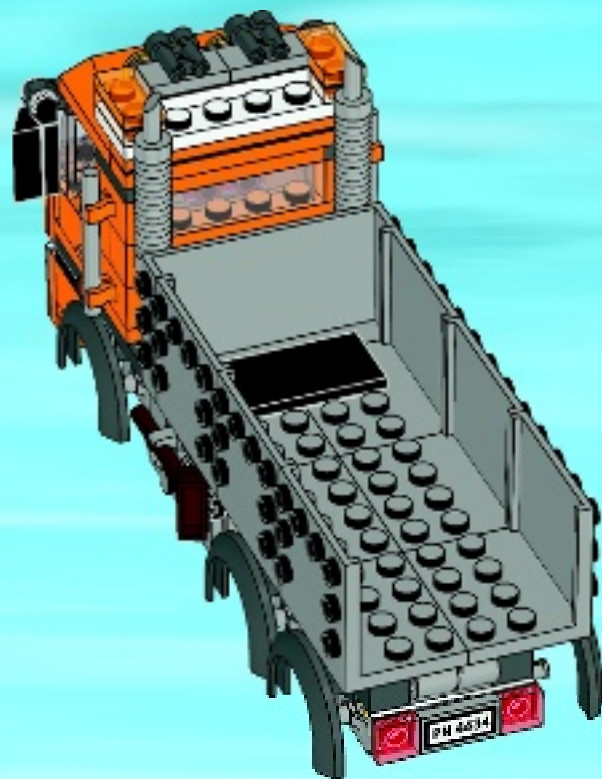

29

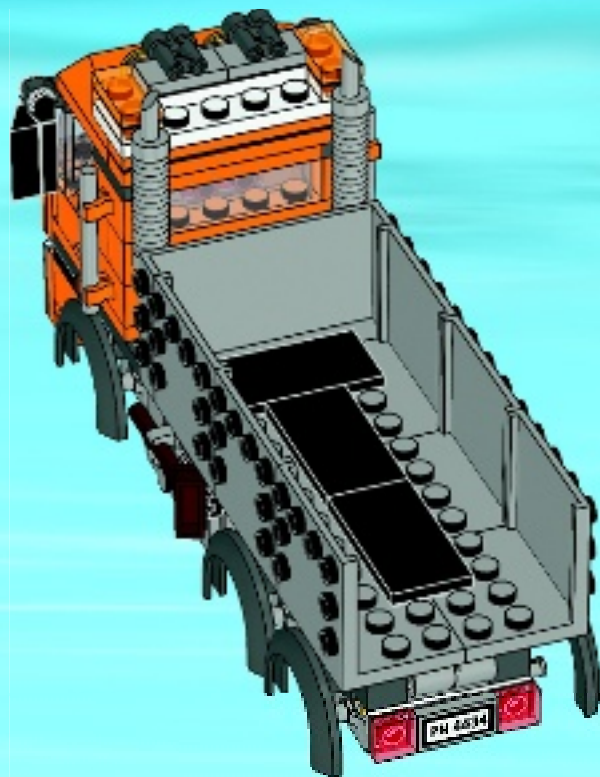

30

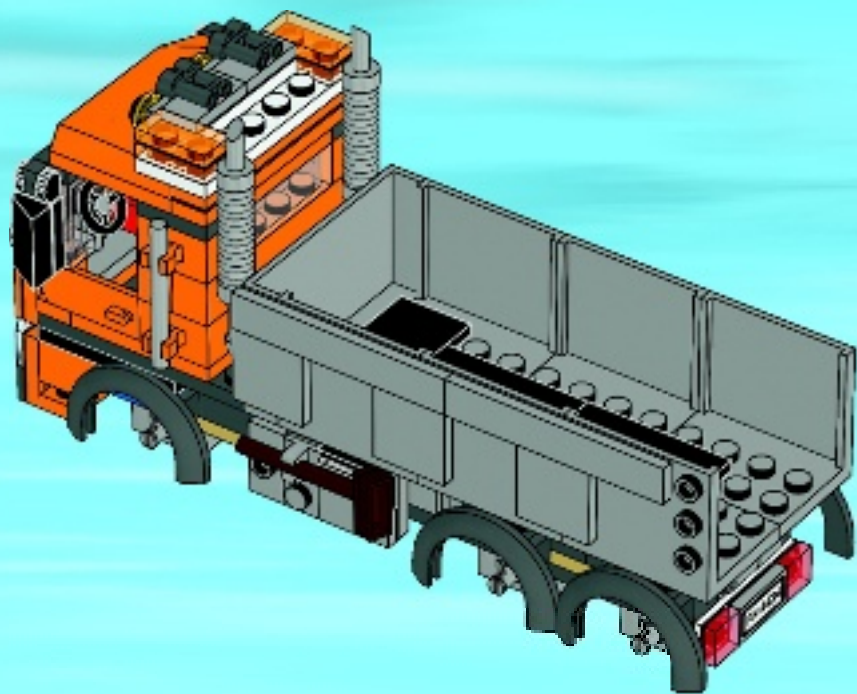

31

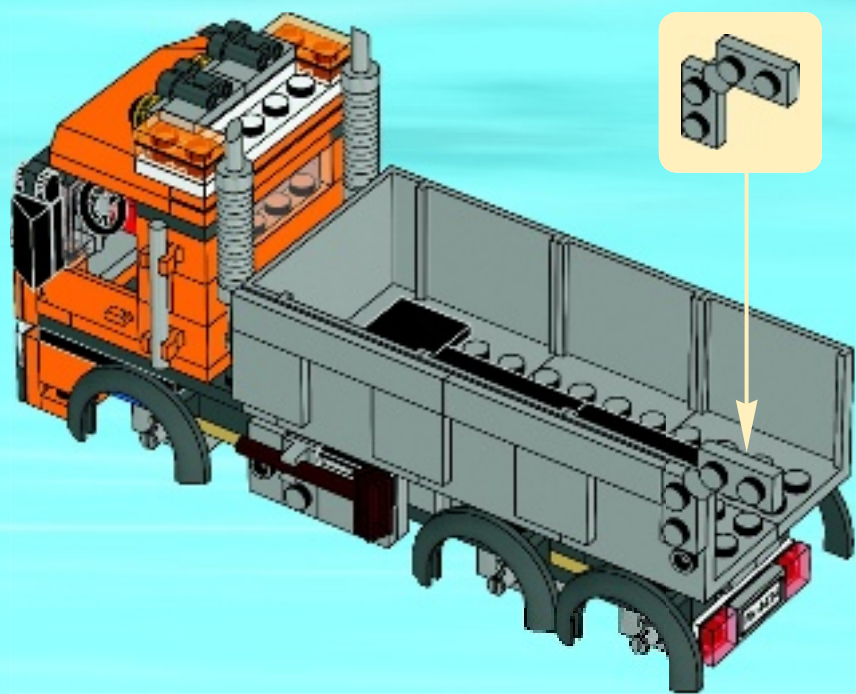

32

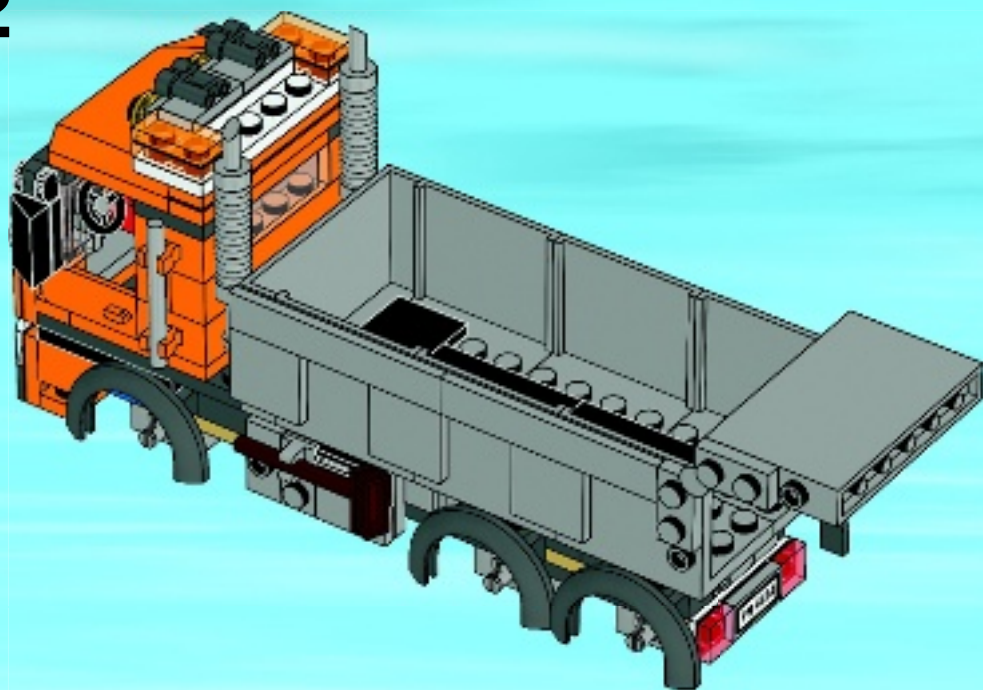

33

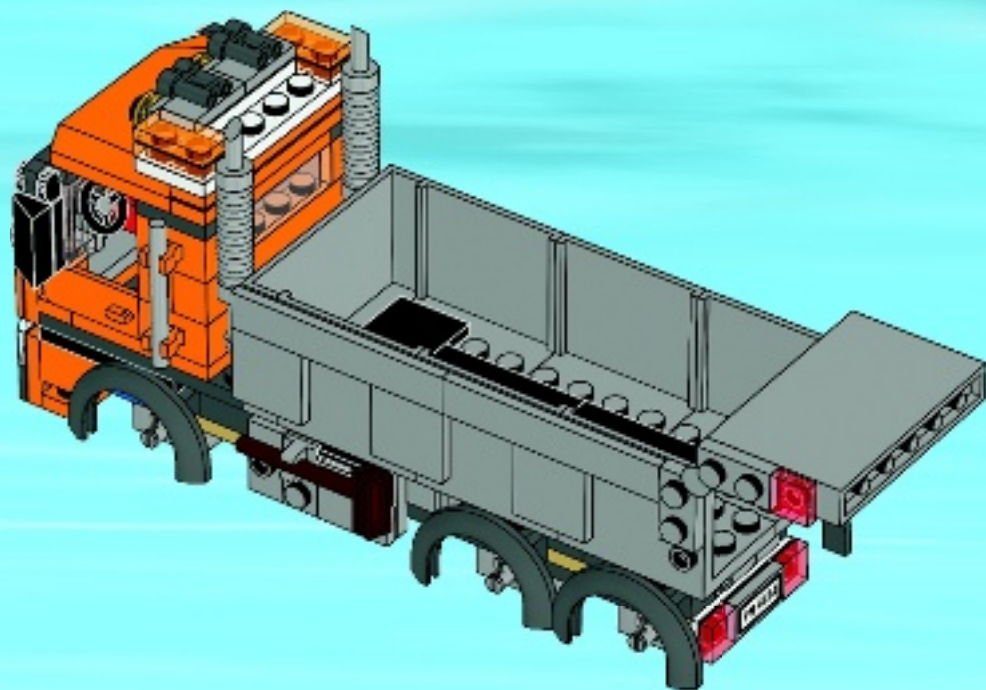

34

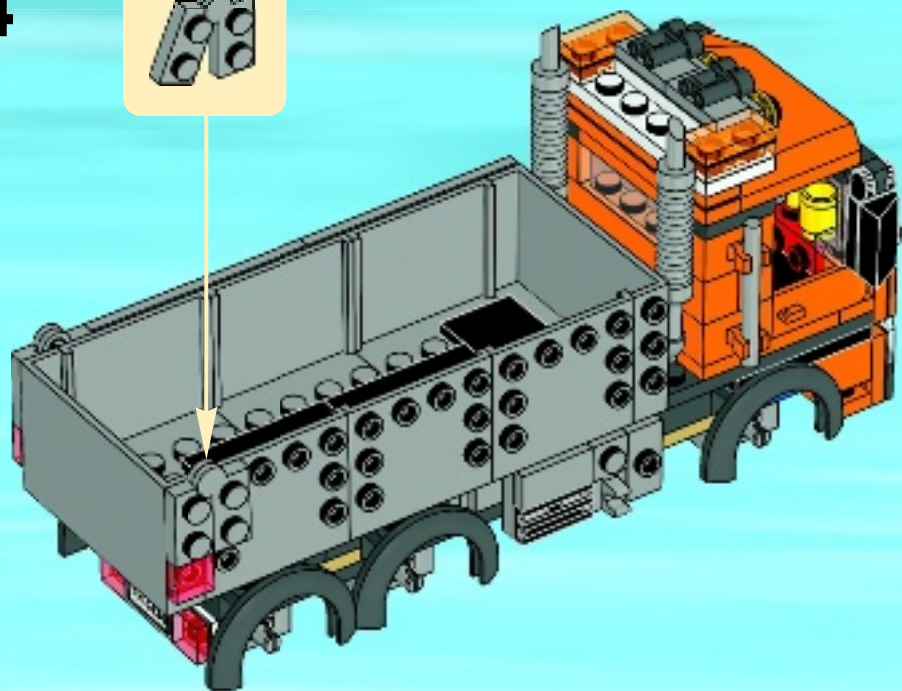

35

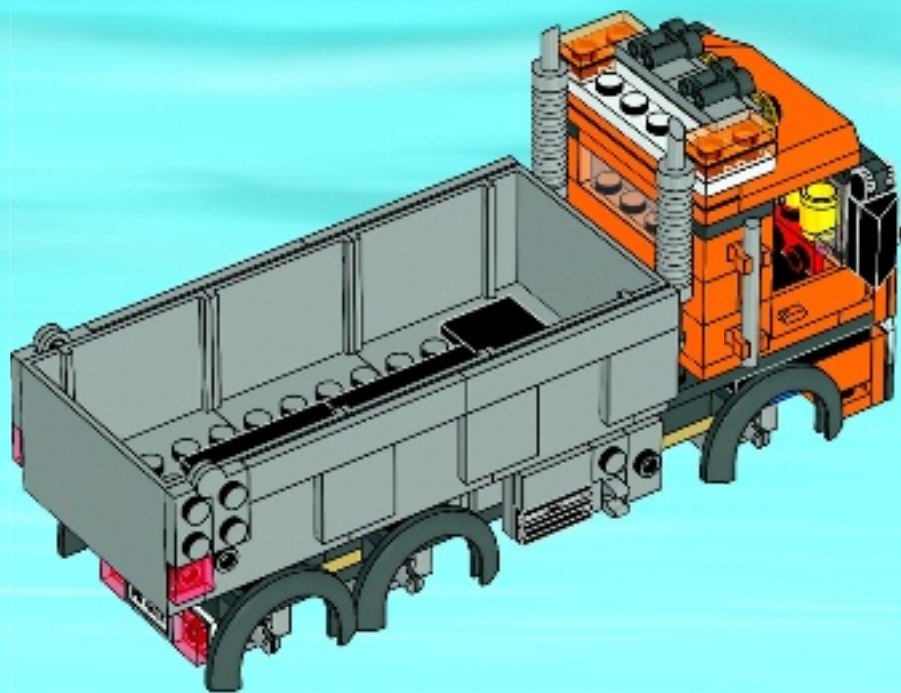

36

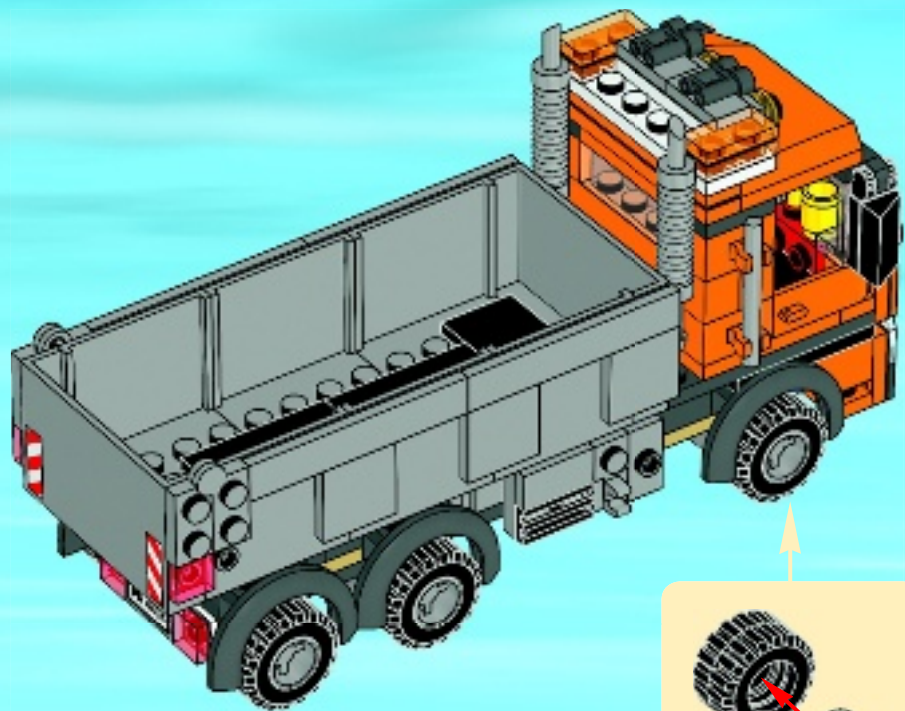

37

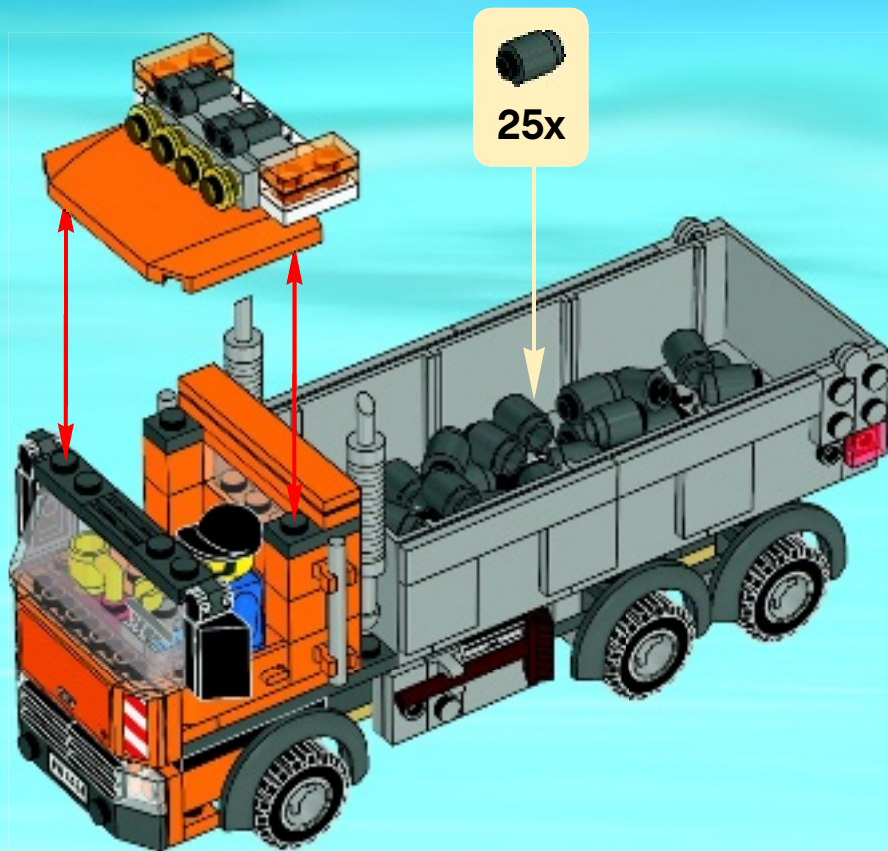



CITY



4431



4432



4433



4434



4435



CITY



4440



4439



4441



4437



4436

LEGO CITY



4209



4208



4427



www.LEGOclub.com



LEGO® Club Email



LEGO® Club Magazine

LEGO club™

FREE! GRATIS! GRATUIT!

SIGN UP ONLINE!

www.LEGOclub.com



00800 5346 5555*



1-866-534-6258 • 1-877-518-5346

US & Canada only

Outside continental

- * Freephone. Mobile charges may apply.
- * Numéro sans frais. Des frais peuvent s'appliquer avec les téléphones cellulaires.
- * Gebührenfrei, Kosten für Anrufe aus Mobilfunknetzen können abweichen.
- * Gratis telefoonnummer vanaf vaste lijn.
- * Det er et gratis nummer, når du ringer fra fasttelefon.
- * Det är gratis, när du ringer från en fast telefon.
- * Numéro sans frais. Des frais peuvent s'appliquer avec les téléphones portables.

YES! I want to join the LEGO® Club FREE! **OUI!** Je veux m'abonner au LEGO® Club GRATUITEMENT ! **Ja!** Ich möchte Mitglied im kostenlosen LEGO® Club werden.
Ja! Ik wil graag GRATIS lid worden van de LEGO® Club. **Ja!** Jeg ønsker å melde meg inn i LEGO® Club gratis! **Ja!** Jag vill gå med i LEGO® Club GRATIS!

First name · Prénom
 Vorname · Voornaam
 Fornavn · Förnamn

Last name · Nom de famille
 Name · Achternaam ·
 Etternavn · Eftermann

Date of Birth · Date de naissance
 Geburtsstag · Geboortedatum
 Fødselsdato · Fødselsedatum

Street · Adresse
 Straße, Hausnr.
 Straat, huisnr. · Adress

City · Ville
 Ort · Woonplaats
 Poststed · Postort

Zip/Postcode
 Code Postal · PLZ
 Postcode
 Postnummer

Email · Courriel
 E-Mail · E-post

Boy · Garçon ·
 Junge · Jongen ·
 Gutt · Pojk

Girl · Fille ·
 Mädchen · Meisje
 Jente · Flicka

State
 Prov. County

Country
 Pays
 Land

Mail to: /
 Poster åt:

LEGO® Club
 P.O. Box 1157
 Enfield, CT USA
 06083-1157

Send til:
 LEGO® Club Norge
 Postboks 58
 1314 Vøyenenga

Mail to:
 LEGO® Club

33 Bath Road
 Slough SL1 3UF
 United Kingdom

Skickas till: LEGO® Club Sverige
 Ubox 841
 202 29 Malmö

Per Post an:
 LEGO® Club
 Postfach 14 15
 D-36243 Niederalau

Stuur op naar:
 LEGO® Club
 Postbus 40250
 3504 AB Utrecht

Poster åt:
 LEGO® Club
 21 rue de la banque
 75 002 PARIS
 FRANCE

Fill in your email address and we will send you a membership confirmation and monthly email newsletters. If you do not wish to receive the newsletters please tick here. Remplis ton adresse e-mail et nous t'enversons une confirmation d'adhésion ainsi que le bulletin e-mail mensuel. Si tu ne désires pas recevoir le bulletin, coche cette case. Vul je e-mailadres in en we sturen je een bevestiging van je lidmaatschap en maandelijkse e-mail nieuwsbrieven. Als je geen e-mail wilt ontvangen, kruis dan dit vakje aan.

If you do not wish to receive additional mailings from the LEGO Club please tick here. Si tu ne désires pas recevoir de courrier supplémentaire du Club LEGO, coche cette case. Als je geen verdere post van de LEGO Club wilt ontvangen, kruis dan dit vakje aan.

Ich möchte per E-Mail den monatlichen LEGO Club Newsletter erhalten. Önsker du at vi skal sende en liten hilsen til barnet ditt for å bekrefte medlemskapet, ber vi deg krysse av i feltet, samt oppgi e-postadressen som hilsen skal sendes til. Om du vill at vi ska skicka en bekräftelse på ditt barns medlemskap, ber vi dig sätta ett kryss i rutan och skriva den e-post adress som bekräftelsen ska skickas till.

Om du vill få annan information från LEGO Gruppen, sätt ett kryss här. Dersom du ønsker å motta annen informasjon fra LEGO Gruppen, setter du ett kryss her.

The English language version of the magazine can only be mailed to addresses in the US, Canada, the UK, and Republic of Ireland. Club membership is valid for two years and includes free copies of the LEGO Club Magazine and e-mail newsletters. In the US and Canada please allow up to 6 weeks for delivery of your first magazine. In the UK and Republic of Ireland please allow up to 14 weeks for delivery of your first magazine. By signing this form you consent the LEGO Club to use your child's data for LEGO mailings. The data will only be used for LEGO mailings and will not be sold, rented or otherwise disclosed to any company outside the LEGO Company except for disclosure to companies acting as our agents to help us provide services requested by the child. This coupon is valid for one free membership per person, group or organization. Photocopied coupons are accepted. La version française du magazine peut être postée uniquement au Canada, Labonnement est valide pour 2 ans et inclut des exemplaires gratuits du Magazine LEGO, Aux E-U et au Canada, allower 6 semaines pour la livraison. En remplissant ce formulaire, vous consentez à ce que LEGO utilise les informations de votre enfant pour des envois postaux de LEGO. L'information sera utilisée uniquement pour des envois postaux par LEGO et ne sera en aucun cas, vendue, louée, échangée ou divulguée à d'autres compagnies autres que la compagnie LEGO à l'exception des compagnies affiliées qui nous procurent des services auxquels l'enfant en a fait la demande. Formulaire photocopier acceptés. Mit der folgenden Unterschrift erkläre ich, für mein Kind den Beitritt als Mitglied zum kostenlosen LEGO Club, der von der LEGO GmbH, D-85627 Grasbrunn, betrieben wird. Die Mitgliedschaft beinhaltet die Zusendung des LEGO Club Magazines und kann beiderseits jederzeit beendet werden. Mit der Mitgliedschaft im LEGO Club sind keinerlei Verpflichtungen verbunden. Das deutschsprachige LEGO Club Magazin wird nur an Adressen in Deutschland, Österreich und der Schweiz versendet. Eine Anmeldebestätigung kann nur per E-Mail geschickt werden. Das Magazin erscheint fünfmal jährlich. Daher kann die Zustellung des ersten Heftes bis zu drei Monate dauern. Die Mitgliedschaft ist beidseitig jederzeit kündbar, ohne dass Ihnen Kosten entstehen. Sie können der werblichen Nutzung Ihrer Daten jederzeit widersprechen. Kündigung und Widerspruch können Sie telefonisch erklären (00800 / 5346 5555, Anruf gebührenfrei, Kosten für Anrufe aus dem Mobilfunknetz können abweichen) oder an die LEGO GmbH senden. Het Nederlandse LEGO Club Magazine kan alleen worden gestuurd naar adressen in Nederland. Het lidmaatschap is 2 jaar geldig en geeft recht op toezending van het gratis LEGO Club Magazine in LEGO Club e-mails. Het eerste magazine zal binnen 12 tot 14 weken toegestuurd worden. Het lidmaatschap kan op ieder moment opgezegd worden en kan na 2 jaar gratis worden verlengd, tenzij LEGO met deze activiteit stopt. Uw gegevens worden uitsluitend gebruikt voor mailings van LEGO en zullen niet worden verkocht, verhuurd of op welke wijze dan ook verstrekt aan derden buiten de LEGO Groep, uitgezonderd de organisaties die namens ons optreden om de informatie te sturen waarvoor toestemming is verleend. Den norske utgaven av magasinet sendes kun til adresser i Norge. Medlemskap i klubben gjelder i 2 år og inkluderer gratisutgaver av LEGO Club Magazine. Pårenning minimum opp til seks uker leveringstid for første magasin. Ved å undertegne dette skjemaet, gir du ditt samtykke til at LEGO Club kan bruke opplysningene om barnet ditt i LEGO foresendelser. Dataene vil utelukkende bli brukt i LEGO foresendelser og vil ikke bli solgt, utleid eller på annen måte gjøres tilgjengelig for selskaper utenfor LEGO gruppen, unntatt selskaper som er våre agenter og som hjelper oss å tilby tjenestene barnet etterper. Dette skjemaet gjelder for ett gratis medlemskap per person, gruppe eller organisasjon. Den svenska versionen av tidningen kan endast skickas till adresser i Sverige. Club-medlemskapet är giltigt i 2 år och innefattar gratis exemplar av LEGO Club Magazine. Vämligen räkna med minimum 6 veckor för leverans av din första tidning. Genom att skicka in ditt här formuläret godkänner du att LEGO Club använder barnets uppgifter för LEGO utskick. Uppgifterna kommer bara att användas för LEGO utskick och kommer inte att säljas, hyras ut eller vidarebefordras till något företag som inte tillhör LEGO Gruppen, med undantag av företag som agerar som våra ombud för att tillhandahålla tjänster som barnet har begärt. Den här kupongen gäller för ett gratis medlemskap per person, grupp eller organisation. En complétant ce bulletin d'adhésion, vous acceptez que LEGO Club utilise les données relatives à votre enfant pour l'envoi de courriers concernant LEGO. Ces données seront uniquement utilisées pour l'envoi d'information concernant LEGO et ne seront ni vendues, ni louées, ni utilisées par d'autres sociétés que le groupe LEGO, à l'exception des sociétés agissant pour le compte de LEGO en tant que sous-traitant de services divers. Labonnement au LEGO Club est valable pour une période de 2 ans. Il inclut l'envoi par courrier du magazine LEGO Club et par email des newsletters. Un détail de 6 à 14 semaines est à prévoir pour la réception de votre premier magazine. Ce bulletin d'adhésion gratuit est valable pour l'inscription d'une seule personne. Les photocopies sont acceptées. ATTENTION! Le bulletin d'adhésion doit être rempli et signé par un parent ou un tuteur.

Parent's signature · Signature d'un parent ou d'un tuteur ·
 Unterschrift Erziehungsberechtigte/r · Handtekening ouders ·
 Foreldres/foresattes underskrift · Förälders /förmyndares underskrift

Date
 Datum
 Date

1x
4262093

1x
4651441

1x
389924

2x
614124

2x
4569056

1x
383321

1x
4646527

2x
4617170

2x
4211541

2x
4211445

2x
4211395

3x
4211414

6x
4211451

2x
4598526

6x
4211413



6x
4211496



6x
4211764

1x
4226995

2x
4219256

6x
4646525

4x
4211549

4x
4211481

1x
4646512

1x
4646513

2x
4648115

2x
4211628

2x
4263192



1x
4211085

1x
4211134

4x
4210997

1x
4211067

3x
4598769

6x
4260124

25x
4211090

2x
4504378

1x
4210631

2x
4210883



2x
4211051

2x
4211063

1x
4296997



1x
4282737

1x
4560929

1x
4541808

4x
4113917

1x
4114001

1x
4249019



2x
4212411



2x
4173805



1x
4545313



3x
4548180



1x
4121715



2x
4244362



2x
4524365



2x
302123



5x
4648849



1x
4545315



3x
371026



1x
4516843



6x
3003941



2x
4280341



2x
243223



2x
4648855



1x
4648853



5x
241226



6x
4568644



1x
4198311



2x
4541710



2x
9341



2x
4118829



2x
4648854



2x
4183060



2x
302228



1x
4173328



1x
4548877



4x
4118782



1x
4505118



4x
4187209



4x
3005744



1x
4288003



3x
4173332



1x
4567910



1x
4211157



1x
4650690



1x
4189007



1x
4189009



Customer Service

Kundenservice

Service Consommateurs

Servicio Al Consumidor

www.lego.com/service or dial



: 00800 5346 5555

: 1-800-422-5346



WIN!

Go to www.LEGOsurvey.com/product to fill out a survey for a chance to win a cool LEGO® Product.

No purchase necessary.

Open to all residents where not prohibited.



www.LEGOsurvey.com/product

GEWINNE!

Nimm an der Umfrage auf www.LEGOsurvey.com/product teil und hab die Chance ein cooles LEGO® Produkt zu gewinnen!

Die Teilnahme am Gewinnspiel führt zu keinerlei Kaufverpflichtungen. Teilnahme in allen nicht ausgeschlossenen Ländern möglich.

WIN!

Ga naar www.LEGOsurvey.com/product, vul een enquêteformulier in en maak kans op een cool LEGO® product.

Geen aankoopverplichting. Iedereen mag deelnemen, uitgezonderd ingezetenden van landen waar een enquêteverbod geldt.

GAGNE!

Visite www.LEGOsurvey.com/product pour répondre à un questionnaire et avoir une chance de gagner un produit LEGO® très cool!

Aucune obligation d'achat. Ouvert à tous les résidents des pays autorisés.

当てよう!

www.LEGOsurvey.com/product にアクセスして、アンケートにご記入ください。当選者にはレゴ®製品を差し上げます。

お買い上げの必要はありません。禁止されていない限り、すべての皆様にご利用いただけます。



www.LEGO.com

4667229

LEGO and the LEGO logo are trademarks of the LEGO Group. ©2012 The LEGO Group.