



# CITY

4434



**WARNING: CHOKING HAZARD.**  
Small parts. Not for children under 3 years.

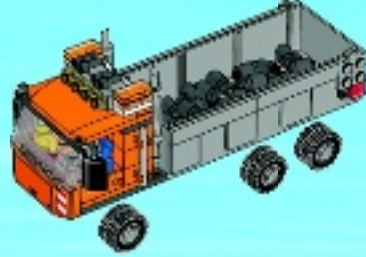
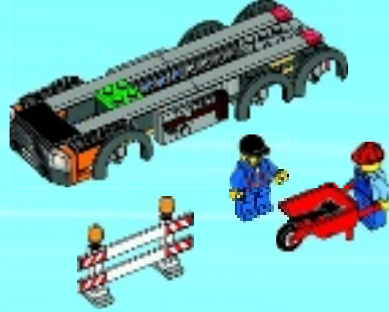

**AVERTISSEMENT : RISQUE D'ÉTOUFFEMENT.**  
Contient des petites pièces. Ne convient pas aux enfants de moins de 3 ans.



**ADVERTENCIA: PELIGRO DE ASFIXIA.**  
No recomendado para niños menores de 3 años. Contiene piezas pequeñas.

1

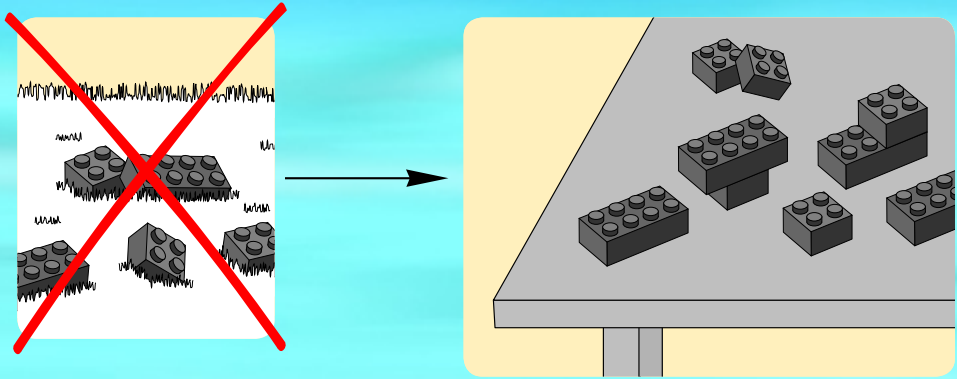

2

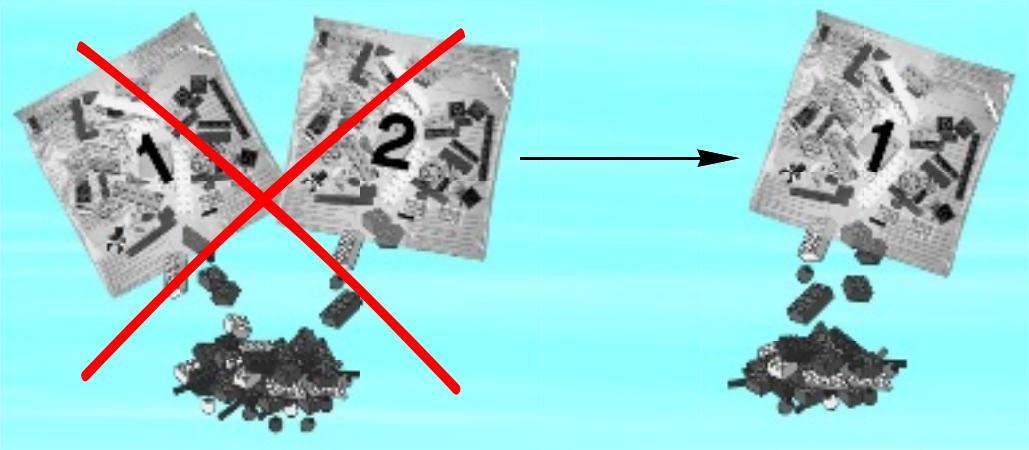

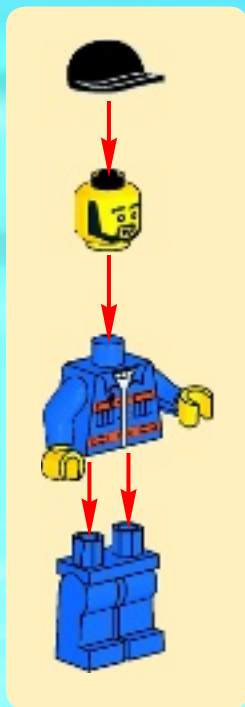
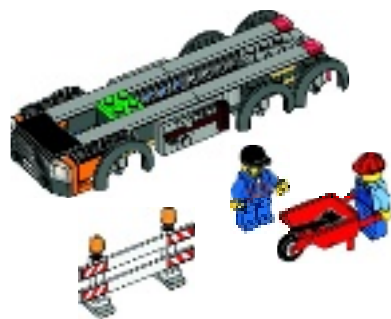

1



2



3



1

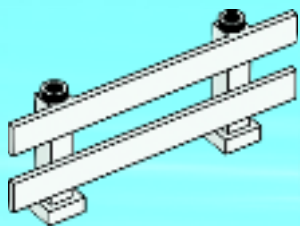

2

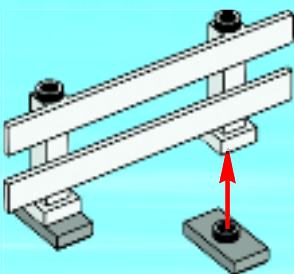

3

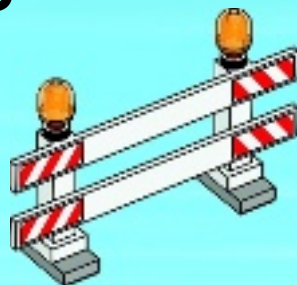



**1**

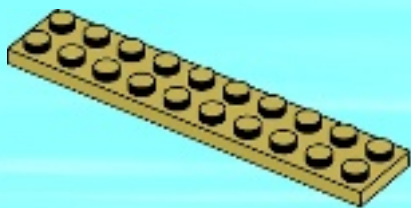

**2**

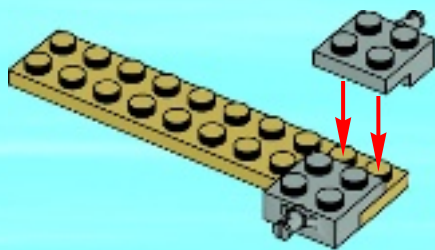

**3**

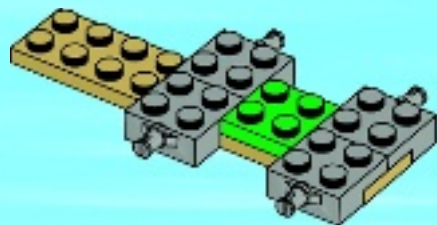

4

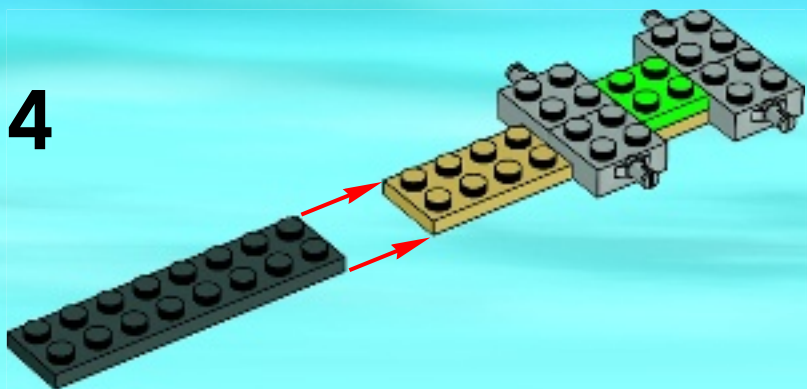

5

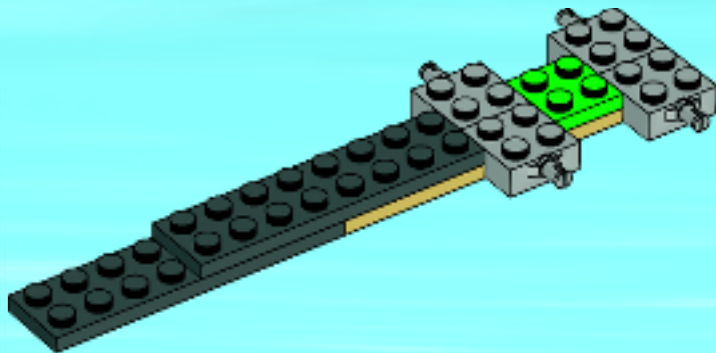



6

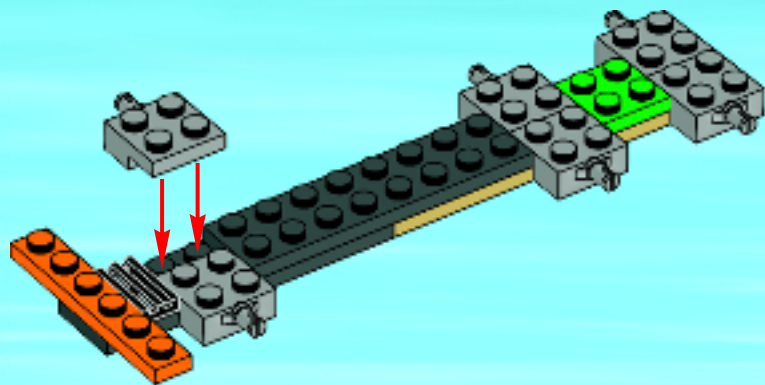

7

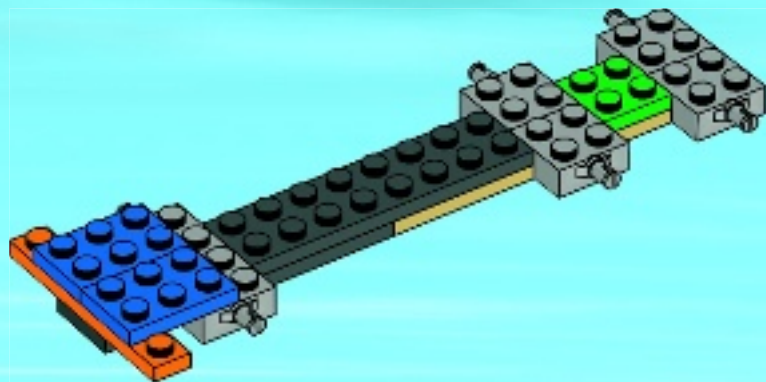

8

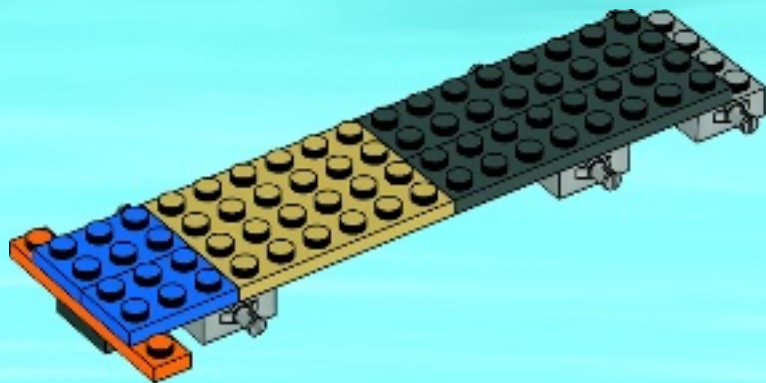

9

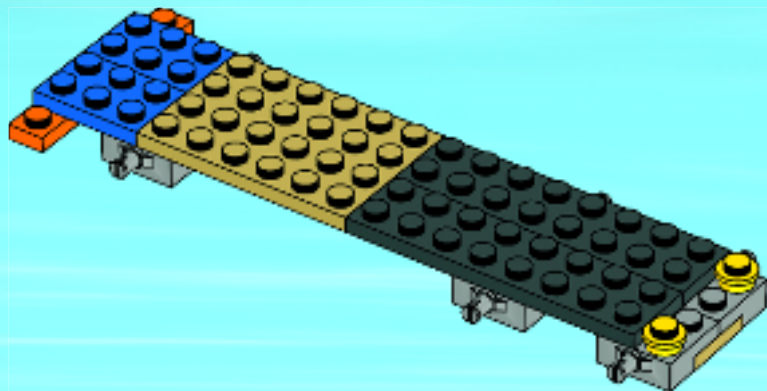

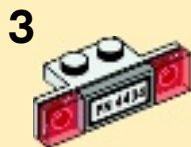
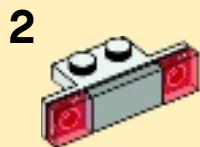
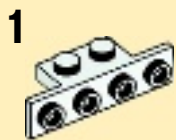

10

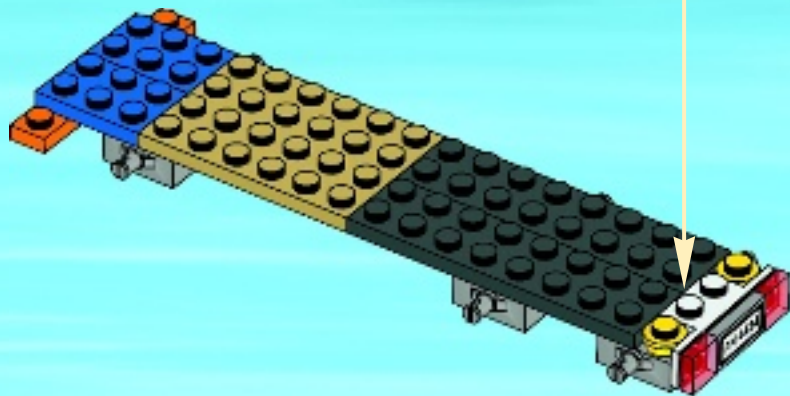

11

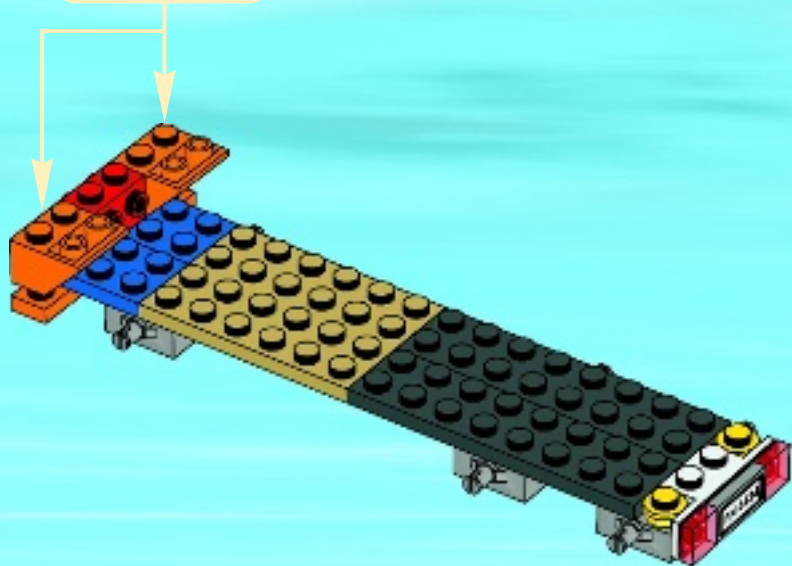

12

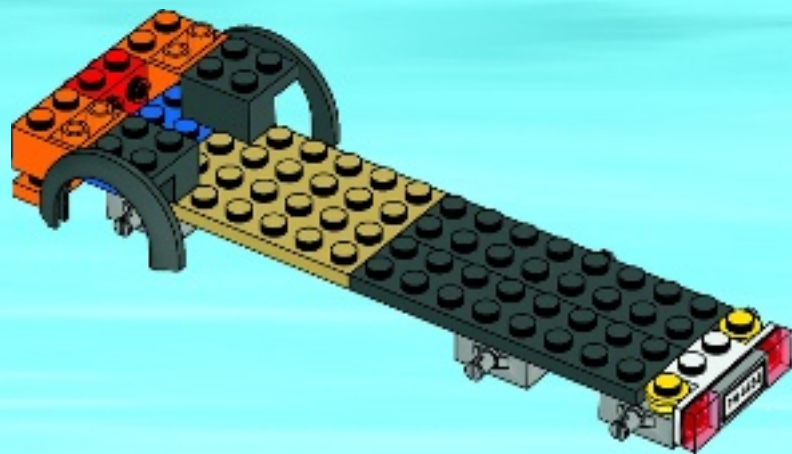

13

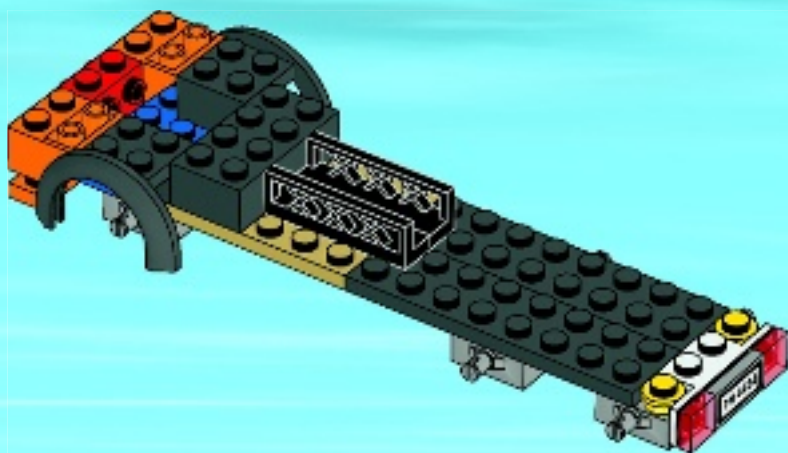



14

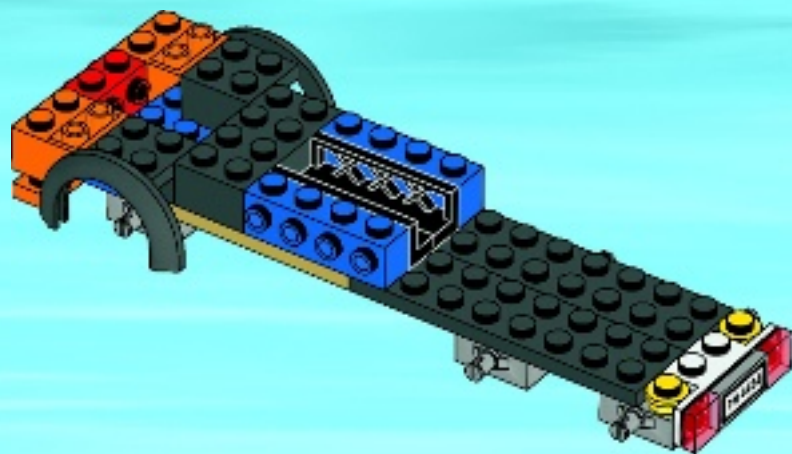

15

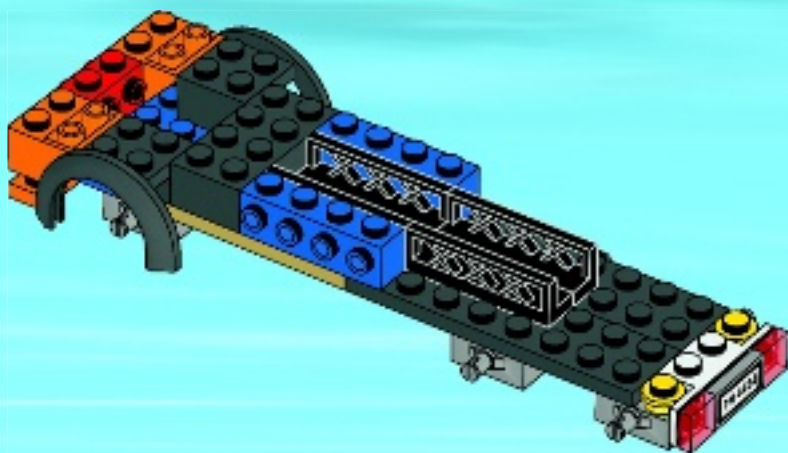

16

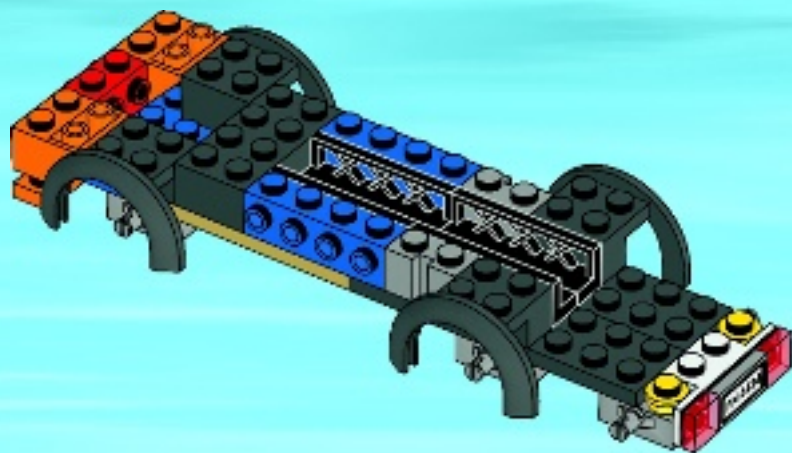

1

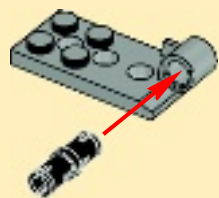

2

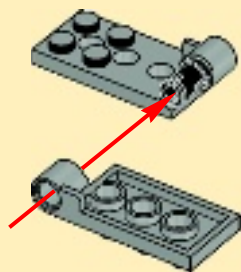

3



17

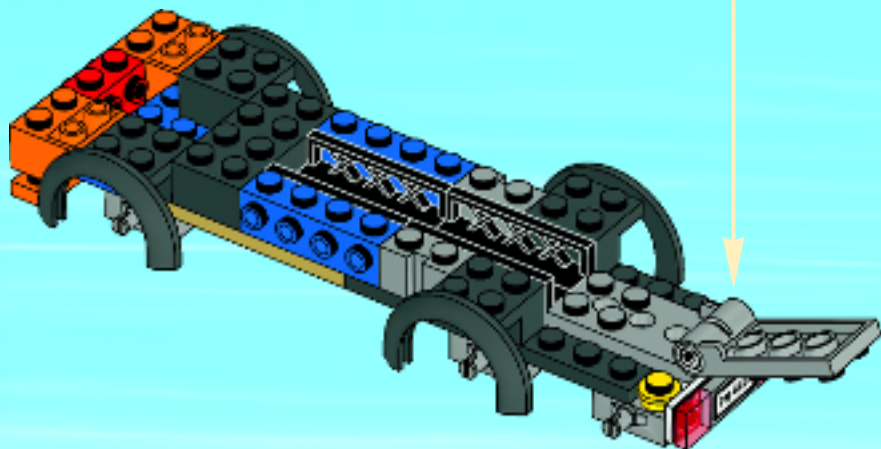

18

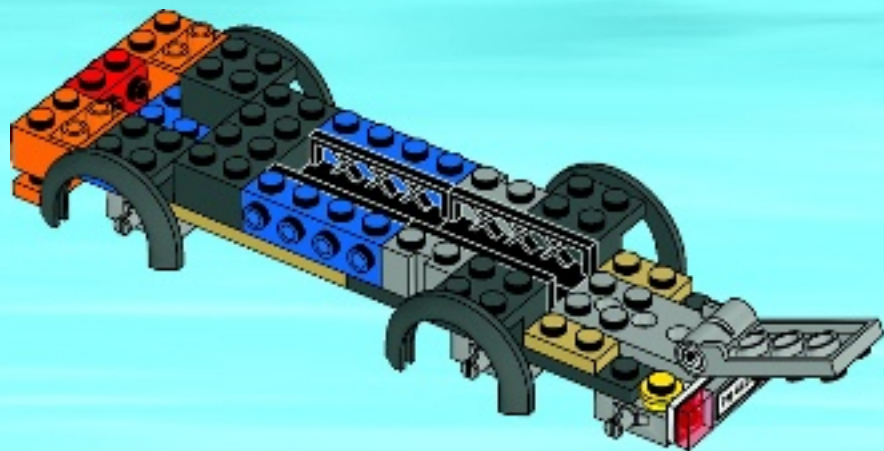

19

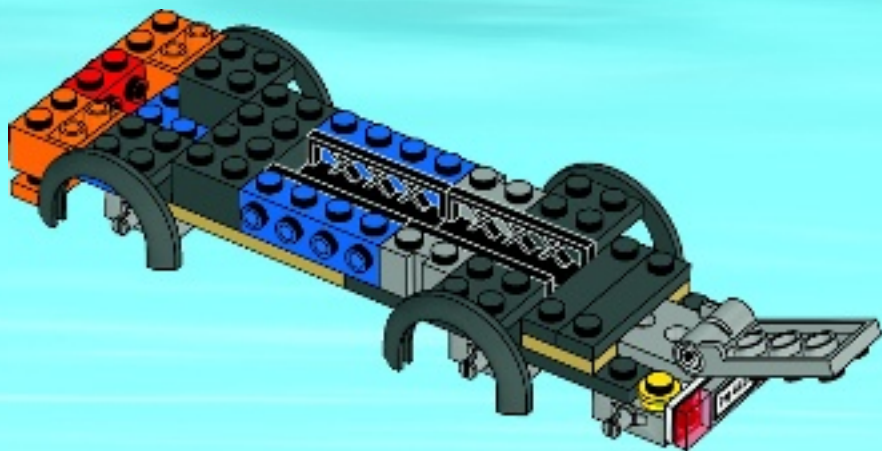

20

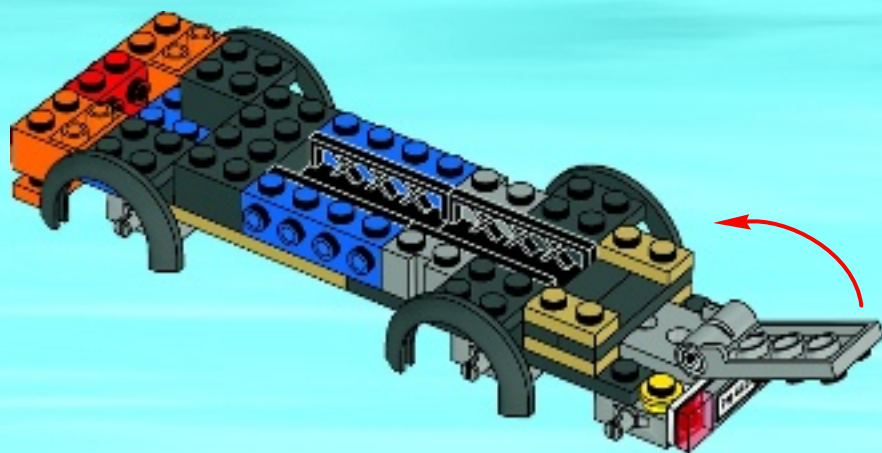

21

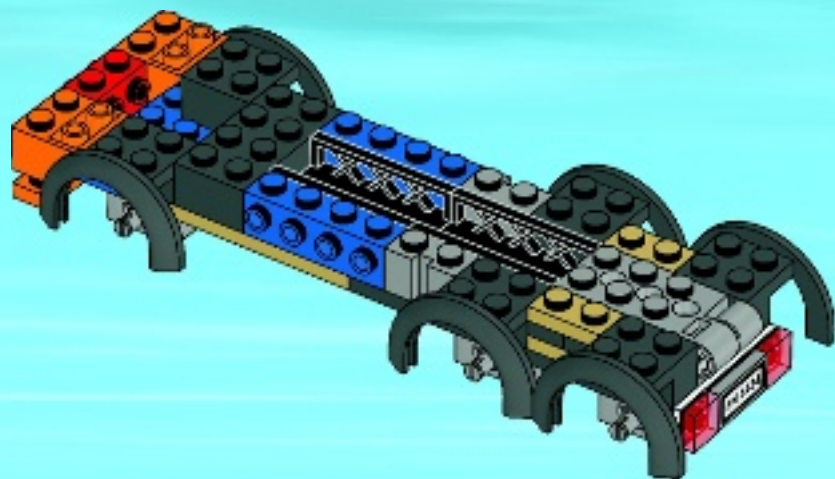



1

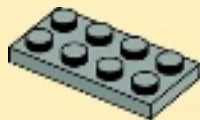

2

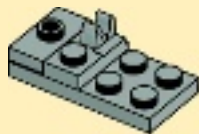

3

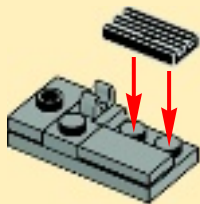

2x

22

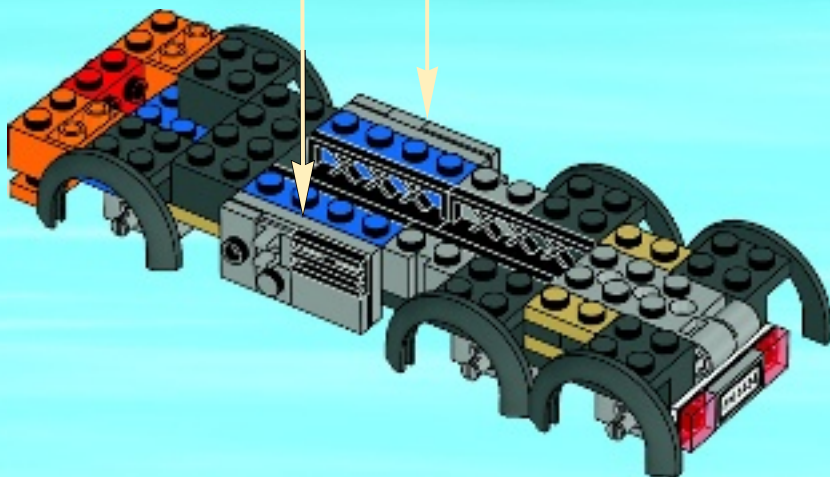

1



2



3

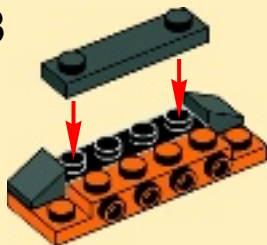

4



23

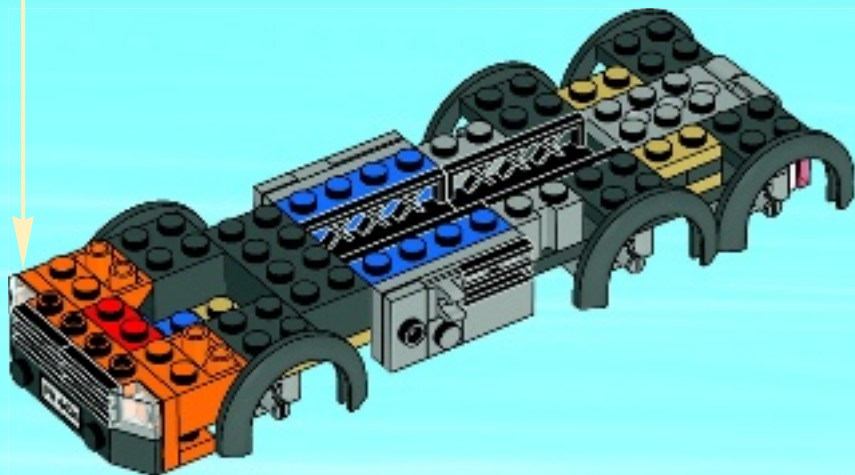

24

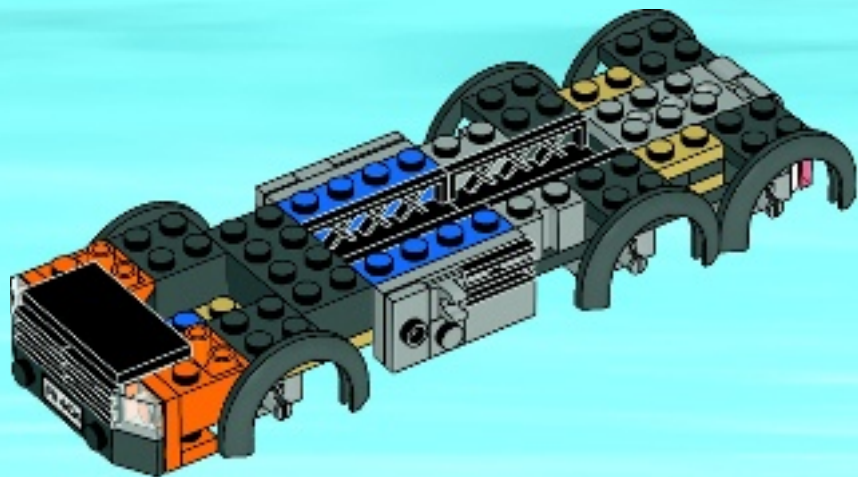

25

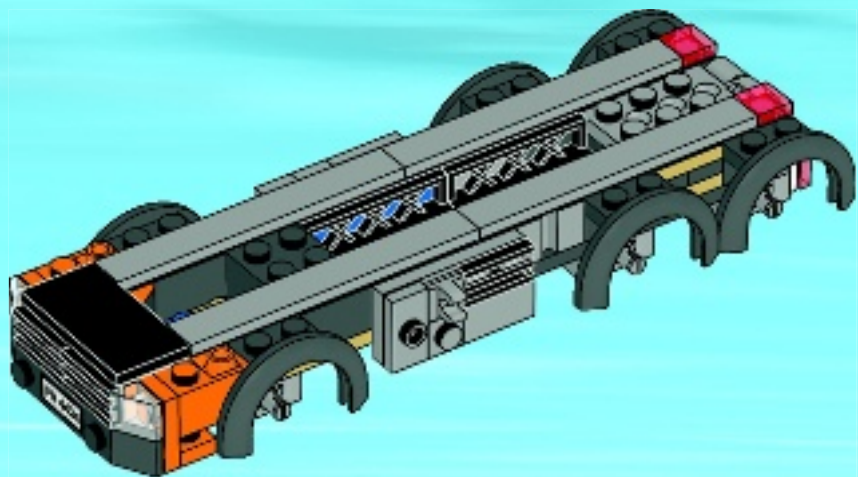

26

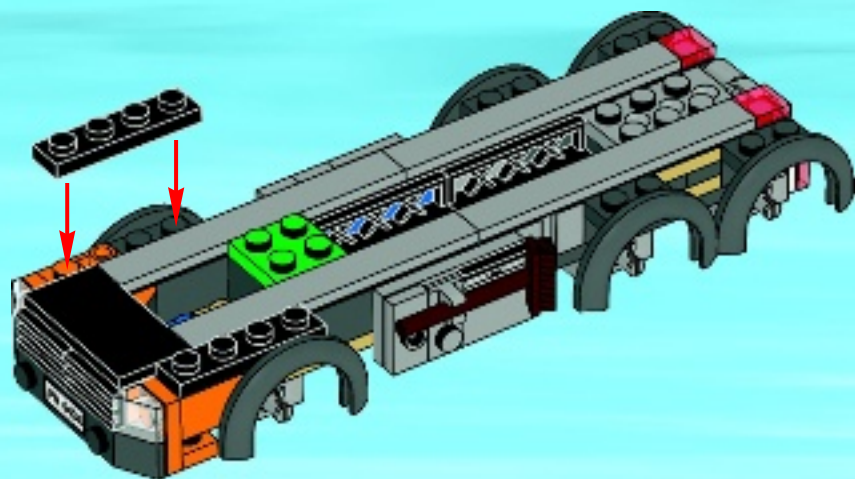



1



2



3



4



5

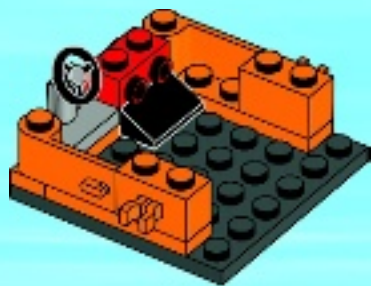

6



7



8

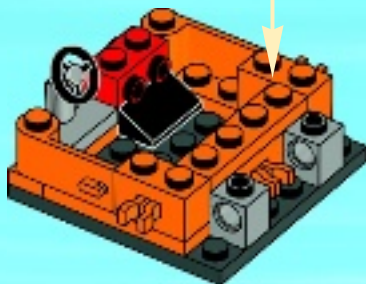



1



2



3

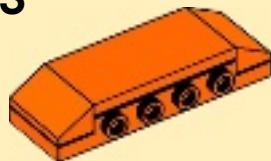

4



9



10



11

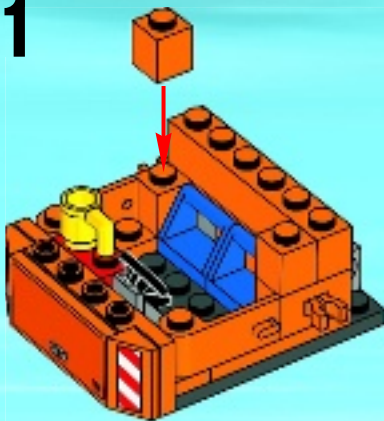

12

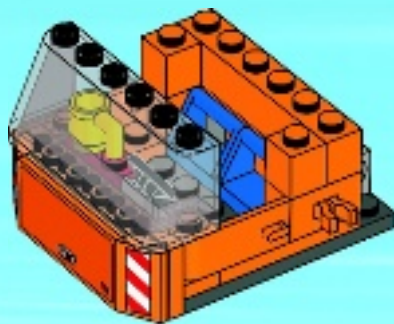

13

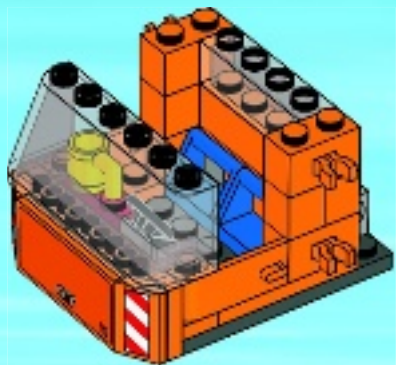

14

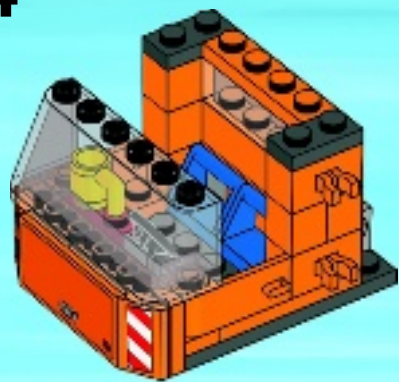

15

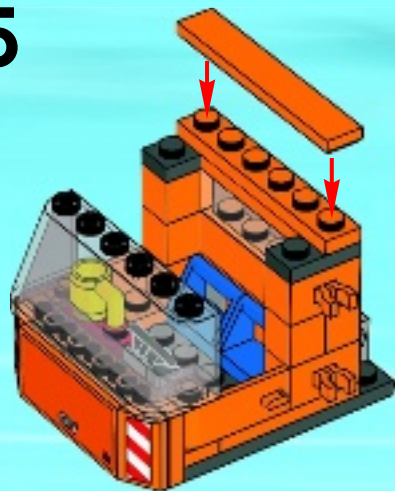

16

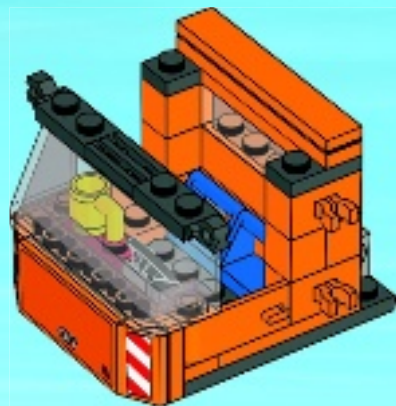

17



18

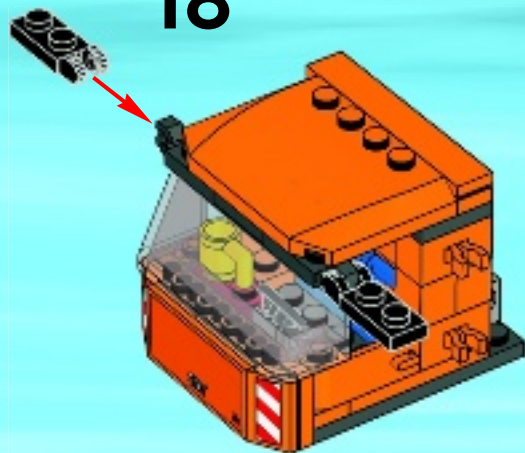

19

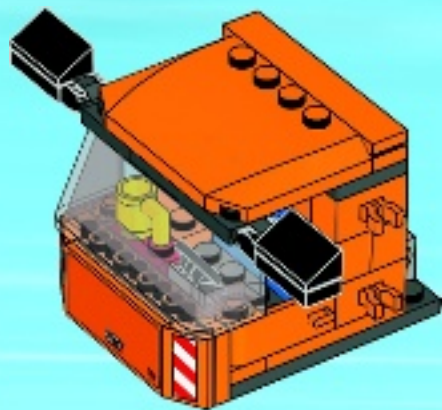

20

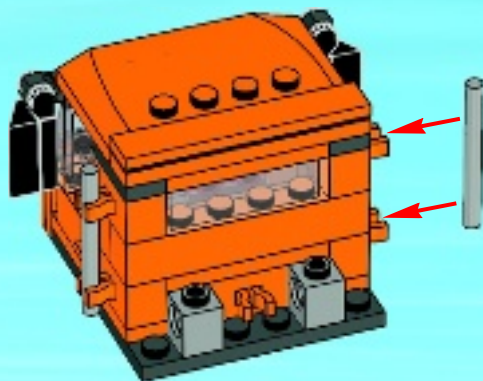

21

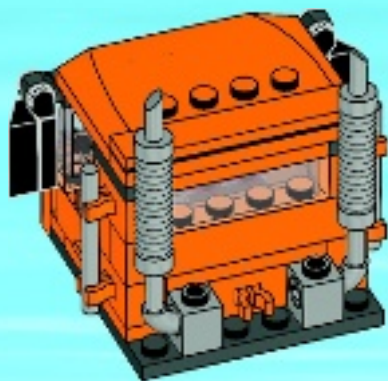

22

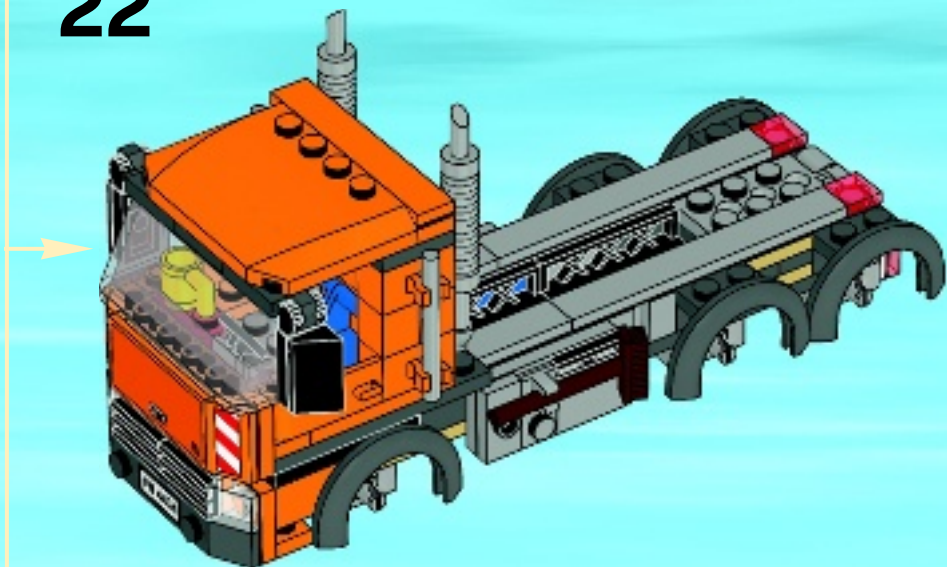



1

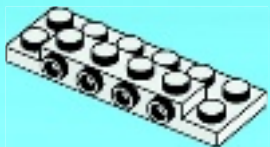

2

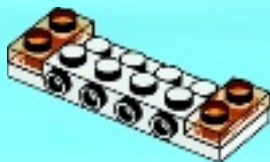

3

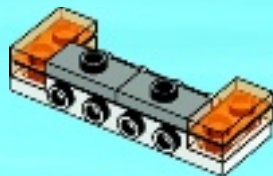



4

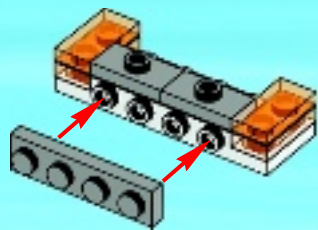

5



6



23

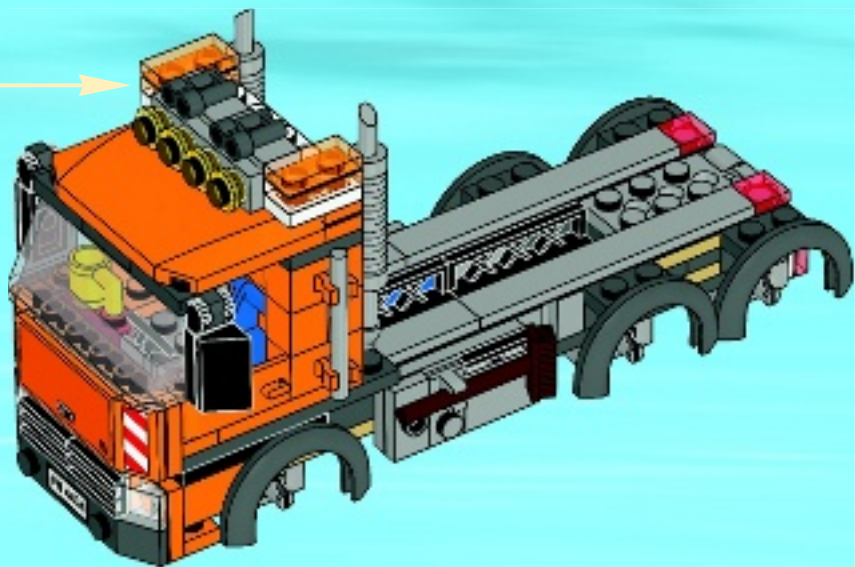

24

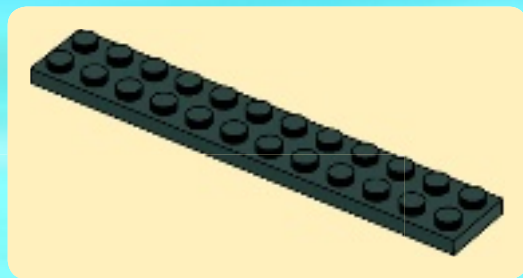
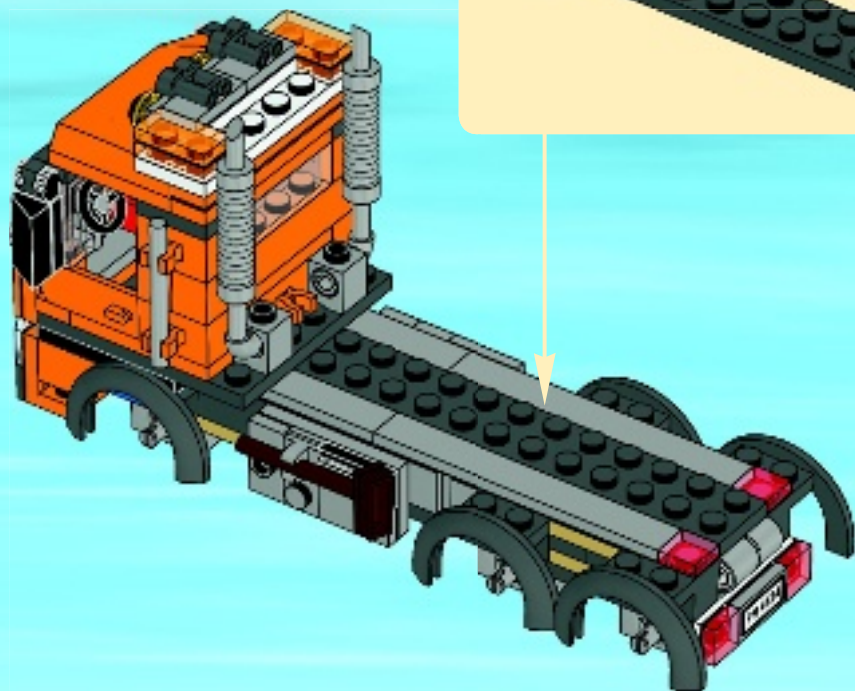

25

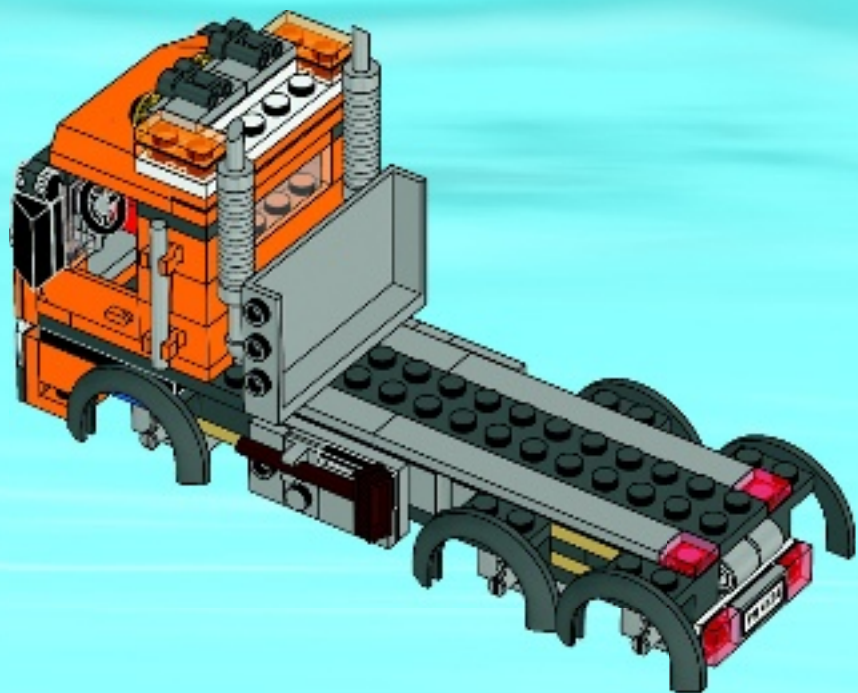

26

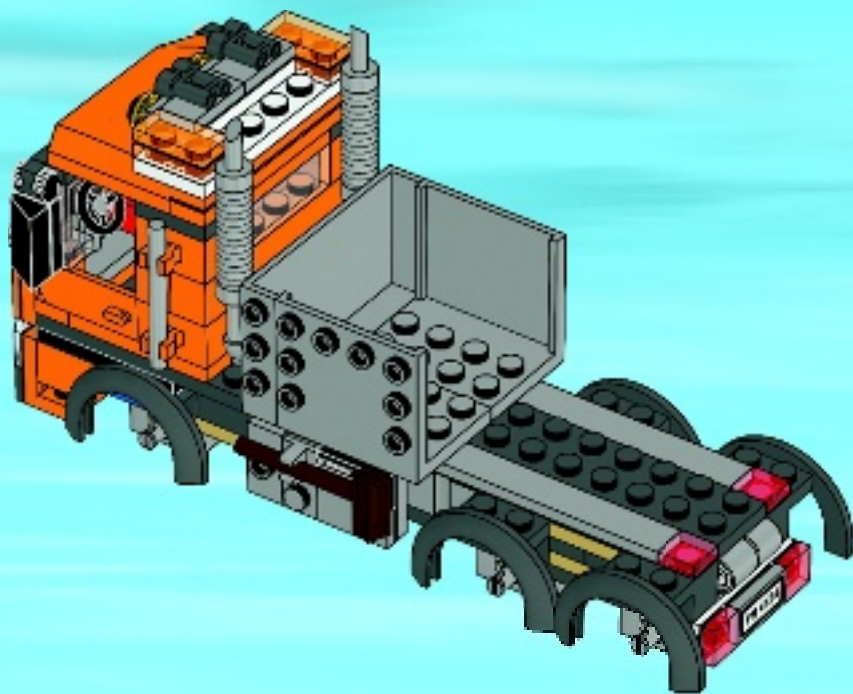

27

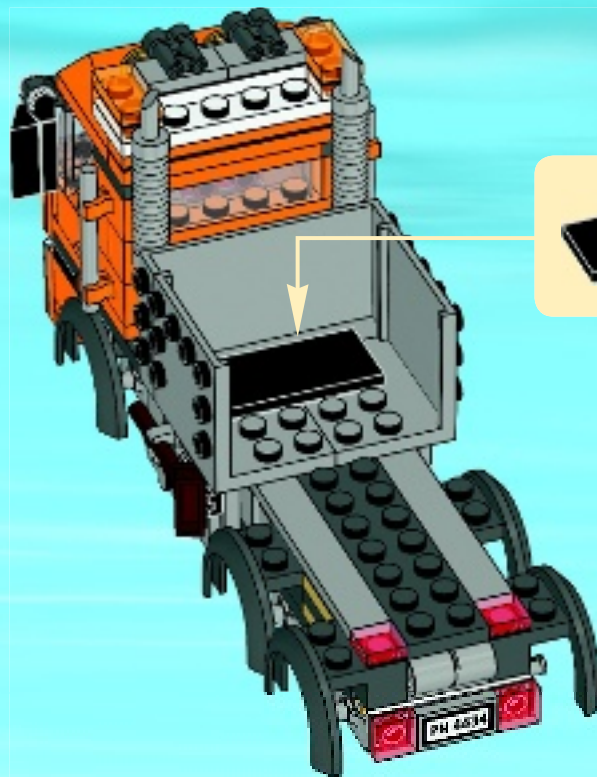

28

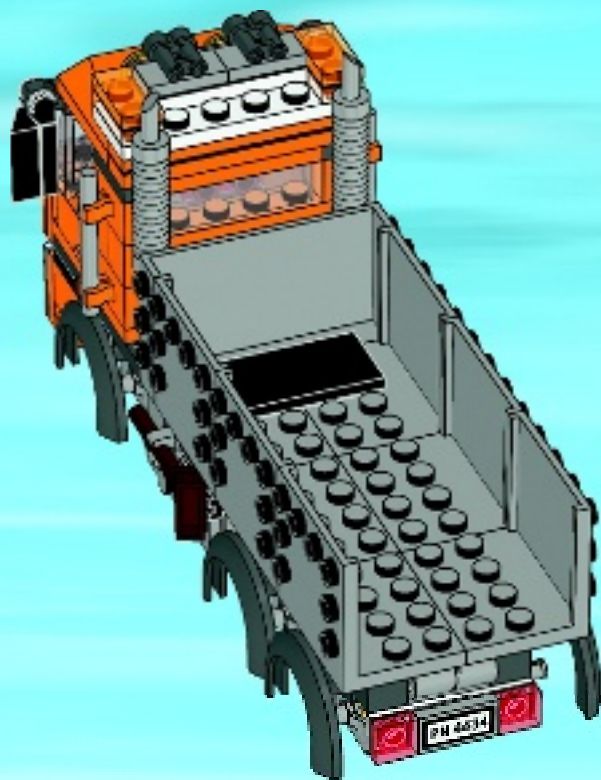

29

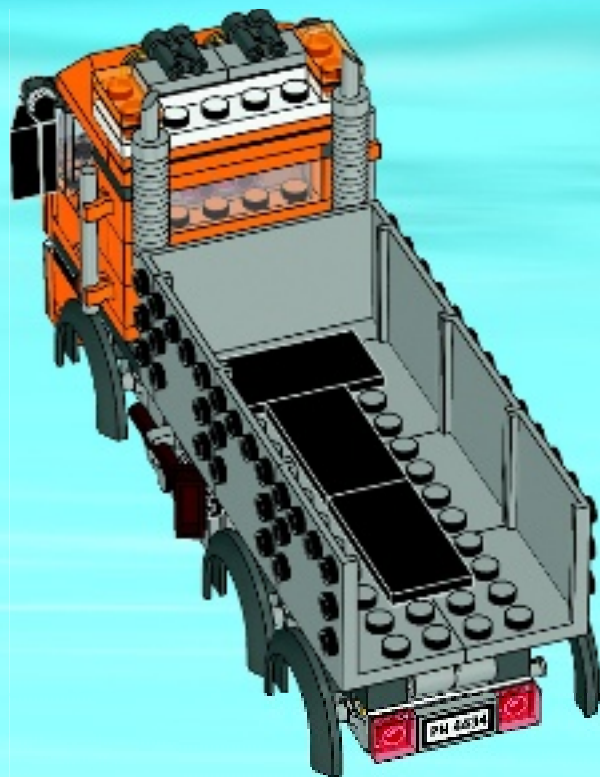



30

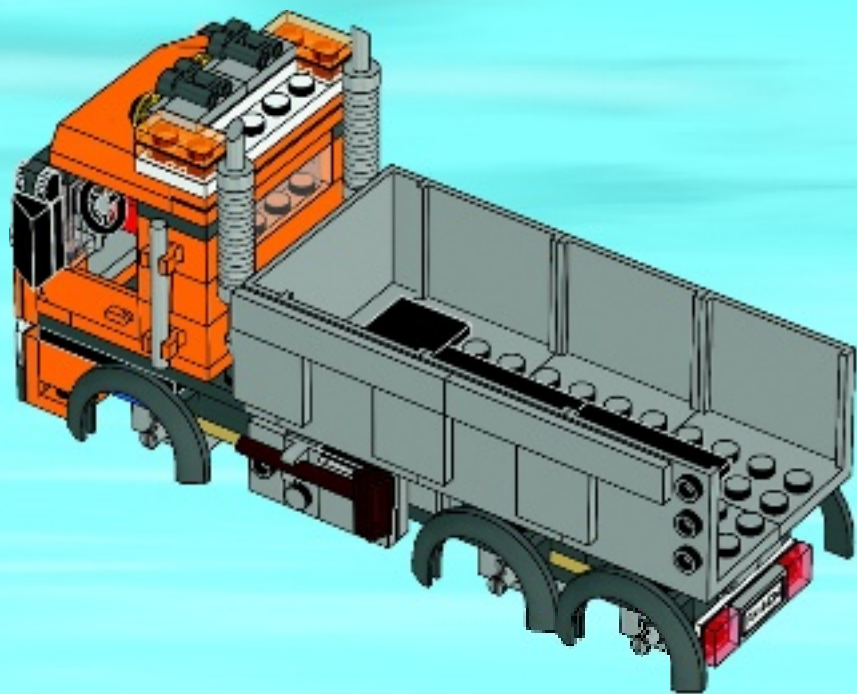

31

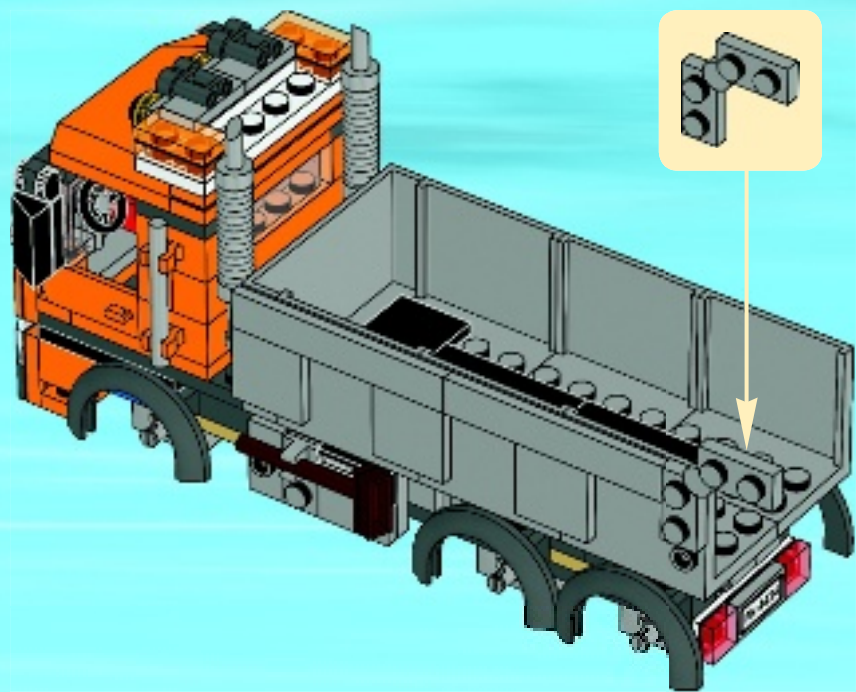

32

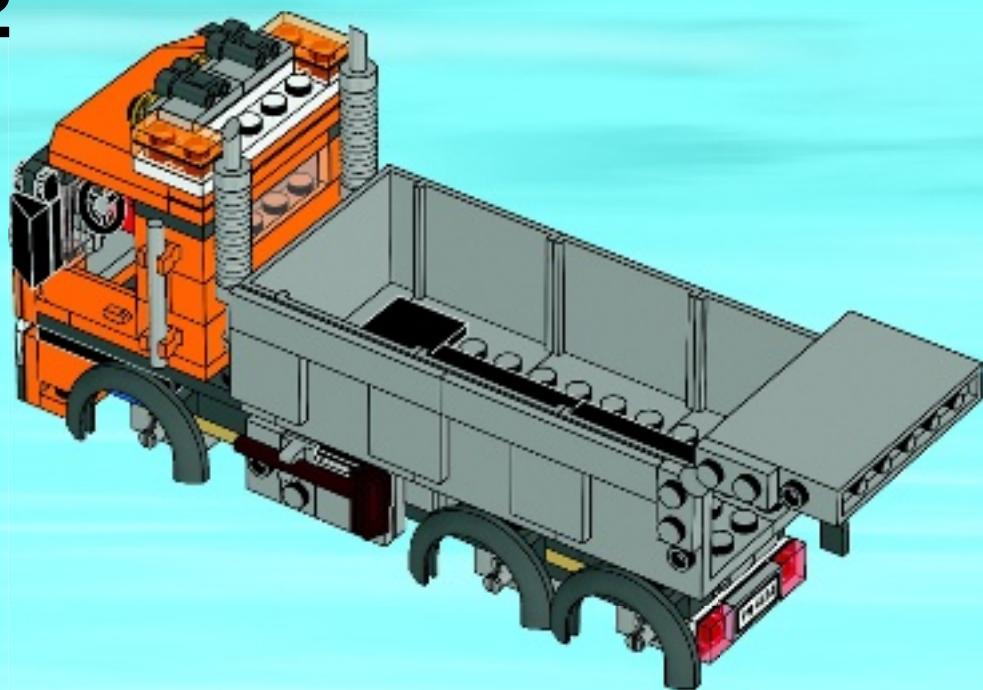

33

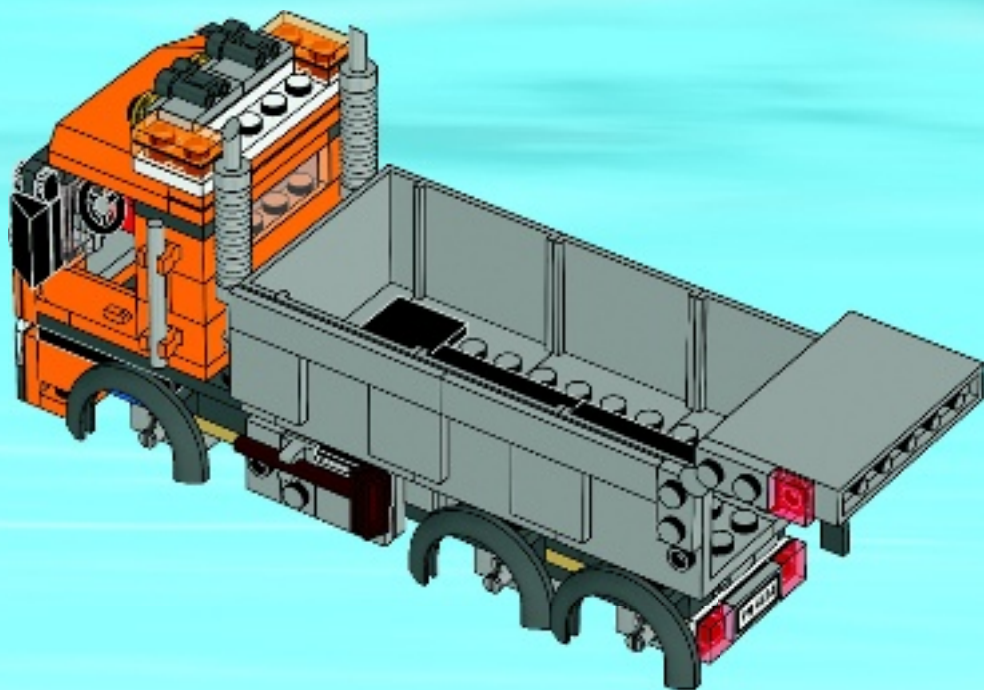

34

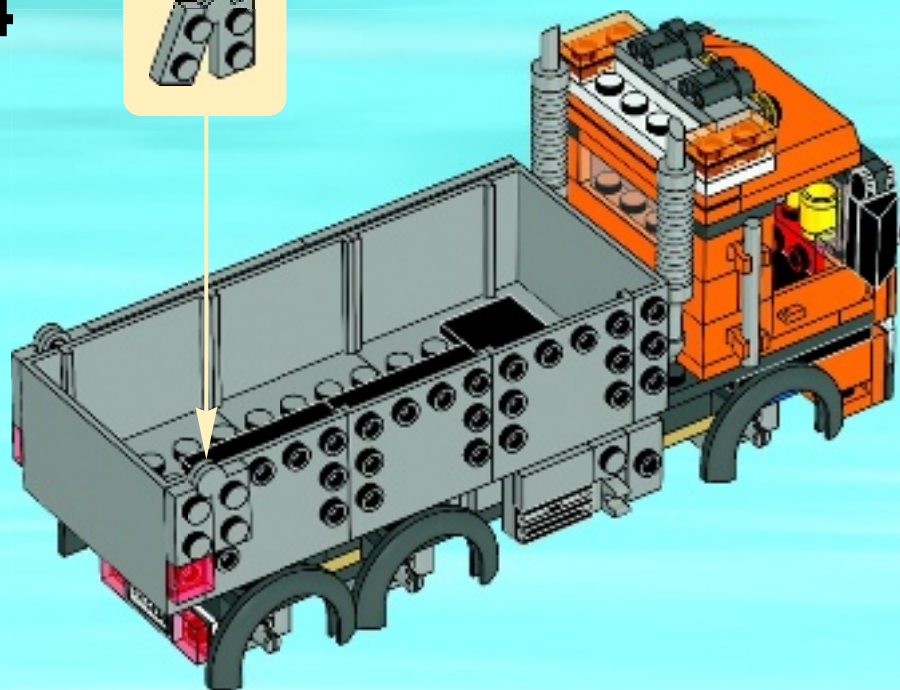

35

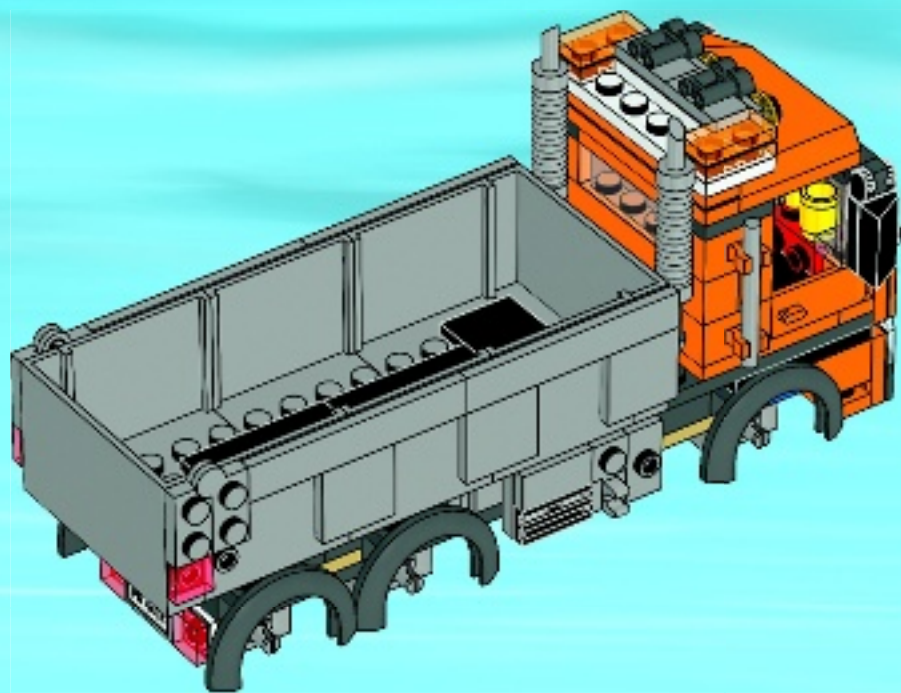

36

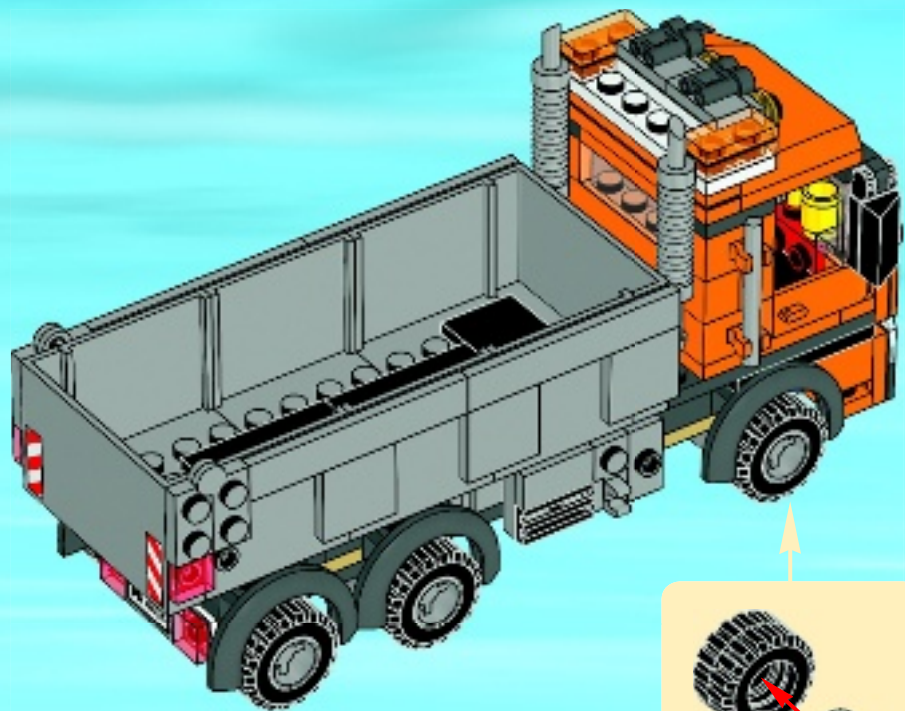

37

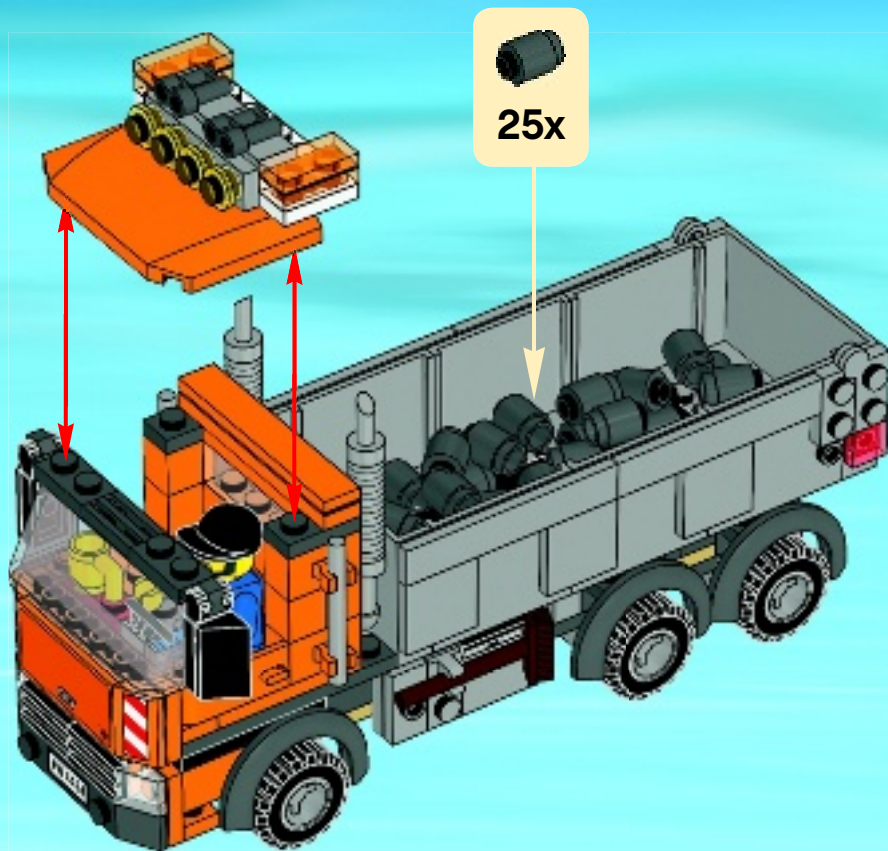





CITY



4431



4432



4433



4434



4435



CITY



4440



4439



4441



4437



4436

**LEGO** CITY



4209



4208



4427



www.LEGOclub.com



LEGO Club Email



LEGO Club Magazine

**LEGO club**

**FREE! GRATIS! GRATUIT!**

**SIGN UP ONLINE!**

**www.LEGOclub.com**



**00800 5346 5555\***



**1-866-534-6258 • 1-877-518-5346**

US & Canada only

Canada seulement

- \* Freephone. Mobile charges may apply.
- \* Numéro sans frais. Des frais peuvent s'appliquer avec les téléphones cellulaires.
- \* Gebührenfrei, Kosten für Anrufe aus Mobilfunknetzen können abweichen.
- \* Gratis telefoonnummer vanaf vaste lijn.
- \* Det er et gratis nummer, når du ringer fra fasttelefon.
- \* Det är gratis, när du ringer från en fast telefon.
- \* Numéro sans frais. Des frais peuvent s'appliquer avec les téléphones portables.

**YES!** I want to join the LEGO® Club FREE! **OUI!** Je veux m'abonner au LEGO® Club GRATUITEMENT ! **Ja!** Ich möchte Mitglied im kostenlosen LEGO® Club werden.  
**Ja!** Ik wil graag GRATIS lid worden van de LEGO® Club. **Ja!** Jeg ønsker å melde meg inn i LEGO® Club gratis! **Ja!** Jag vill gå med i LEGO® Club GRATIS!

First name • Prénom  
 Vorname • Voornaam  
 Fornavn • Förnamn

Last name • Nom de famille  
 Name • Achternaam  
 Etternavn • Efternamn

Date of Birth • Date de naissance  
 Geburtsstag • Geboortedatum  
 Fødselsdato • Fødselsedatum

Street • Adresse  
 Straße, Hausnr.  
 Straat, huisnr. • Adress

City • Ville  
 Ort • Woonplaats  
 Poststed • Postort

Zip/Postcode  
 Code Postal • PLZ  
 Postcode  
 Postnummer

Email • Courriel  
 E-Mail • E-post

Boy • Garçon • Junge • Jongen • Gutt • Pojk  
 Girl • Fille • Mädchen • Meisje  
 Jente • Flicka

State  
 Prov. County

Country  
 Pays Land

Mail to: /  
 Poster à:  
 LEGO® Club  
 P.O. Box 1157  
 Enfield, CT USA  
 06083-1157

Send til:  
 LEGO® Club Norge  
 Postboks 58  
 1314 Vøyenenga

Mail to:  
 LEGO® Club  
 33 Bath Road  
 Slough SL1 3UF  
 United Kingdom

Skickas till: LEGO® Club Sverige  
 Ubox 841  
 202 29 Malmö

Per Post an:  
 LEGO® Club  
 Postfach 14 15  
 D-36243 Niederaula

Poster à:  
 LEGO® Club  
 21 rue de la banque  
 75 002 PARIS  
 FRANCE

Stuur op naar:  
 LEGO® Club  
 Postbus 40250  
 3504 AB Utrecht

Fill in your email address and we will send you a membership confirmation and monthly email newsletters. If you do not wish to receive the newsletters please tick here. Remplis ton adresse e-mail et nous t'enversons une confirmation d'adhésion ainsi que le bulletin e-mail mensuel. Si tu ne désires pas recevoir le bulletin, coche cette case. Vul je e-mailadres in en we sturen je een bevestiging van je lidmaatschap en maandelijkse e-mail nieuwsbrieven. Als je geen e-mail wilt ontvangen, kruis dan dit vakje aan.

If you do not wish to receive additional mailings from the LEGO Club please tick here. Si tu ne désires pas recevoir de courrier supplémentaire du Club LEGO, coche cette case. Als je geen verdere post van de LEGO Club wilt ontvangen, kruis dan dit vakje aan.

Ich möchte per E-Mail den monatlichen LEGO Club Newsletter erhalten. Önsker du at vi skal sende en liten hilsen til barnet ditt for å bekrefte medlemskapet, ber vi deg kryssse av i feltet, samt oppgi e-postadressen som hilsenen skal sendes til. Om du vill at vi ska skicka en bekräftelse på ditt barns medlemskap, ber vi dig sätta ett kryss i rutan och skriva den e-post adress som bekräftelsen ska skickas till.

Om du vill få annan information från LEGO Gruppen, sätt ett kryss här. Dersom du ønsker å motta annen informasjon fra LEGO Gruppen, setter du ett kryss her.

 The English language version of the magazine can only be mailed to addresses in the US, Canada, the UK, and Republic of Ireland. Club membership is valid for two years and includes free copies of the LEGO Club Magazine and e-mail newsletters. In the US and Canada please allow up to 6 weeks for delivery of your first magazine. In the UK and Republic of Ireland please allow up to 14 weeks for delivery of your first magazine. By signing this form you consent the LEGO Club to use your child's data for LEGO mailings. The data will only be used for LEGO mailings and will not be sold, rented or otherwise disclosed to any company outside the LEGO Company except for disclosure to companies acting as our agents to help us provide services requested by the child. This coupon is valid for one free membership per person, group or organization. Photocopied coupons are accepted.  La version française du magazine peut être postée uniquement au Canada, l'abonnement est valide pour deux ans et inclut des exemplaires gratuits du Magazine LEGO, Aux E.U. et au Canada, allowez 6 semaines pour la livraison. En remplissant ce formulaire, vous consentez à ce que LEGO utilise les informations de votre enfant pour des envois postaux de LEGO. L'information sera utilisée uniquement pour des envois postaux par LEGO et ne sera en aucun cas, vendue, louée, échangée ou divulguée à d'autres compagnies, autres que la compagnie LEGO à l'exception des compagnies affiliées qui nous procurent des services auxquels l'enfant en a fait la demande. Formulaires photocopiés acceptés.  Mit der folgenden Unterschrift erkläre ich, für mein Kind den Beitritt als Mitglied zum kostenlosen LEGO Club, der von der LEGO GmbH, D-85627 Grasbrunn, betrieben wird. Die Mitgliedschaft beinhaltet die Zusendung des LEGO Club Magazins und kann beiderseits jederzeit beendet werden. Die Mitgliedschaft im LEGO Club sind keinerlei Verpflichtungen verbunden. Das deutschsprachige LEGO Club Magazin wird nur an Adressen in Deutschland, Österreich und der Schweiz versendet. Eine Anmeldebestätigung kann nur per E-Mail geschickt werden. Das Magazin erscheint fünfmal jährlich. Daher kann die Zustellung des ersten Heftes bis zu drei Monate dauern. Die Mitgliedschaft ist beidseitig jederzeit kündbar, ohne dass Ihnen Kosten entstehen. Sie können der werblichen Nutzung Ihrer Daten jederzeit widersprechen. Kündigung und Widerspruch können Sie telefonisch erklären (00800 / 5346 5555, Anruf gebührenfrei, Kosten für Anrufe aus dem Mobilfunknetz können abweichen) oder an die LEGO GmbH senden.  Het Nederlandse LEGO Club Magazine kan alleen worden gestuurd naar adressen in Nederland. Het lidmaatschap is 2 jaar geldig en geeft recht op toezending van het gratis LEGO Club Magazine in LEGO Club e-mails. Het eerste magazine zal binnen 12 tot 14 weken toegestuurd worden. Het lidmaatschap kan op ieder moment opgezegd worden en kan na 2 jaar gratis worden verlengd, tenzij LEGO met deze activiteit stopt. Uw gegevens worden uitsluitend gebruikt voor mailings van LEGO en zullen niet worden verkocht, verhuurd of op welke wijze dan ook verstrekt aan derden buiten de LEGO Groep, uitgezonderd de organisaties die namens ons optreden om de informatie te sturen waarvoor toestemming is verleend.  Den norske utgaven av magasinet sendes kun til adresser i Norge. Medlemskap i klubben gjelder i 2 år og inkluderer gratisutgaver av LEGO Club Magazine. Pårenning minimum opp til seks uker leveringstid for første magasin. Ved å undertegne dette skjemaet, gir du ditt samtykke til at LEGO Club kan bruke opplysningene om barnet ditt i LEGO foresendelser. Dataene vil utelukkende bli brukt i LEGO foresendelser og vil ikke bli solgt, utleide eller på annen måte gjøres tilgjengelig for selskaper utenfor LEGO gruppen, unntatt selskaper som er våre agenter og som hjelper oss å tilby tjenestene barnet etterper. Dette skjemaet gjelder for ett gratis medlemskap per person, gruppe eller organisasjon.  Den svenska versionen av tidningen kan endast skickas till adresser i Sverige. Club-medlemskapet är giltigt i 2 år och innefattar gratis exemplar av LEGO Club Magazine. Vännen räkna med minimum 6 veckor för leverans av din första tidning. Genom att skicka in ditt här formuläret godkänner du att LEGO Club använder barnets uppgifter för LEGO utskick. Uppgifterna kommer bara att användas för LEGO utskick och kommer inte att säljas, hyras ut eller vidarebefordras till något företag som inte tillhör LEGO Gruppen, med undantag av företag som agerar som våra ombud för att tillhandahålla tjänster som barnet har begärt. Den här kupongen gäller för ett gratis medlemskap per person, grupp eller organisation.  En complétant ce bulletin d'adhésion, vous acceptez que LEGO Club utilise les données relatives à votre enfant pour l'envoi de courriers concernant LEGO. Ces données seront uniquement utilisées pour l'envoi d'information concernant LEGO et ne seront ni vendues, ni louées, ni utilisées par d'autres sociétés que le groupe LEGO, à l'exception des sociétés agissant pour le compte de LEGO en tant que sous-traitant de services divers. L'abonnement au LEGO Club est valable pour une période de 2 ans. Il inclut l'envoi par courrier du magazine LEGO Club et par email des newsletters. Un détail de 6 à 14 semaines est à prévoir pour la réception de votre premier magazine. Ce bulletin d'adhésion gratuit est valable pour l'inscription d'une seule personne. Les photocopies sont acceptées. ATTENTION! Le bulletin d'adhésion doit être rempli et signé par un parent ou un tuteur.

Parent's signature • Signature d'un parent ou d'un tuteur •  
 Unterschrift Erziehungsberechtigter • Handtekening ouders •  
 Foreldres/foresattes underskrift • Förälders /förmyndares underskrift

Date  
 Datum  
 Date

  
1x  
4262093

  
1x  
4651441

  
1x  
389924

  
2x  
614124

  
2x  
4569056

  
1x  
383321

  
1x  
4646527

  
2x  
4617170

  
2x  
4211541

  
2x  
4211445

  
2x  
4211395

  
3x  
4211414

  
6x  
4211451

  
2x  
4598526

  
6x  
4211413

  
6x  
4211496

  
6x  
4211764

  
1x  
4226995

  
2x  
4219256

  
6x  
4646525

  
4x  
4211549

  
4x  
4211481

  
1x  
4646512

  
1x  
4646513

  
2x  
4648115

  
2x  
4211628

  
2x  
4263192

  
1x  
4211085

  
1x  
4211134

  
4x  
4210997

  
1x  
4211067

  
3x  
4598769

  
6x  
4260124

  
25x  
4211090

  
2x  
4504378

  
1x  
4210631

  
2x  
4210883

  
2x  
4211051

  
2x  
4211063

  
1x  
4296997

  
1x  
4282737

  
1x  
4560929

  
1x  
4541808

  
4x  
4113917

  
1x  
4114001

  
1x  
4249019



2x  
4212411



2x  
4173805



1x  
4545313



3x  
4548180



1x  
4121715



2x  
4244362



2x  
4524365



2x  
302123



5x  
4648849



1x  
4545315



3x  
371026



1x  
4516843



6x  
3003941



2x  
4280341



2x  
243223



2x  
4648855



1x  
4648853



5x  
241226



6x  
4568644



1x  
4198311



2x  
4541710



2x  
9341



2x  
4118829



2x  
4648854



2x  
4183060



2x  
302228



1x  
4173328



1x  
4548877



4x  
4118782



1x  
4505118



4x  
4187209



4x  
3005744



1x  
4288003



3x  
4173332



1x  
4567910



1x  
4211157



1x  
4650690



1x  
4189007



1x  
4189009



Customer Service

Kundenservice

Service Consommateurs

Servicio Al Consumidor

[www.lego.com/service](http://www.lego.com/service) or dial



: 00800 5346 5555

: 1-800-422-5346



# WIN!

Go to [www.LEGOsurvey.com/product](http://www.LEGOsurvey.com/product) to fill out a survey for a chance to win a cool LEGO® Product.

No purchase necessary.

Open to all residents where not prohibited.



## [www.LEGOsurvey.com/product](http://www.LEGOsurvey.com/product)

### GEWINNE!

Nimm an der Umfrage auf [www.LEGOsurvey.com/product](http://www.LEGOsurvey.com/product) teil und hab die Chance ein cooles LEGO® Produkt zu gewinnen!

Die Teilnahme am Gewinnspiel führt zu keinerlei Kaufverpflichtungen. Teilnahme in allen nicht ausgeschlossenen Ländern möglich.

### WIN!

Ga naar [www.LEGOsurvey.com/product](http://www.LEGOsurvey.com/product), vul een enquêteformulier in en maak kans op een cool LEGO® product.

Geen aankoopverplichting. Iedereen mag deelnemen, uitgezonderd ingezetenden van landen waar een enquêteverbod geldt.

### GAGNE !

Visite [www.LEGOsurvey.com/product](http://www.LEGOsurvey.com/product) pour répondre à un questionnaire et avoir une chance de gagner un produit LEGO® très cool !

Aucune obligation d'achat. Ouvert à tous les résidents des pays autorisés.

### 当てよう!

[www.LEGOsurvey.com/product](http://www.LEGOsurvey.com/product) にアクセスして、アンケートにご記入ください。当選者にはレゴ®製品を差し上げます。

お買い上げの必要はありません。禁止されていない限り、すべての皆様にご利用いただけます。



[www.LEGO.com](http://www.LEGO.com)

4667230

LEGO and the LEGO logo are trademarks of the/son des marques de commerce de/son marcas registradas de LEGO Group. ©2012 The LEGO Group.