

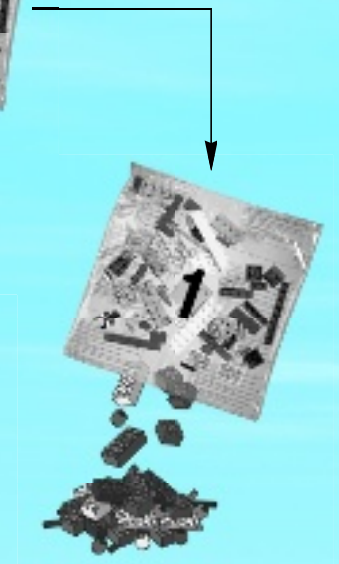

4439

# CITY

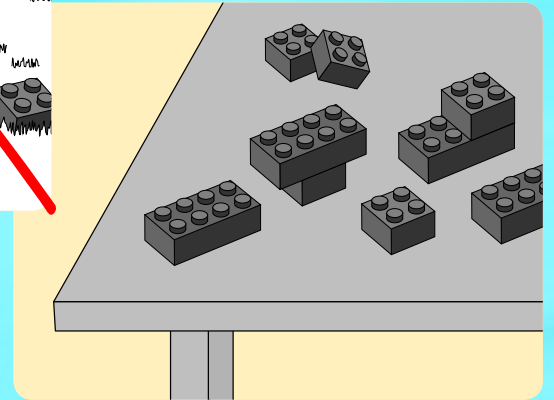

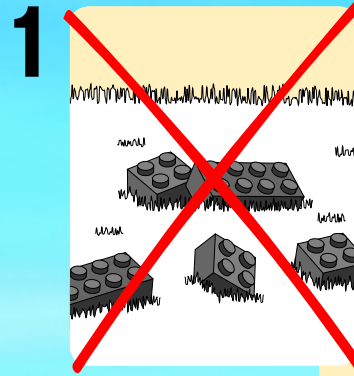
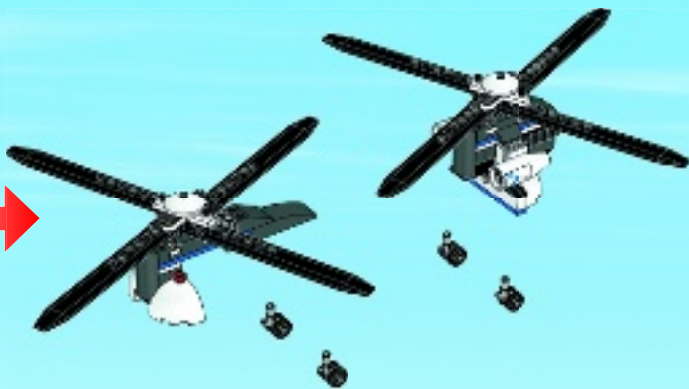
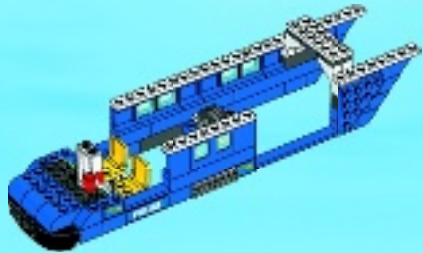
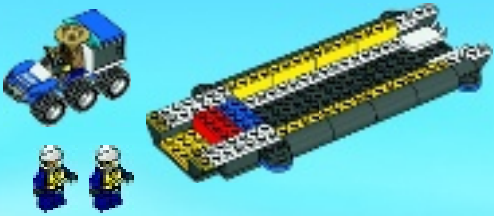



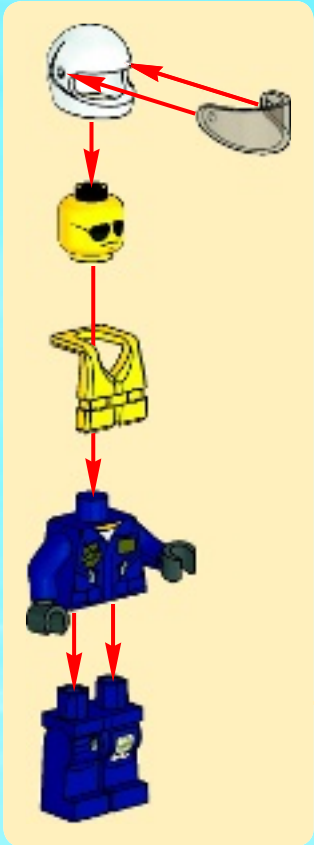
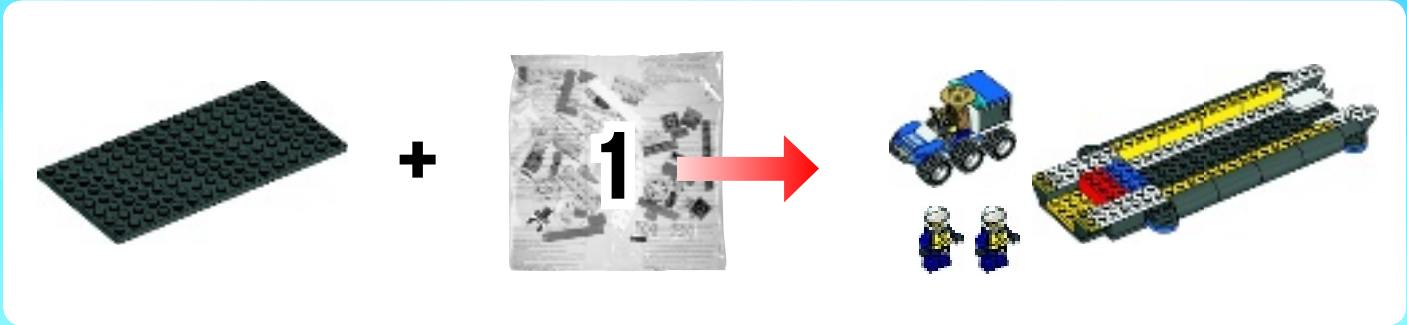

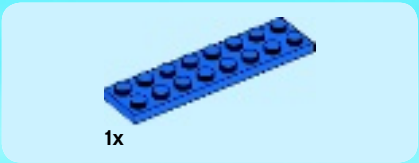

1x

1

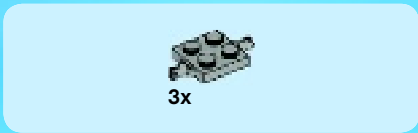
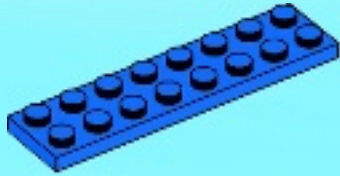

3x

2

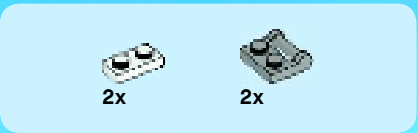
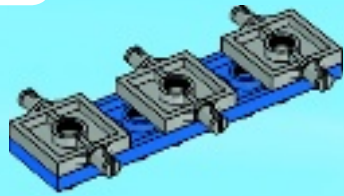

2x

2x

3

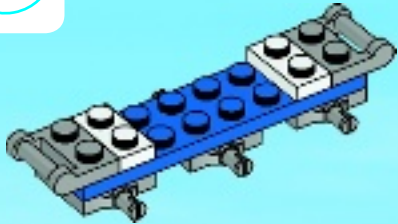



1x



1x

# 4

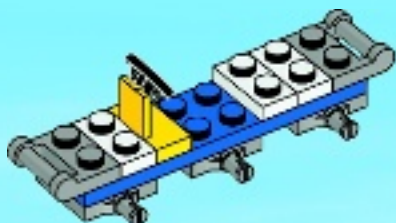

1x



1x

# 5

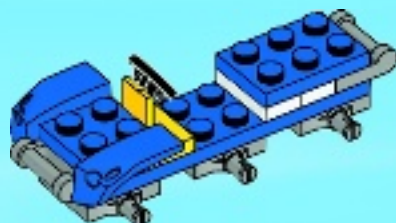

1x



1x

# 6

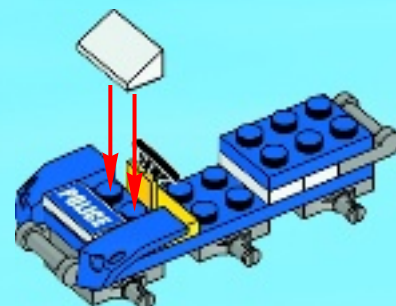



# 7

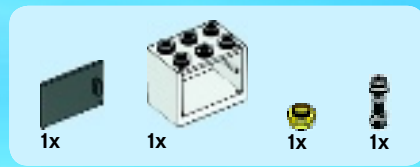
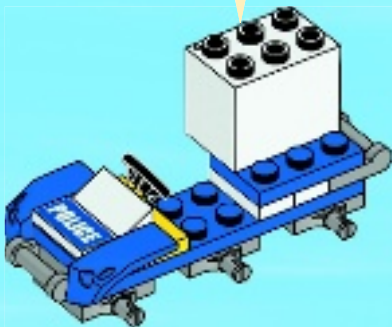
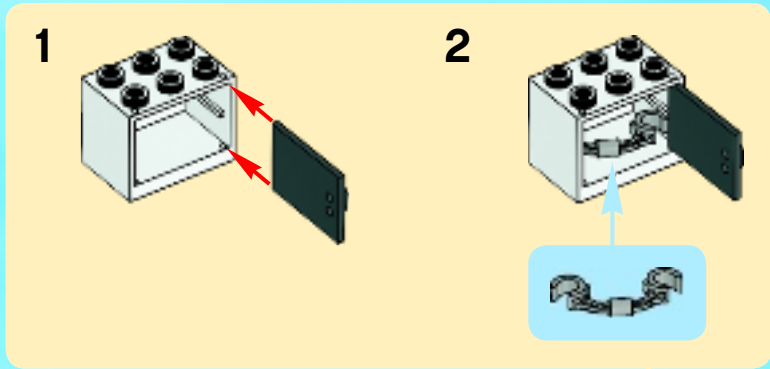

# 8

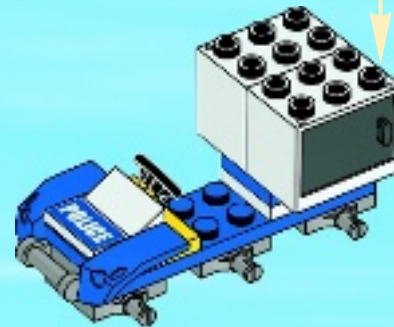
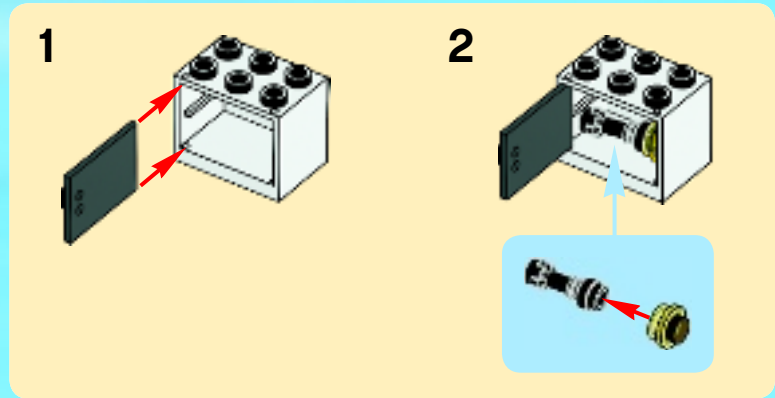



1x



1x

# 9

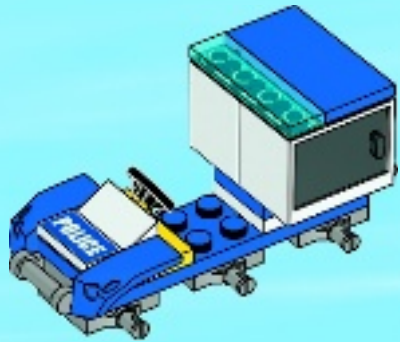

6x



6x

# 10







1x

1

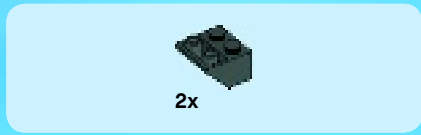

2x

2

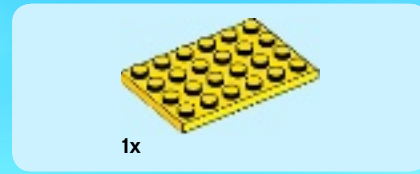
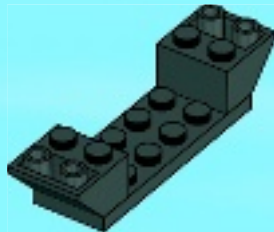

1x

3





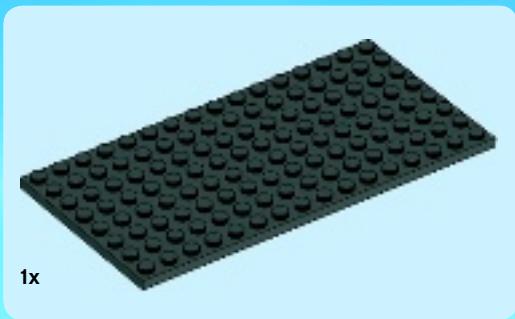

4

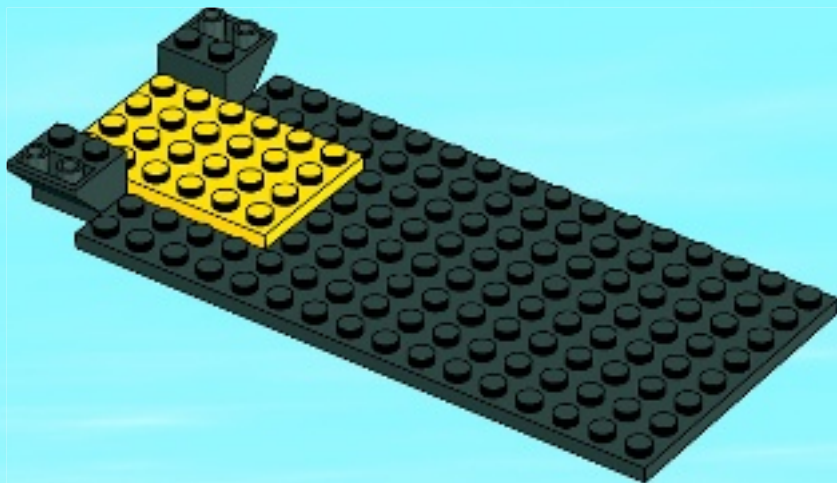

5

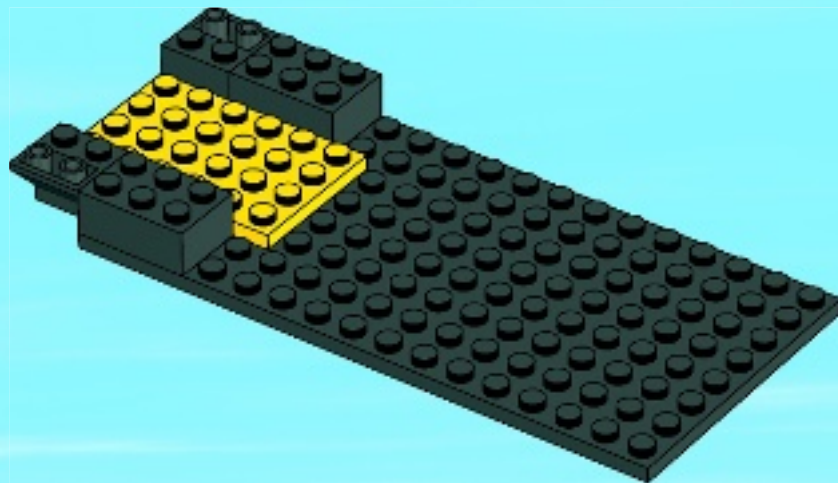



1x



2x

# 6

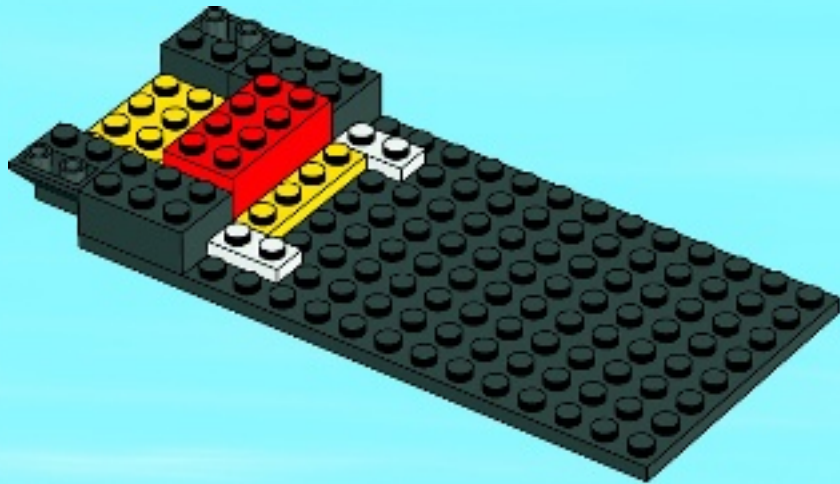

1x

# 7

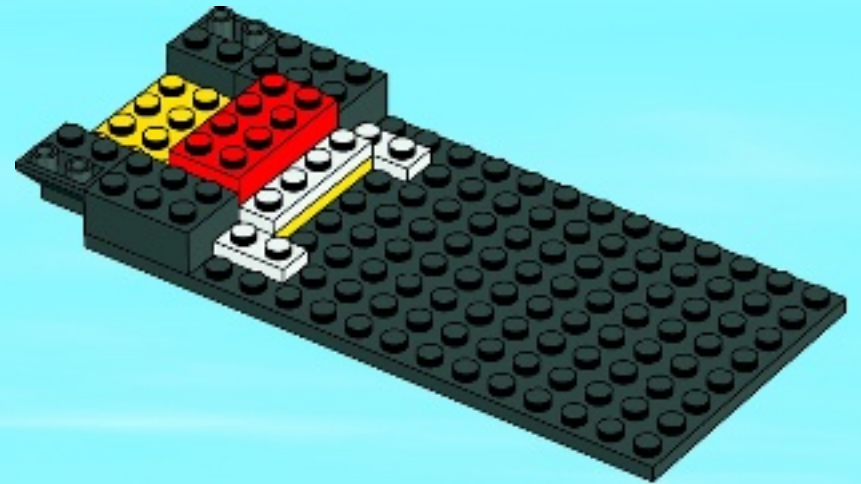



2x

8

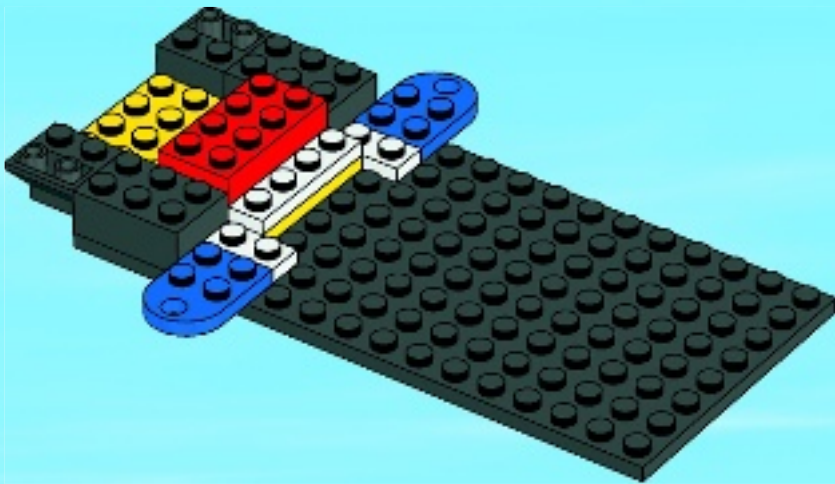

2x

9

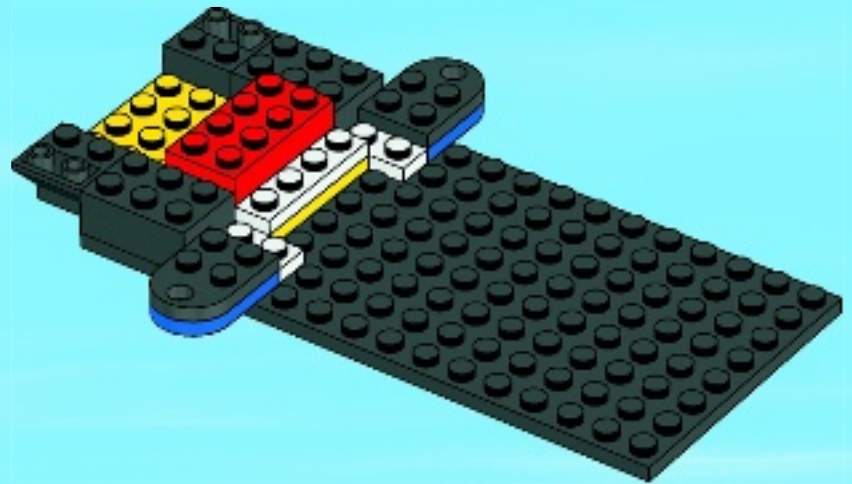

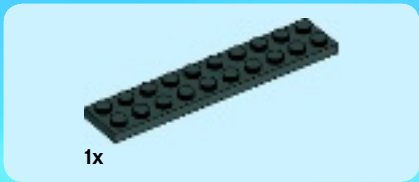

10

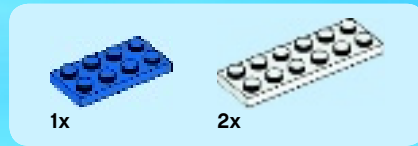
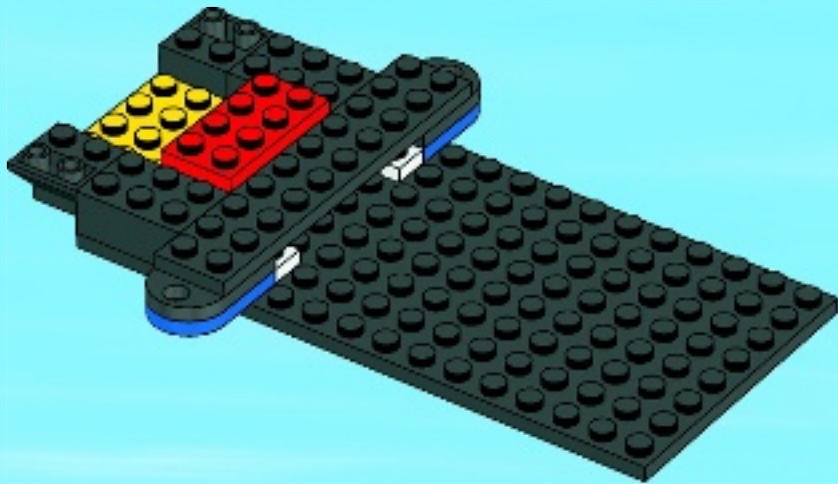

11







2x

# 12

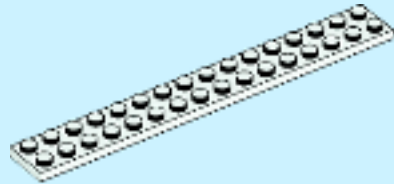
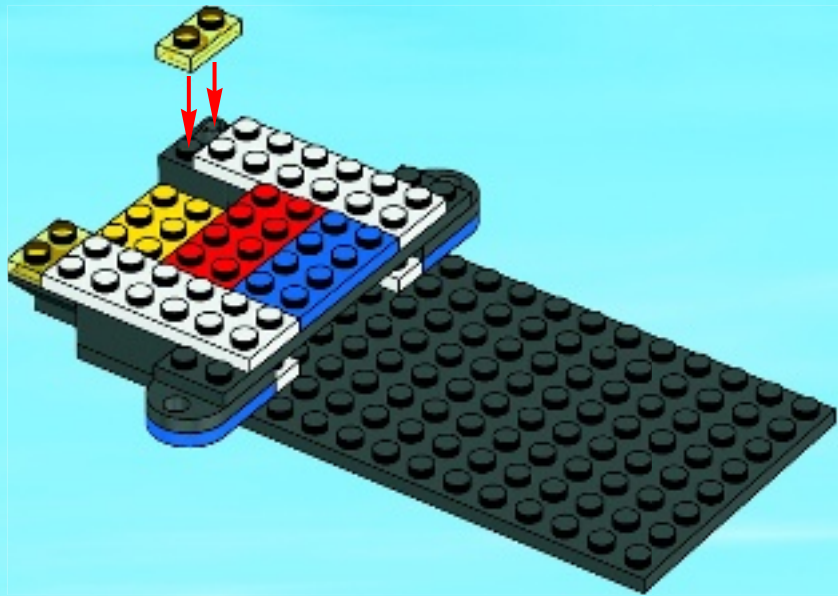

2x

# 13

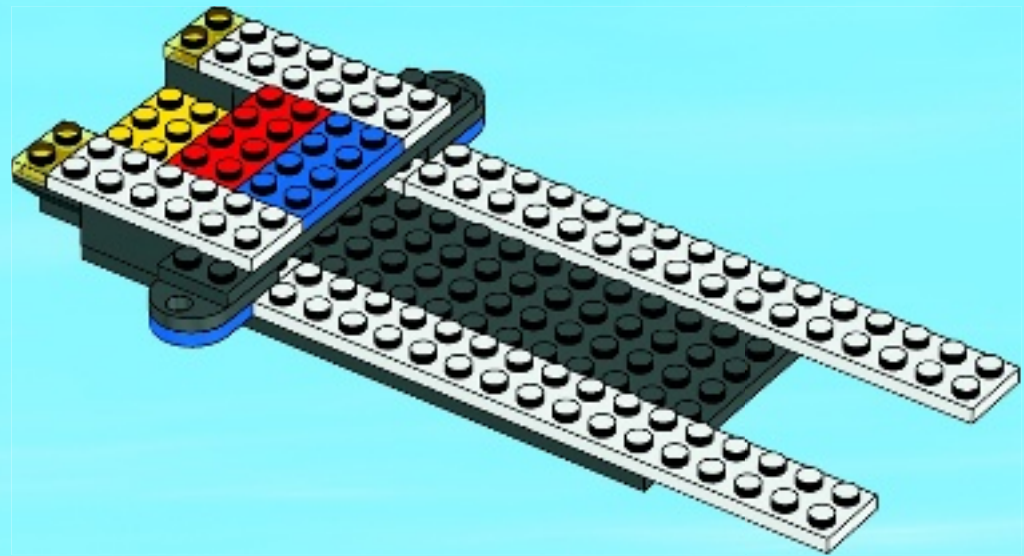



14

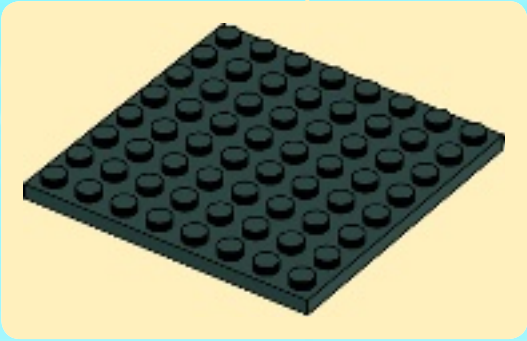
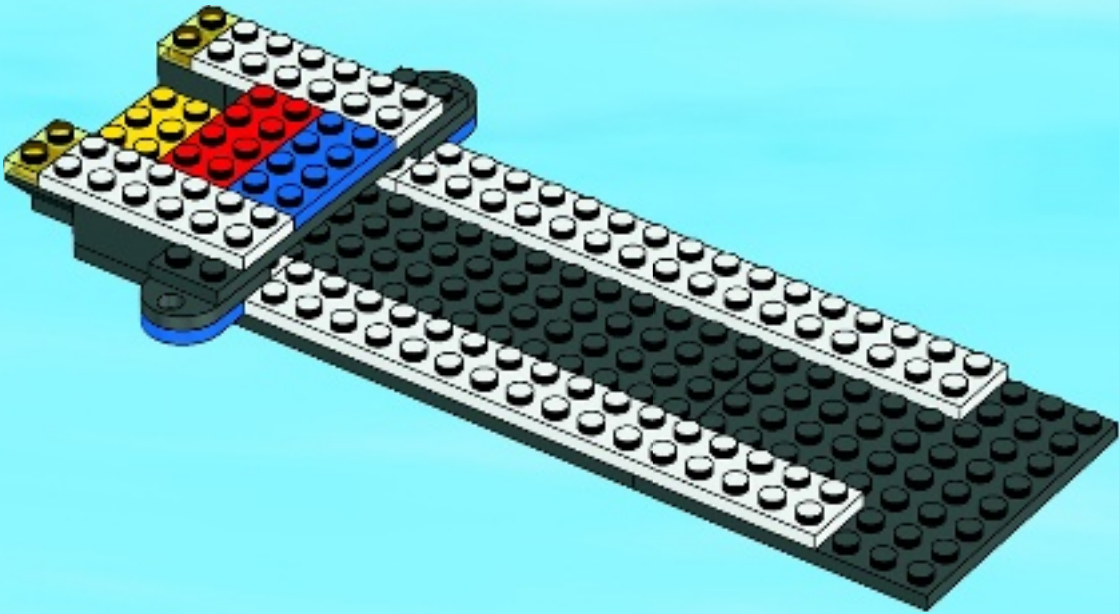



8x

# 15

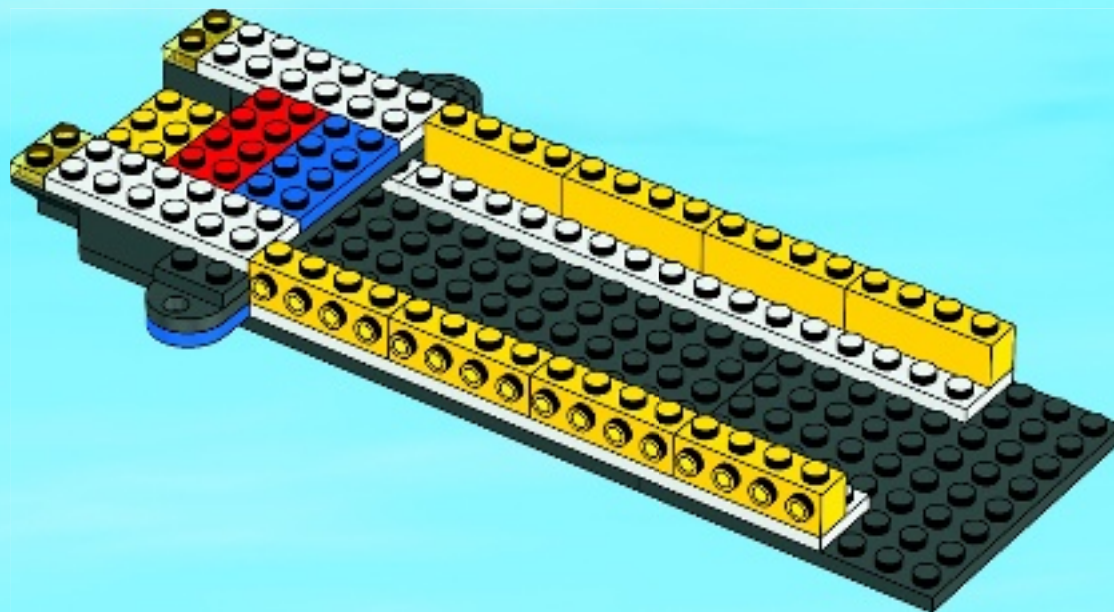



2x



2x

# 16

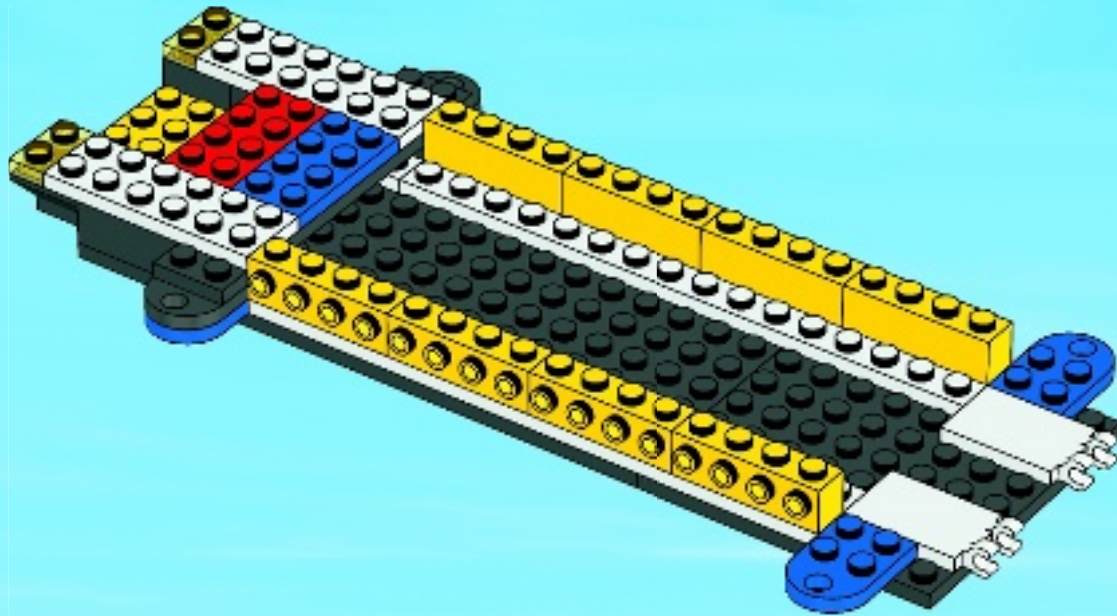





2x

17

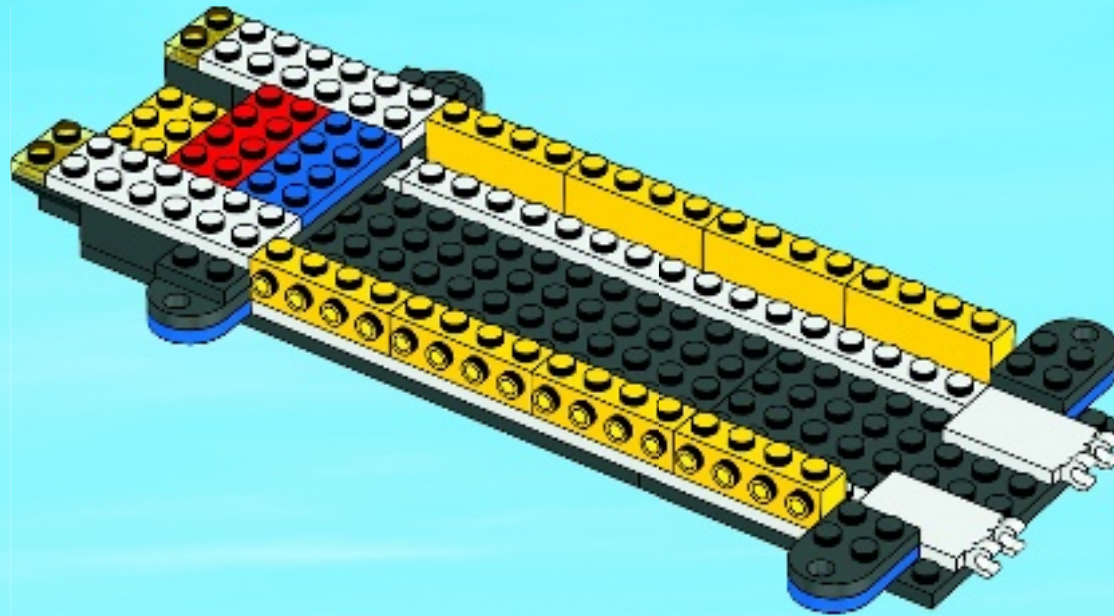



2x

# 18

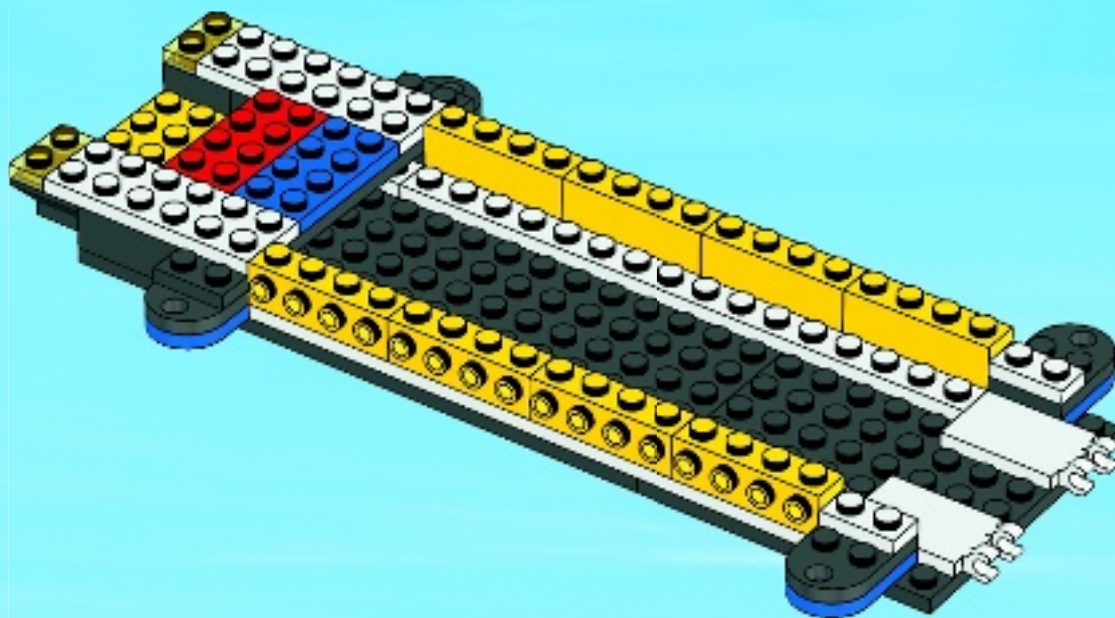



2x

# 19

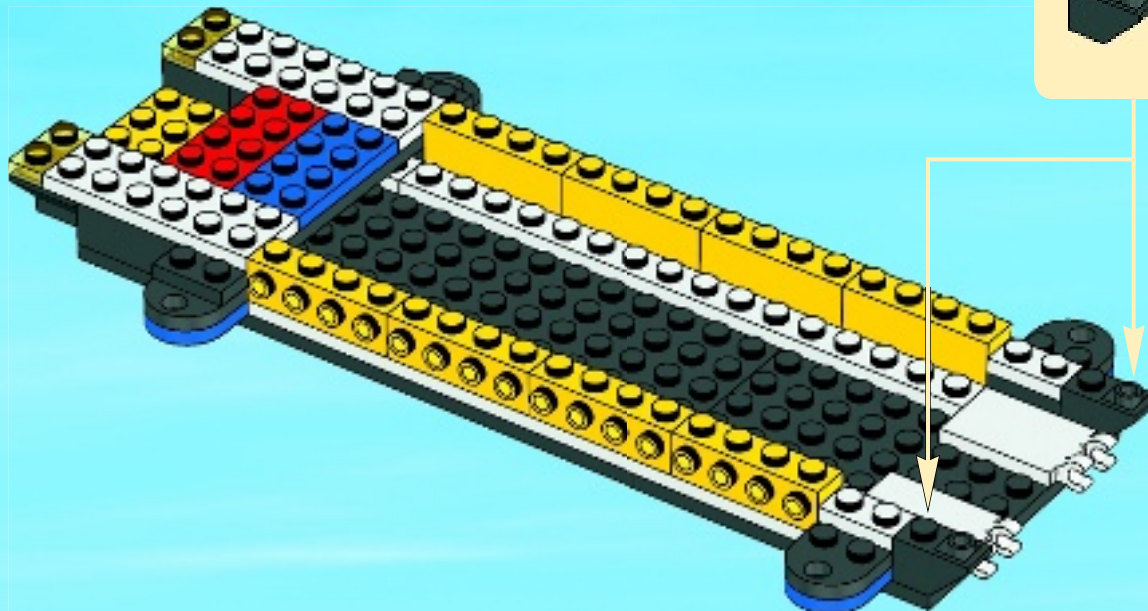

2x



2x

20

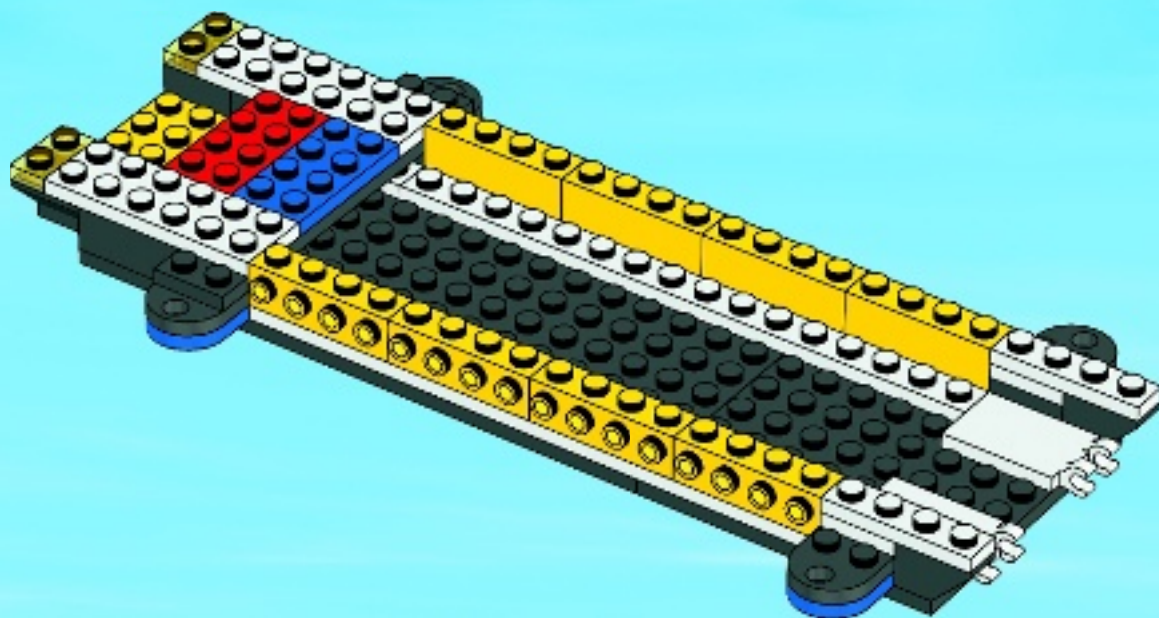





2x

# 21

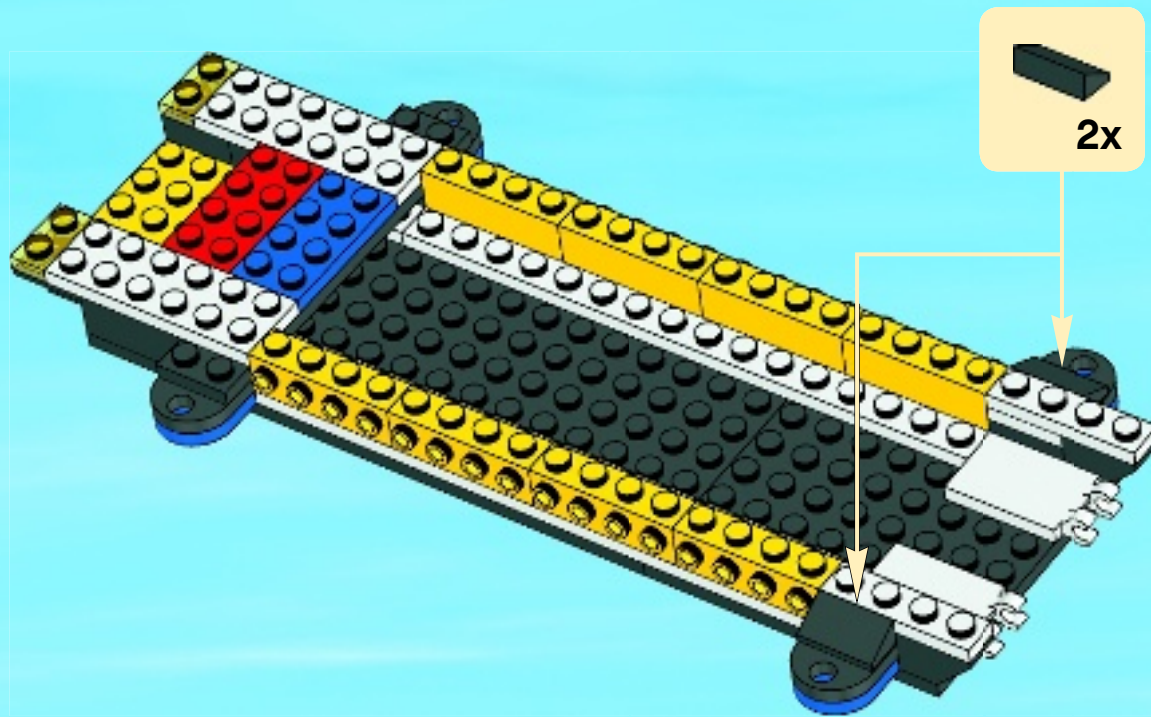

2x



8x

22



8x

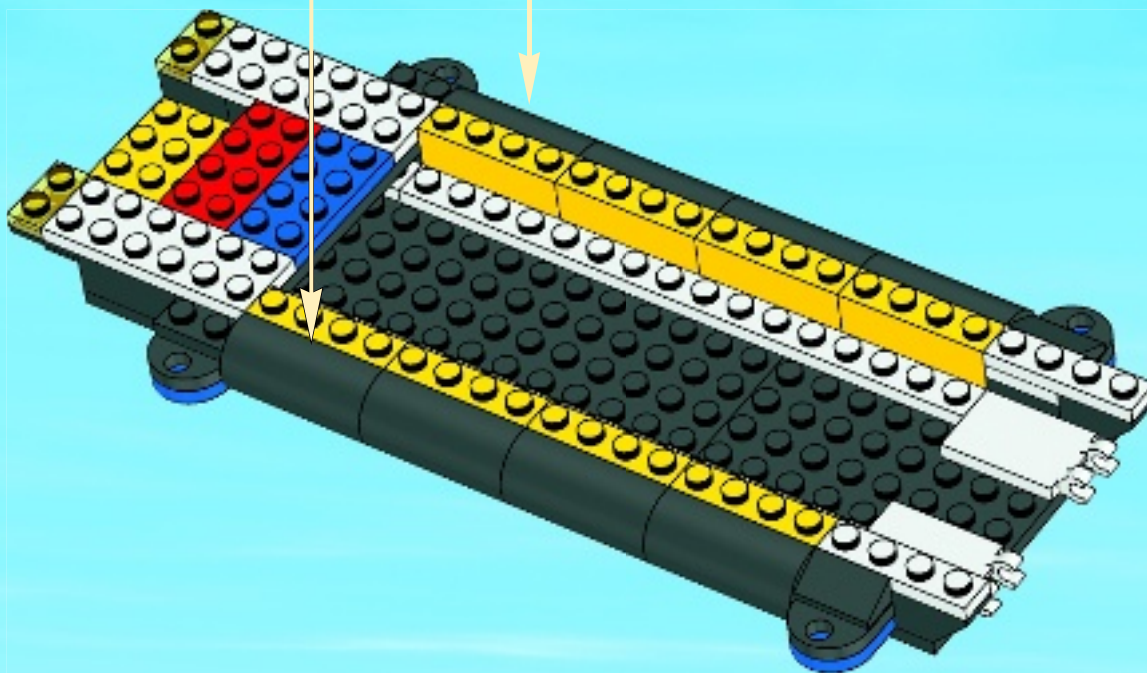

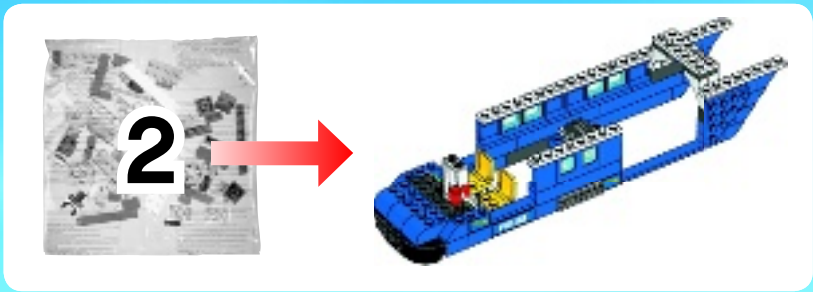

23

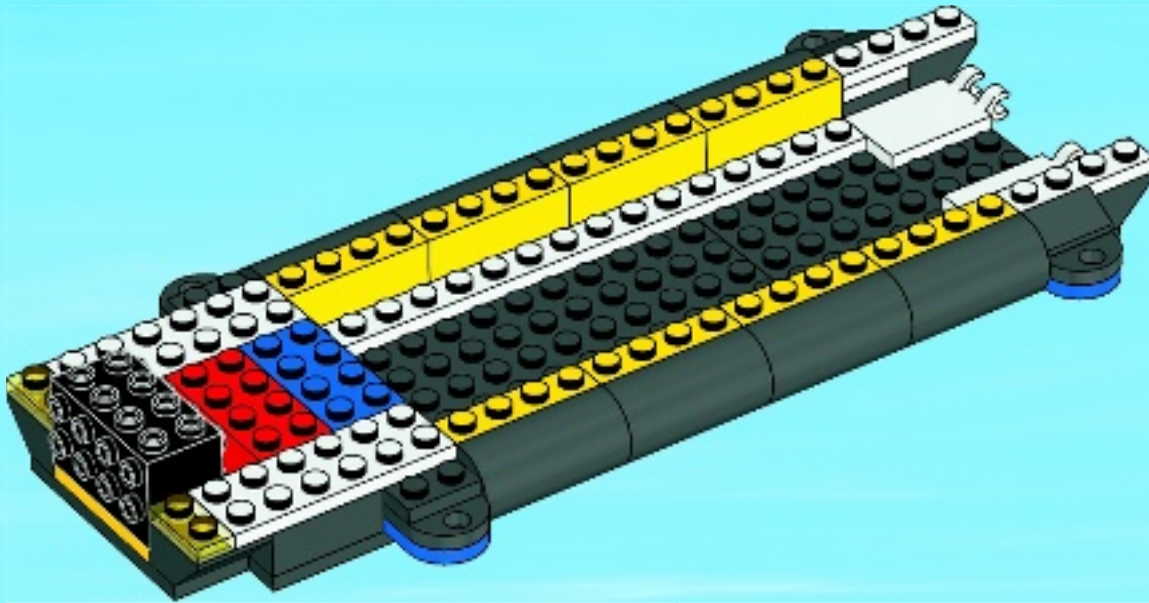



2x



2x

# 24

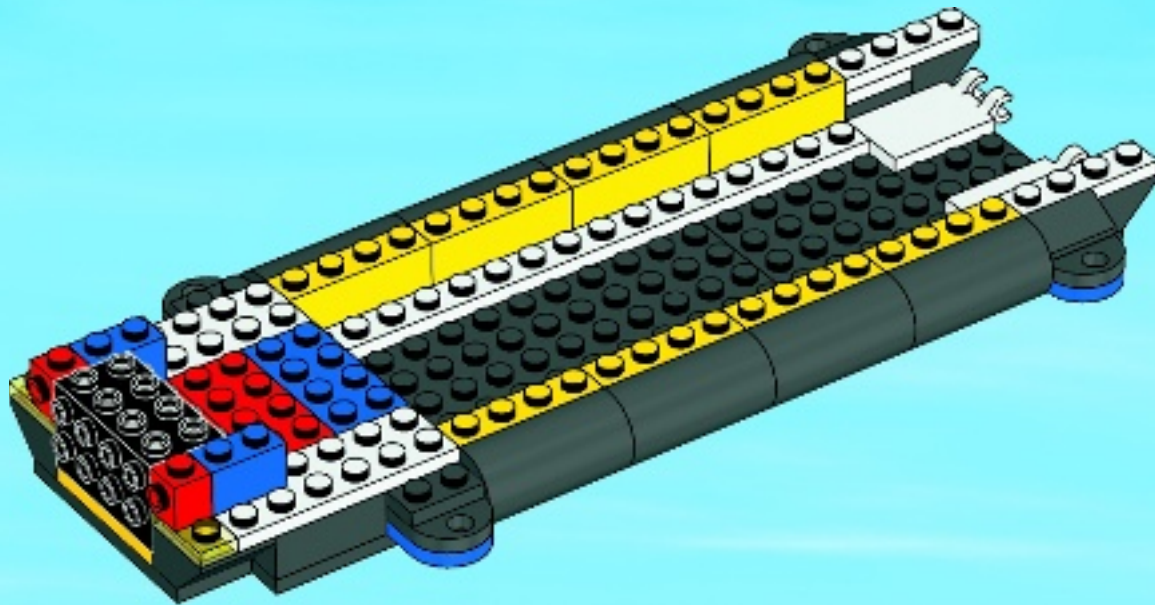



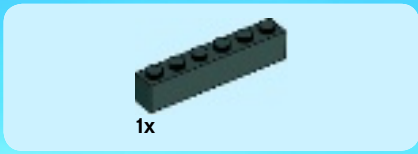

25

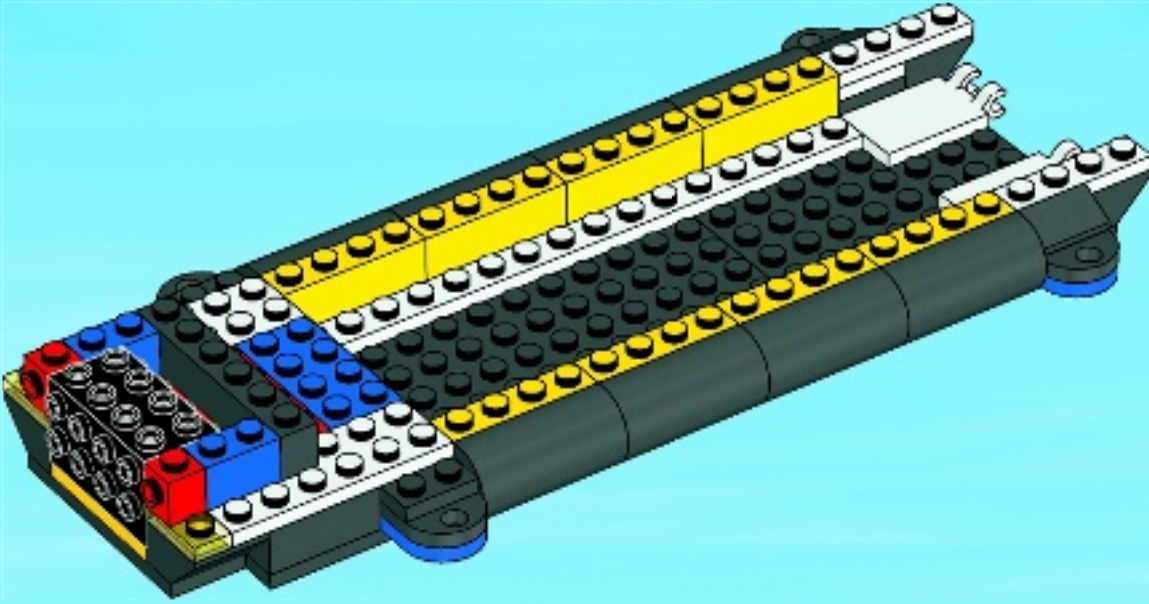



2x

# 26

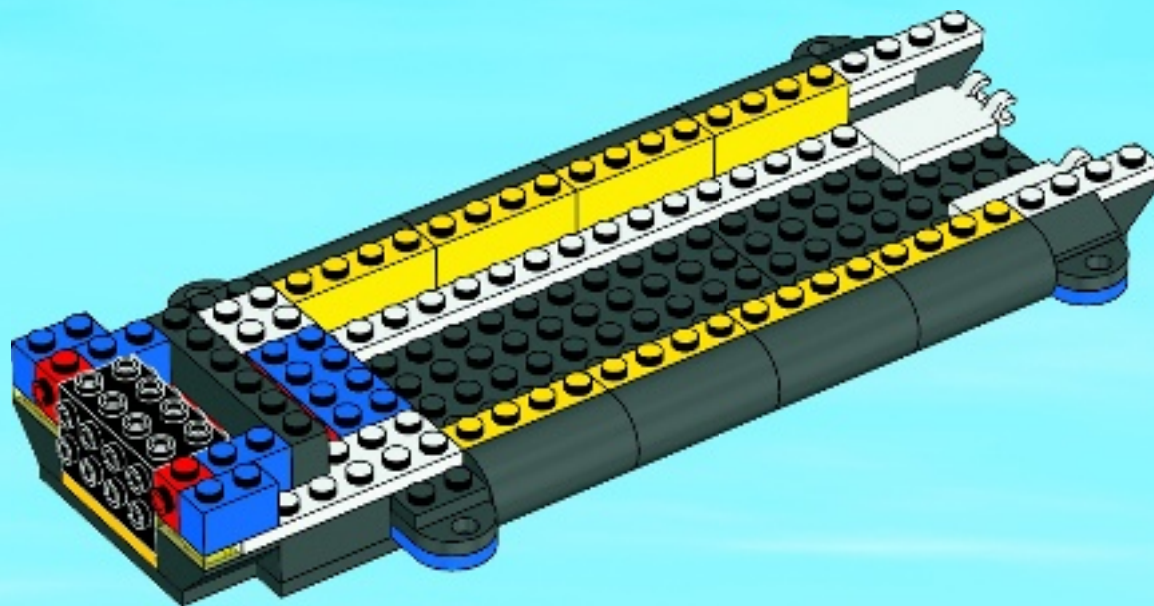

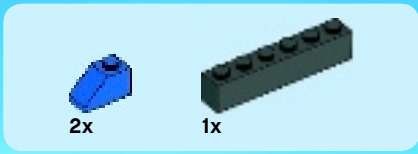

27

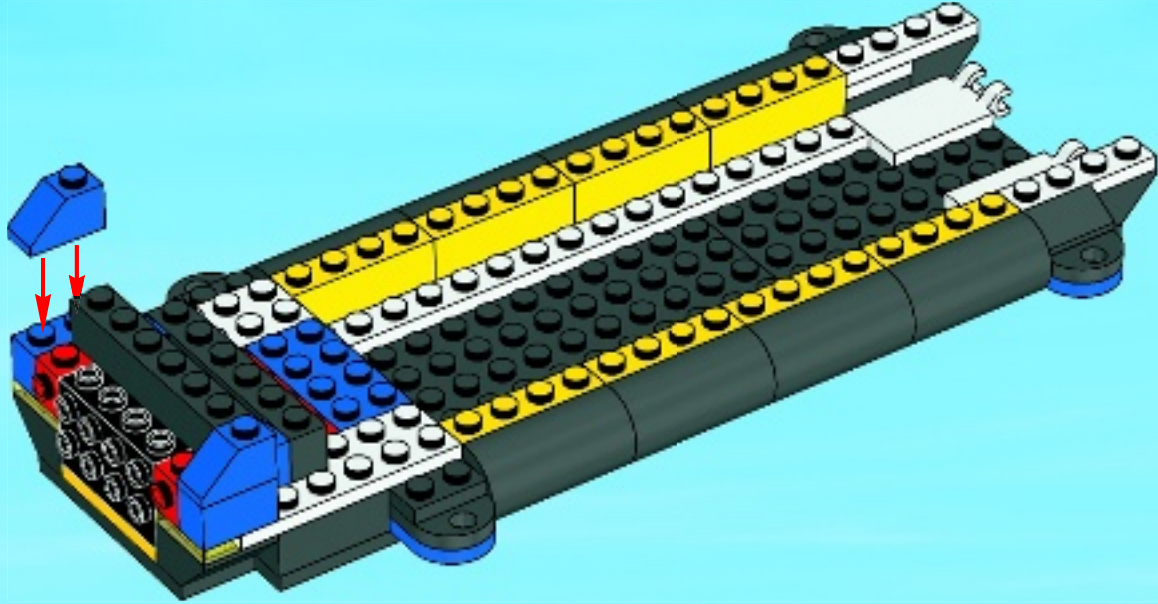



1x

28

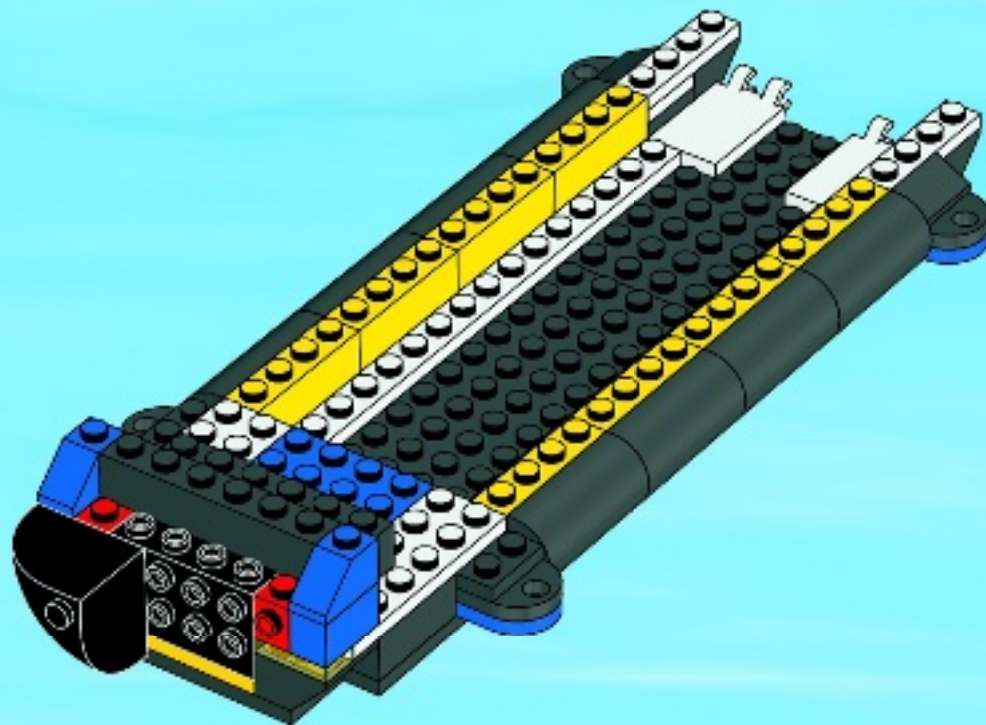





2x

# 29

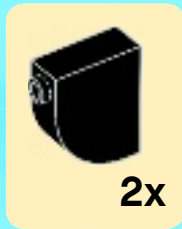

2x

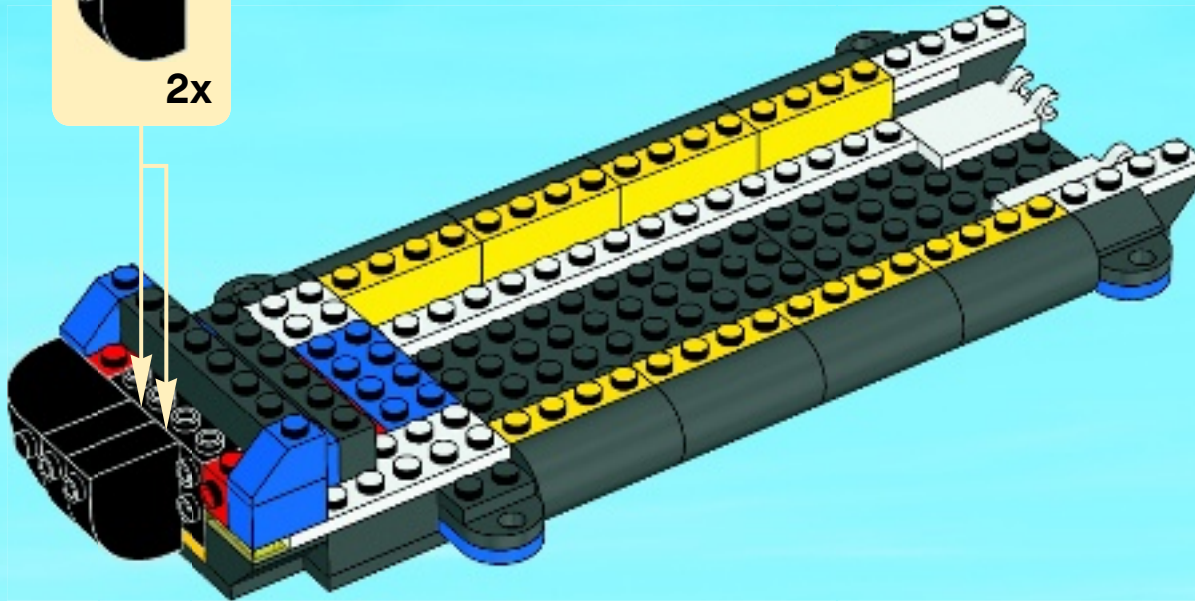



1x

# 30

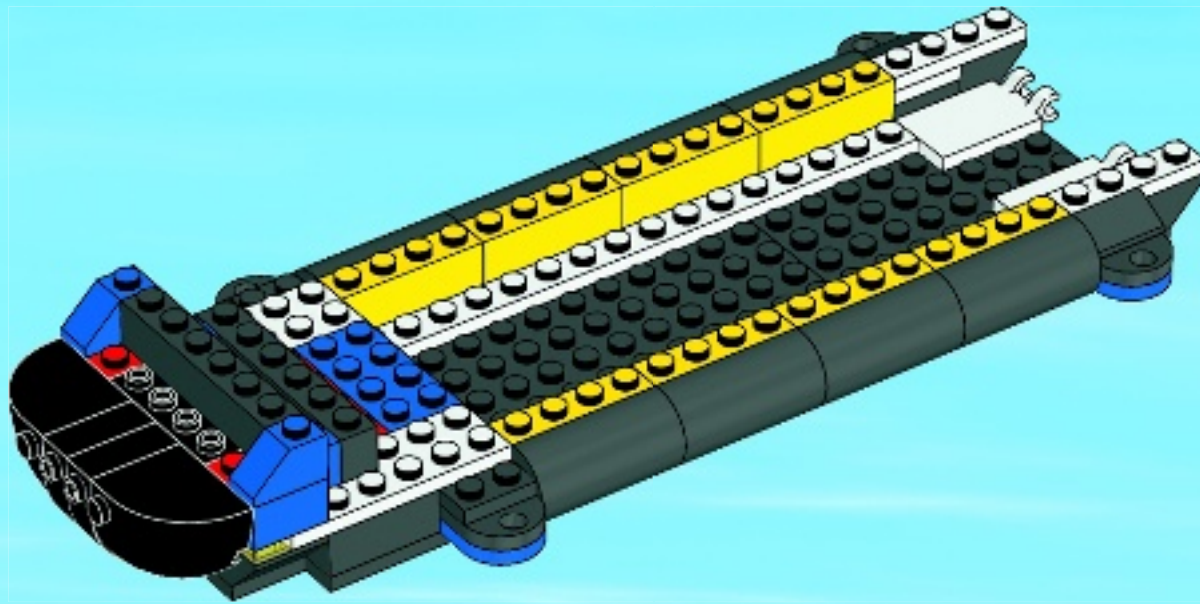



3x

# 31

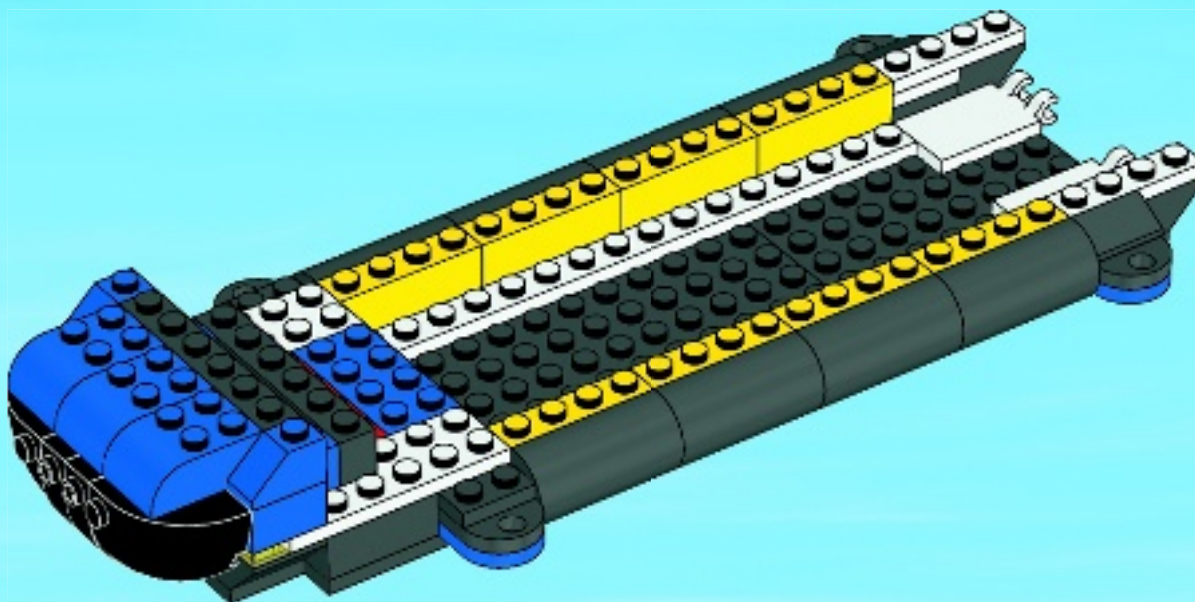



2x



4x

# 32

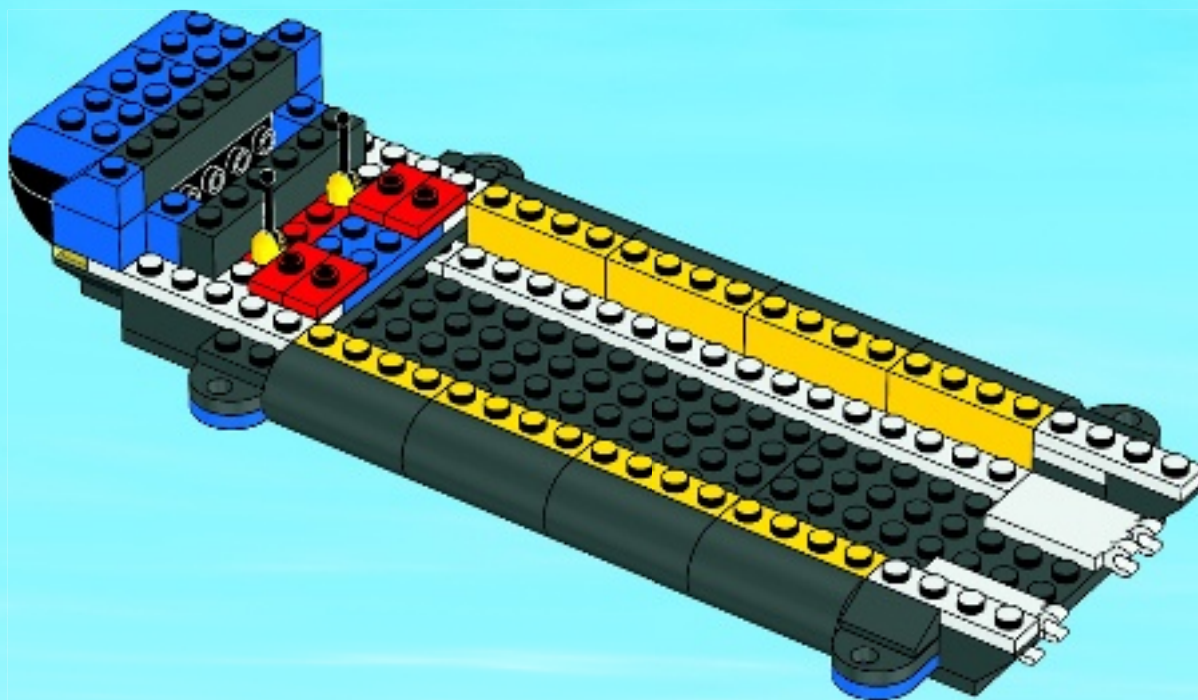





2x

33

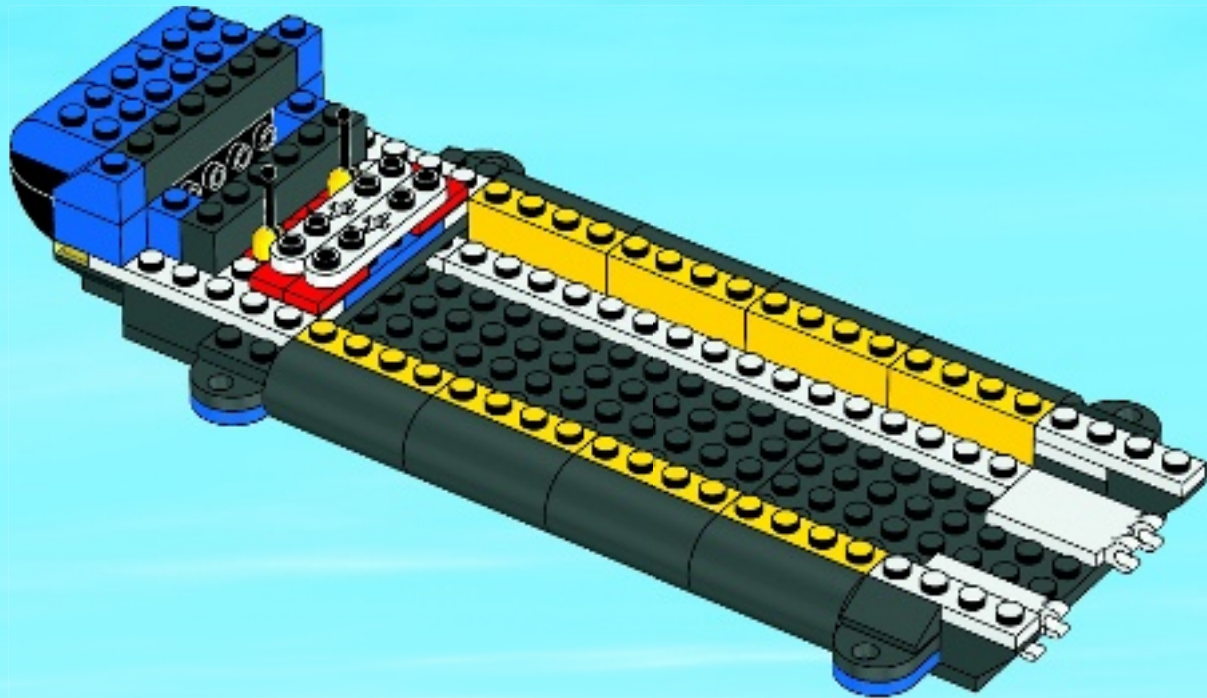

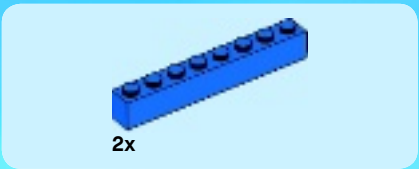

# 34

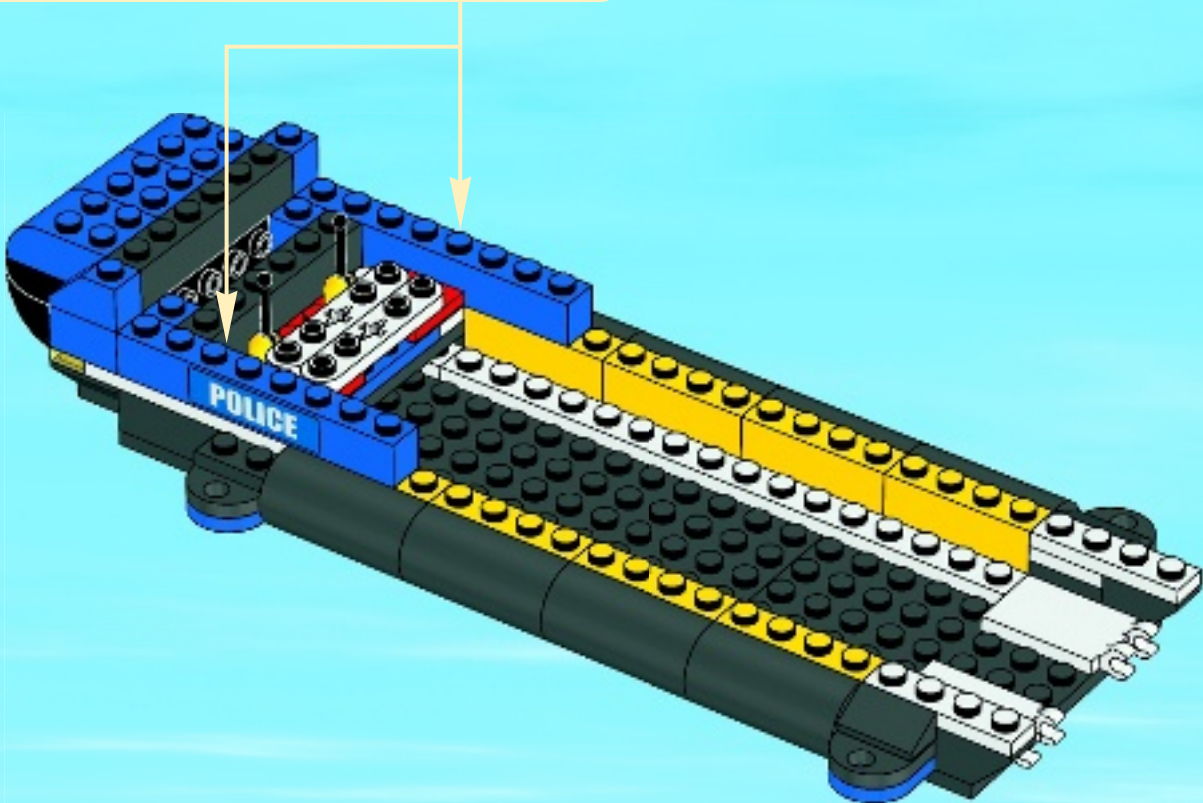
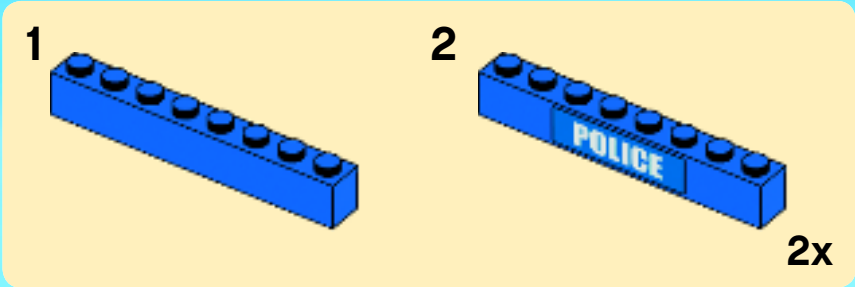



# 35

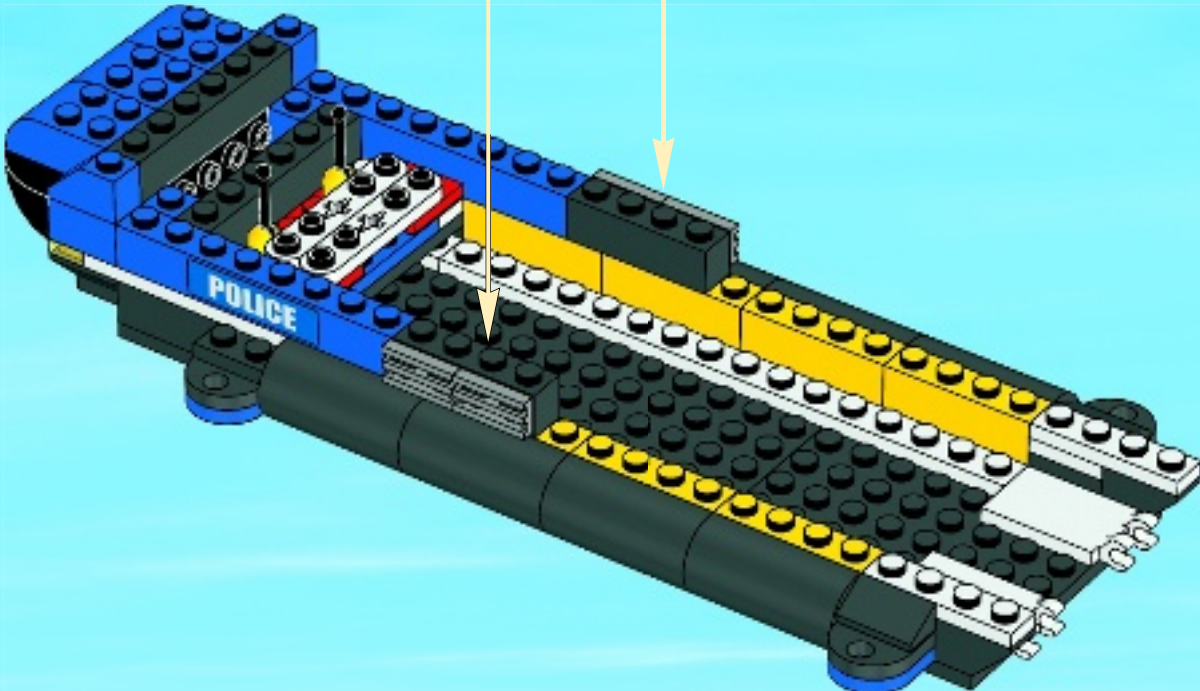
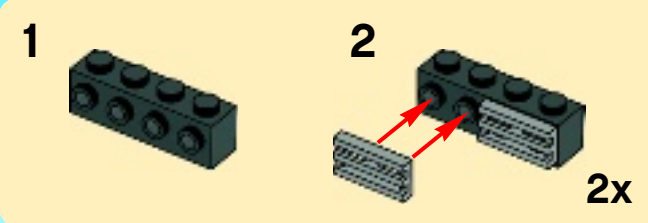

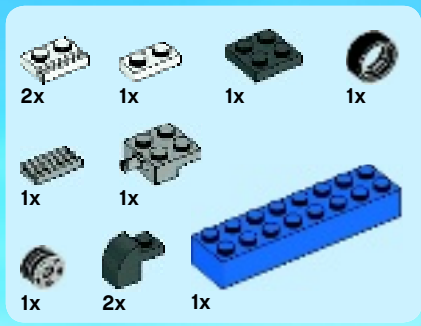

# 36

1

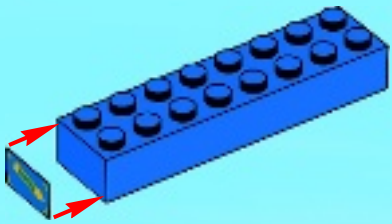

2

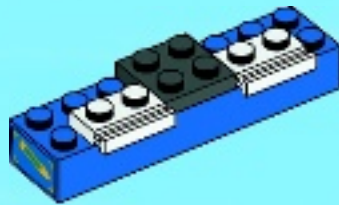

3

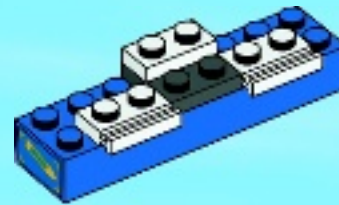

4

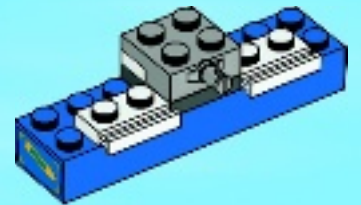



5

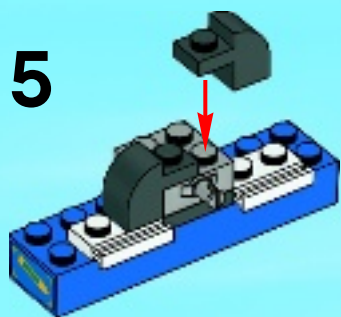

6

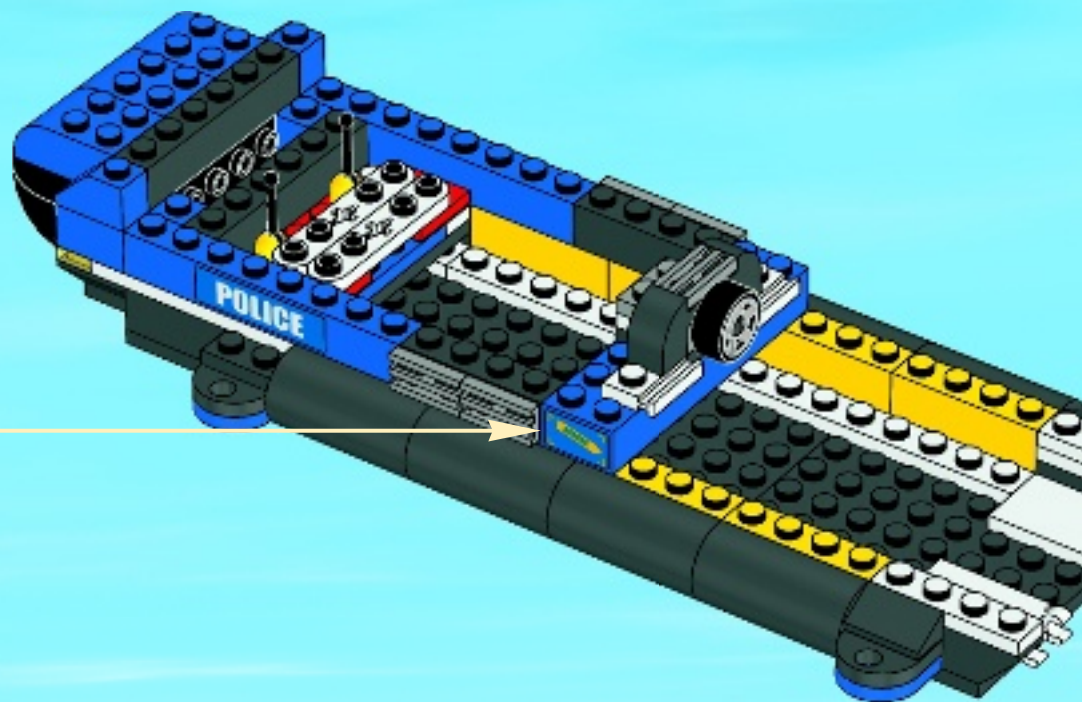
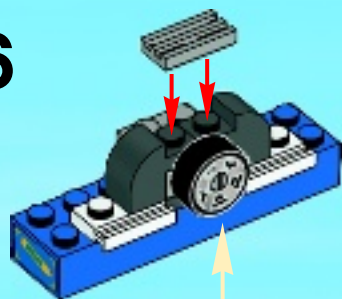

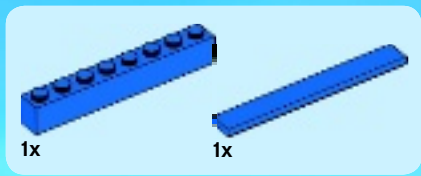

37

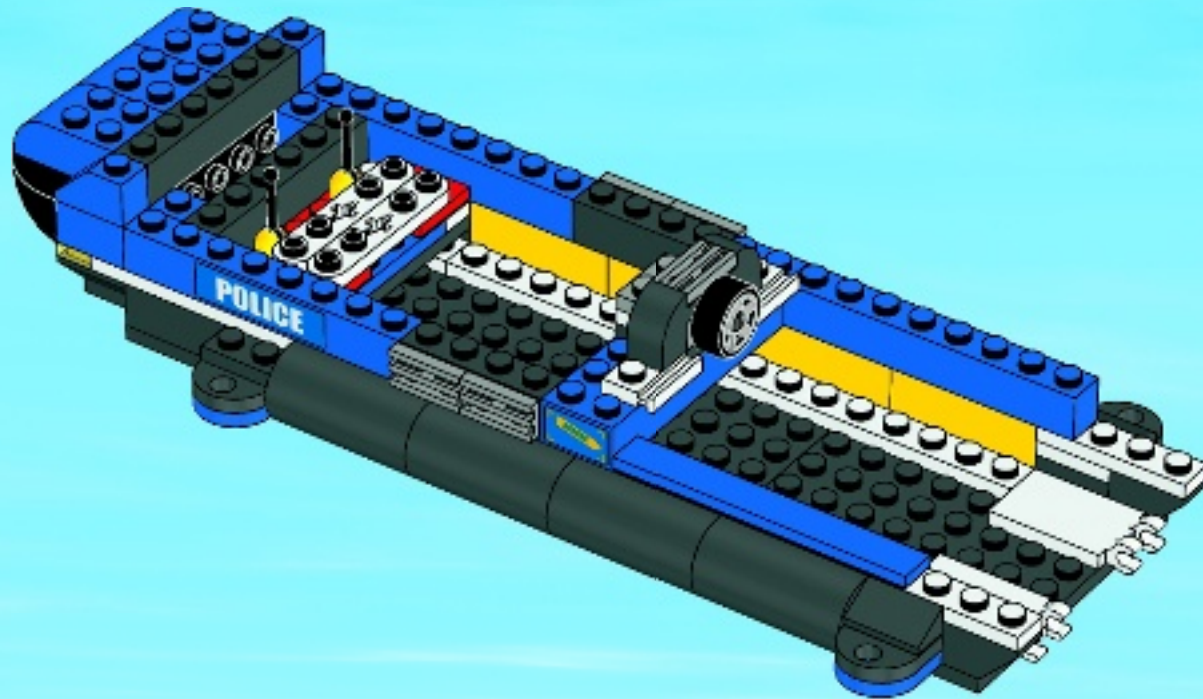



2x



2x

# 38

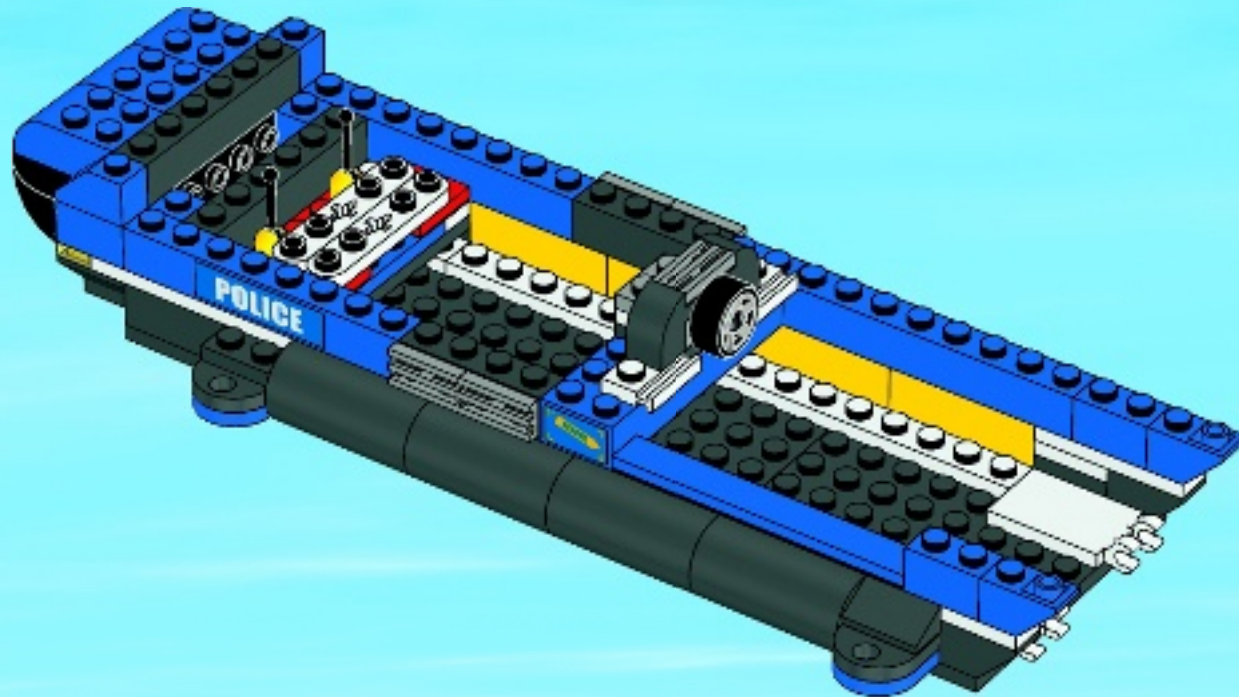





2x

# 39

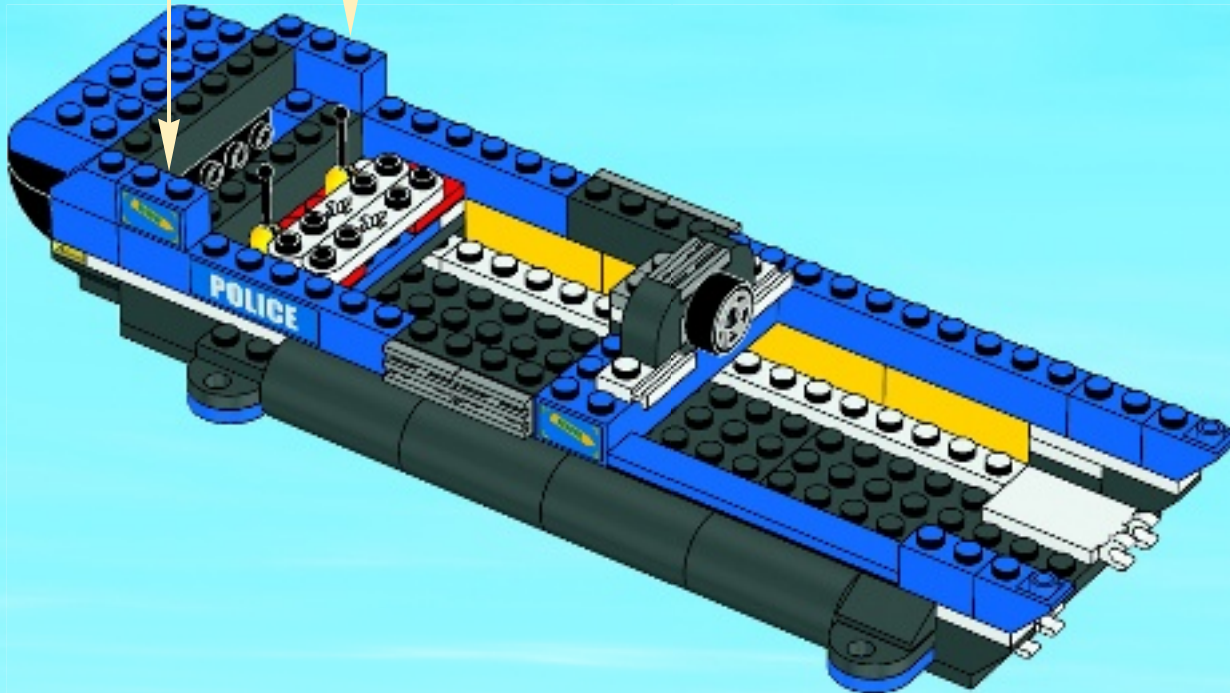
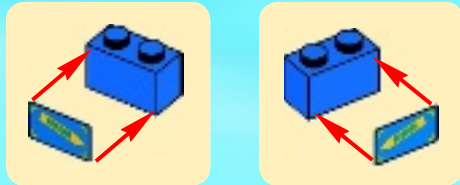





1x



1x

# 40

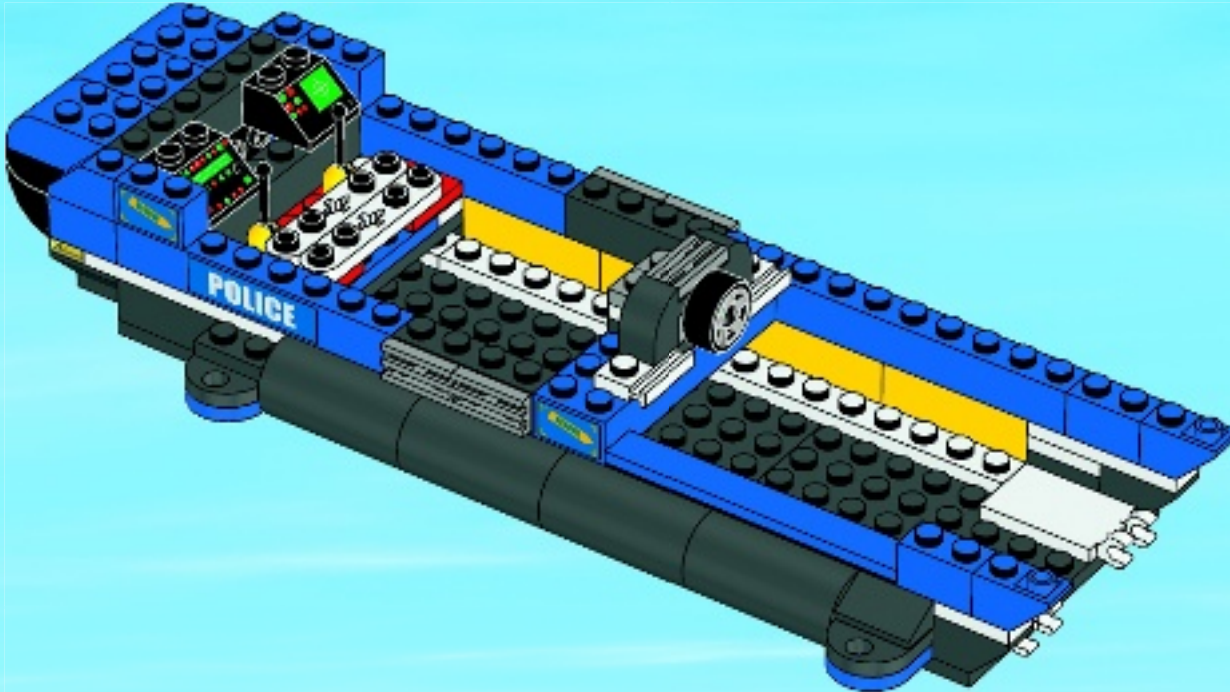



1x

41

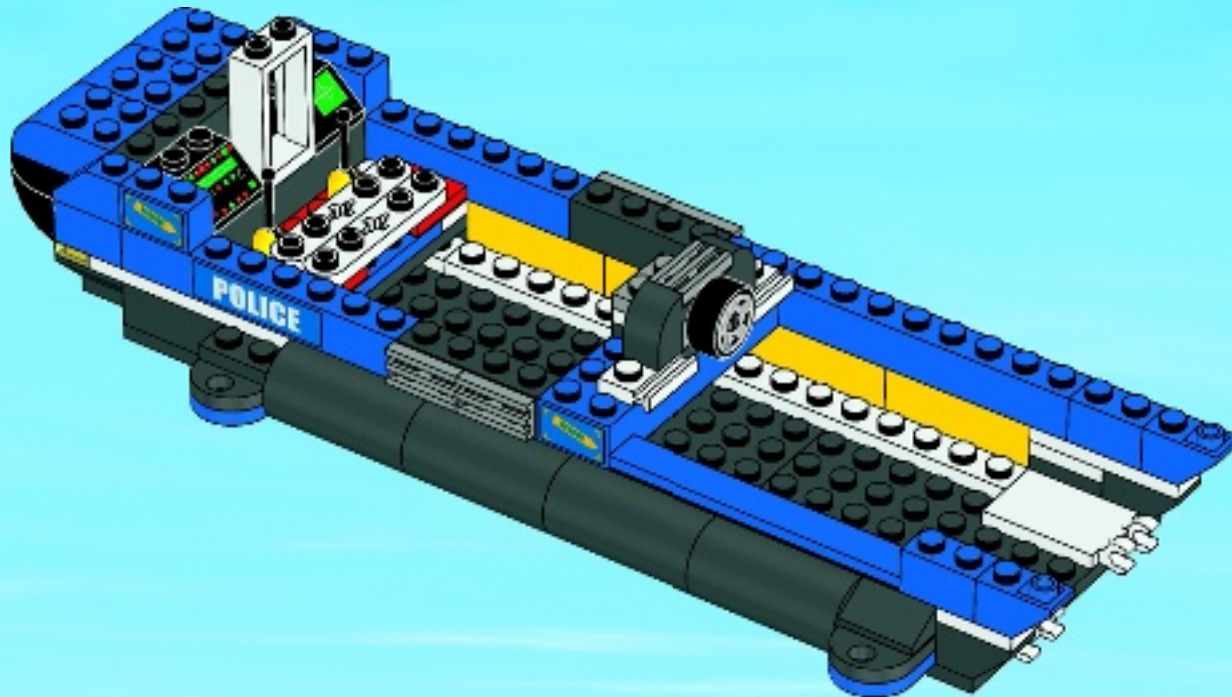



2x

# 42

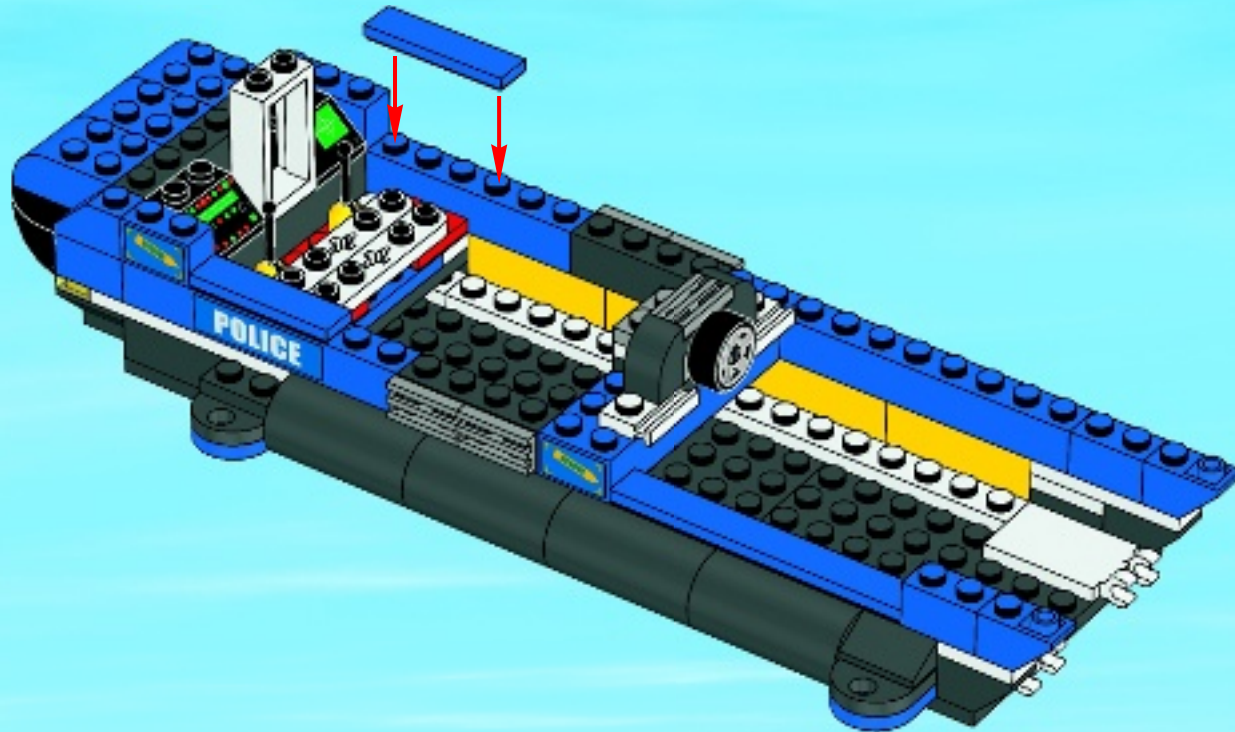



2x



1x

# 43

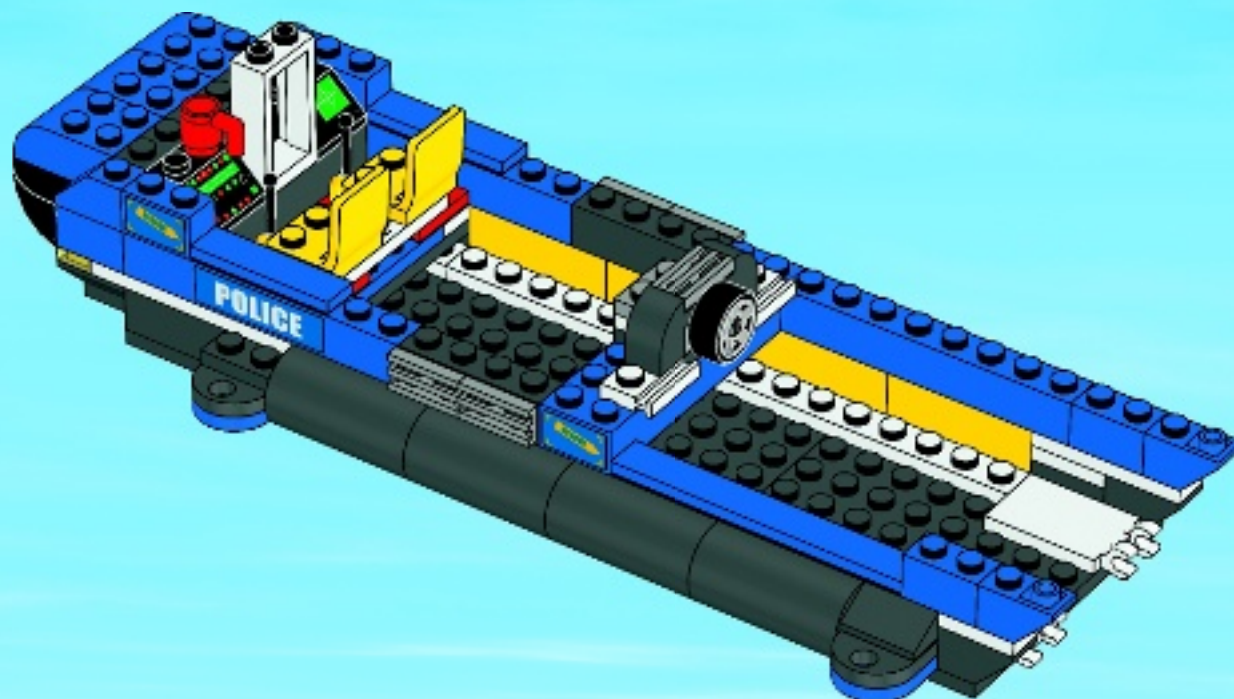



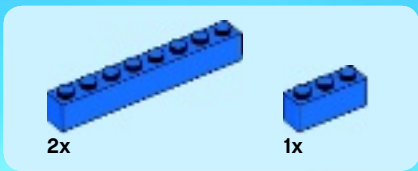

44

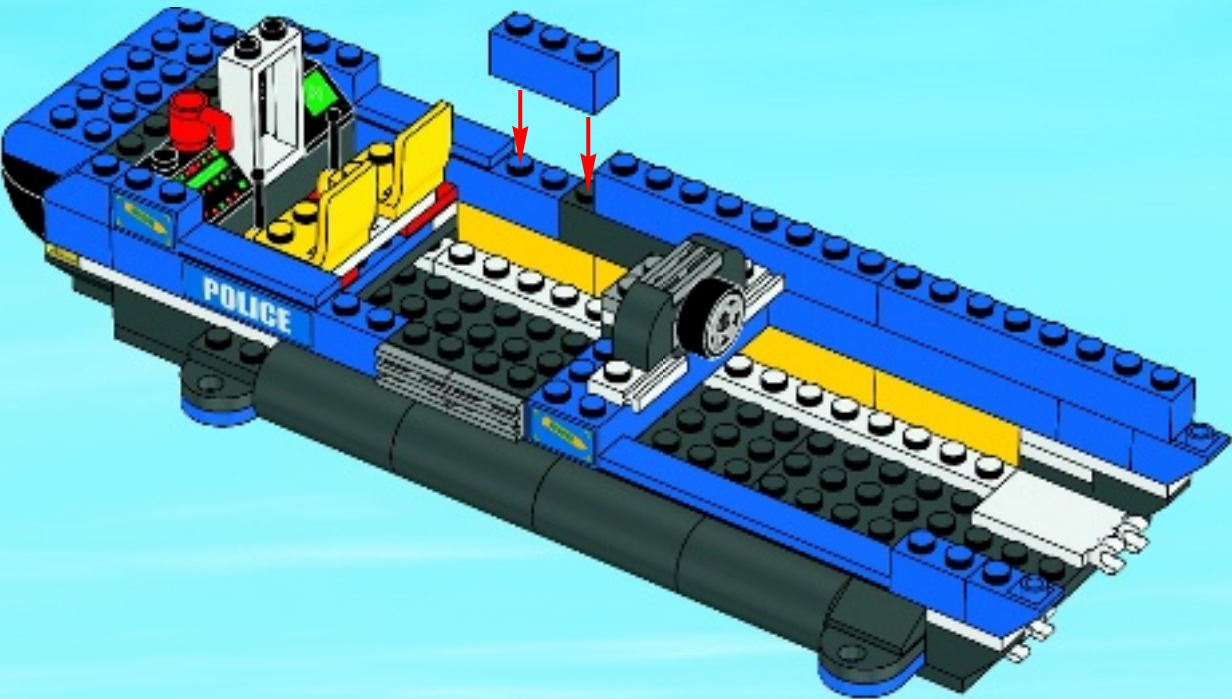

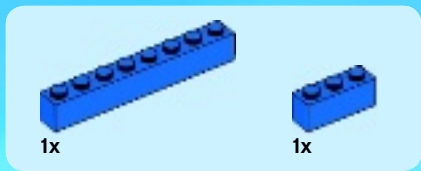

45

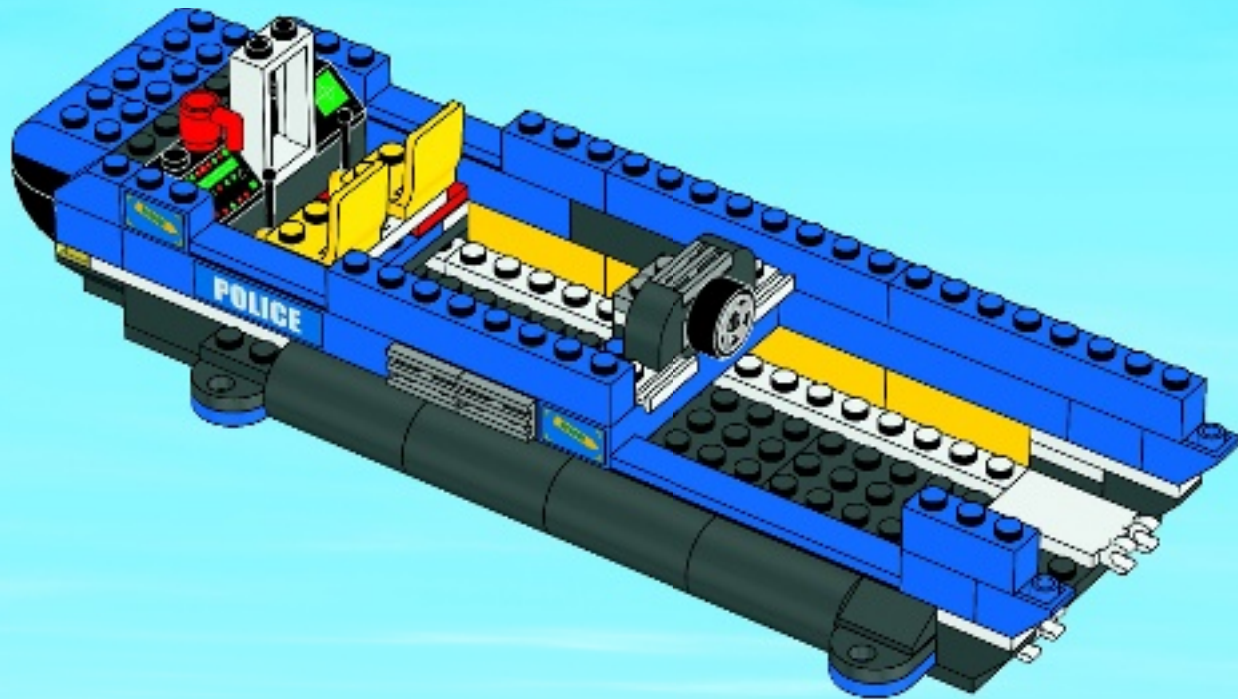



2x



2x

# 46

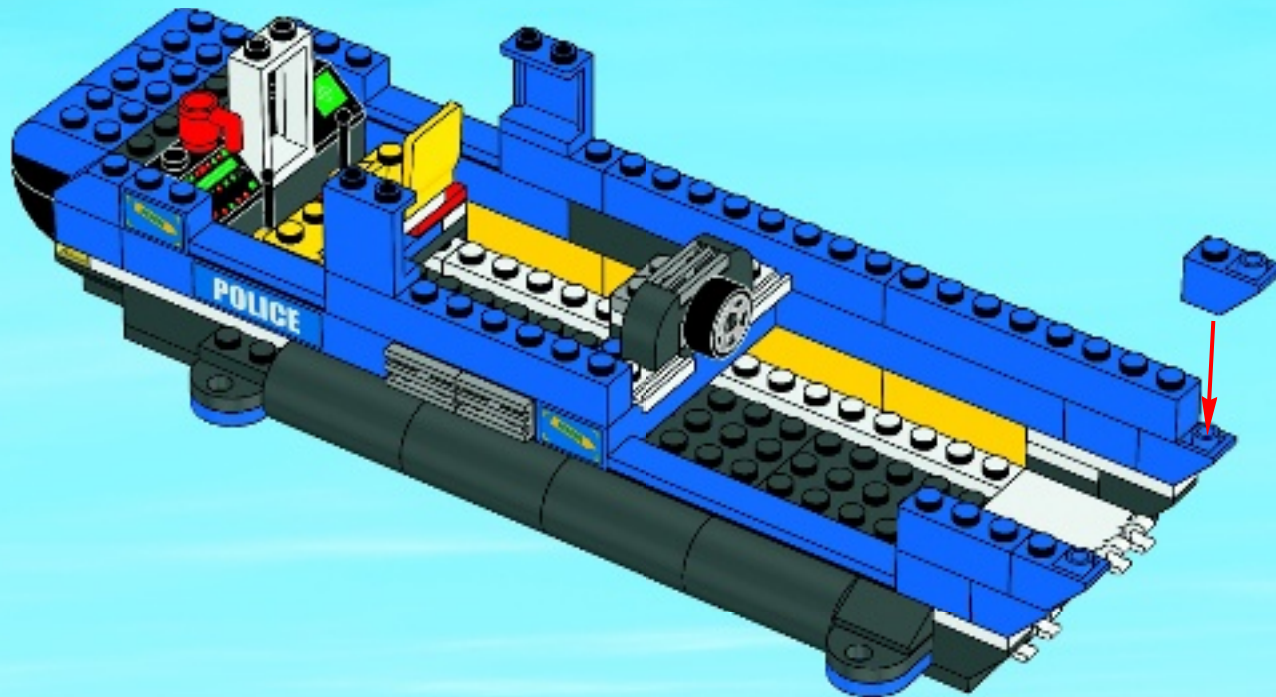



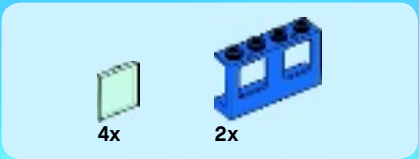

47

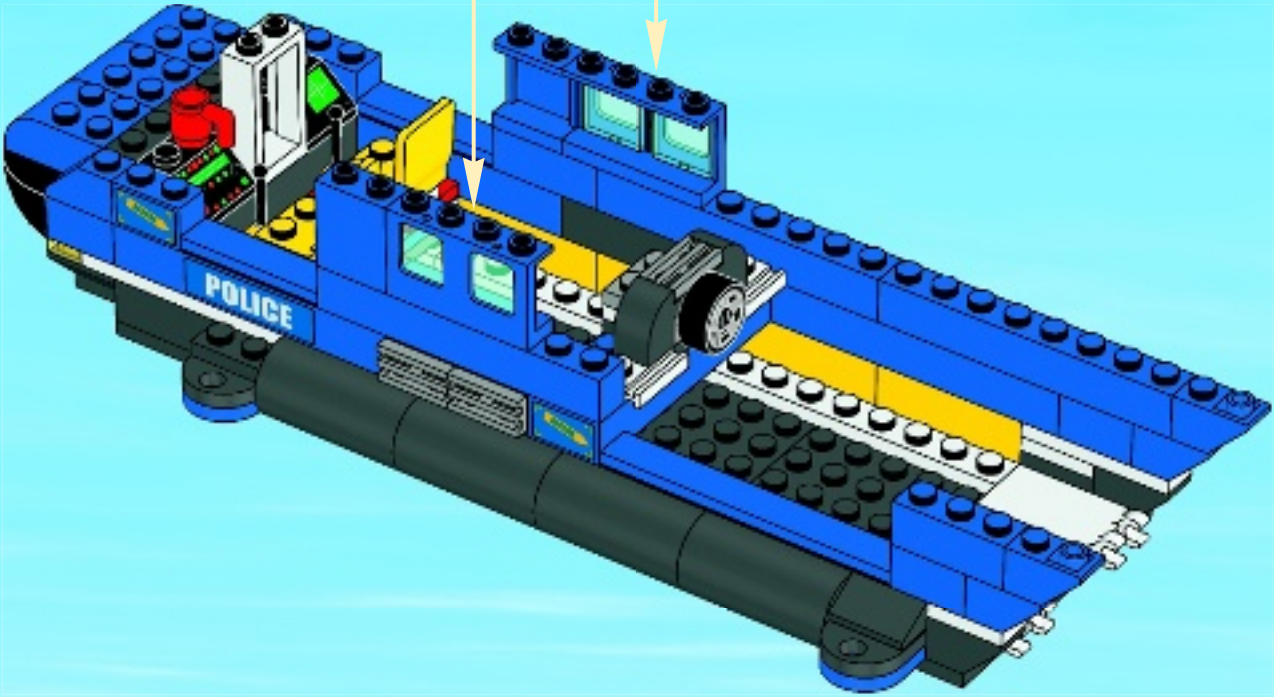
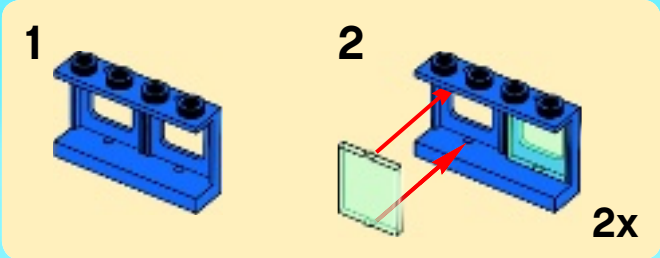





3x

# 48

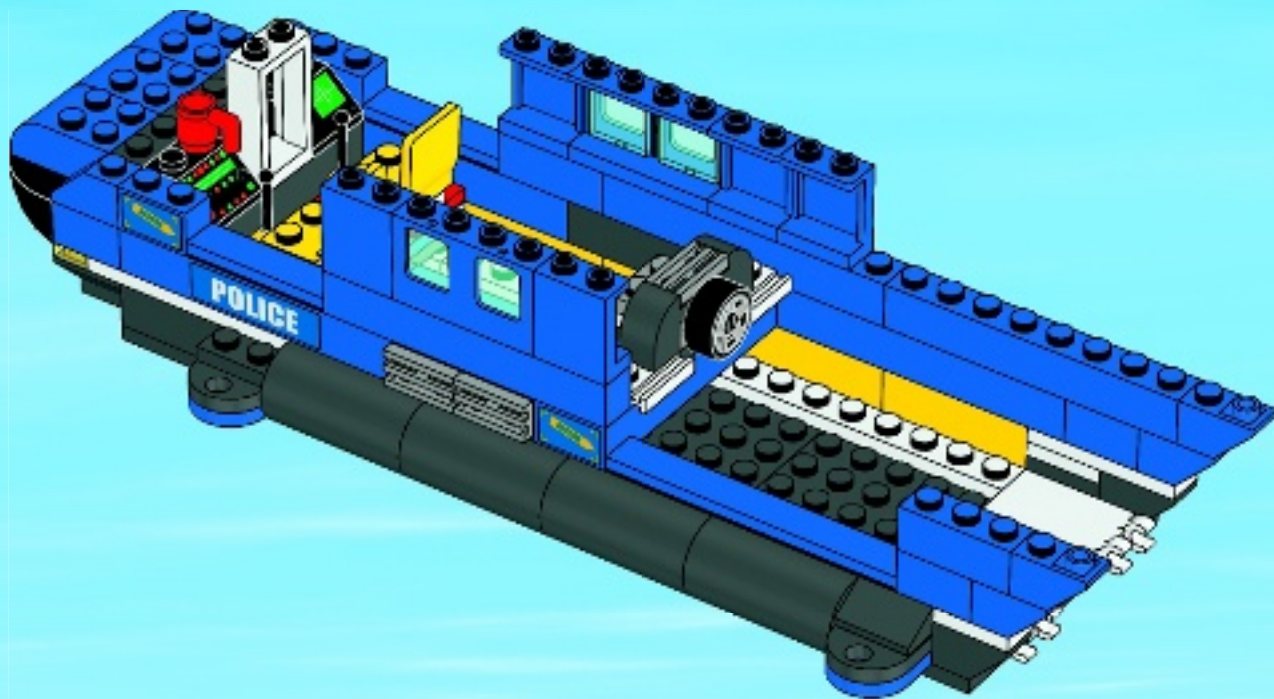

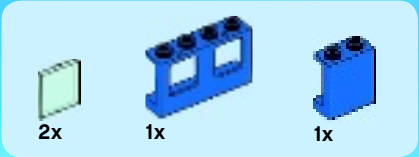

# 49

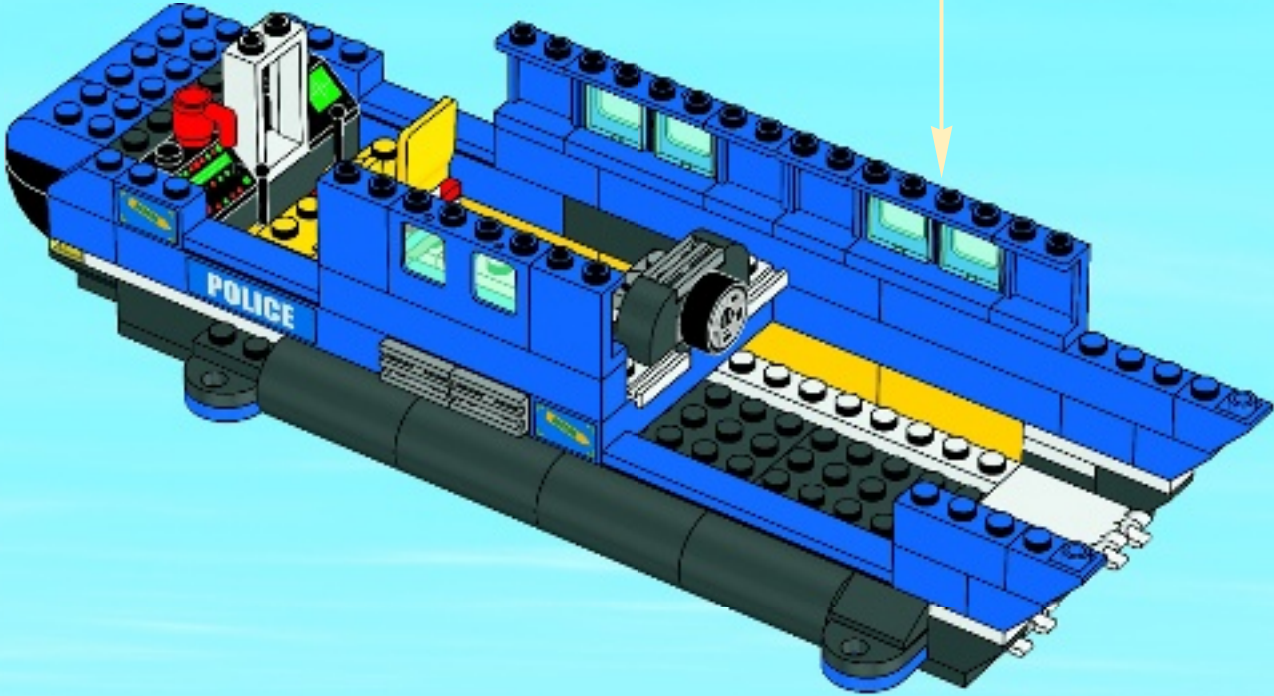
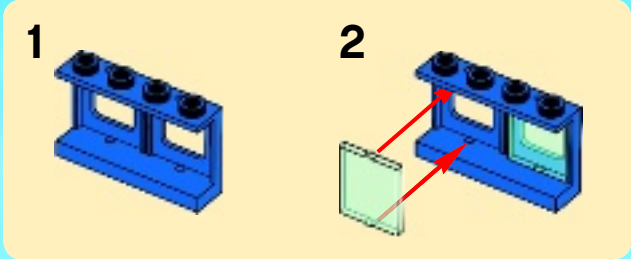

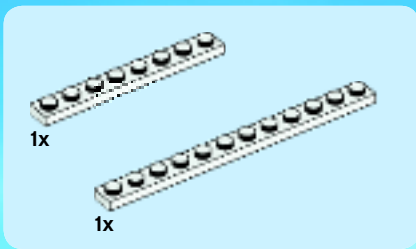

50

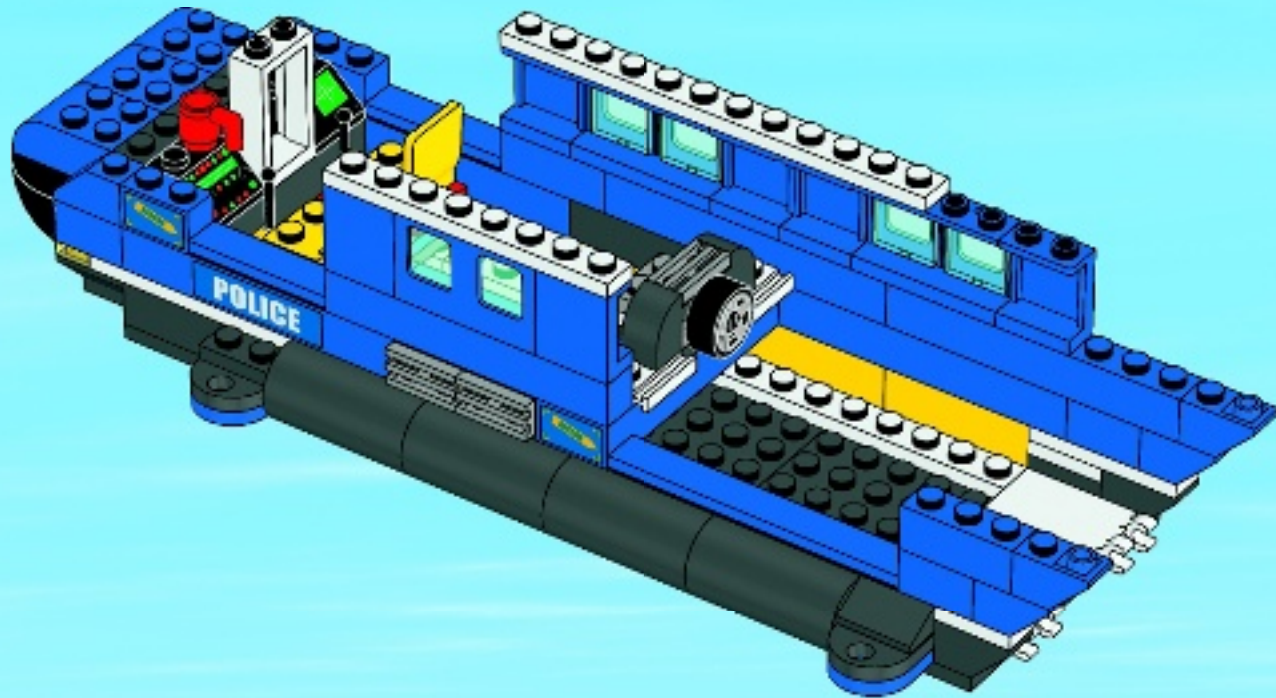





2x

# 51

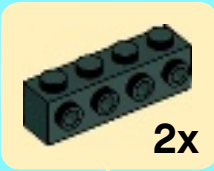
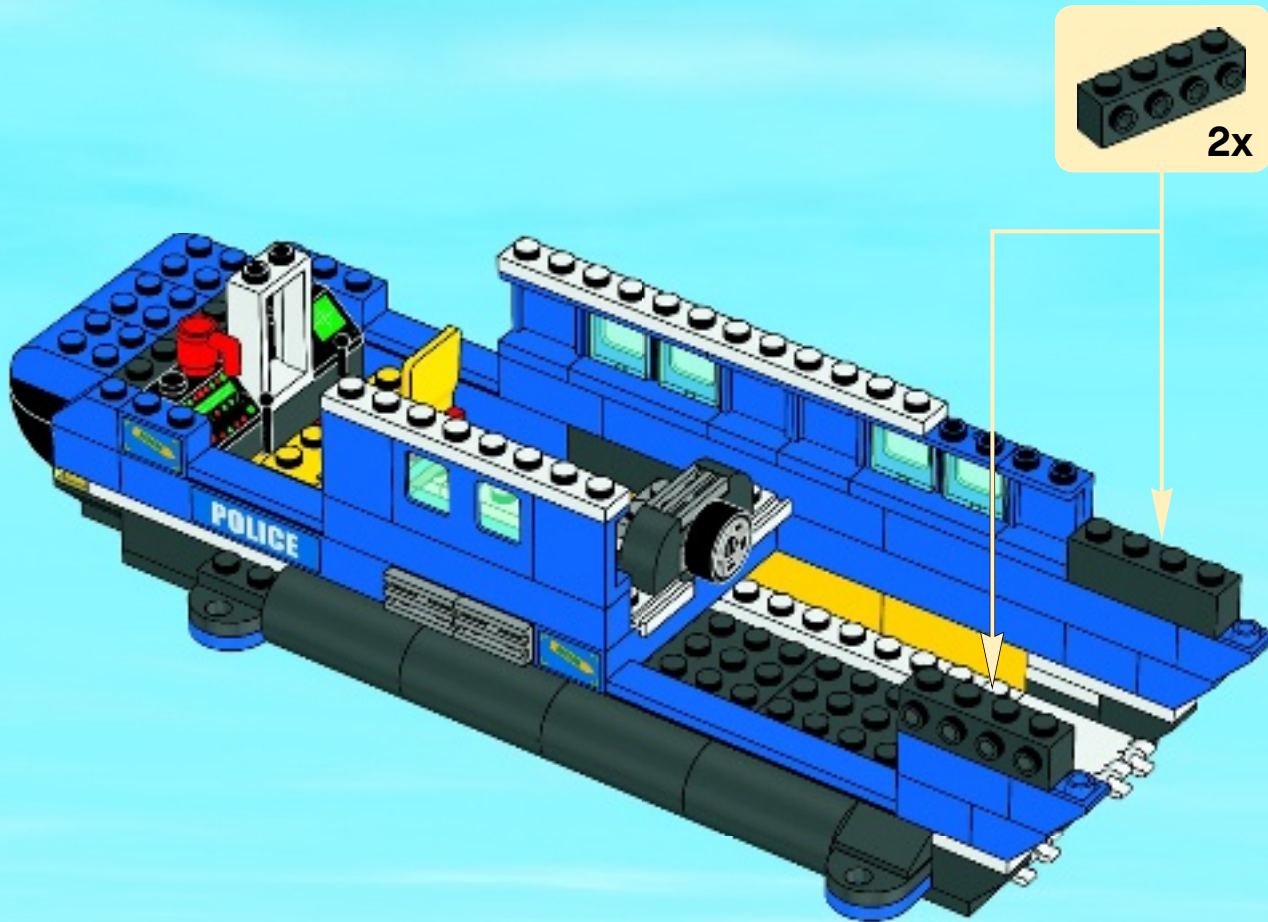





2x

# 52

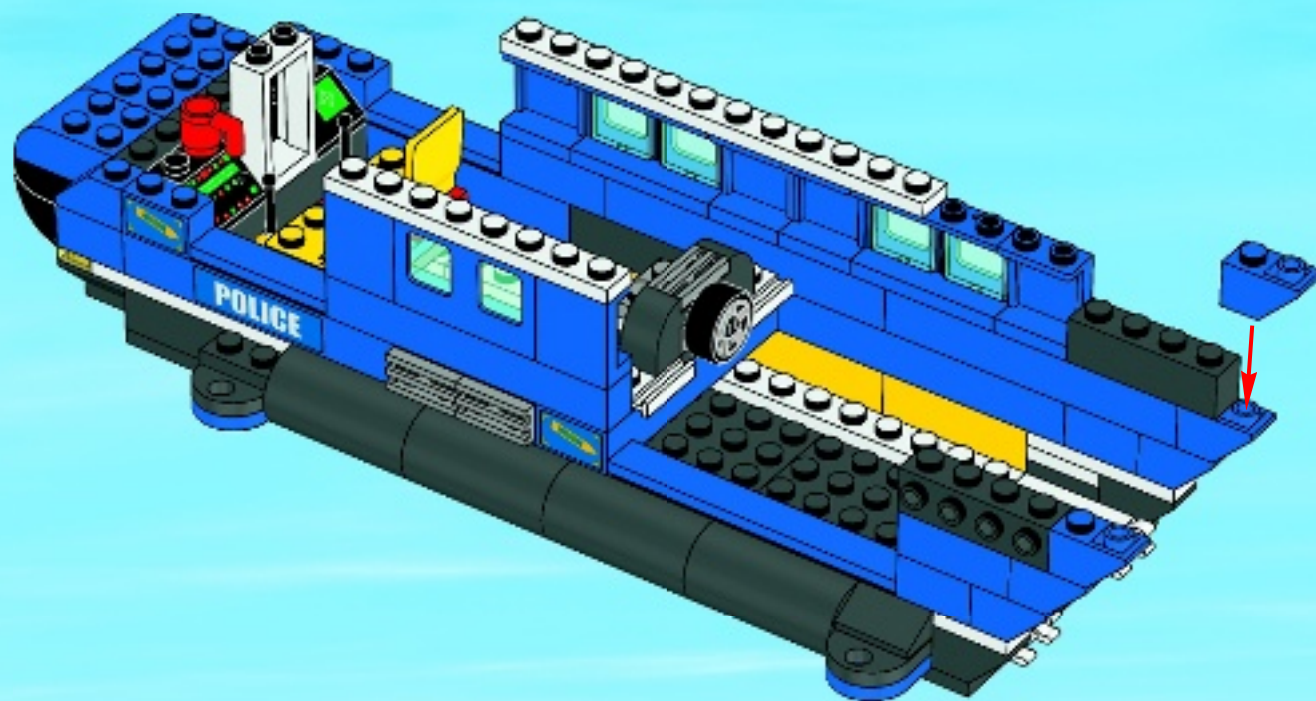

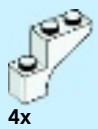

4x

# 53



4x

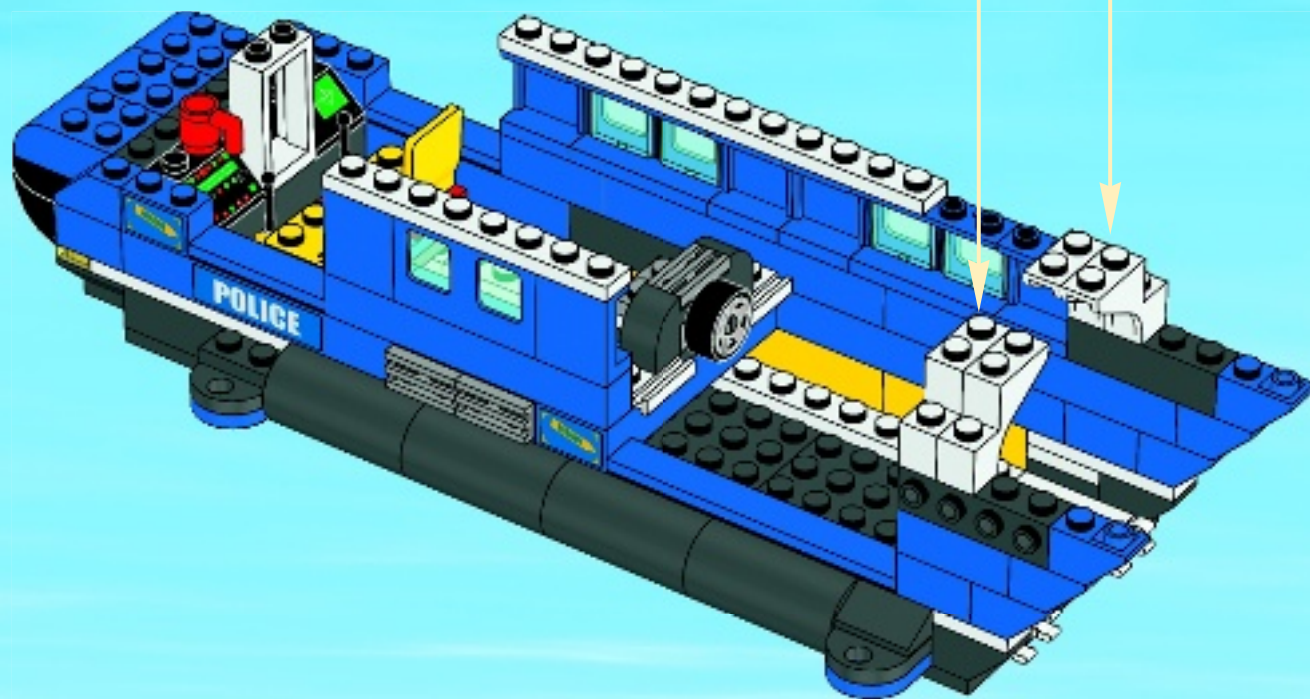



2x

# 54

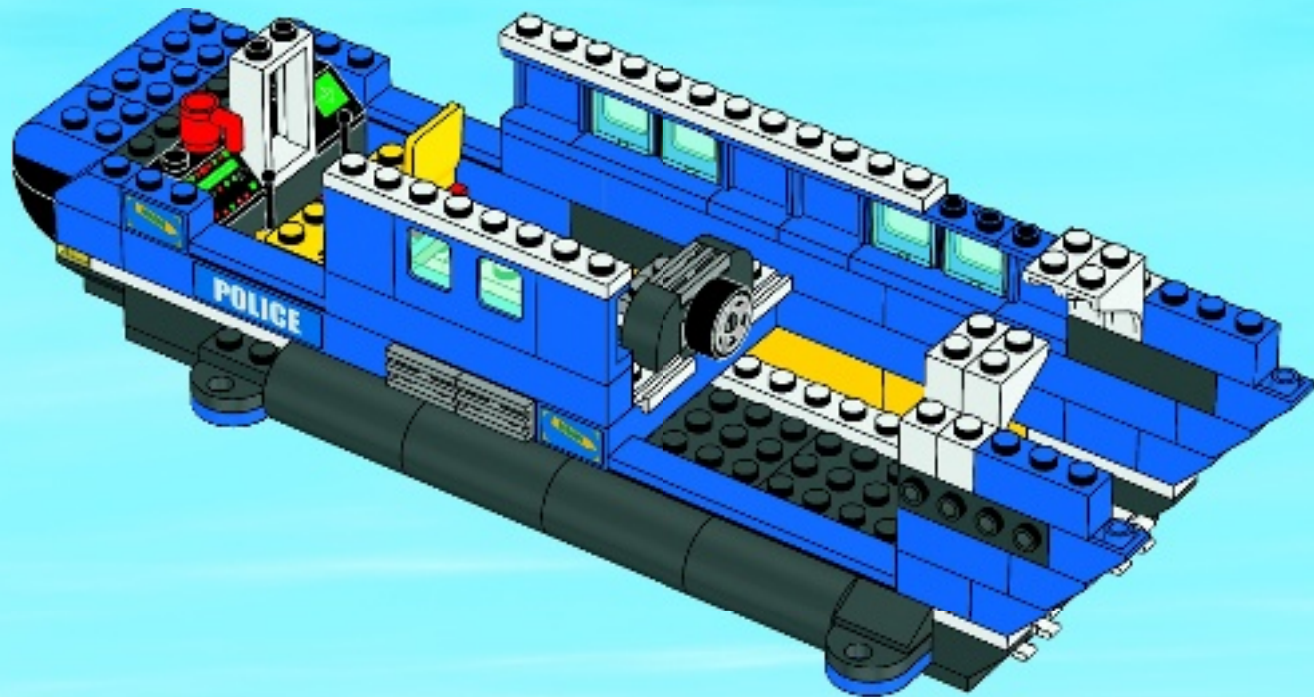





2x

# 55

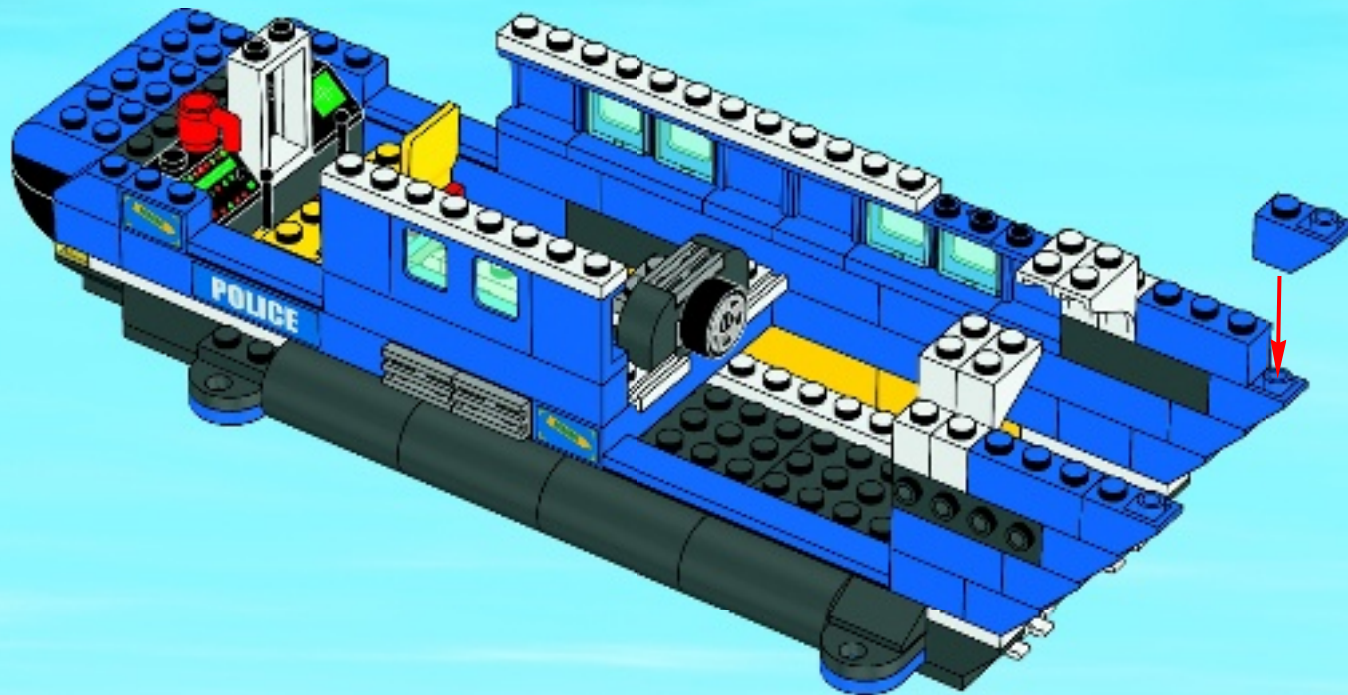



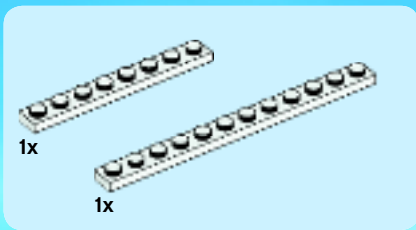

56

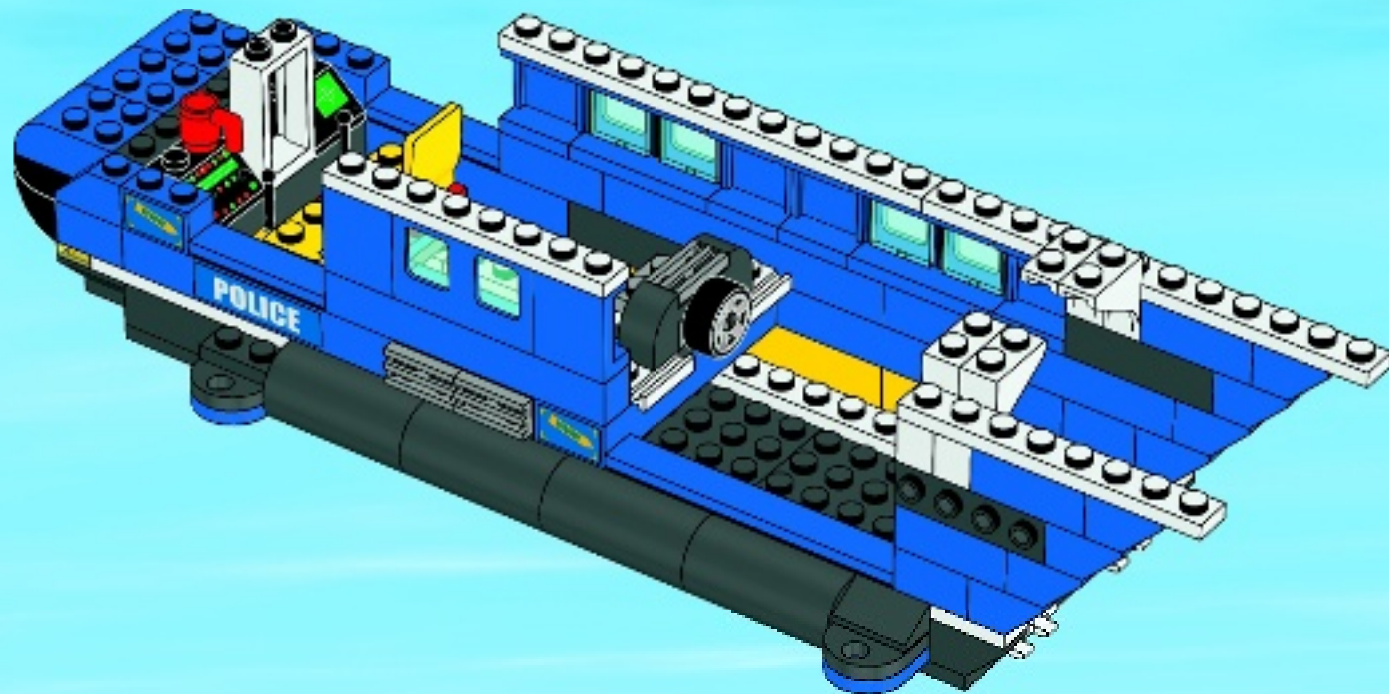

2x



1x



57

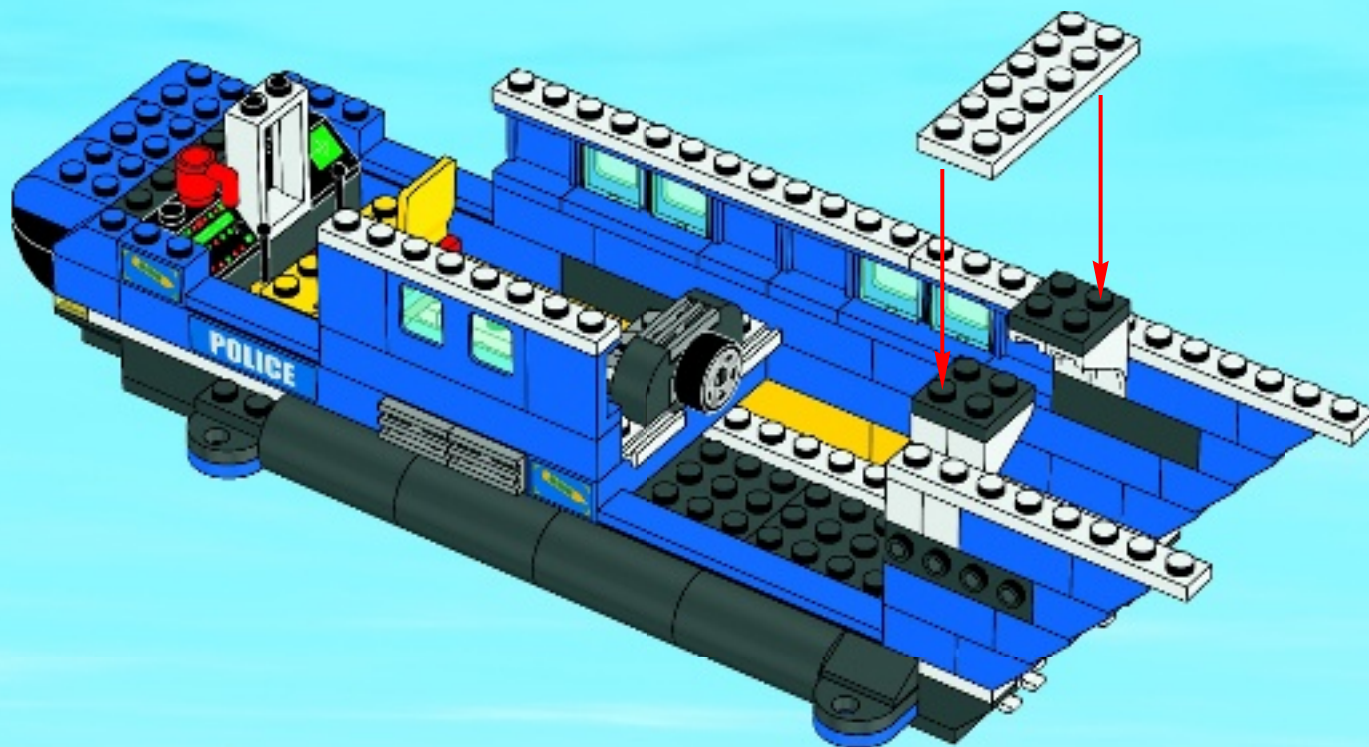



1x

# 58

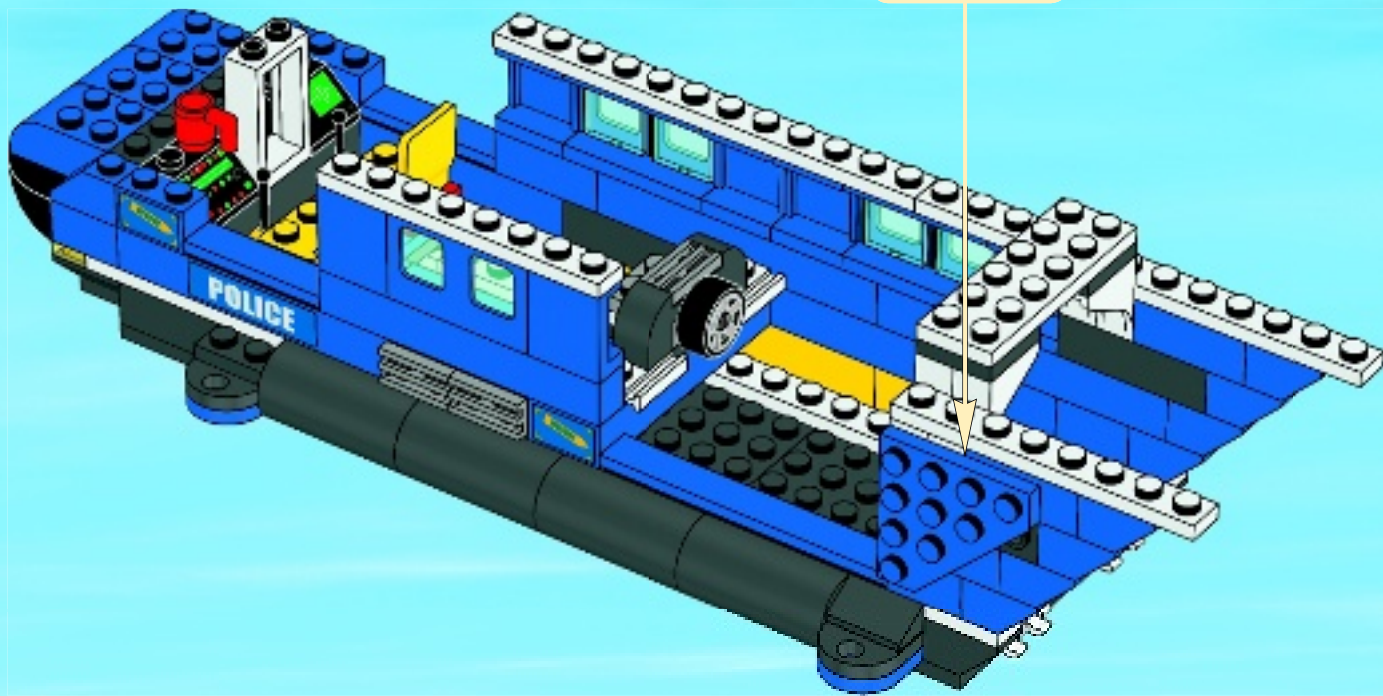
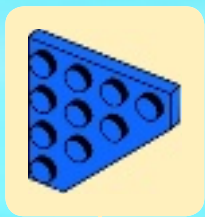





1x

# 59

