



Harry Potter™

4163045



4702

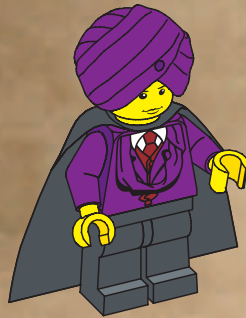
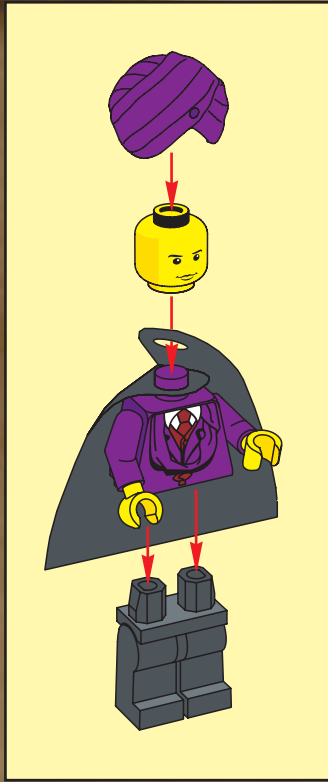

1

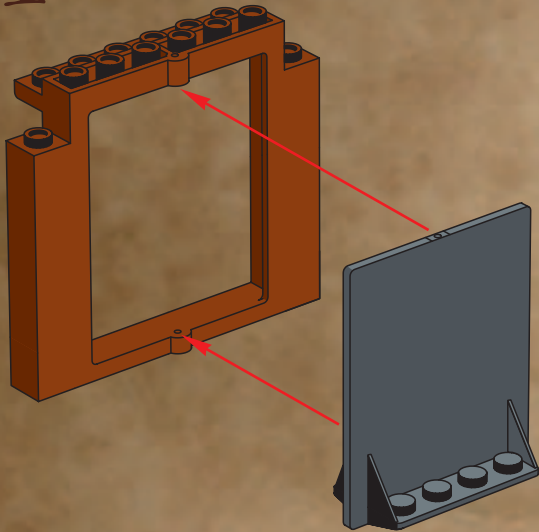

2

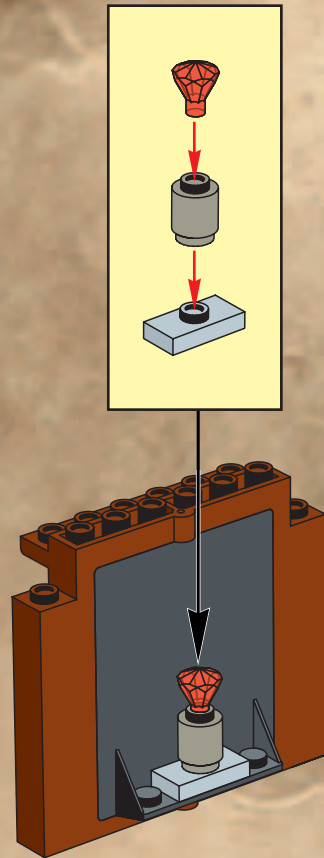

3

3

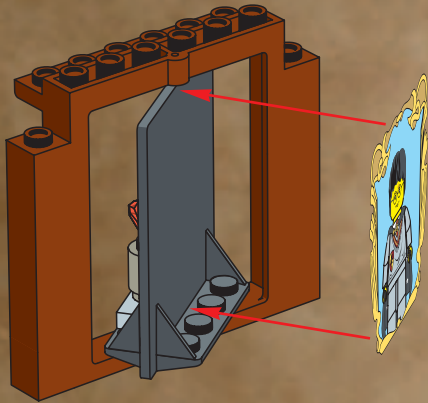

4

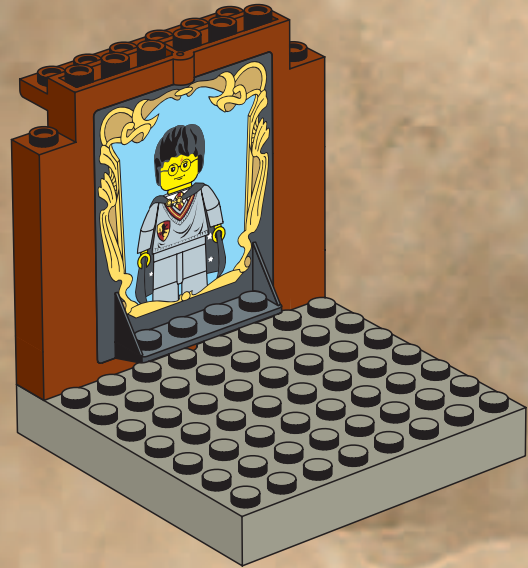

5

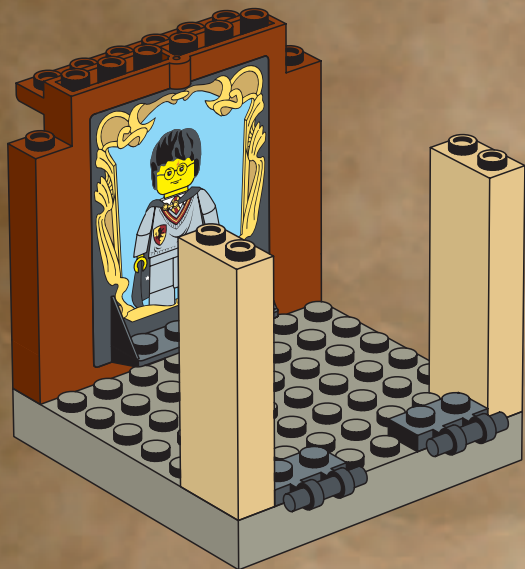

6

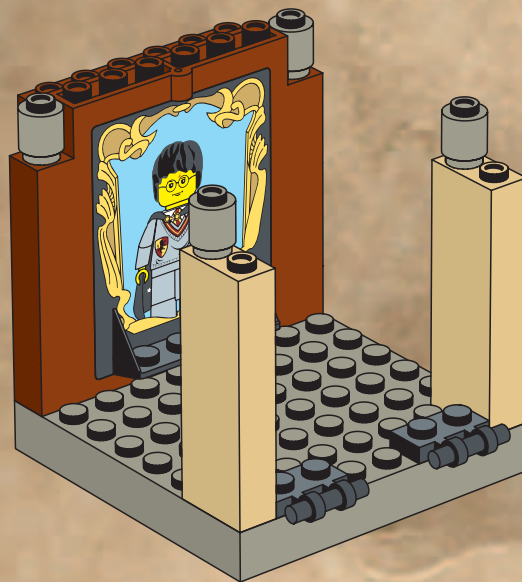

7

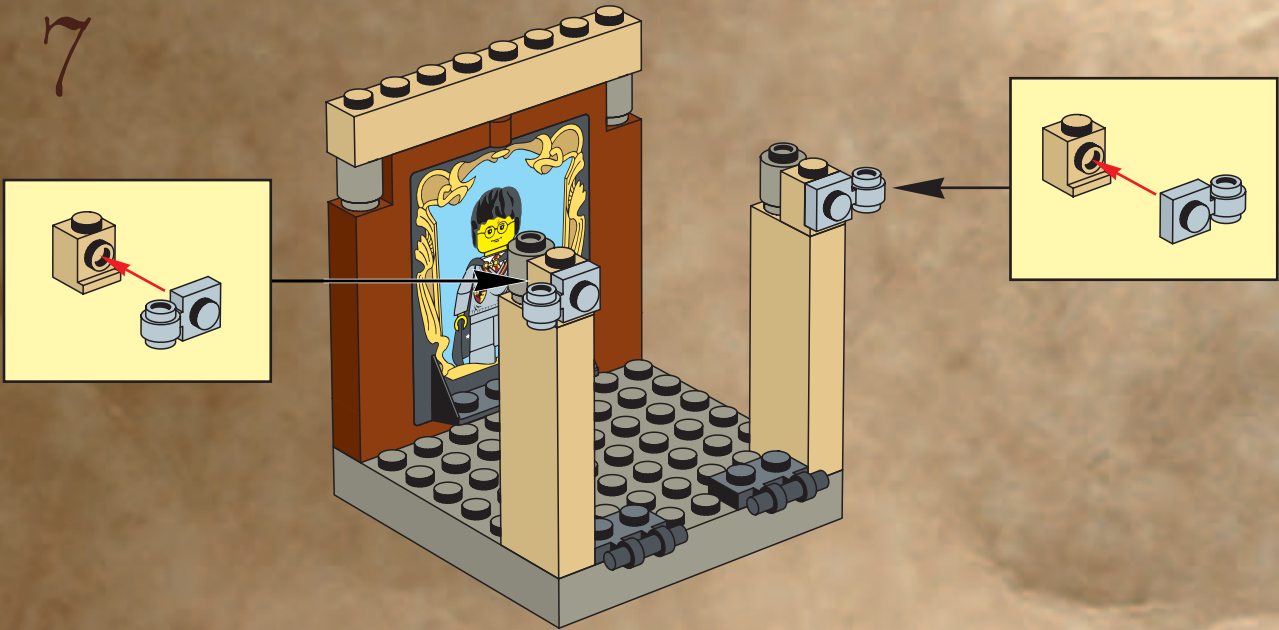

8

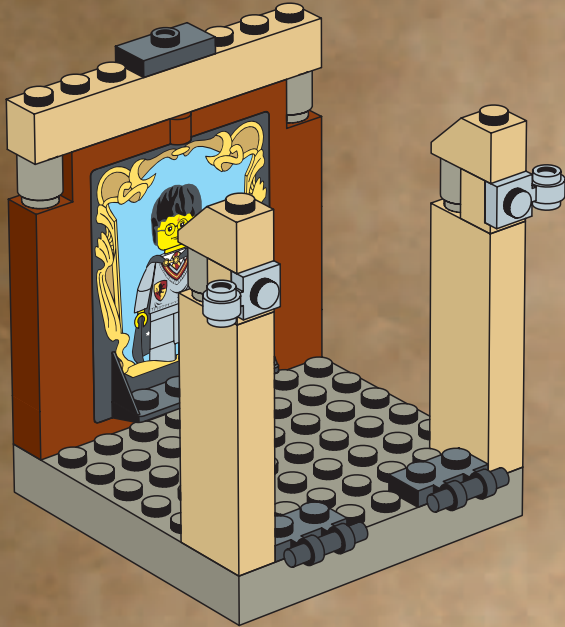

9

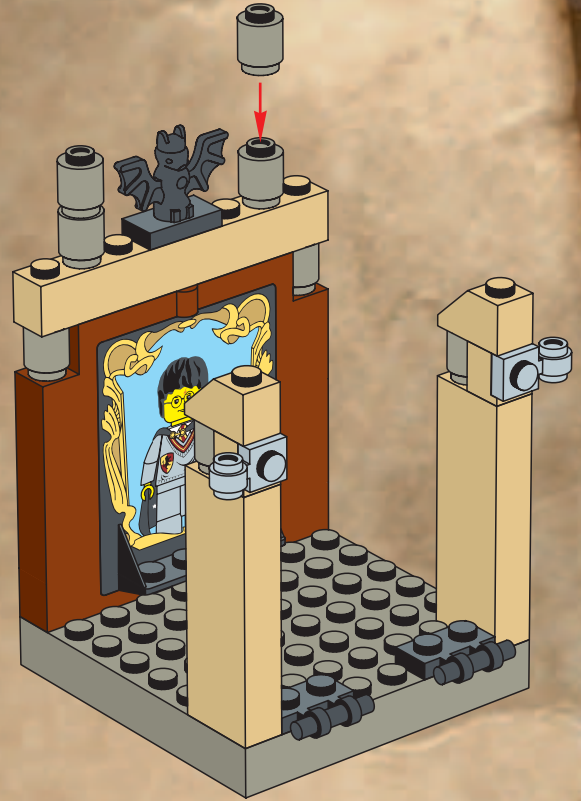

10

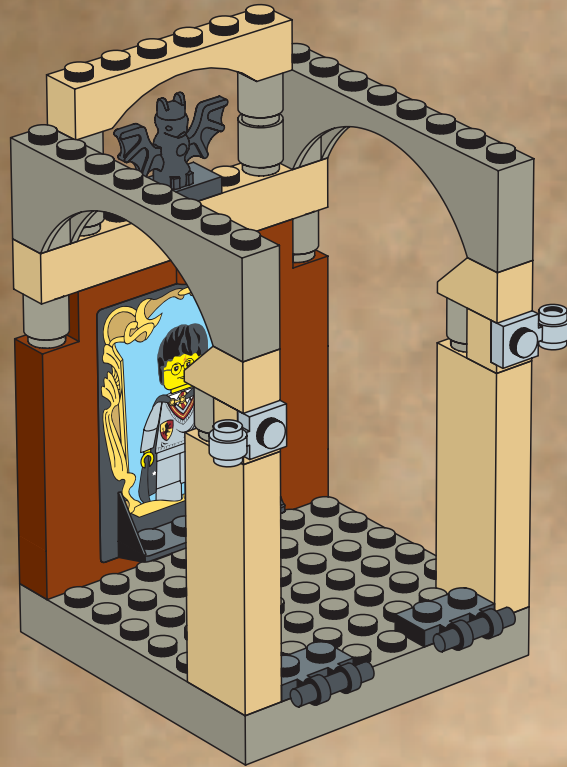

11

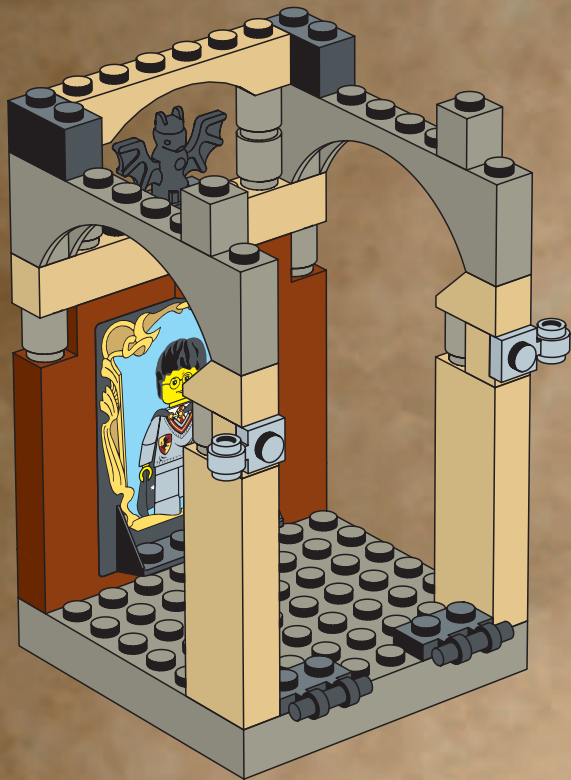

12

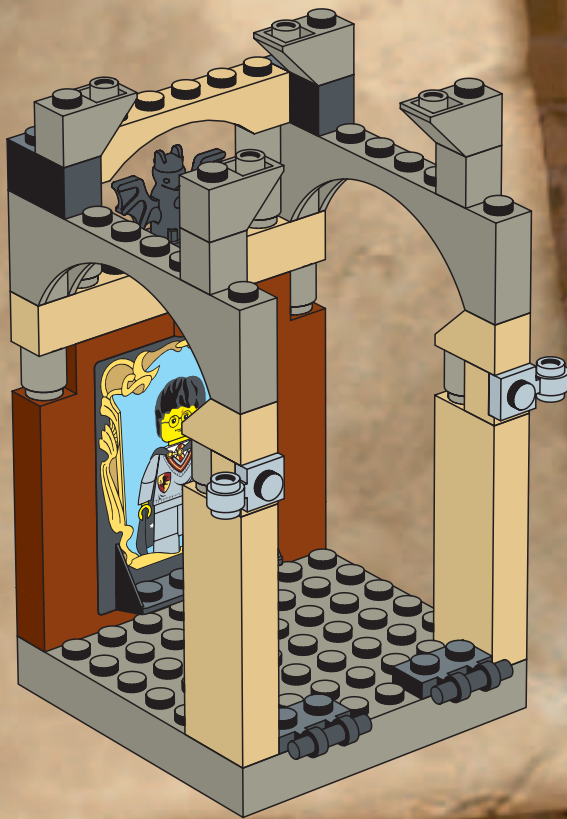

13

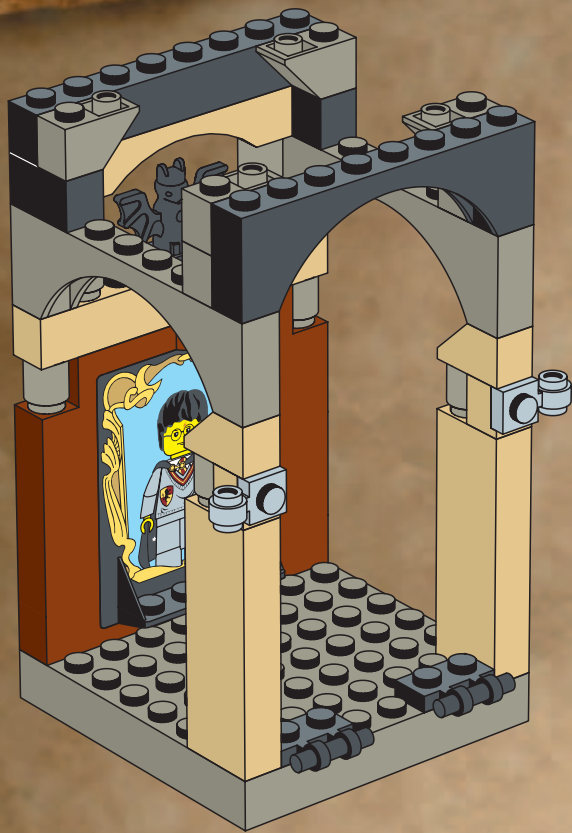

14

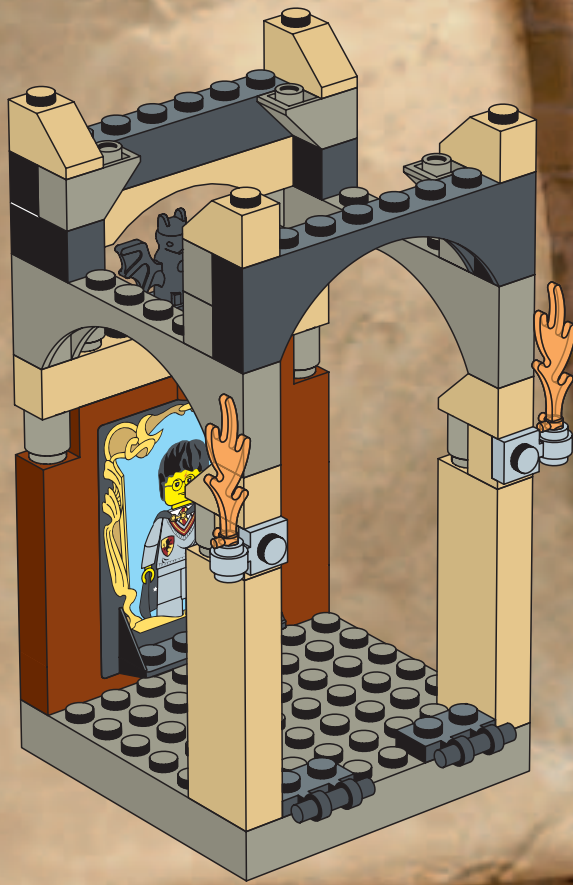

15

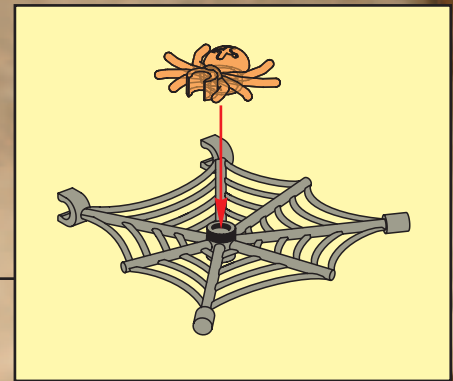
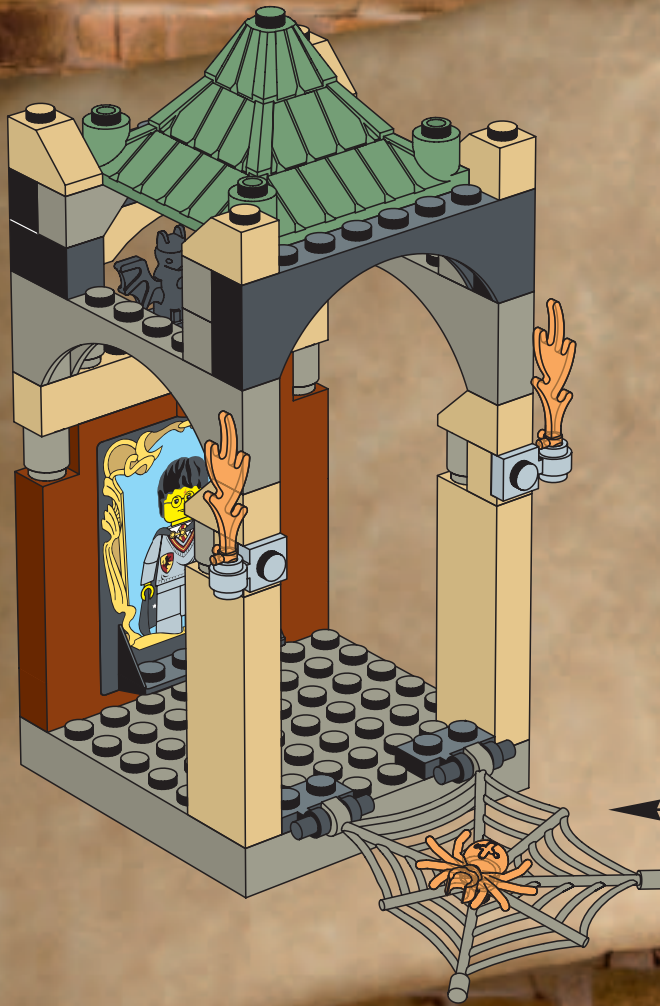

16

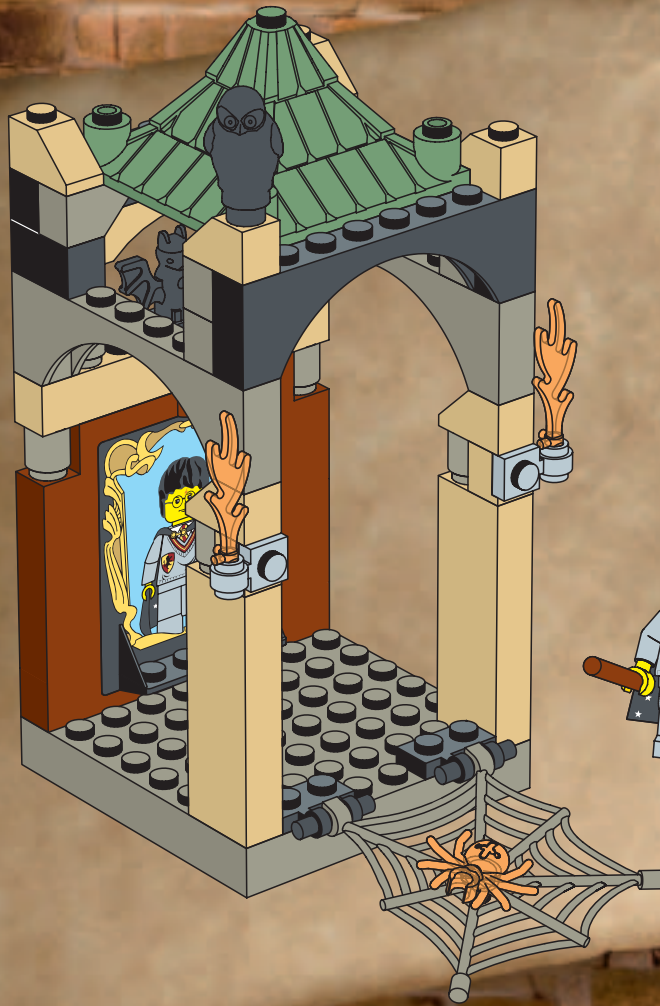









LEGO SOFTWARE



www.harrypotter.com



 HARRY POTTER, characters, names and related indicia are trademarks of Warner Bros. © 2001.
HARRY POTTER, characters, names and related indicia are trademarks of and © Warner Bros.
(s01)
 WB SHIELD: TM & © 2001 Warner Bros.
© 2001 The LEGO Group.