

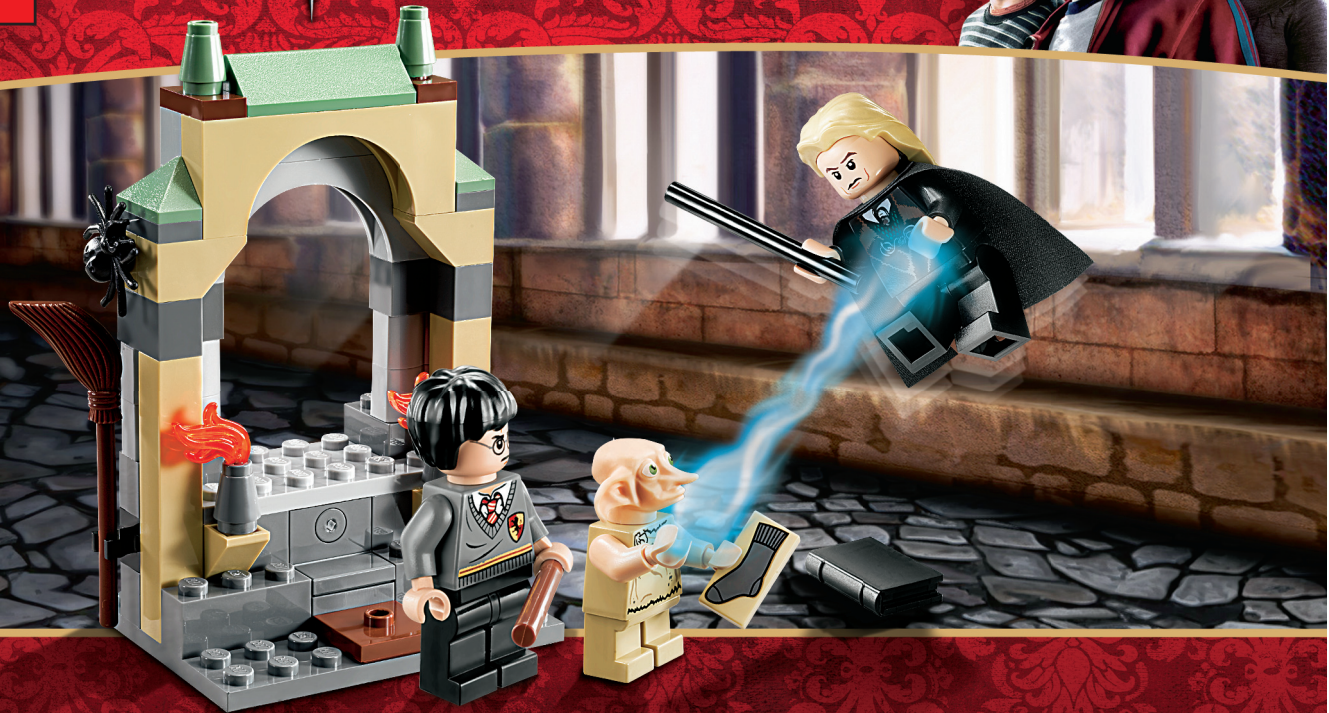

# Harry Potter



4736





# Harry Potter

YEARS 1-4

[WWW.MAGICISBUILDING.COM](http://WWW.MAGICISBUILDING.COM)



Wii

NINTENDO DS



PlayStation



Games for Windows



XBOX 360

RATING PENDING

**RP**

CONTENT RATED BY ESRB

Visit [www.esrb.org](http://www.esrb.org) for rating information

LEGO HARRY POTTER: YEARS 1-4 software © 2010 TT Games Publishing Ltd. Produced by TT Games under license from the LEGO Group. LEGO, the LEGO logo, the Brick and the Knob configurations and the Minifigure are trademarks of the LEGO Group. © 2010 The LEGO Group. "PlayStation" and the "PS" Family logo are registered trademarks of Sony Computer Entertainment Inc. Wii and Nintendo DS are trademarks of Nintendo. © 2008 Nintendo, Microsoft, Xbox, Xbox 360, Xbox LIVE, and the Xbox logos are trademarks of the Microsoft group of companies and are used under license from Microsoft. Windows and the Windows Vista Start button are trademarks of the Microsoft group of companies; and "Games for Windows" and the Windows Vista Start button logo are used under license from Microsoft. All other trademarks and copyrights are the property of their respective owners. All rights reserved.

HARRY POTTER characters, names and related indicia are trademarks of and © Warner Bros. Entertainment Inc. Harry Potter Publishing Rights © JKR, WBIE LOGO, WB SHIELD.™ & © Warner Bros. Entertainment Inc. (s10)



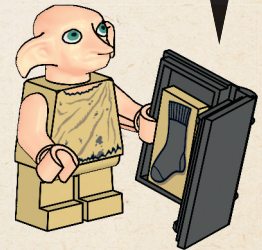
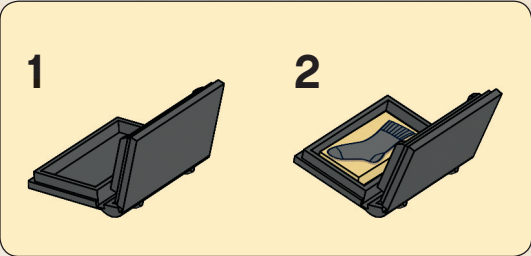
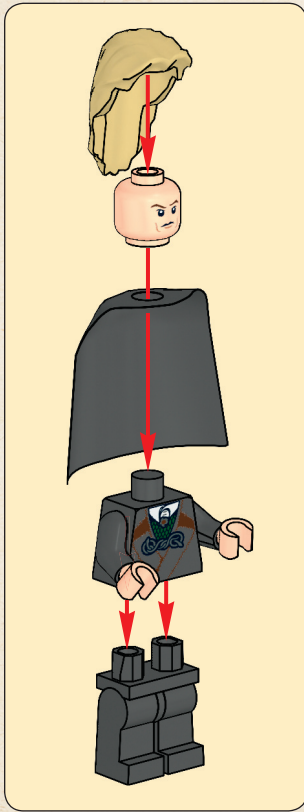

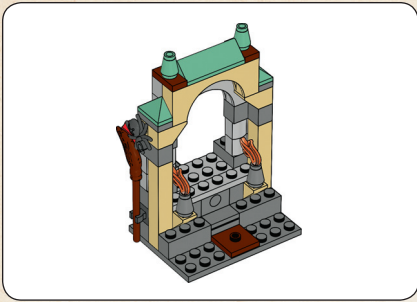

1

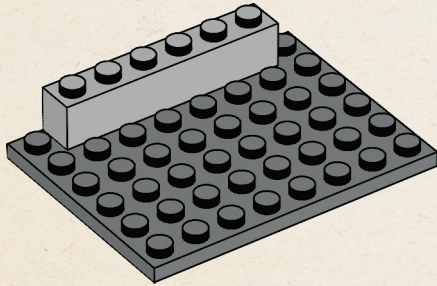

2

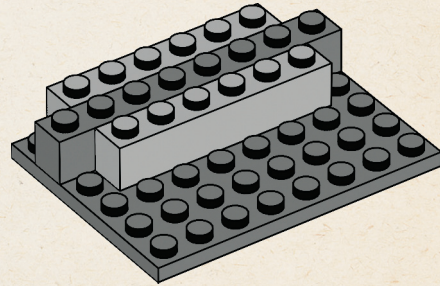

4





7

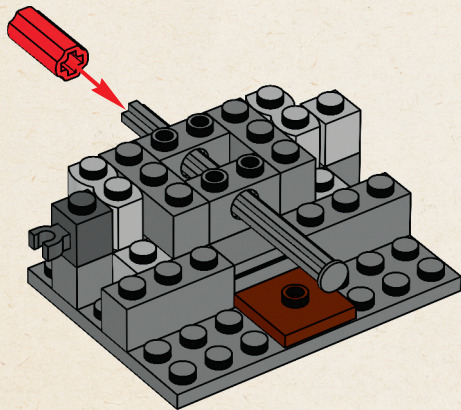

8

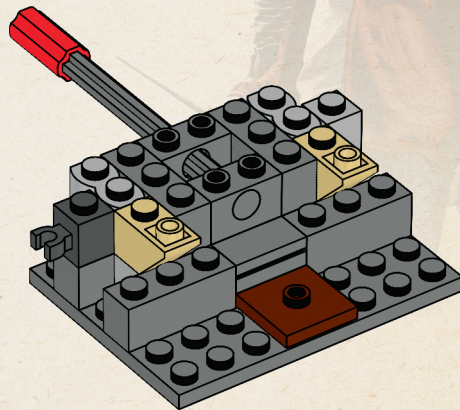

7

9

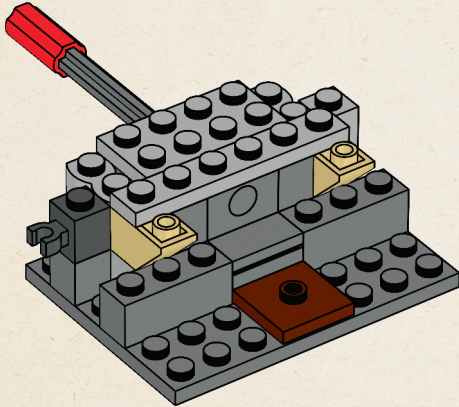

10

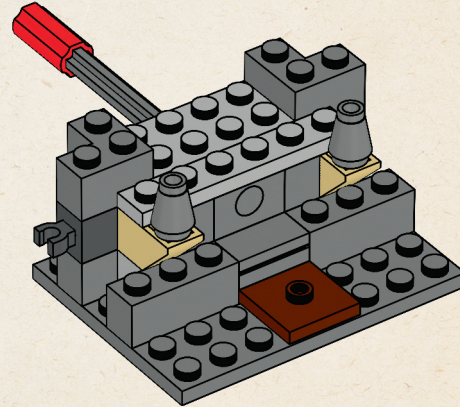



11

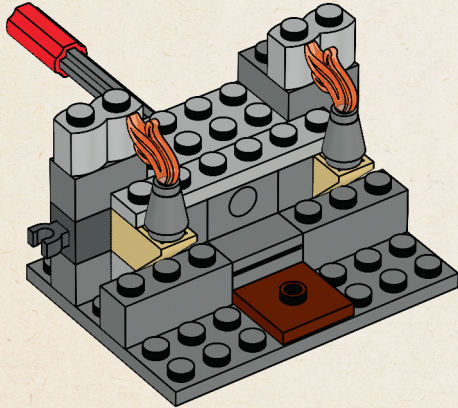

12

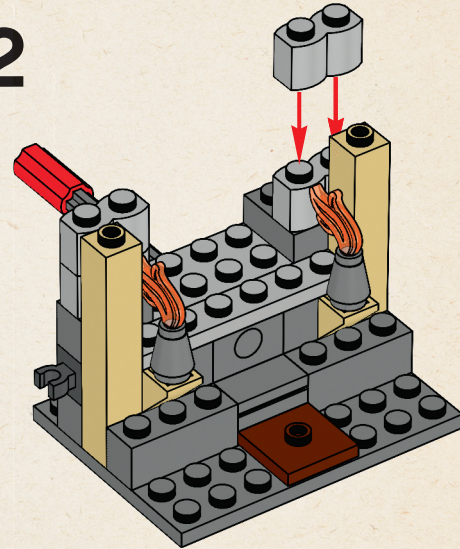

13

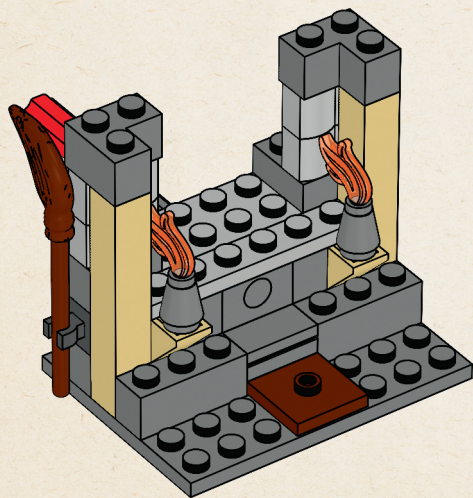

10

14

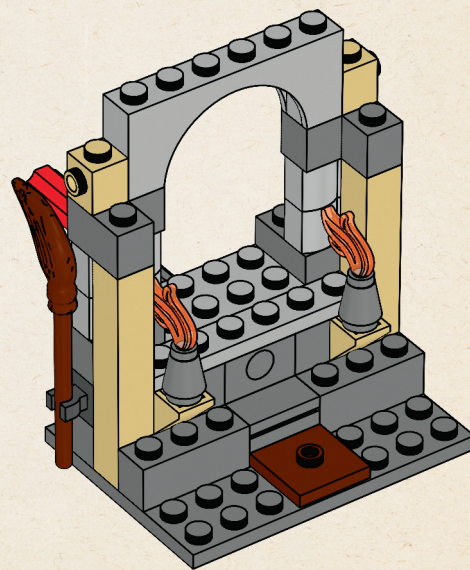

15

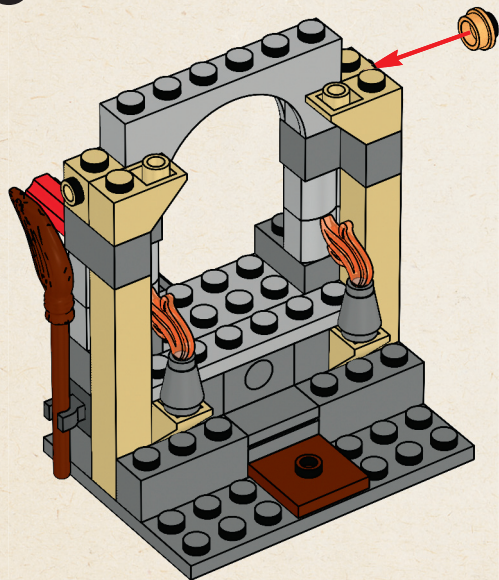

16

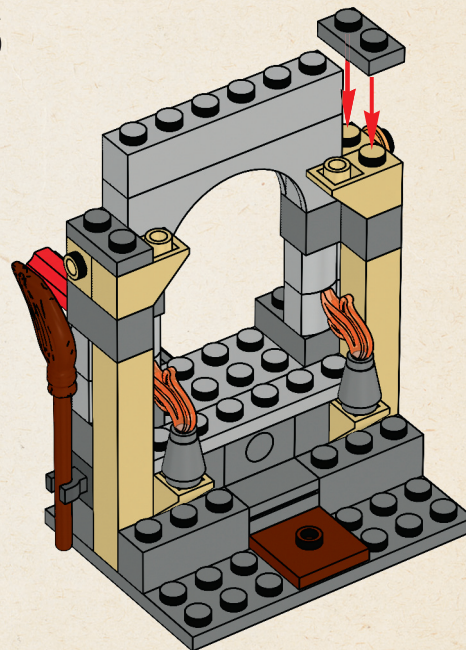

17

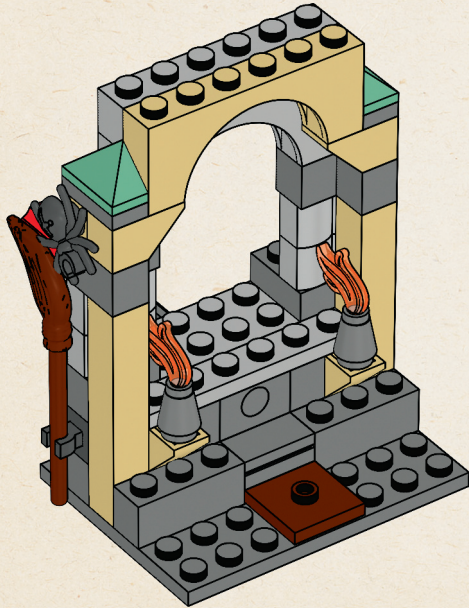

12

18

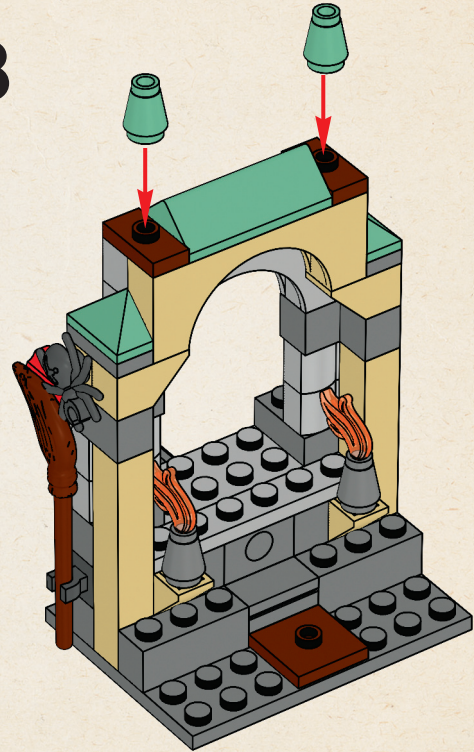

19

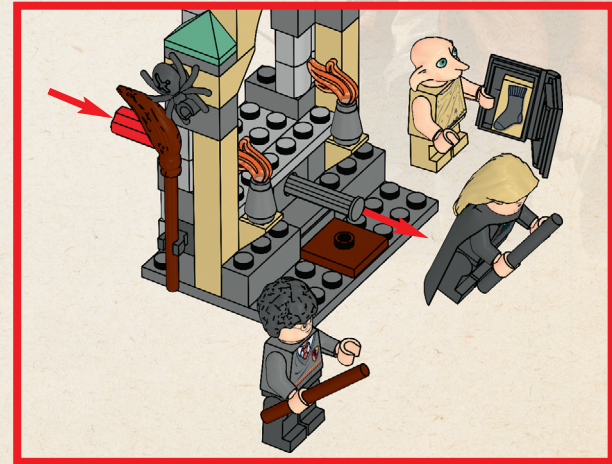
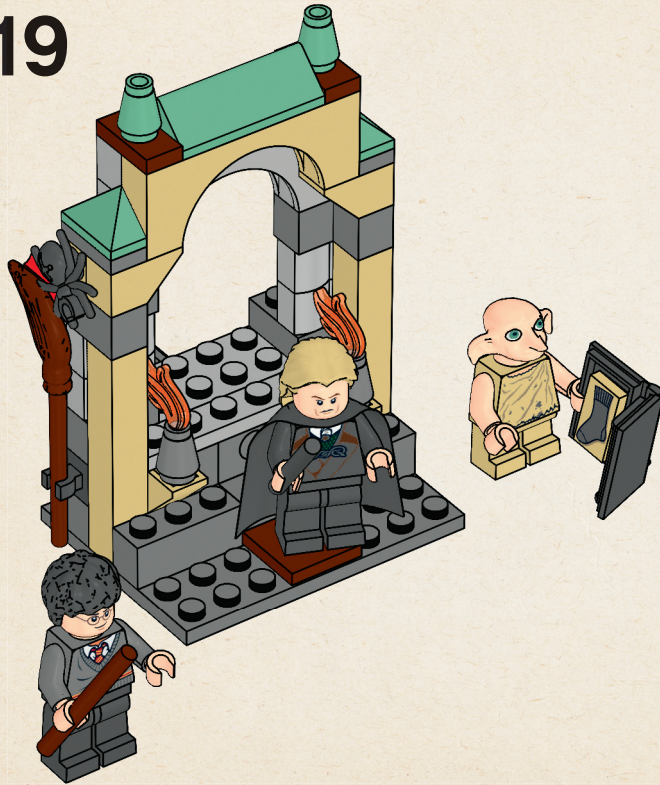



2x  
4579260



4x  
4159196



1x  
4507055



1x  
4596327



1x  
4596173



1x  
4596324

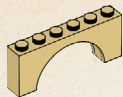

1x  
4114073



2x  
4112980



1x  
4597643



2x  
4597660



2x  
4520959



1x  
4513174



1x  
4523159



2x  
4540865



1x  
4596284



1x  
4596302



1x  
4596307



1x  
4596315



1x  
4596318



1x  
4533771



1x  
4140303



2x  
9339



1x  
4157659



1x  
4113209



1x  
4597644



2x  
4219726



1x  
4565394



1x  
4262974



1x  
4597642



1x  
4124171



1x  
4211389



6x  
4550325



3x  
4211393



1x  
4221600



1x  
4211395

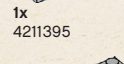

1x  
4211438

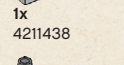

2x  
4529240



2x  
4211111



1x  
4211052



4x  
4211063



4x  
4211109



4x  
4211104



1x  
4499858



1x  
4211099



1x  
4210794

Customer Service

Kundenservice

Service Consommateurs

Servicio Al Consumidor

[www.lego.com/service](http://www.lego.com/service) or dial



00800 5346 5555 :



1-800-422-5346 :



**FREE! GRATIS! GRATUIT!**



**club**  
MAGAZINE™

**www.LEGOclub.com**



**00800 5346 5555\***        

  **1-866-534-6258 • 1-877-518-5346**

US & Canada only

Canada seulement

\* Freephone. Mobile charges may apply. \* Numéro sans Frais. Des Frais peuvent s'appliquer avec les téléphones cellulaires. \* Gebührenfrei, Kosten für Anrufe aus Mobilfunknetzen können abweichen. \* Gratis telefonnummer vanaf vaste lijn. \* Det er ett gratis nummer, når du ringer fra fasttelefon. \* Det är gratis, när du ringer från en fast telefon.



VISIT THE WORLD'S  
BIGGEST LEGO® SHOP!

**www.LEGOshop.com**



# WIN!

Go to [www.nielsen.com/LEGO](http://www.nielsen.com/LEGO)  
to fill out a survey for a chance  
to win a cool LEGO® Product.

No purchase necessary.

Open to all residents where not prohibited.



[www.LEGO.com](http://www.LEGO.com)



## [www.nielsen.com/LEGO](http://www.nielsen.com/LEGO)

### GEWINNE!

Nimm an der Umfrage auf  
[www.nielsen.com/](http://www.nielsen.com/)  
LEGO teil und hab die Chance ein cooles  
LEGO® Produkt zu gewinnen!

Die Teilnahme am Gewinnspiel führt zu keinerlei  
Kaufverpflichtungen. Teilnahme in allen nicht  
ausgeschlossenen Ländern möglich.

### WIN!

Ga naar [www.nielsen.com/LEGO](http://www.nielsen.com/LEGO),  
vul een enquêteformulier in en  
maak kans op een  
cool LEGO® product.

Geen aankoopverplichting.

Iedereen mag deelnemen, uitgezonderd  
ingezetenden

van landen waar een enquêteverbod geldt.

### GAGNE!

Visite [www.nielsen.com/LEGO](http://www.nielsen.com/LEGO)  
pour répondre à un questionnaire  
et avoir une chance de gagner  
un produit LEGO® très cool !

Aucune obligation d'achat.

Ouvert à tous les résidents des pays  
autorisés.

### 当てよう!

[www.nielsen.com/LEGO](http://www.nielsen.com/LEGO)  
にアクセスして、  
アンケートにご記入ください。  
当選者にはレゴ製品を  
差し上げます。

お買い上げの必要はありません。

禁止されていない限り、すべての皆様にご利用いただけます。

LEGO and the LEGO logo are trademarks of the LEGO Group. ©2010 The LEGO Group. © 2010 Lucasfilm Ltd. & TM. All rights reserved. Used under authorization.  
HARRY POTTER, characters, names and related indicia are trademarks of and © Warner Bros. Entertainment Inc.  
Harry Potter Publishing Rights © JKR. TM & © Warner Bros. Entertainment Inc.

(s10)

4614173