



# Harry Potter



4842





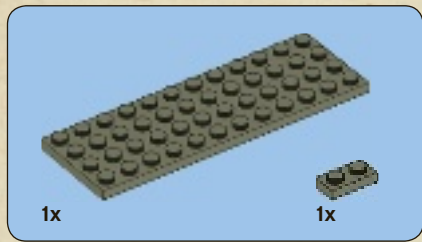
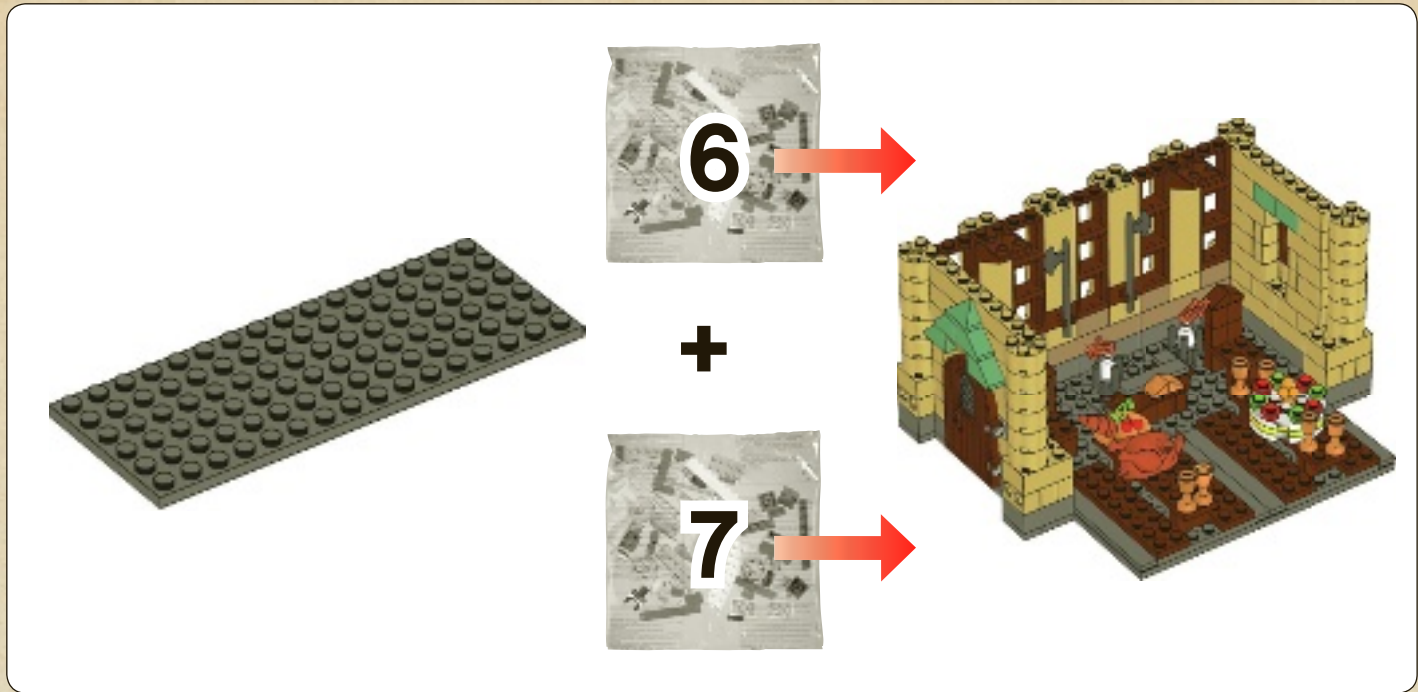

1

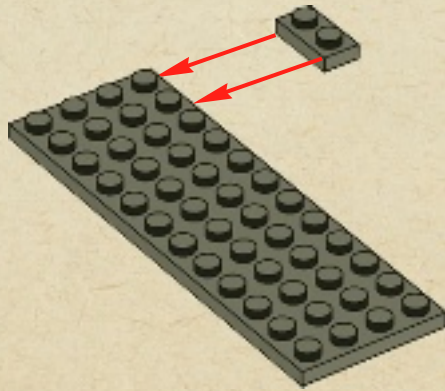



2

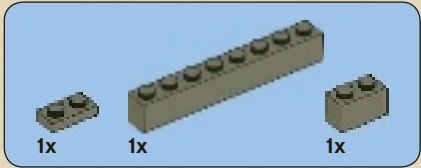
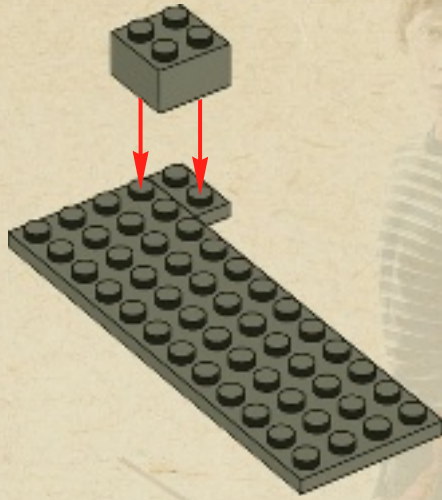

3

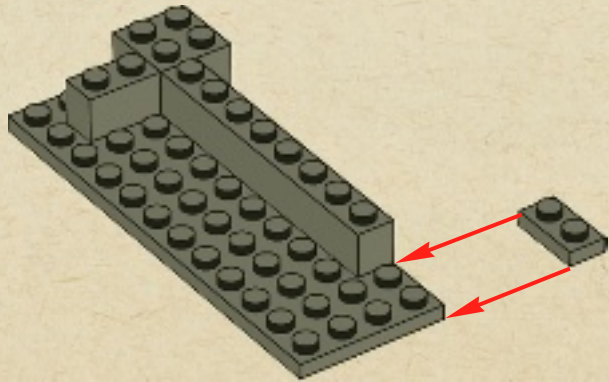



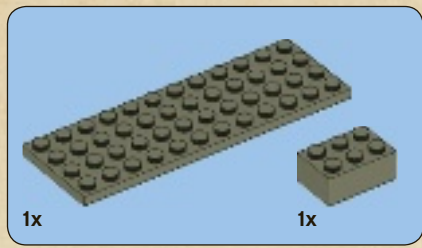

4

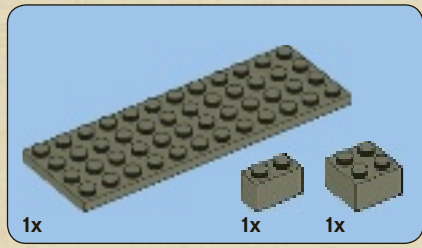
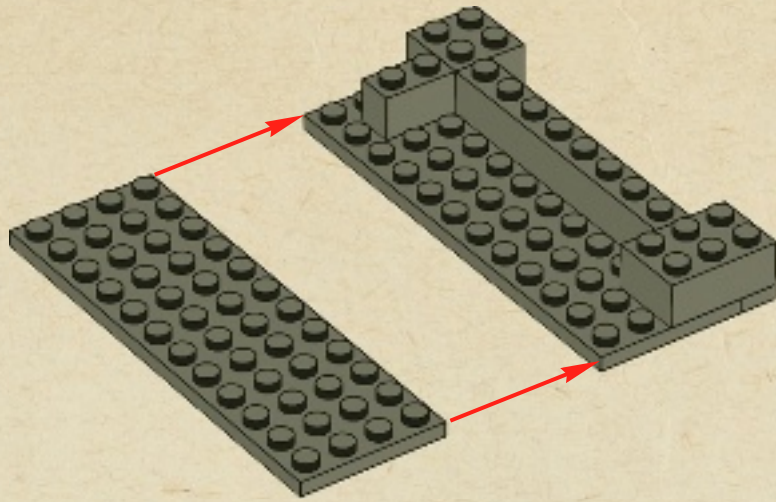

5

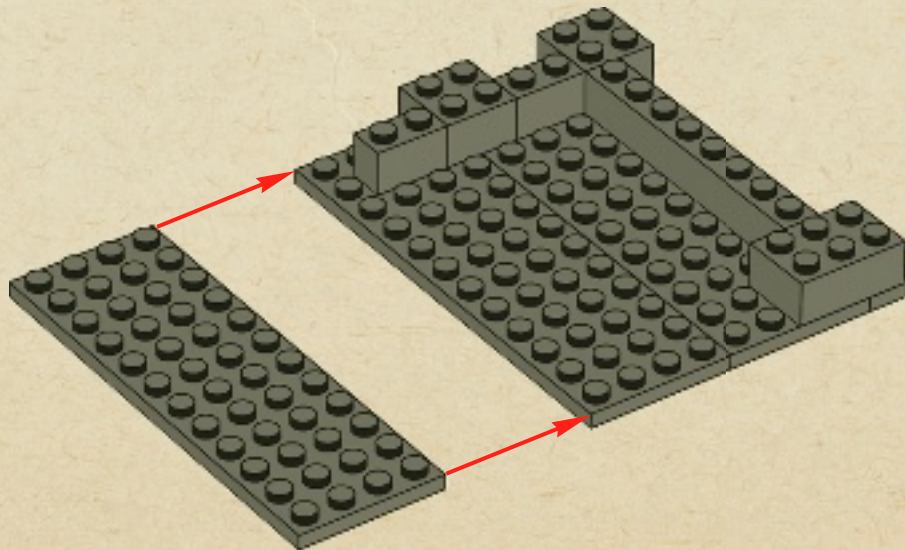





6

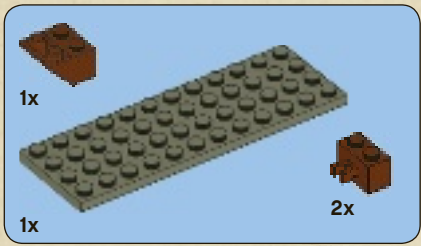
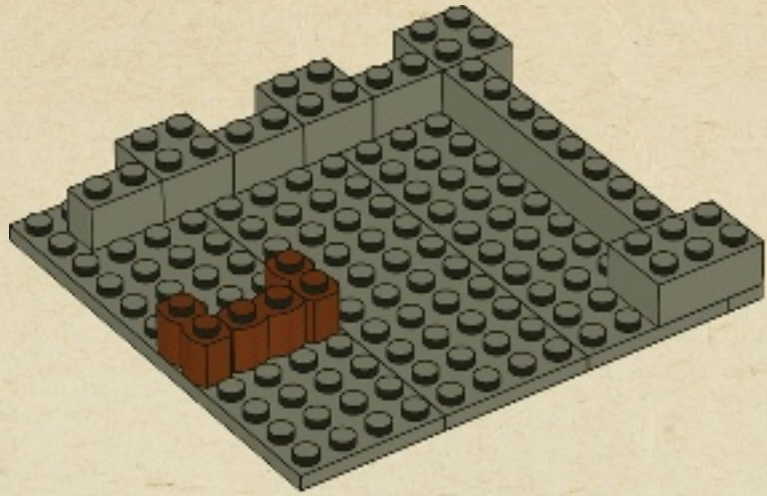

7

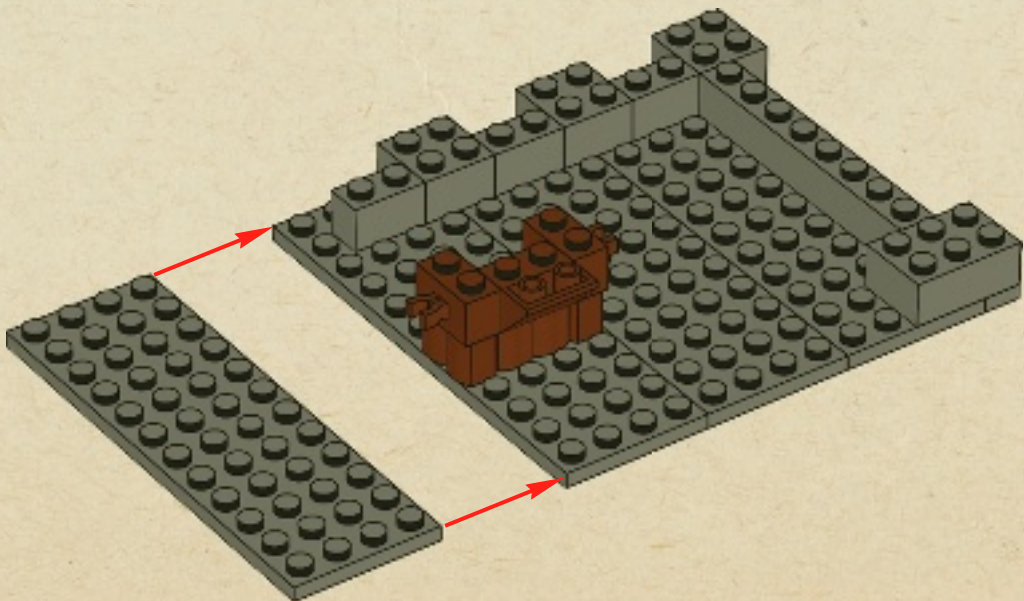



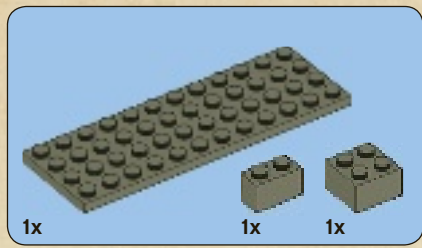

8

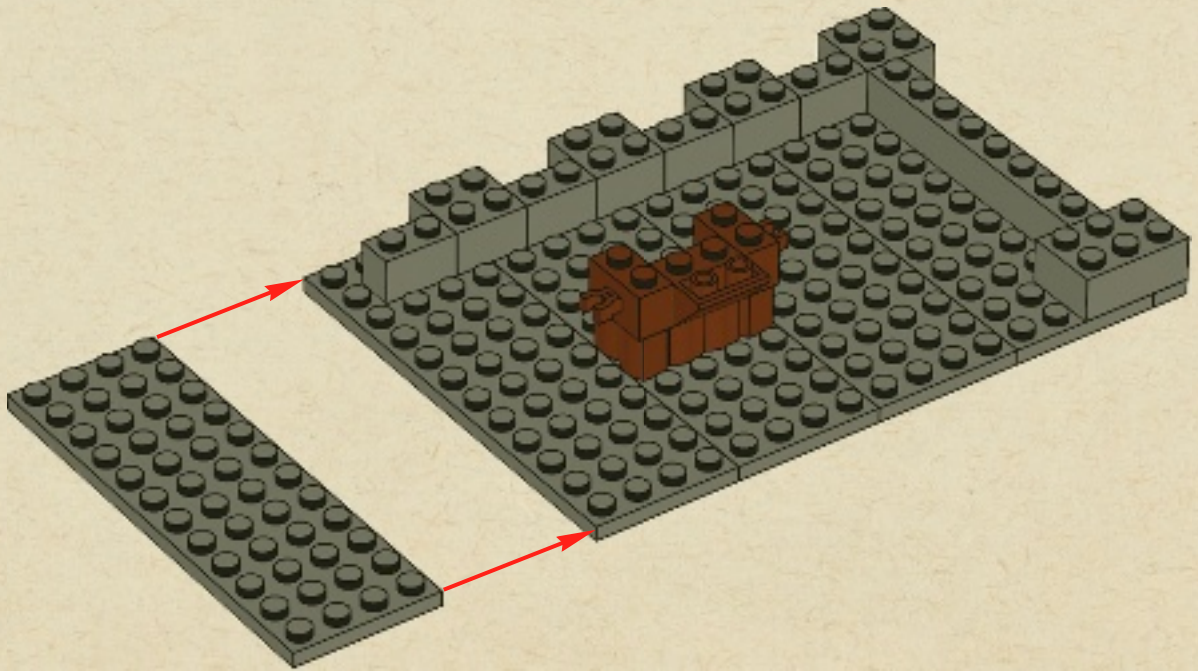





9

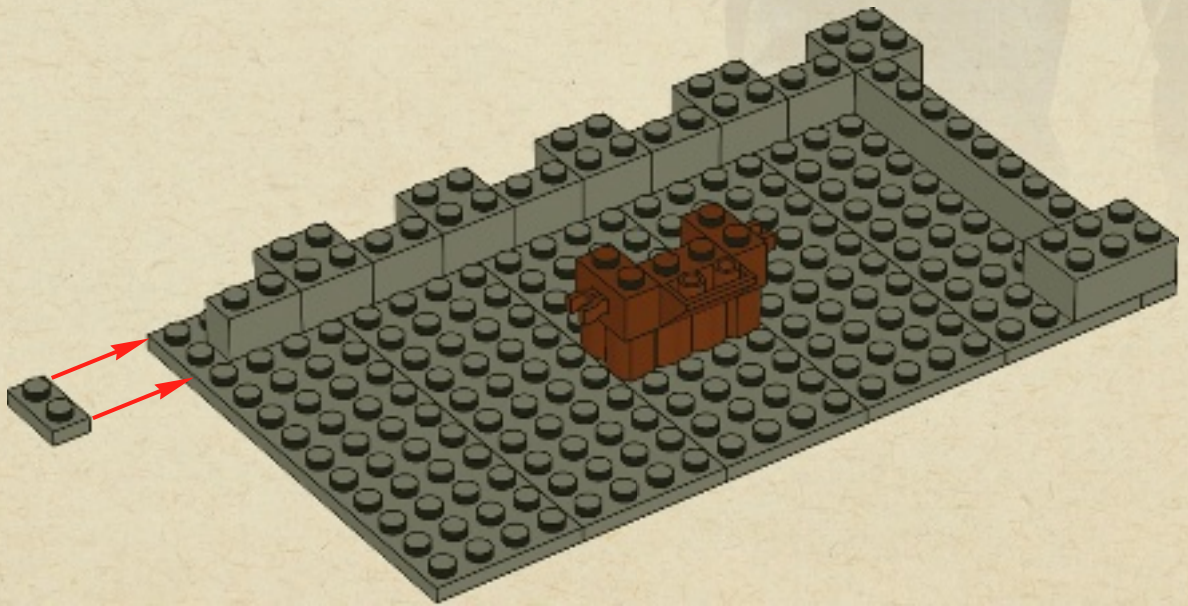





# 10

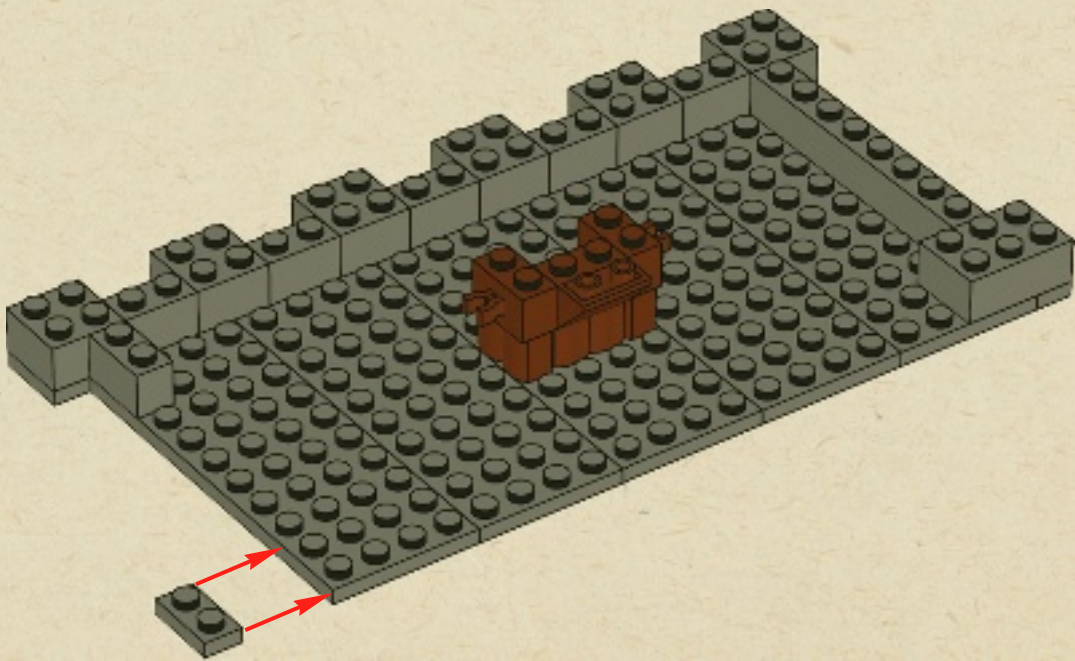





1x



1x

# 11

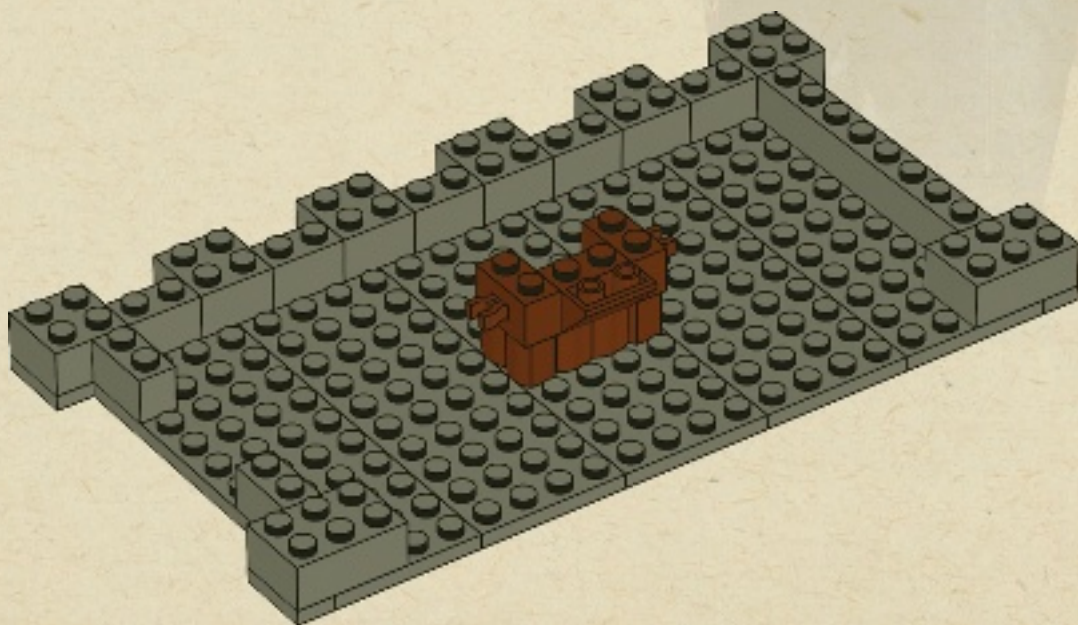



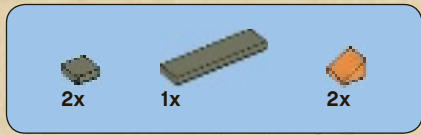

# 12

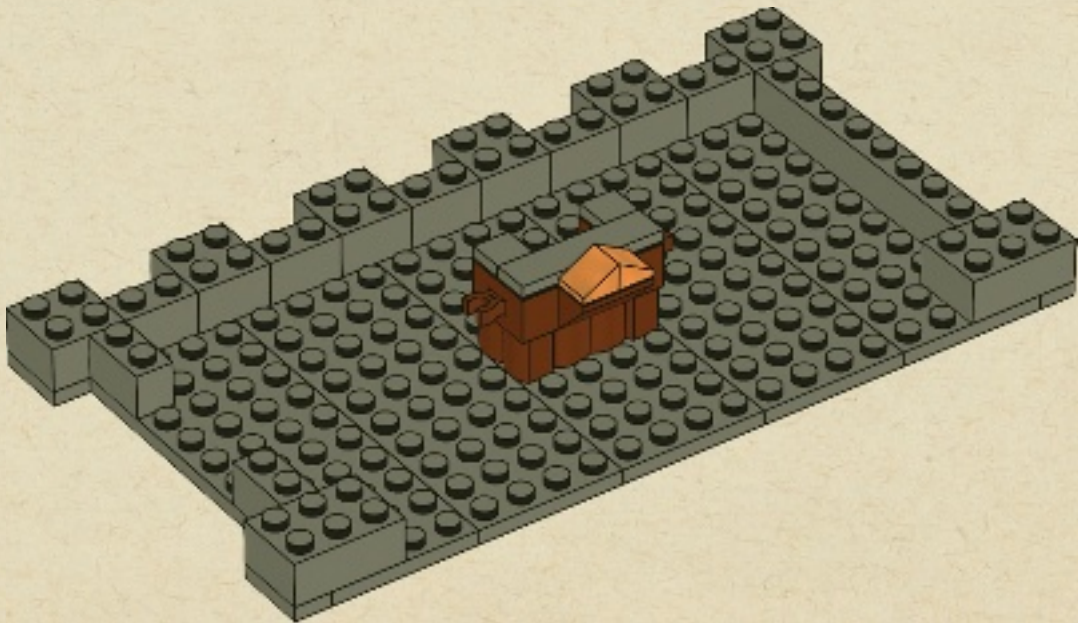





4x

13

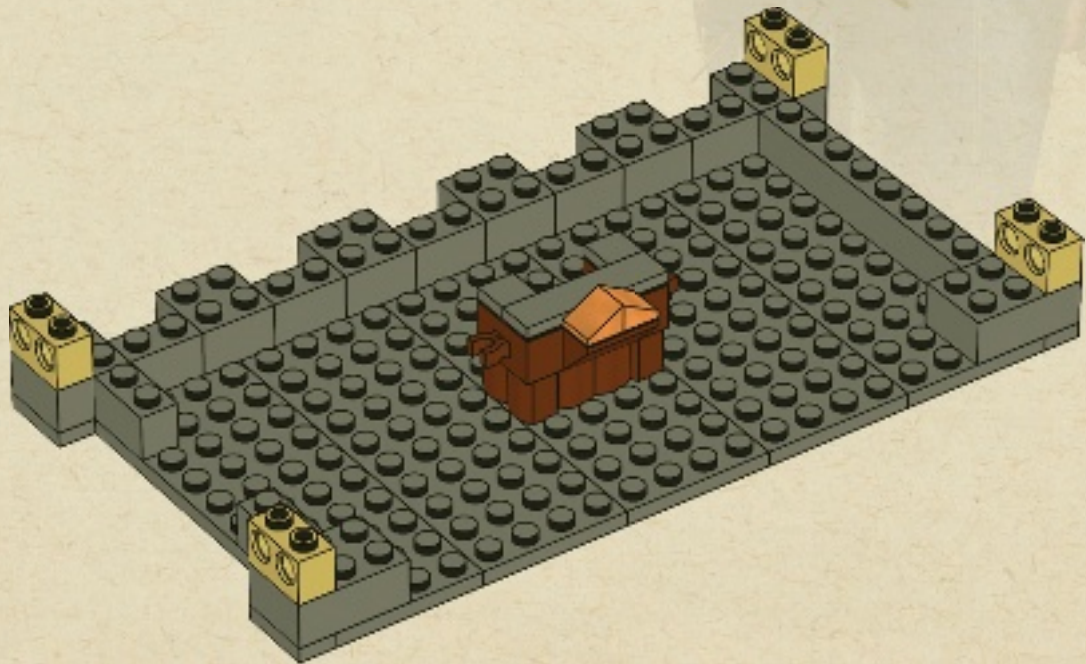



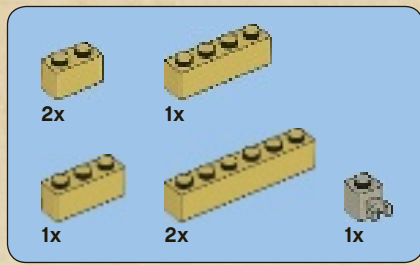

14

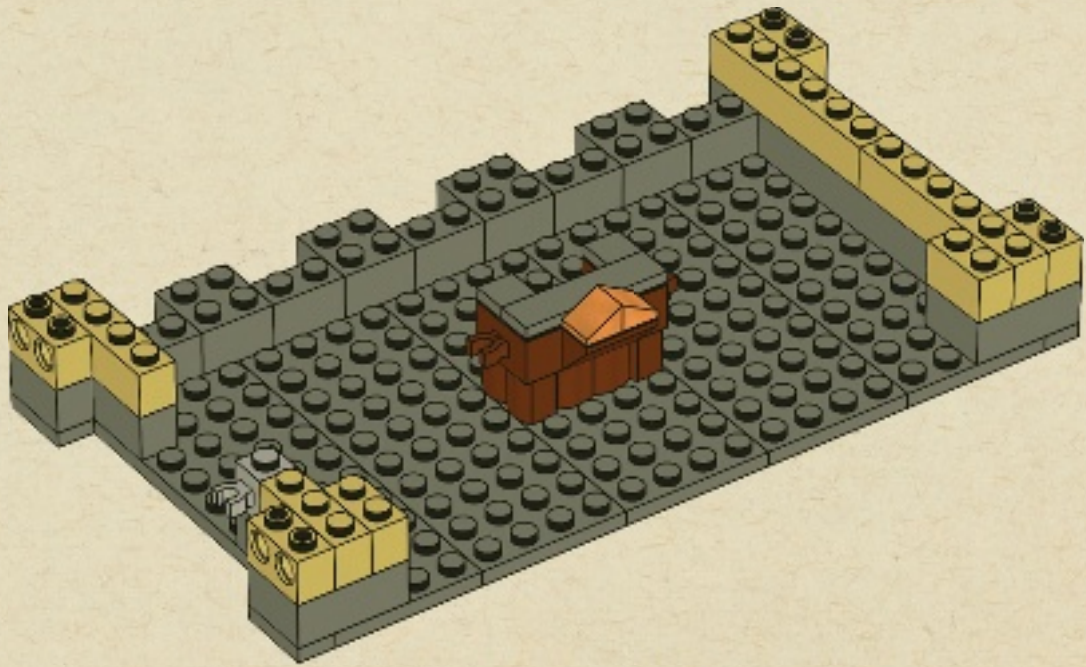



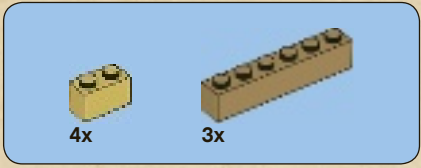

# 15

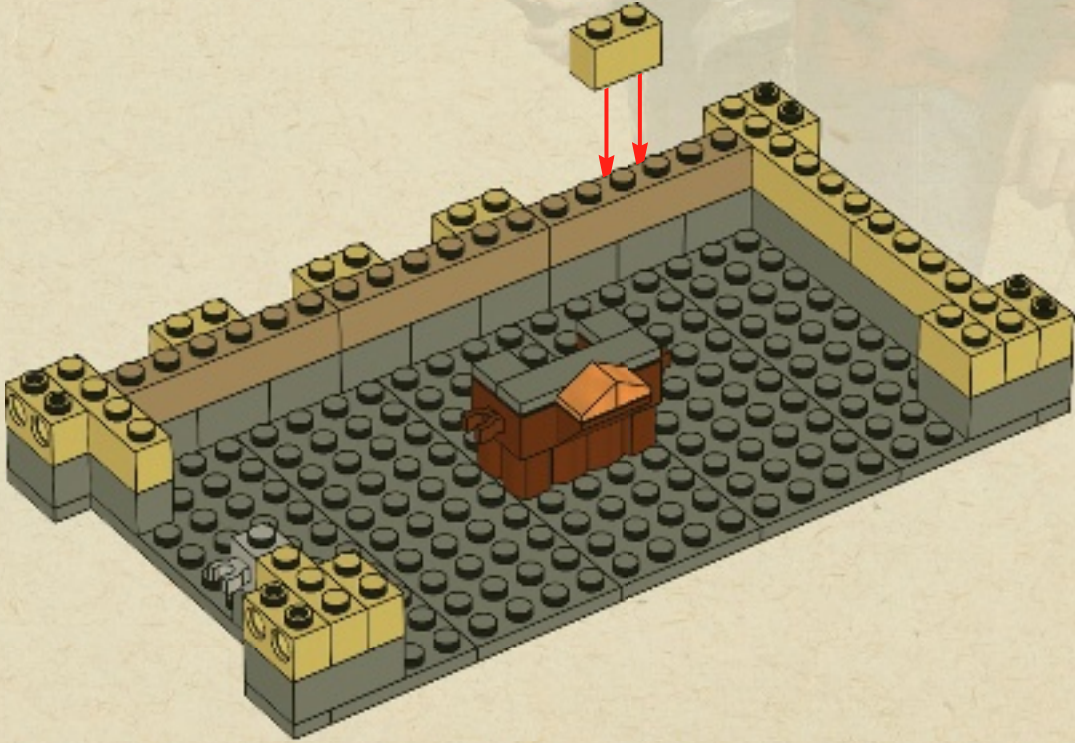



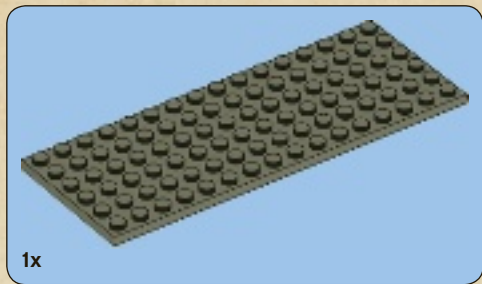

1x

# 16

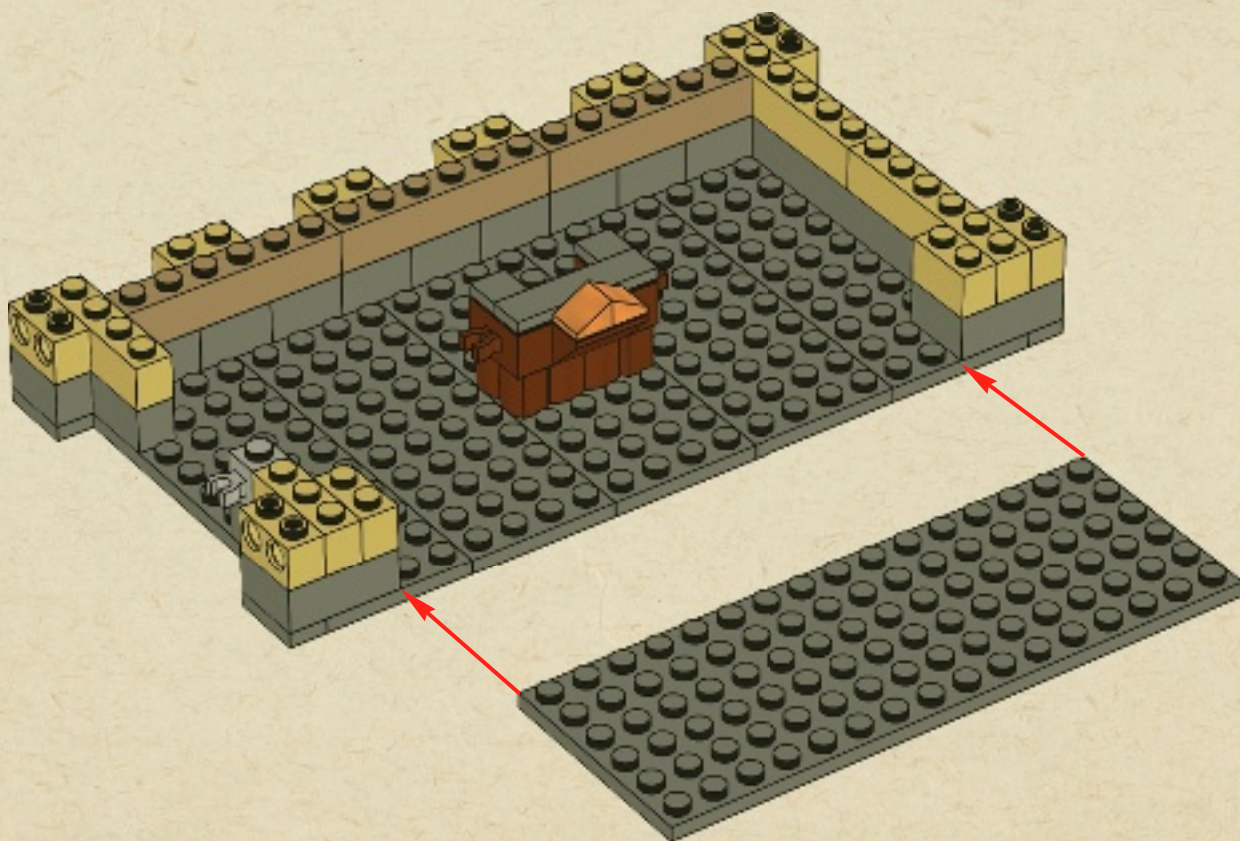



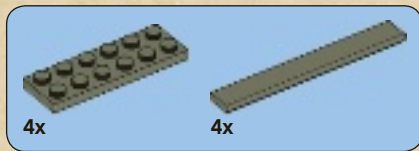

17

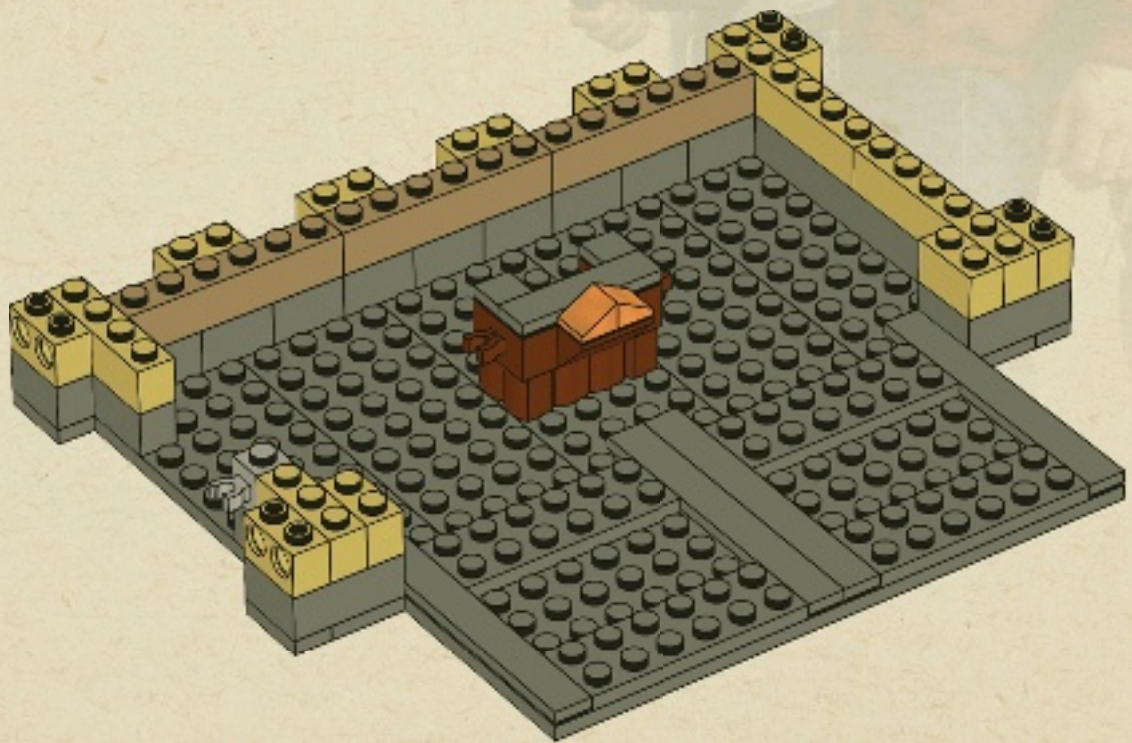



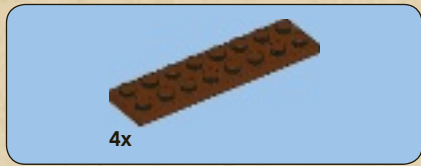

18

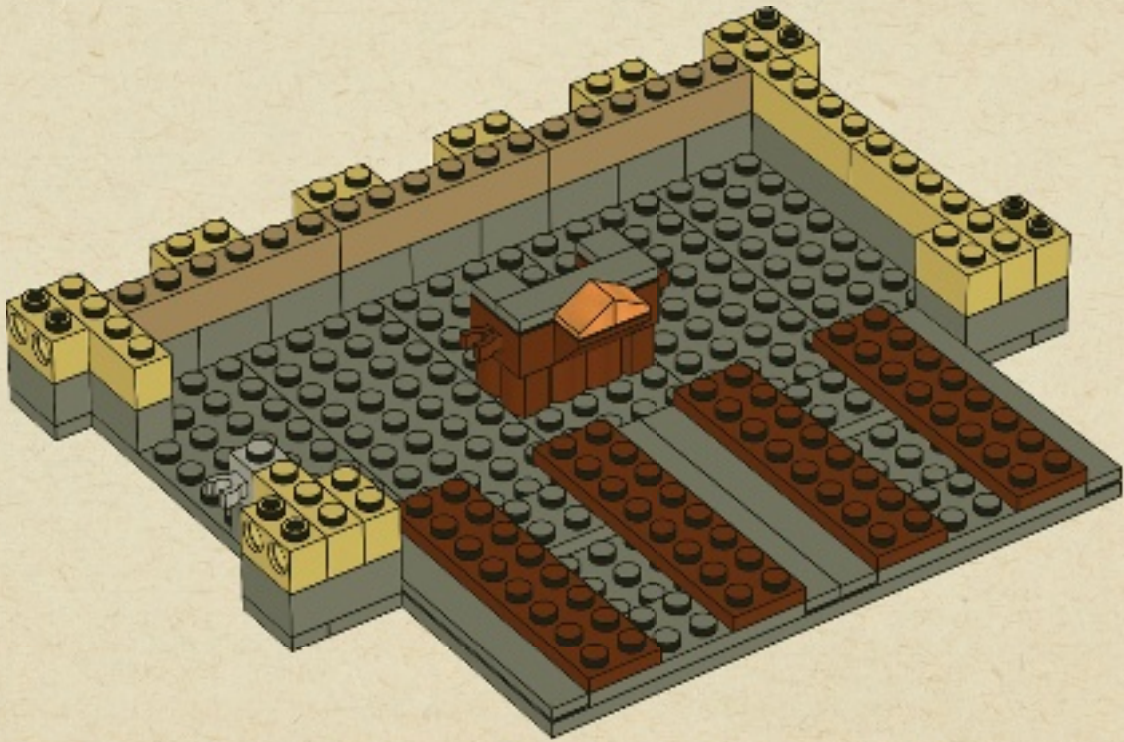





4x

# 19

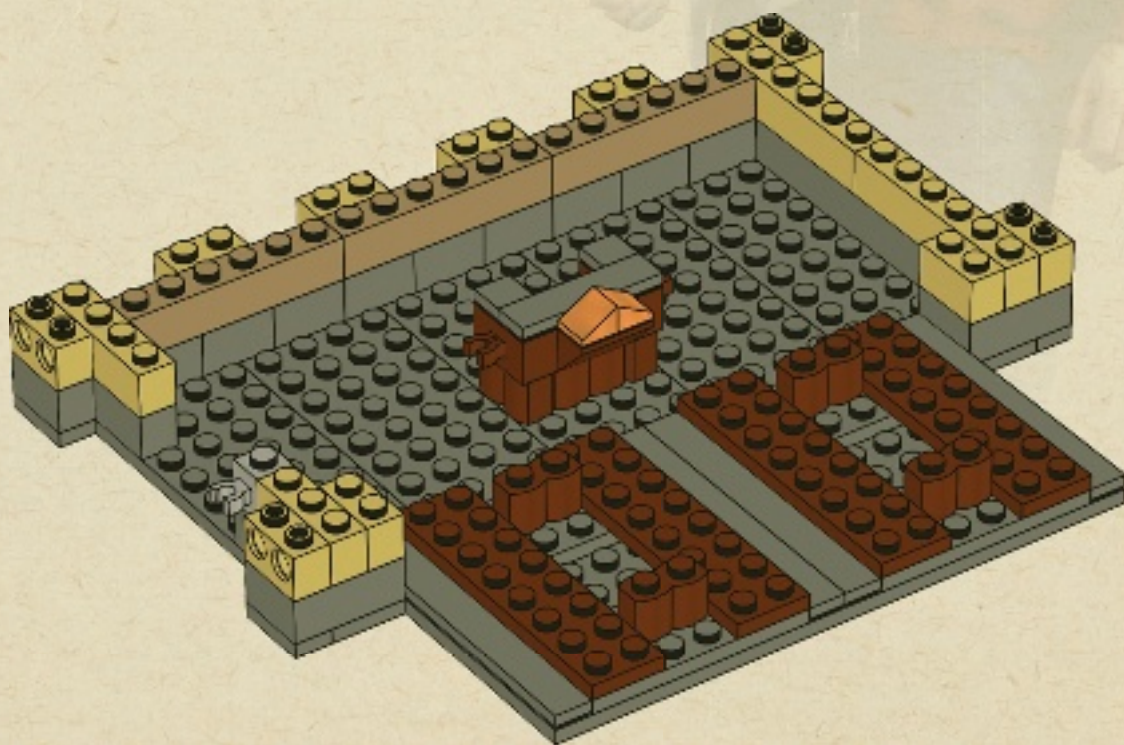



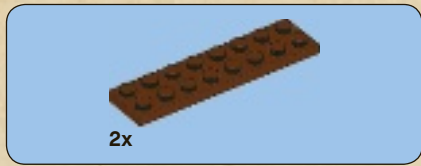

20

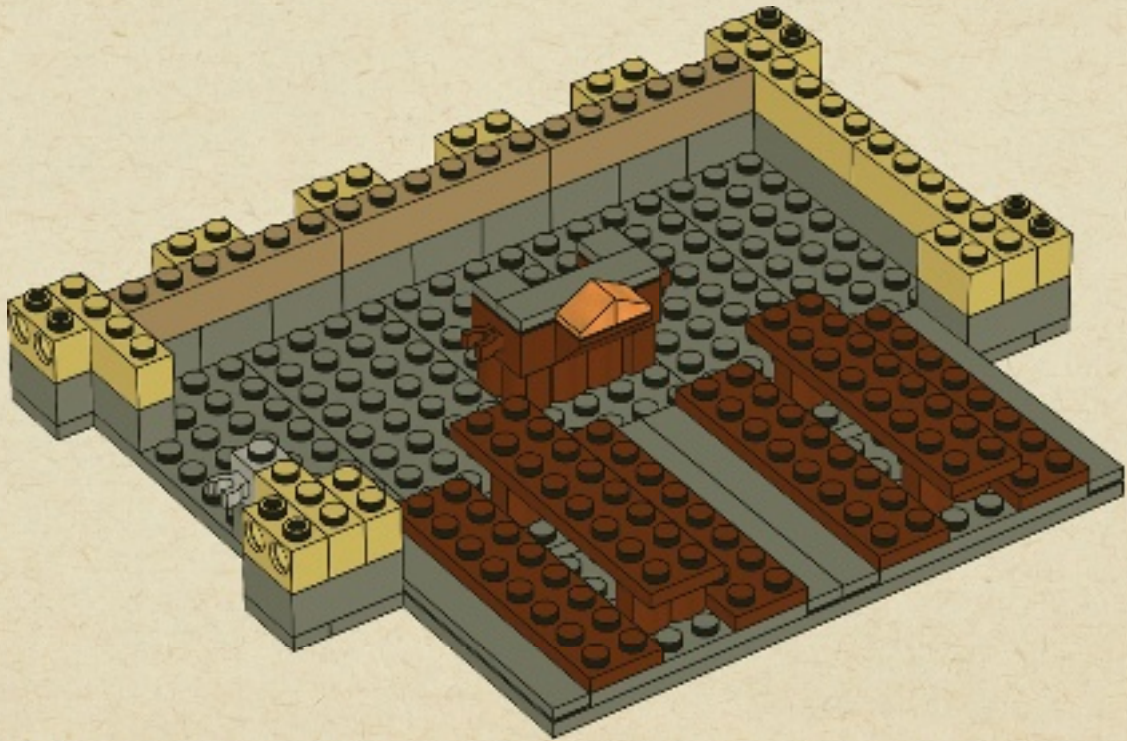





# 21

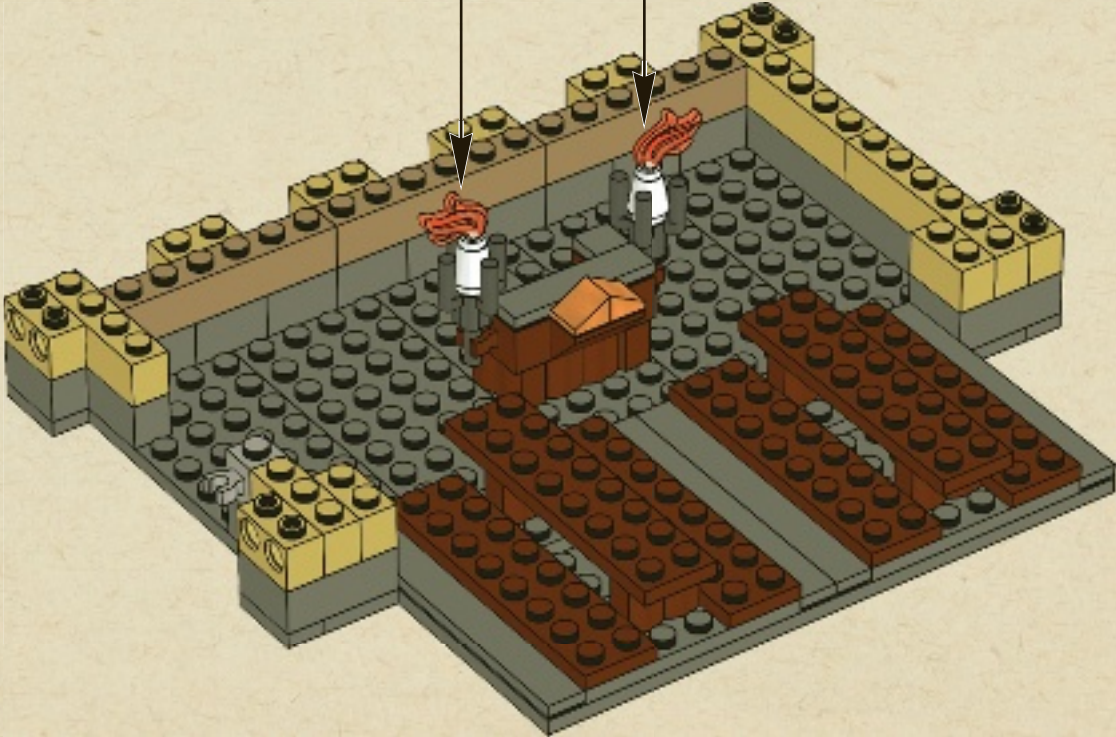
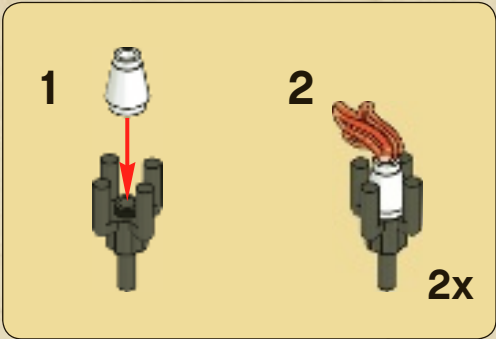



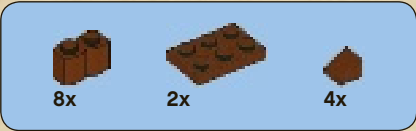

# 22

<p>1</p>	<p>3</p>	<p>4</p>
<p>2</p>		<p>2x</p>

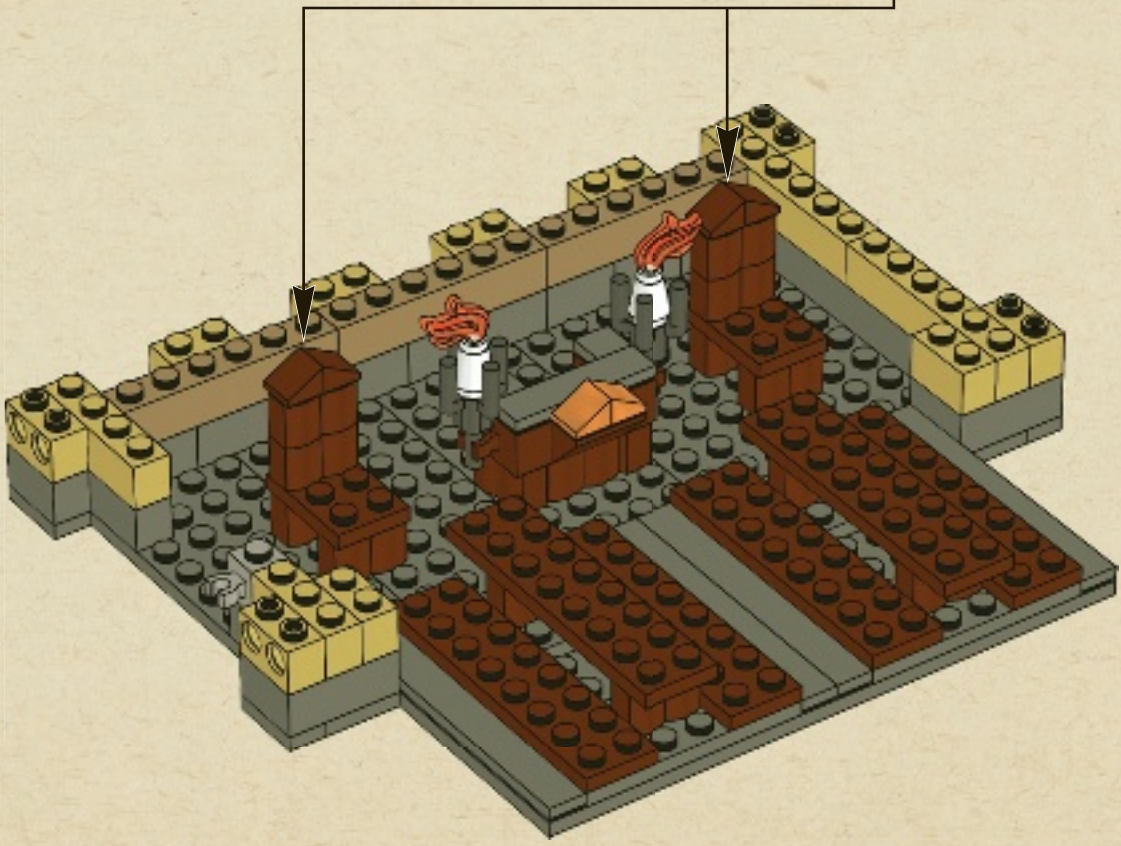





6x



5x

# 23

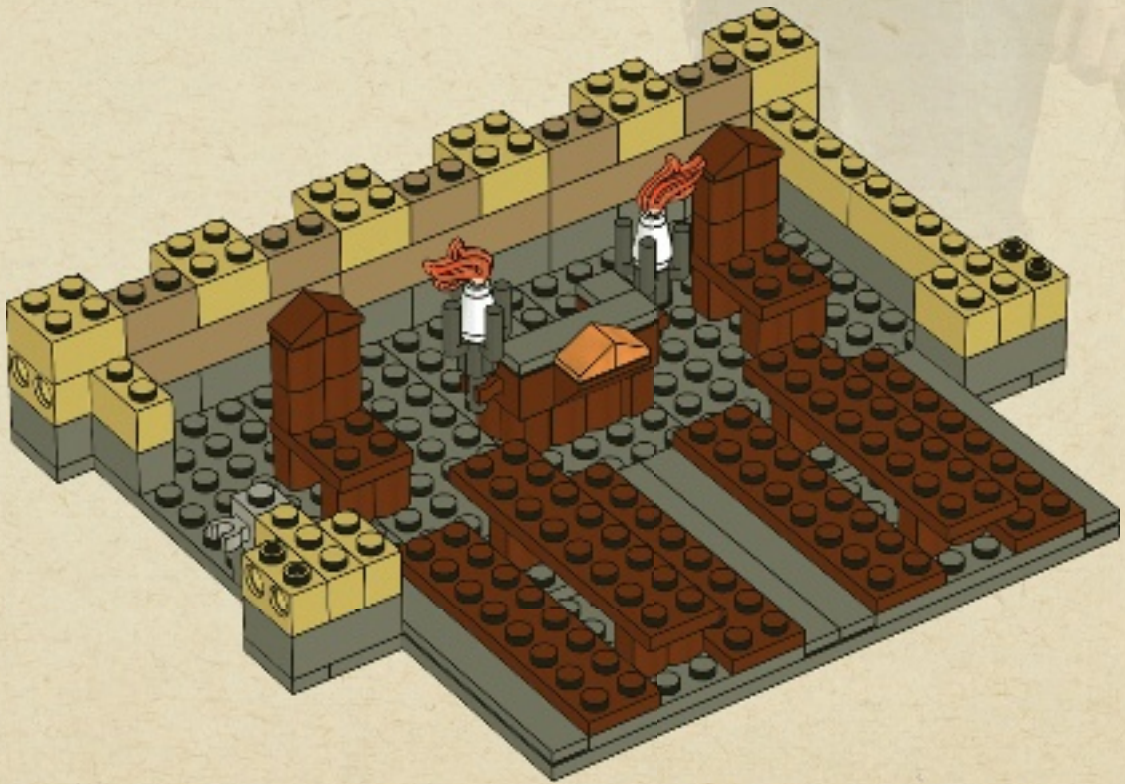





24

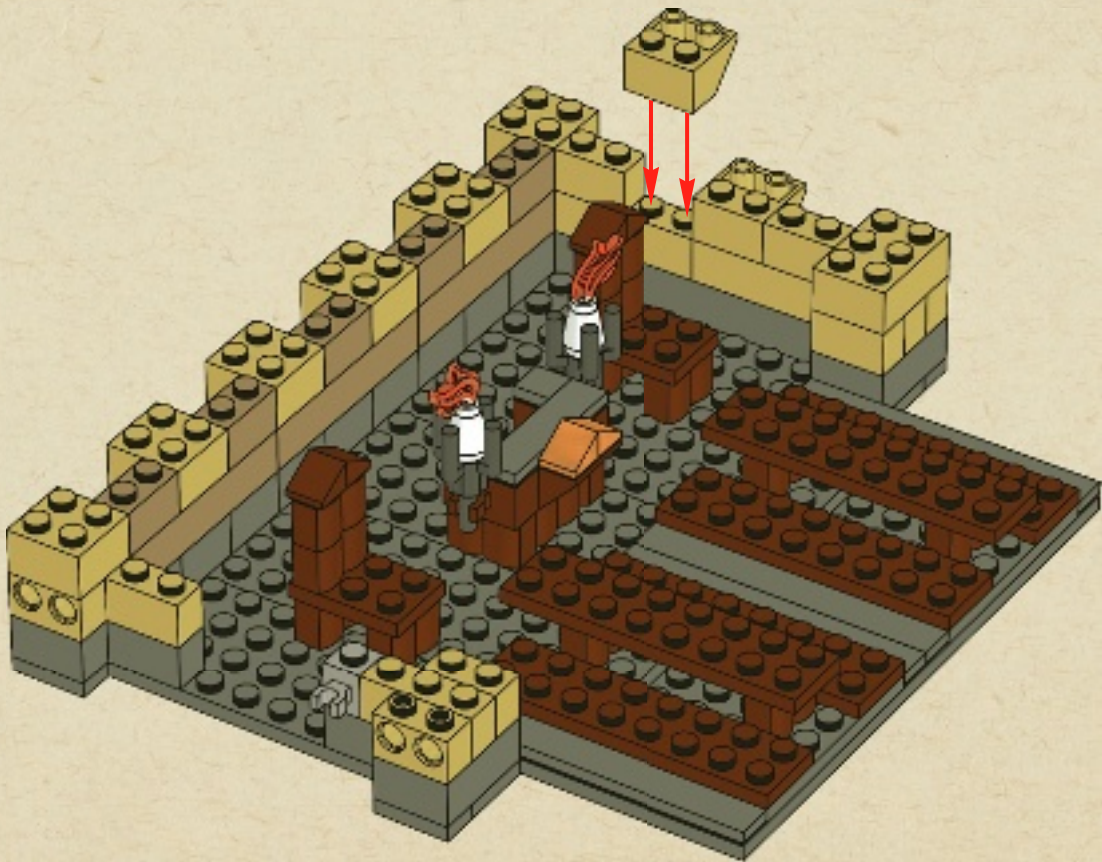





2x



1x

# 25

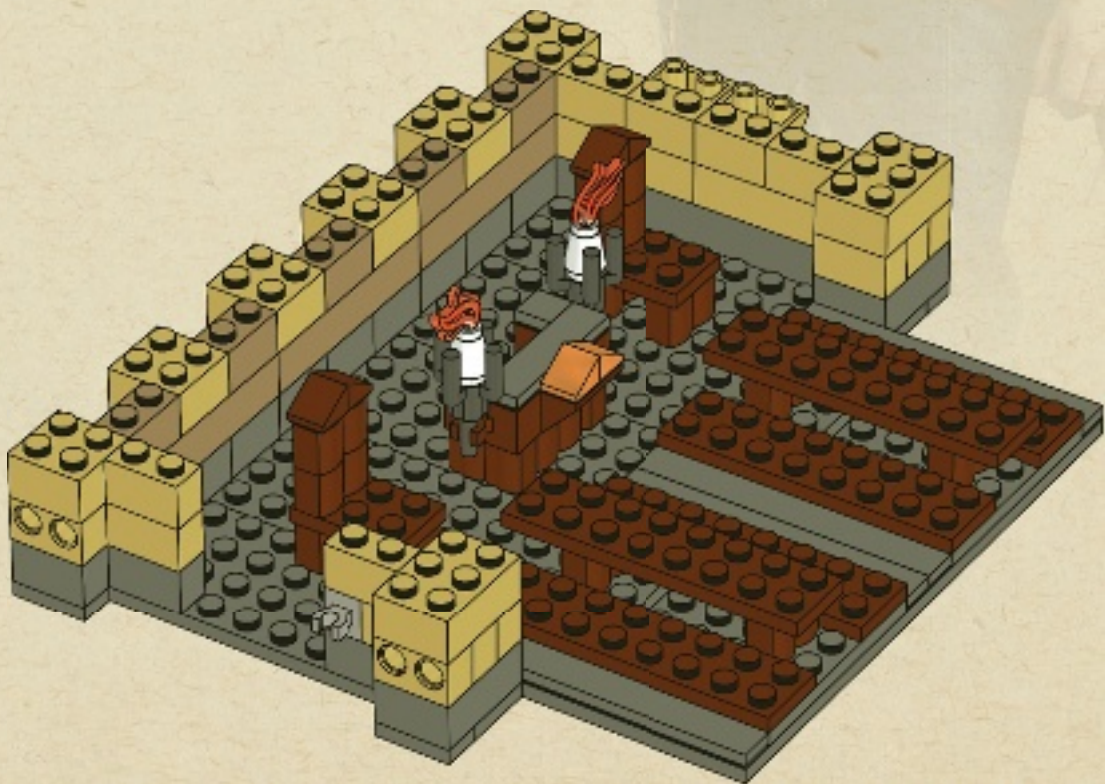





2x

# 26

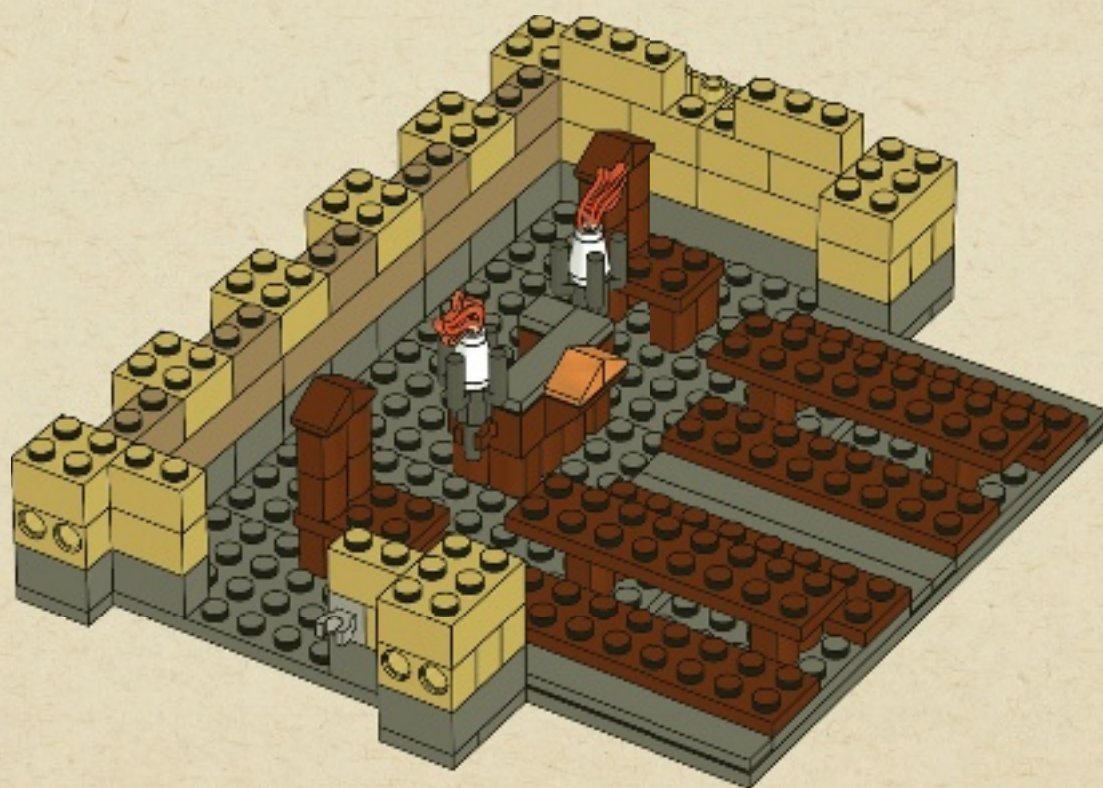





2x

27

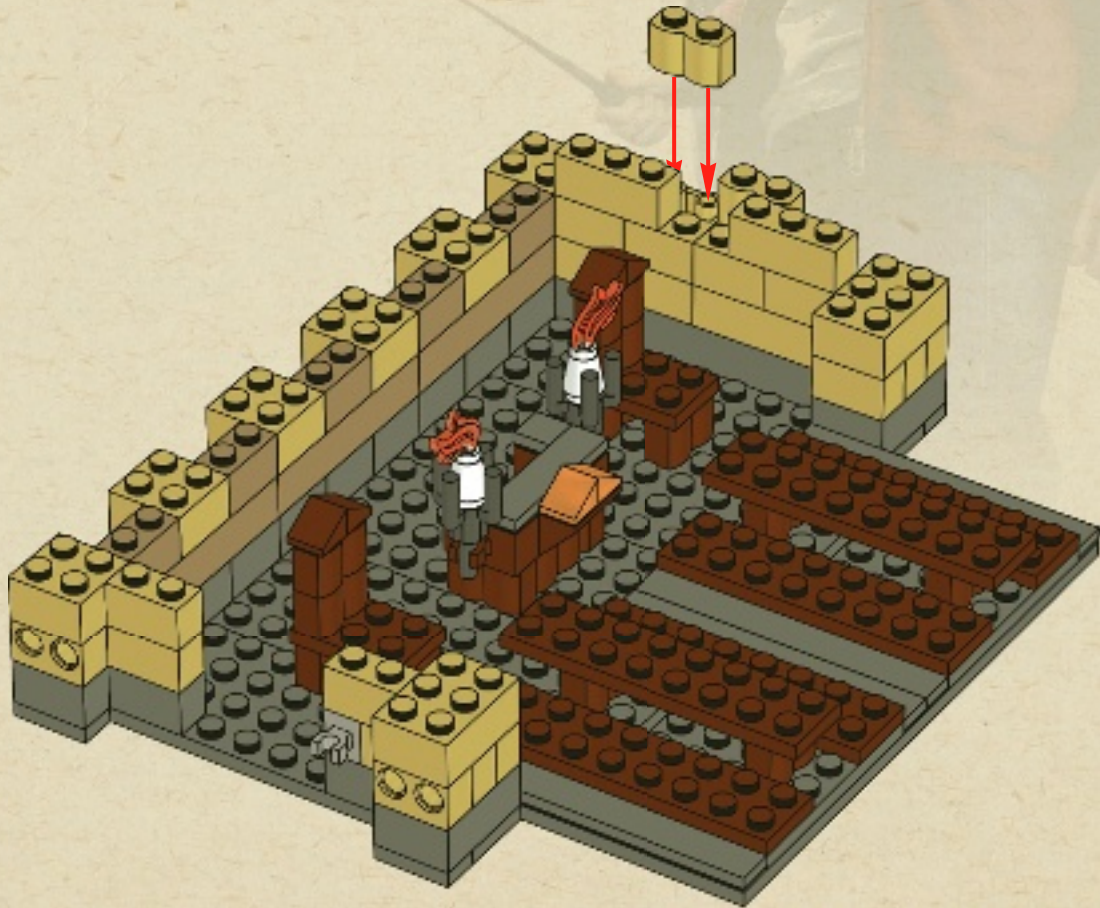





2x



2x

# 28

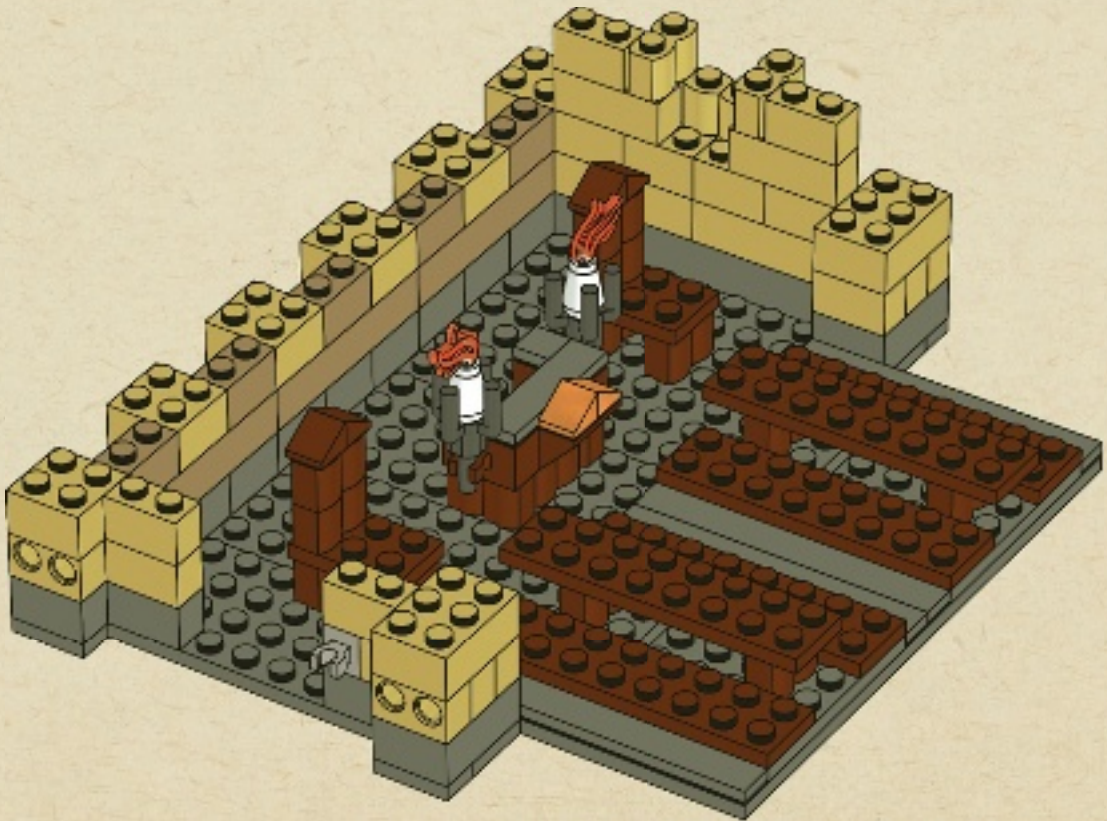



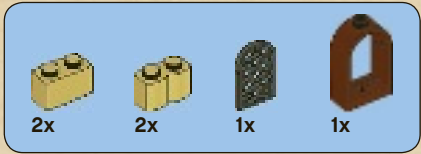

29

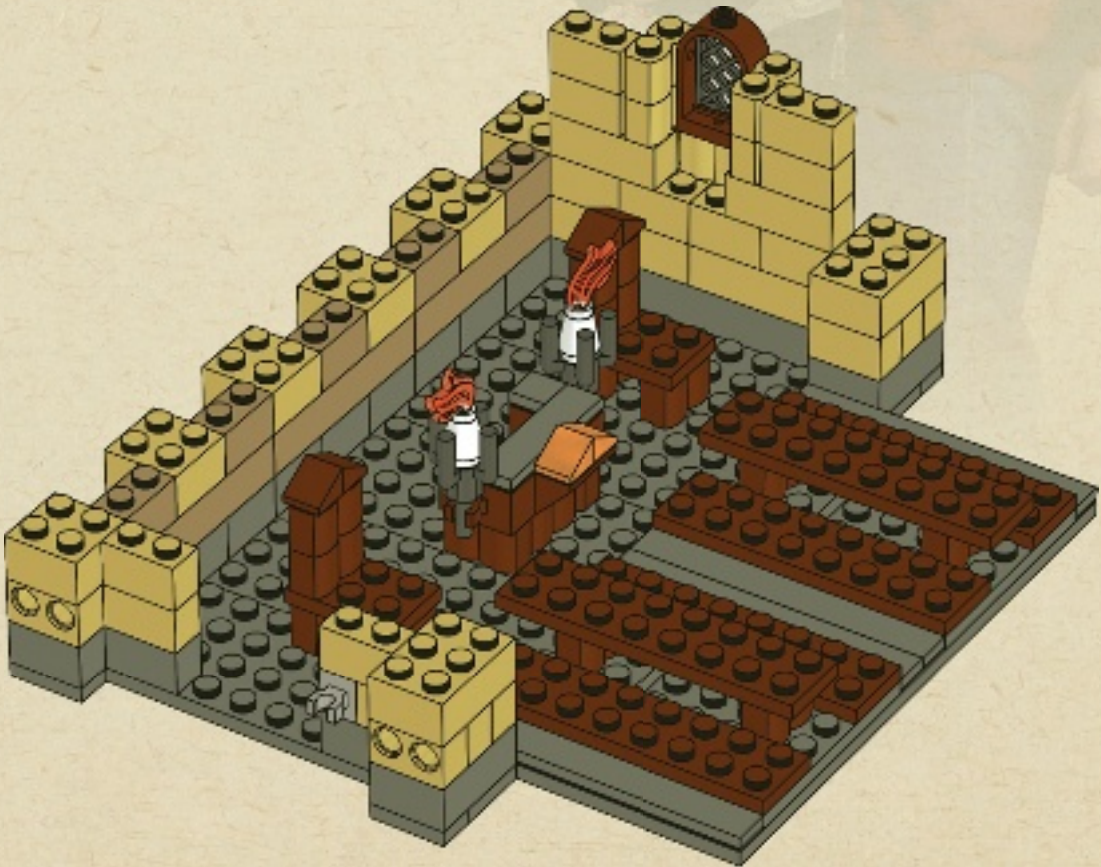



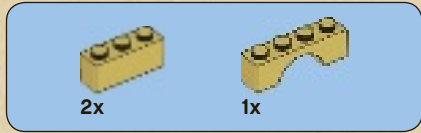

# 30

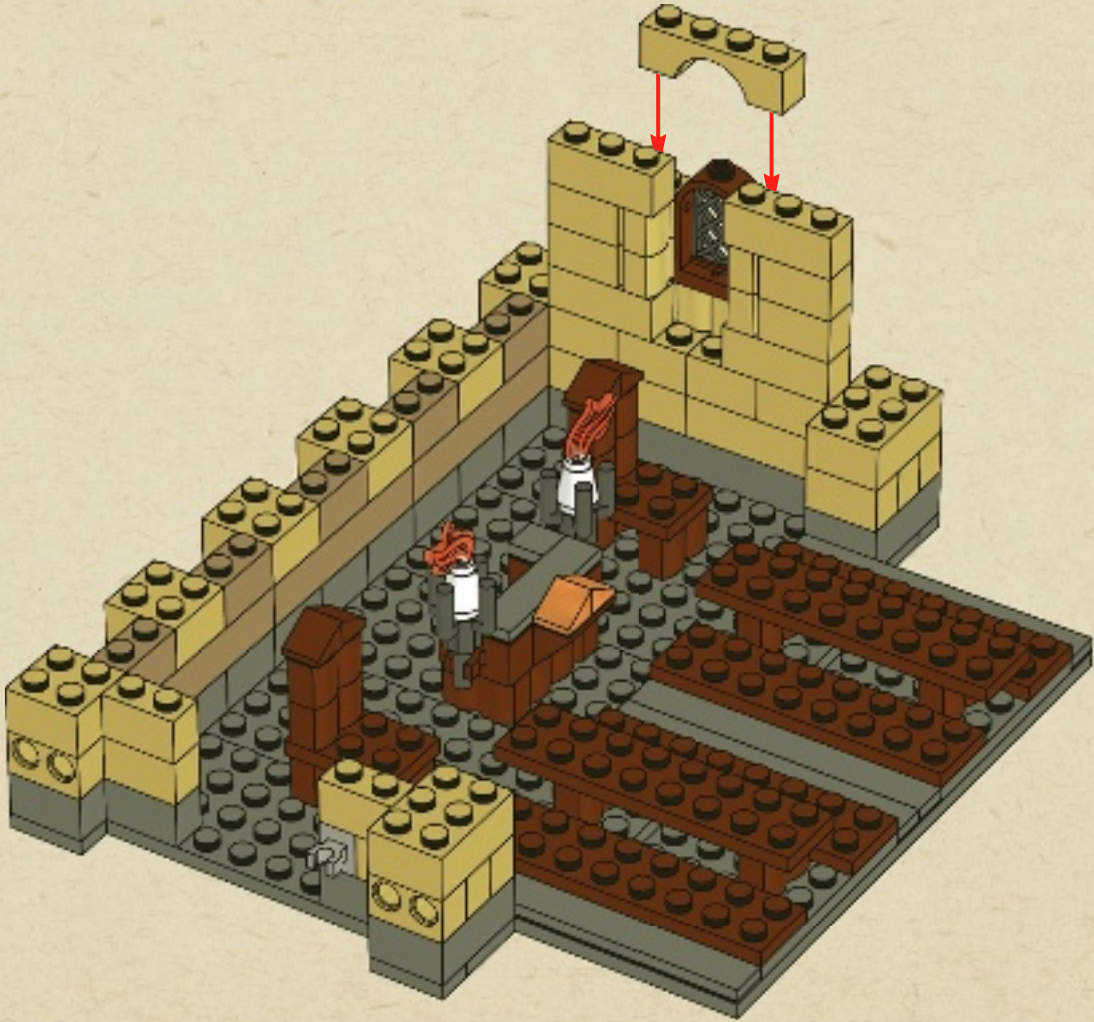





2x



2x

# 31

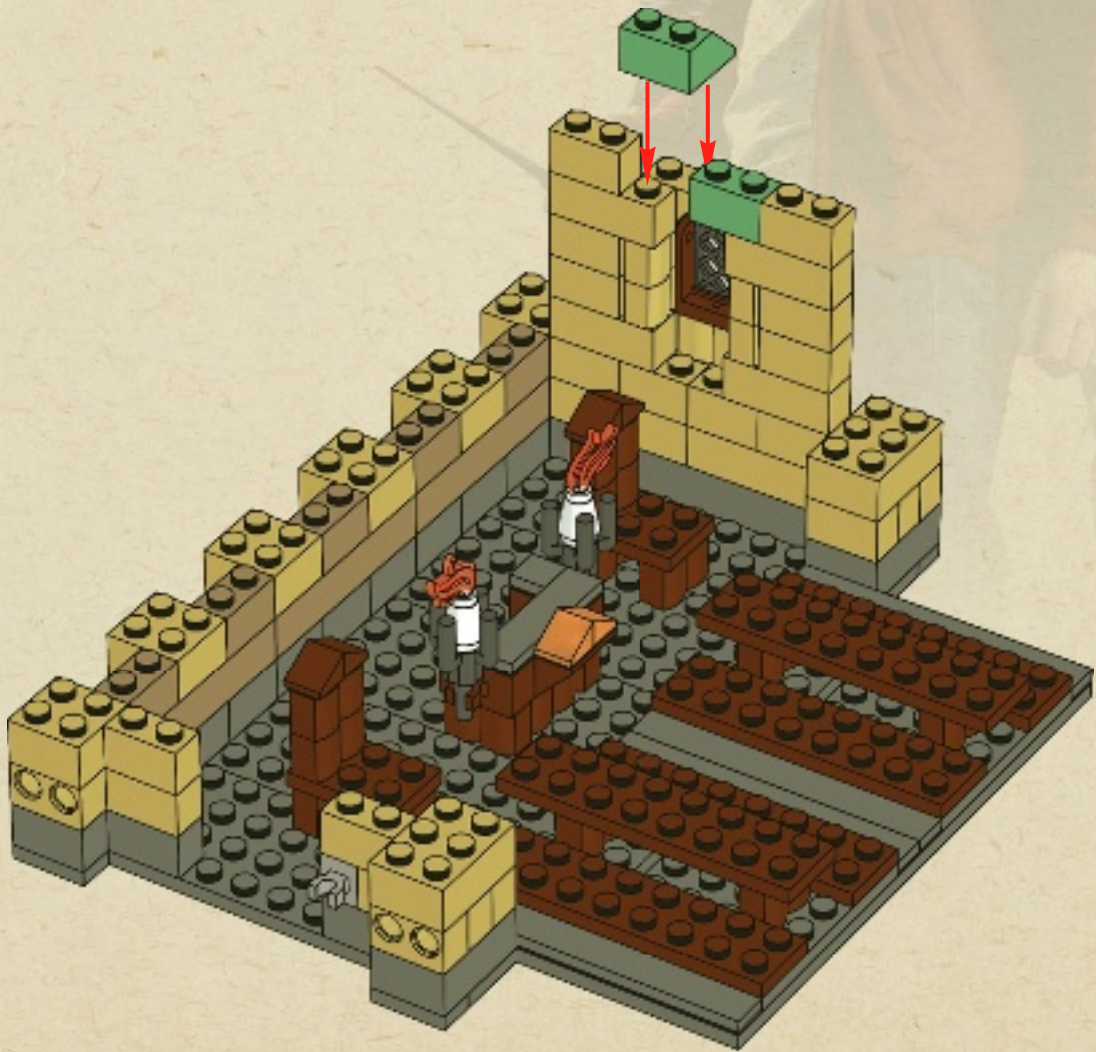



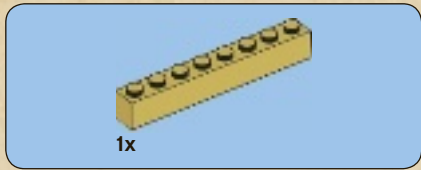

# 32

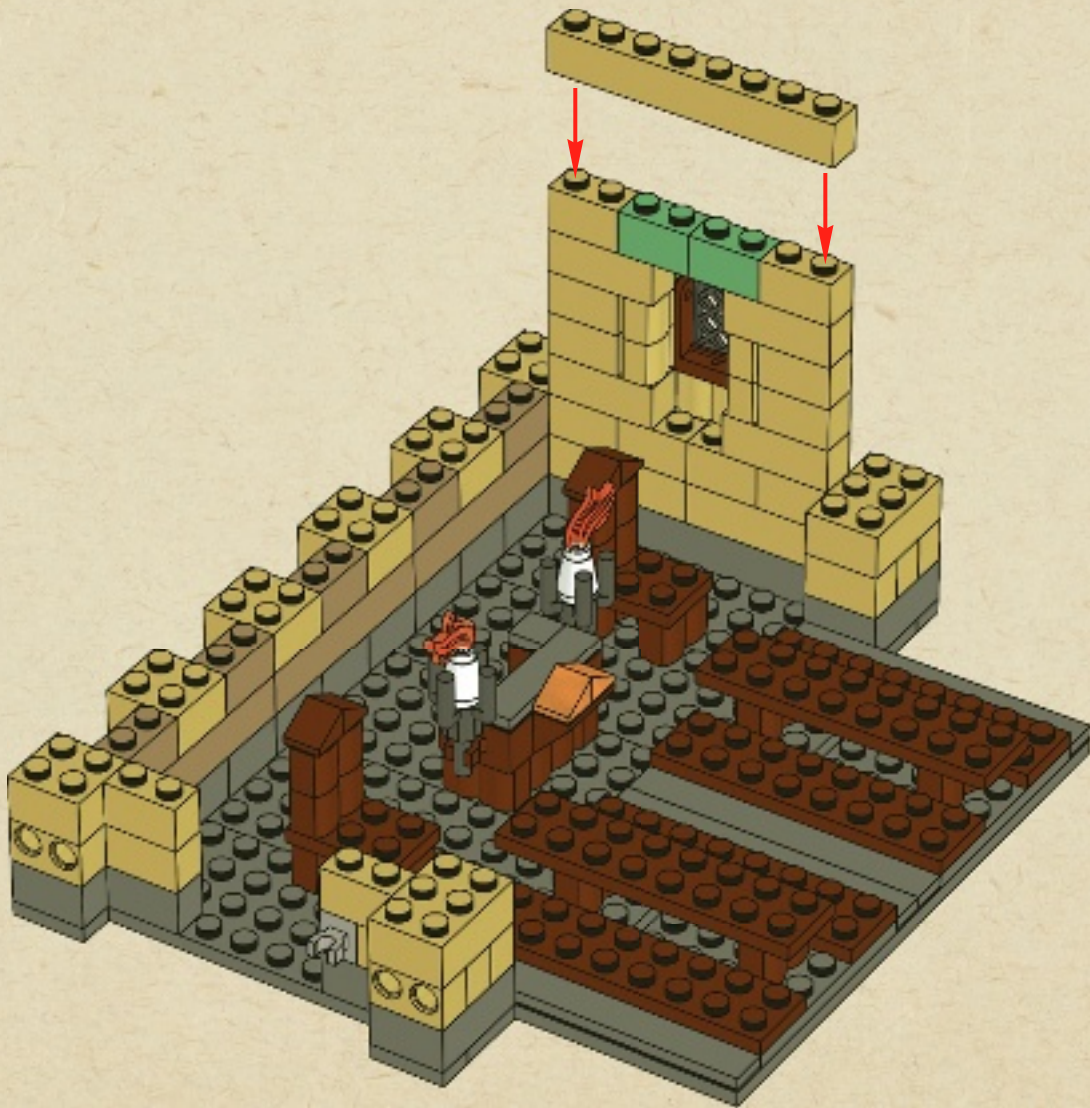





24x

# 33

1

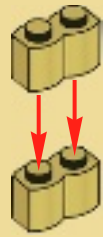

2



4x

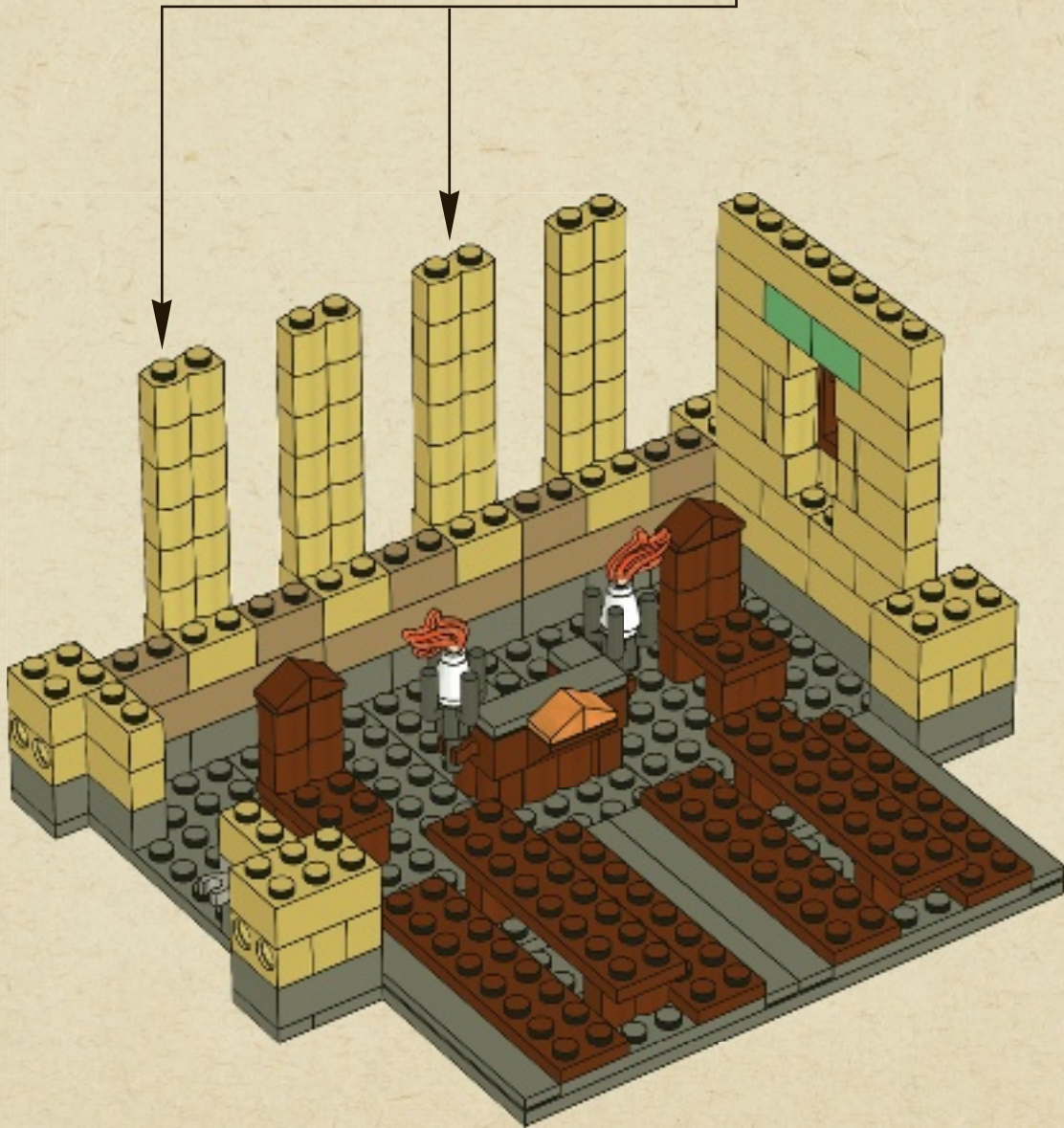



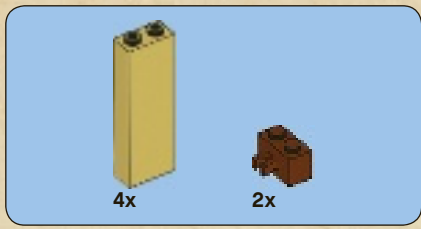

34

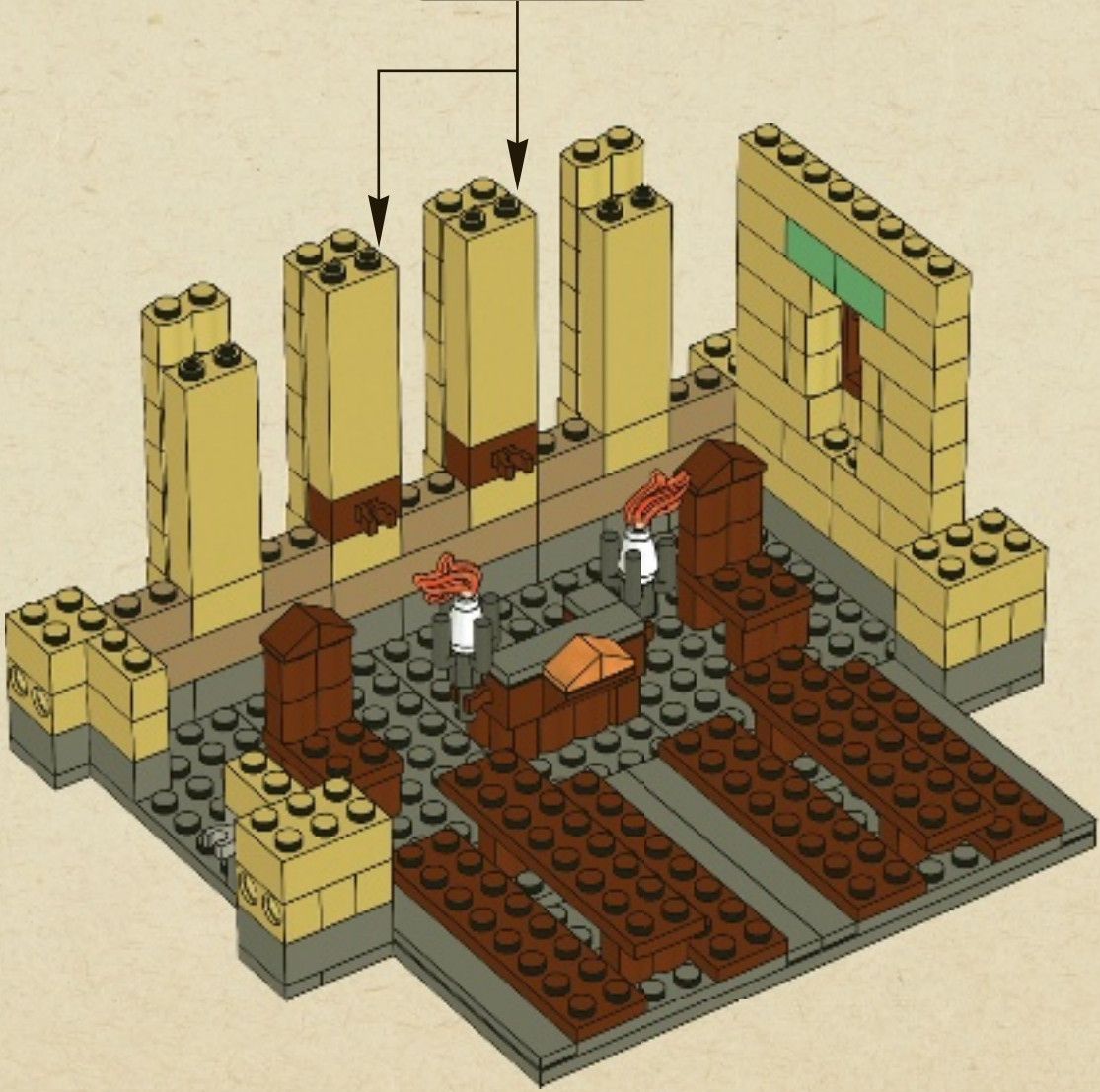
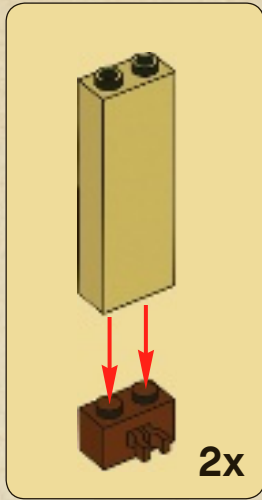





15x

# 35

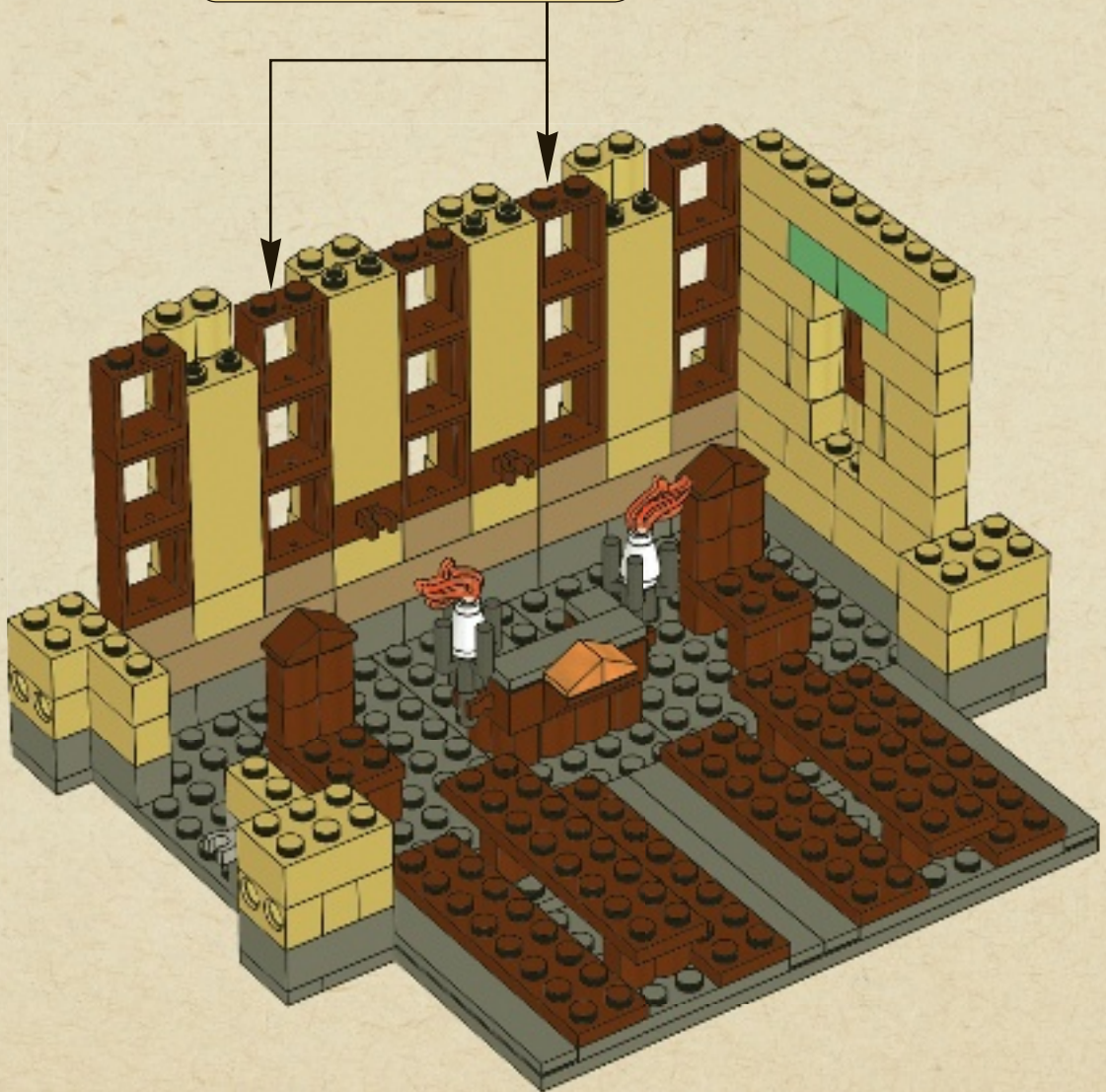
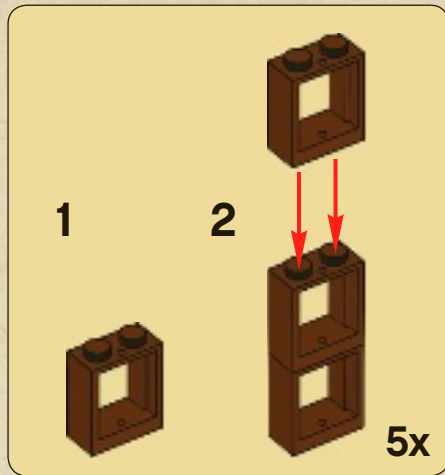





# 36

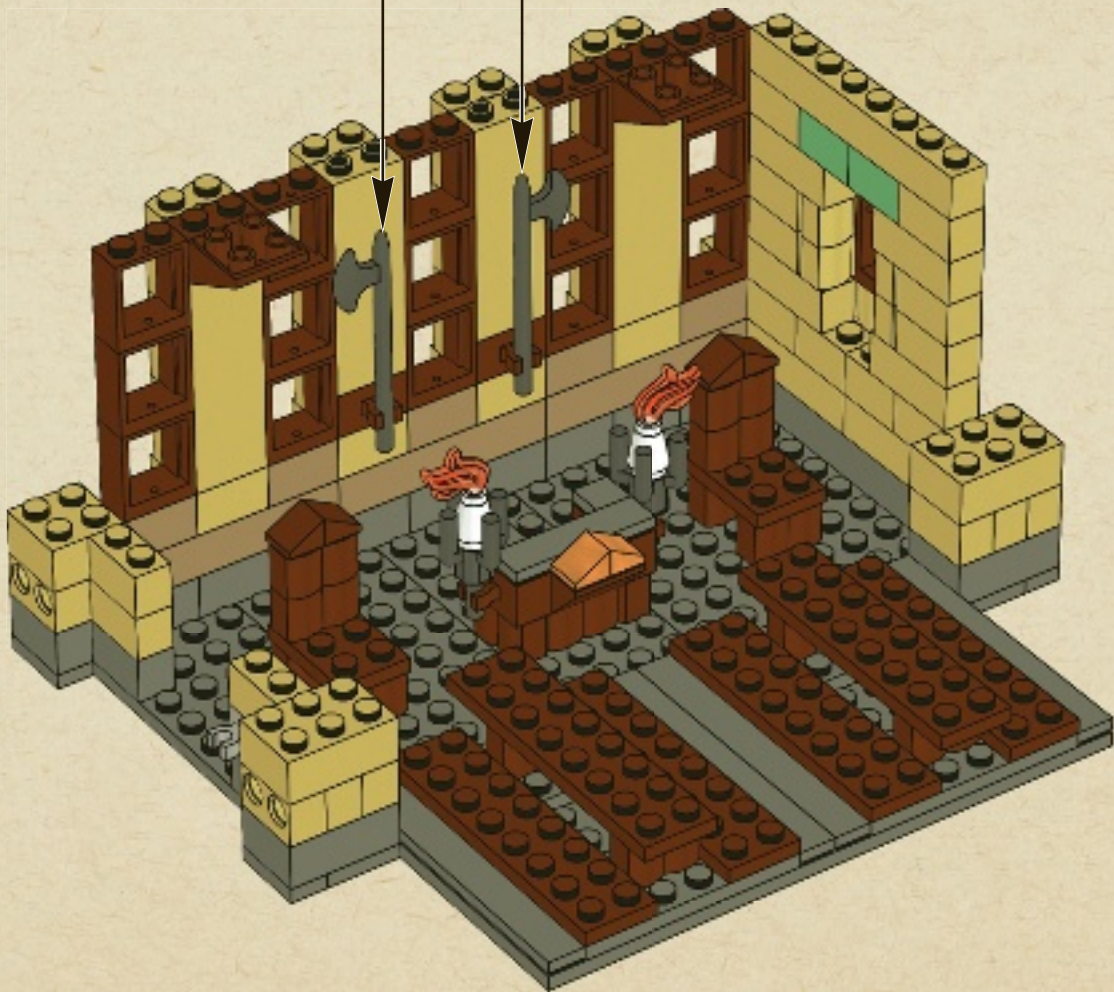





1x



1x



1x

# 37

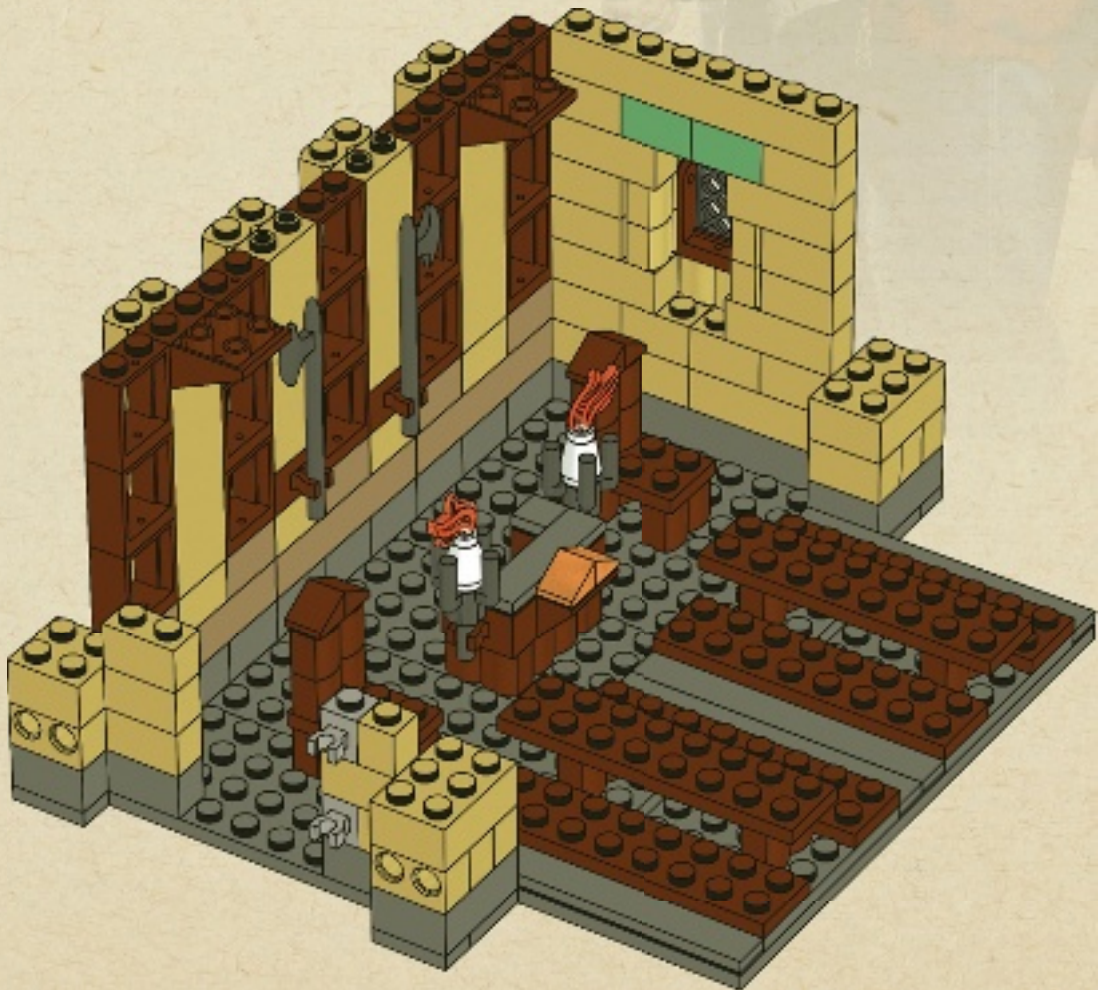



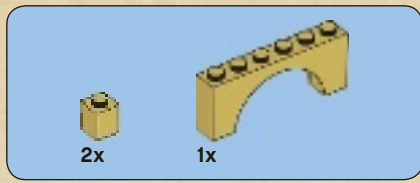

# 38

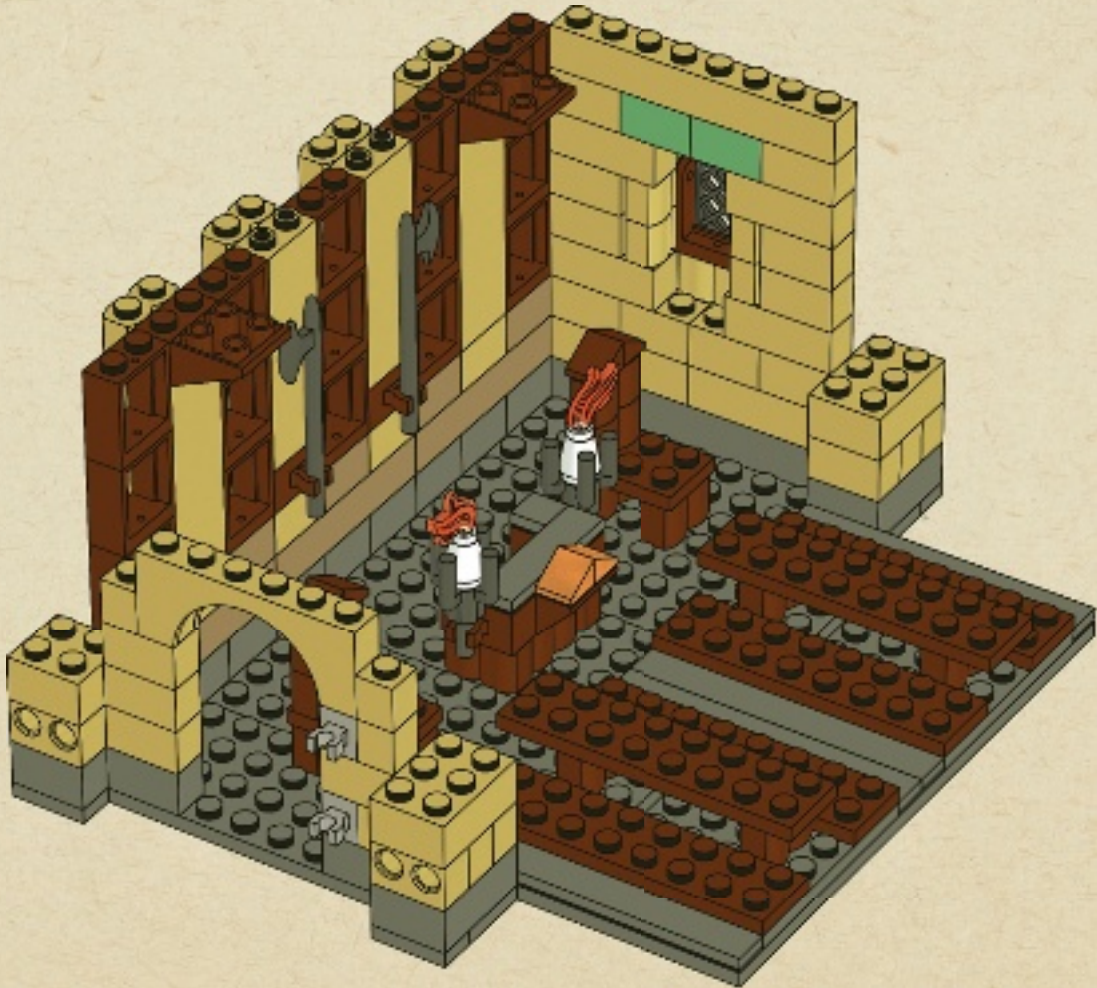



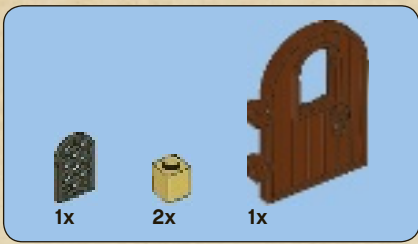

# 39

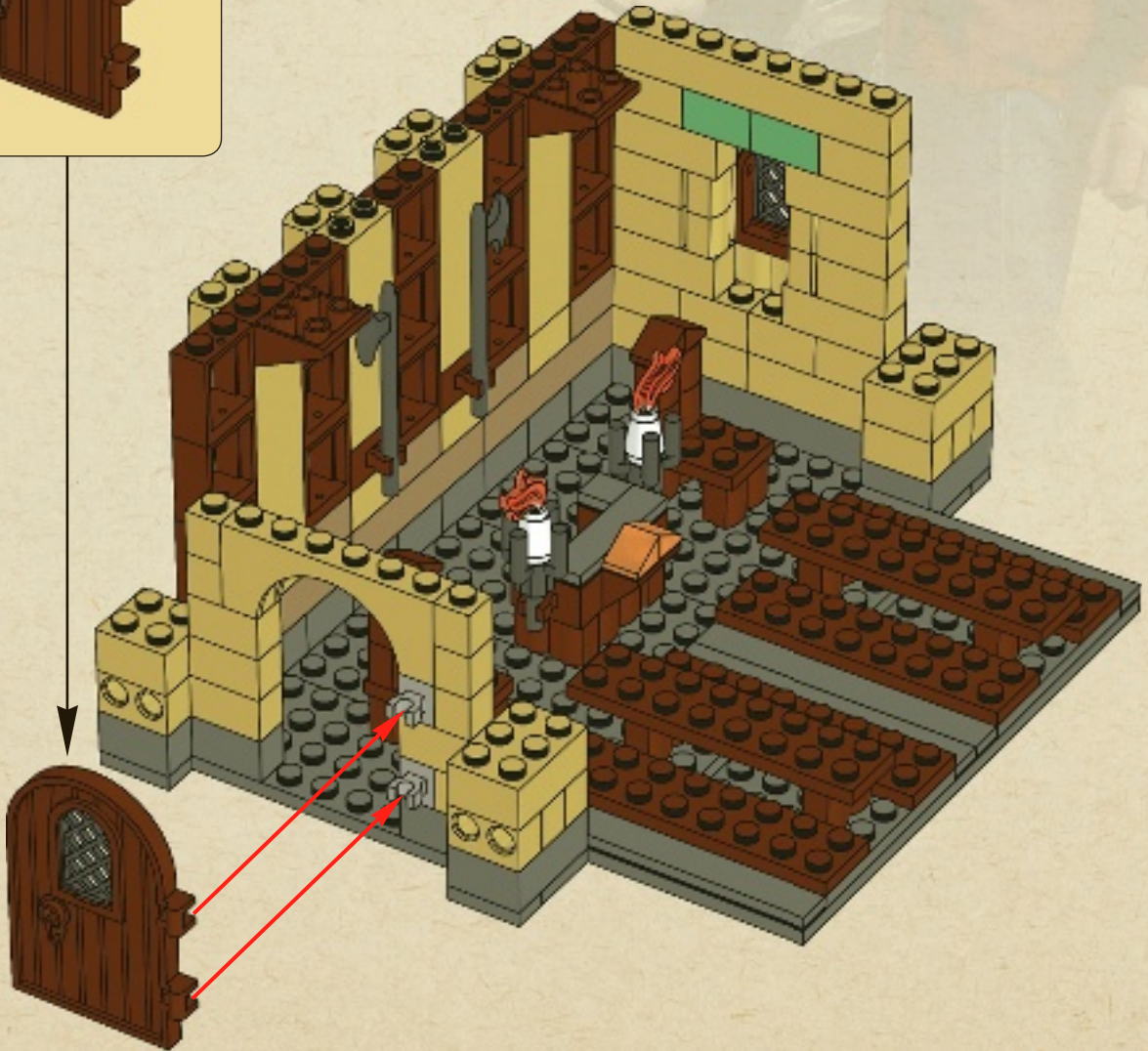





1x



2x

# 40

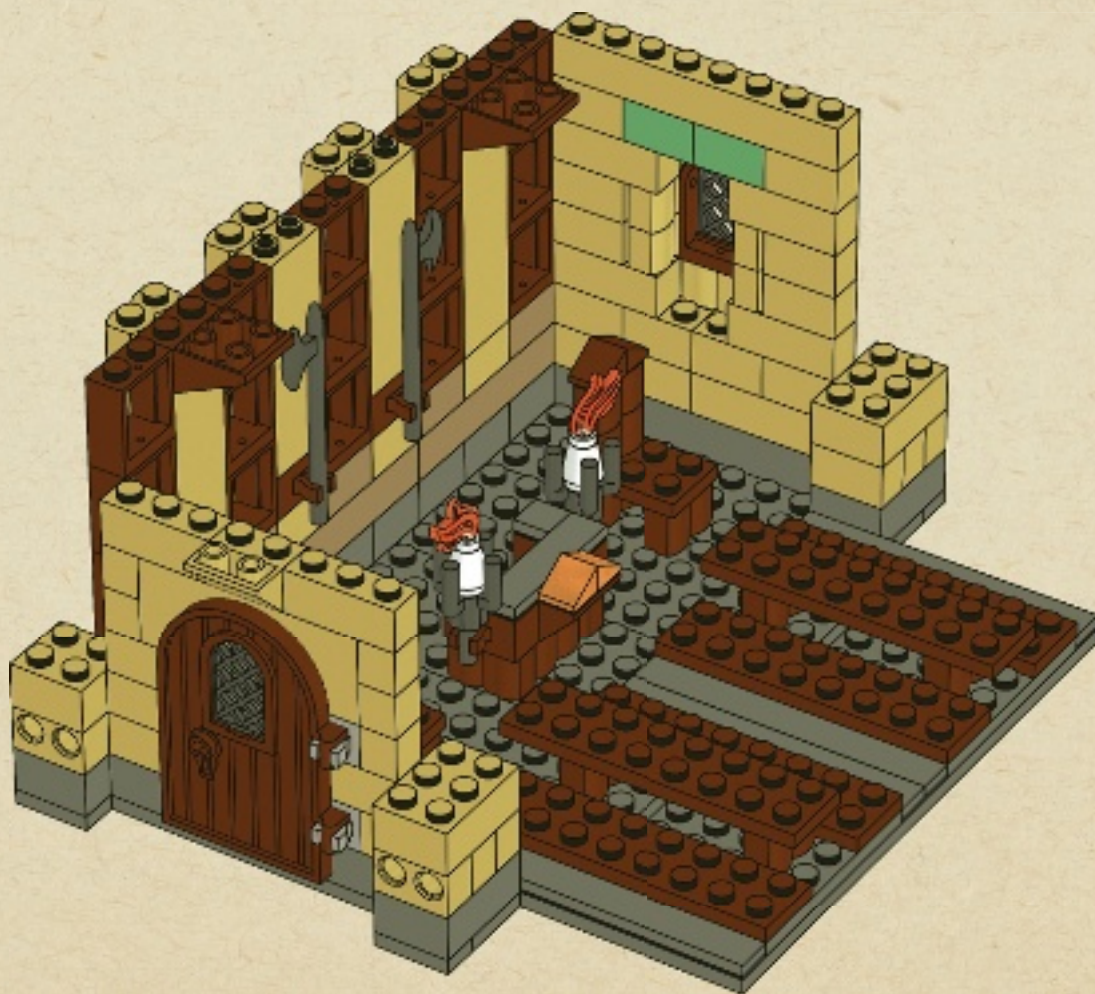



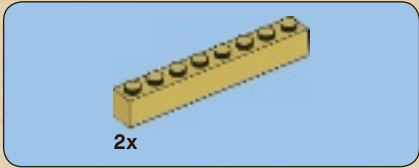

41

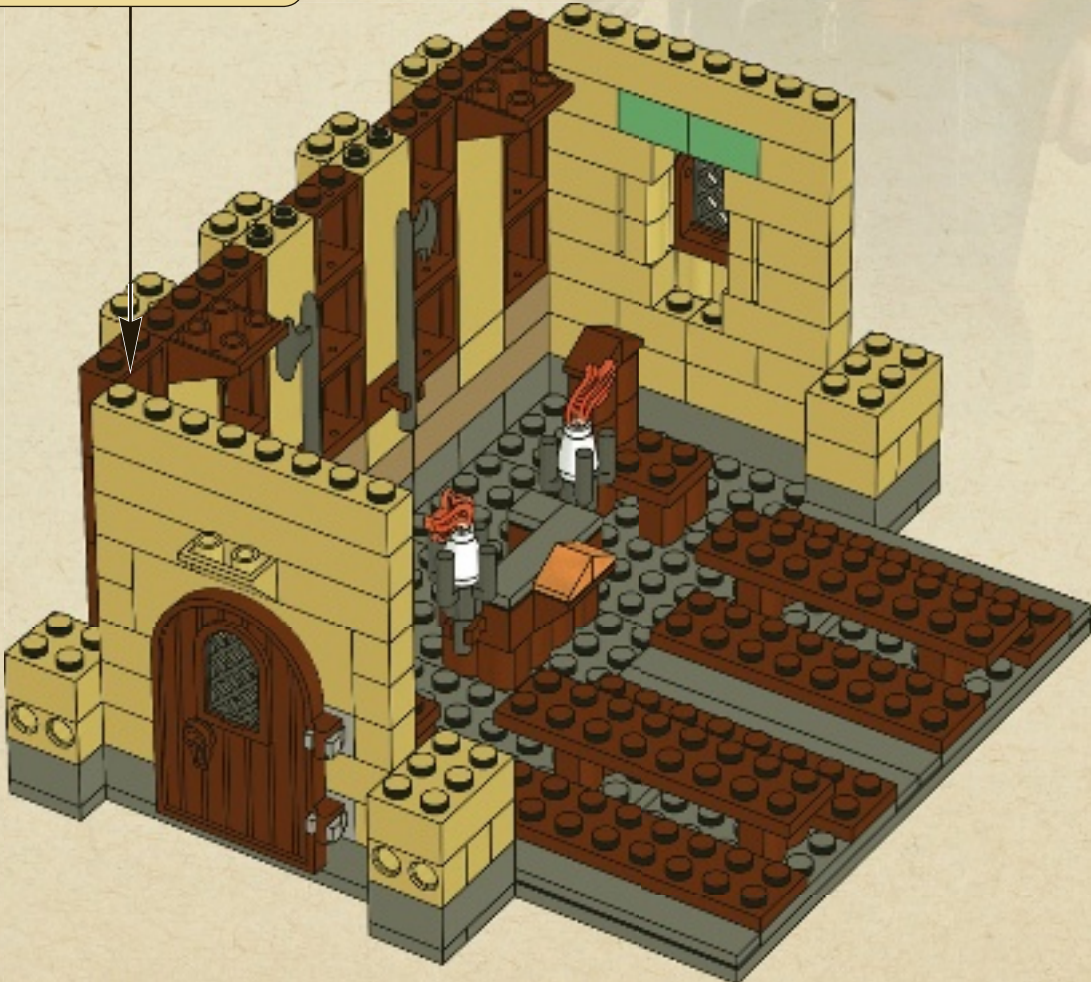
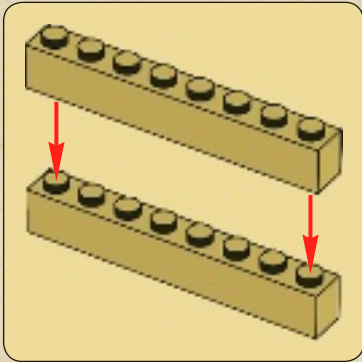





# 42

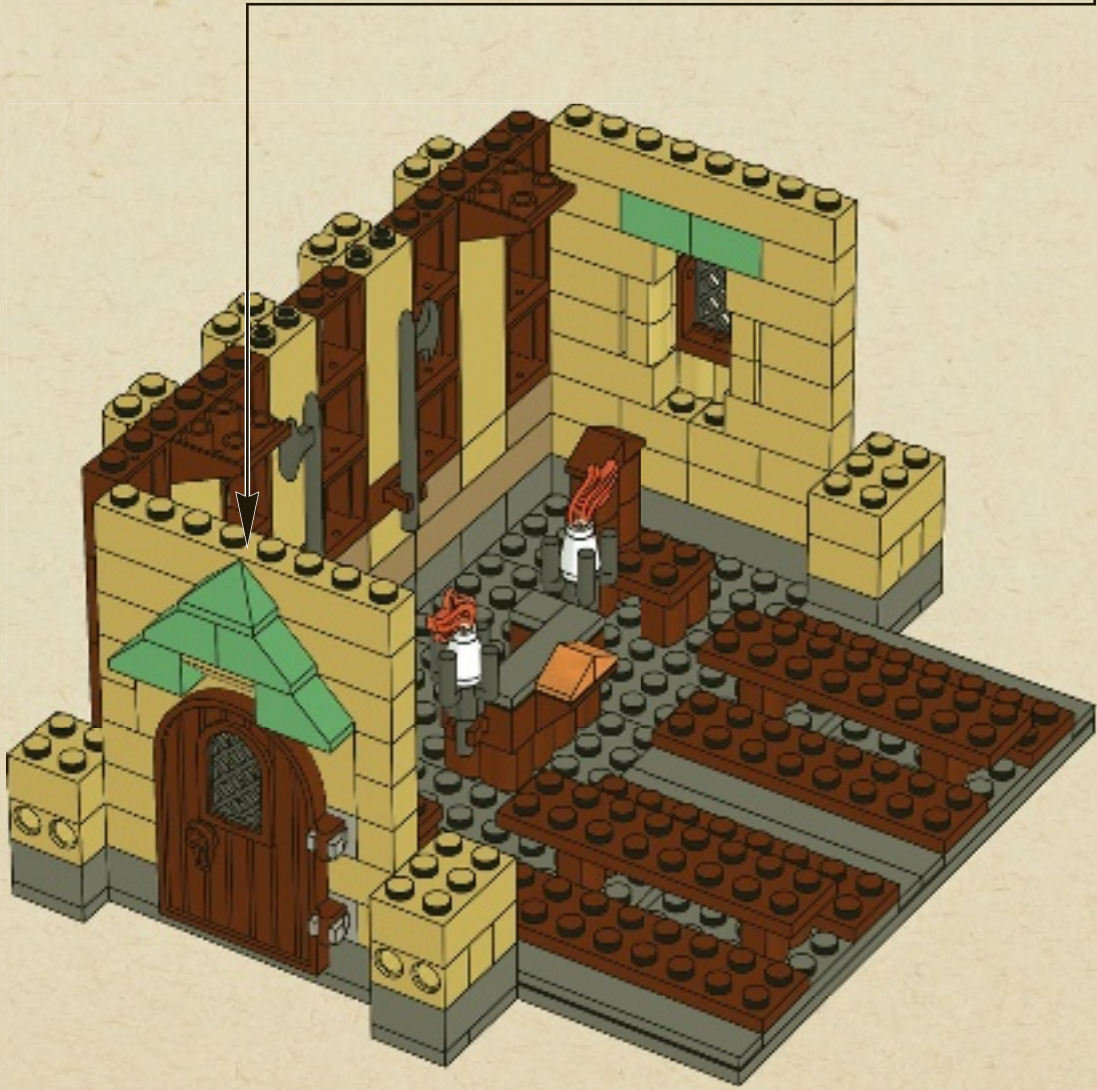
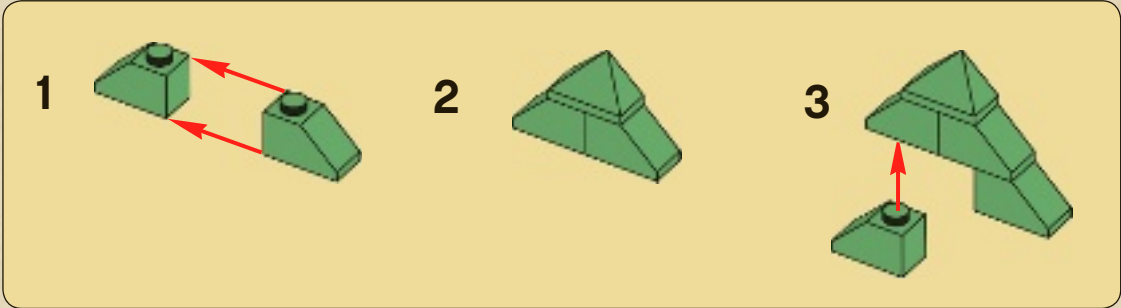



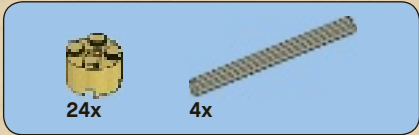

# 43

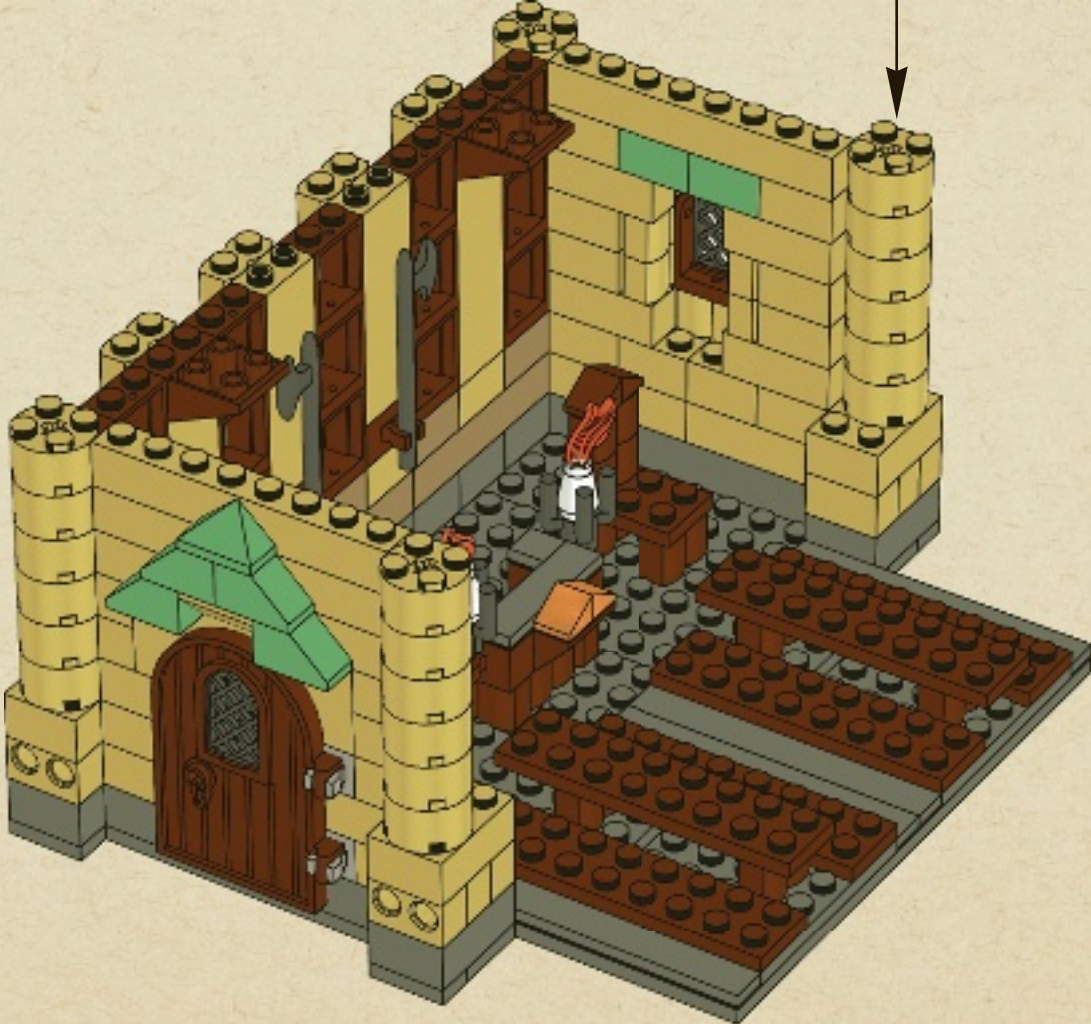
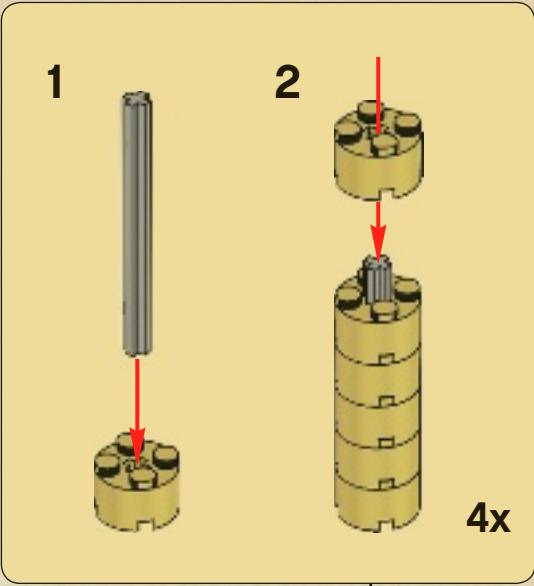





# 44

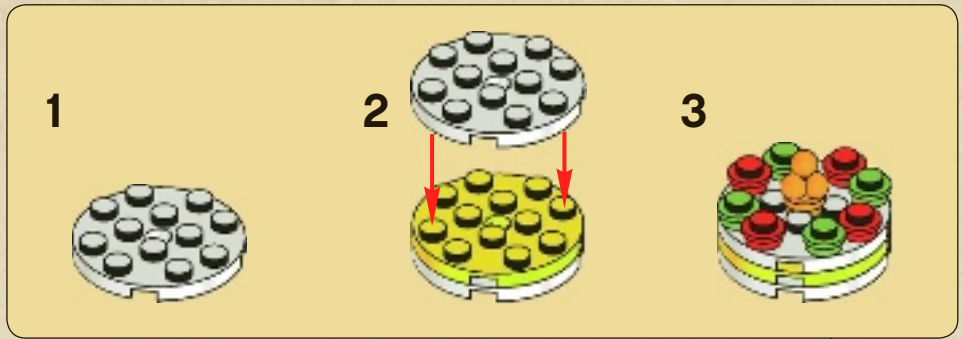



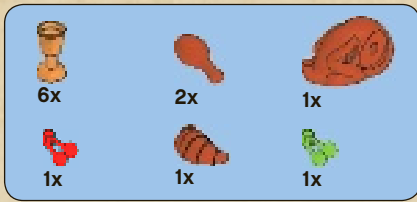

# 45

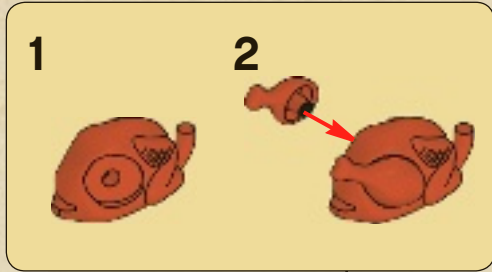





2x



5x

46





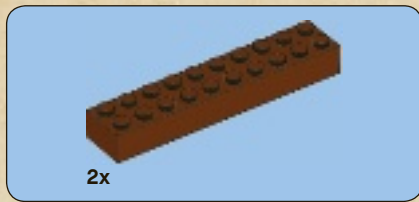

47





5x 5x

# 48

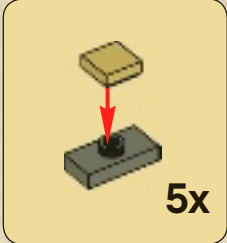





# 49

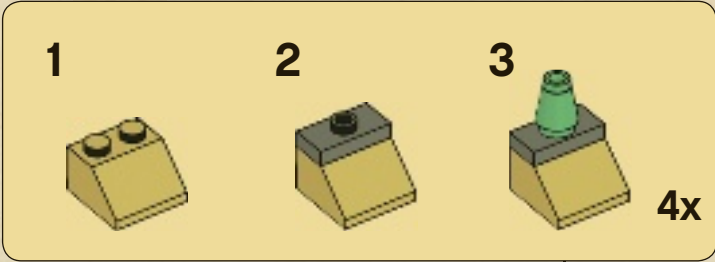





2x



2x

# 50

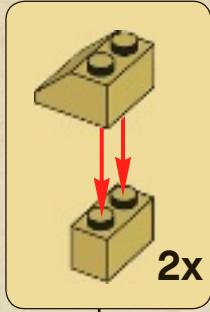



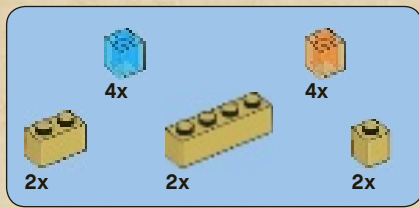

51







# 52







# 53

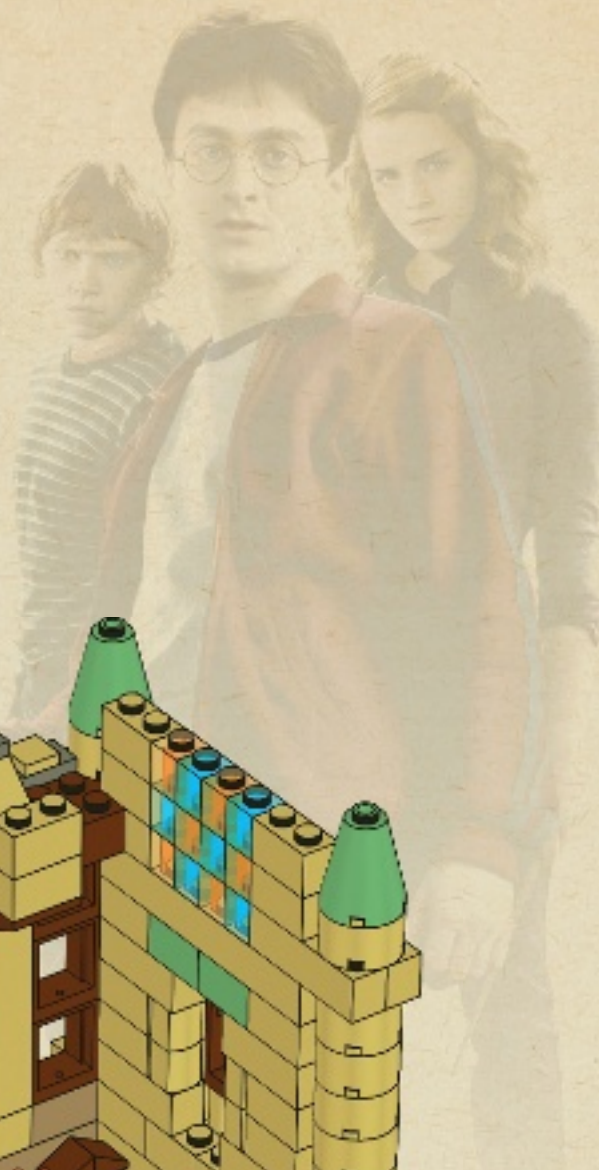





4x



2x



2x

# 54







2x

55







2x

# 56

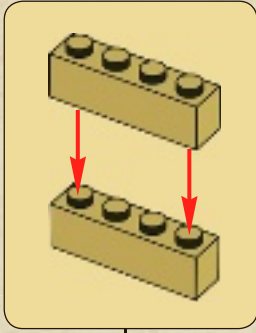



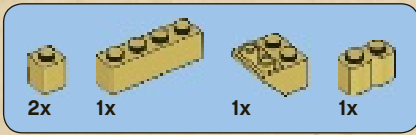

# 57

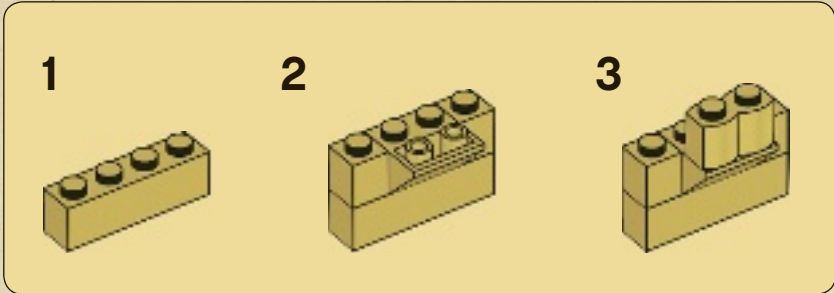



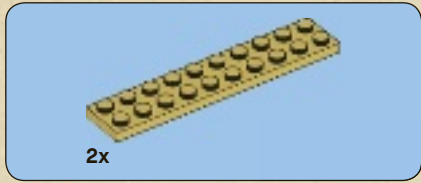

1

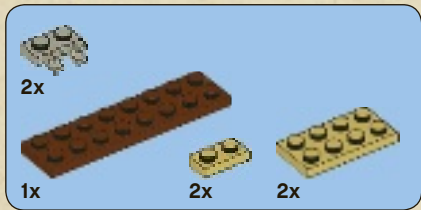
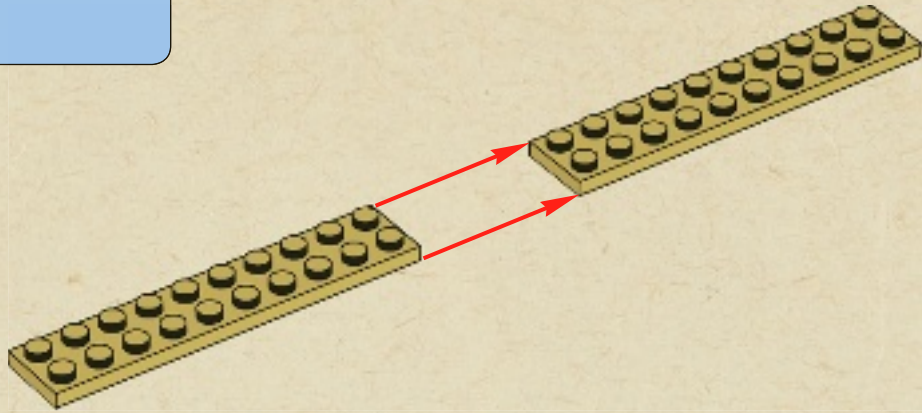

2

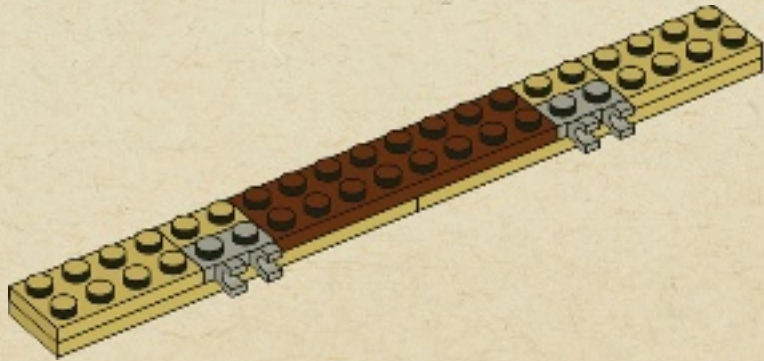



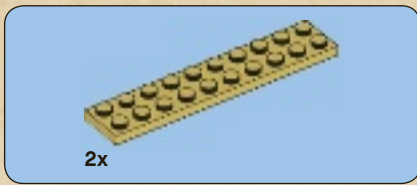

3

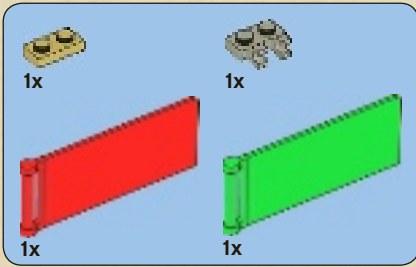
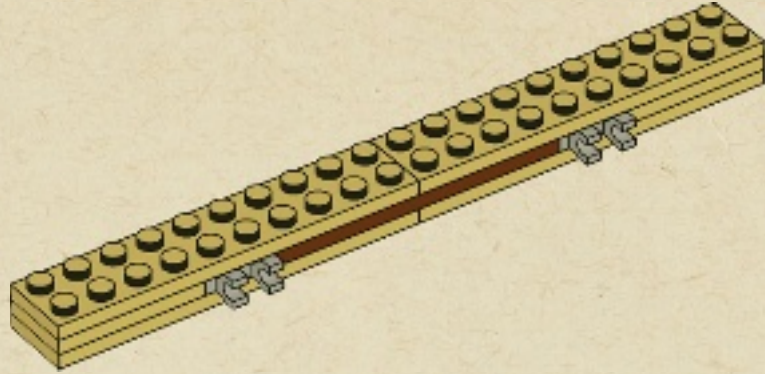

4

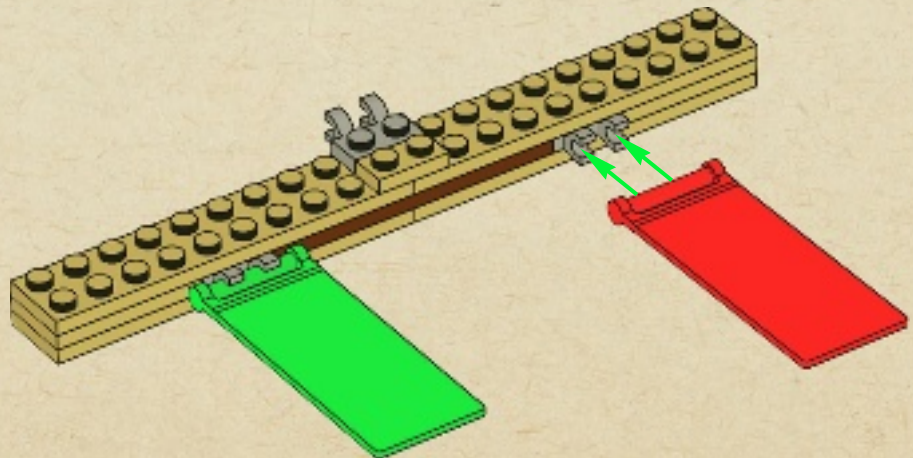



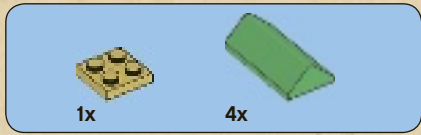

5

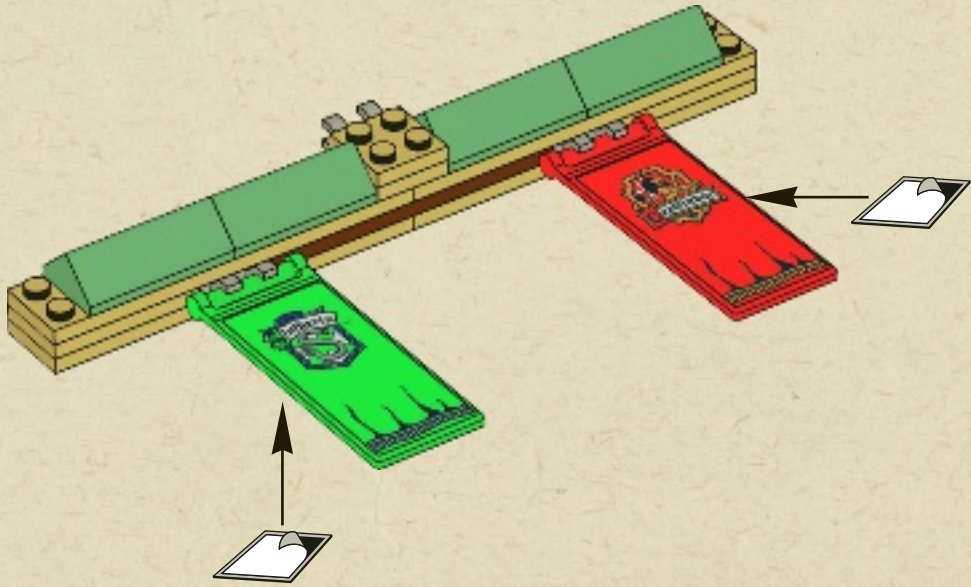



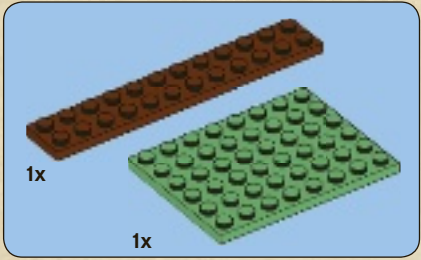
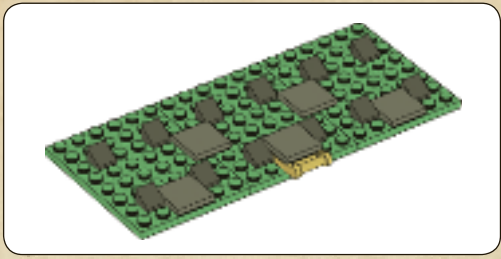

1

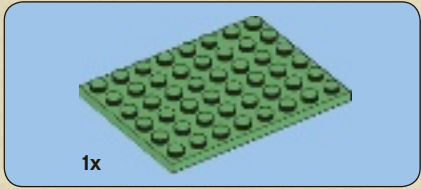
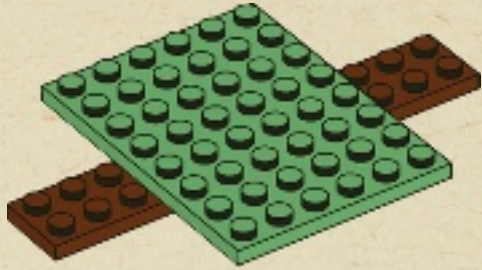

2

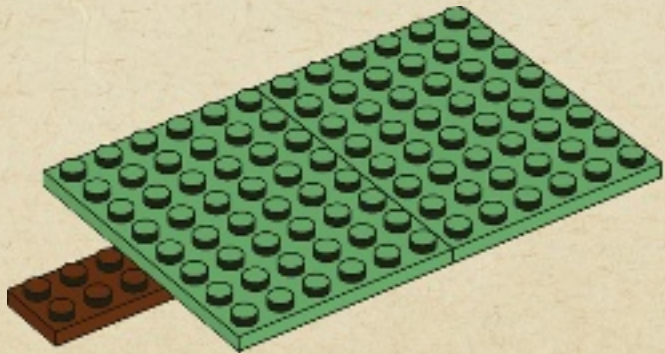



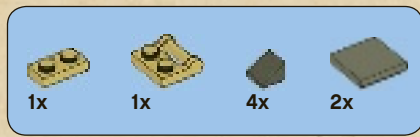

3

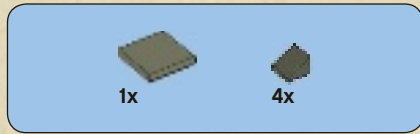
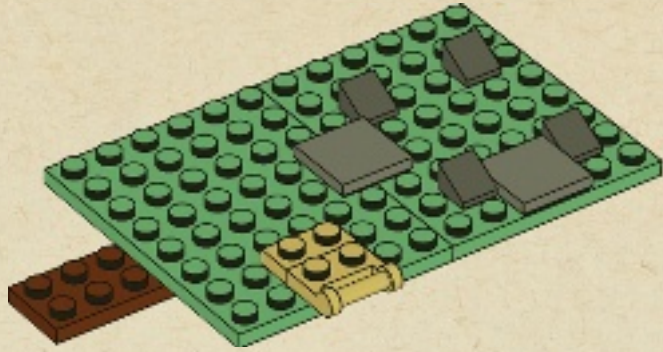

4

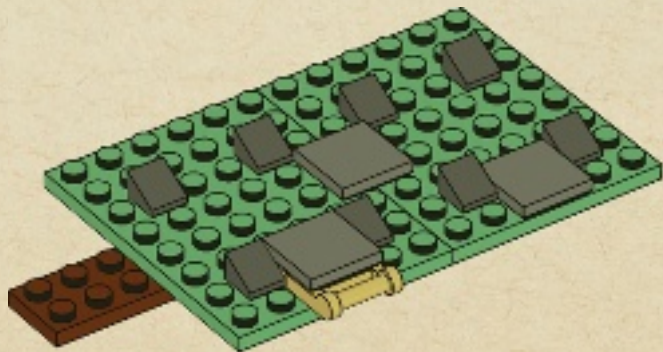



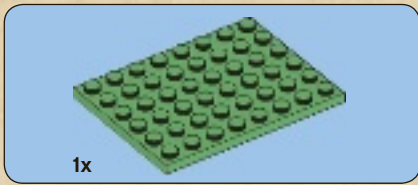

5

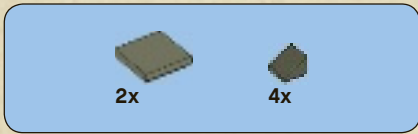
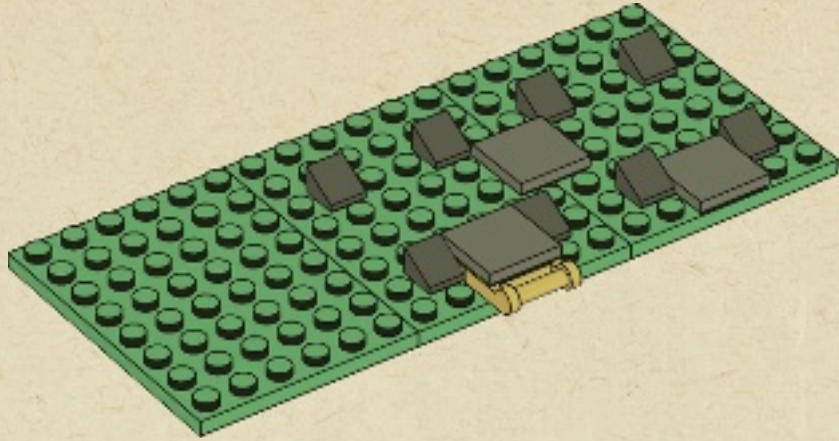

6

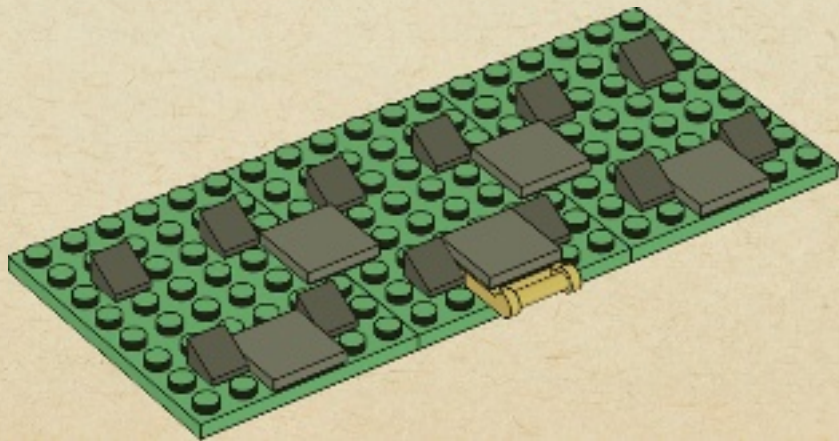



7

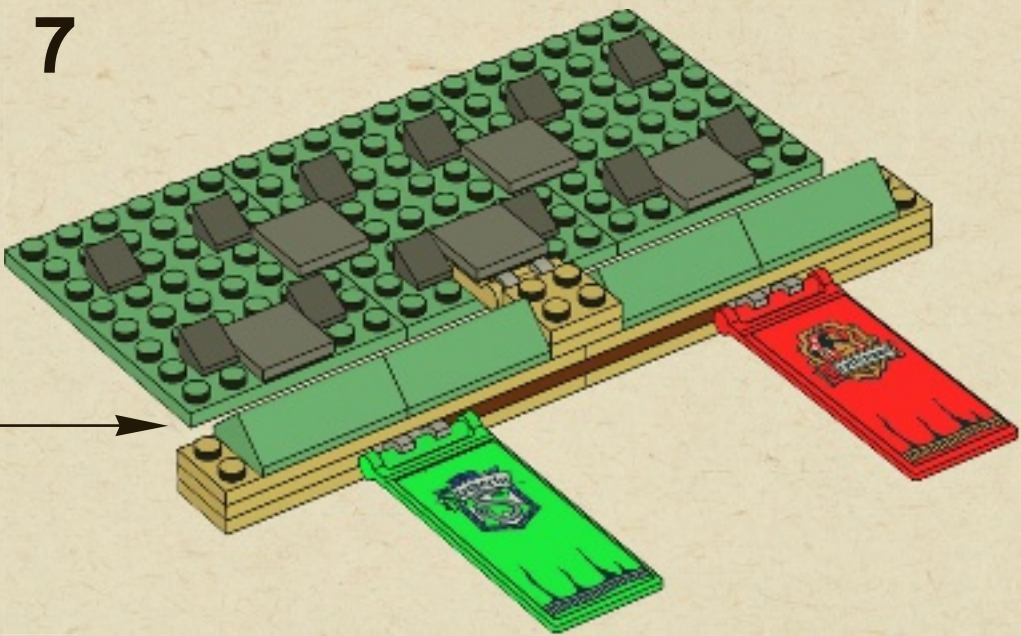



8

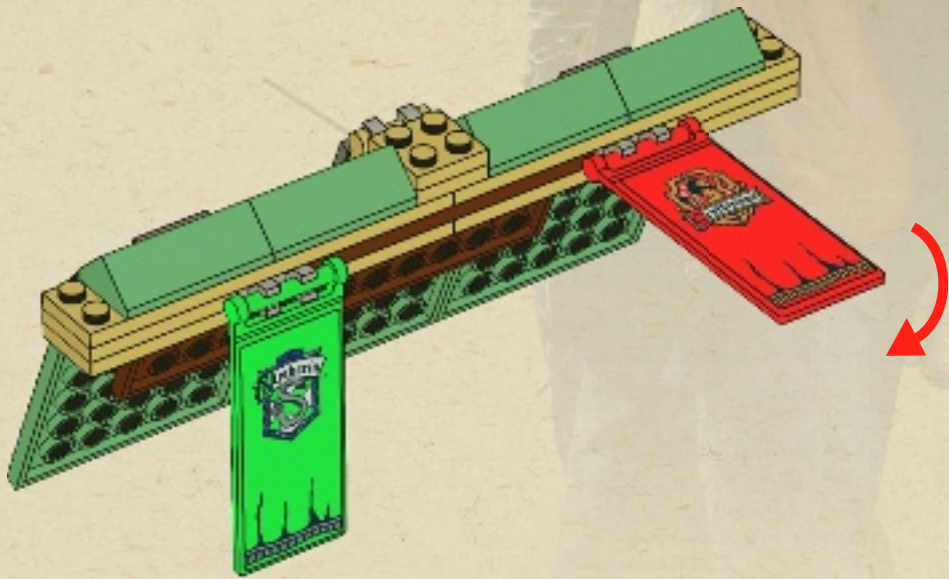



58







# 59

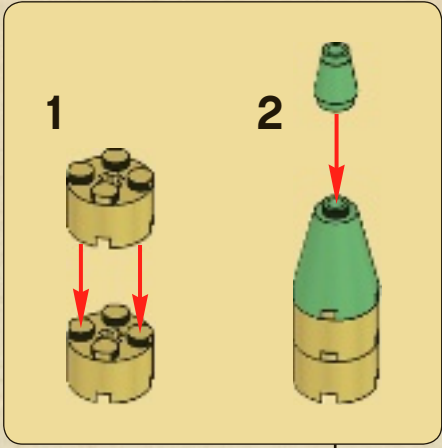



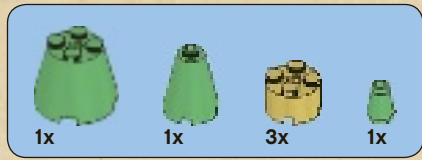

60

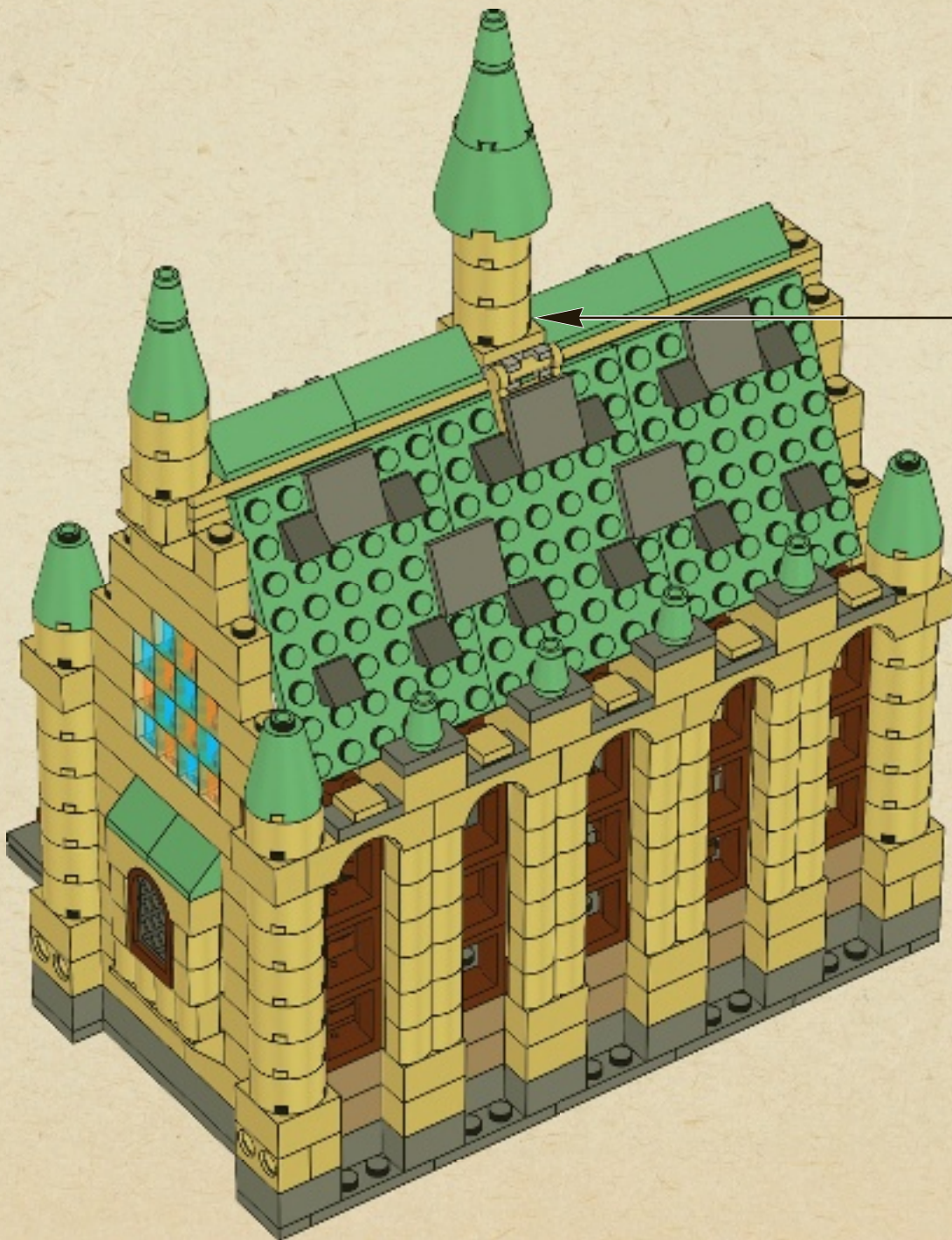
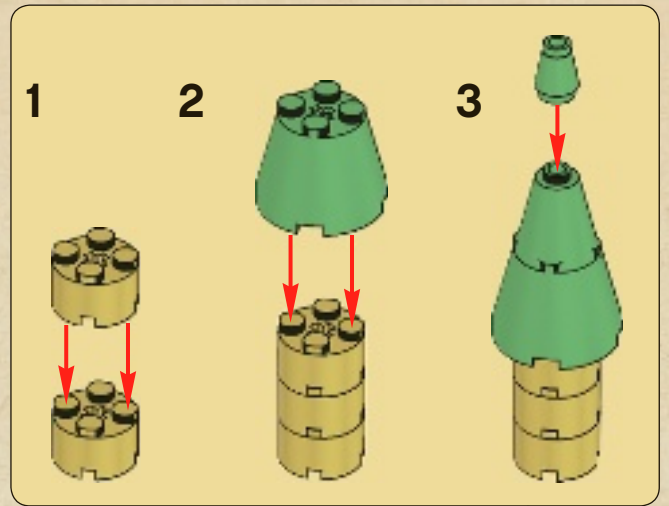





61

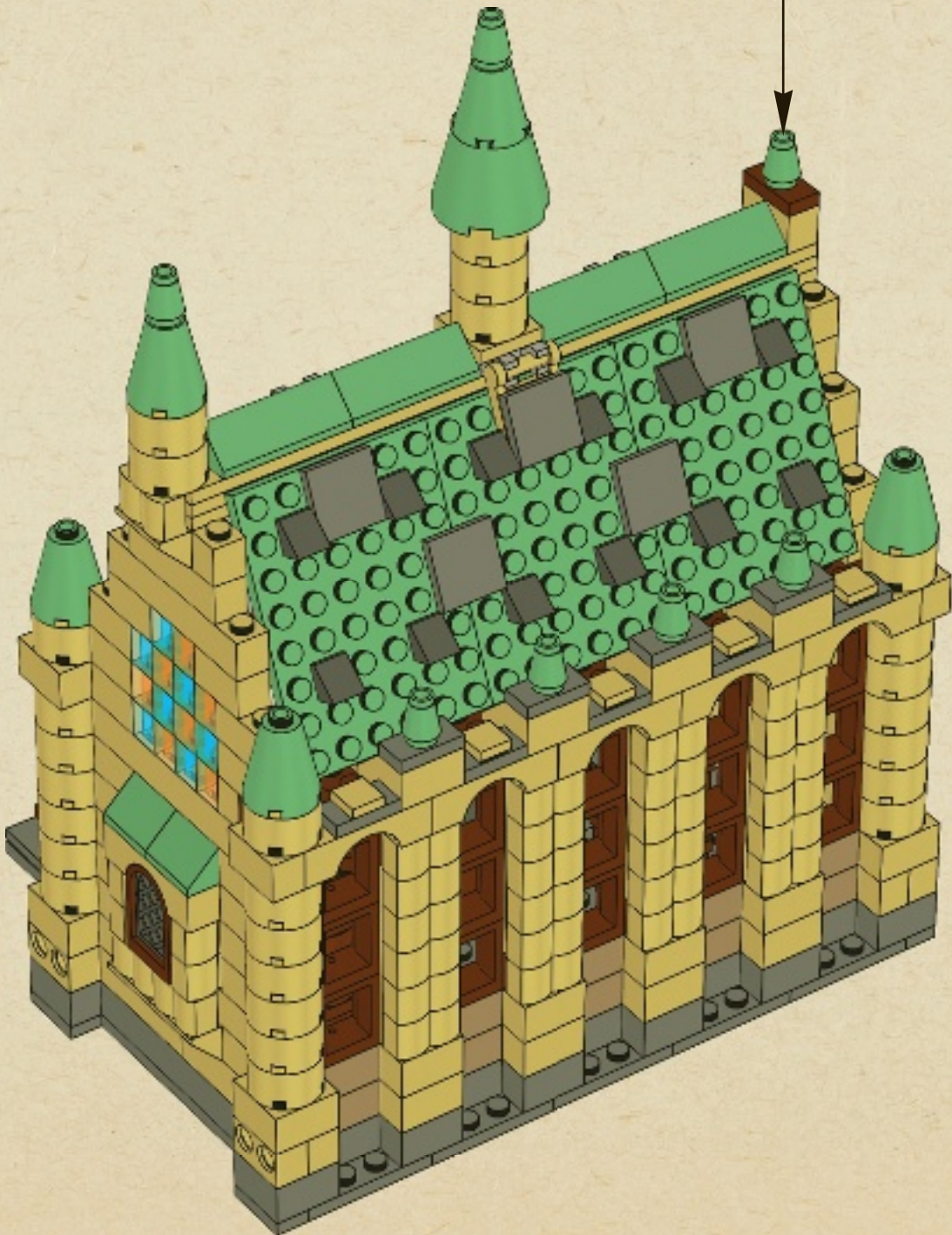
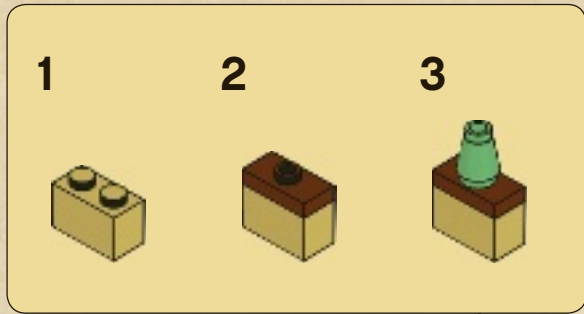





1



2

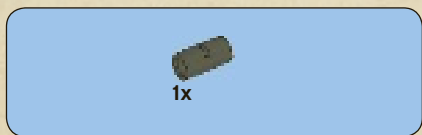

3



4

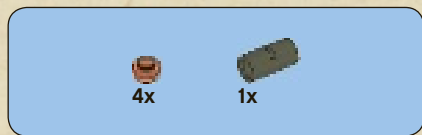
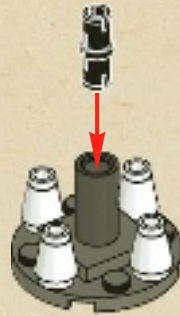

5



6





62





63

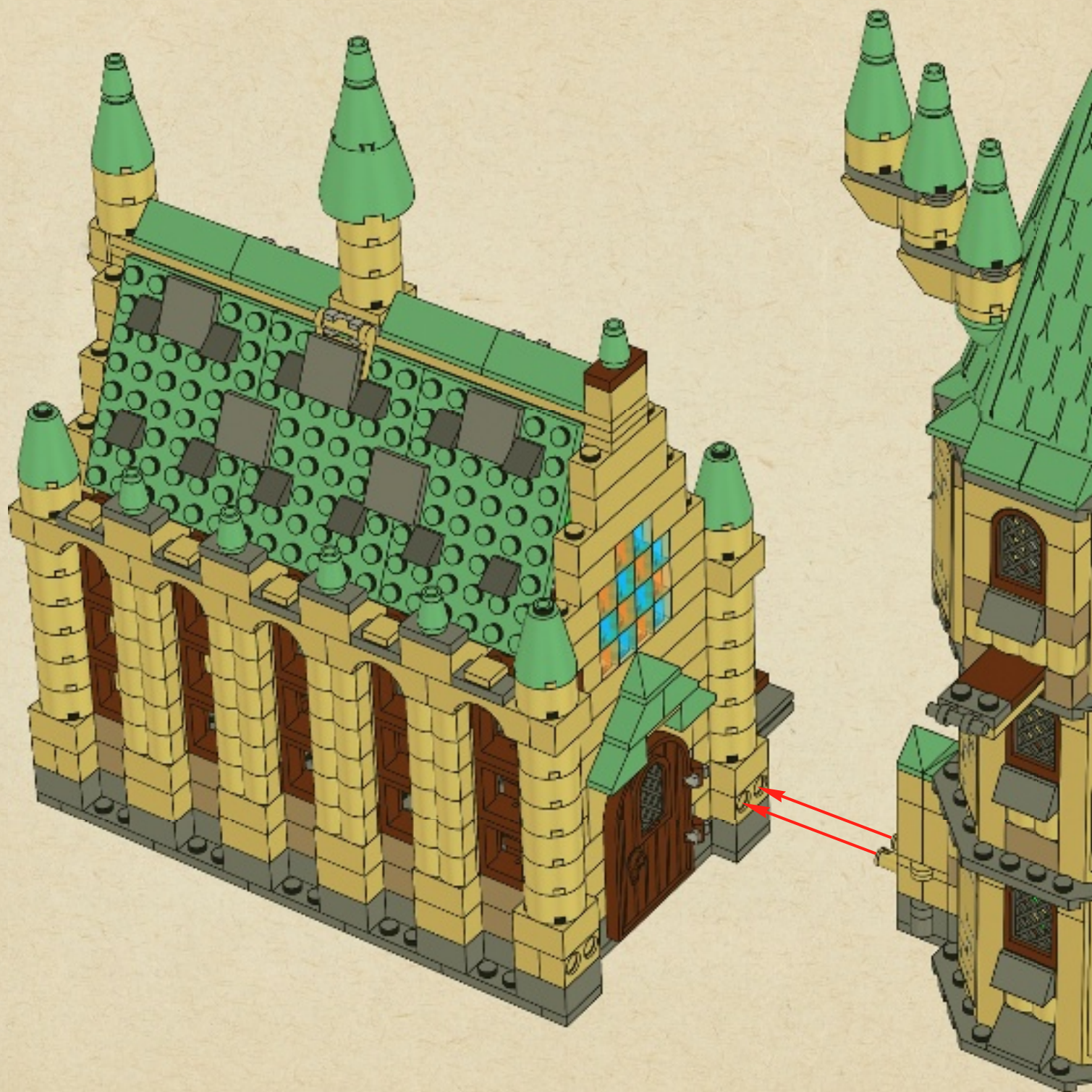







64

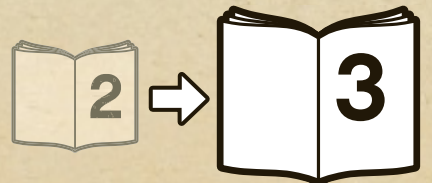





# Harry Potter™ HOGWARTS™



3862  
Harry Potter™ Hogwarts™

    
2-4 8+ 20-40







# Harry Potter







# ATLANTIS



8078



8077



8076



**FREE! GRATIS! GRATUIT!**



**club**  
MAGAZINE™

**www.LEGOclub.com**



**00800 5346 5555\***

**1-866-534-6258 • 1-877-518-5346**

US & Canada only

Canada seulement

\* FreePhone. Mobile charges may apply. \* Numéro sans Frais. Des Frais peuvent s'appliquer avec les téléphones cellulaires. \* Gebührenfrei, Kosten für Anrufe aus Mobilfunknetzen können abweichen. \* Gratis telefoonnummer vanaf vaste lijn. \* Deel of één gratis nummer, niet de ringer Free PostTelefon. \* Deel of gratis, niet de ringer Free en Post Telefon.



**VISIT THE WORLD'S  
BIGGEST LEGO® SHOP!**

**www.LEGOshop.com**



**www.LEGO.com**