

The LEGO logo is displayed in its characteristic white, bold, sans-serif font with a black outline, set against a red square background.

DINO

The word "DINO" is written in large, yellow, 3D block letters with a black outline and a cracked texture. The letter "O" is replaced by a green dinosaur head with its mouth open, showing sharp teeth.

5883



WARNING: CHOKING HAZARD.
Toy contains small parts and a small ball.
Not for children under 3 years.



1

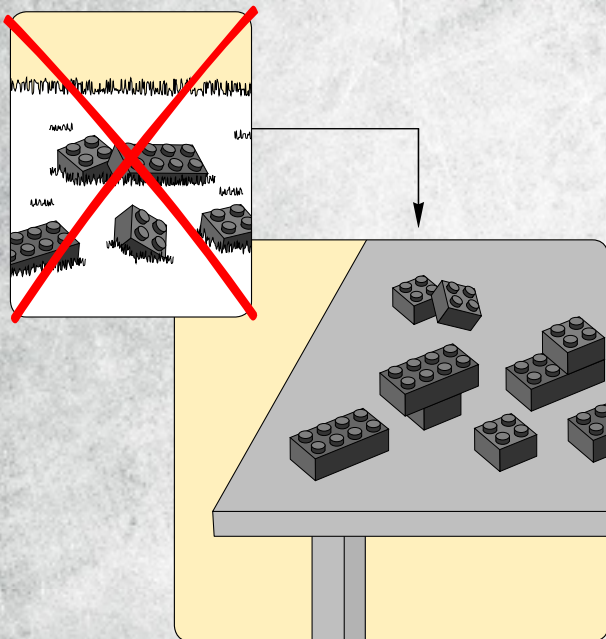

2

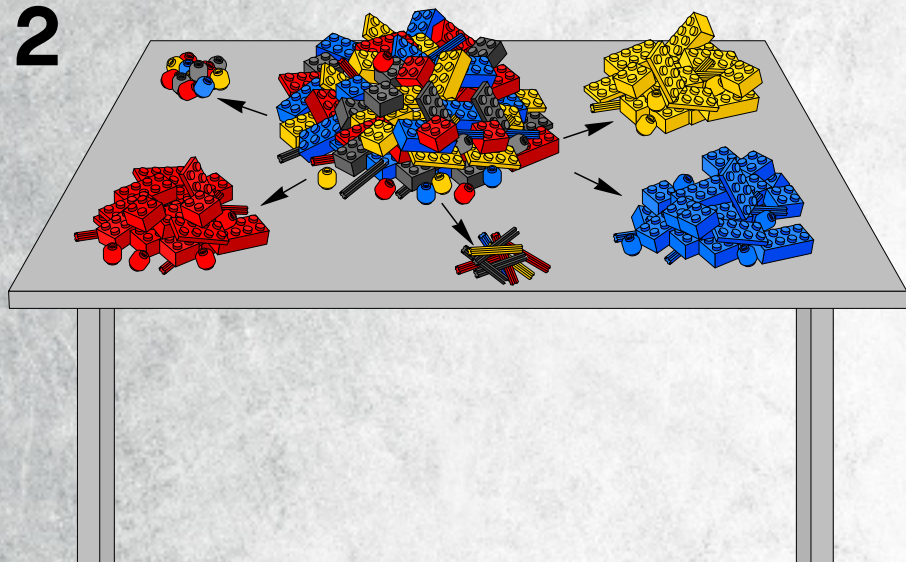

AVERTISSEMENT : RISQUE D'ÉTOUFFEMENT.

Le jouet contient des petites pièces ainsi qu'une petite boule.
Il ne convient pas aux enfants de moins de 3 ans.



ADVERTENCIA: PELIGRO DE ASFIXIA.

Juguete que contiene partes pequeñas y una pelota pequeña.
No recomendado para niños menores de 3 años.

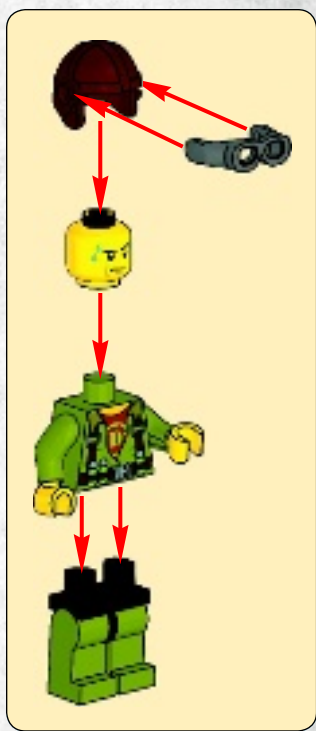



1x

1



1x

1x

2





1x

3

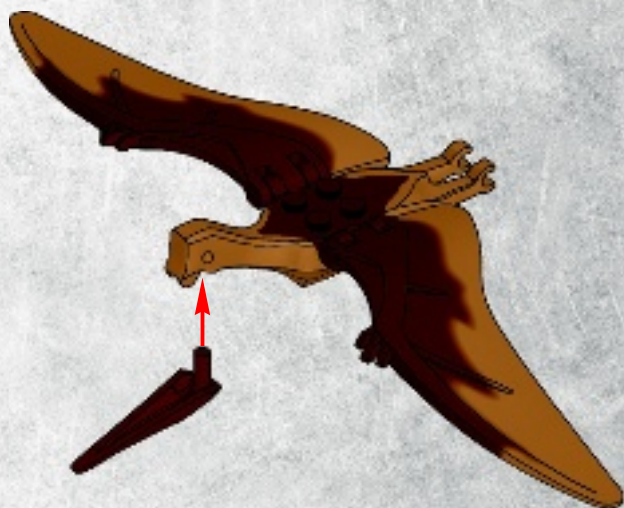

1x

4



5

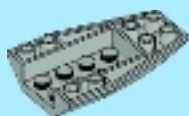

1x



1x

1

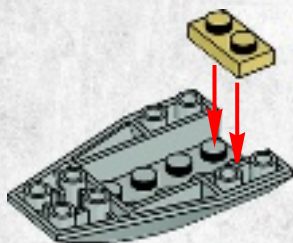

2x



1x

2





1x



2x

3

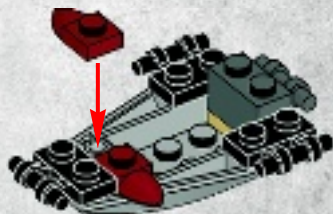

1x



1x

4





1x



1x



1x

5

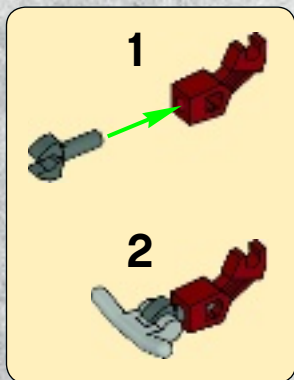

6





1

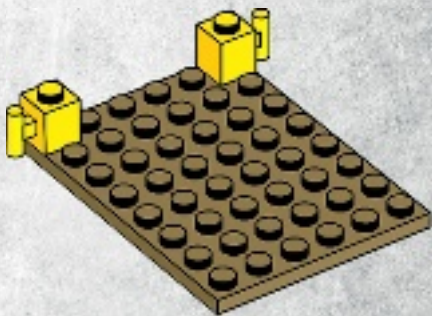



2x



2x

2

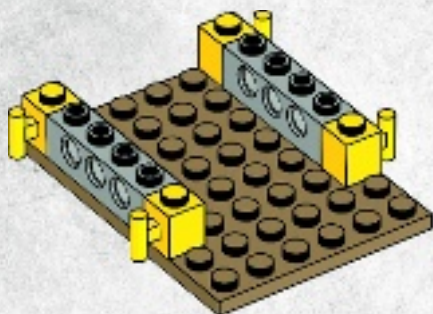

1x



1x

3

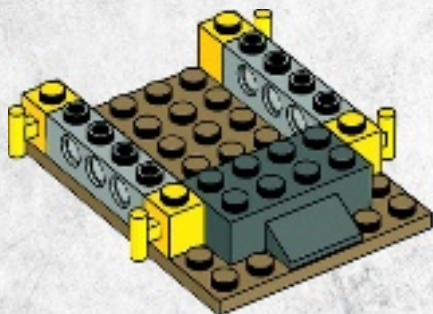



6x

4

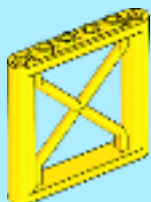
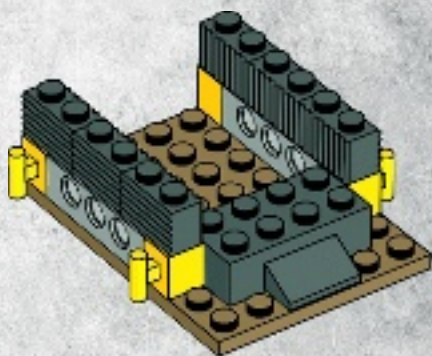

2x

5

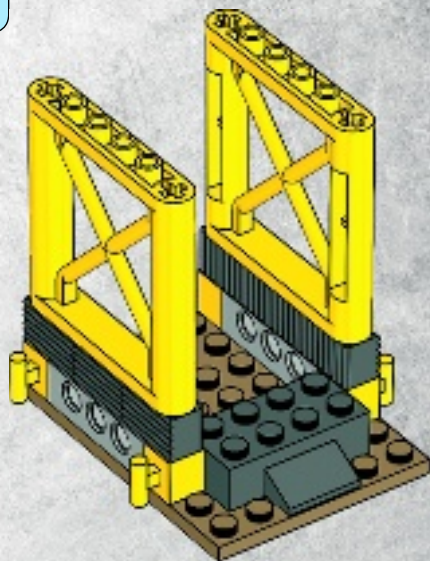



1x

6

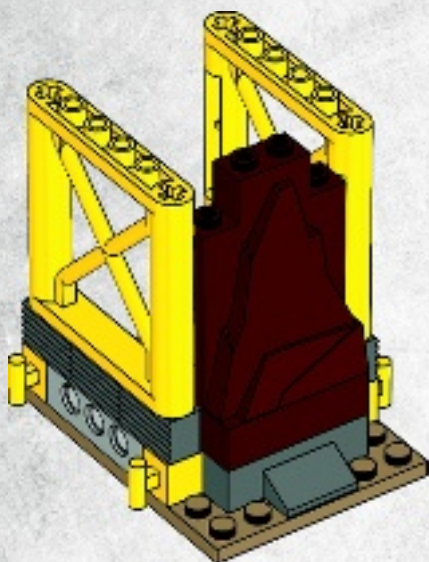

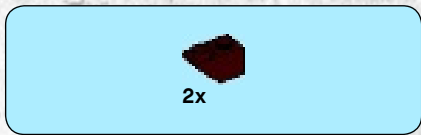

7

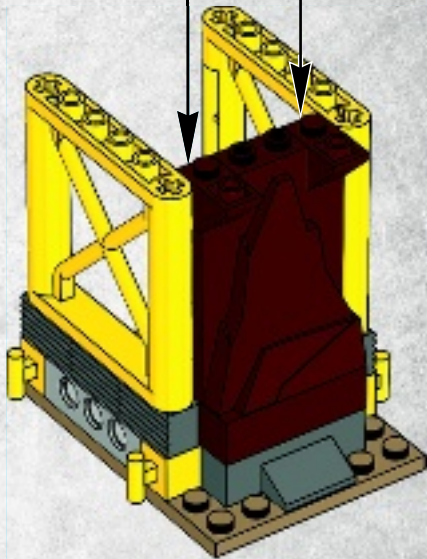
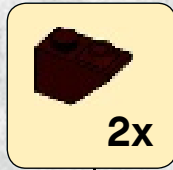



1x

8

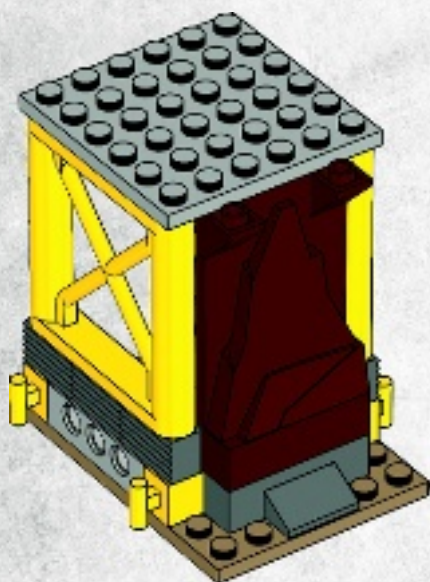



1x



1x

9

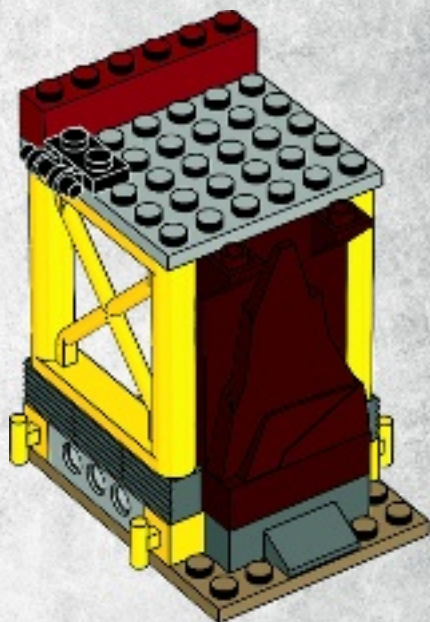



2x

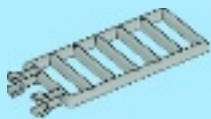

1x

10

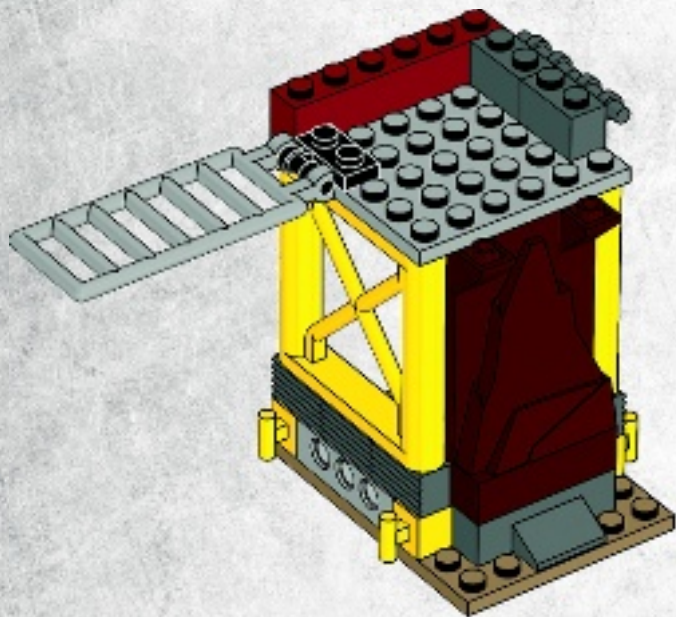



2x



2x

11





2x



1x

12



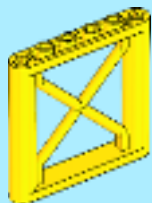

1x

13





1x



2x

14

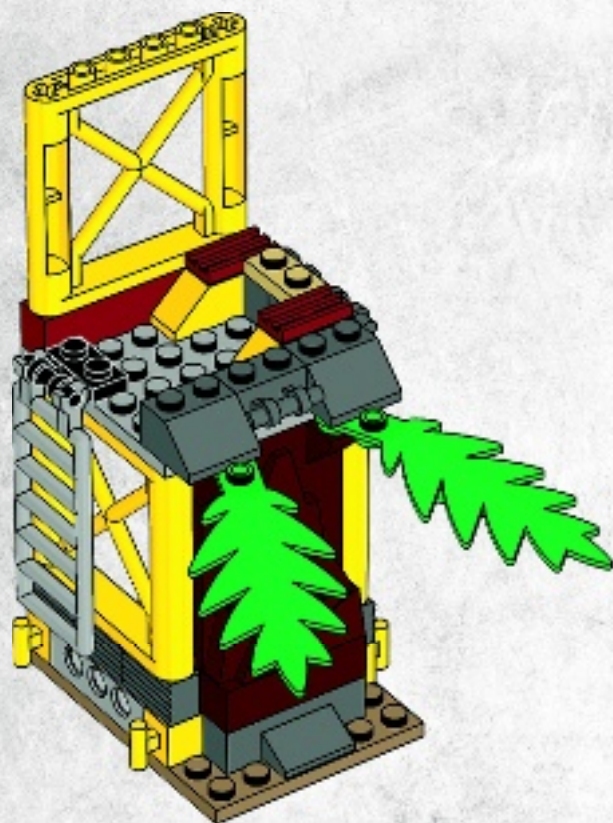



1x



1x



1x

15

1

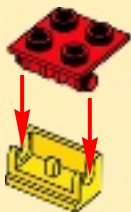

2



3

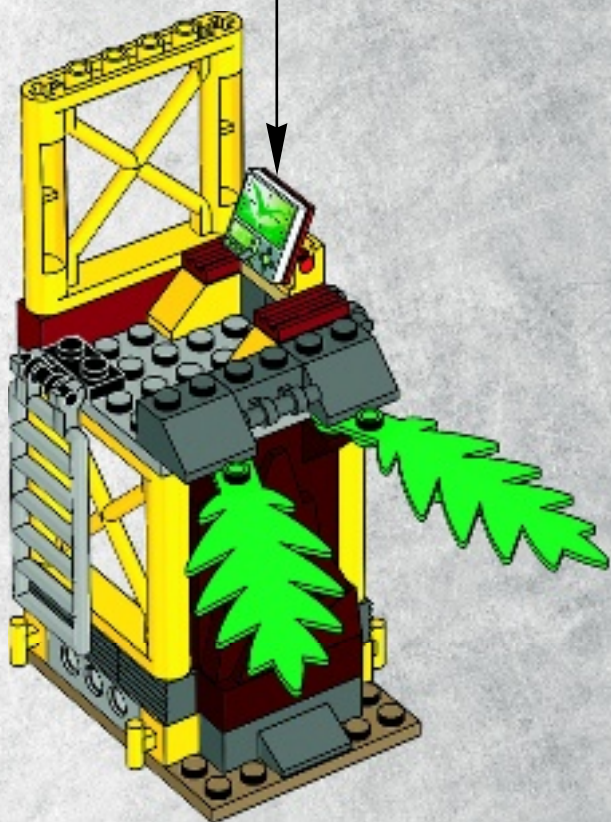

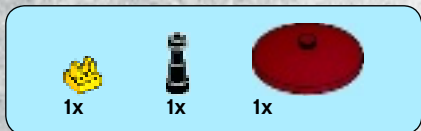

16

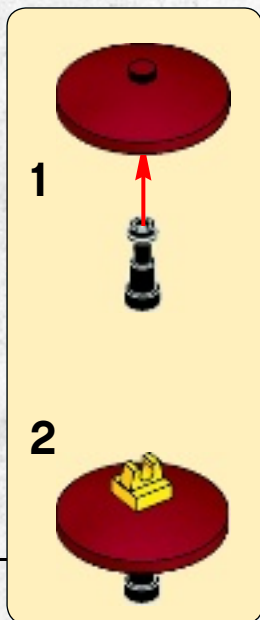
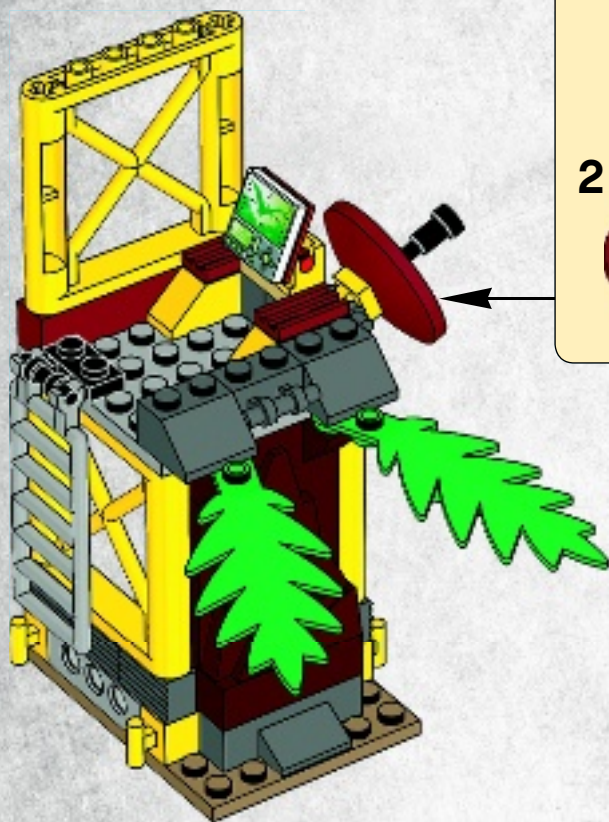

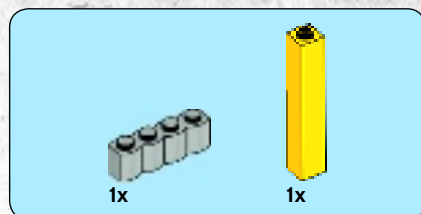

17

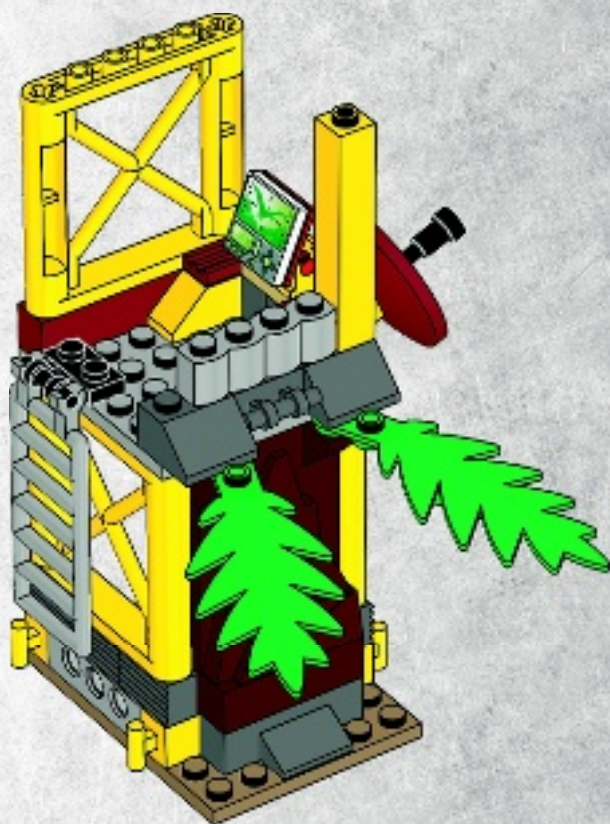

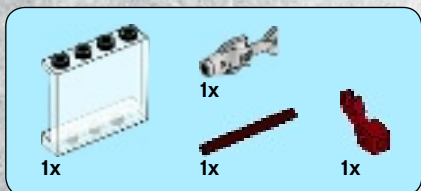

18

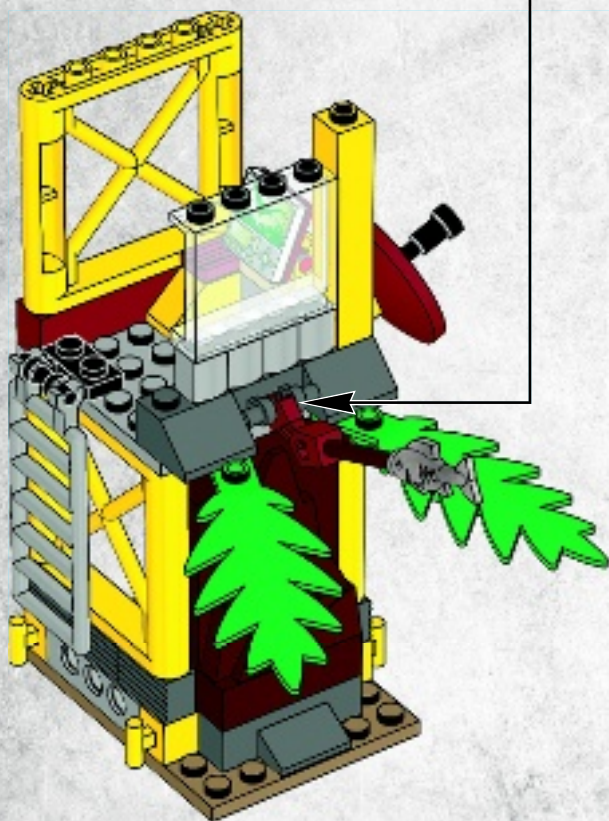
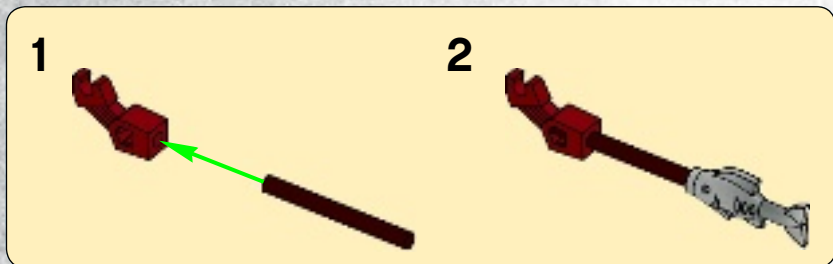

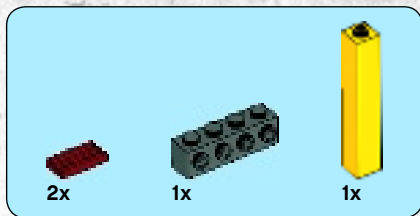

19

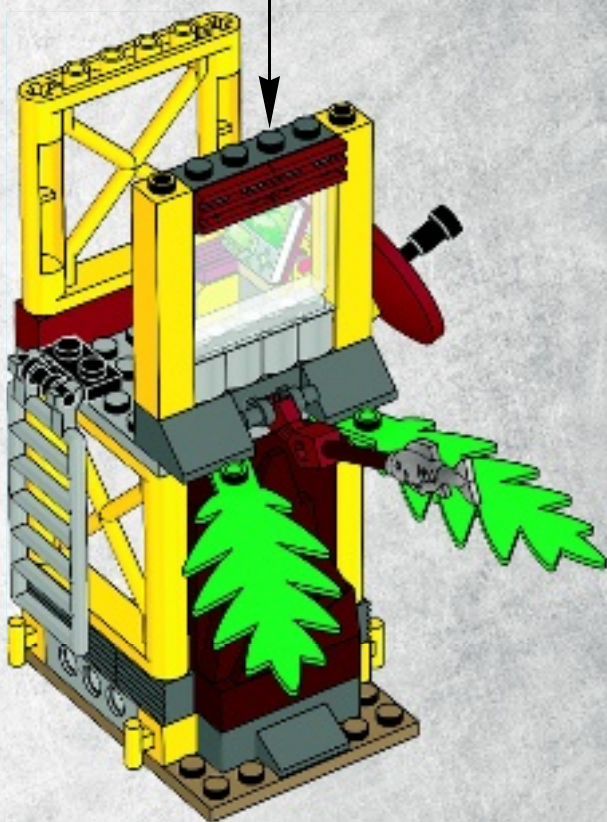
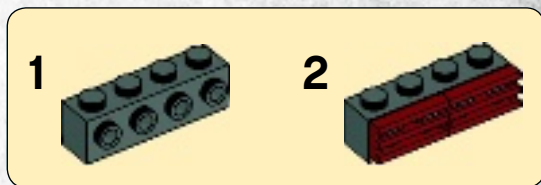



1x

20





4x



1x

21

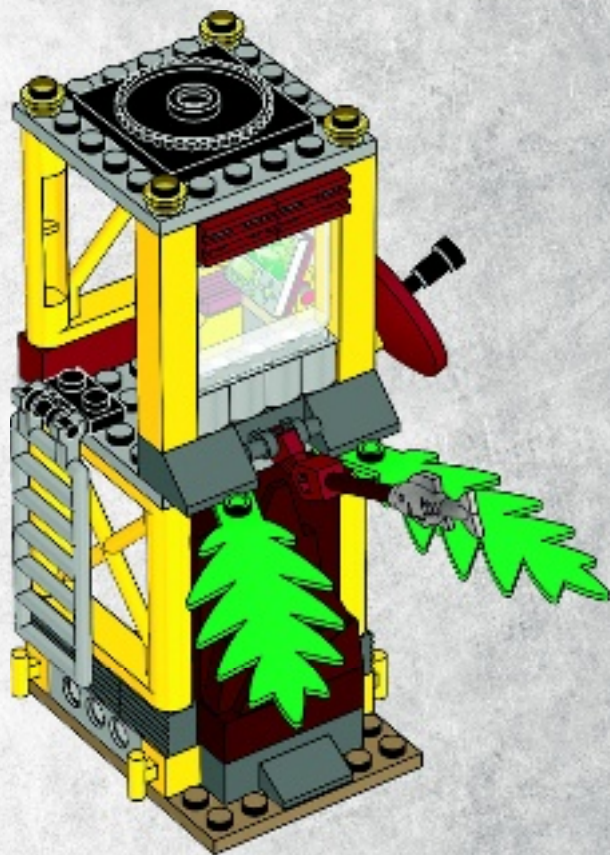



1x

1



1x

2





1x



2x

3



1x



2x



2x

4





1x



2x

5

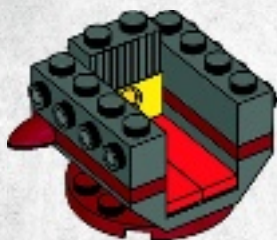

1x

6





7

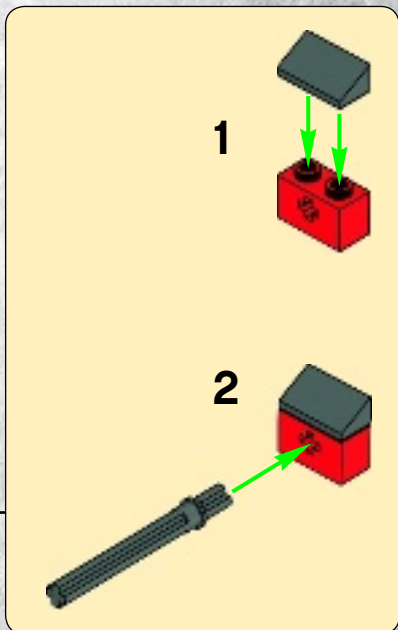
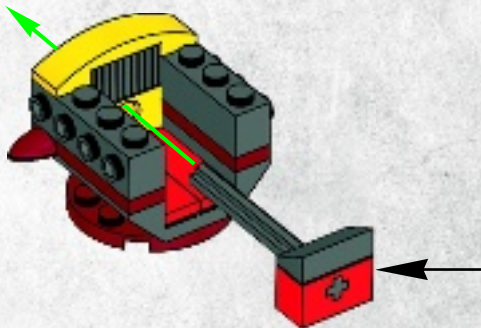

8

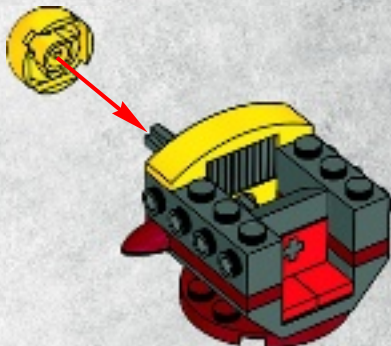



2x

9

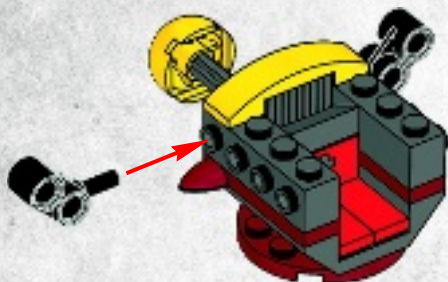

4x

10

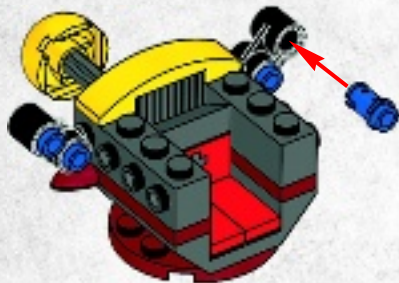



2x



2x

11

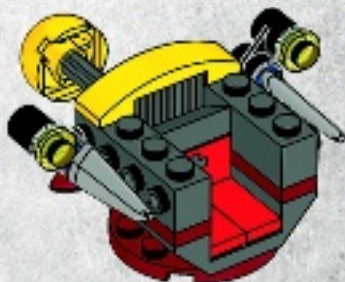

3x

12

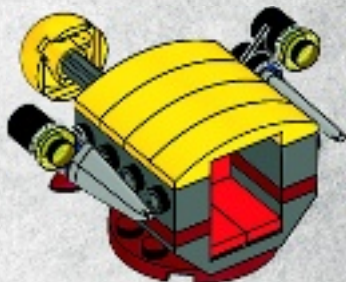

22



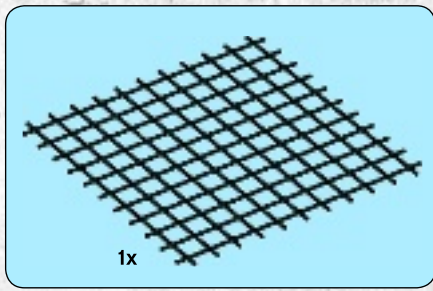

23

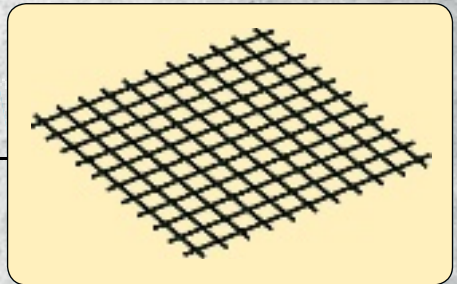
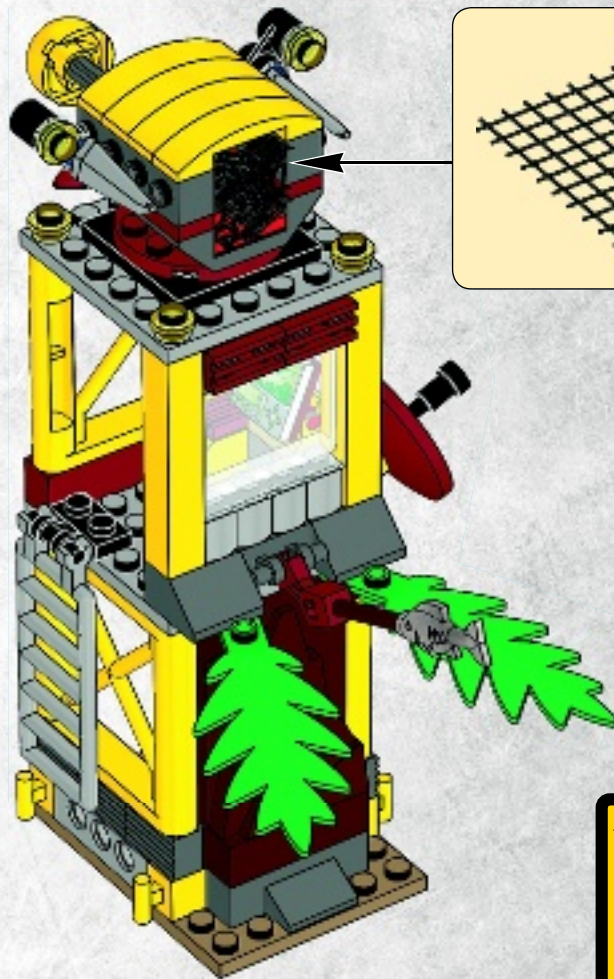

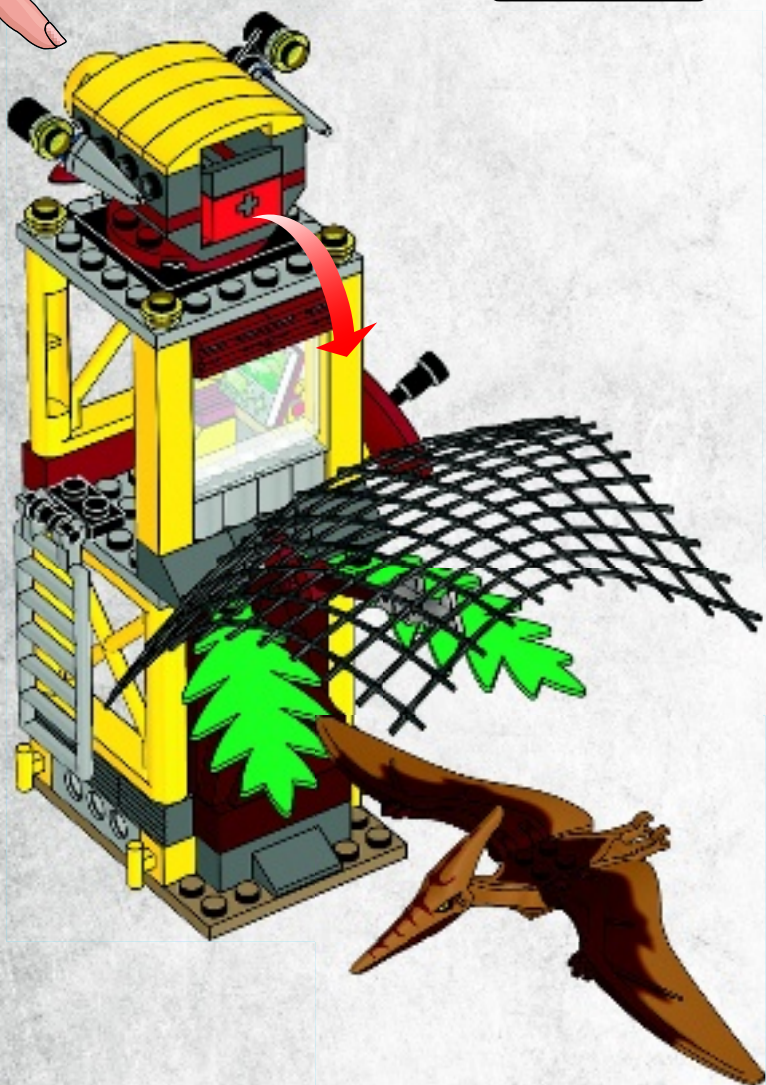
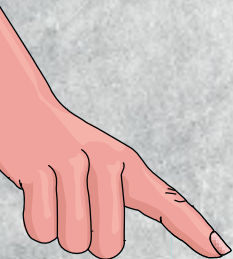

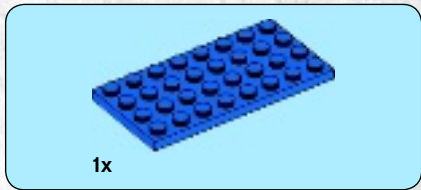

1

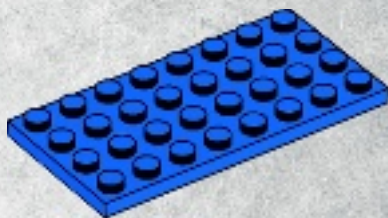

2

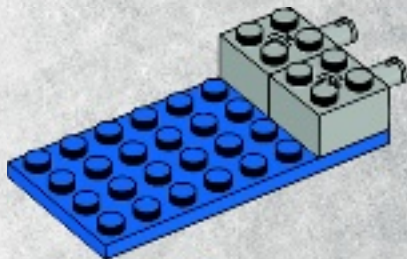

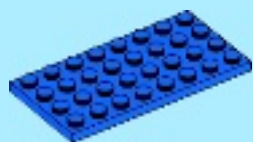

1x

3

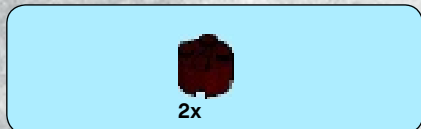
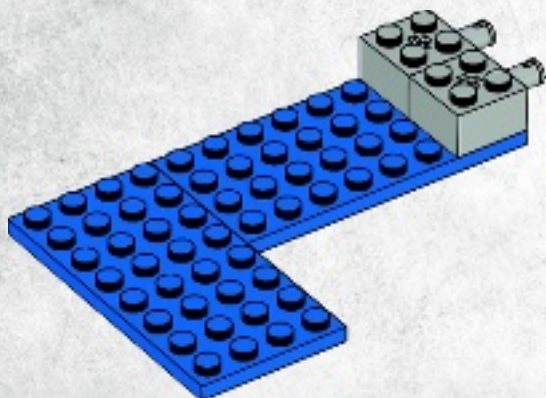

2x

4

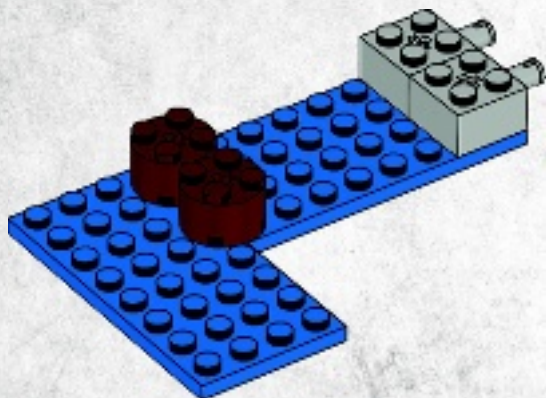



3x

5

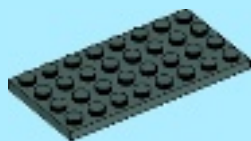
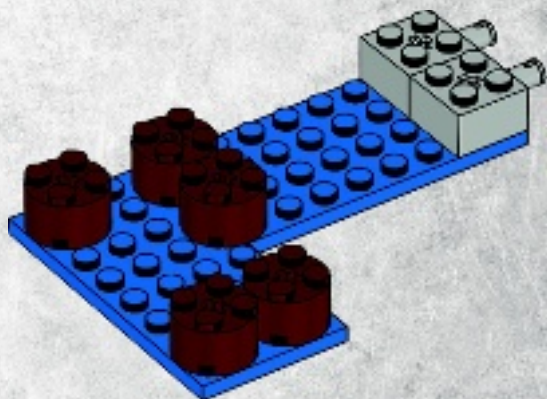

2x

6

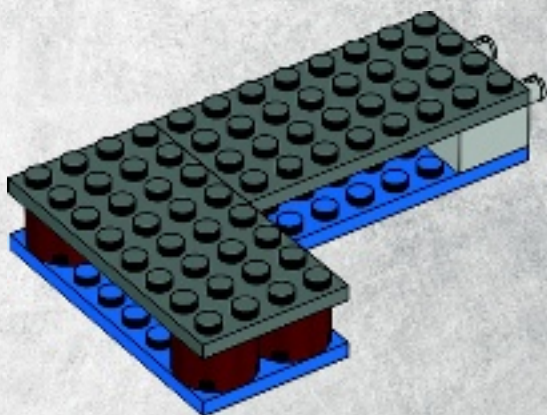

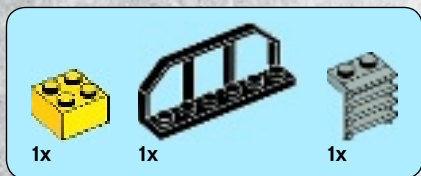

7

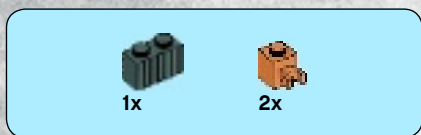
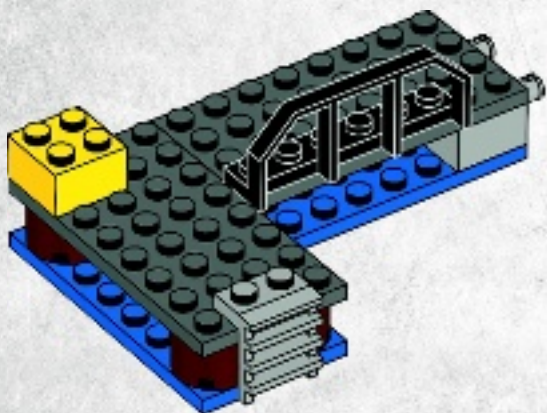

8

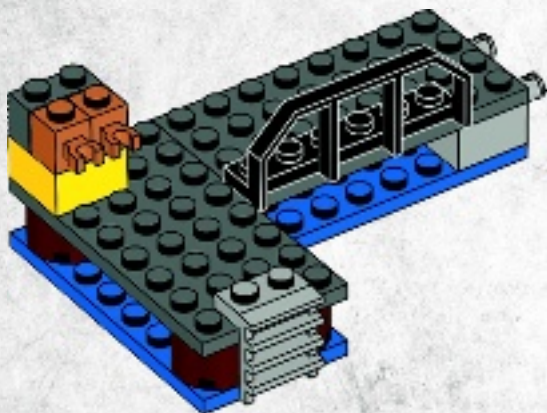



1x



1x

9

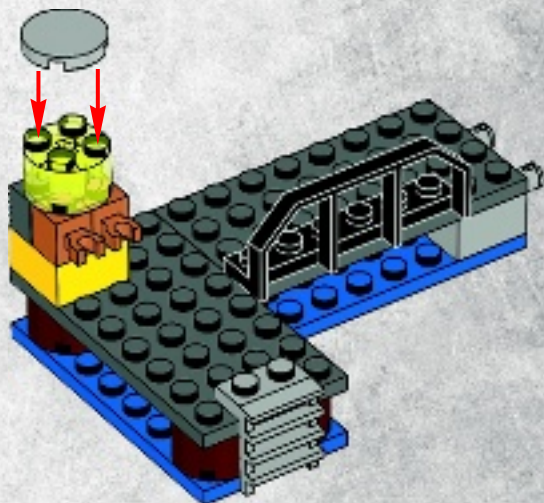

1x

10

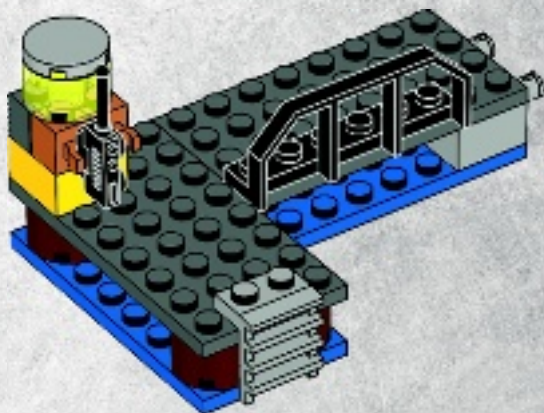

11

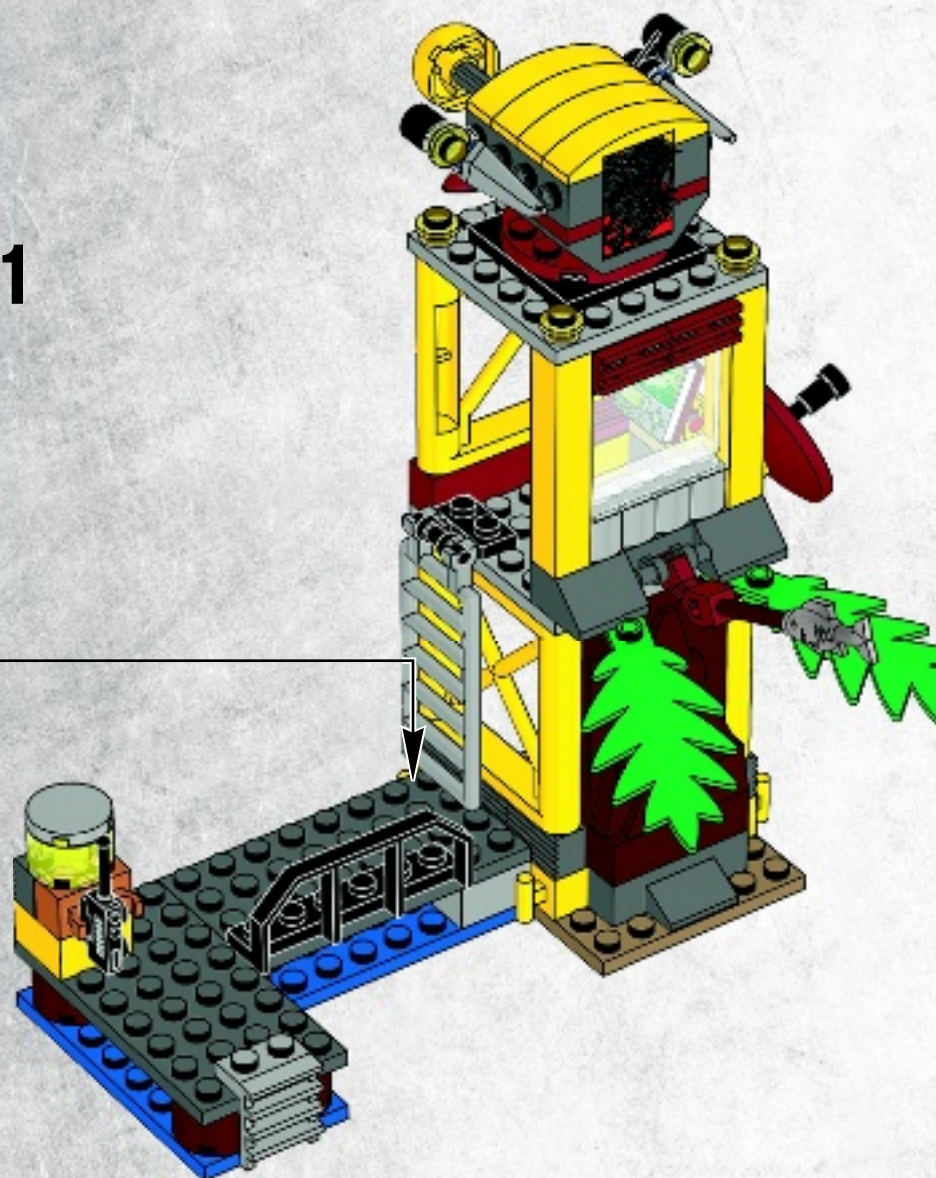





1x
4656496



1x
4656491



5x
4211166



2x
4211222



1x
4262974



1x
4507049



1x
4645343



1x
4285708



Customer Service

Kundenservice

Service Consommateurs

Servicio Al Consumidor

www.lego.com/service or dial



00800 5346 5555 :



1-800-422-5346 :



2x
4121965



1x
4164060



1x
4185269



1x
393724



1x
300324



4x
4262786



1x
4216656



1x
370024



2x
4503204



1x
4654328



5x
4613151



3x
4539435



1x
4594686



1x
4541528



2x
4539076



4x
4541506



1x
4631233



1x
4541386



2x
4626928



4x
4275573



2x
4569385



1x
4513987



2x
4533742



1x
613421



6x
3005744



1x
611649



1x
4654423



3x
4113917



2x
4211529



1x
4258308



2x
4616840



1x
4603503



1x
4211480



1x
4211833



2x
4211441



1x
4180464



2x
4211474



1x
4275673



2x
4562148



4x
4140588



1x
658326



1x
4538456



1x
396226



1x
4517986

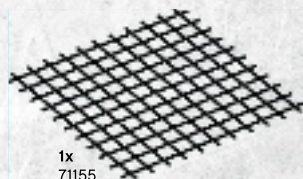

1x
71155



1x
4654583



1x
4211085



8x
4210636



4x
4211128



3x
4210725



2x
4567887



2x
4211054



1x
4210645



1x
4289542



1x
4658974



1x
4508553



2x
4211061



1x
4655291



1x
4645344



1x
4645345



1x
4646202



2x
4258459



1x
4251796



2x
303523



4x
4143005



1x
4656556



1x
4611885

5882



5884



5883



5885



5886



5887





www.LEGOclub.com

LEGO club™

FREE! GRATIS! GRATUIT!



LEGO® Club Magazine



LEGO® Club Email

SIGN UP ONLINE!
www.LEGOclub.com

VISIT THE WORLD'S
BIGGEST LEGO® SHOP!
www.LEGOshop.com

00800 5346 5555 
 1-866-534-6258 • 1-877-518-5346

© 2012 LEGO Group

LEGO.com/usa



* Freephone. Mobile charges may apply. * Numéro sans frais. Des frais peuvent s'appliquer avec les téléphones cellulaires. * Gebührenfrei, Kosten für Anrufe aus Mobilfunknetzen können abweichen. * Gratis telefoonnummer vanaf vaste lijn. * Det er et gratis nummer, når du ringer fra fasttelefon. * Det är gratis, när du ringer från en fast telefon. * Numéro sans frais. Des frais peuvent s'appliquer avec les téléphones portables.

B1112



WIN!

Go to www.LEGOsurvey.com/product to fill out a survey for a chance to win a cool LEGO® Product.

No purchase necessary.

Open to all residents where not prohibited.



www.LEGOsurvey.com/product

GEWINNE!

Nimm an der Umfrage auf www.LEGOsurvey.com/product teil und hab die Chance ein cooles LEGO® Produkt zu gewinnen!

Die Teilnahme am Gewinnspiel führt zu keinerlei Kaufverpflichtungen. Teilnahme in allen nicht ausgeschlossenen Ländern möglich.

WIN!

Ga naar www.LEGOsurvey.com/product, vul een enquêteformulier in en maak kans op een cool LEGO® product.

Geen aankoopverplichting. Iedereen mag deelnemen, uitgezonderd ingezetenden van landen waar een enquêteverbod geldt.

GAGNE!

Visite www.LEGOsurvey.com/product pour répondre à un questionnaire et avoir une chance de gagner un produit LEGO® très cool!

Aucune obligation d'achat. Ouvert à tous les résidents des pays autorisés.

当てよう!

www.LEGOsurvey.com/product にアクセスして、アンケートにご記入ください。当選者にはレゴ®製品を差し上げます。

お買い上げの必要はありません。禁止されていない限り、すべての皆様にご利用いただけます。



www.LEGO.com

6002898

LEGO and the LEGO logo are trademarks of the/son des marques de commerce de/son marcas registradas de LEGO Group. ©2012 The LEGO Group.