

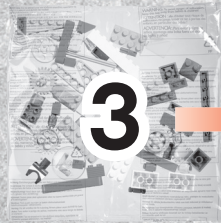

# DINO

5887





3

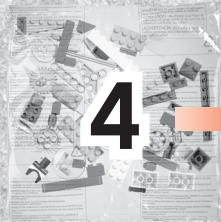
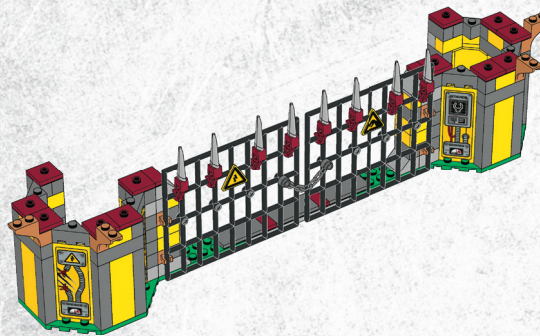

4

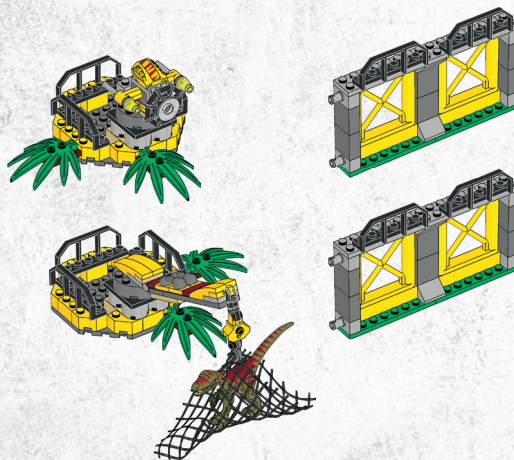

5

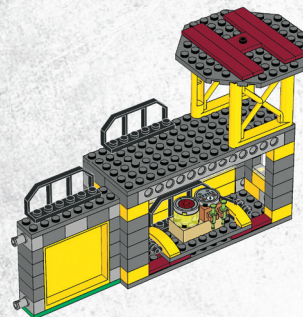

1

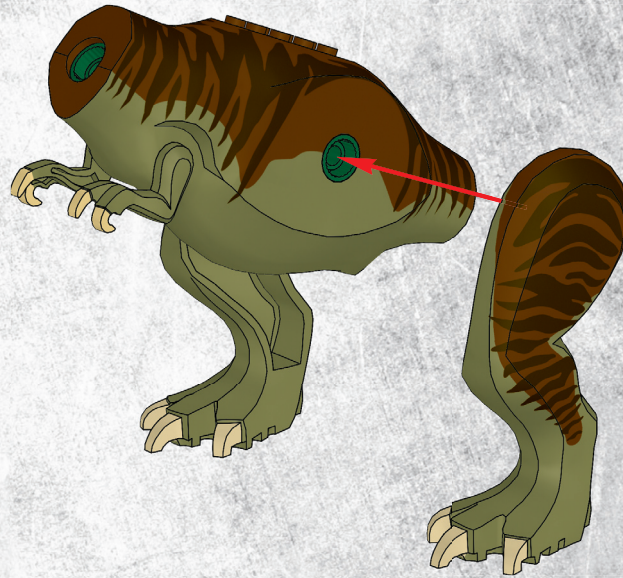

2

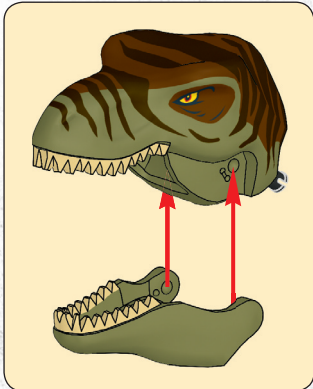

3

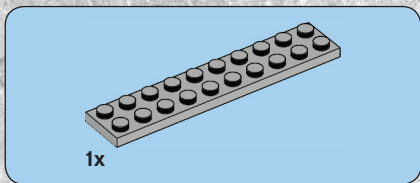
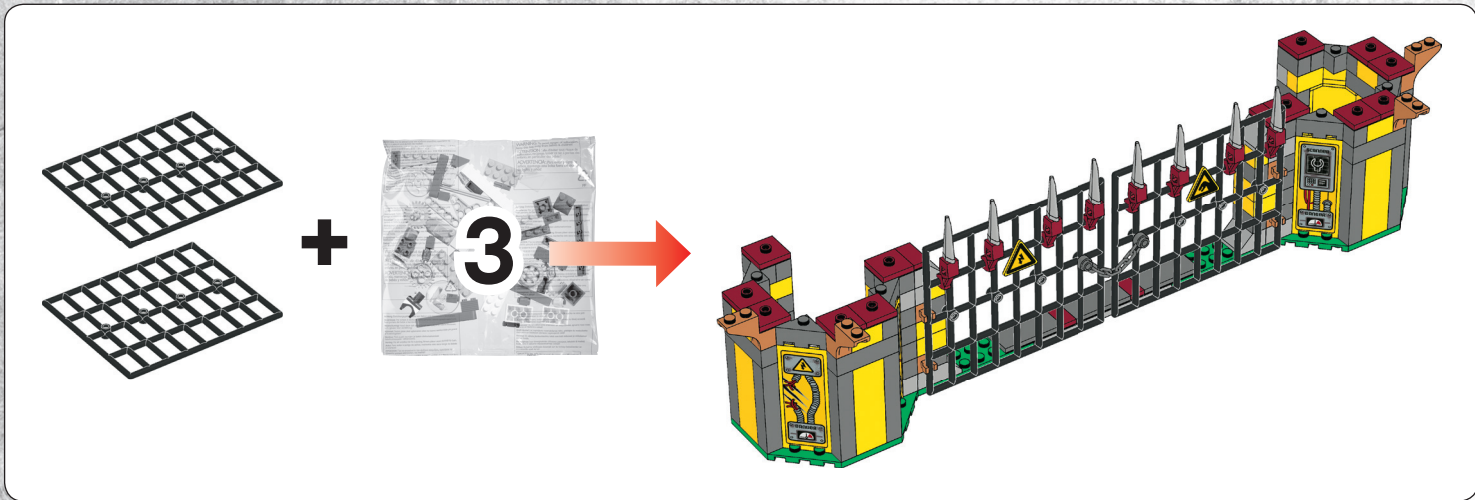

1

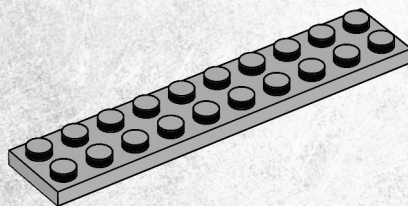

4

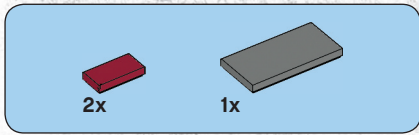

**2**

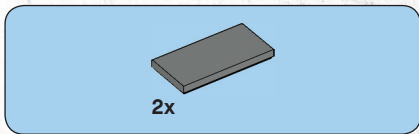
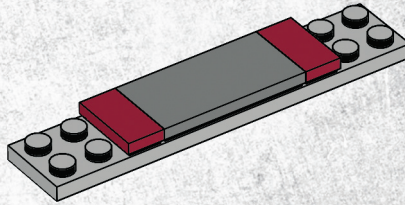

**3**

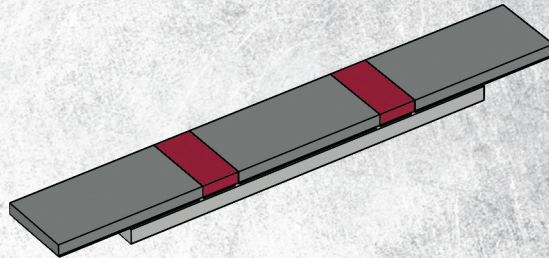

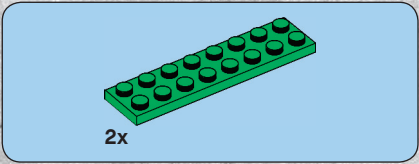

4

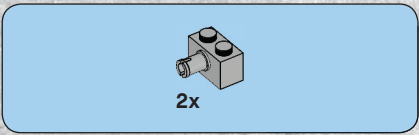
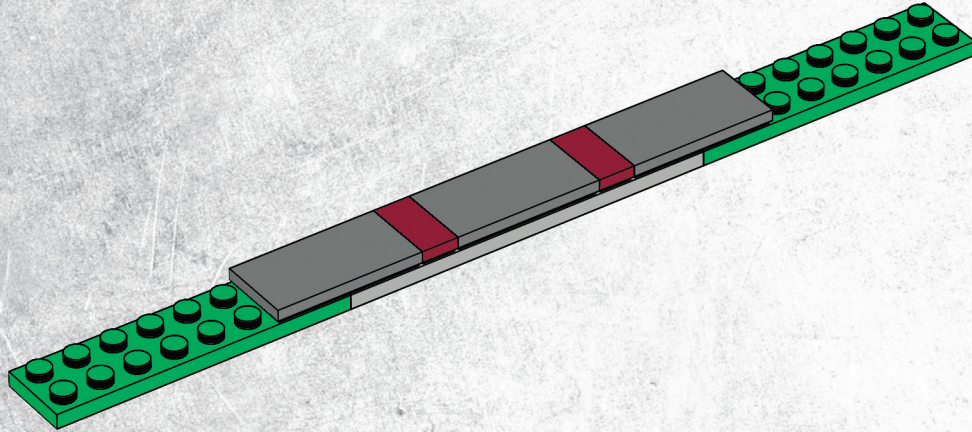

5

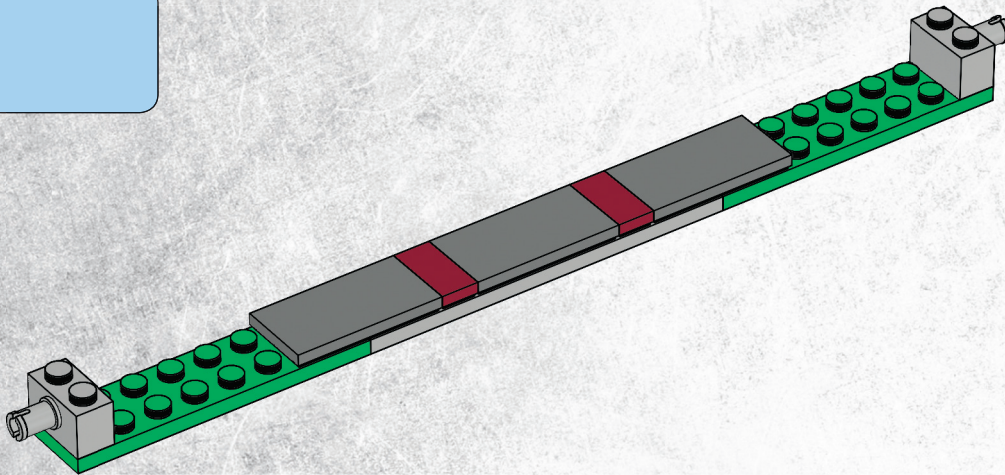

6



6

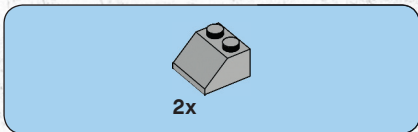
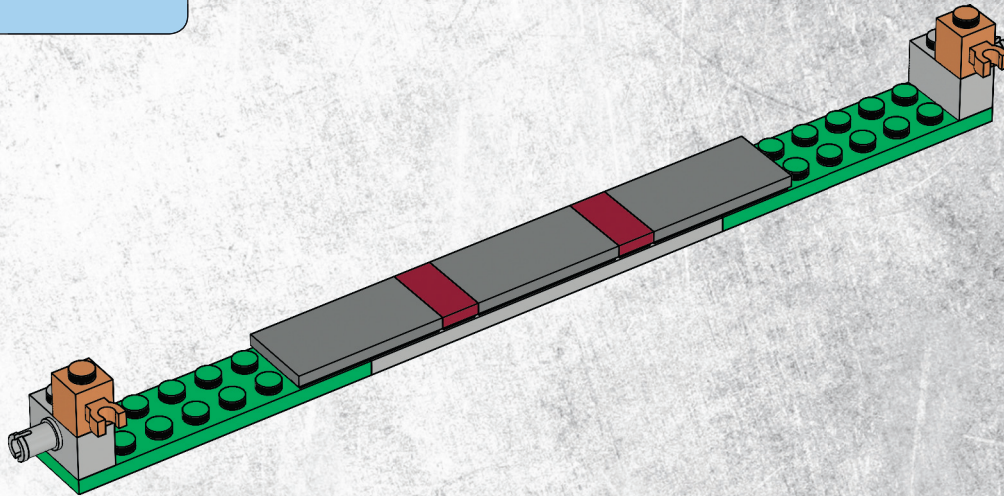

7

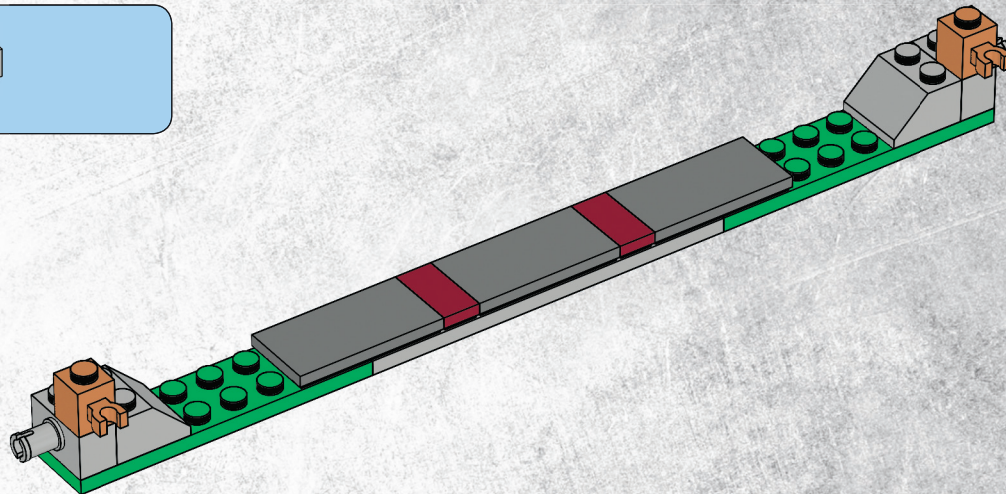

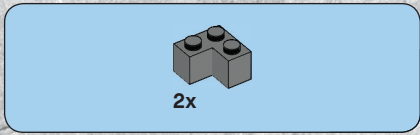

8

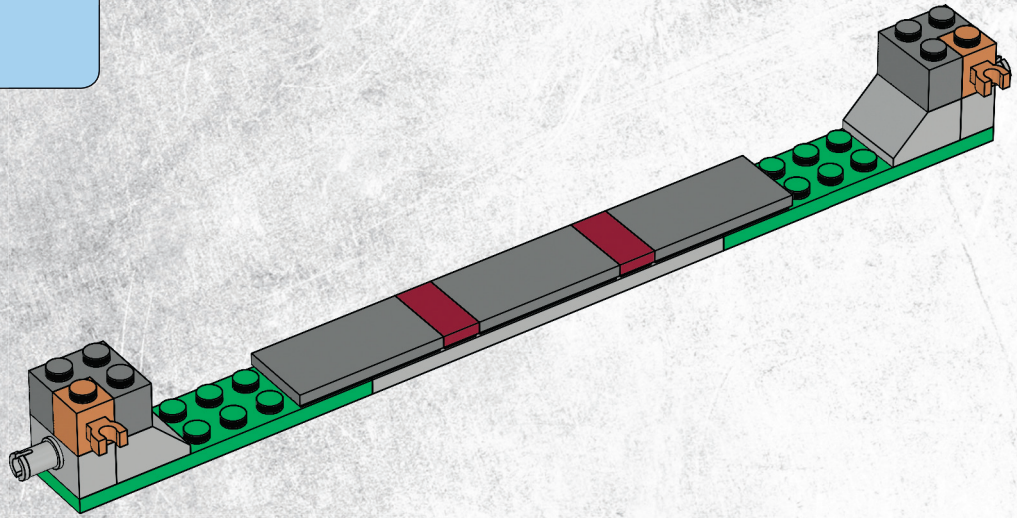

9

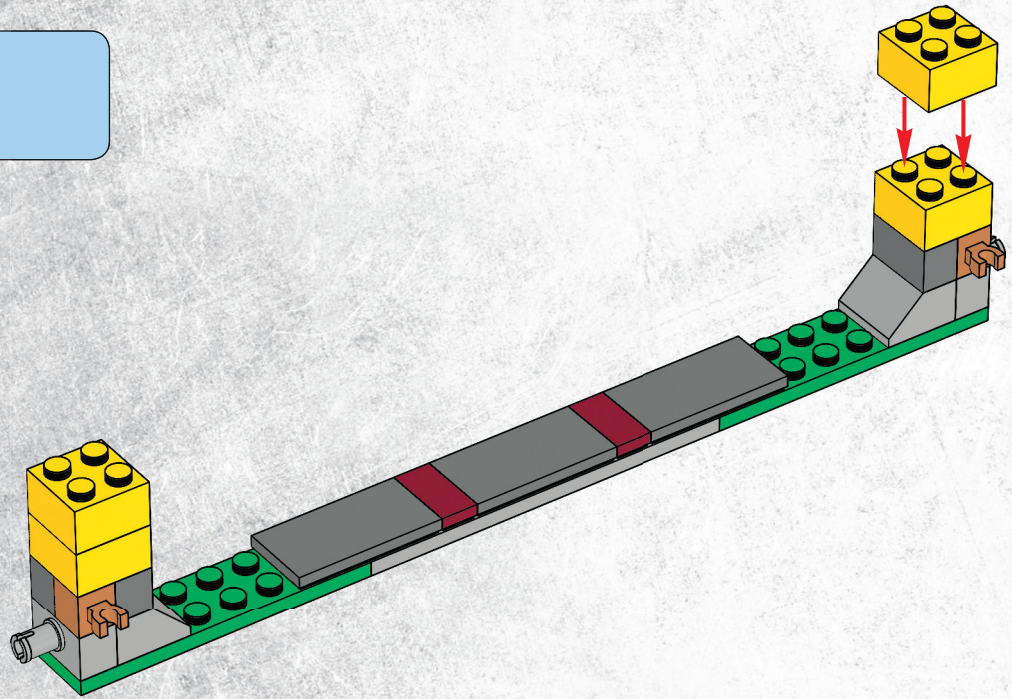

8





2x



2x

# 10

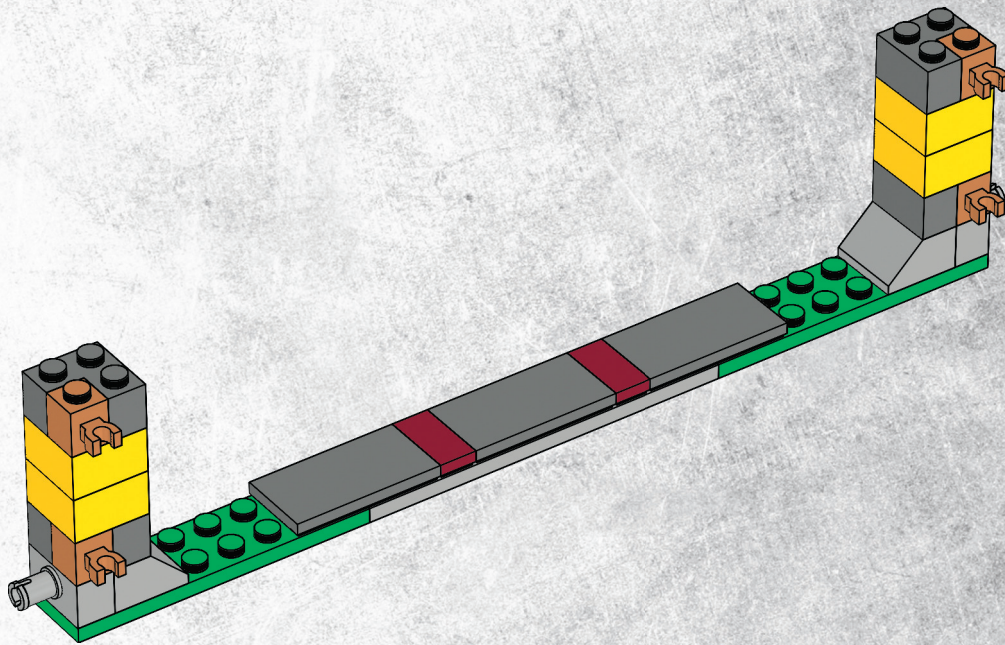



2x



2x

# 11

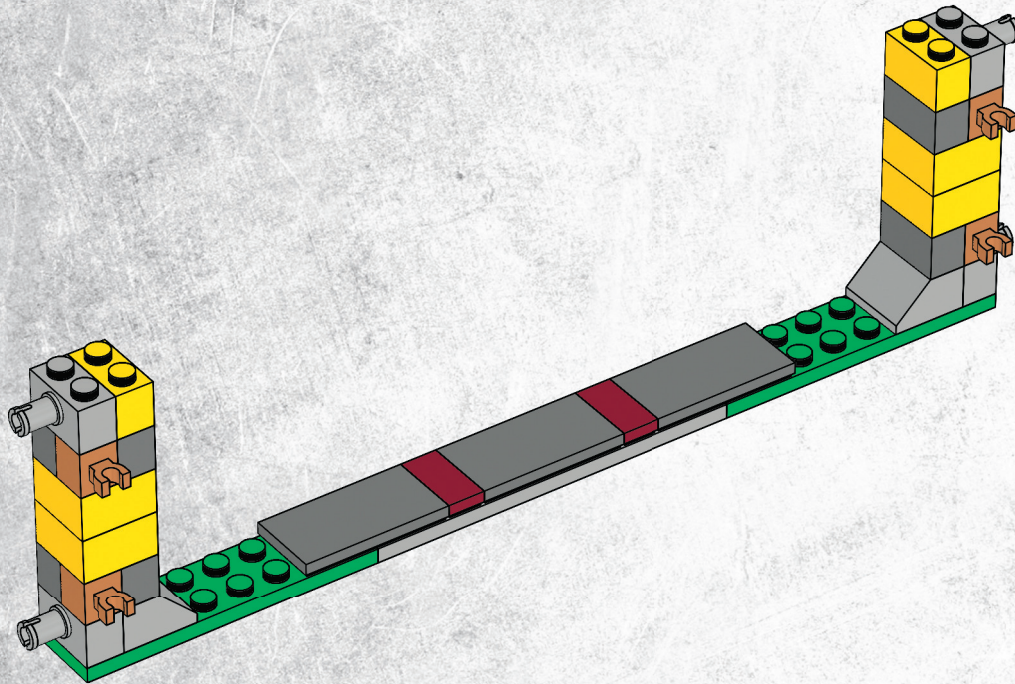

10

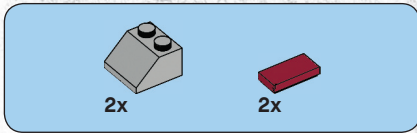

# 12

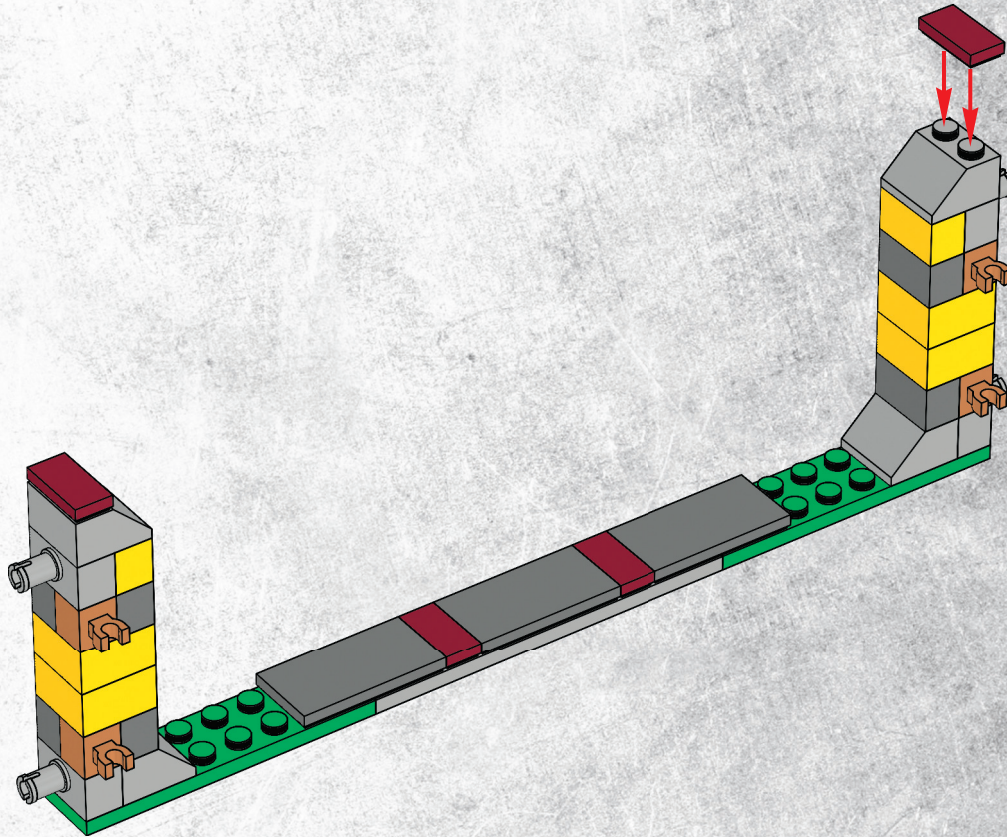

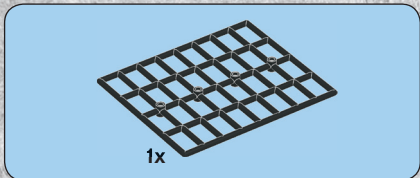
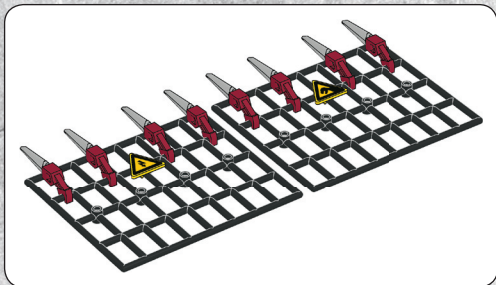

1

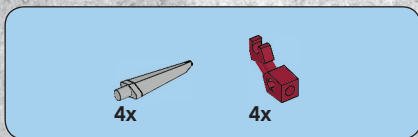
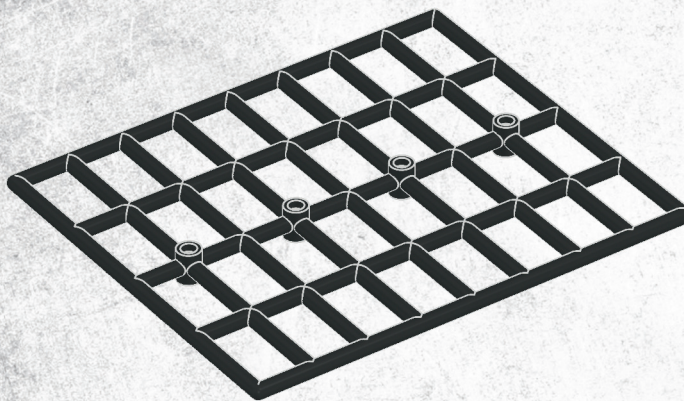

2

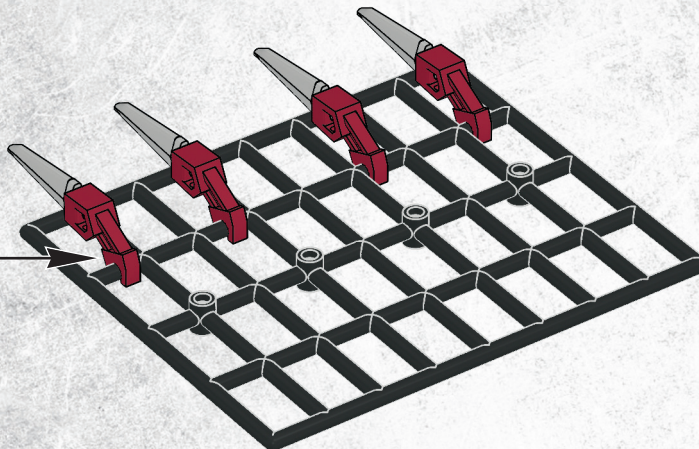
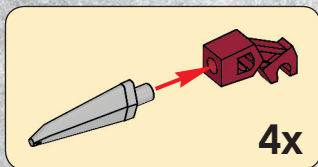

12

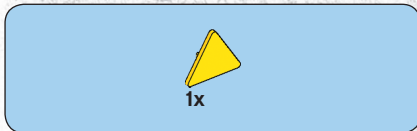

3

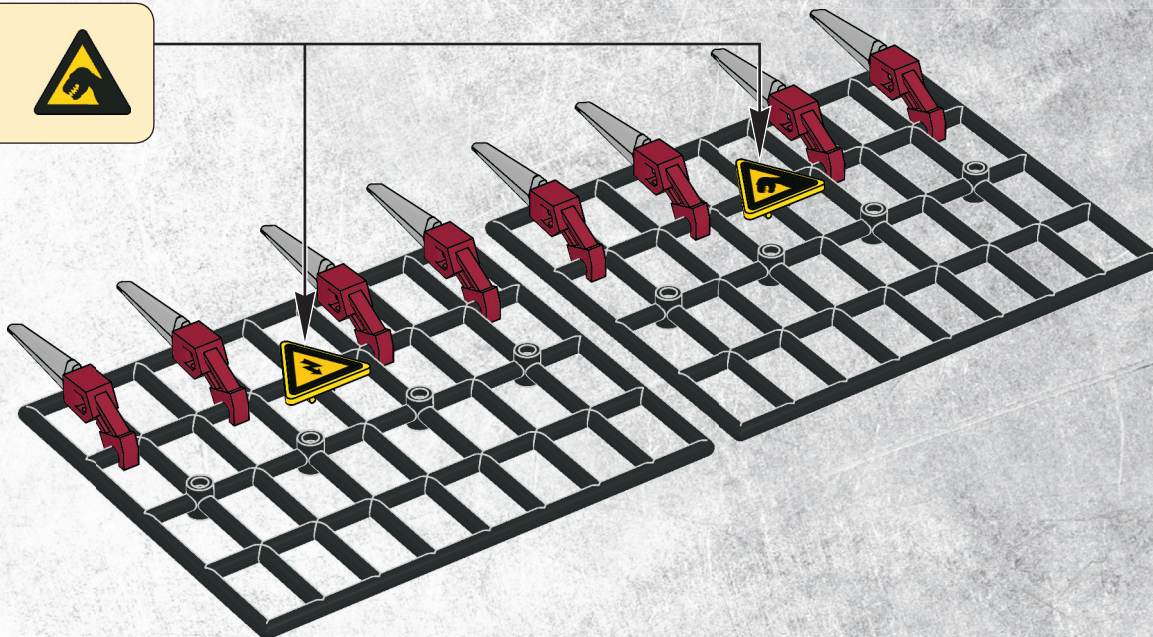
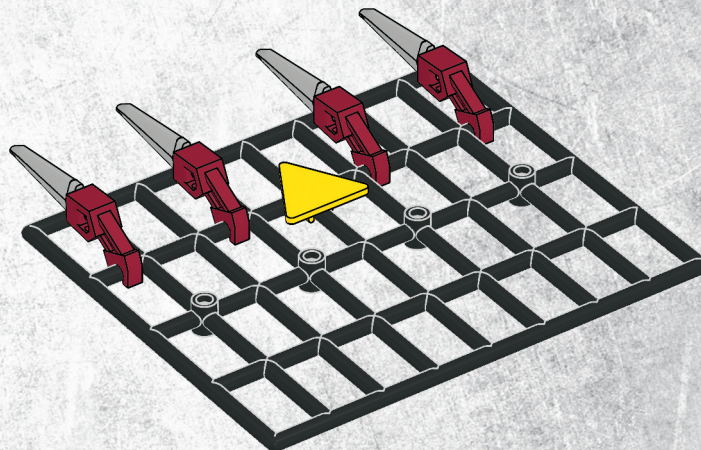

13

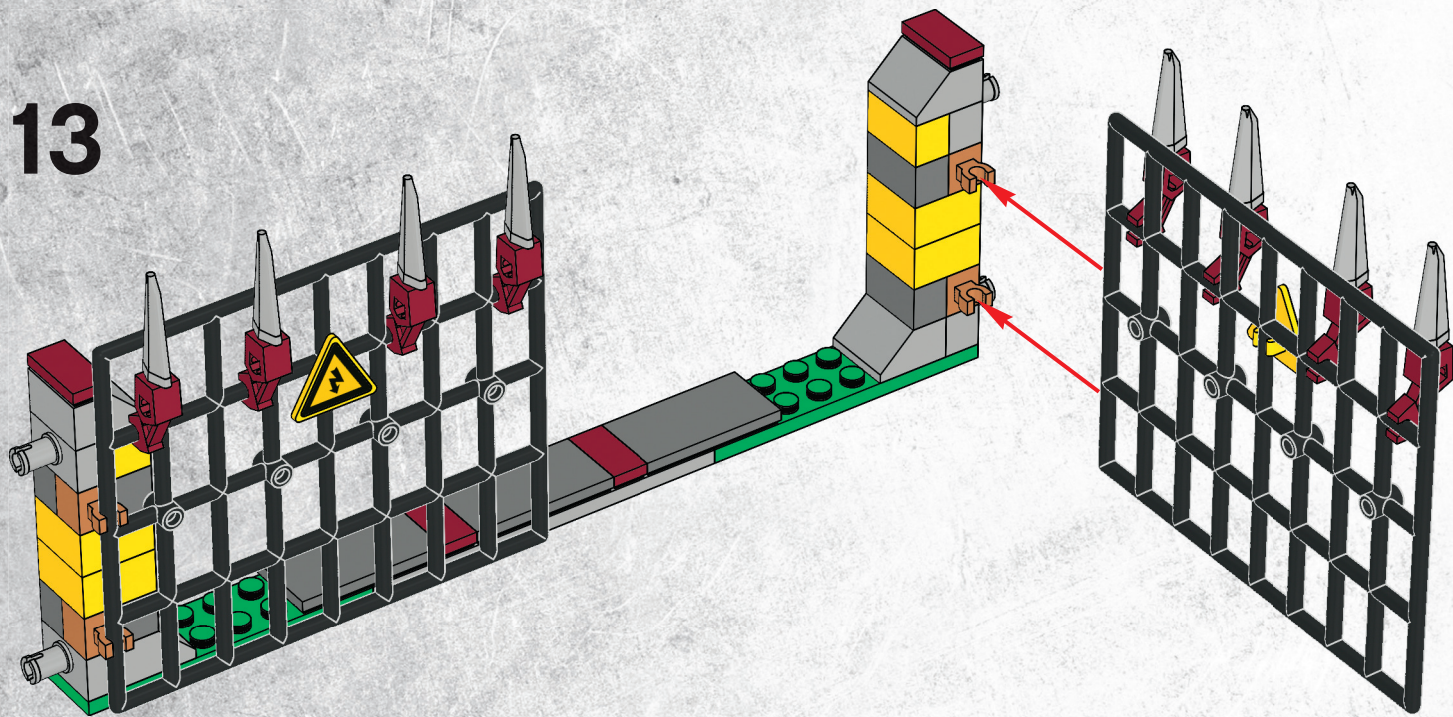

14

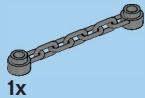

1x

# 14

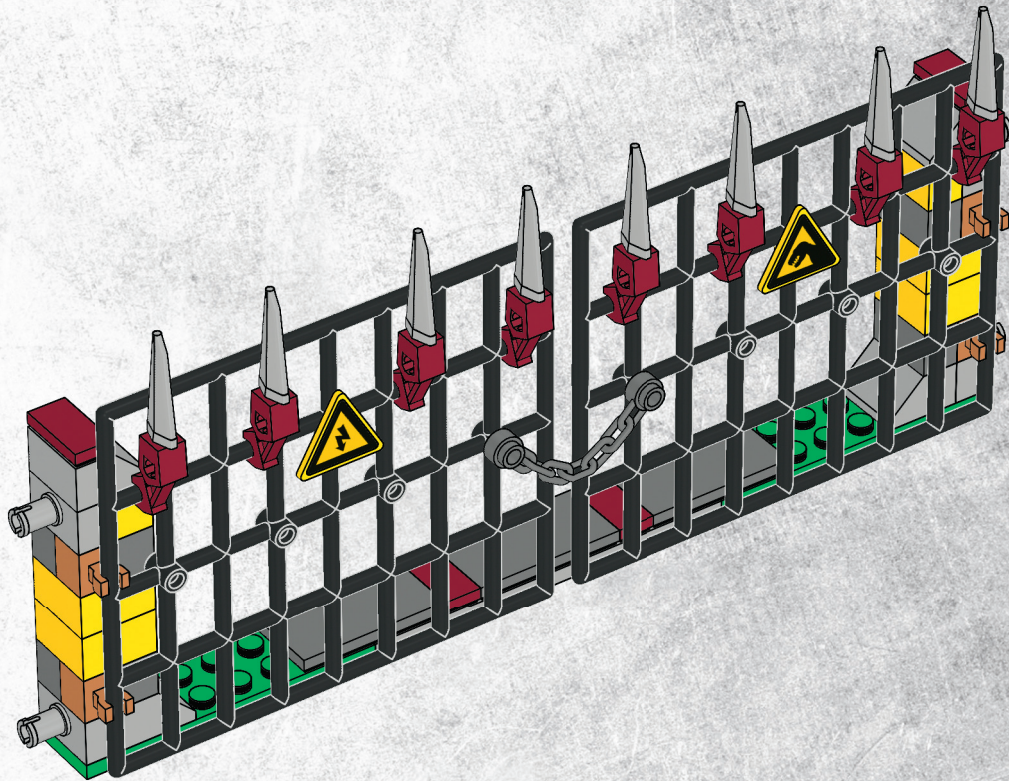

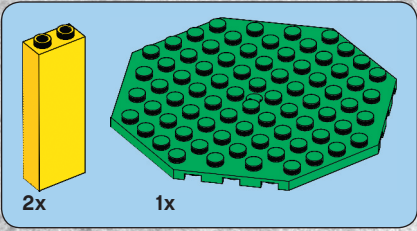
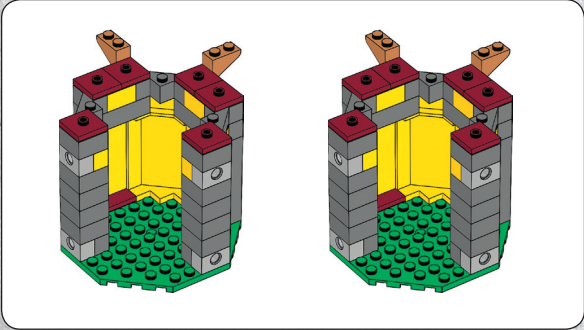

1

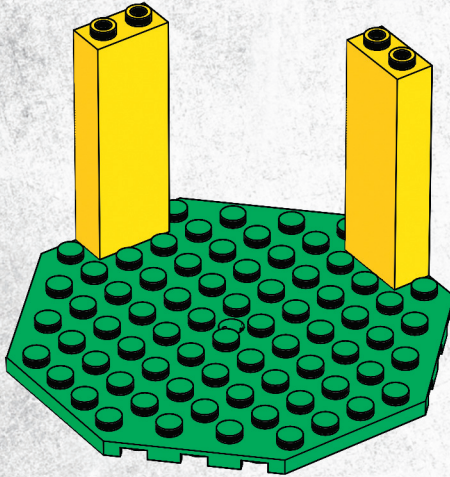



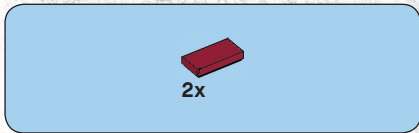

2

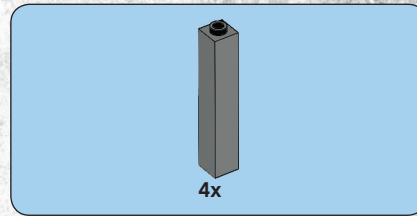
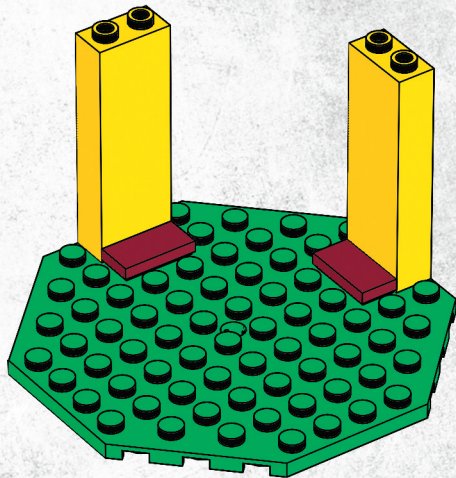

3

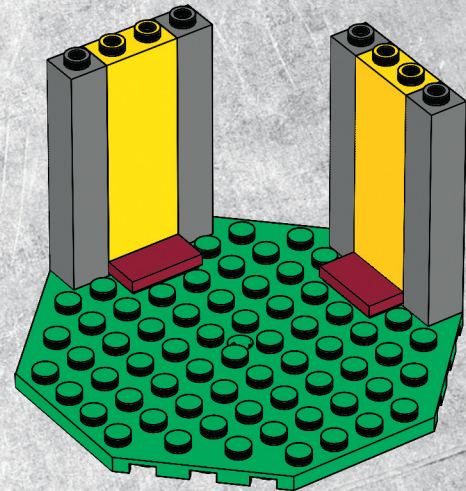

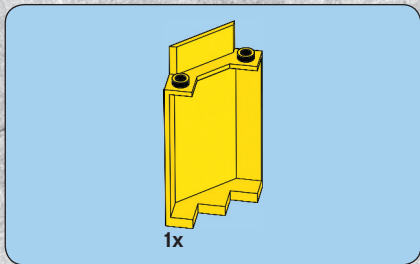

4

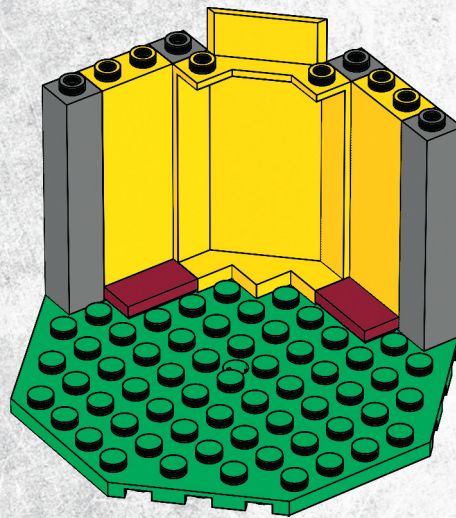

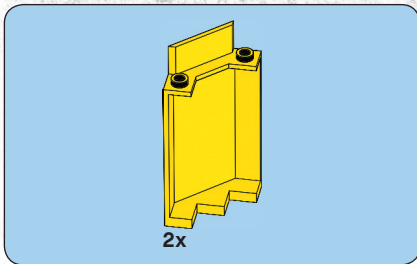

5

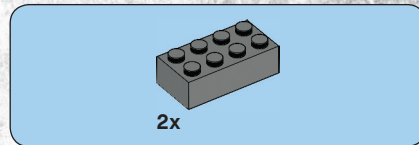
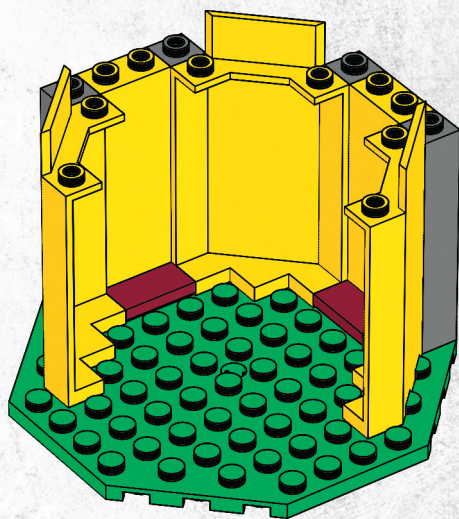

6

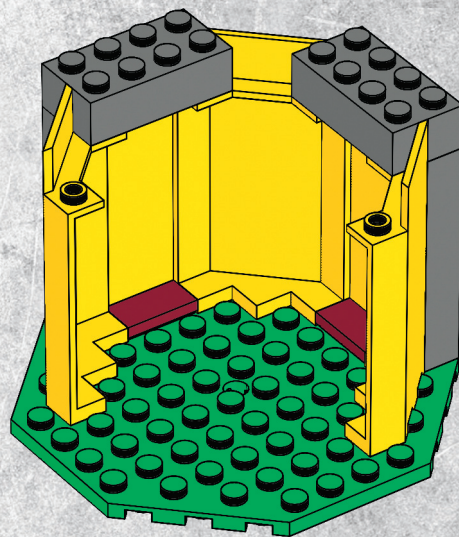



2x

7

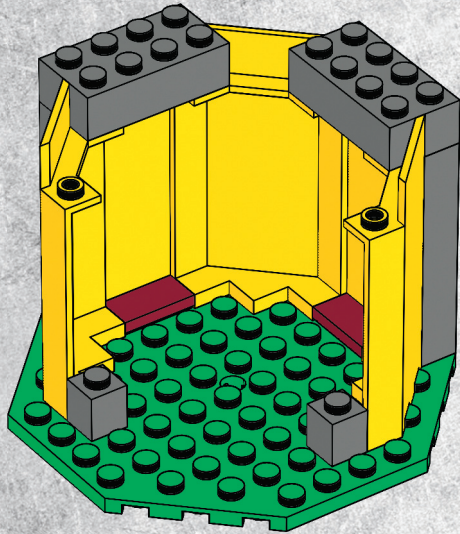

2x

8

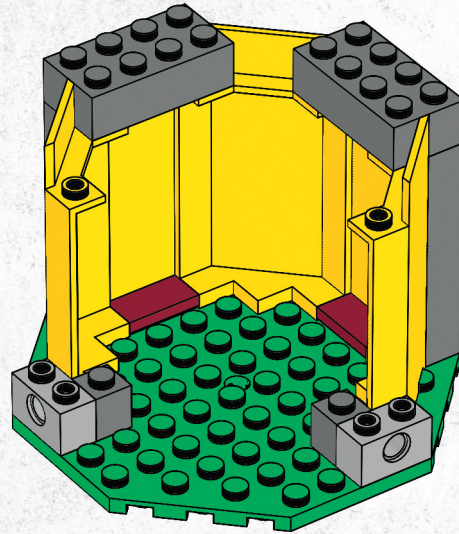

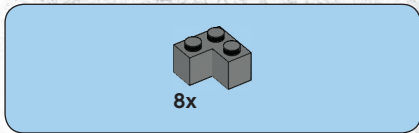

9

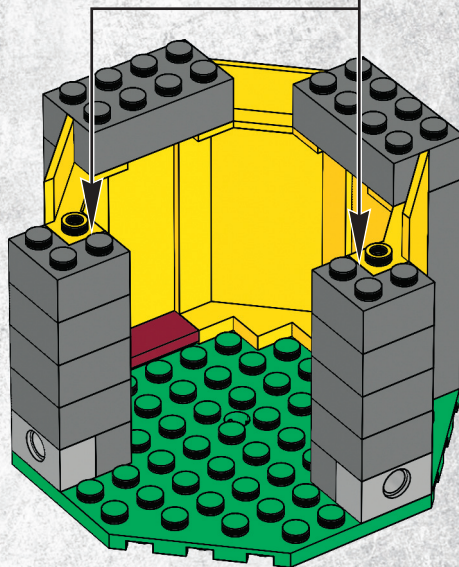
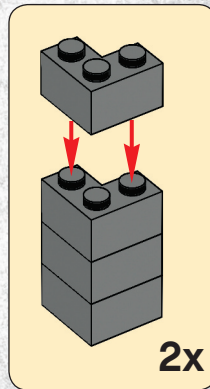

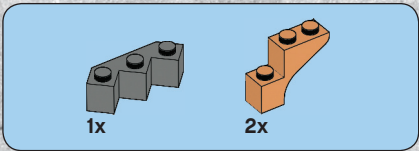

10

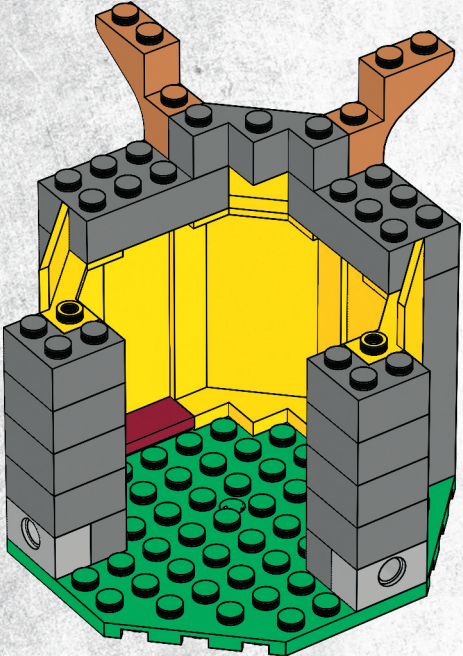



2x



2x

# 11

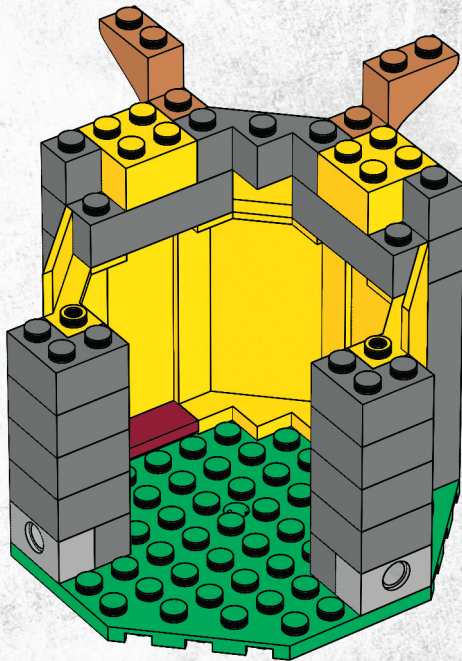

2x

# 12

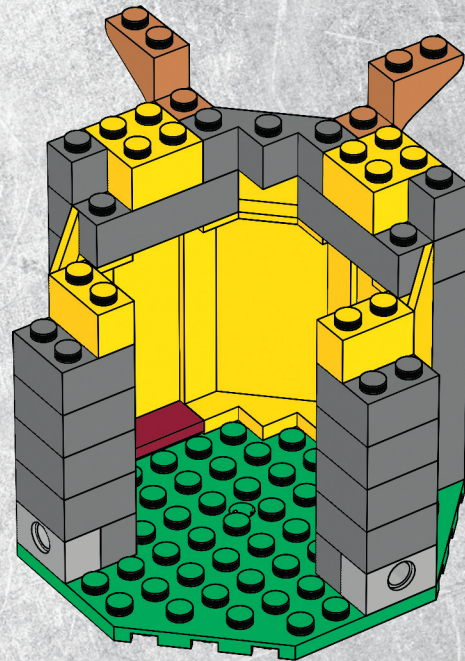

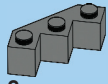

2x

13

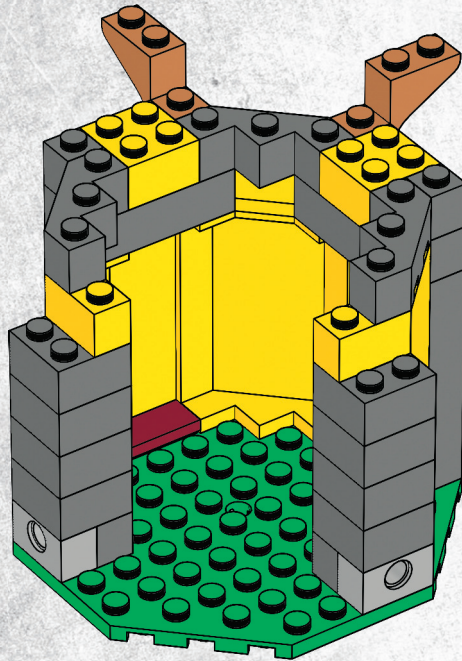

24





2x

14

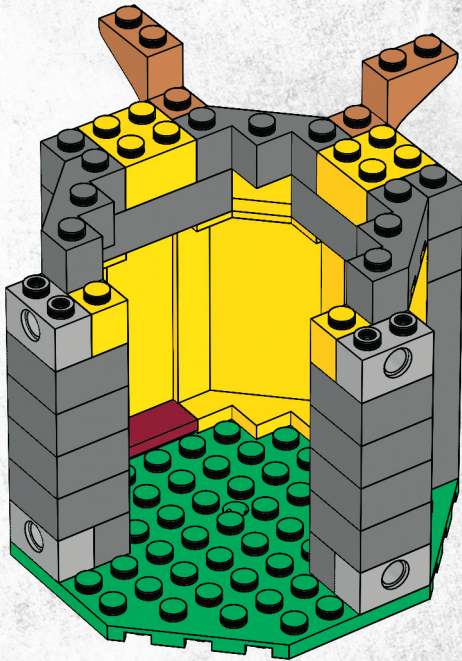

2x

15

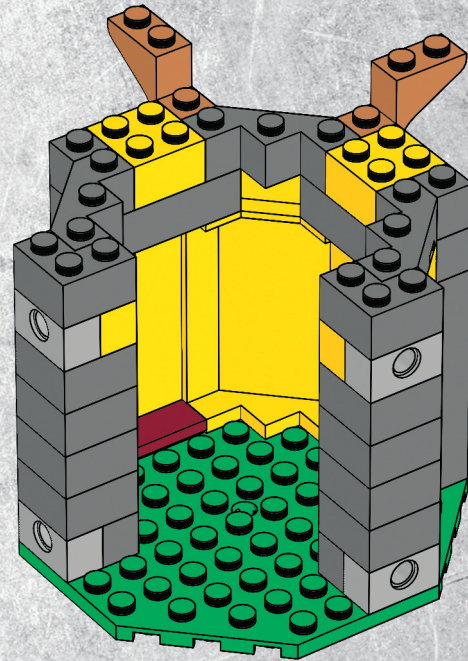



6x

16

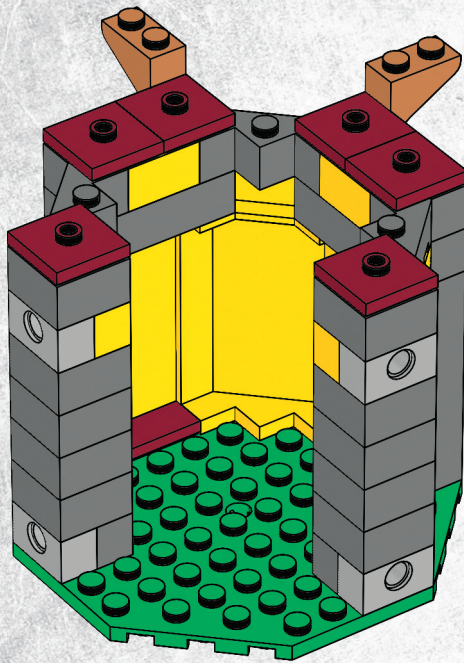

2x

17

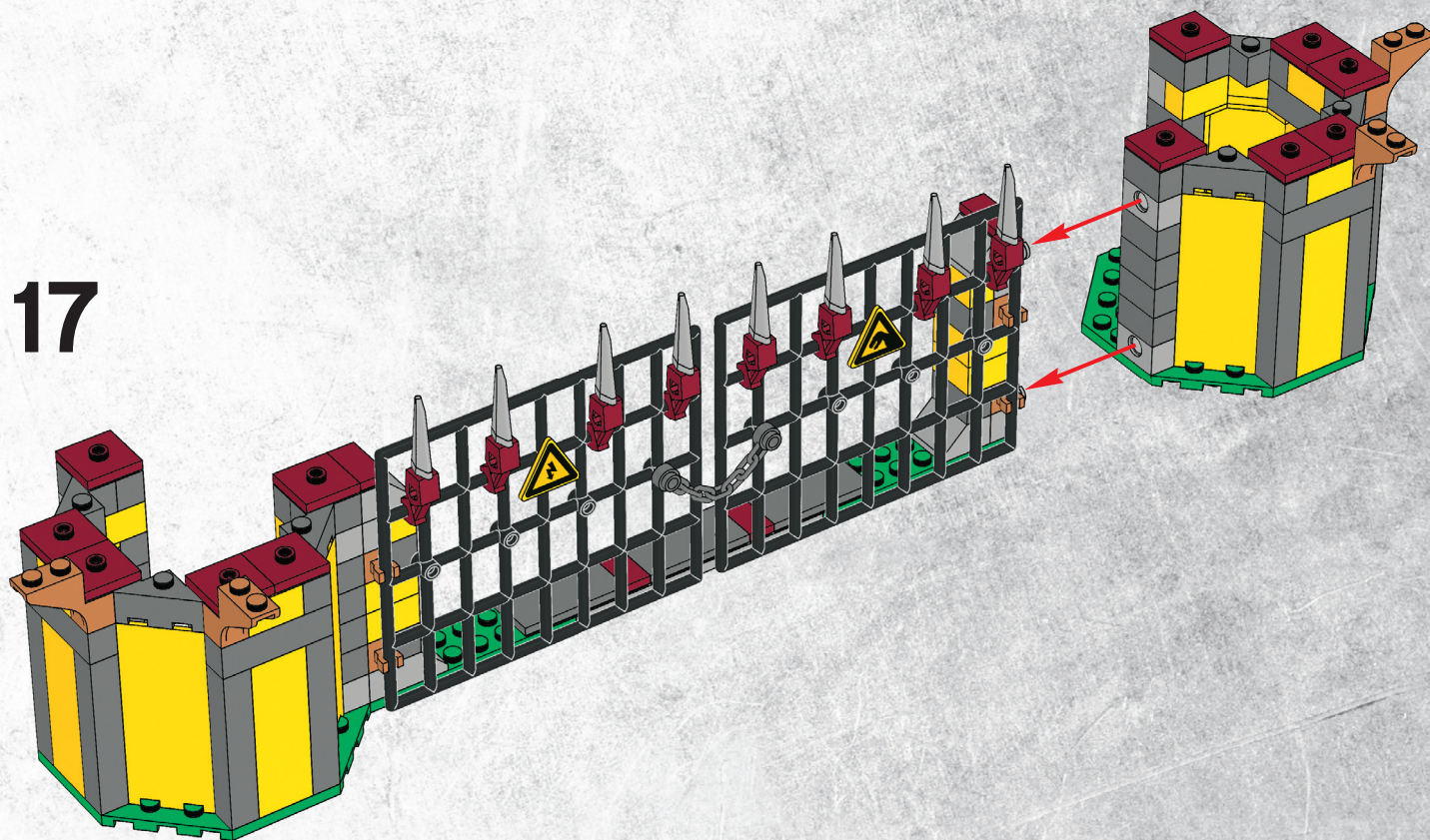

# 18

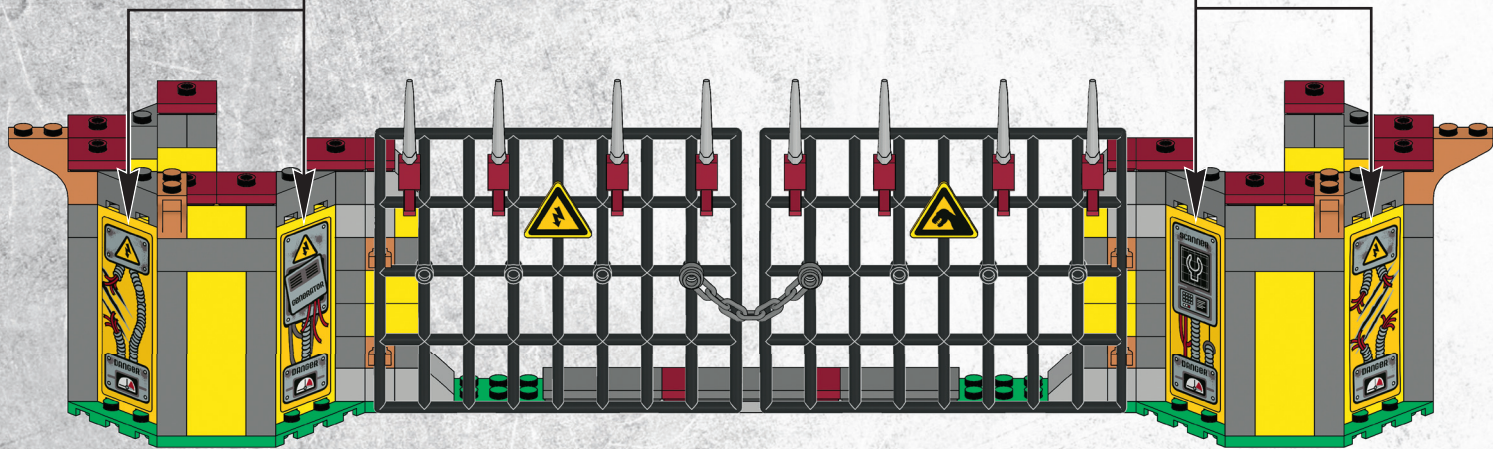
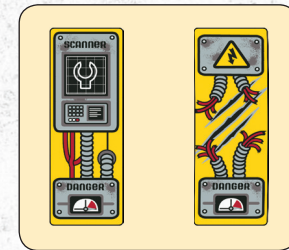
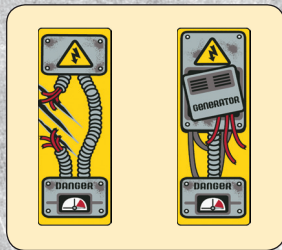

28

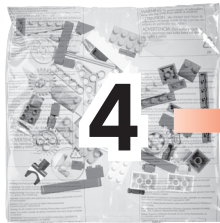

4

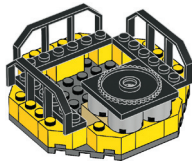
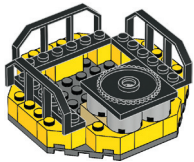
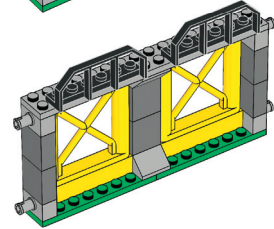
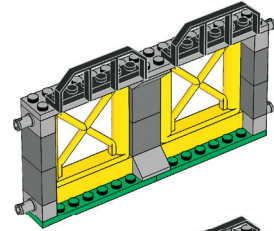
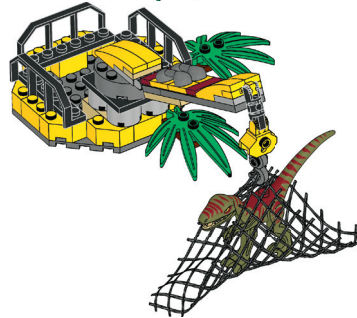
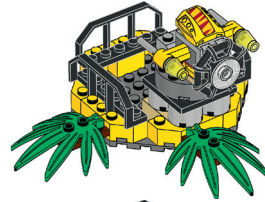

2x

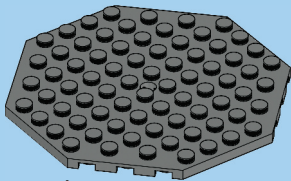

1x

1

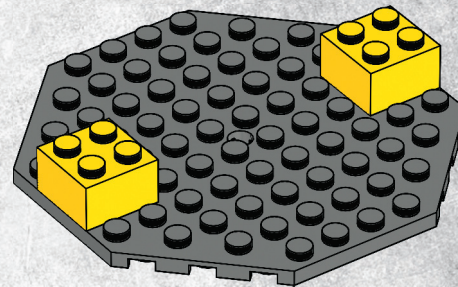



2

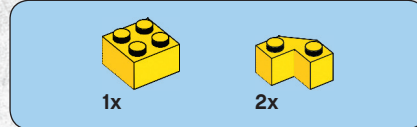
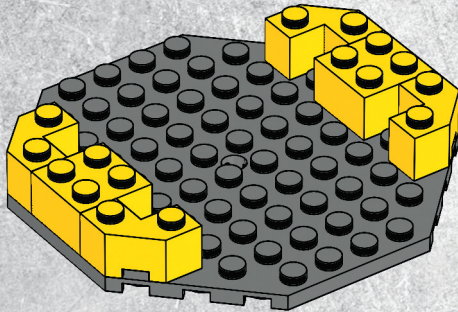

3

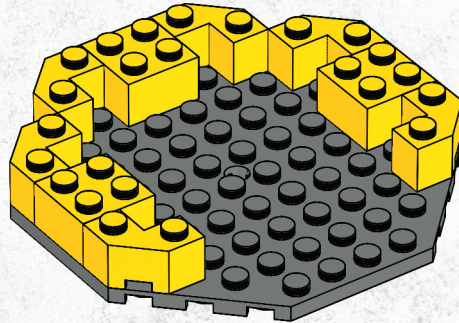

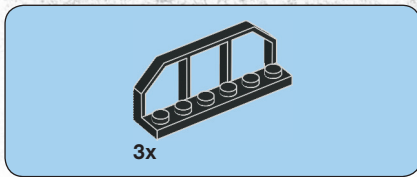

4

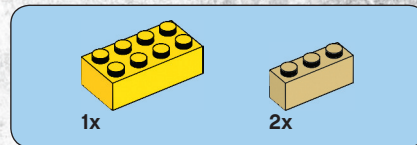
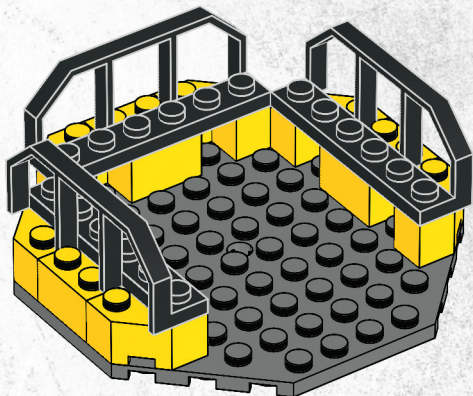

5

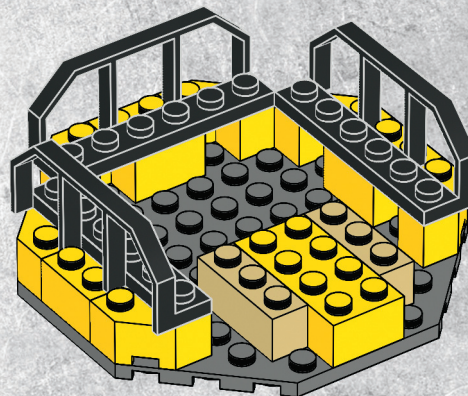



2x

6

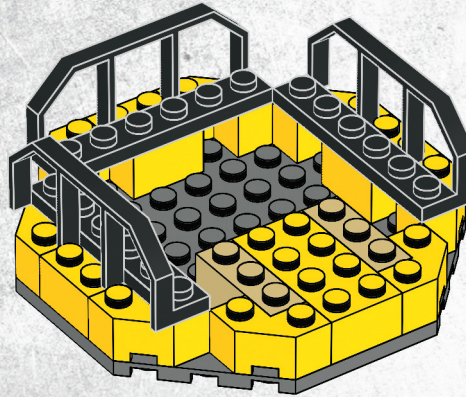



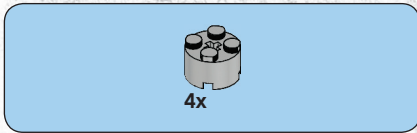

7

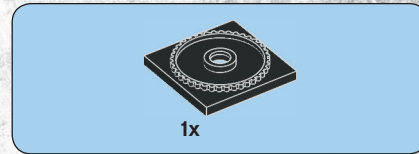
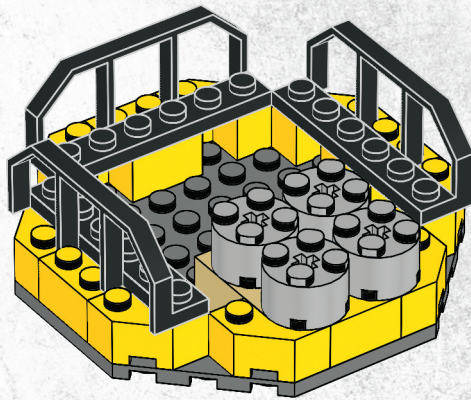

8

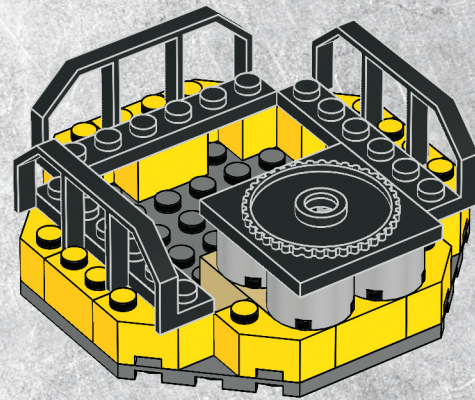

2x

19

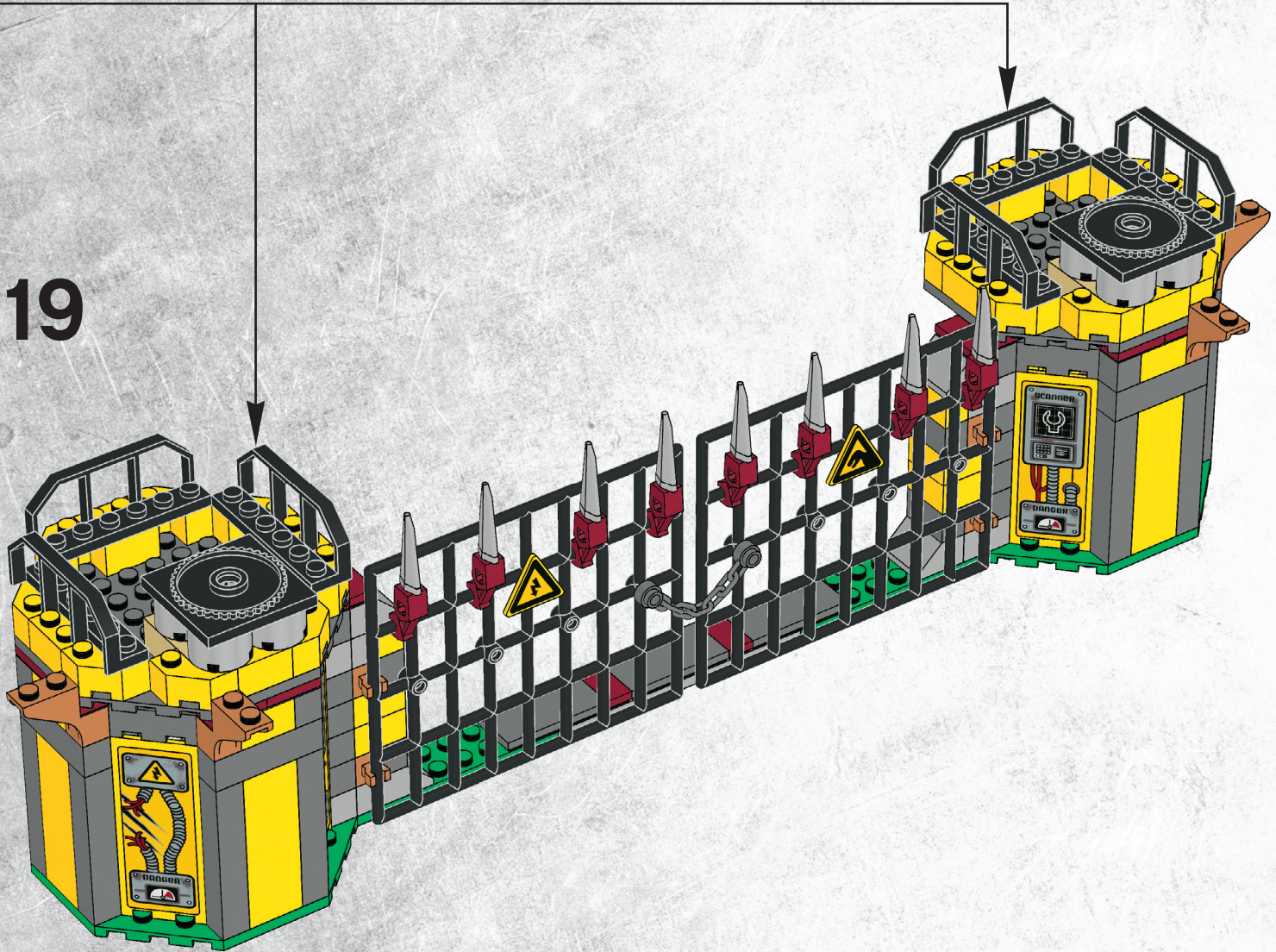

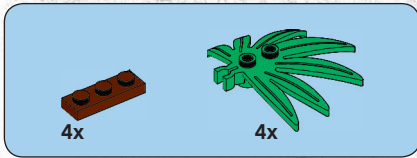

20

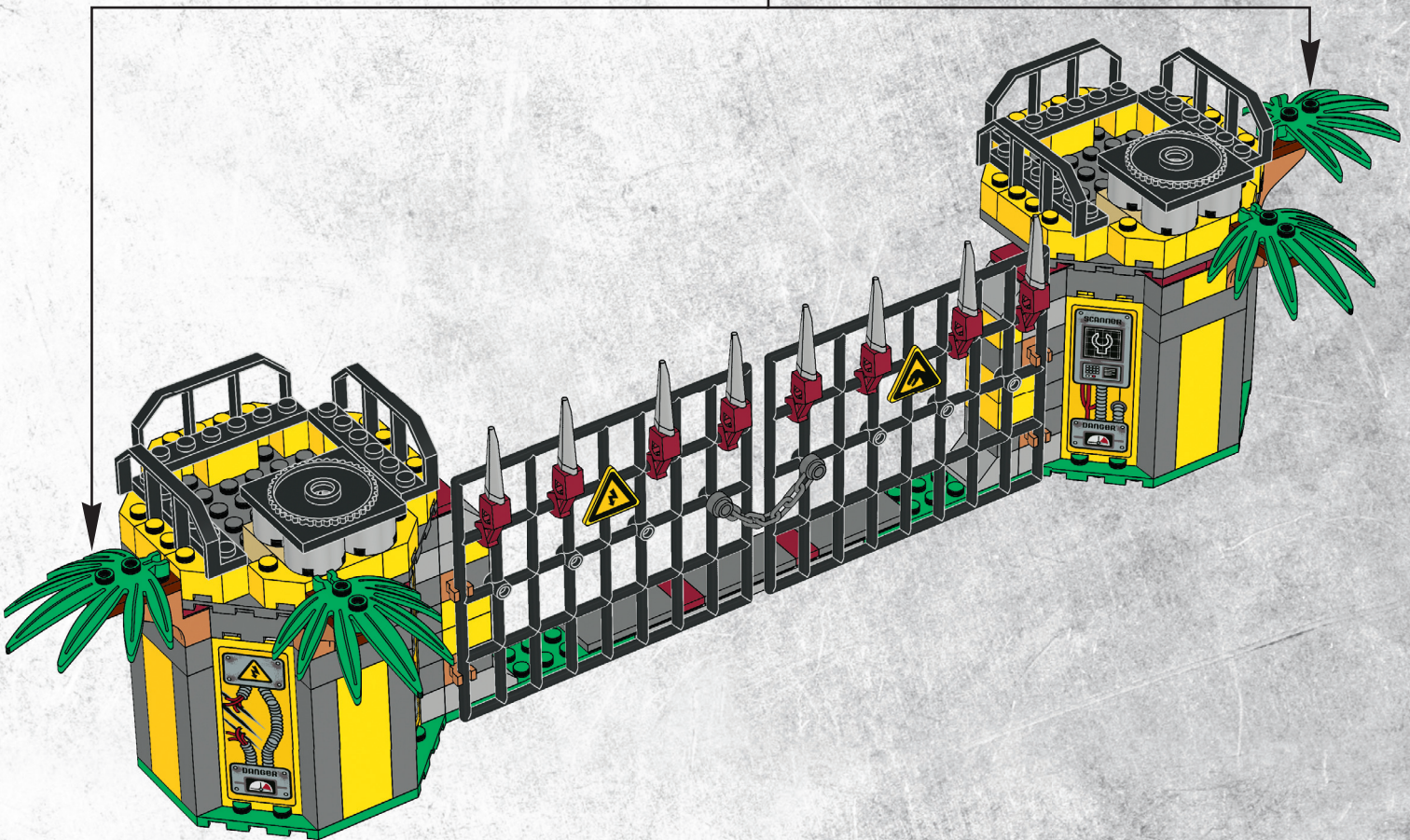
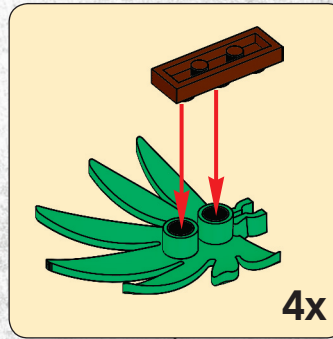

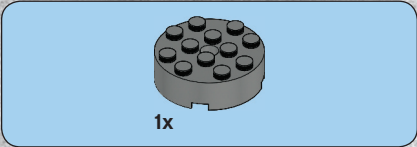
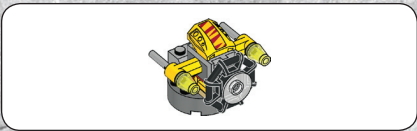

1

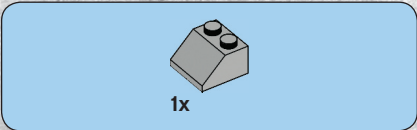
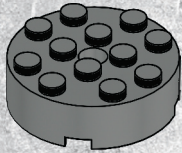

2

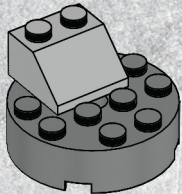

36

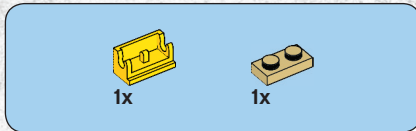

3

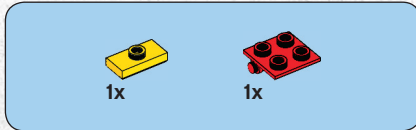
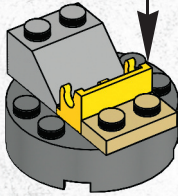
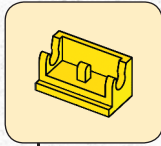

4

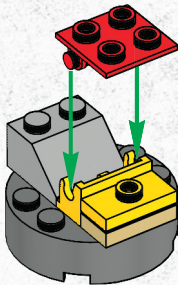



5

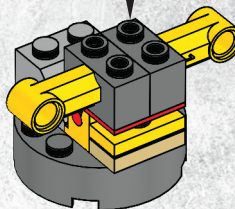
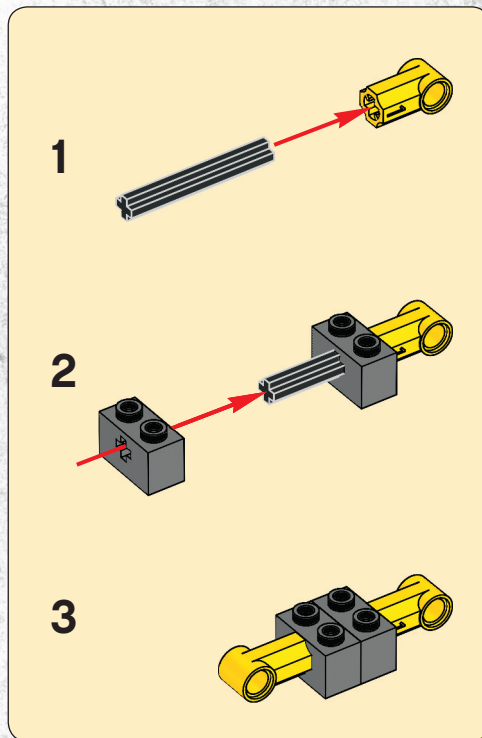

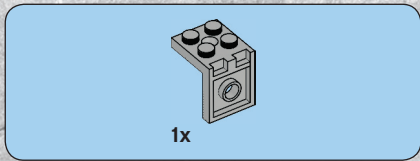

6

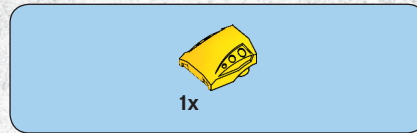
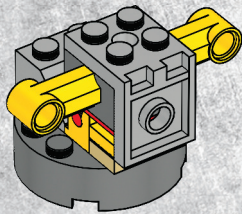

7

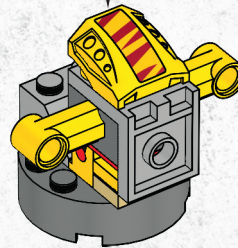
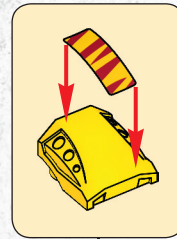

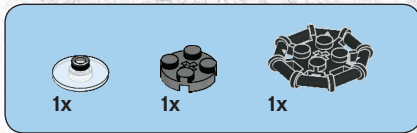

8

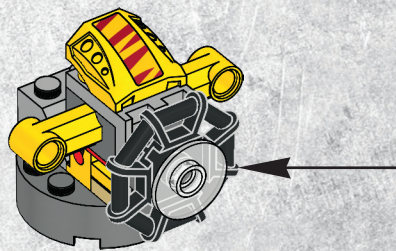
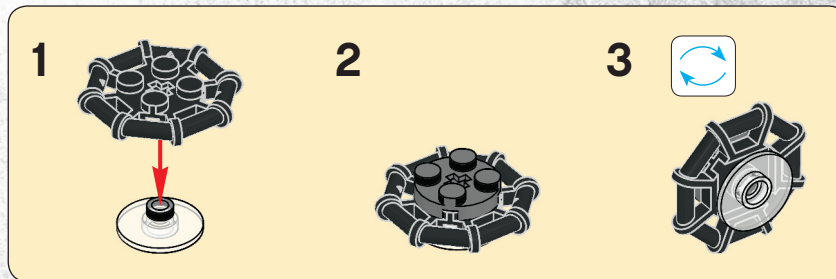

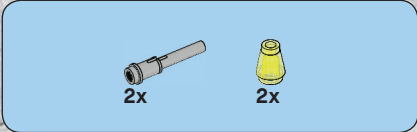

9

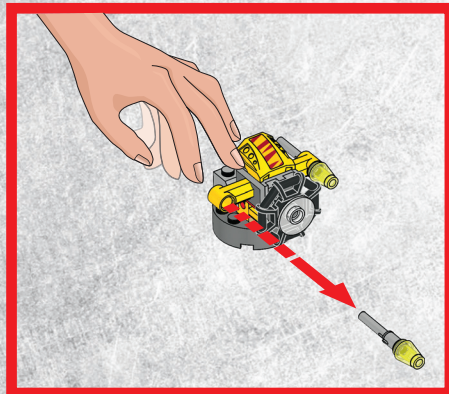
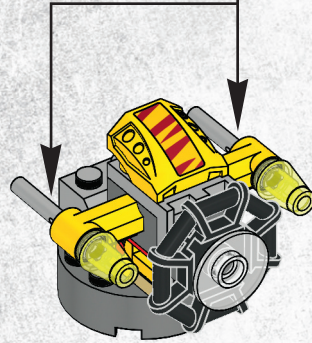
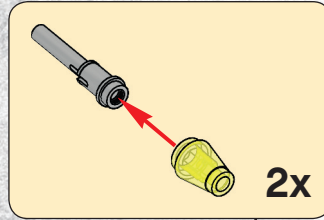



21

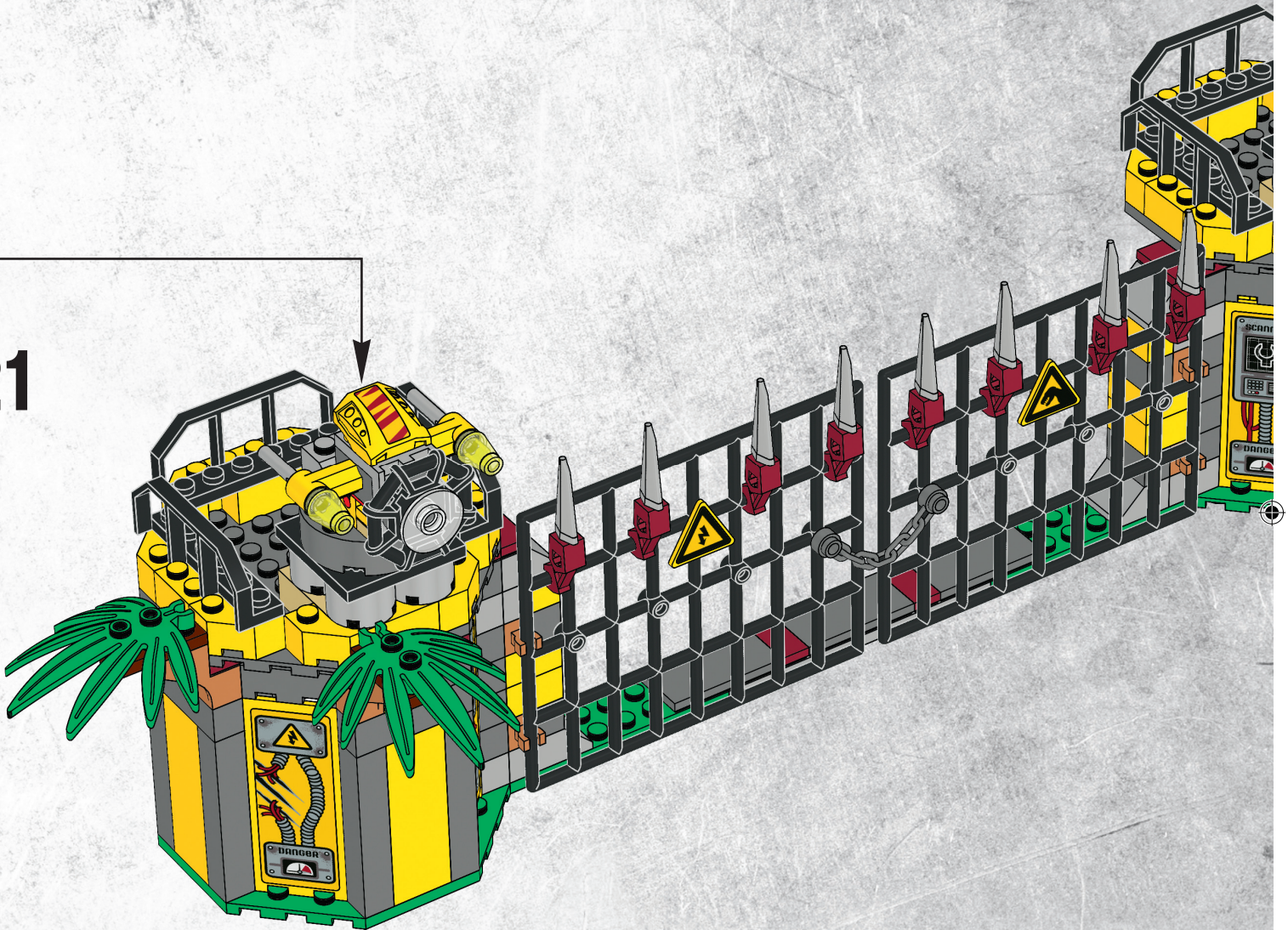

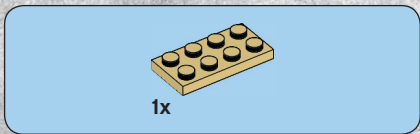
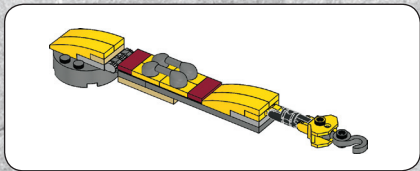

1x

1

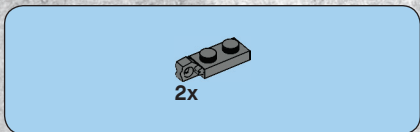
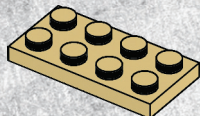

2x

2

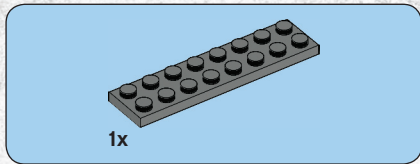
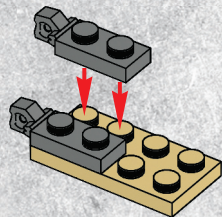

1x

3

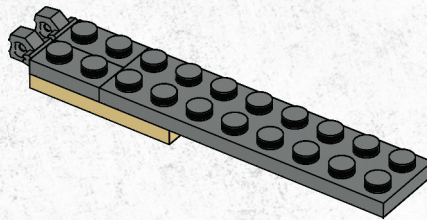

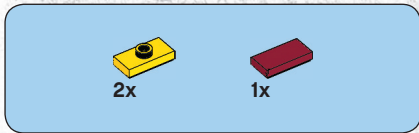

4

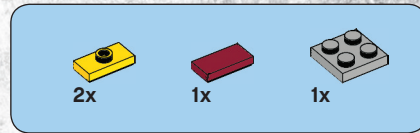
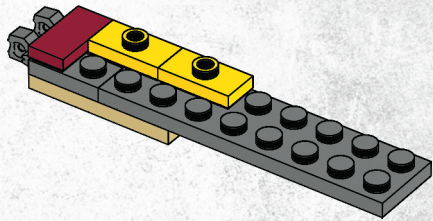

5

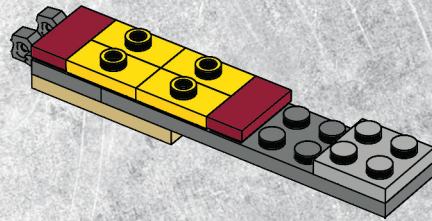

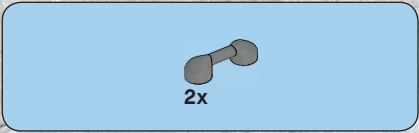

6

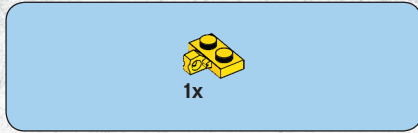
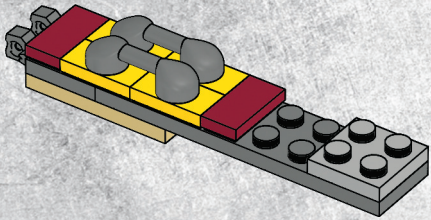

7

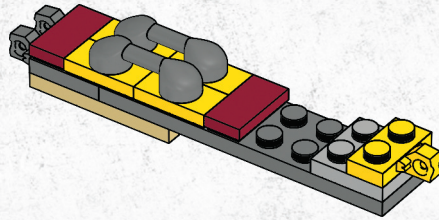

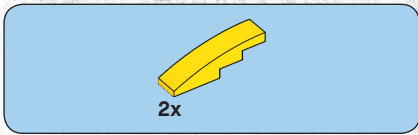

8

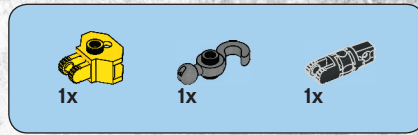
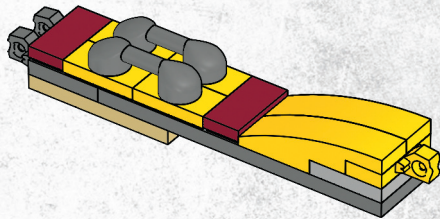

9

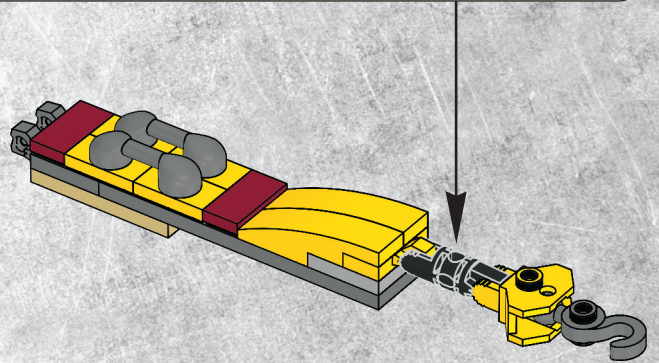
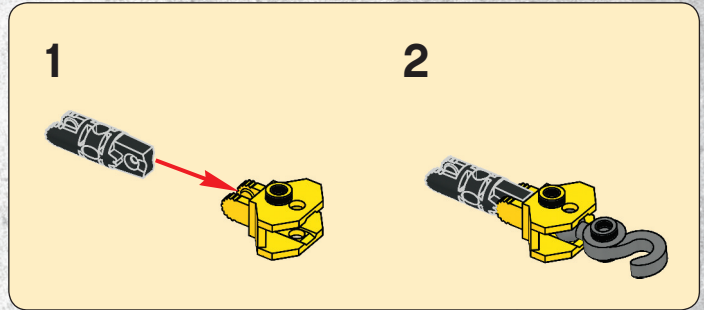

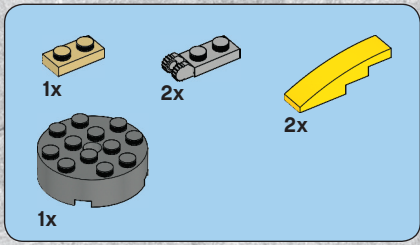

10

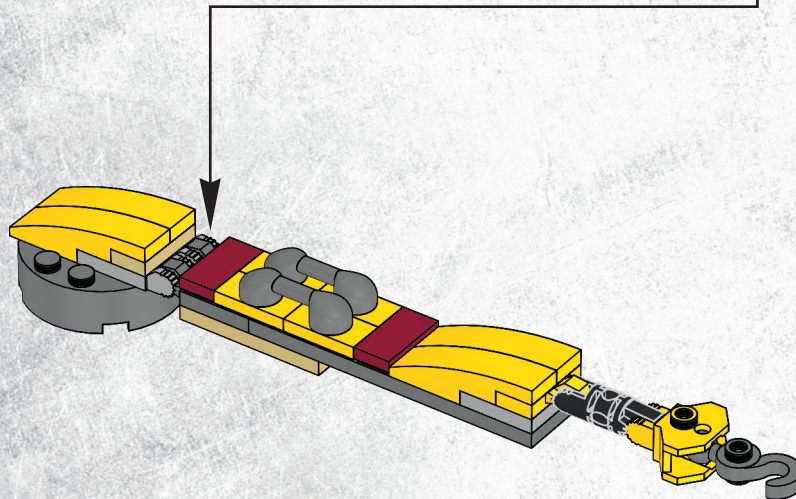
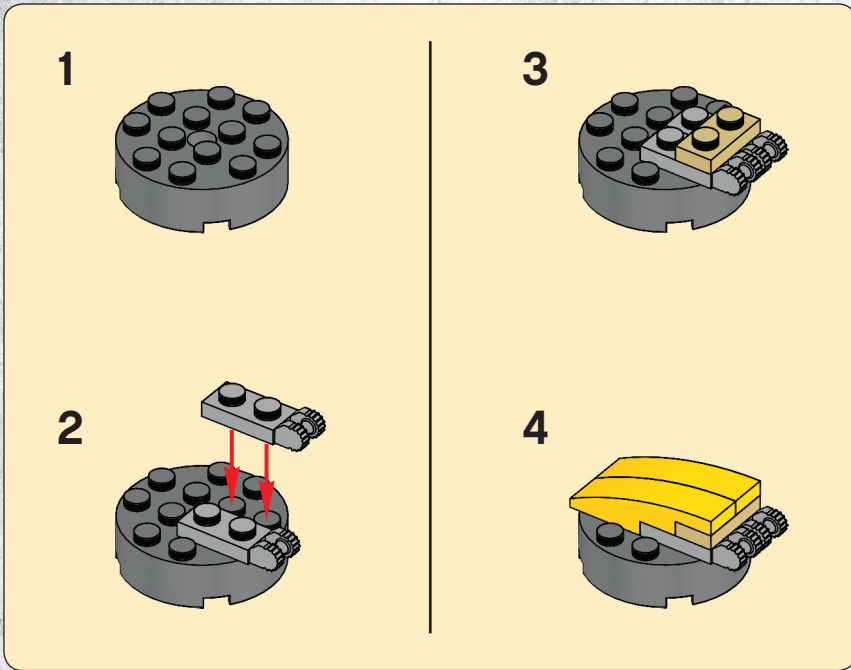

22

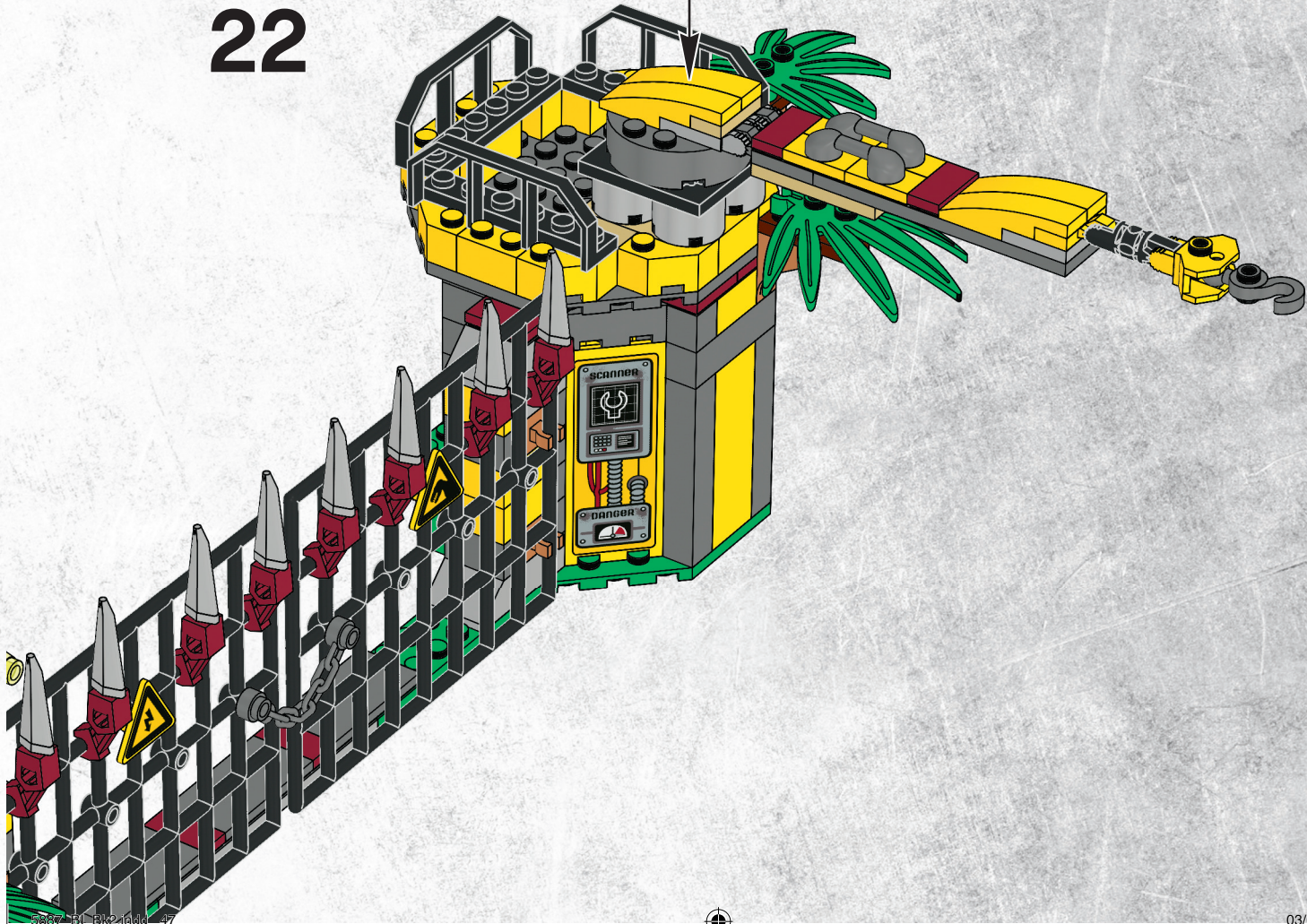

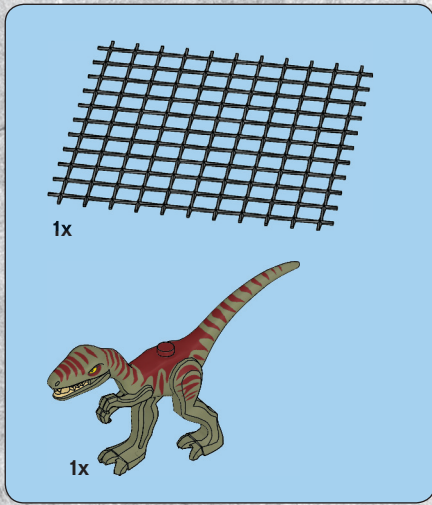

23

1

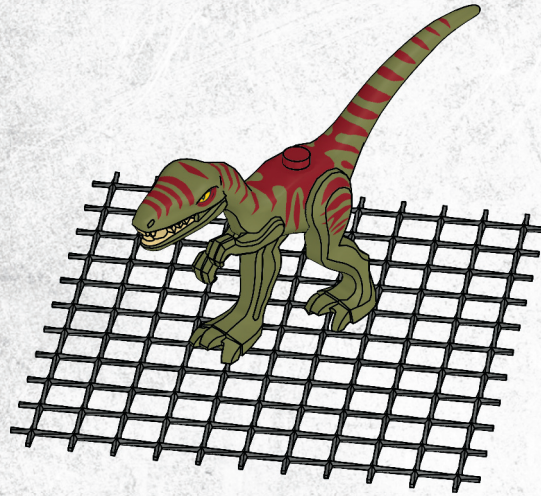

2







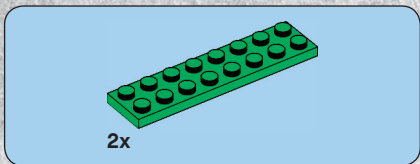
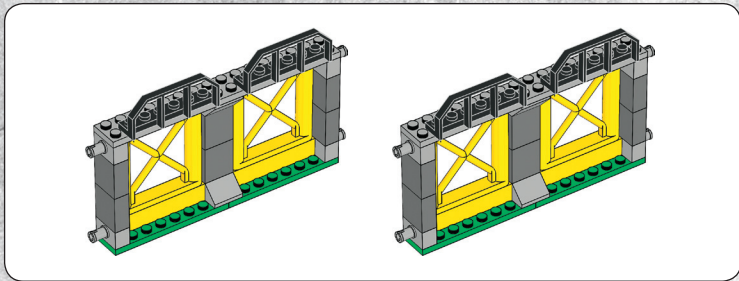

1

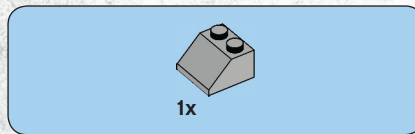
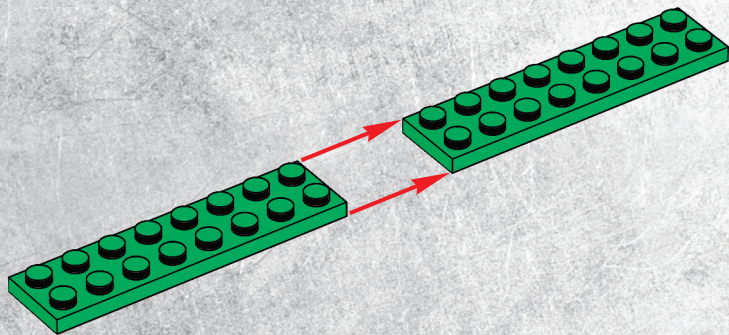

2

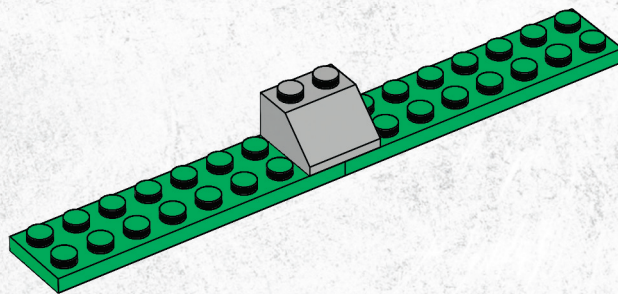

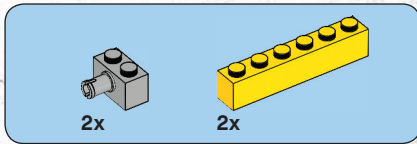

3

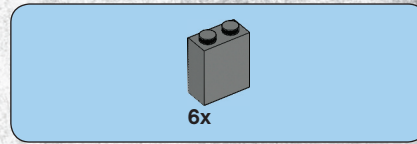
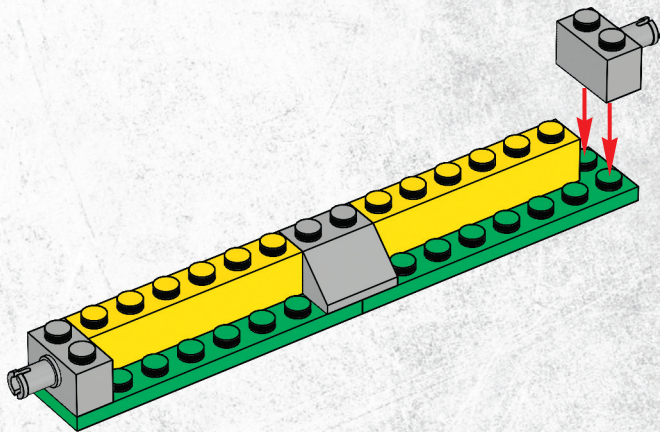

4

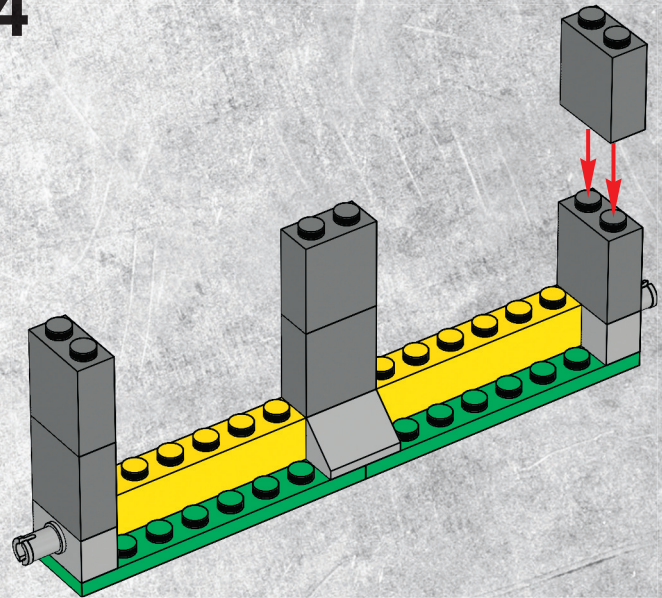

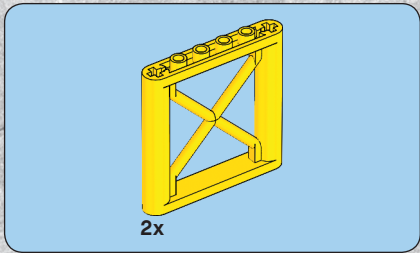

5

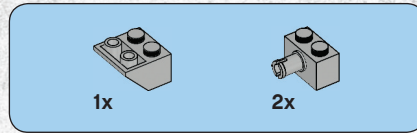
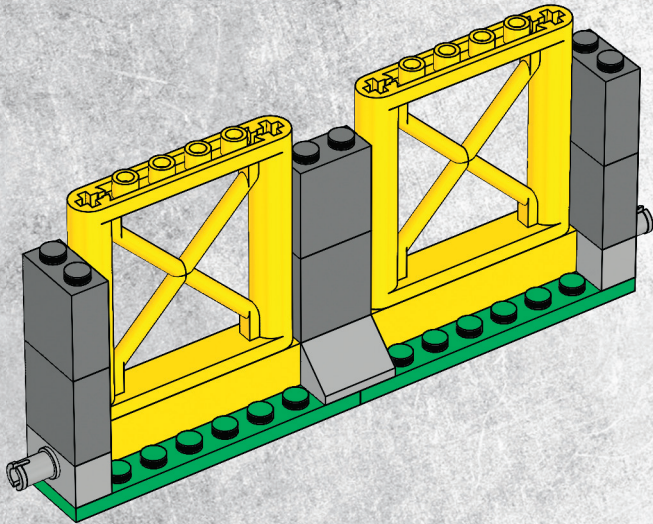

6

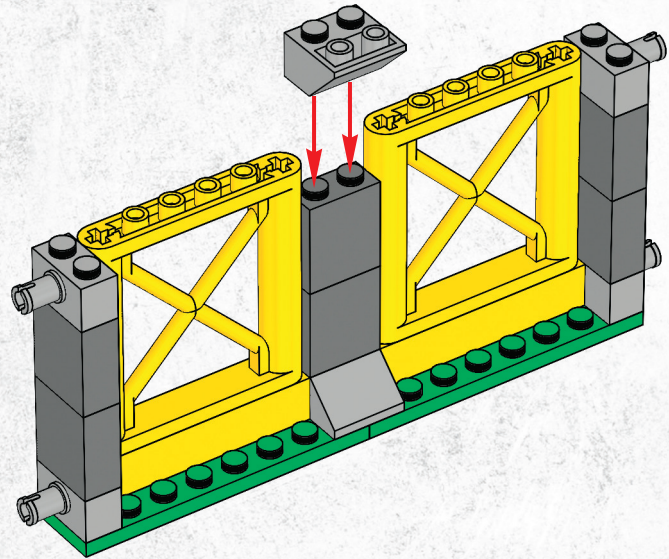

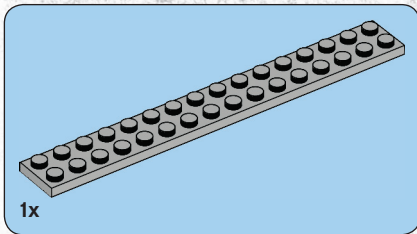

7

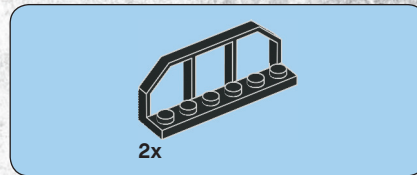
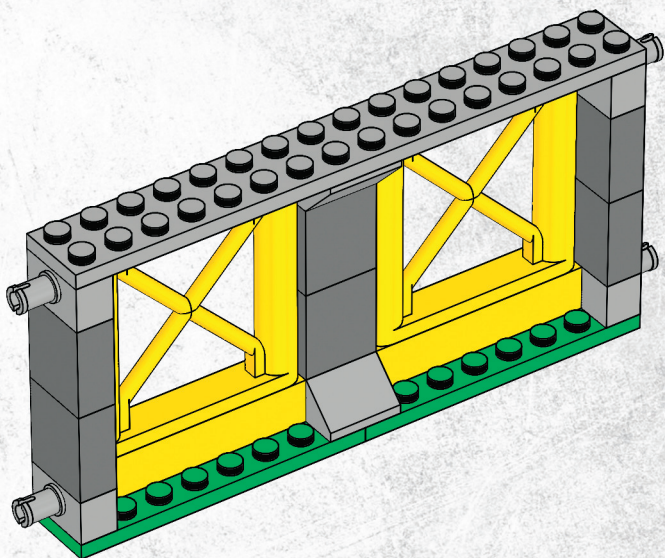

8

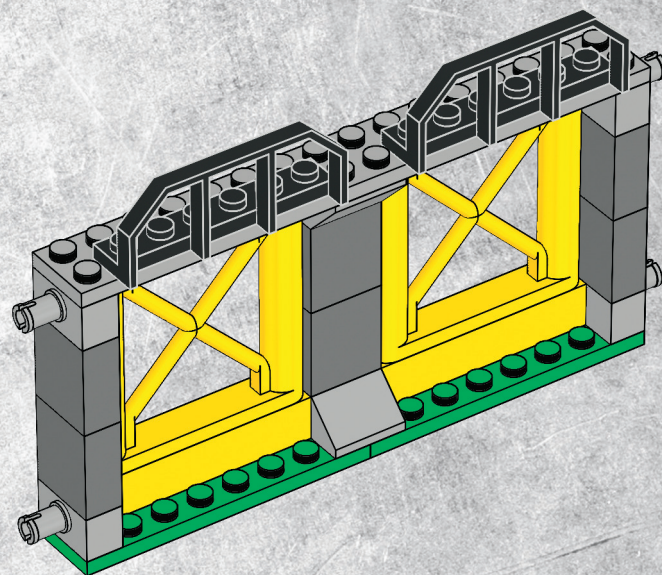

2x

24



54

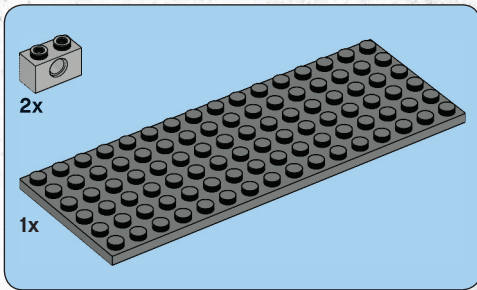
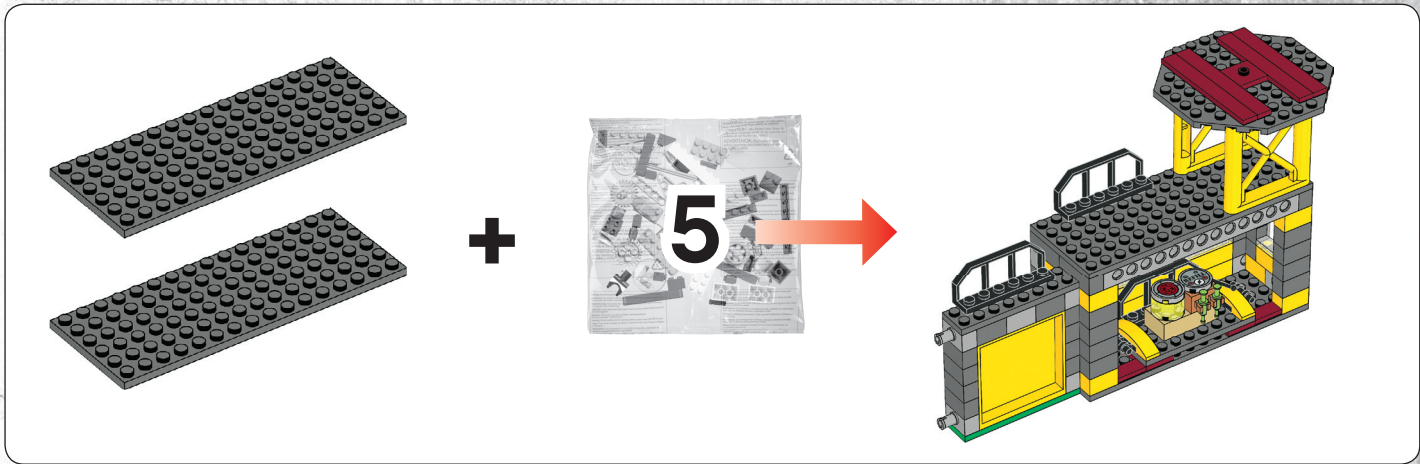

1

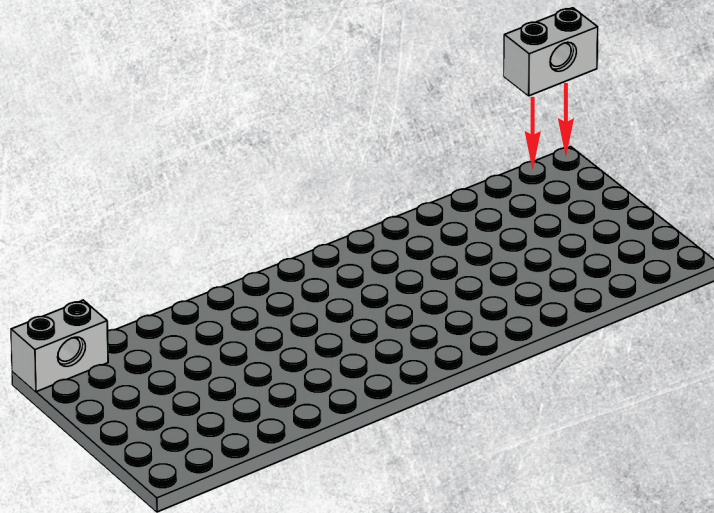



2x



2x

2

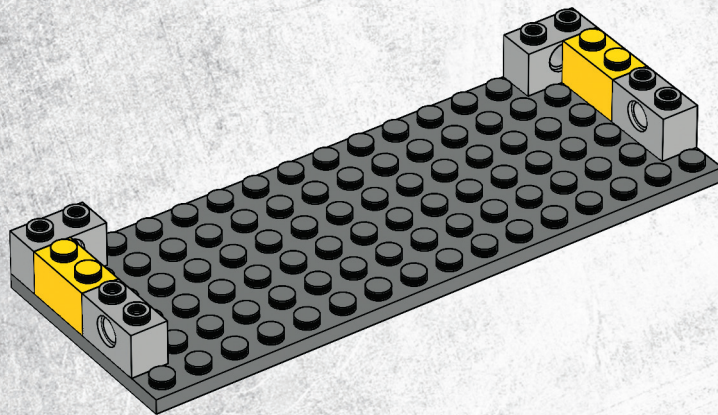



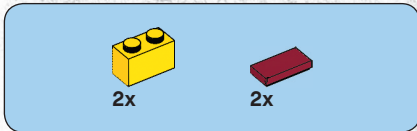

**3**

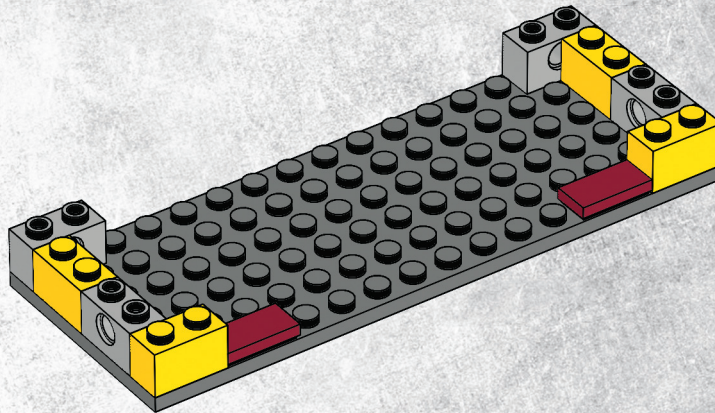

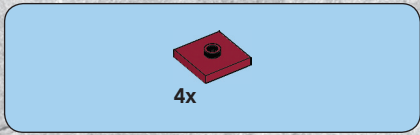

4

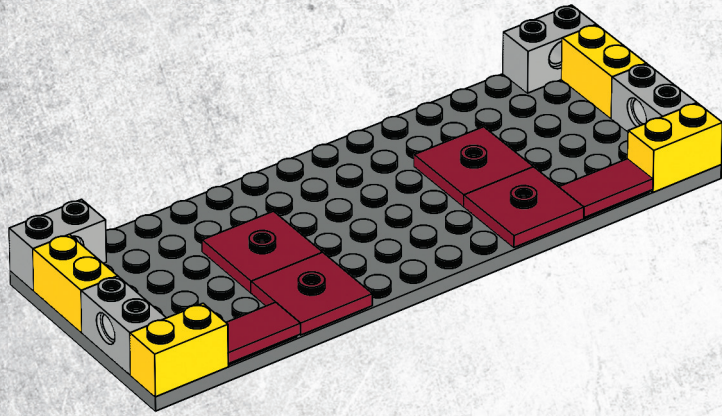

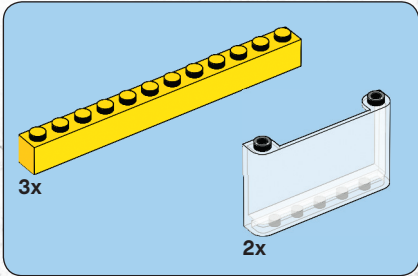
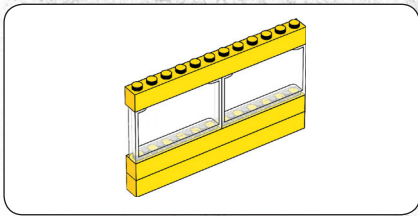

5

1

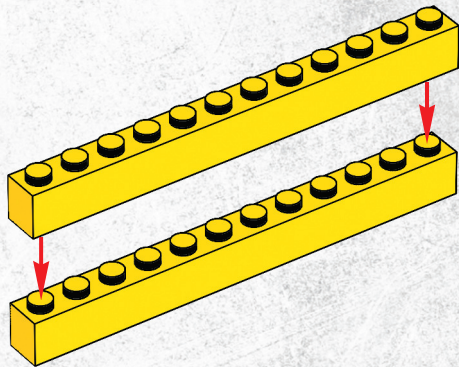

2

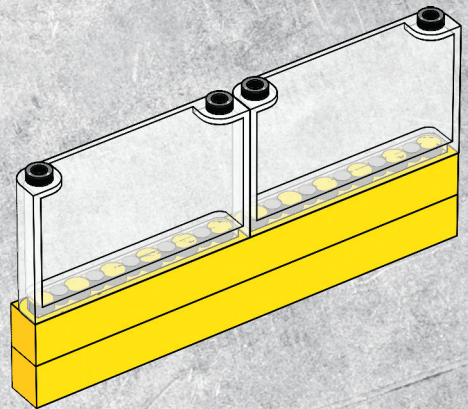

3

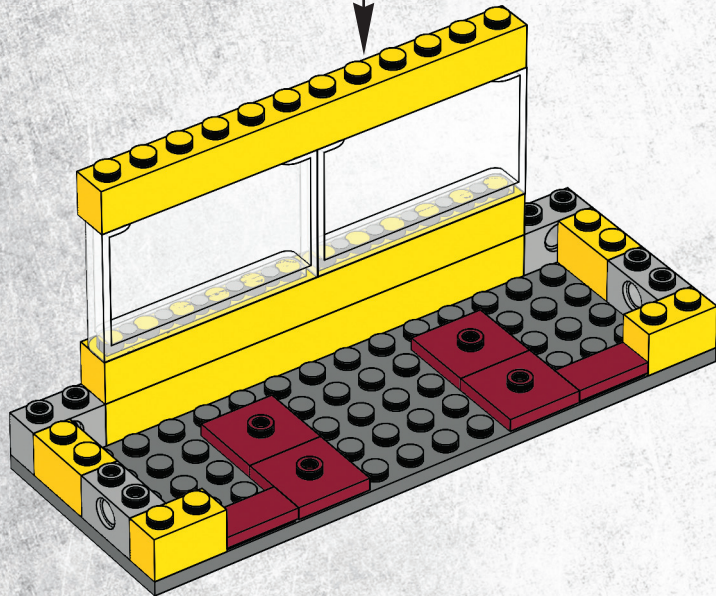
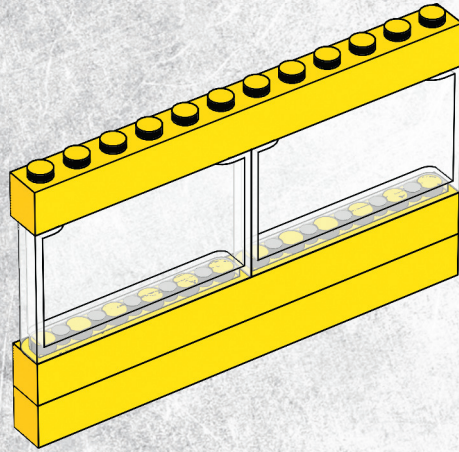

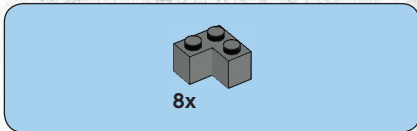

6

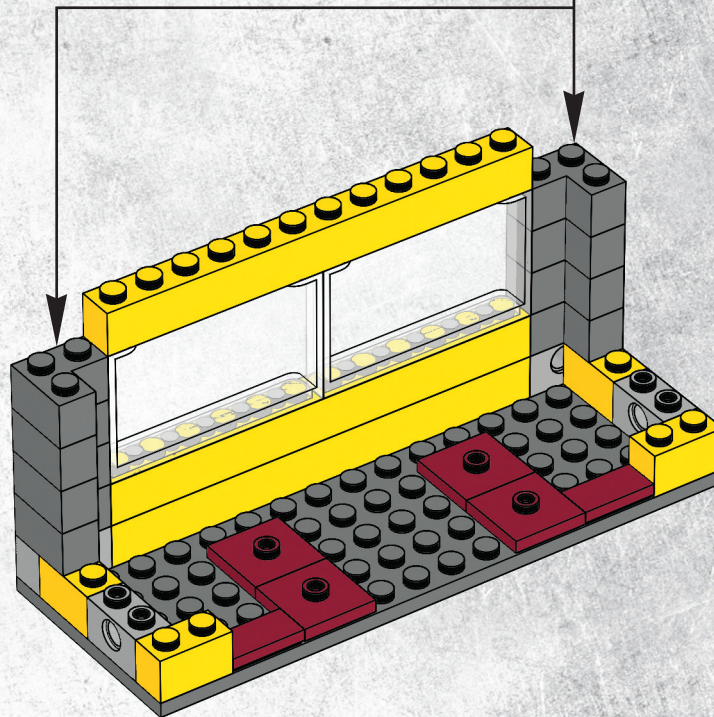
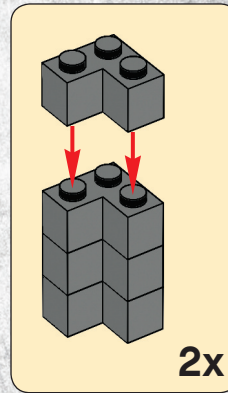

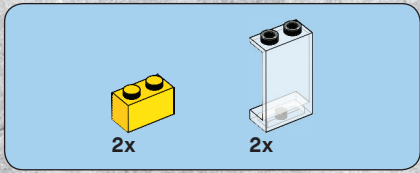

7

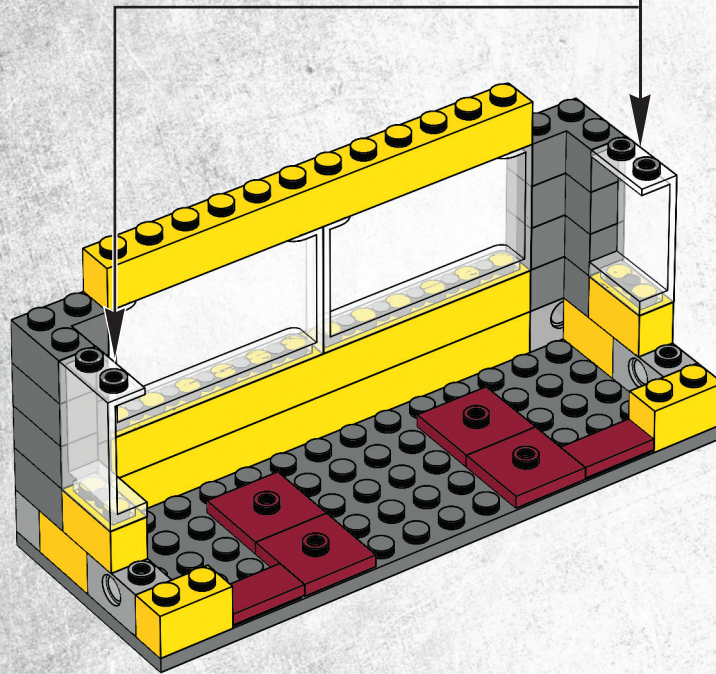
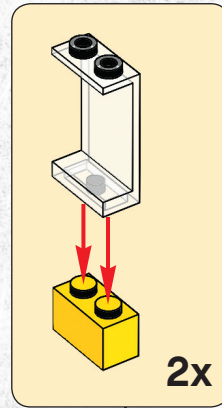

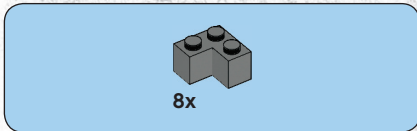

8

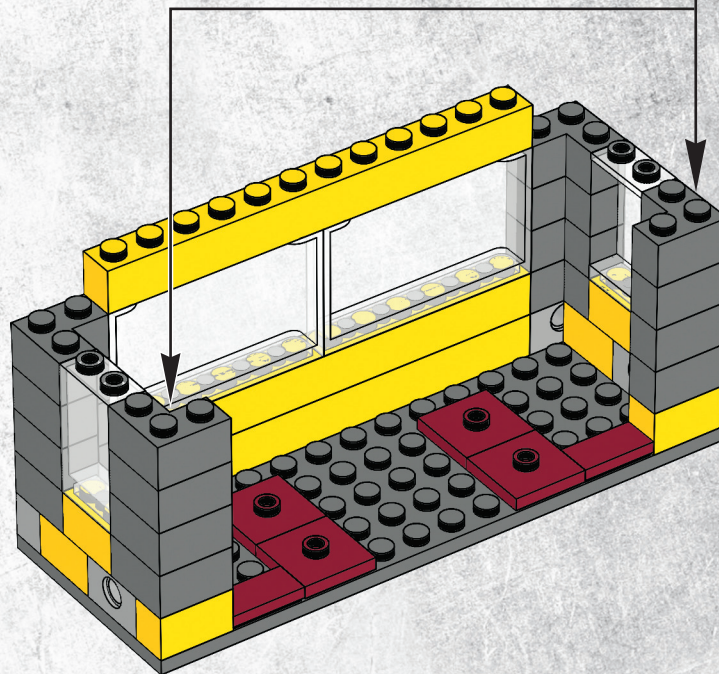
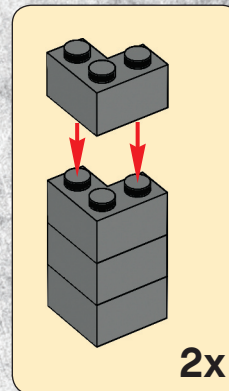



2x



2x

9

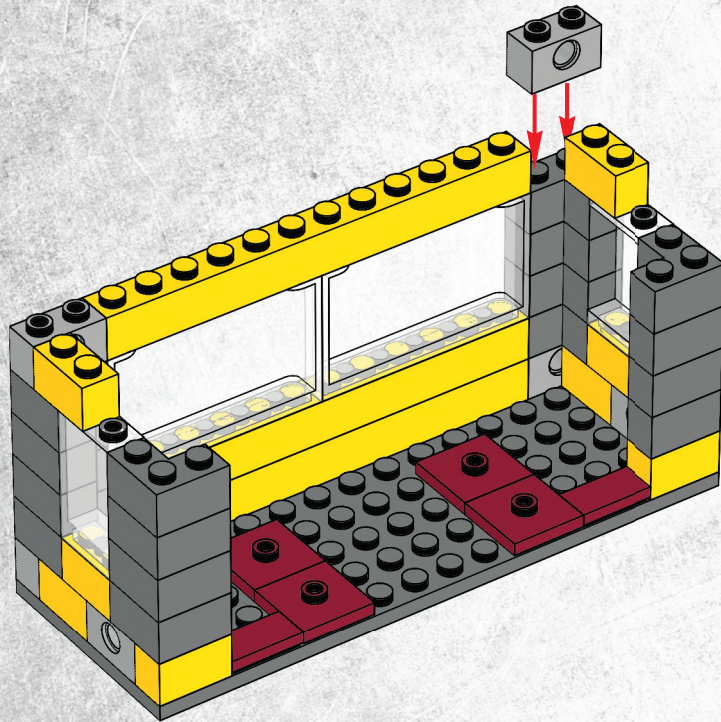





2x



2x

# 10

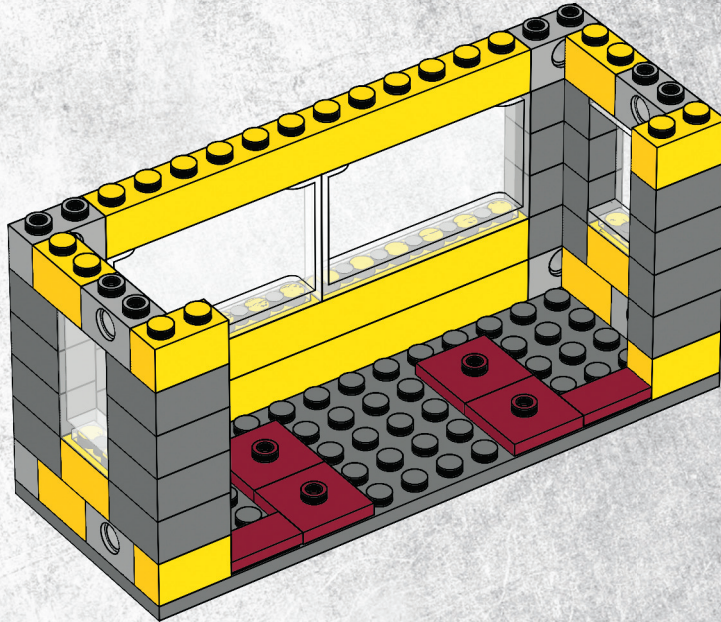



4x

# 11

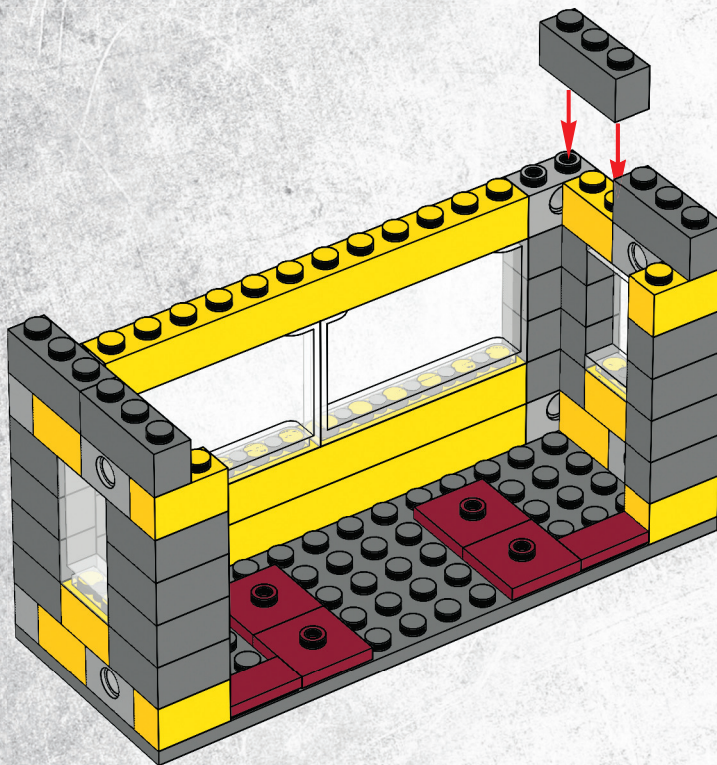

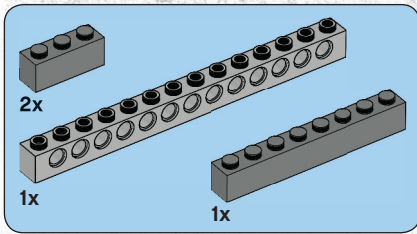

# 12

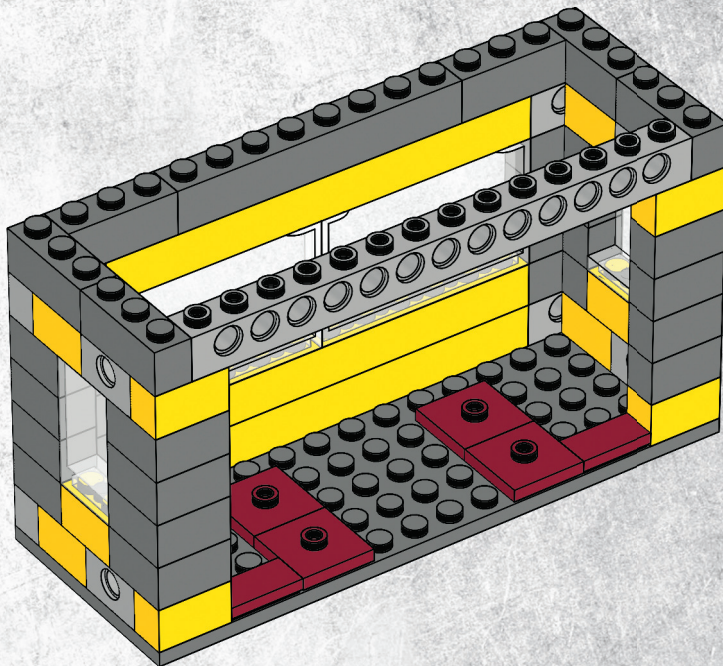

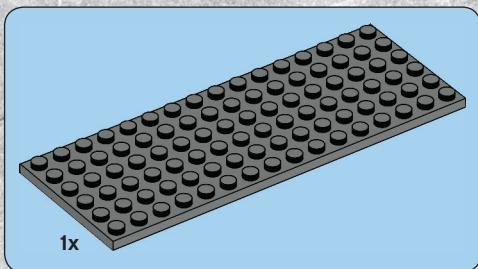

13

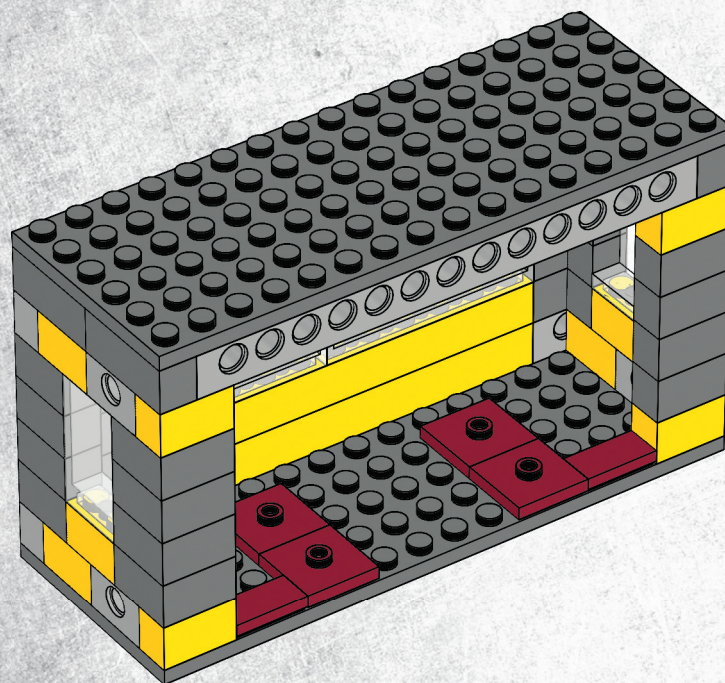

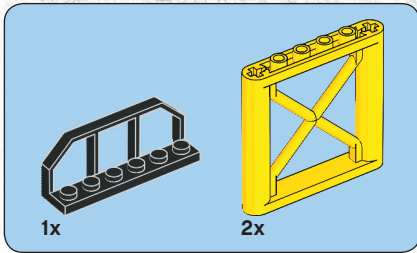

14

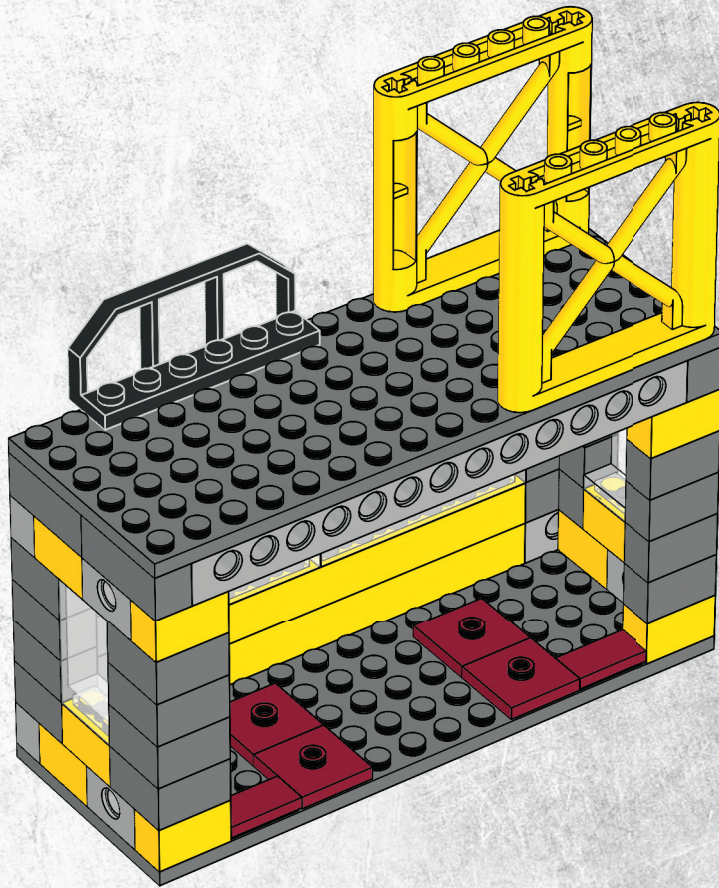

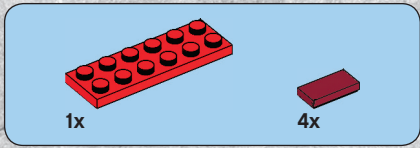

15

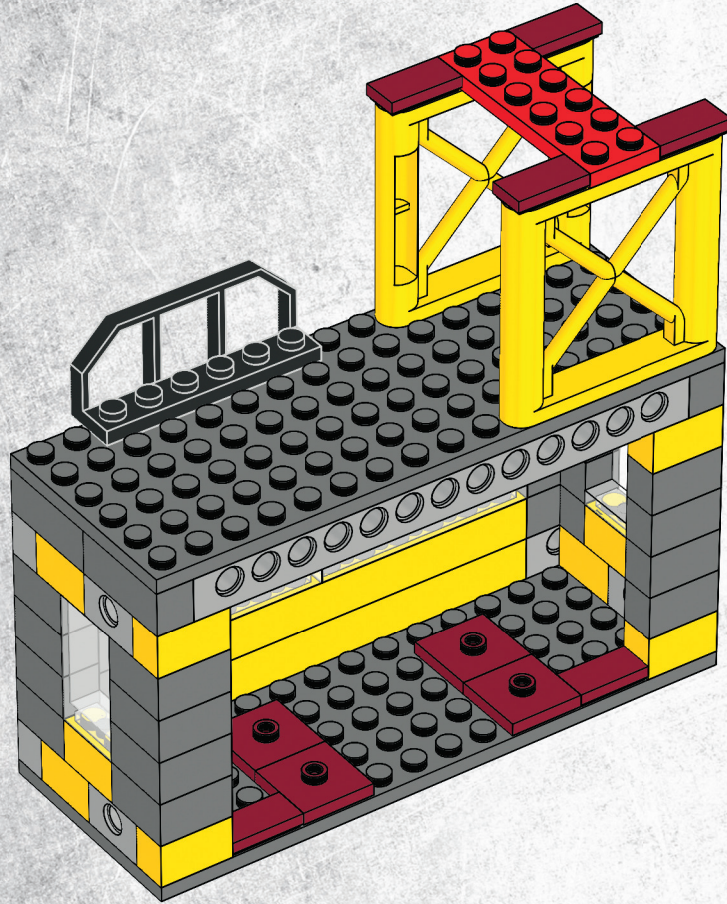

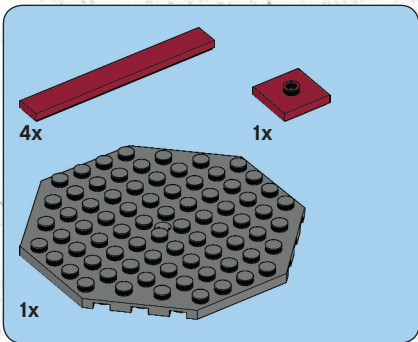
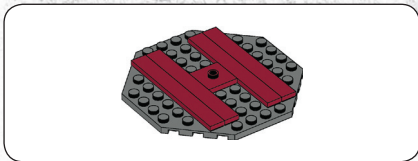

16

1

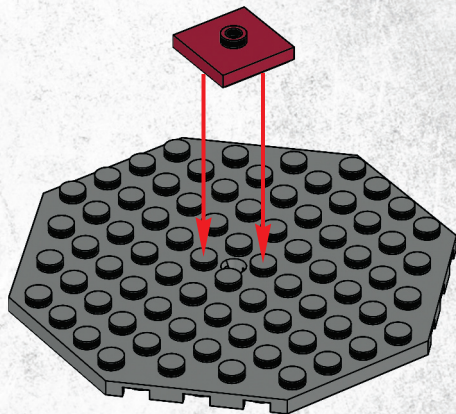

2

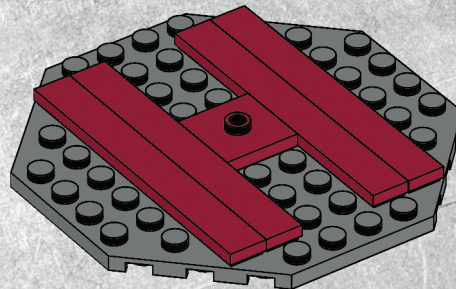

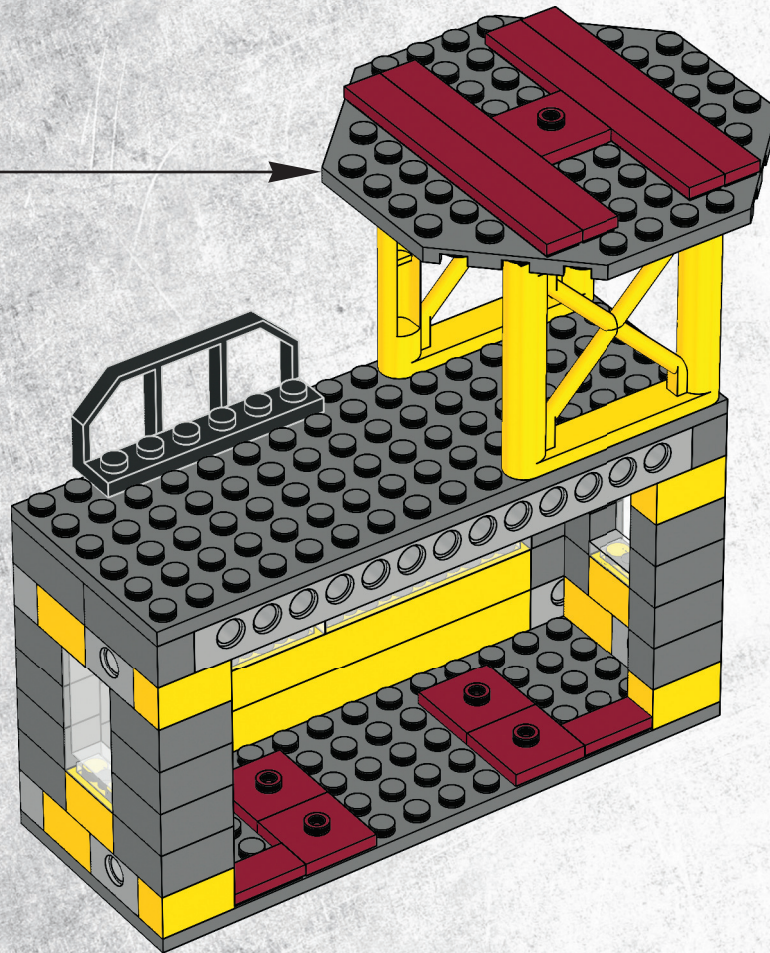



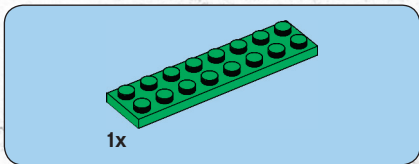
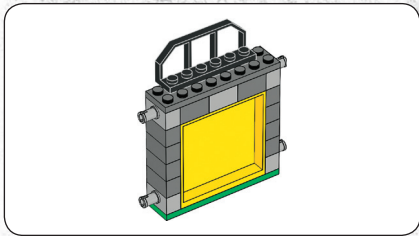

1x

1

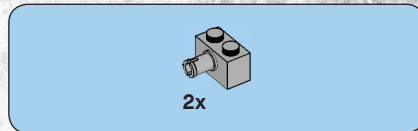
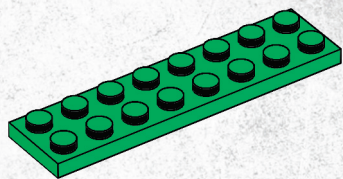

2x

2

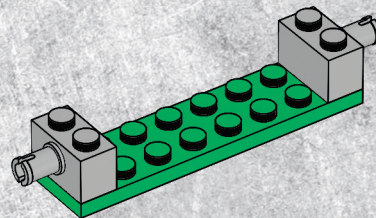

2x

3

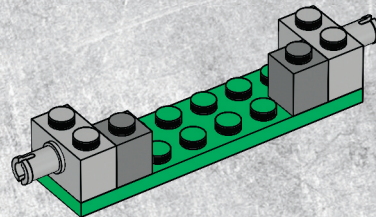

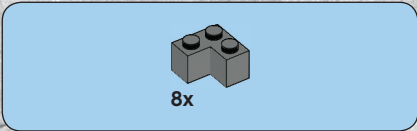

4

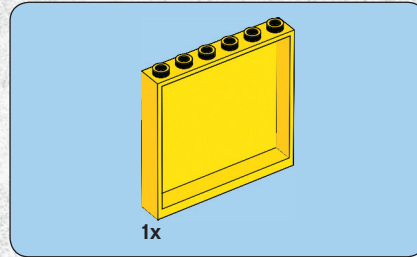
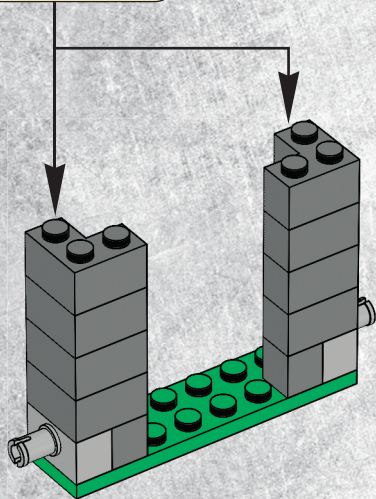
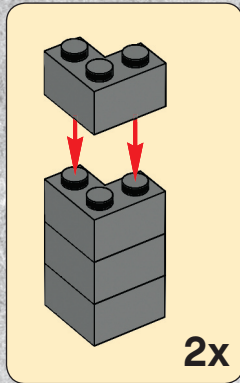

5

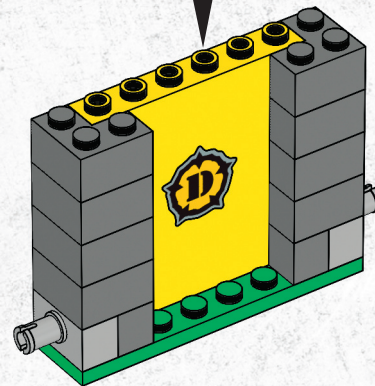
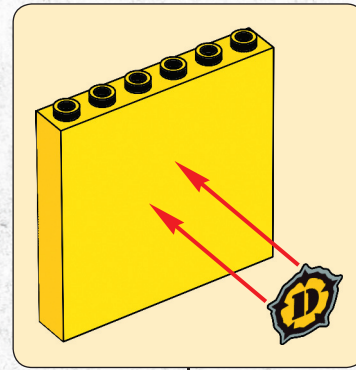

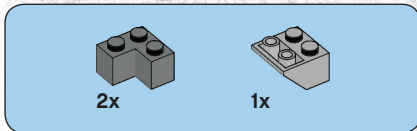

6

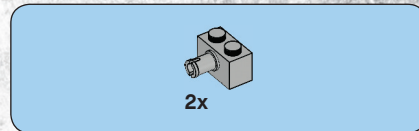
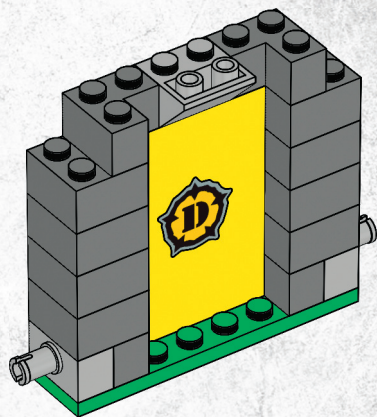

7

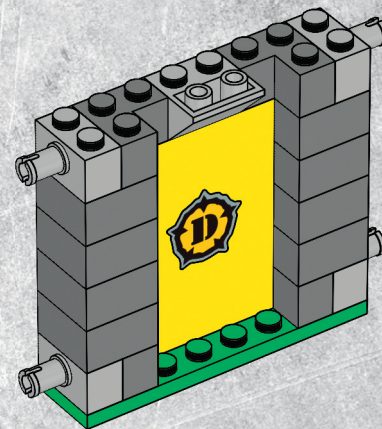

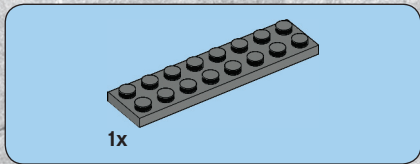

8

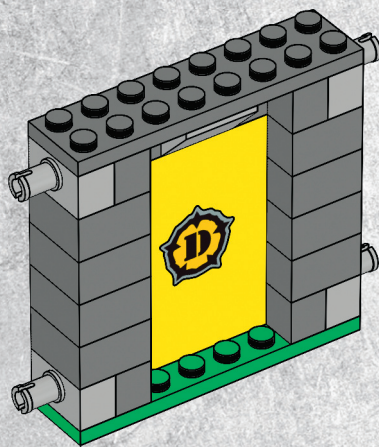

76

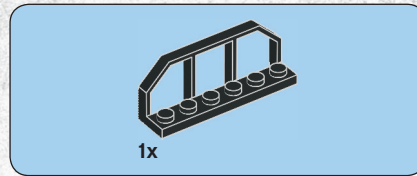

9

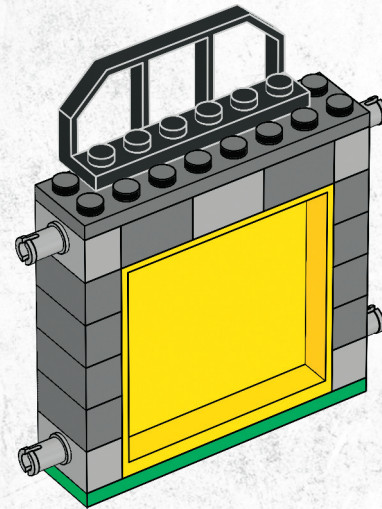
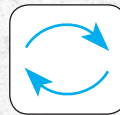

17

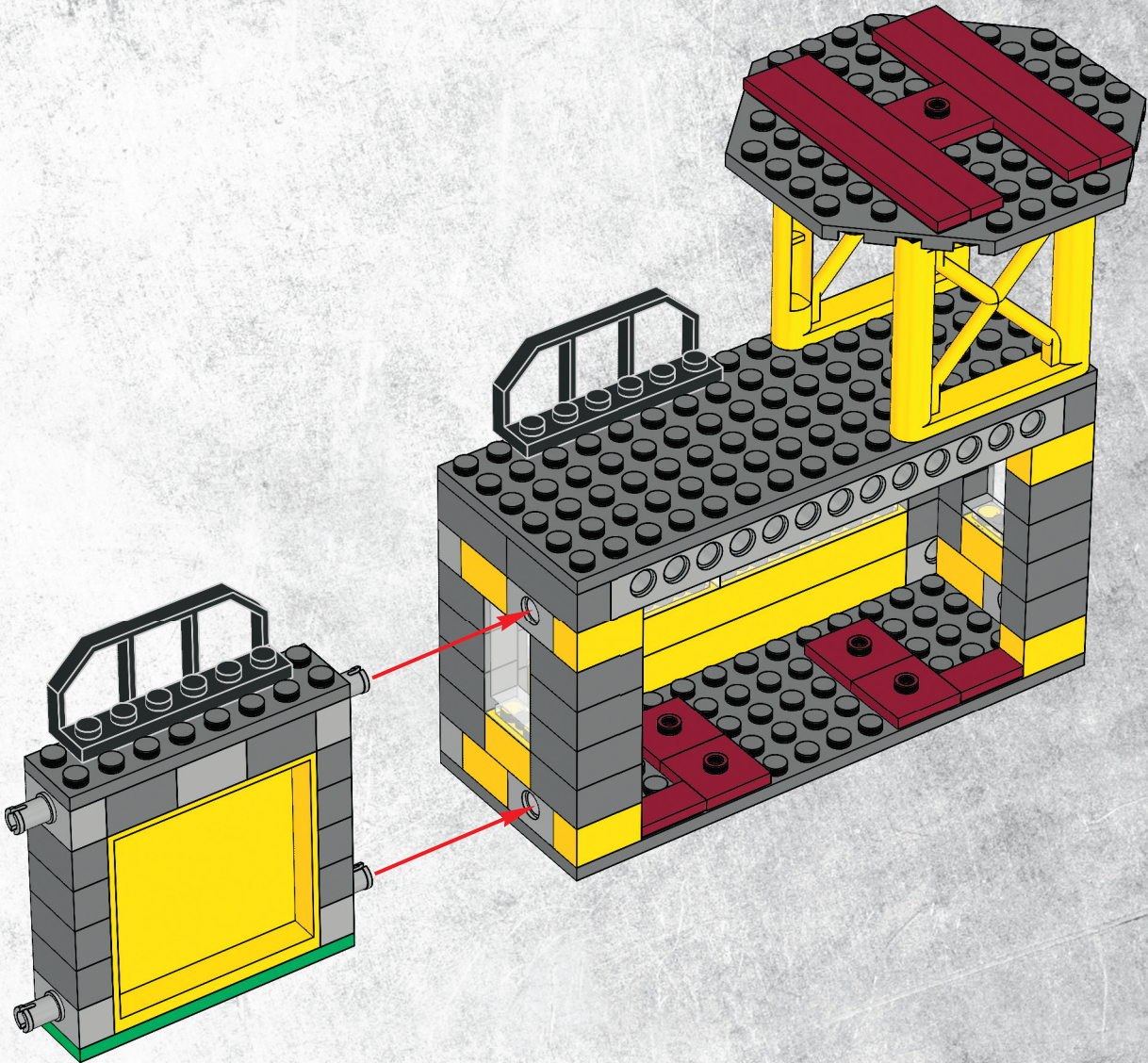

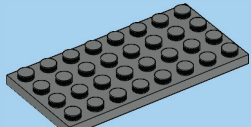
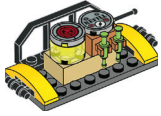

1x

1

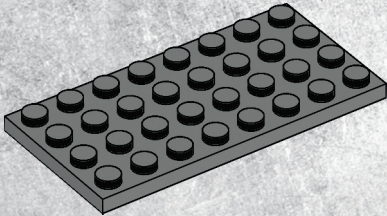

2x

2

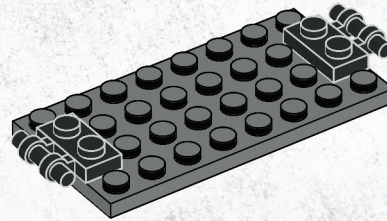

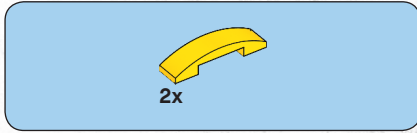

3

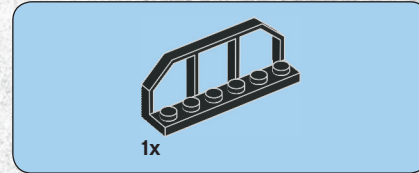
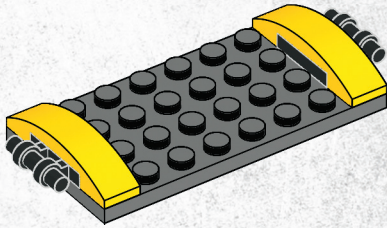

4

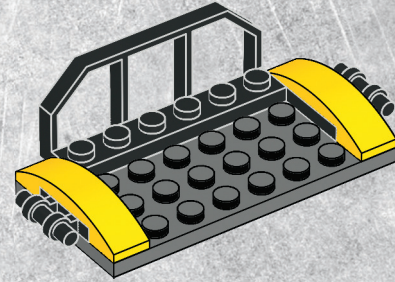

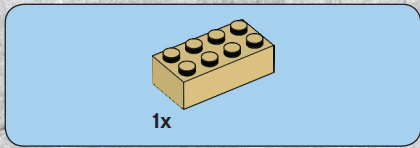

5

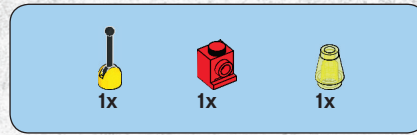
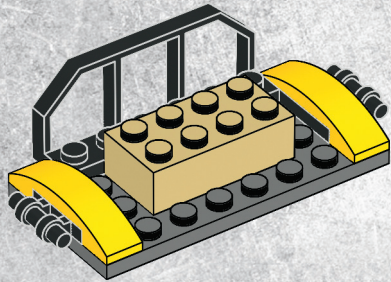

6

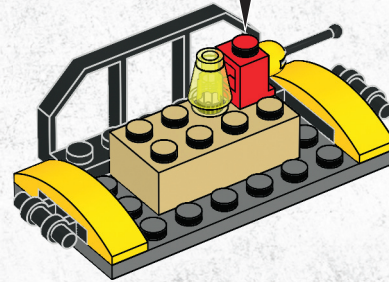
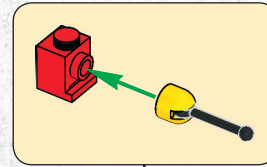





7

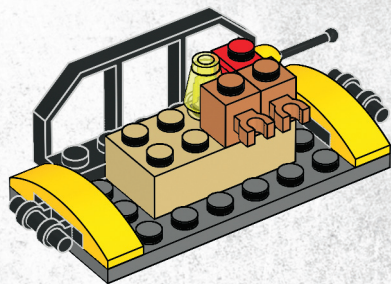

8

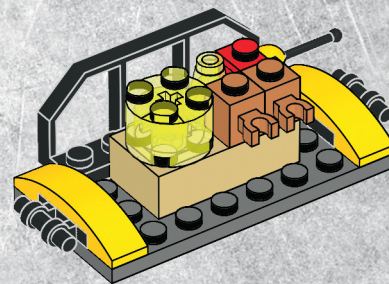



2x

9

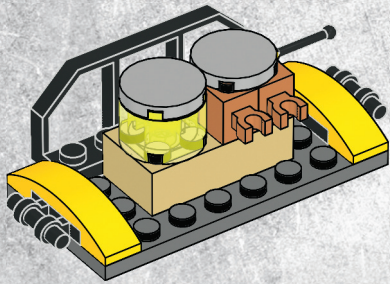

2x

10

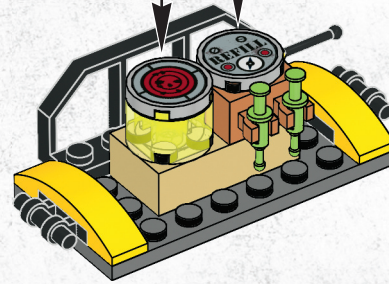
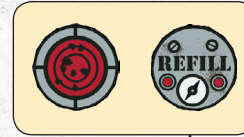

18

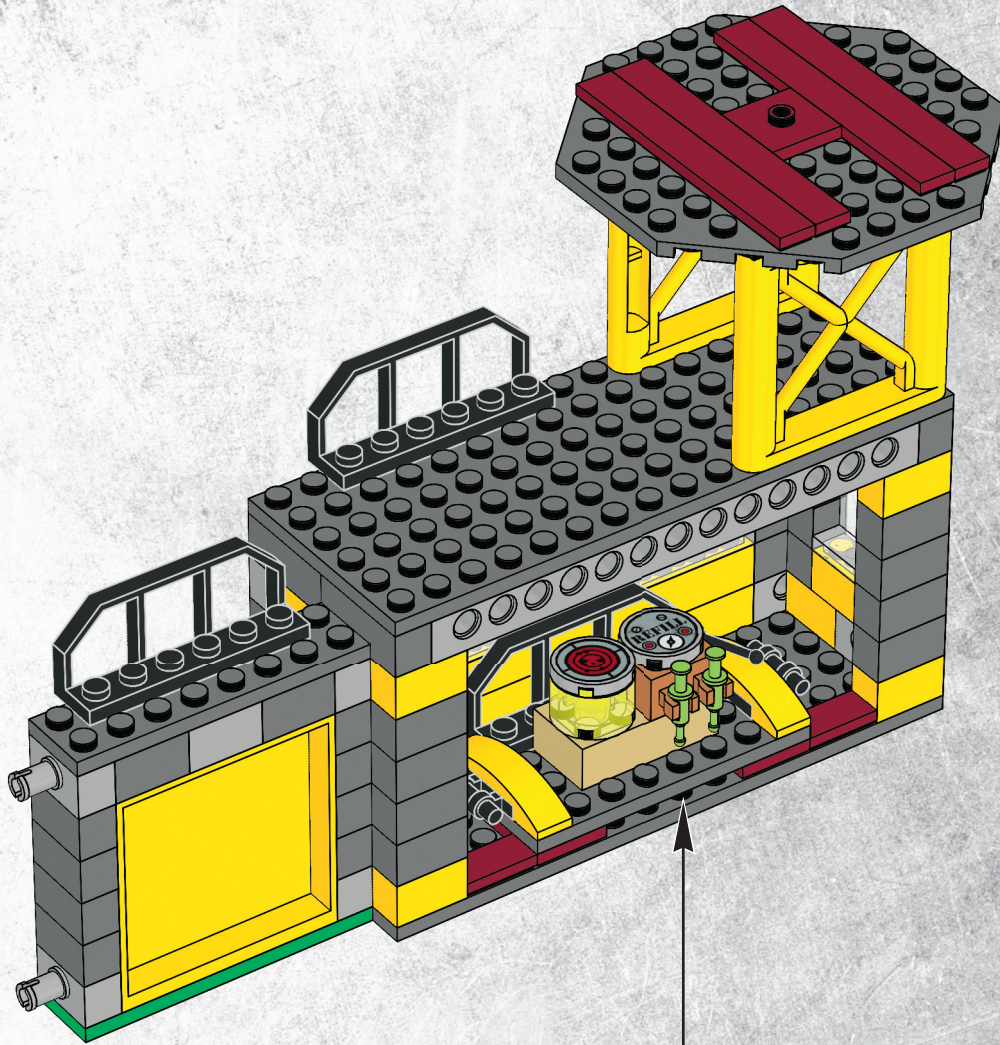

19

