



# CITY

60004





3



4

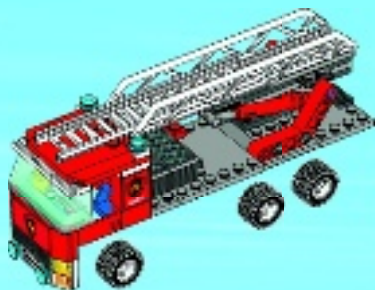

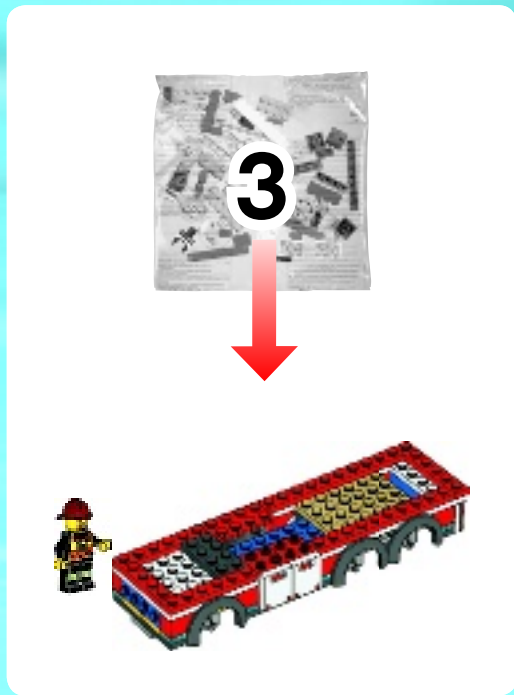

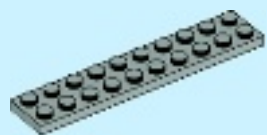

1x

1

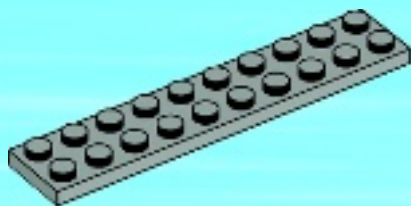



1x



1x

# 2

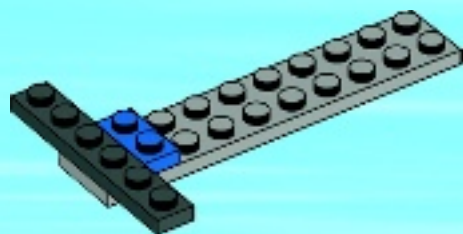

1x



2x

# 3

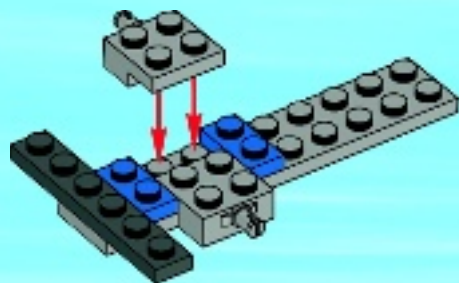



1x

4

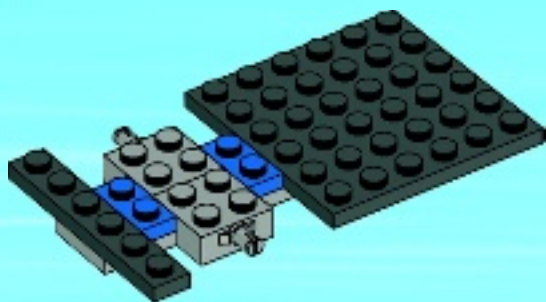

6



2x

5

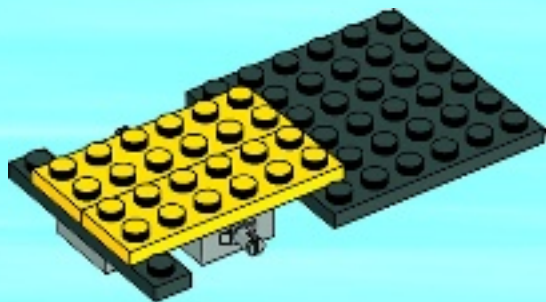

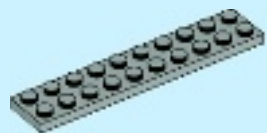

1x

1

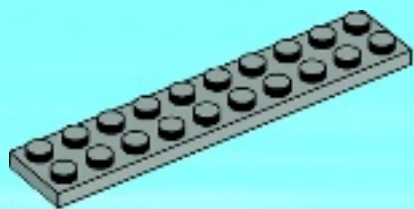





1x



1x

2

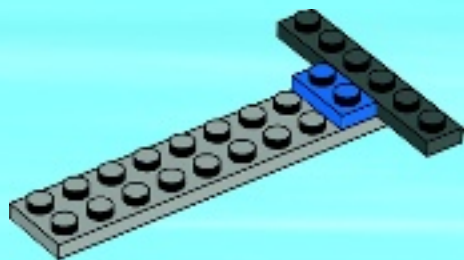

1x



2x

3

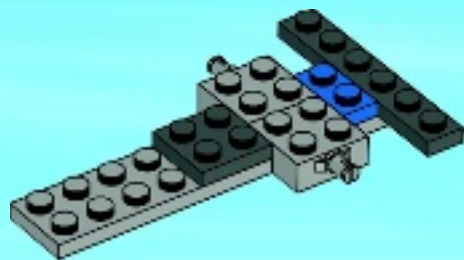



1x



2x

4

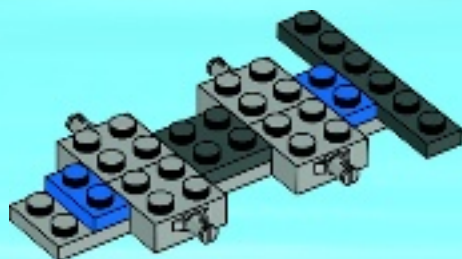

6

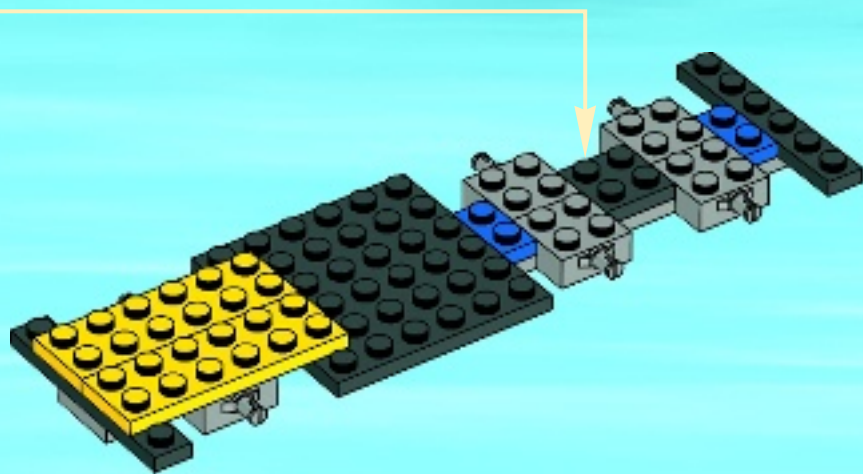

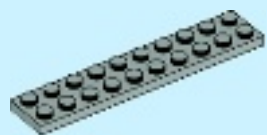

2x

7

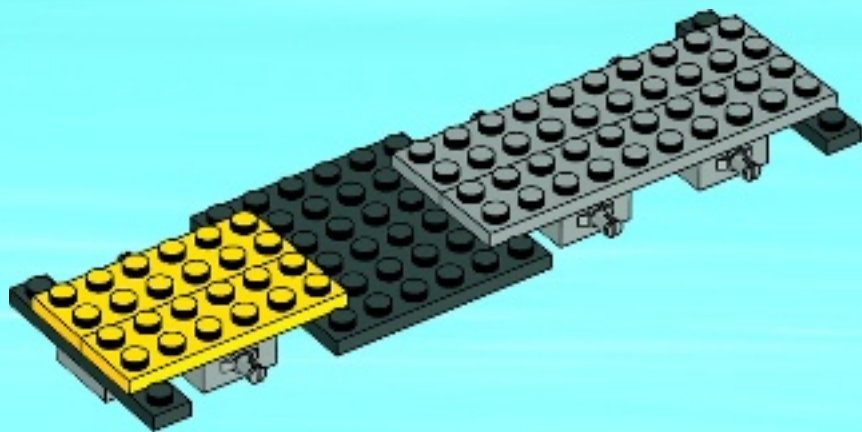



8x

8

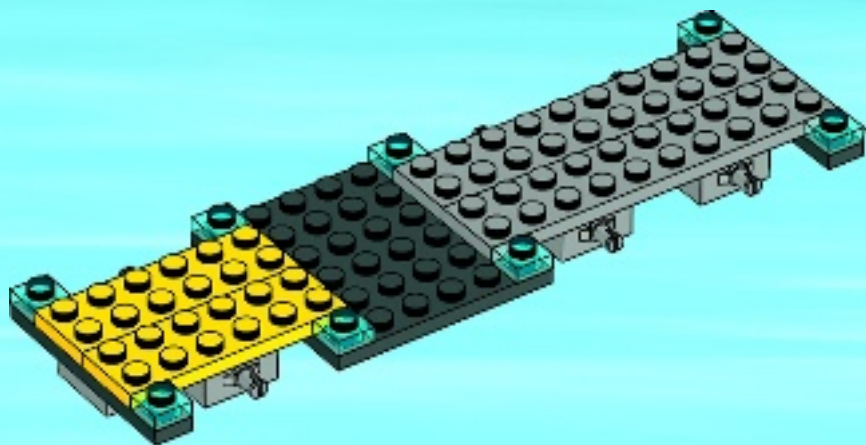



1x

9

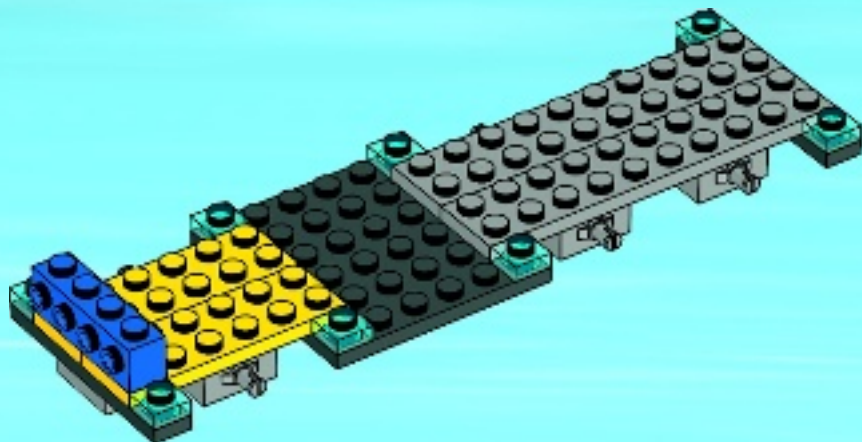

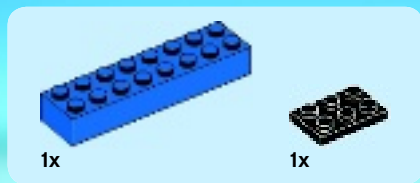

10

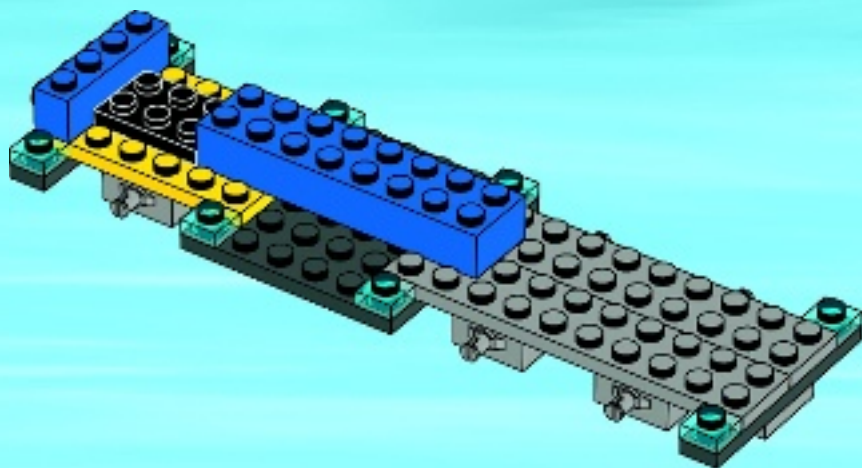



2x

11

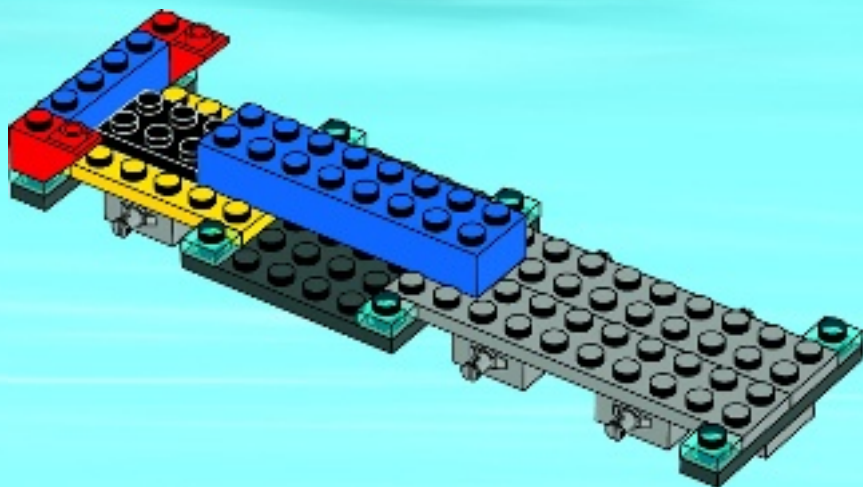





2x

12

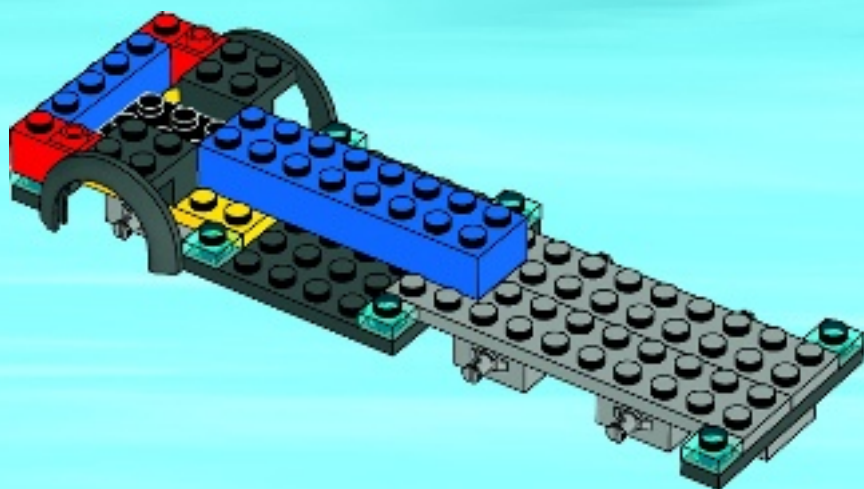



2x

13

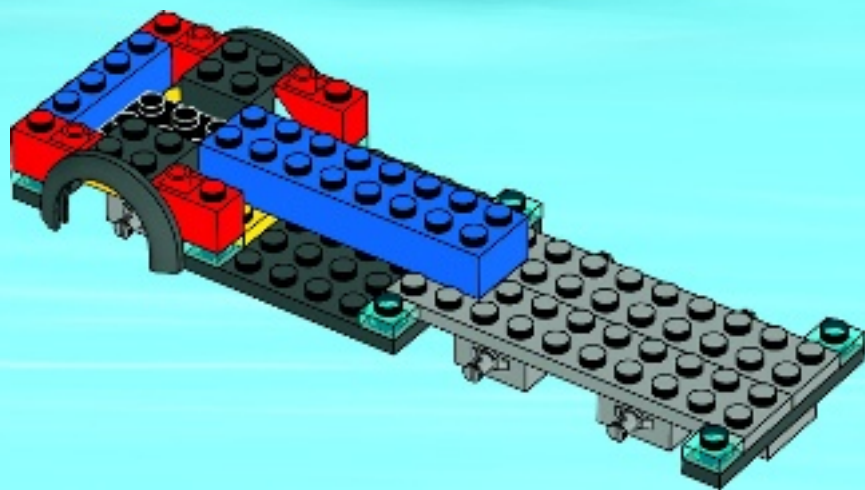



1x

14

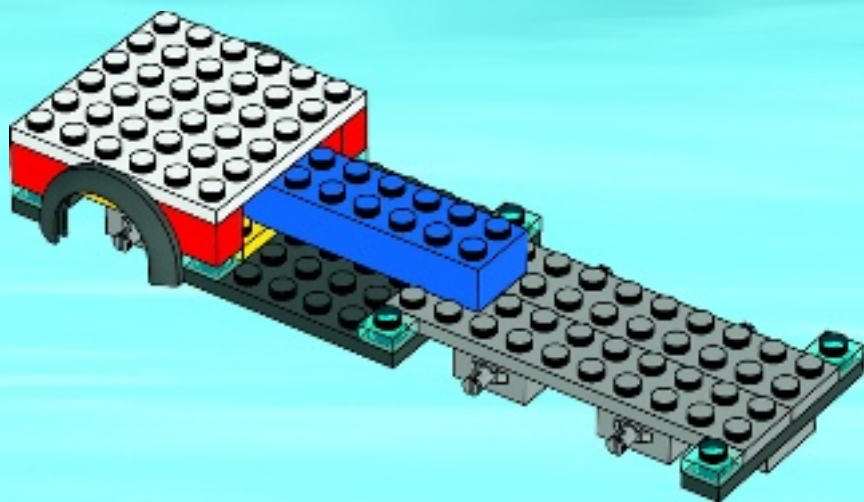



2x

15

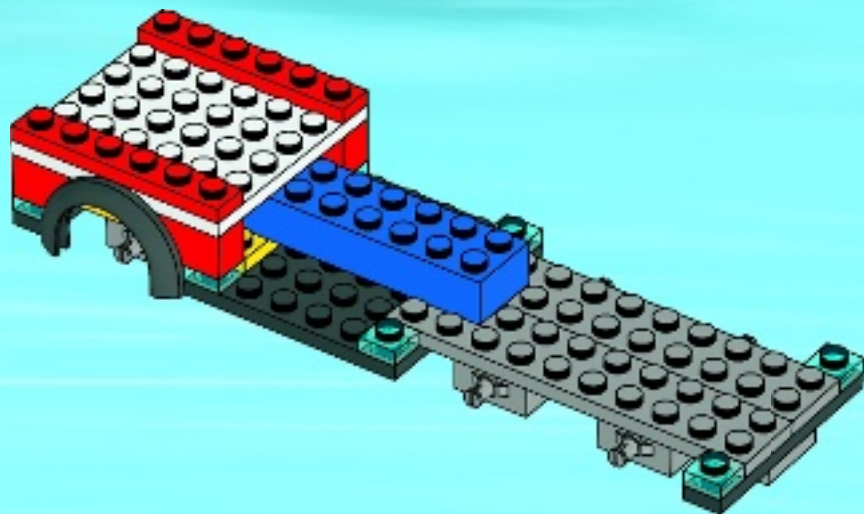



1x



1x

# 16

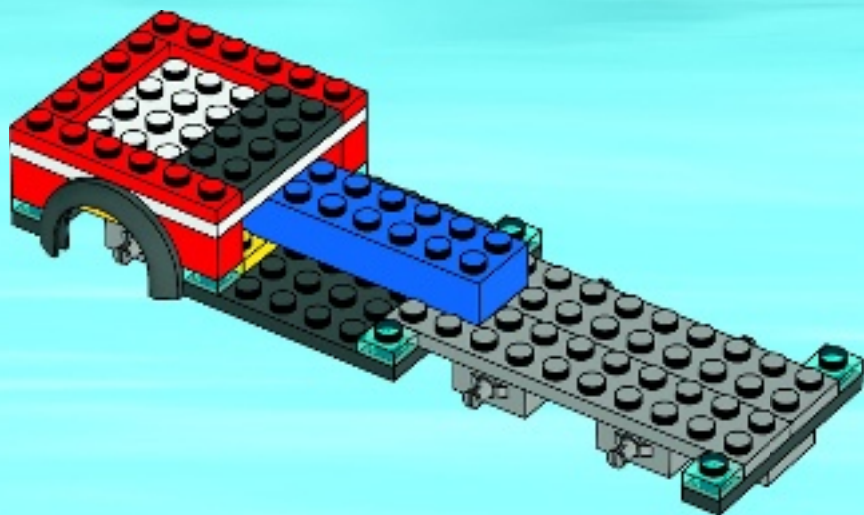



2x



2x



2x



2x

# 17

1

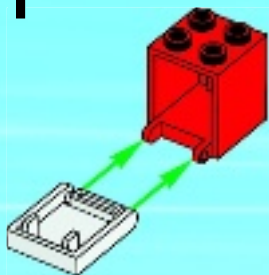

2

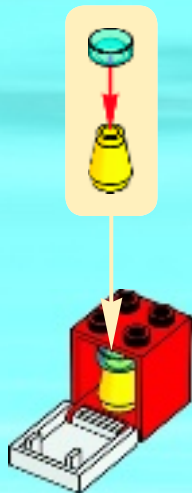

3



# 2x

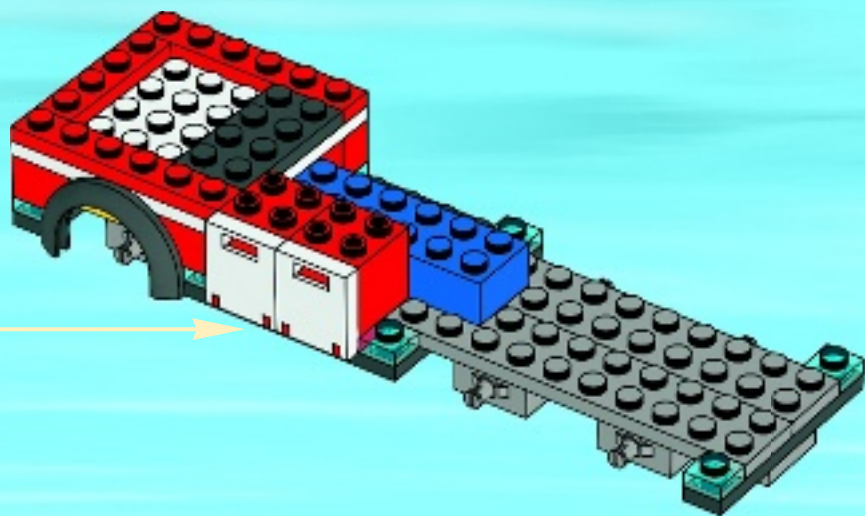

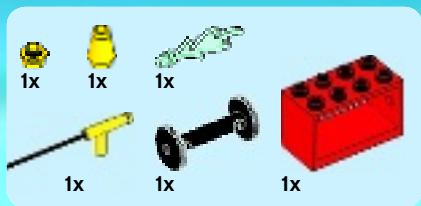

18

1



2





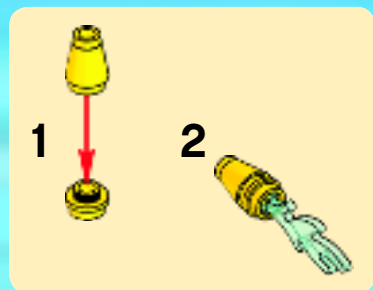

3



4



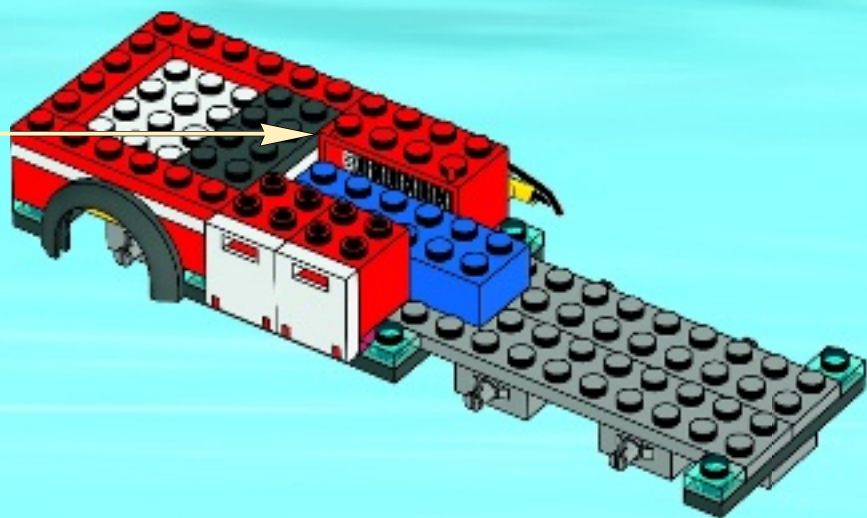



2x

19

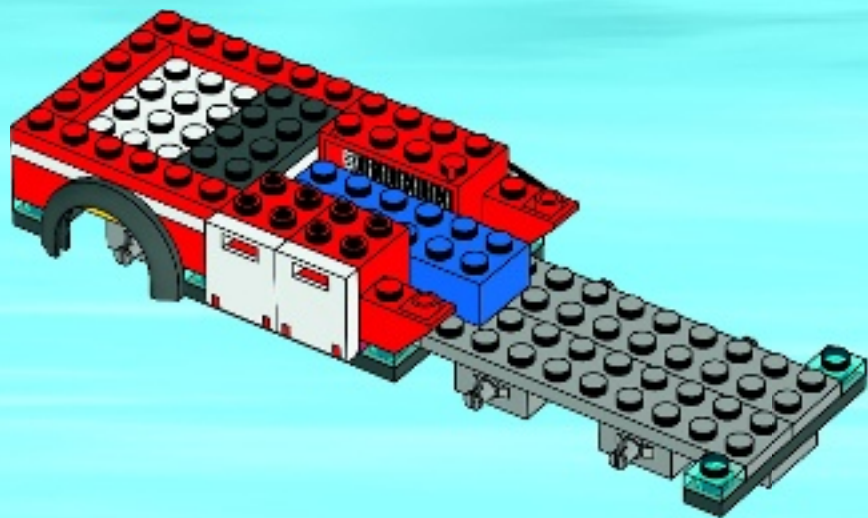



1x

20

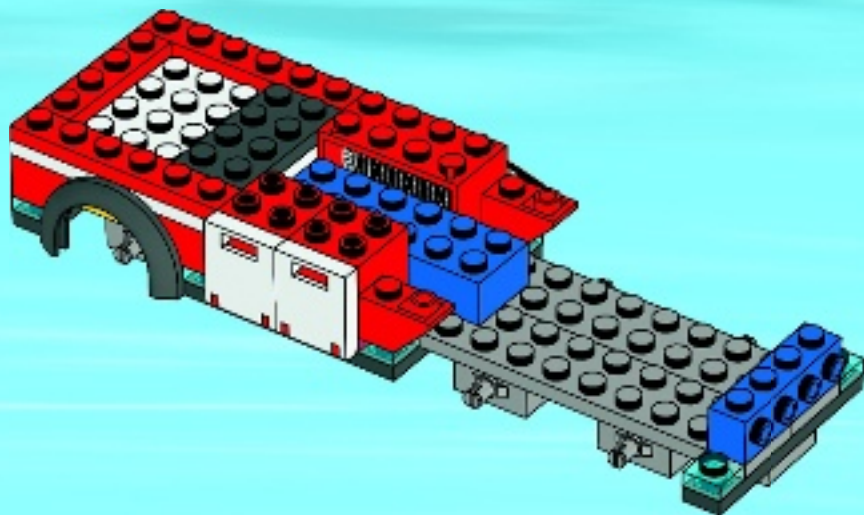





4x

22

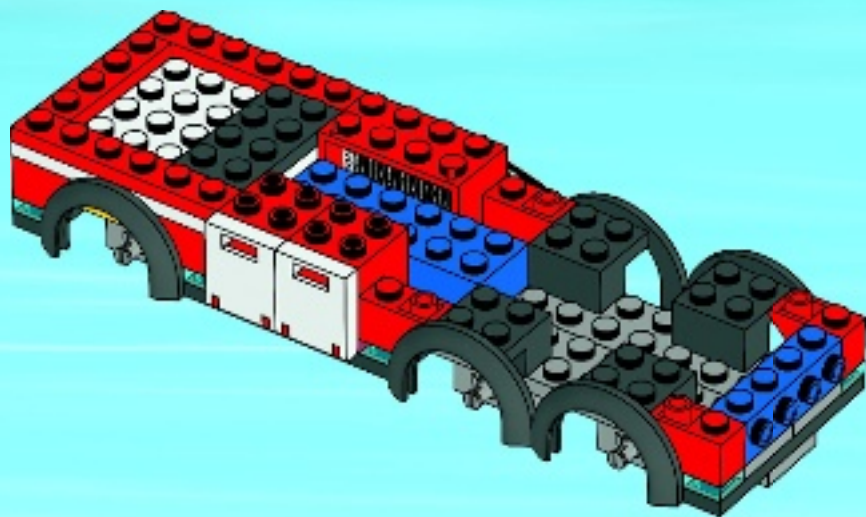



2x



1x

# 23

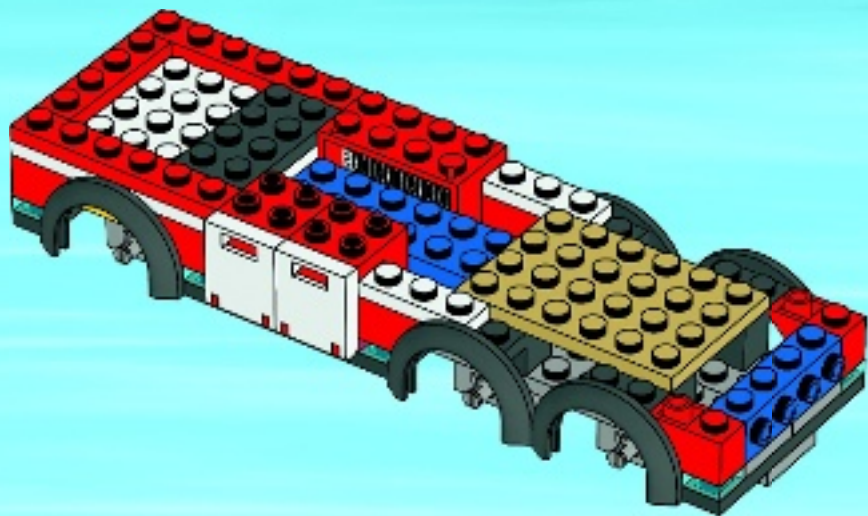



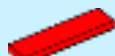

1x



2x



2x



1x



2x



1x

# 24

## 1

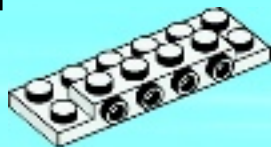

## 2

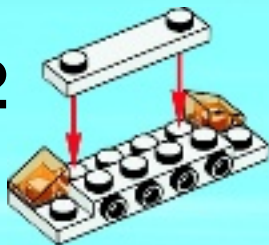

## 3

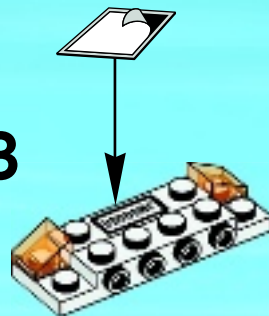



4



5

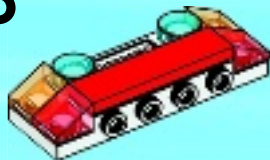

6

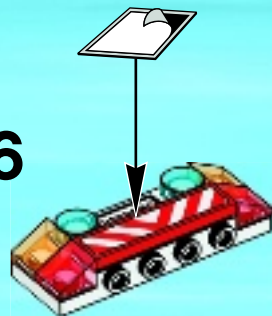



7

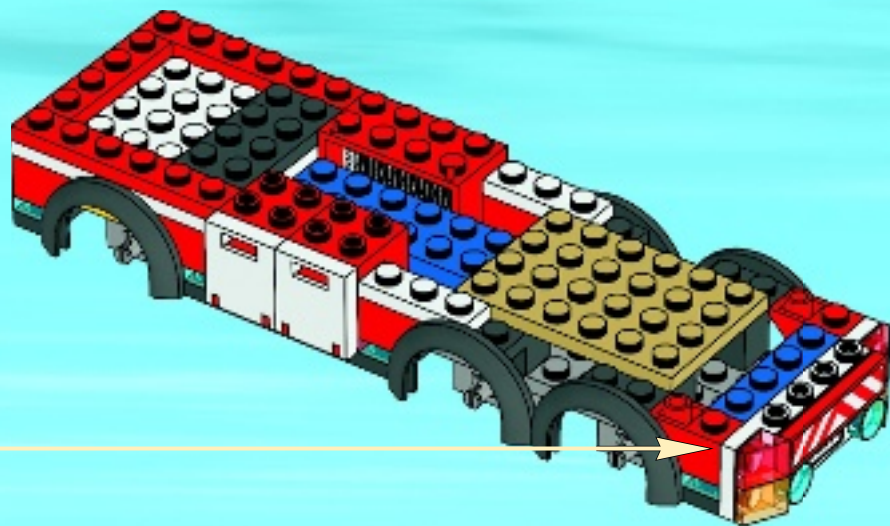



1x

25

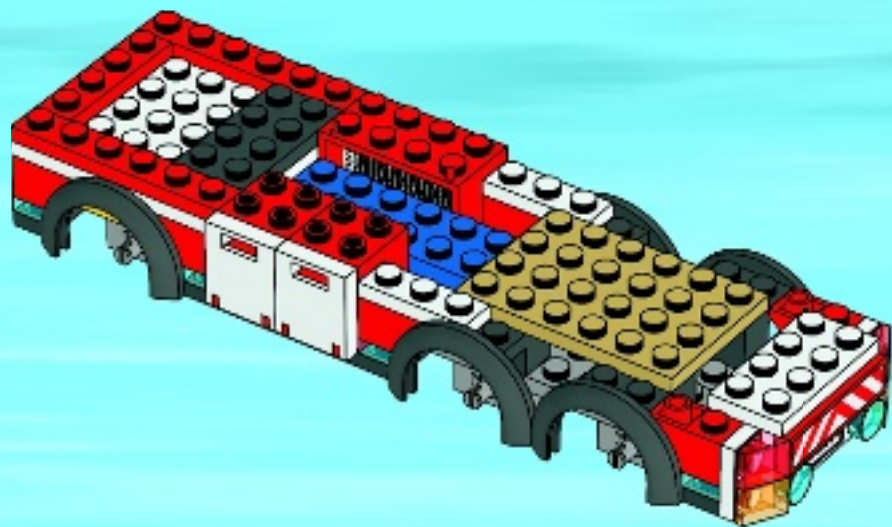



2x

26

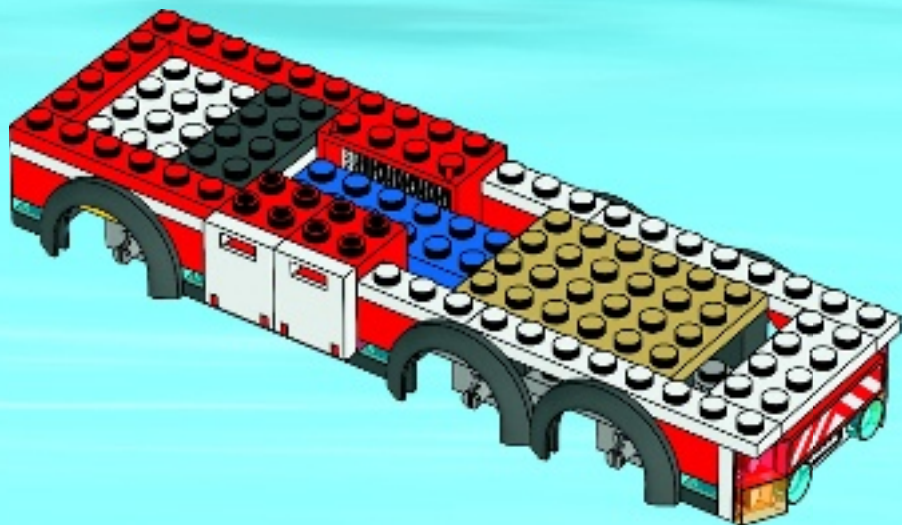

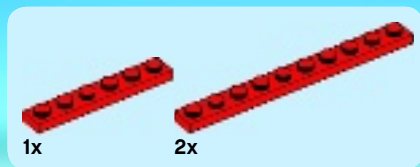

27

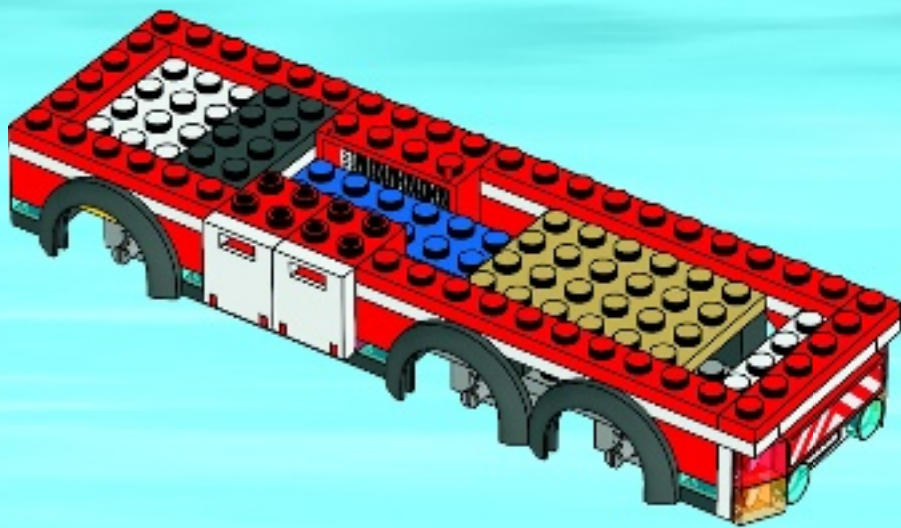



4



1x



1x

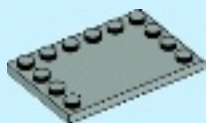

28

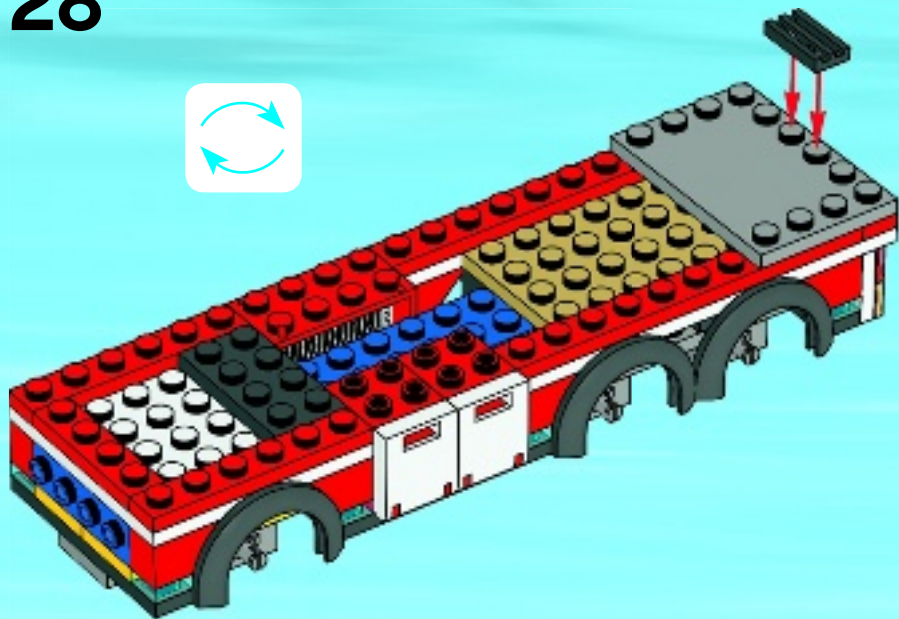





2x



1x

# 29

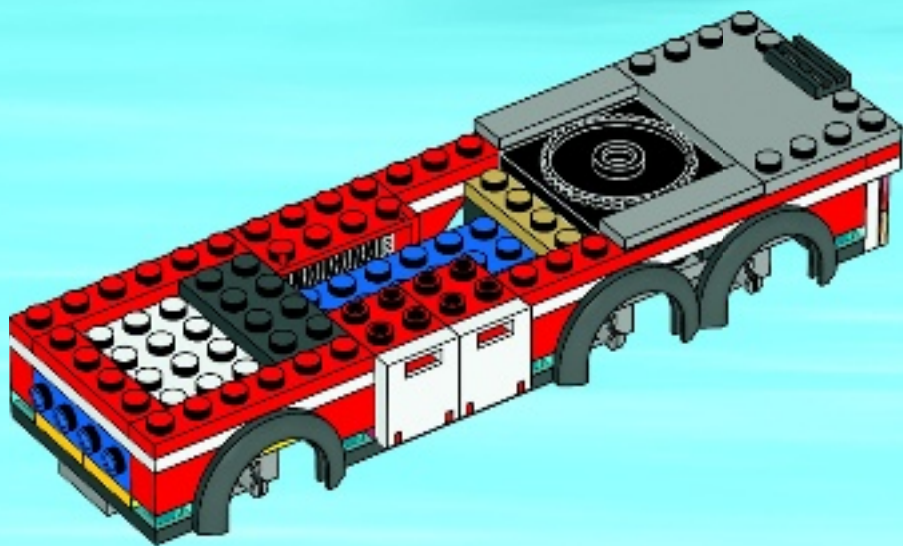



1x

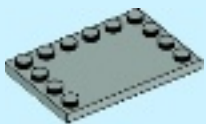

1x

30

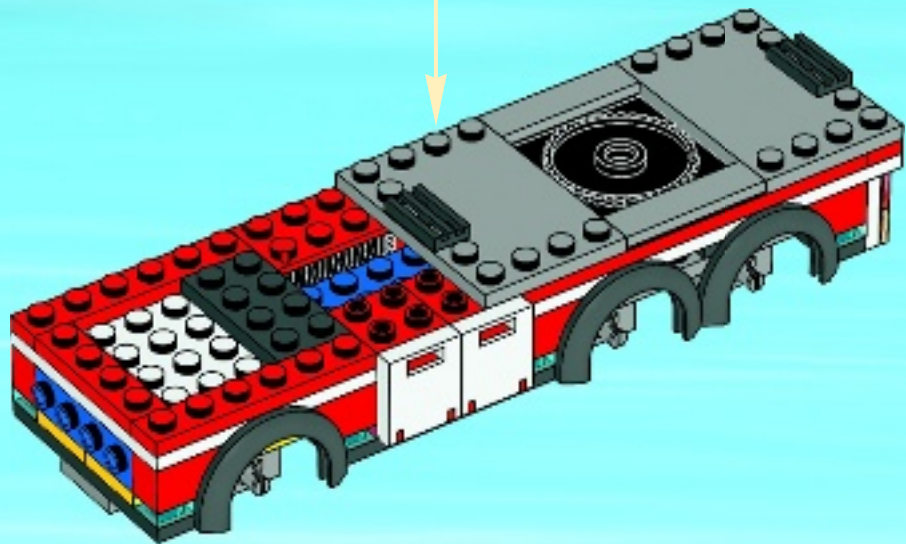
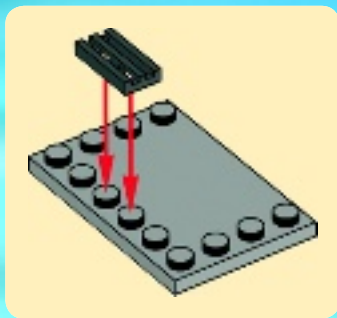





1x



2x

# 31

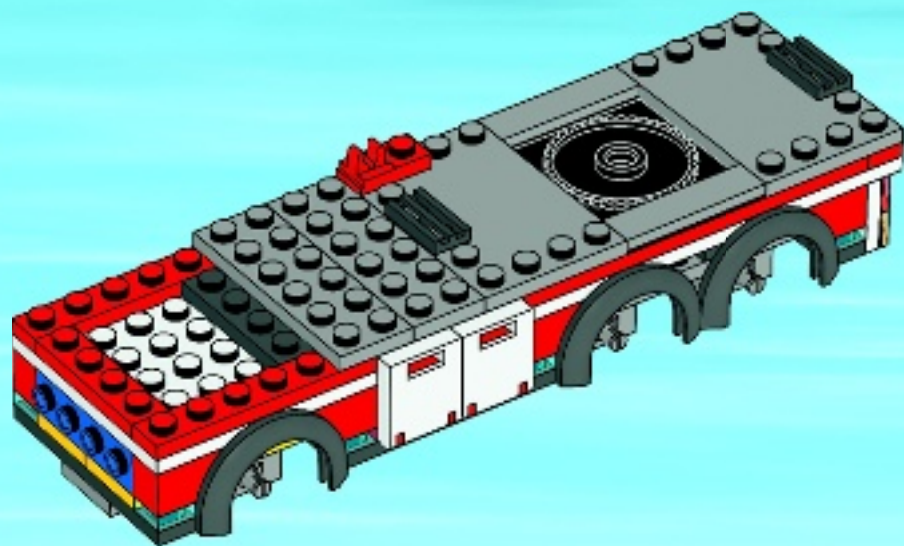



1x

# 32

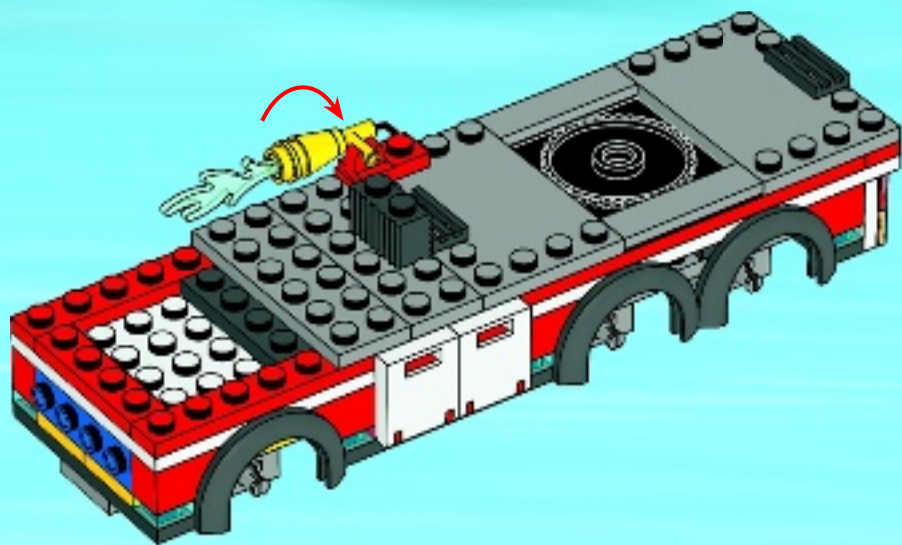



4x

# 33

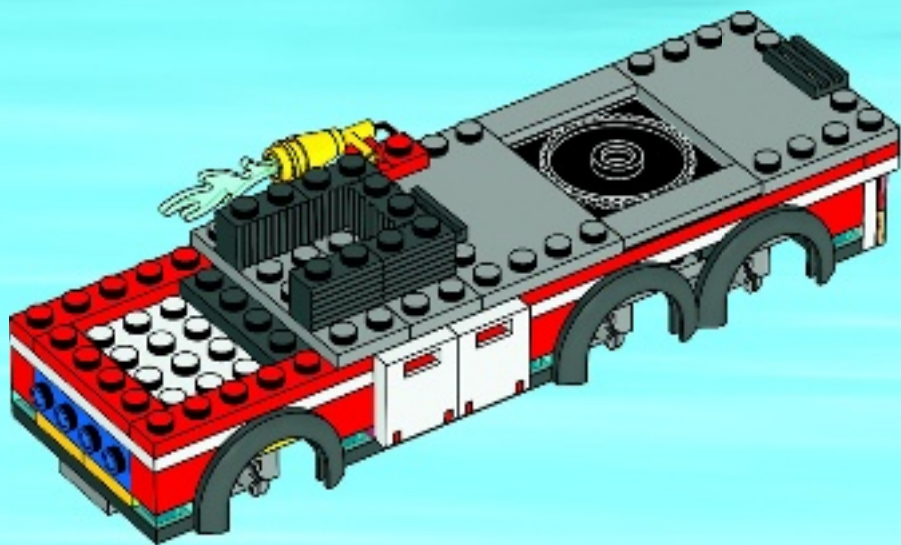



2x

# 34

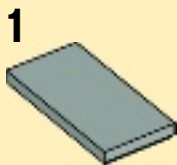

2x

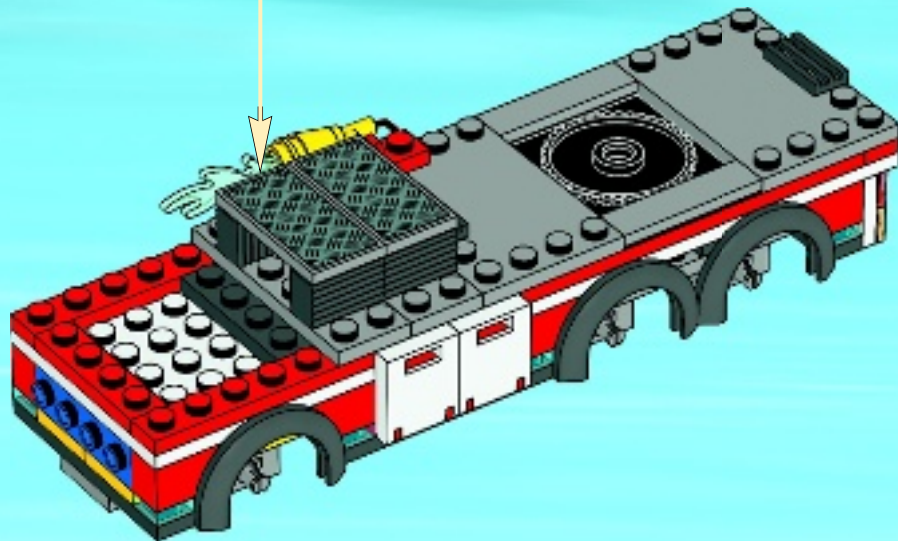



2x



1x

# 35

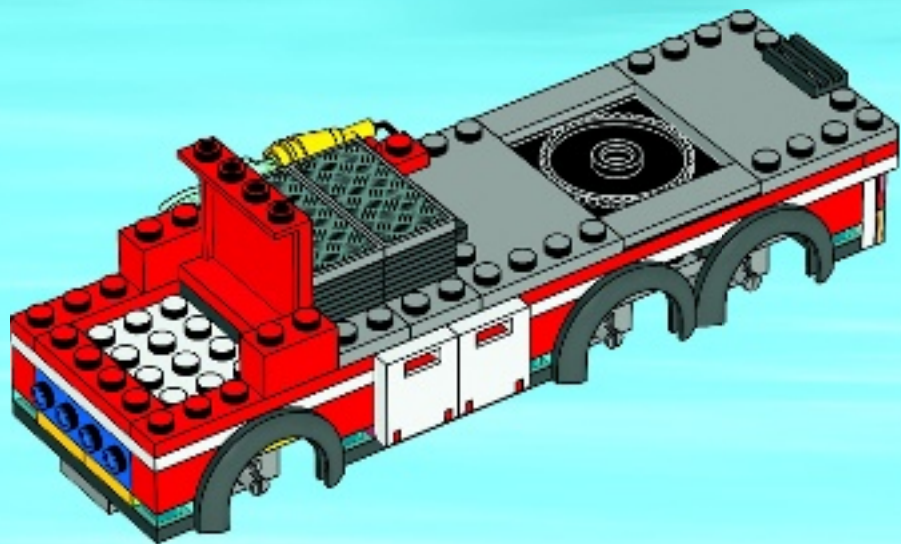



1x



1x

# 36

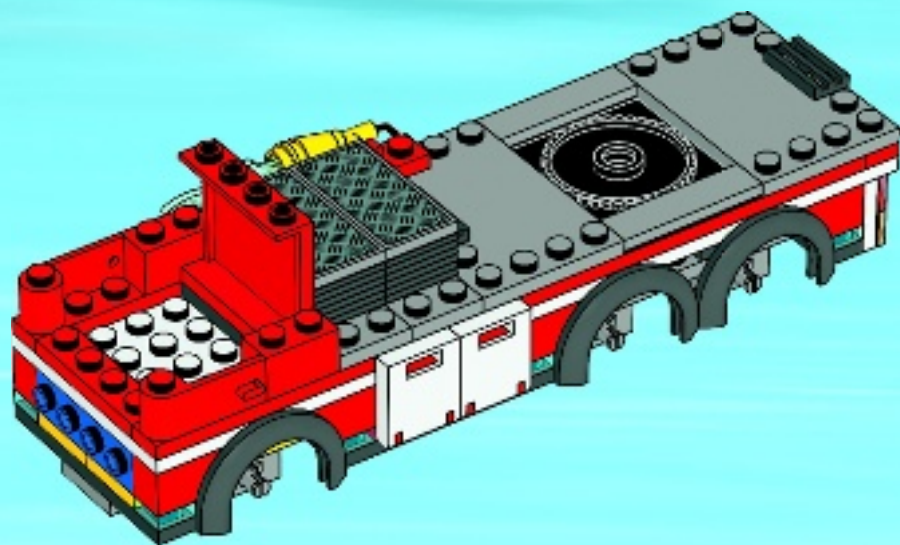





1x



1x

# 37

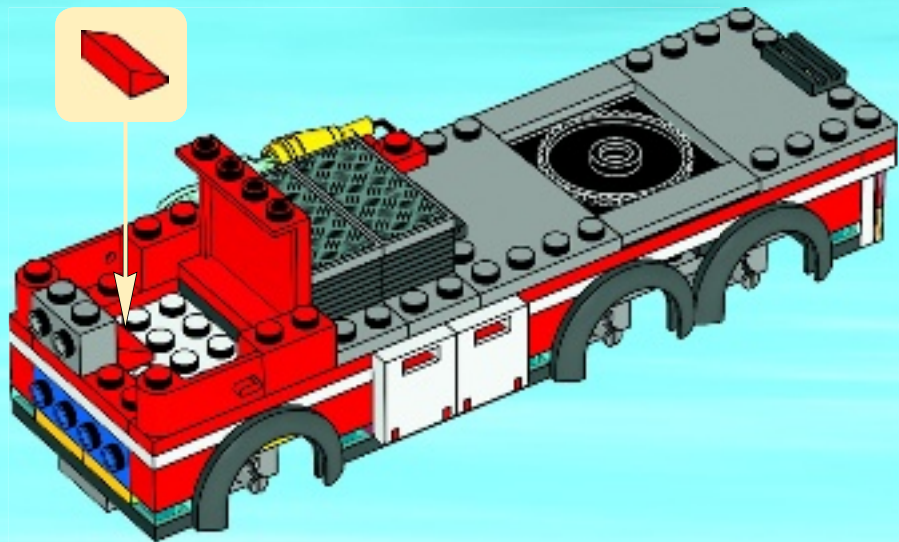



1x



1x



1x

# 38

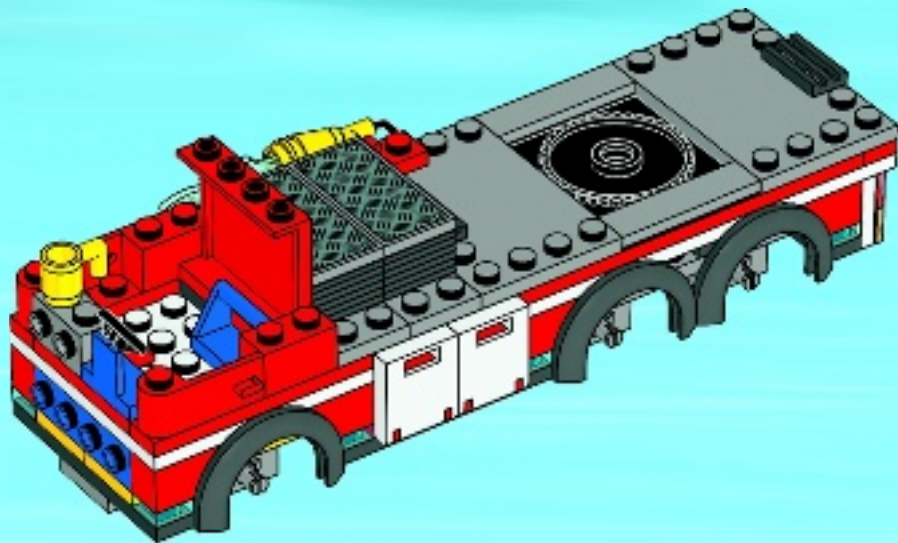





1x

1

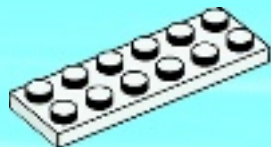

2x

2





2x



1x

3



2x



2x

4





1x

5



2x



1x

6



7



8



2x



39

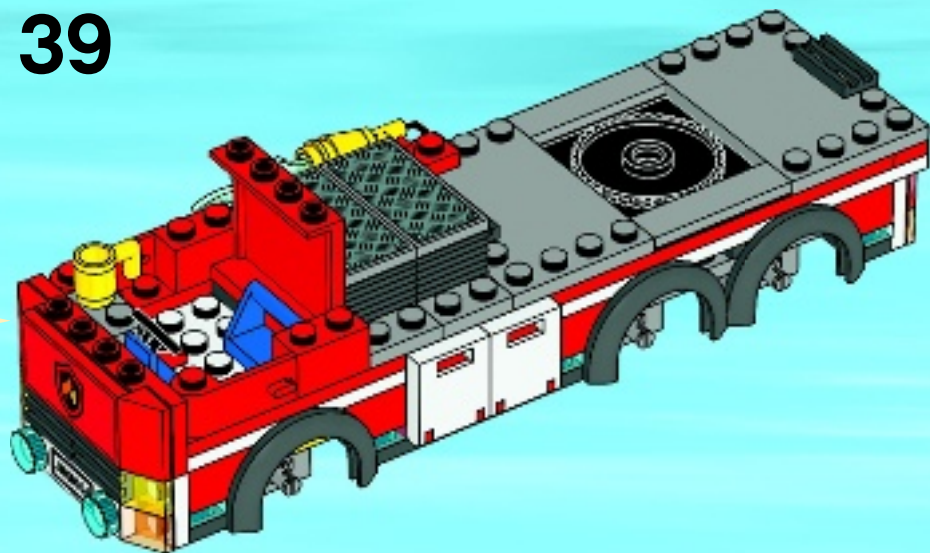



2x

40

1



2



2x

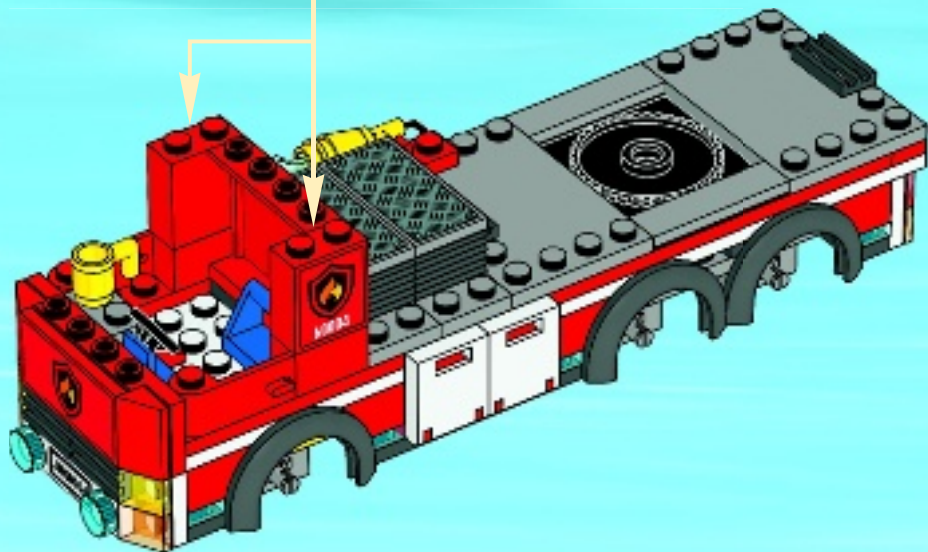



1x

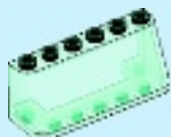

1x

# 41

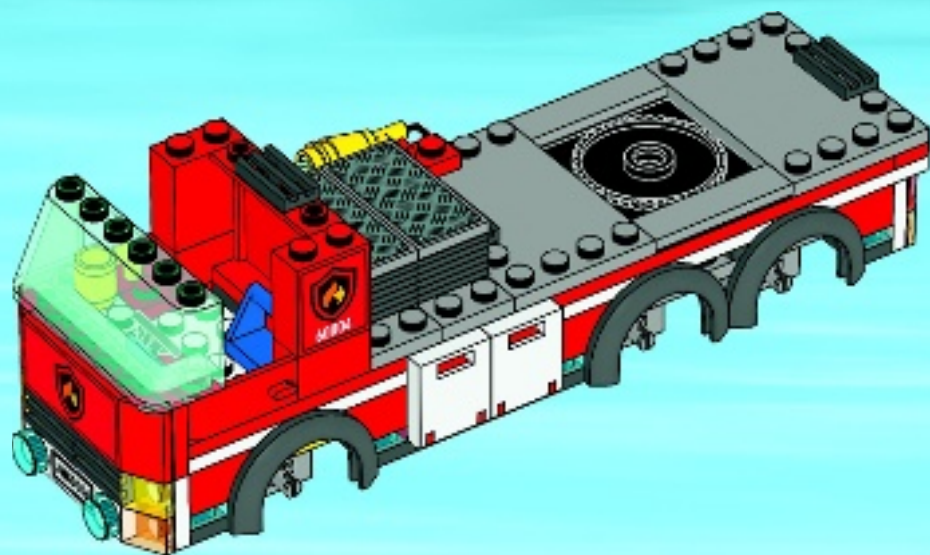



2x



3x

# 42

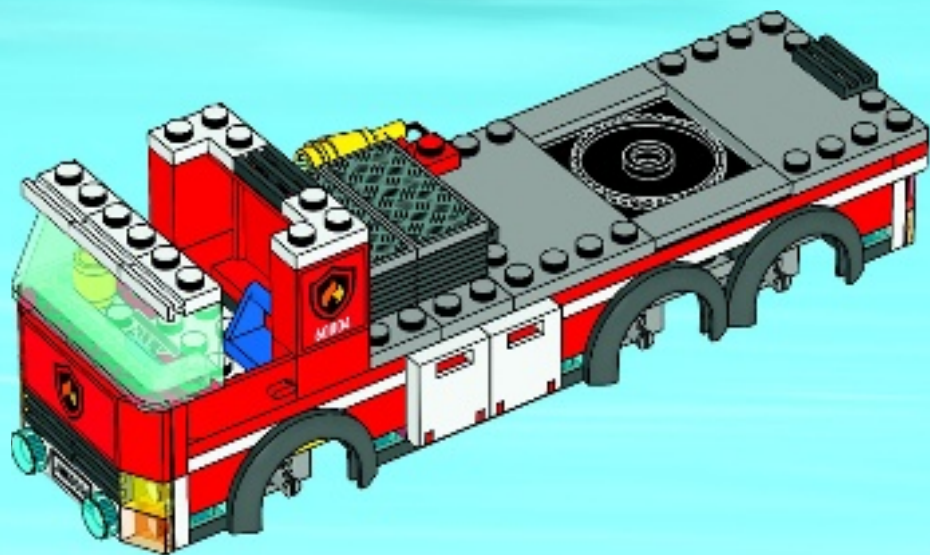





2x



1x



2x

# 43

1

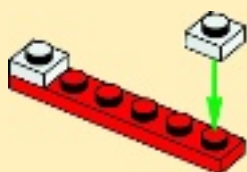

2

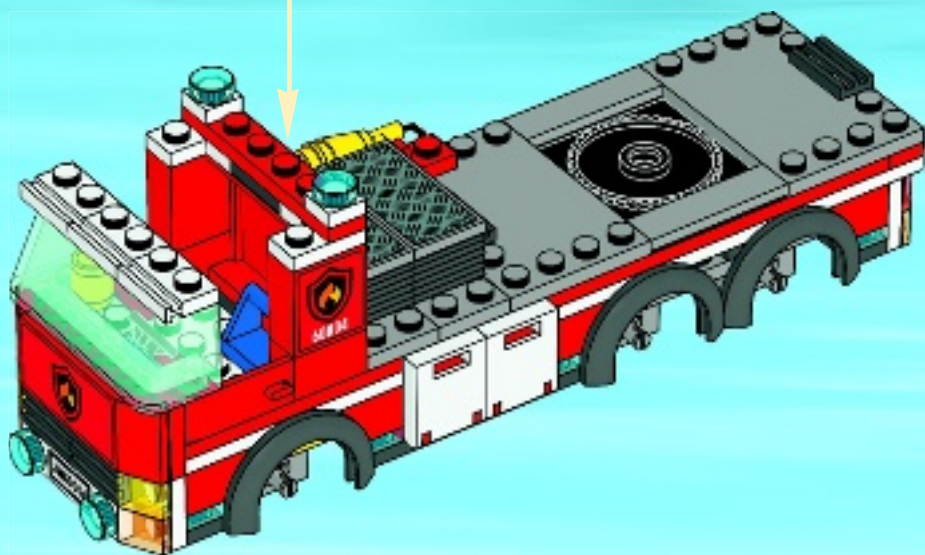
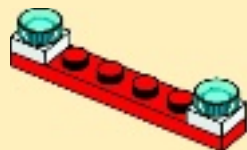



1x

44

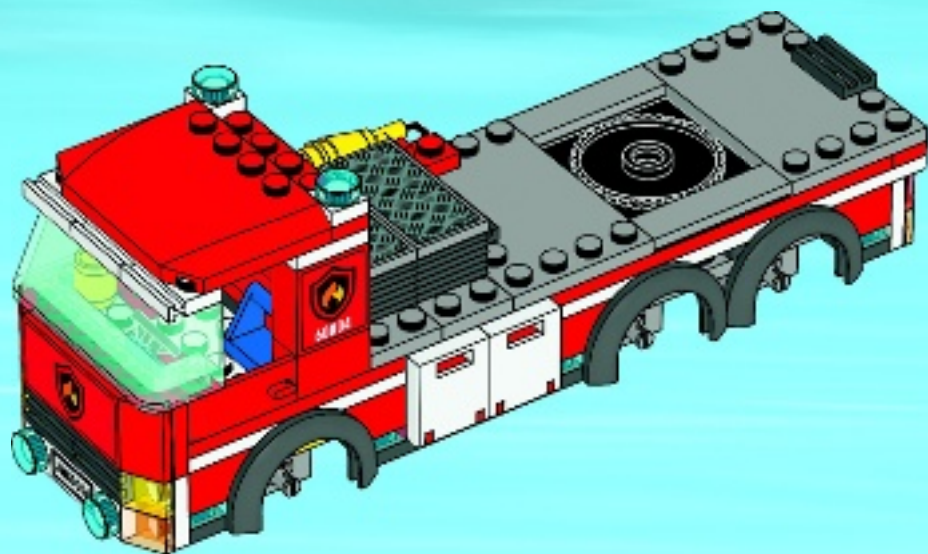



1x

1



2x

2





1x

3



2x

4





1x

5



1x

6

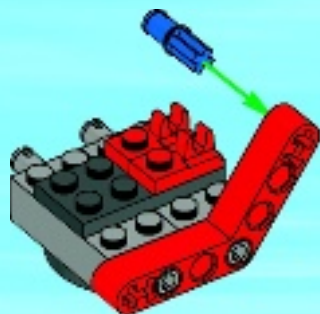

45

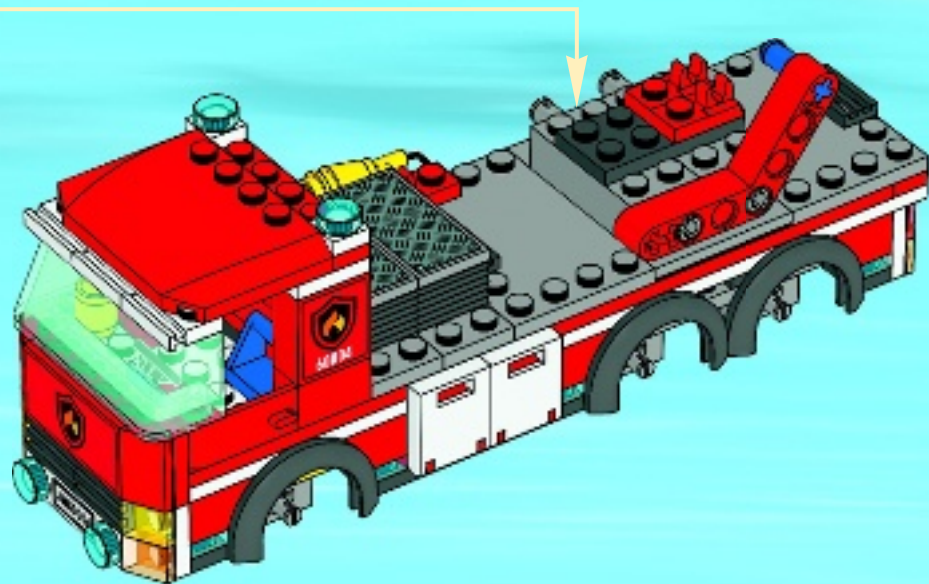

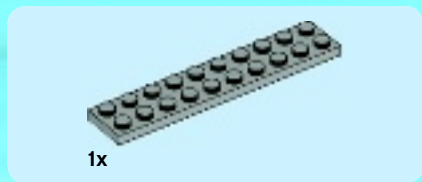

1

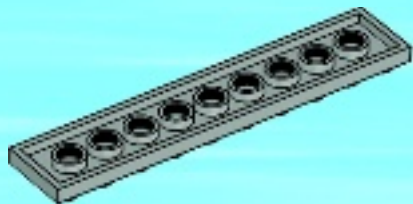

2

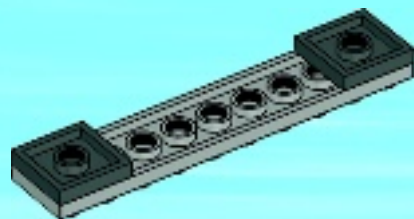



1x

3

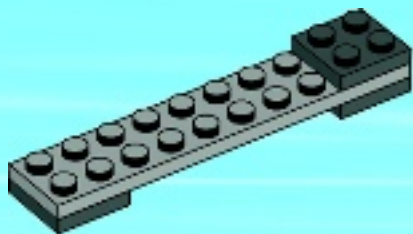

2x



1x

4

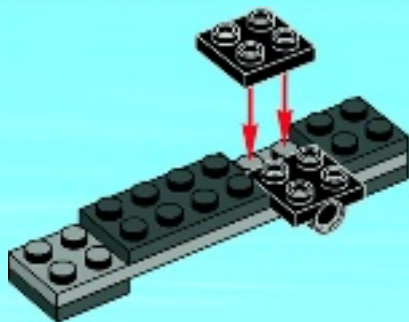





2x

5



1x

6



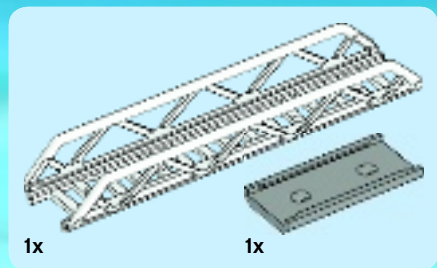

7

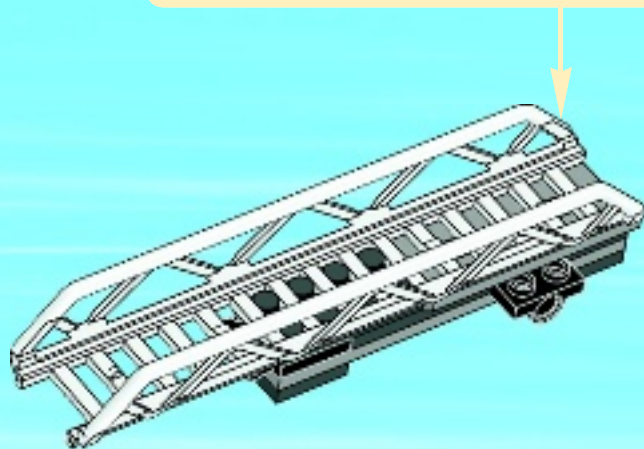
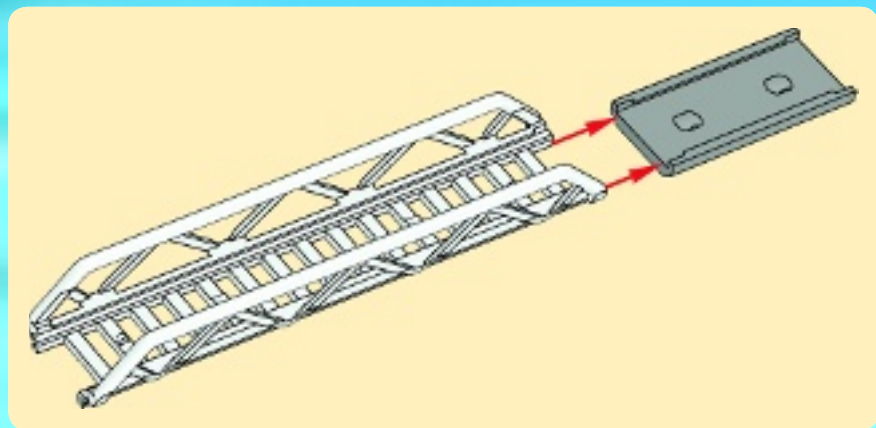

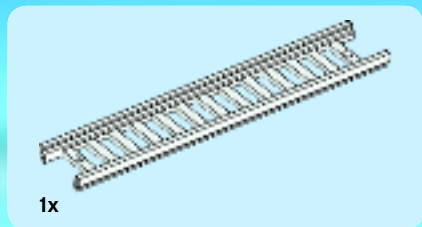

8

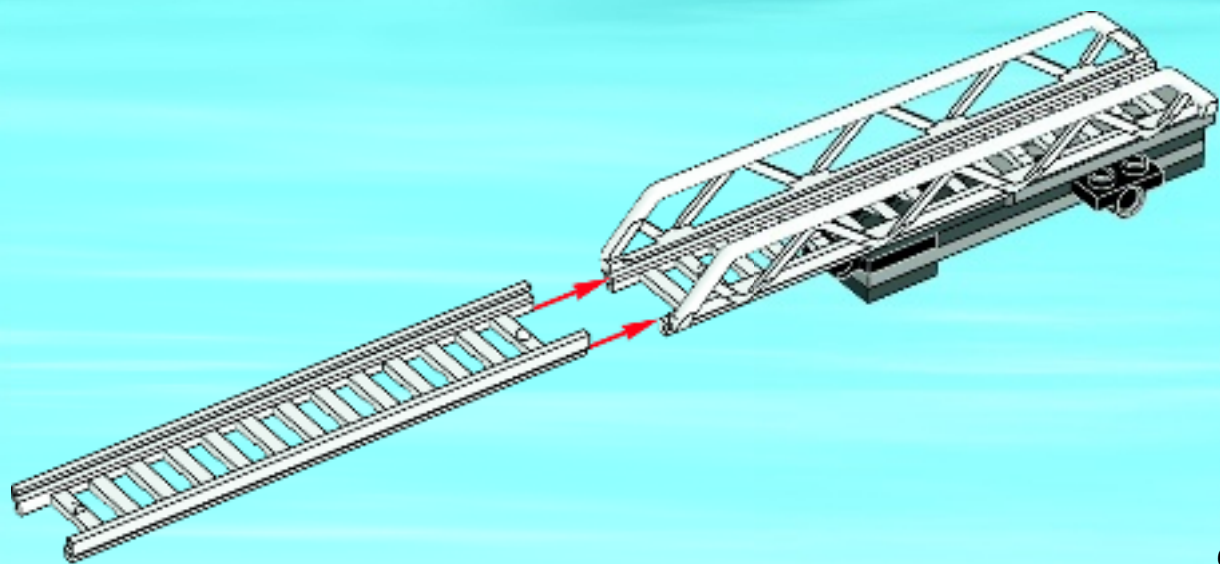

46

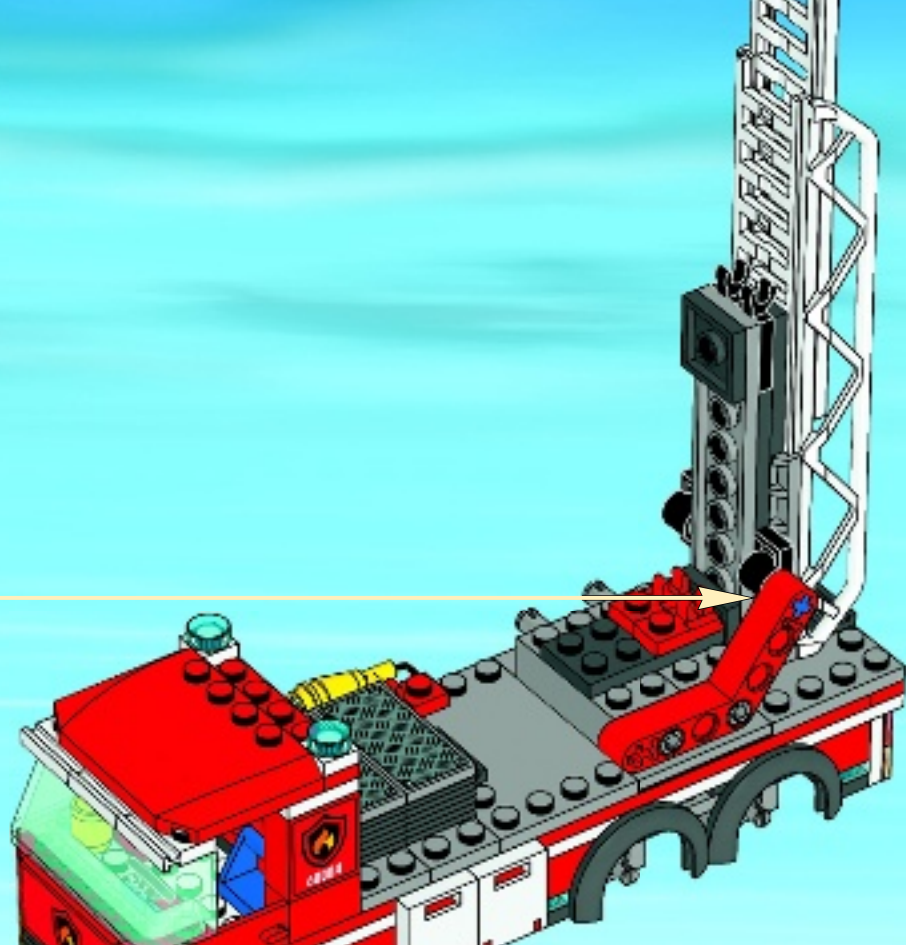

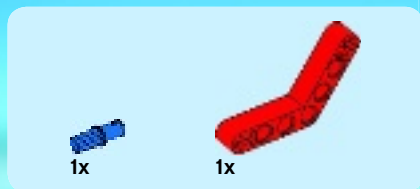

47

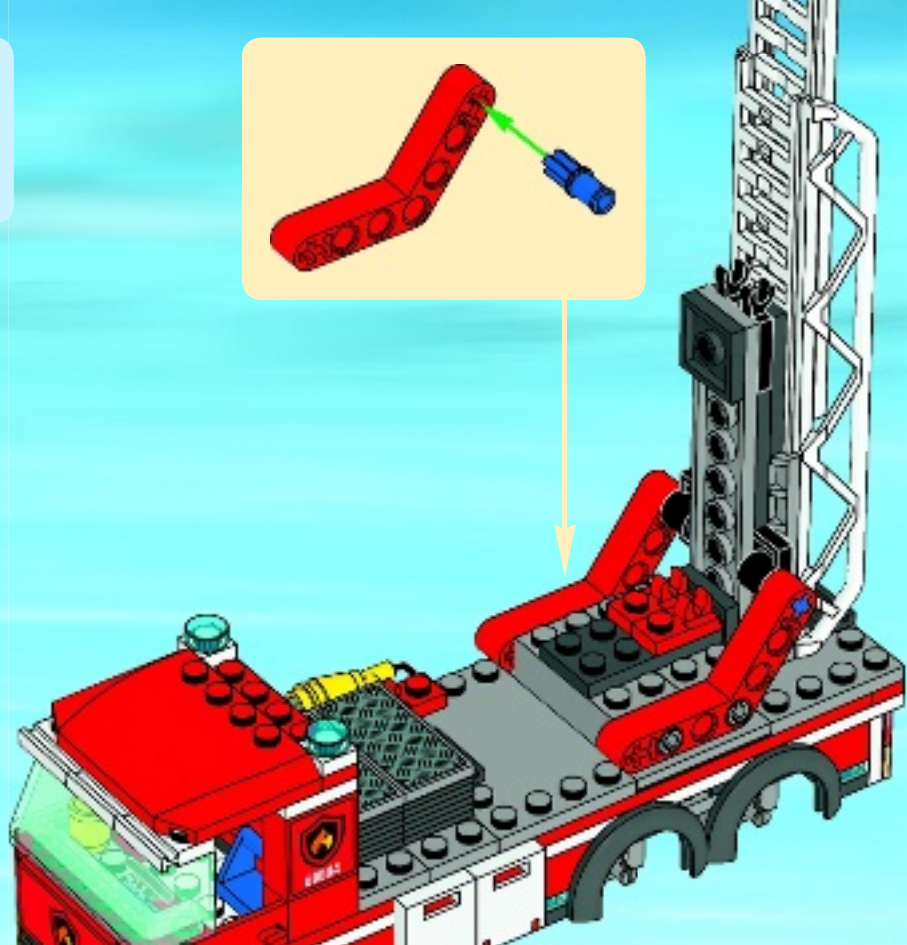
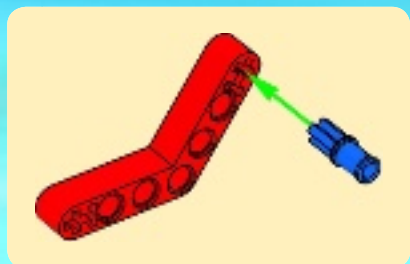



2x

48



2x

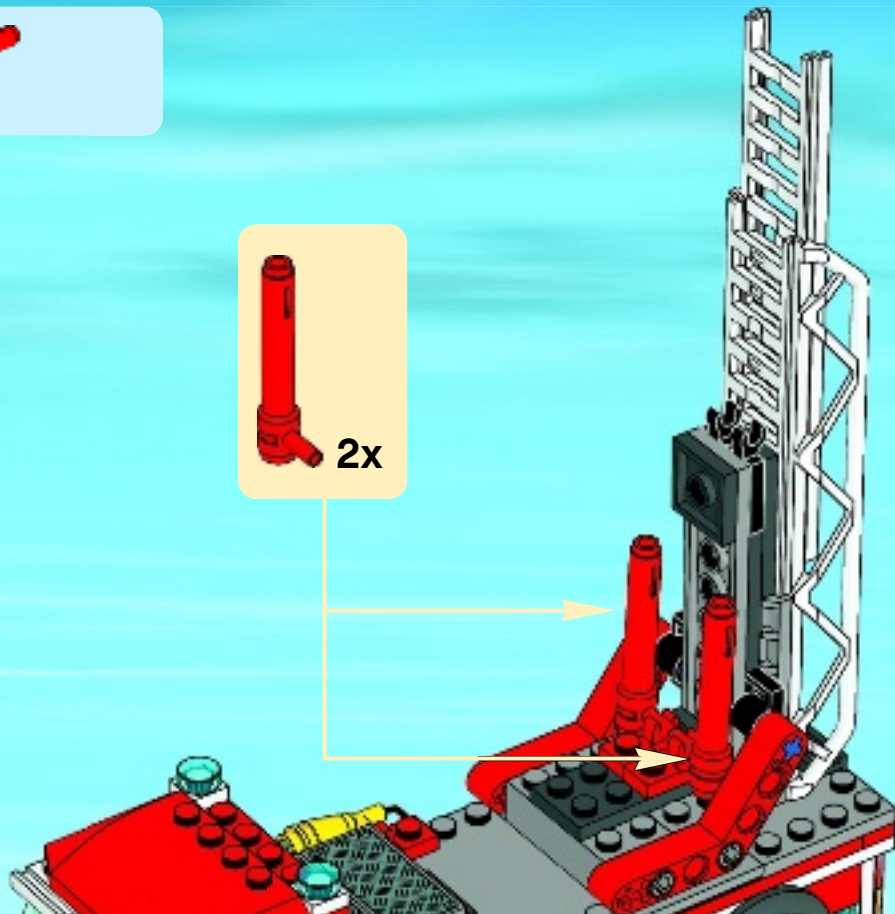



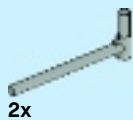

2x

49



2x

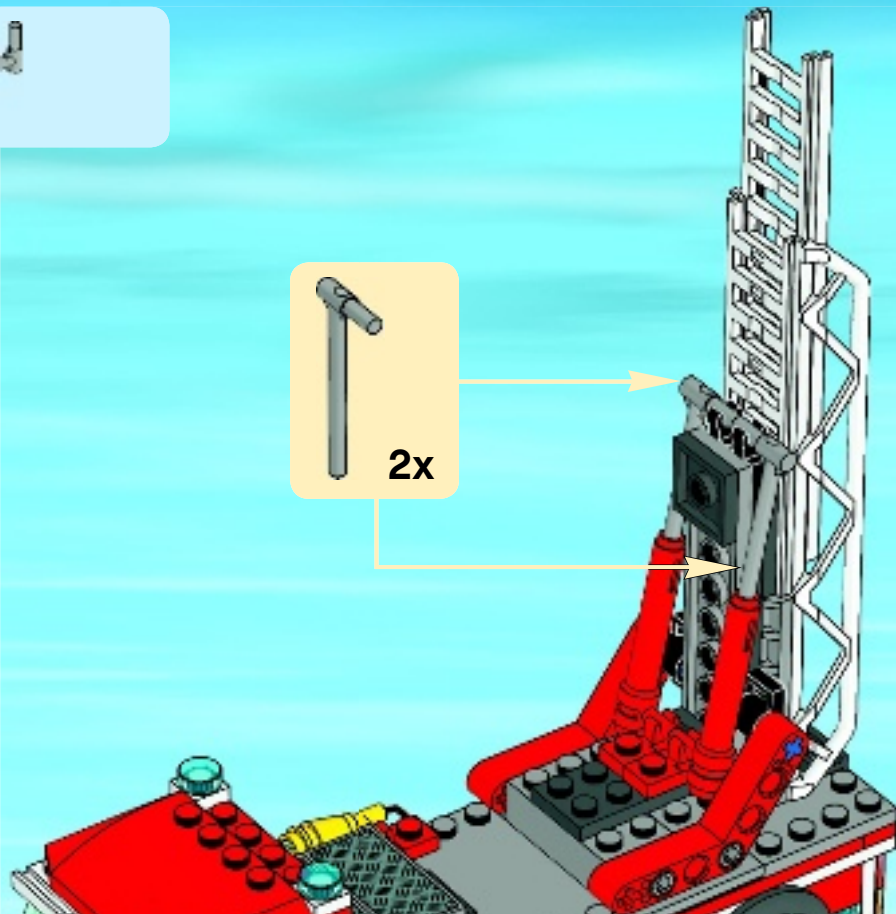



6x



6x

# 50

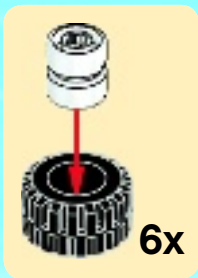

6x