

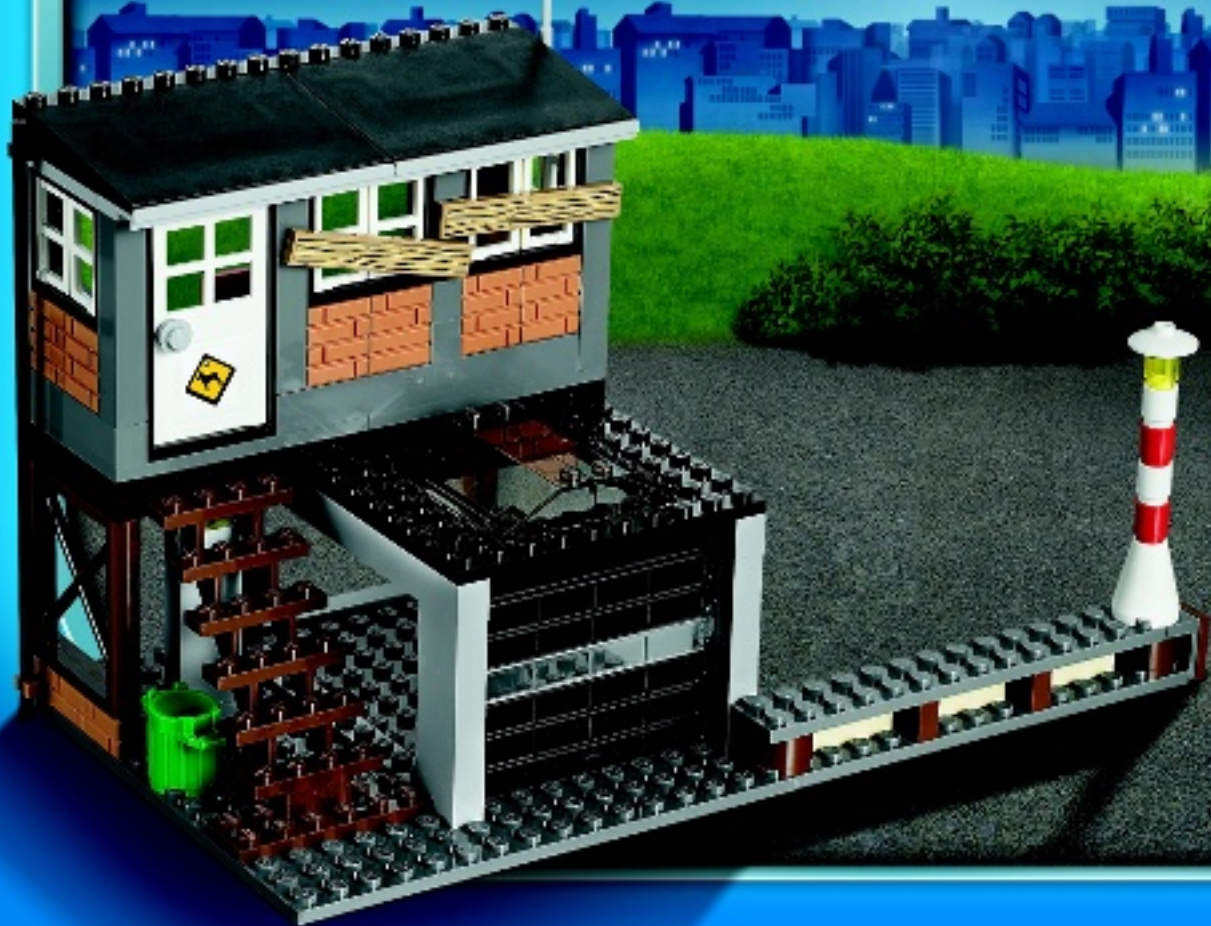

# CITY

60009

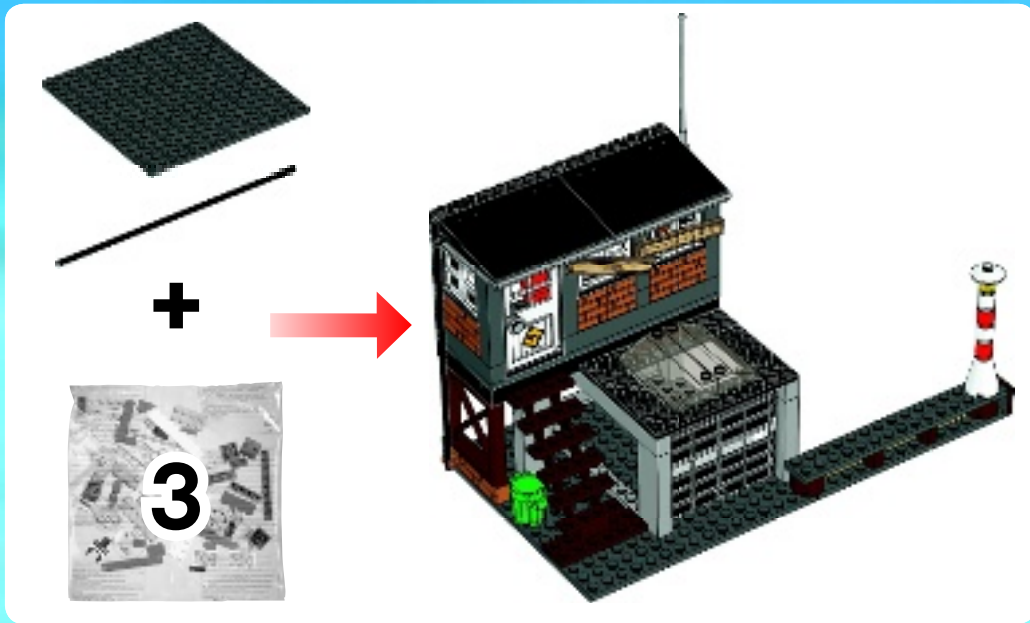



1

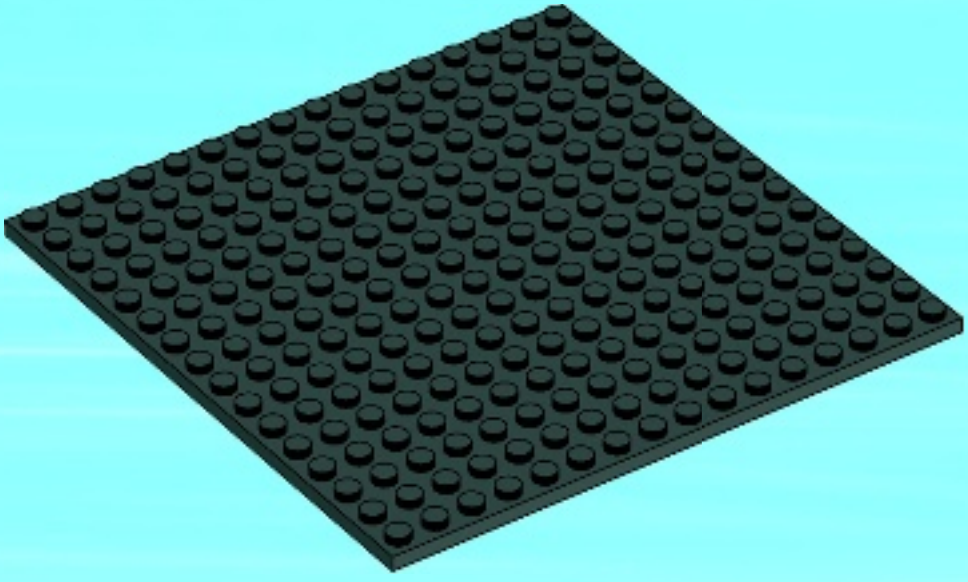

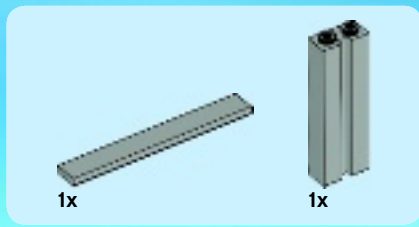

2

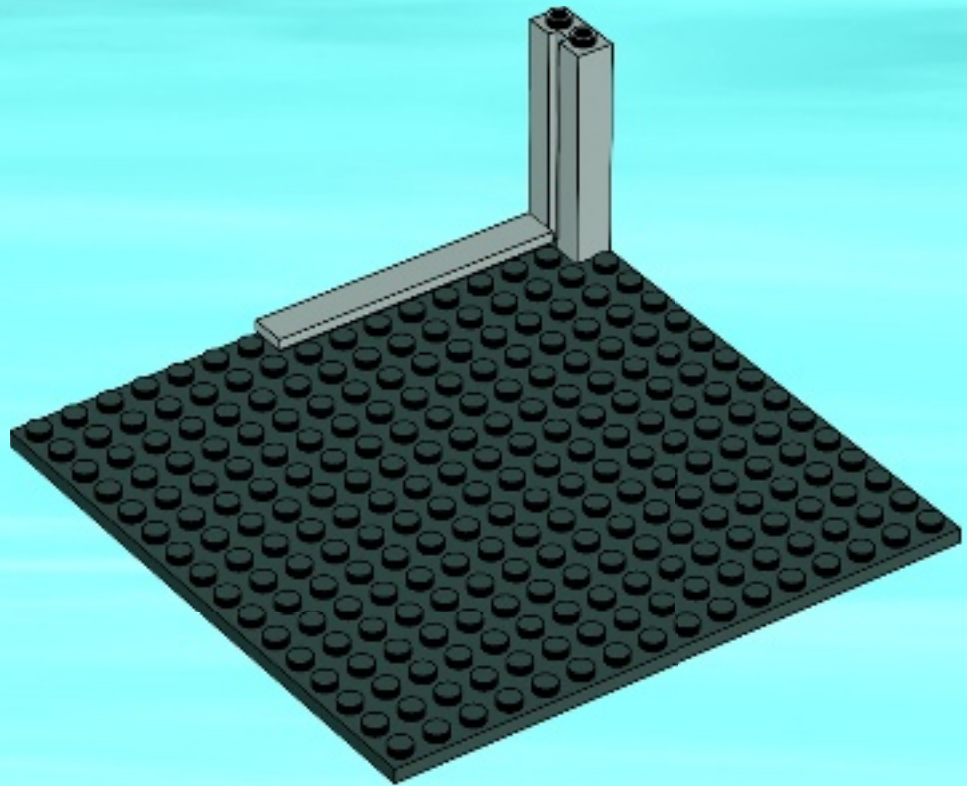

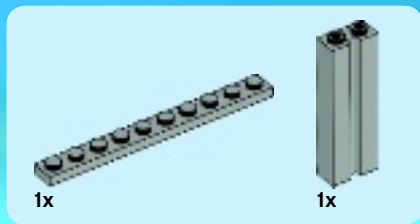

3

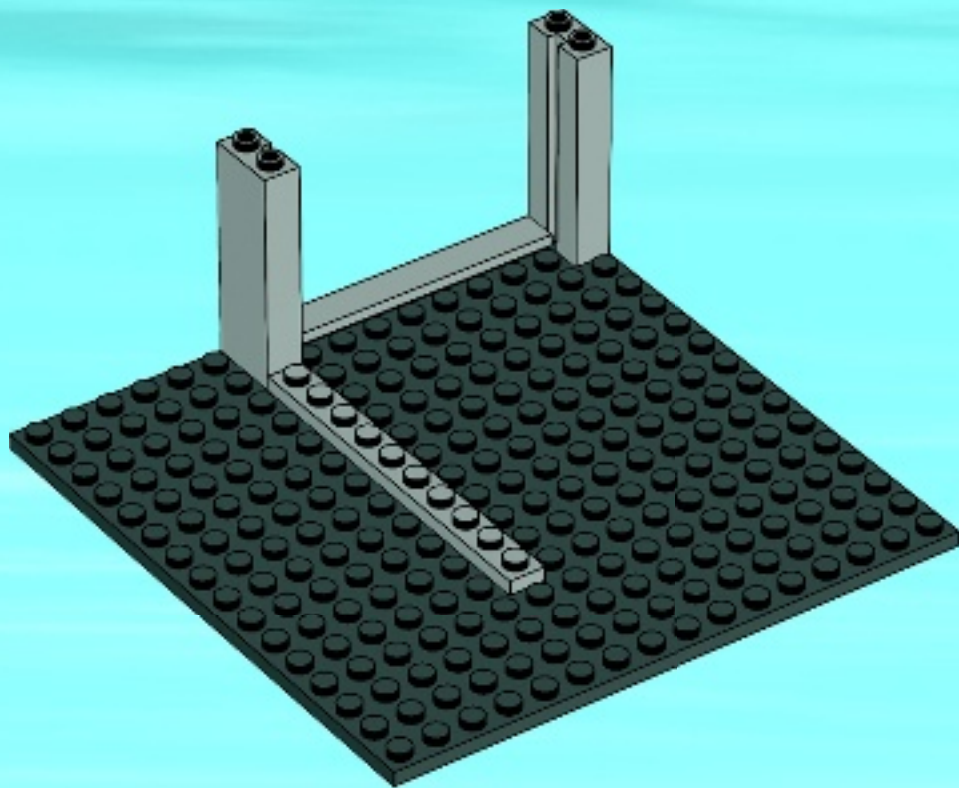



1x



1x

4

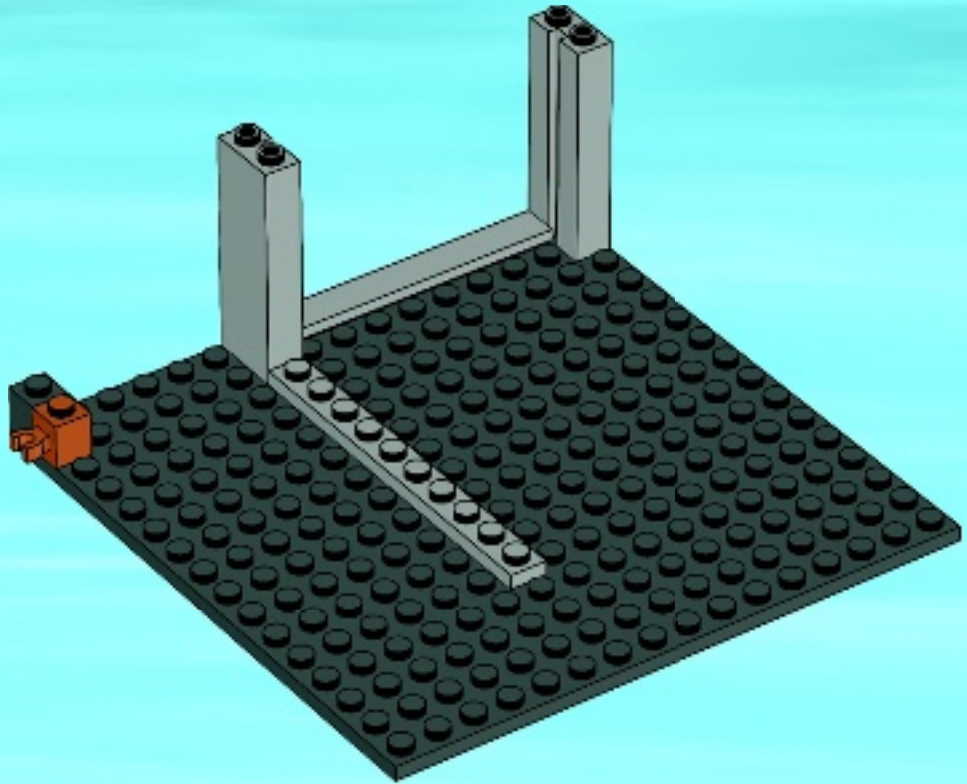



1x



2x

5

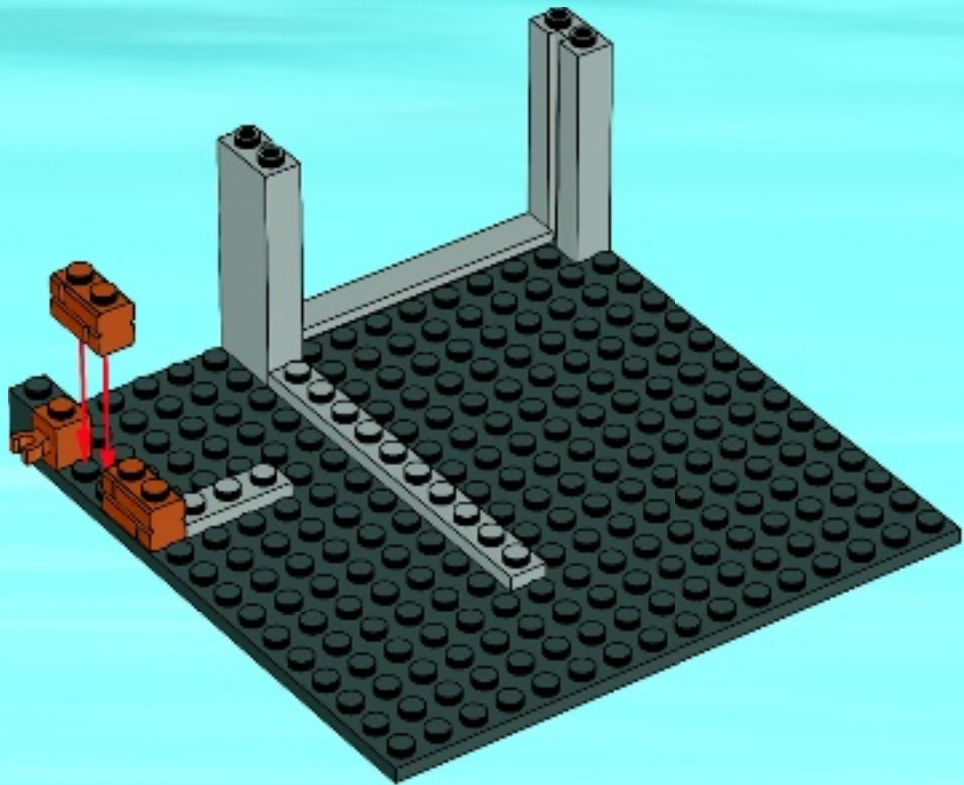

6

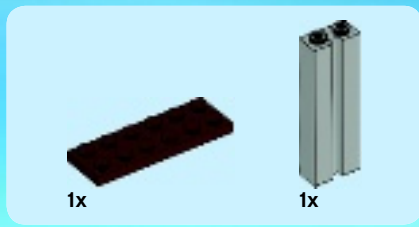

6

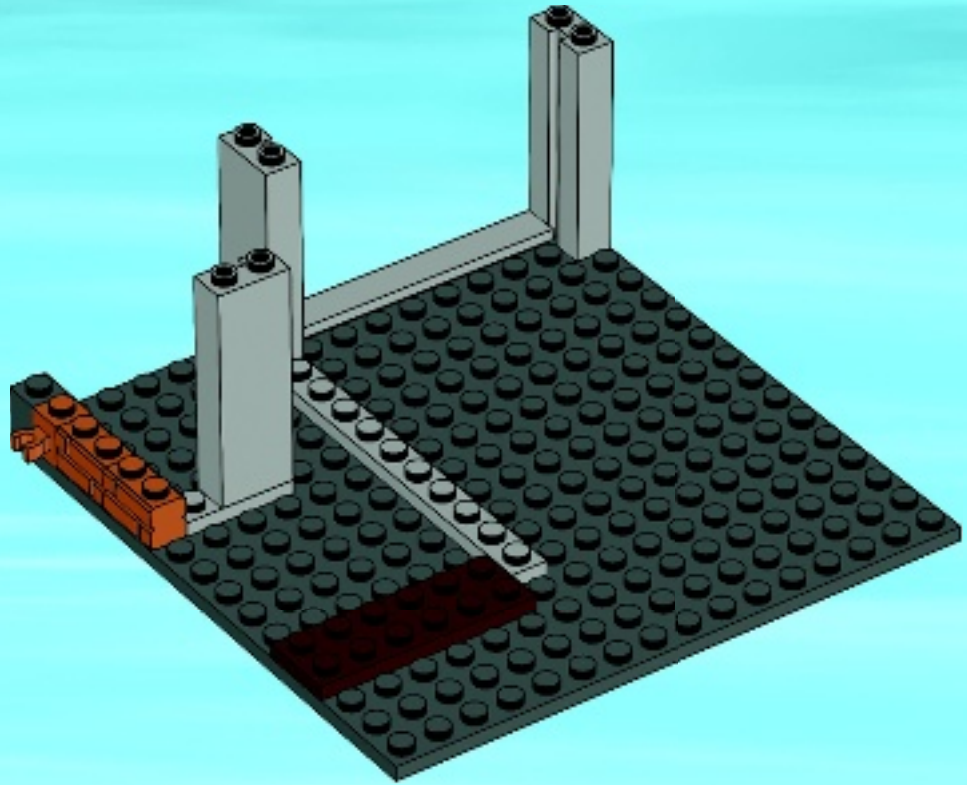



2x

7

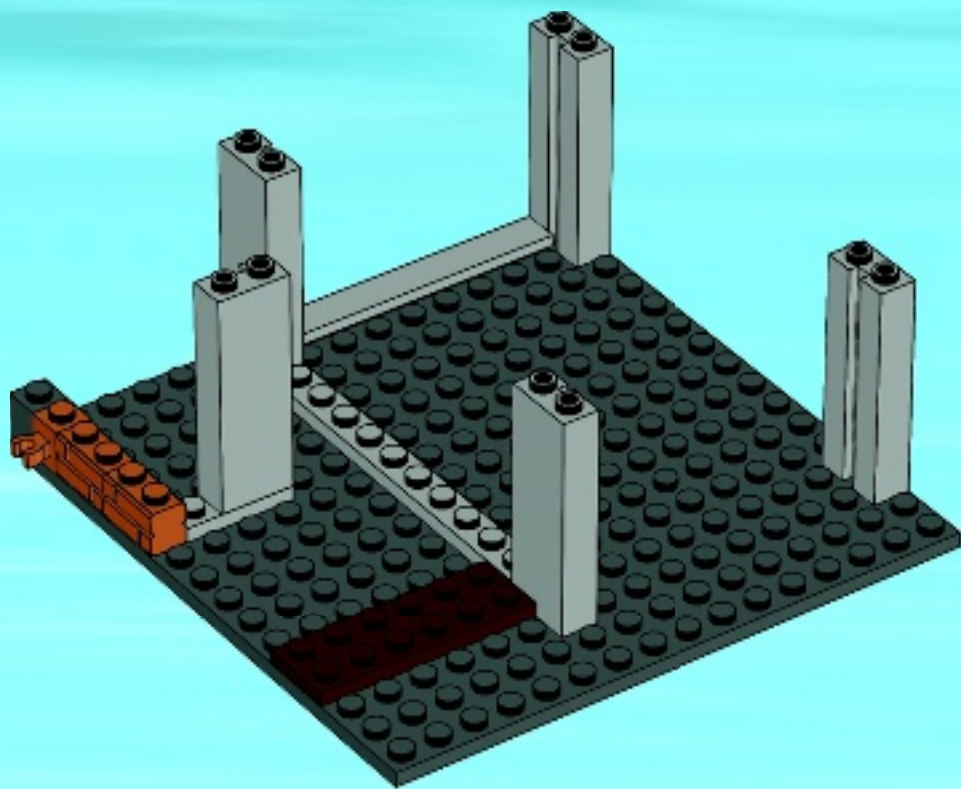

8



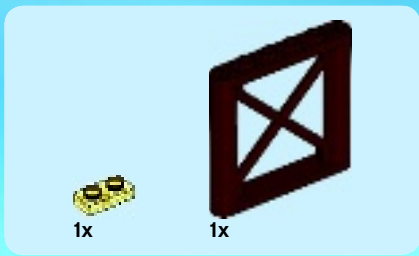

8

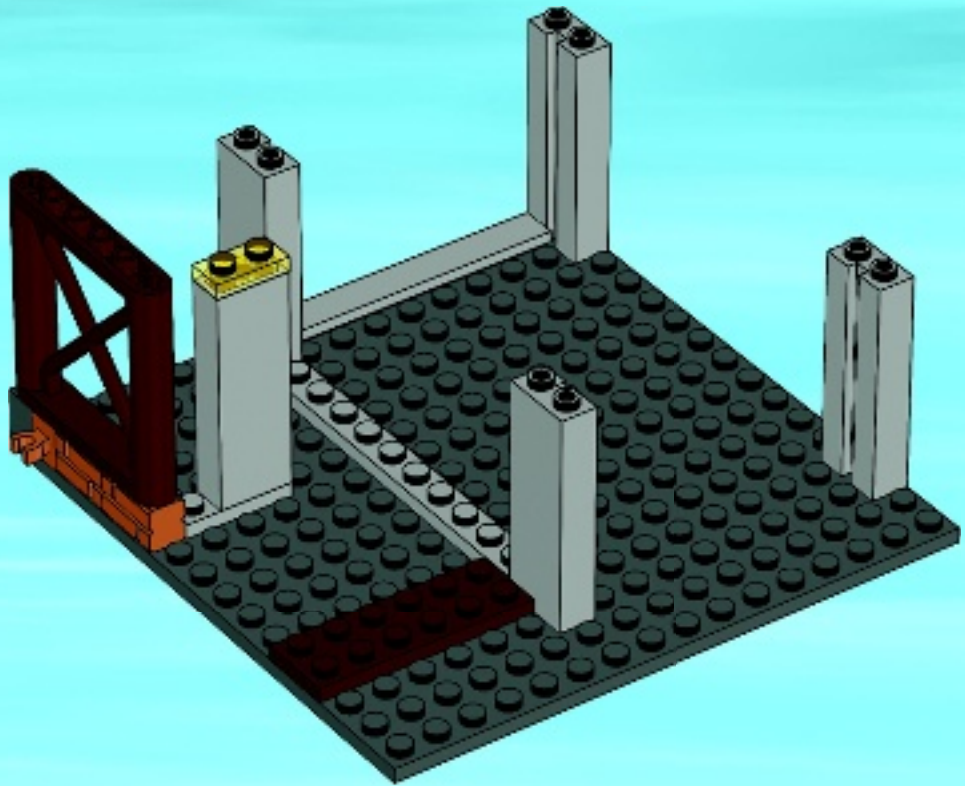

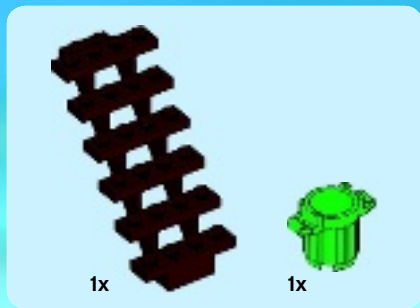

9

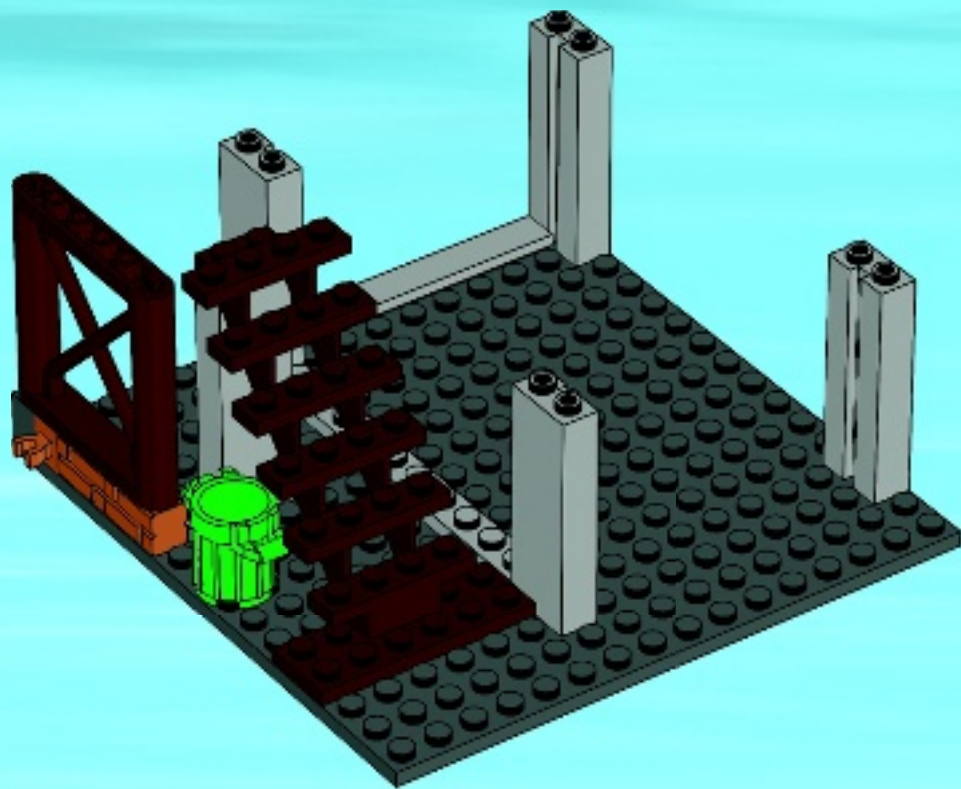

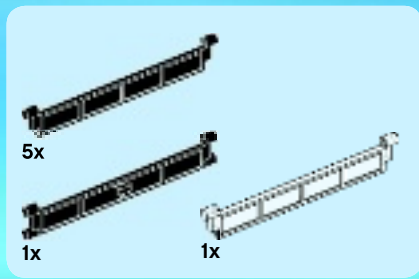

10

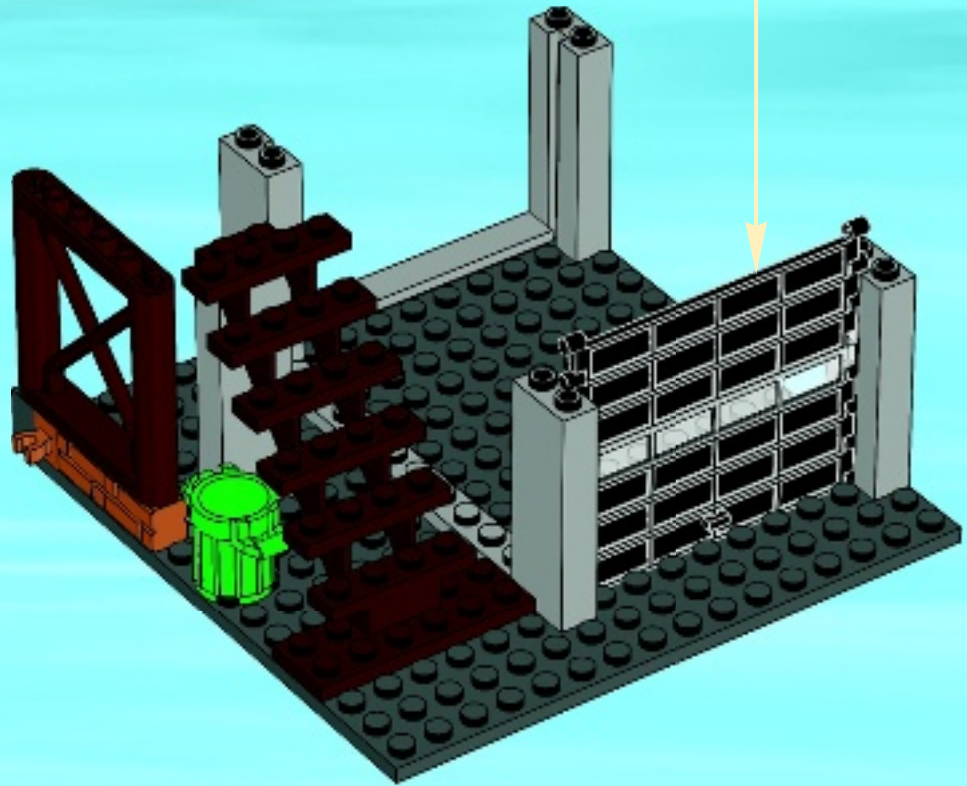
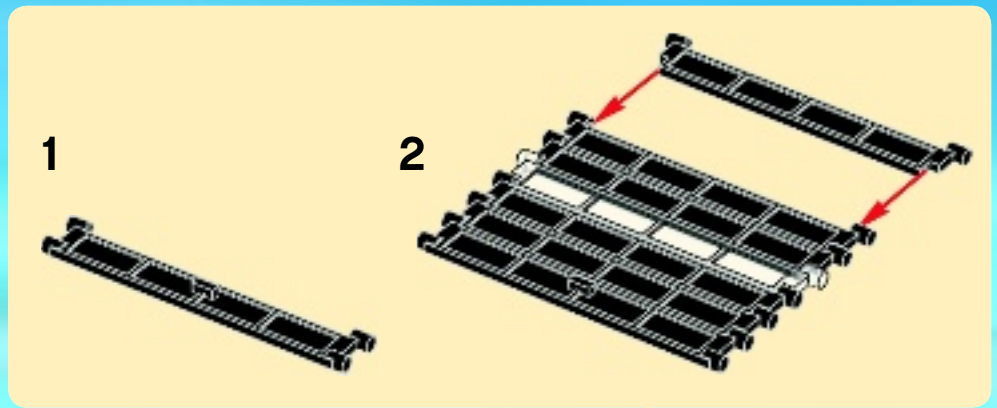

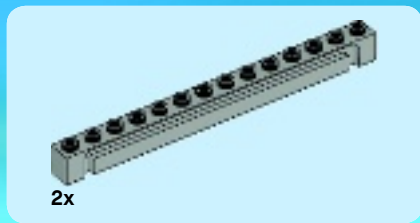

11

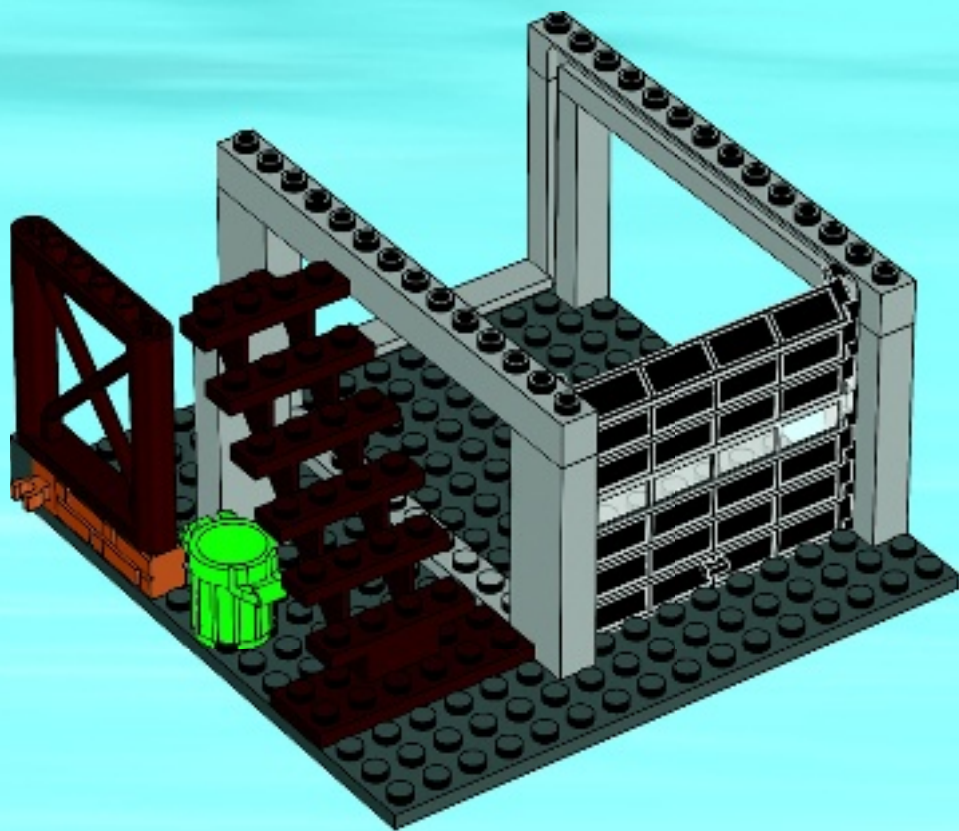



12

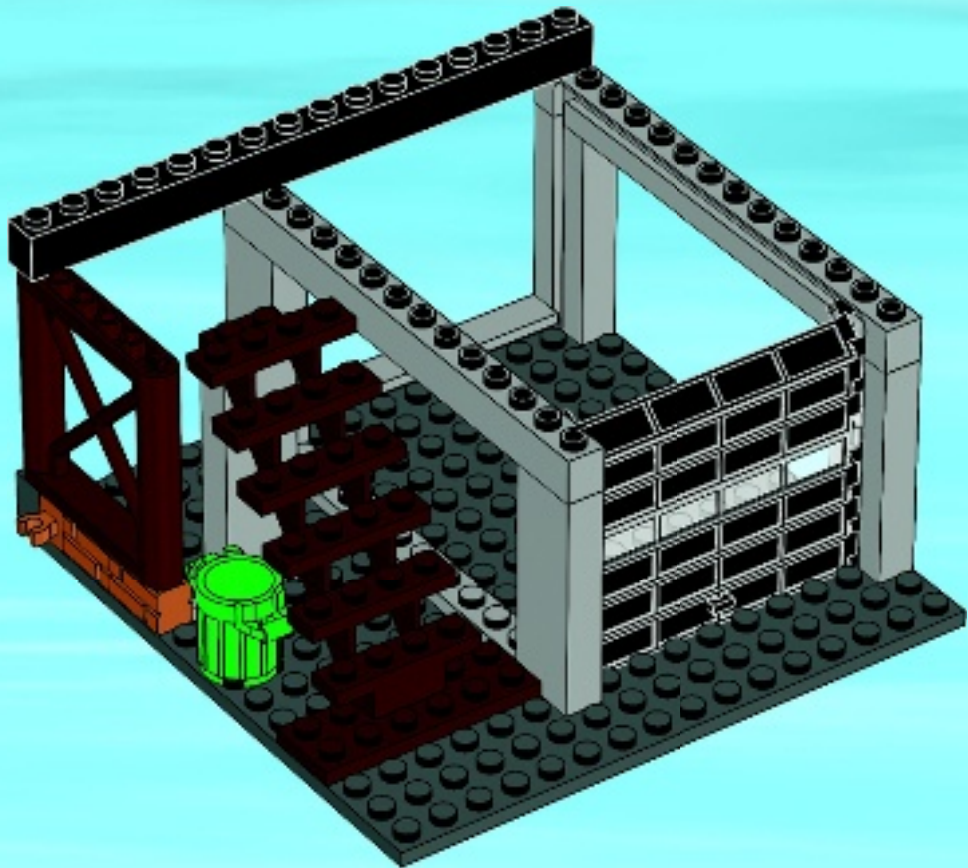



1x



2x

# 13

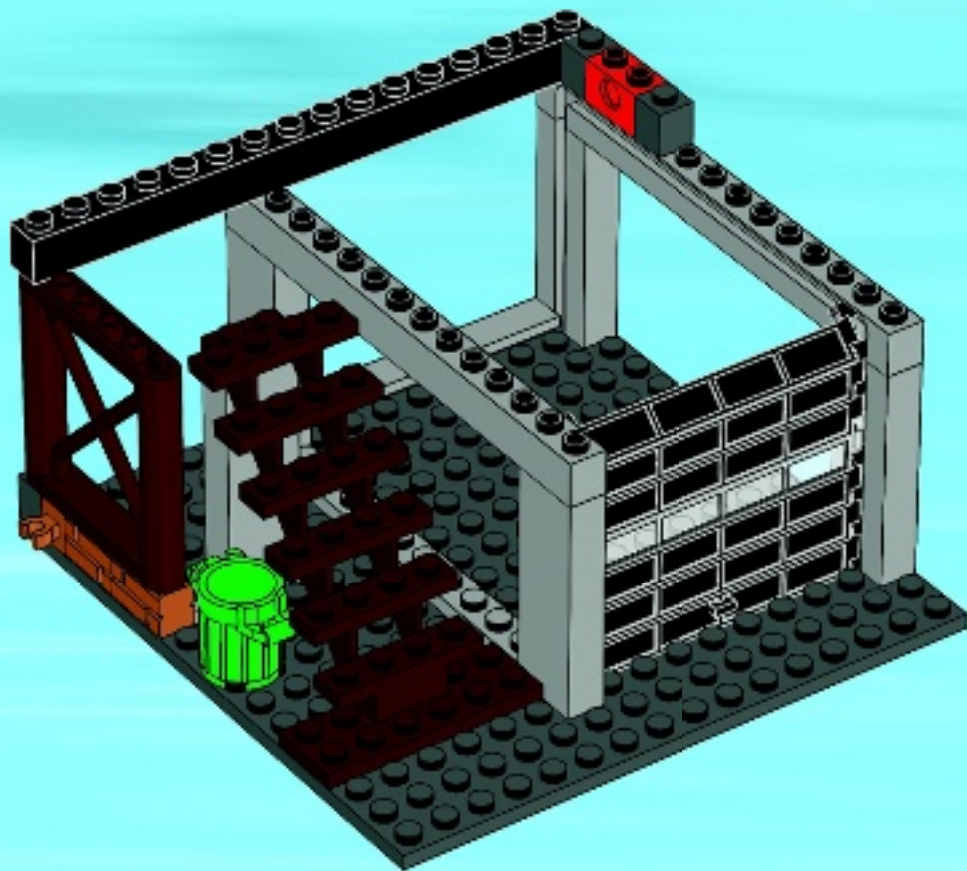



1x

# 14

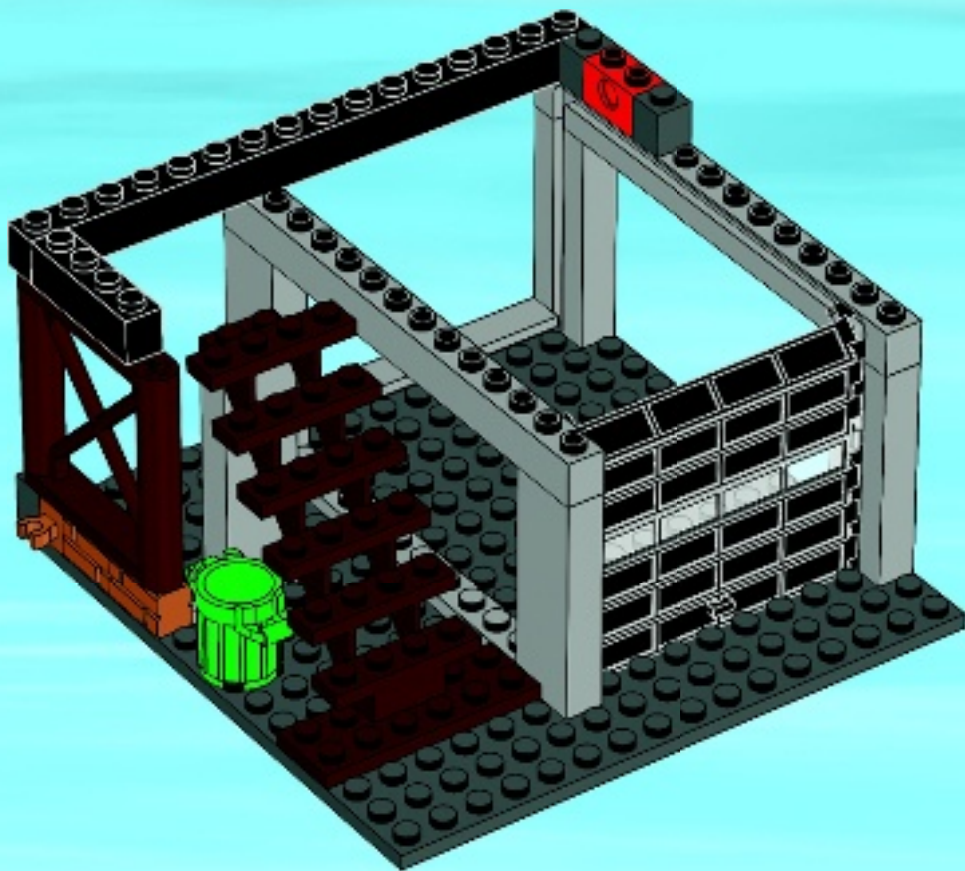



1x



1x

# 15

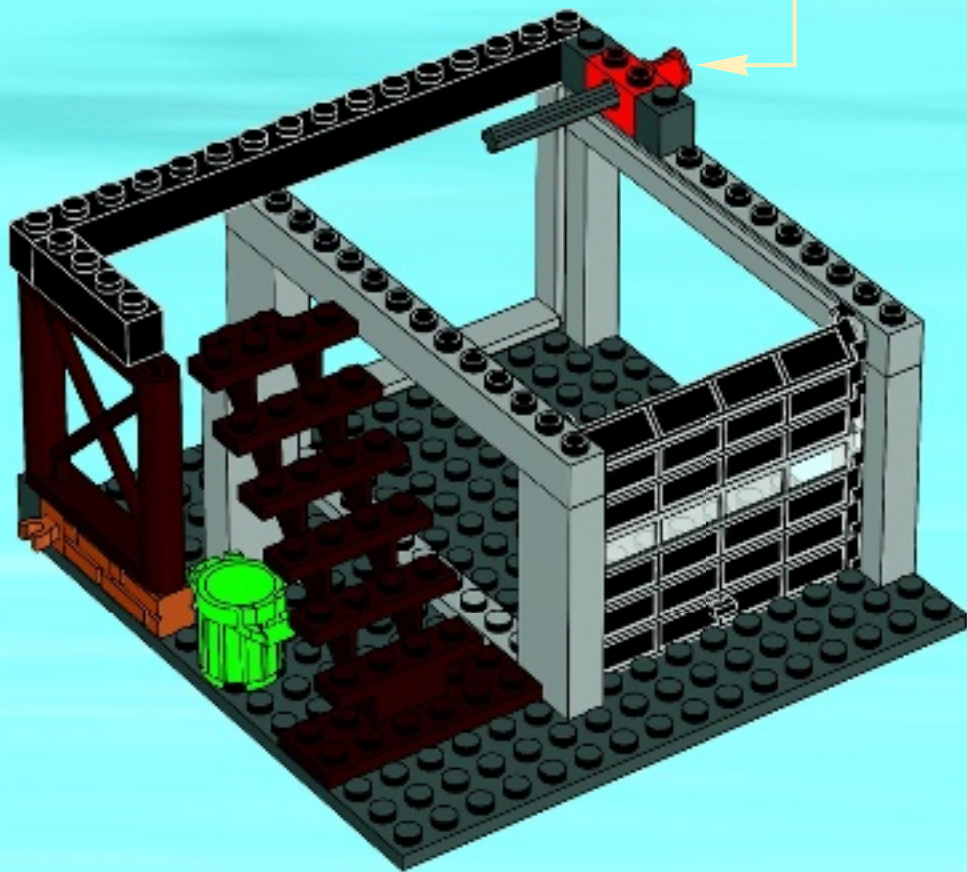
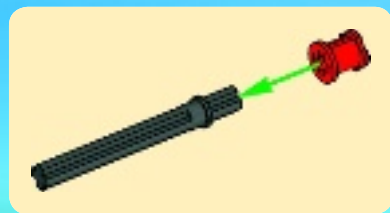





16

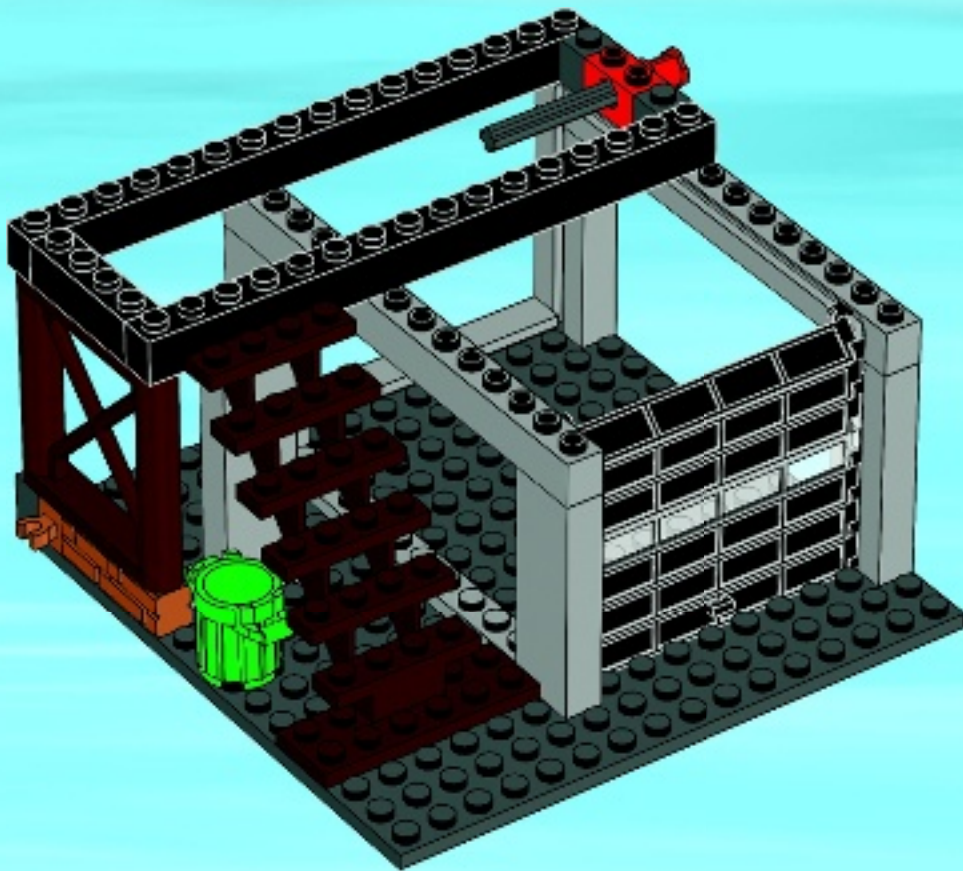

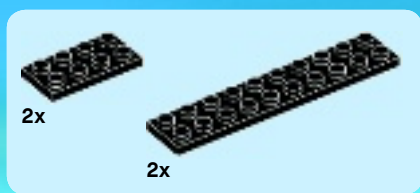

17

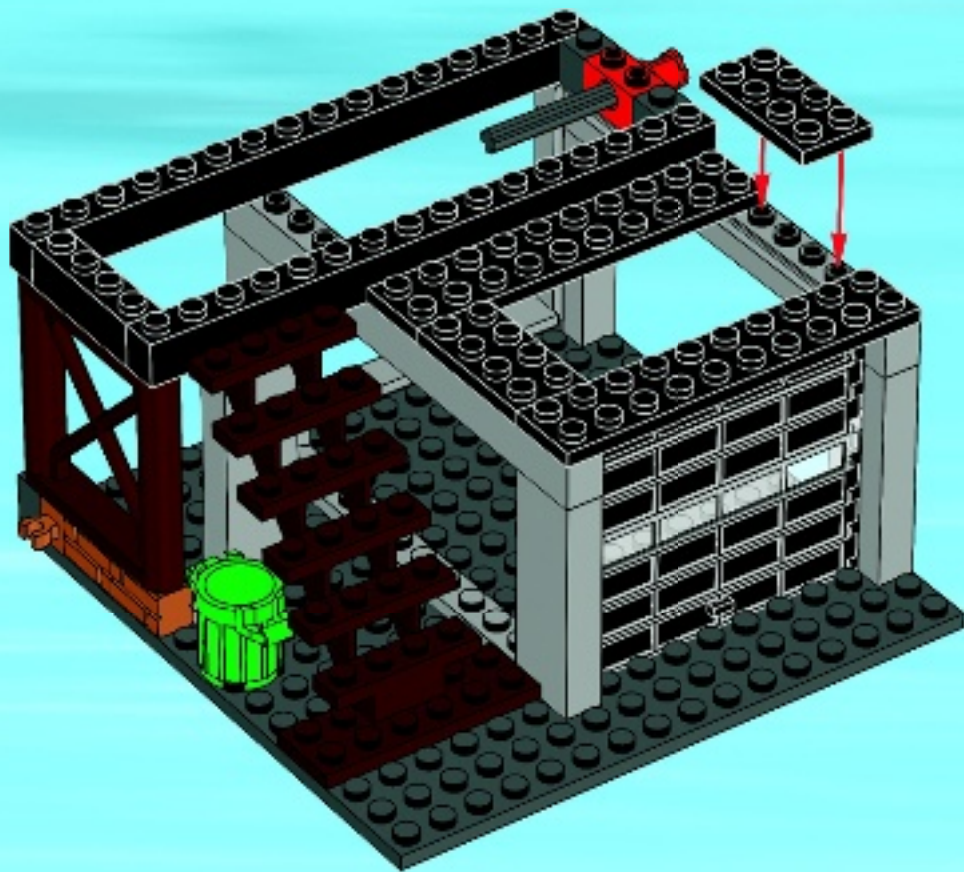

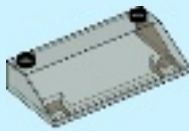

2x

# 18

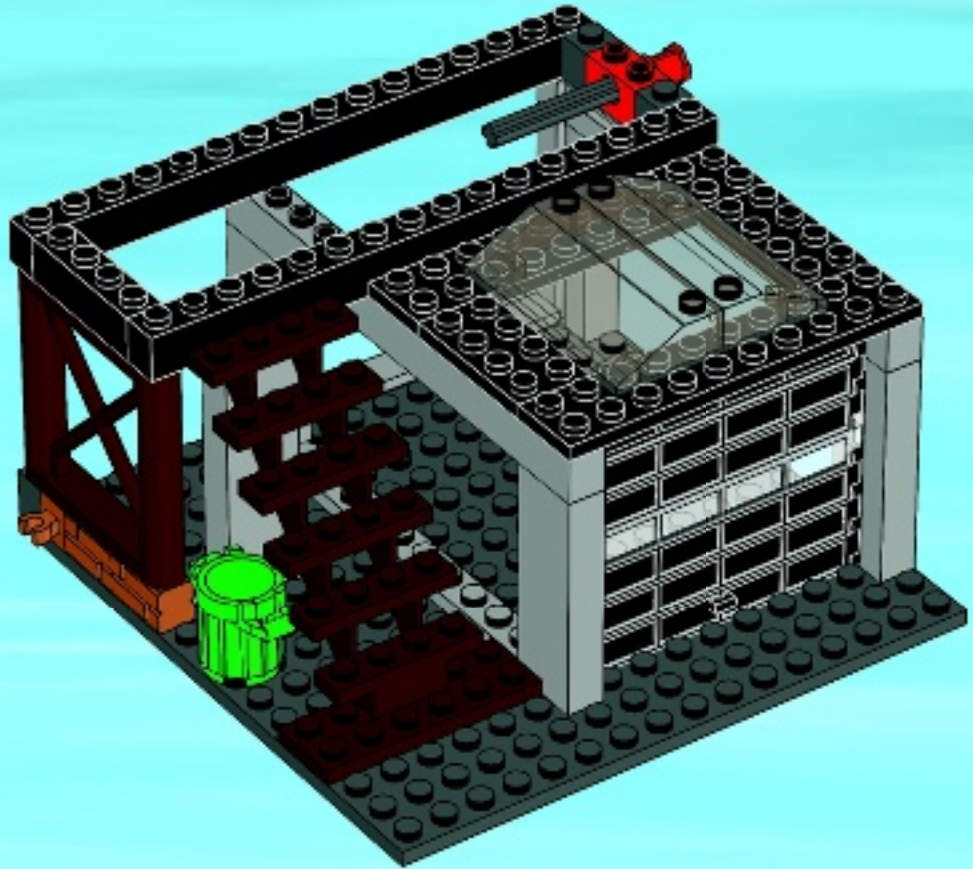

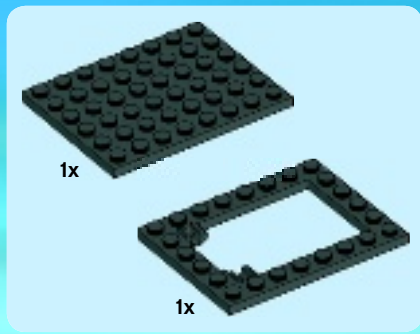

19

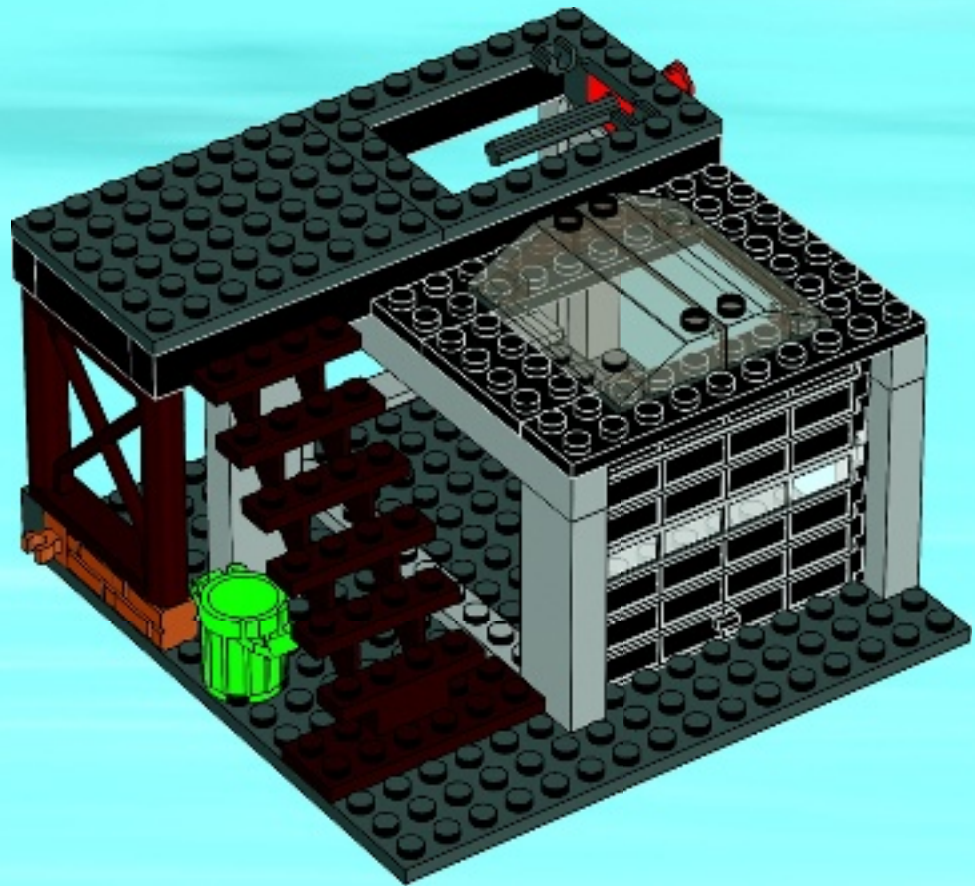



1x



2x

# 20

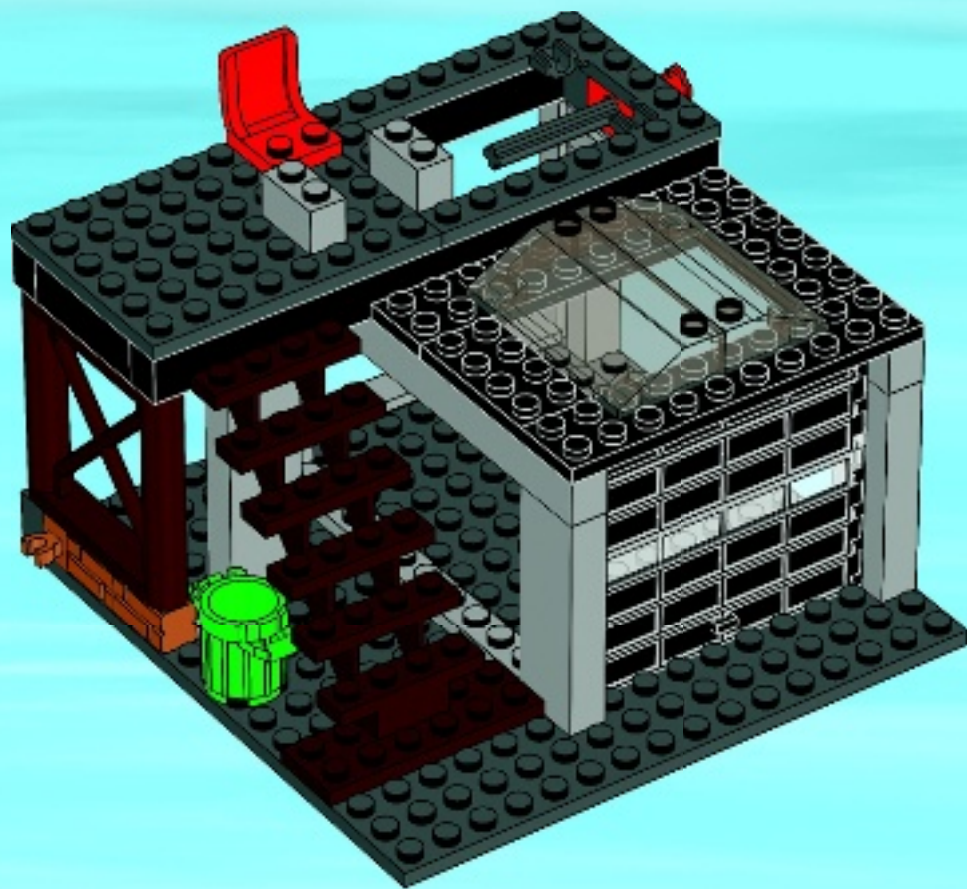



21

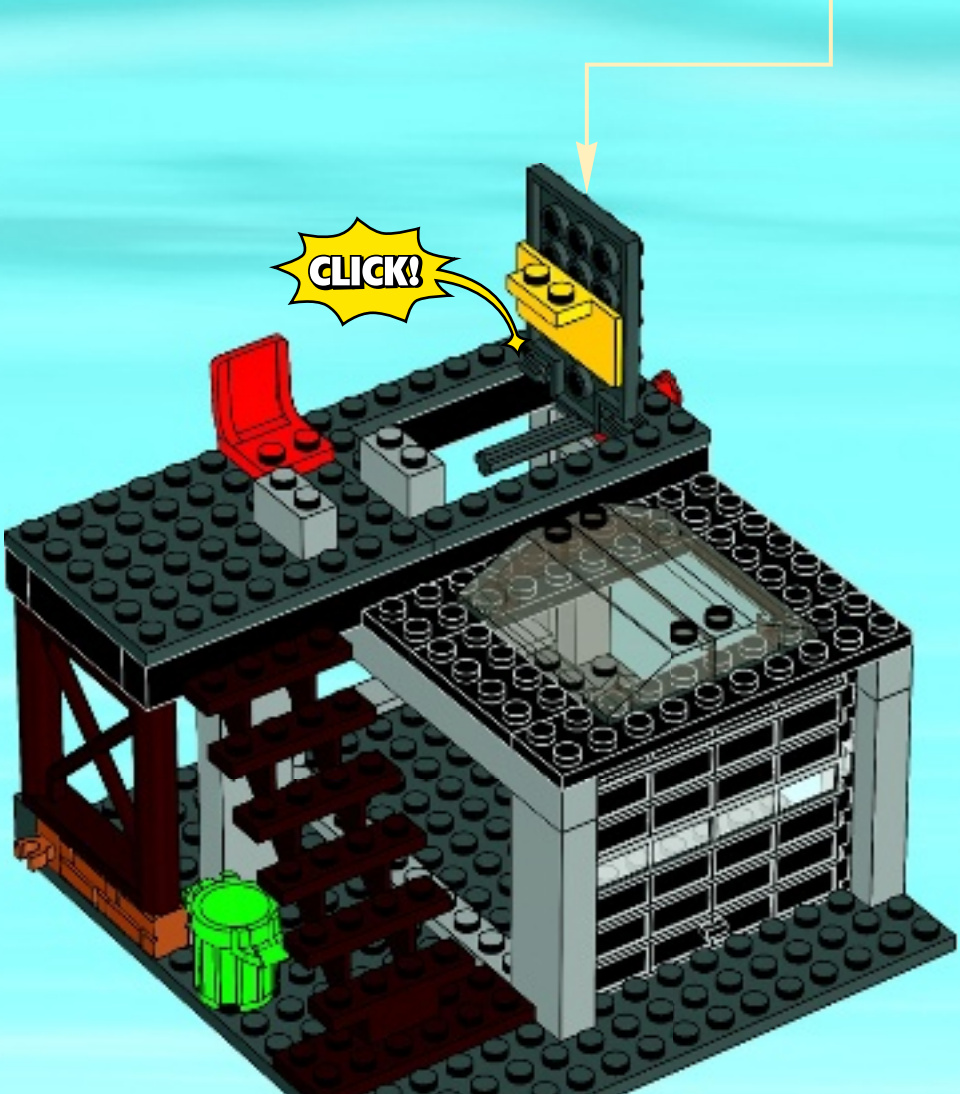
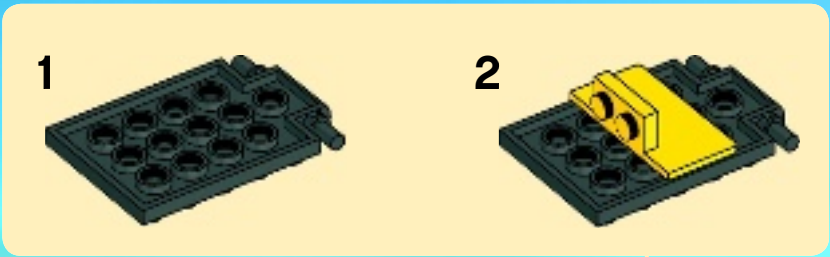

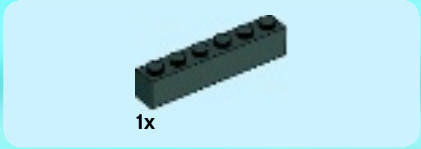
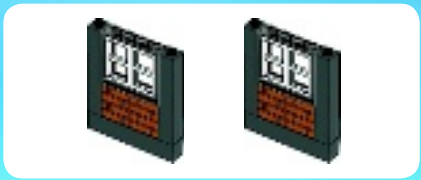

1

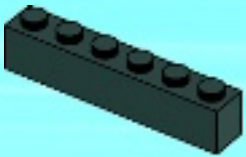

2x

2

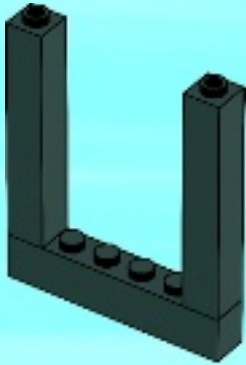



3

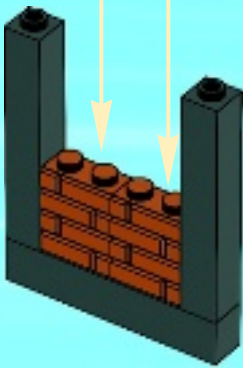
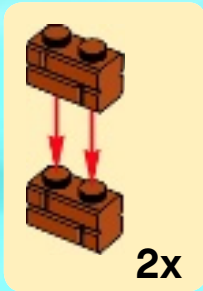

4

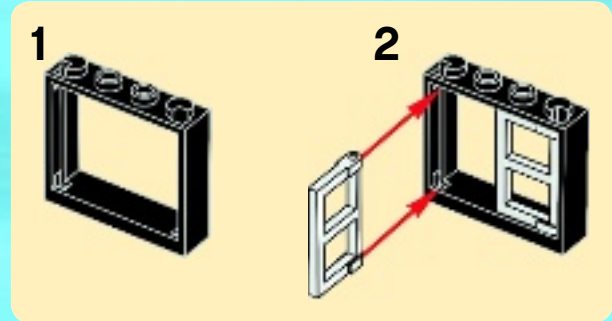

2x



22

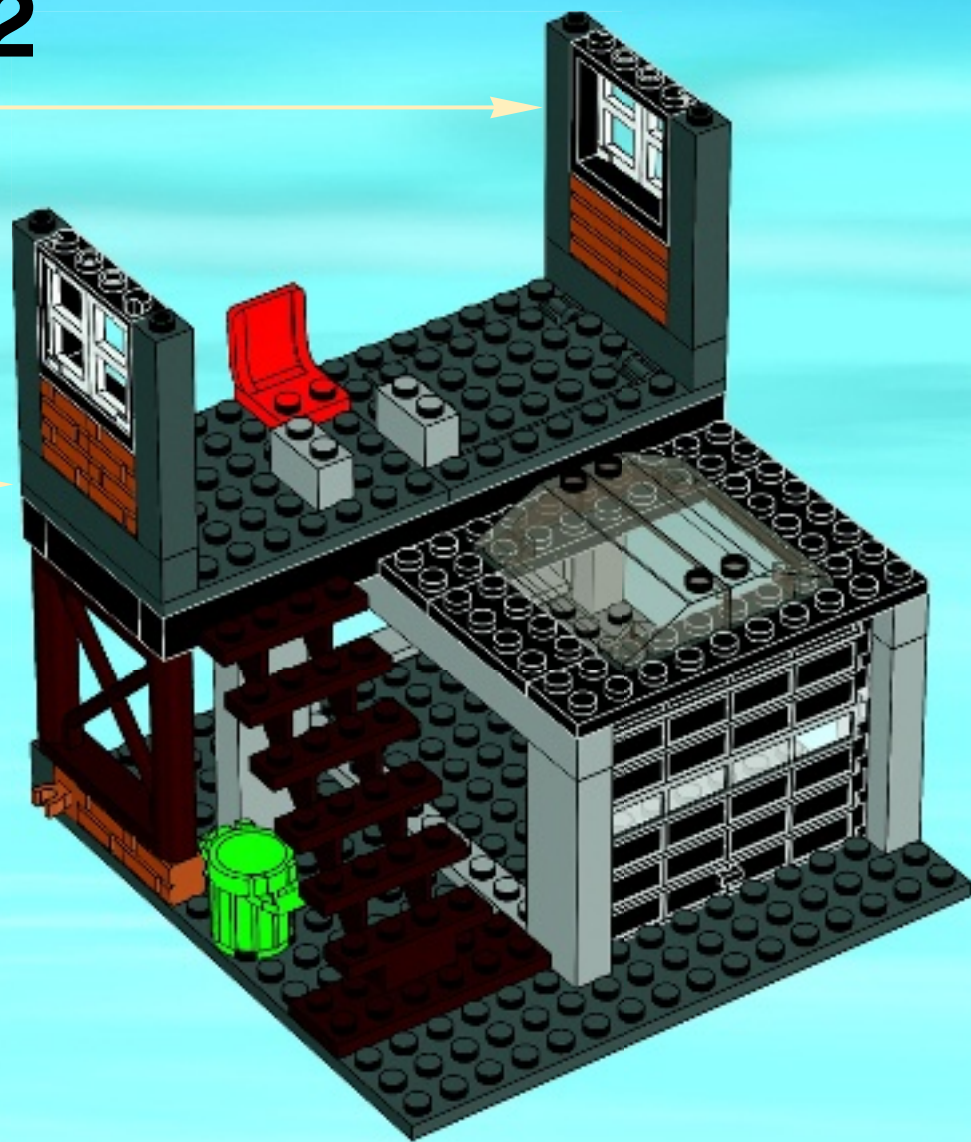



1x

23

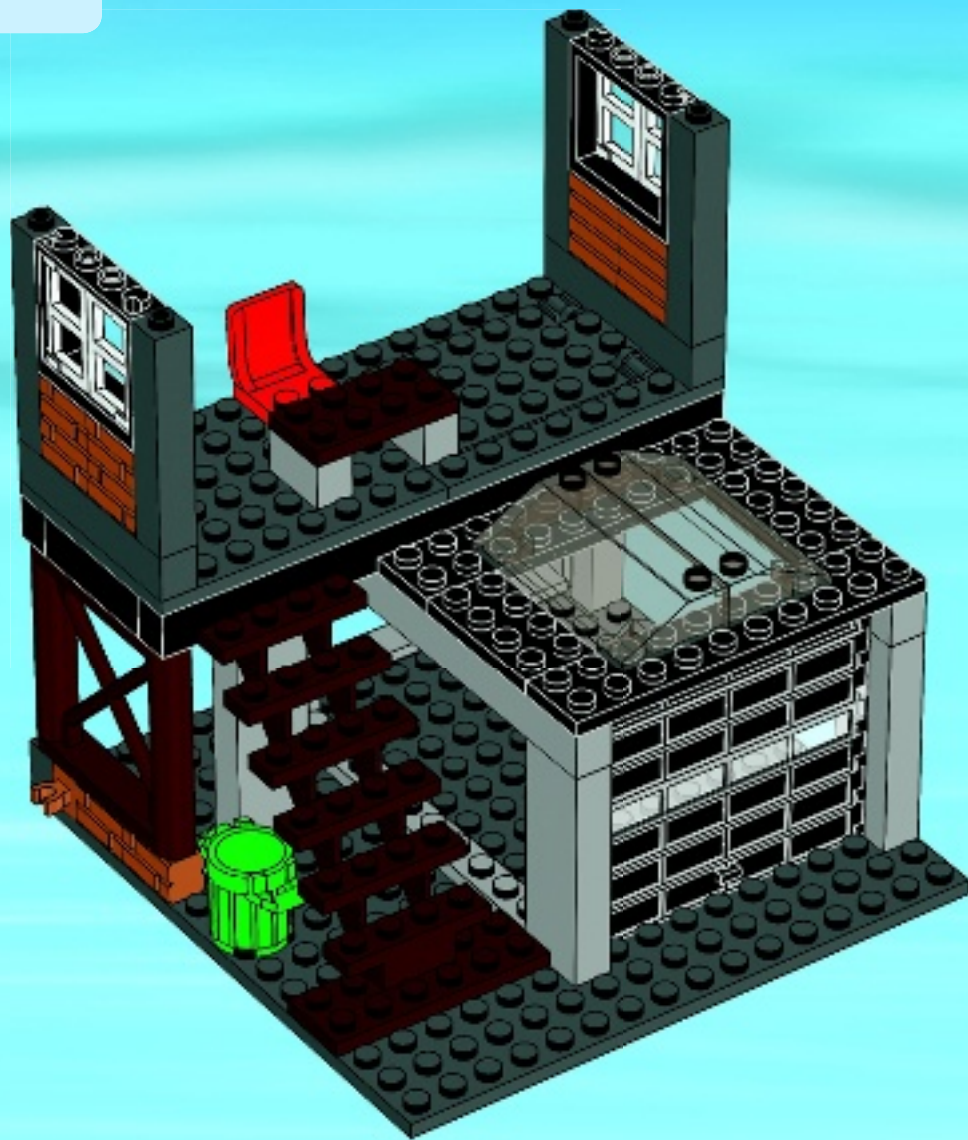

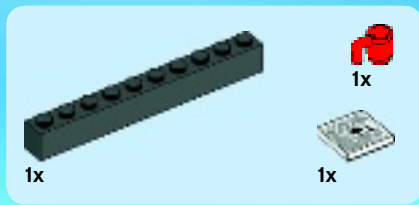

24

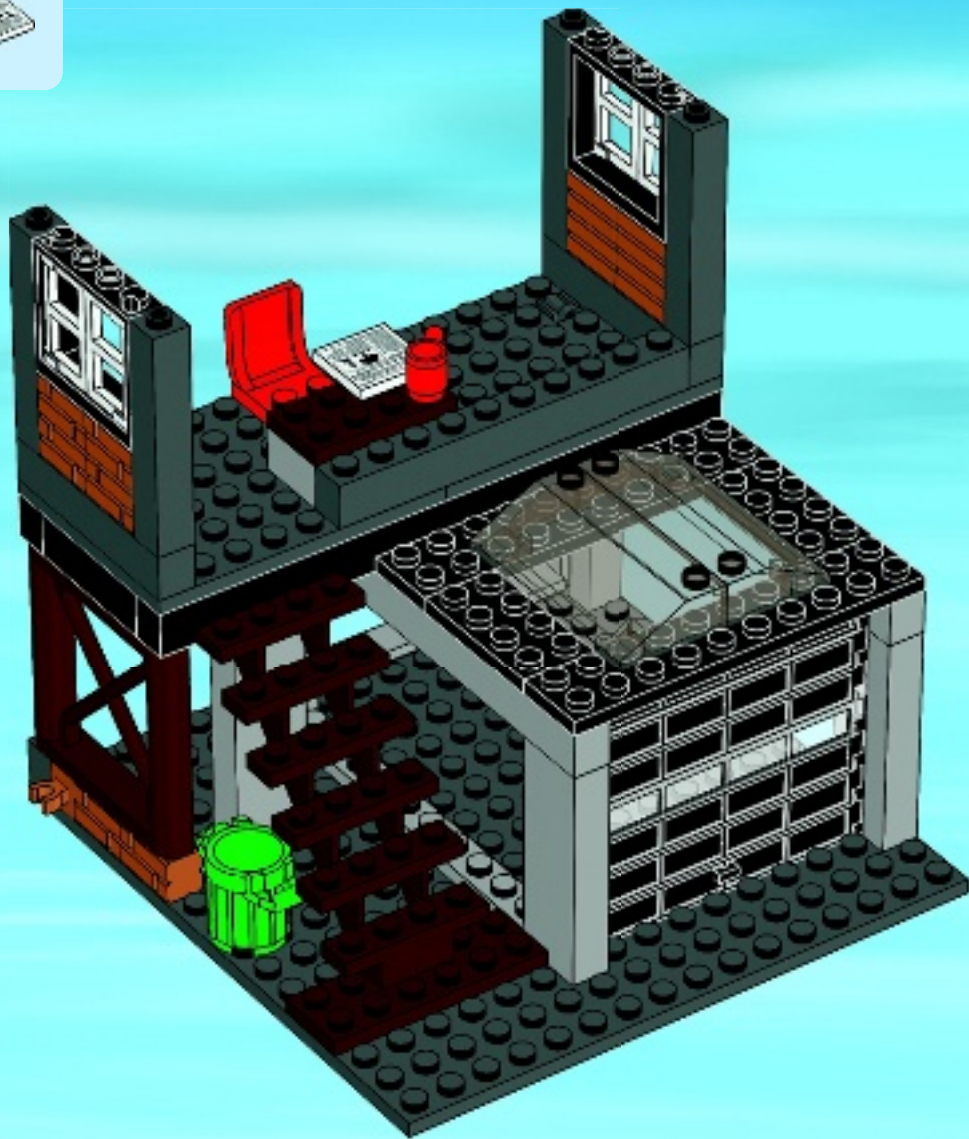



1x



4x

# 25

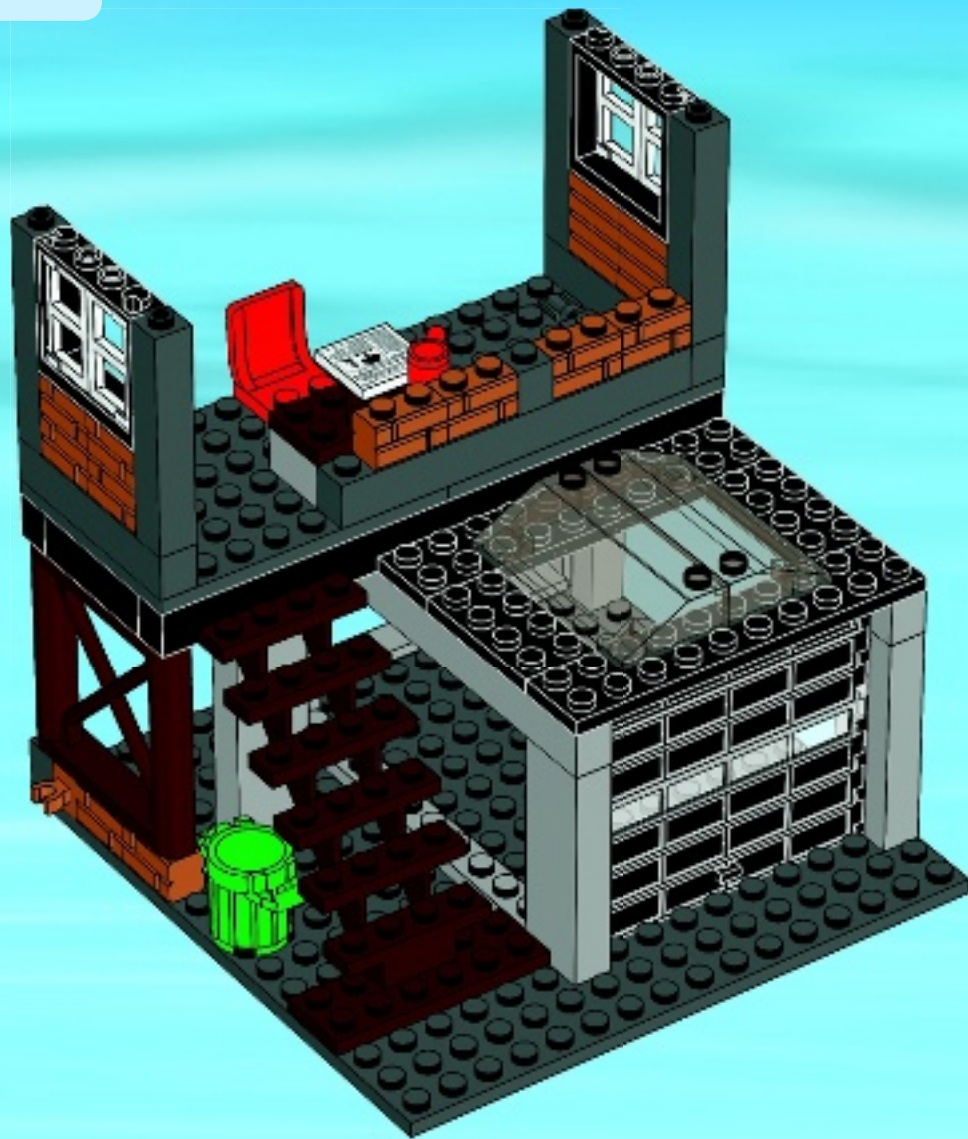



1x



4x

# 26

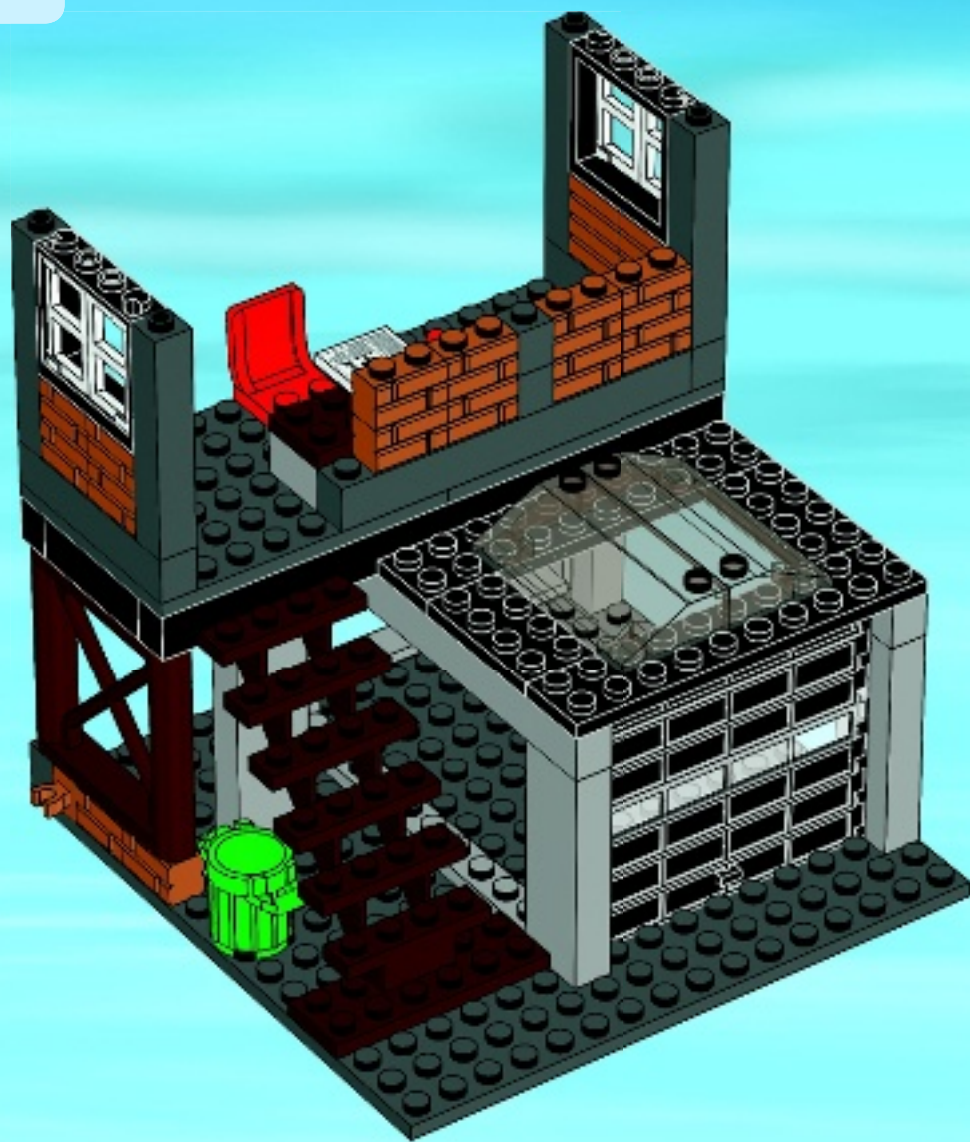



1x



1x

27

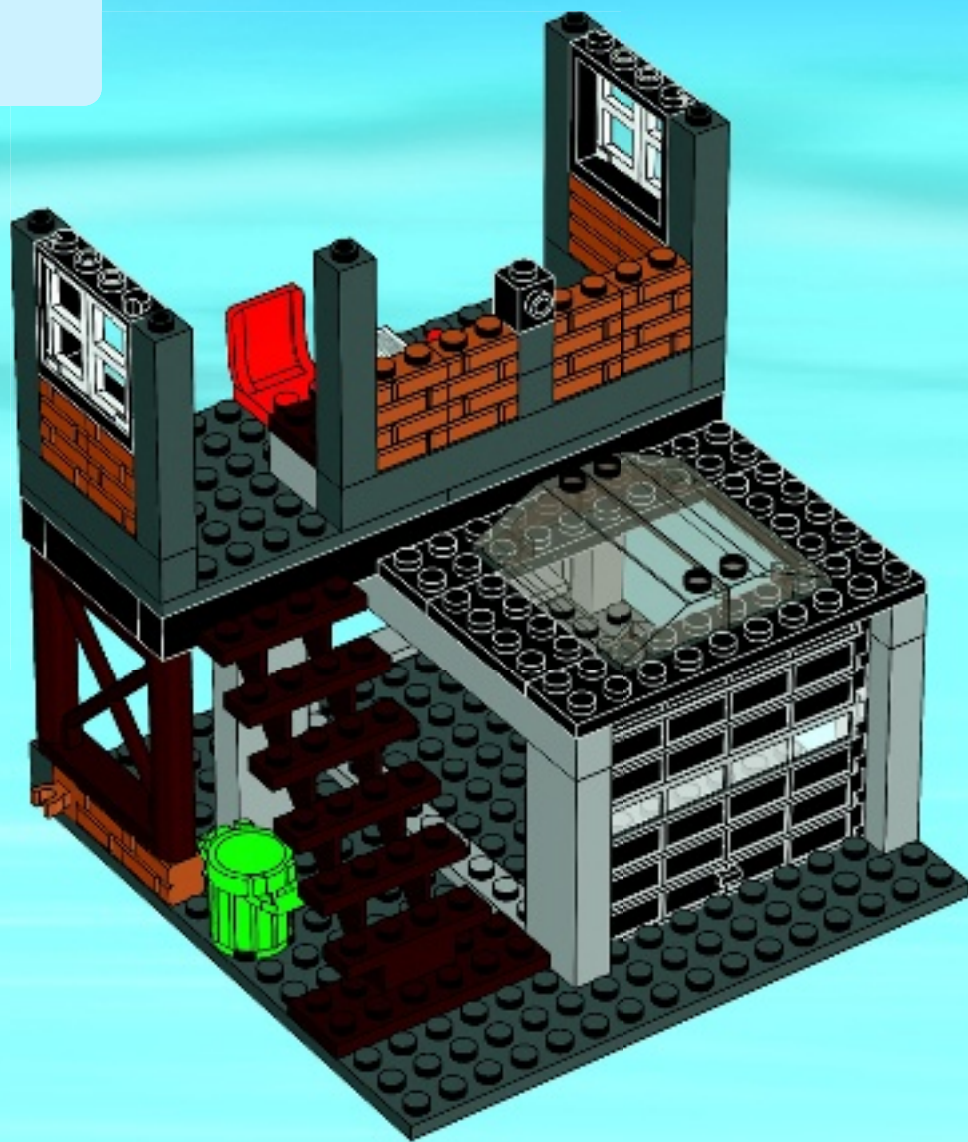



1x



1x

# 28

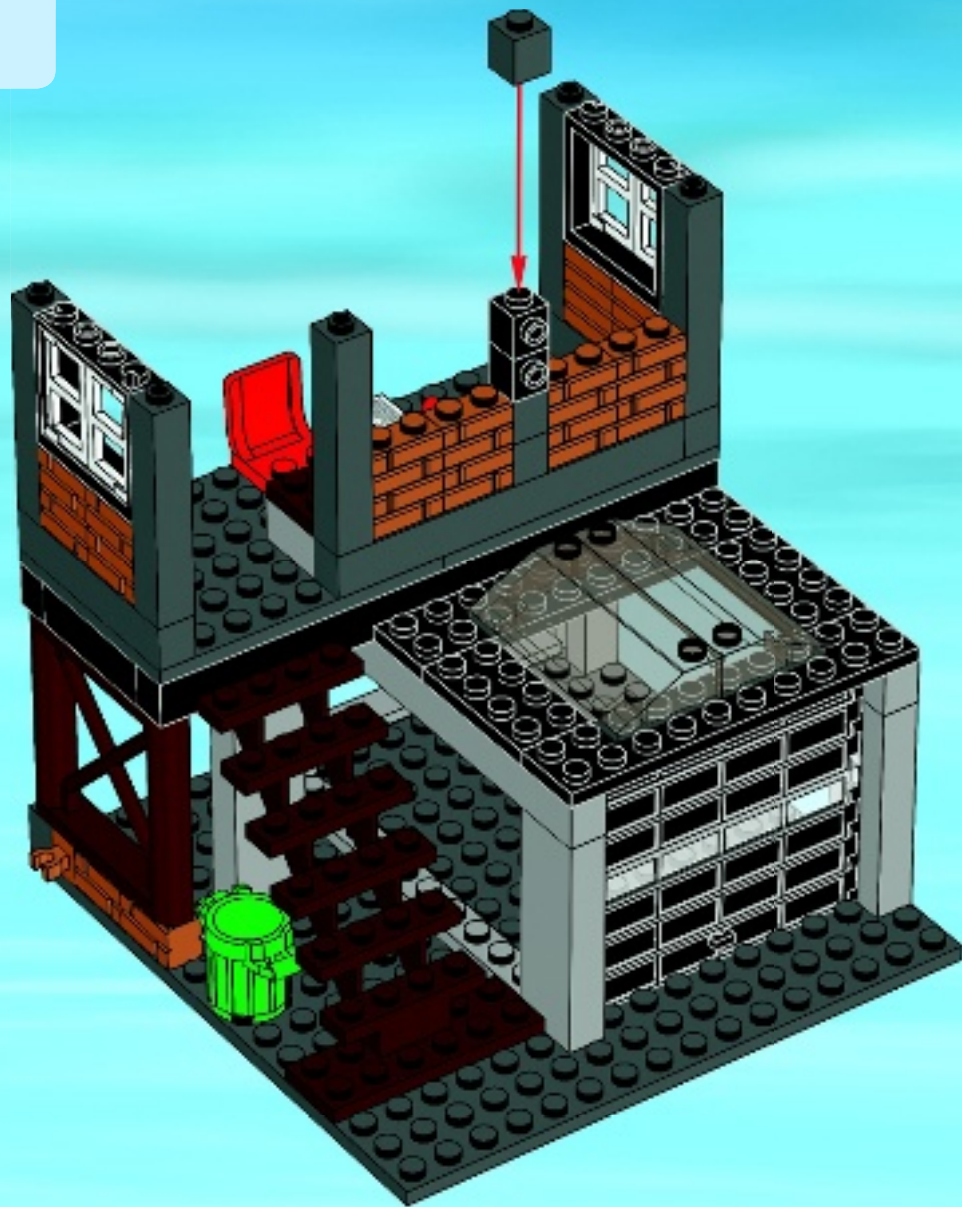

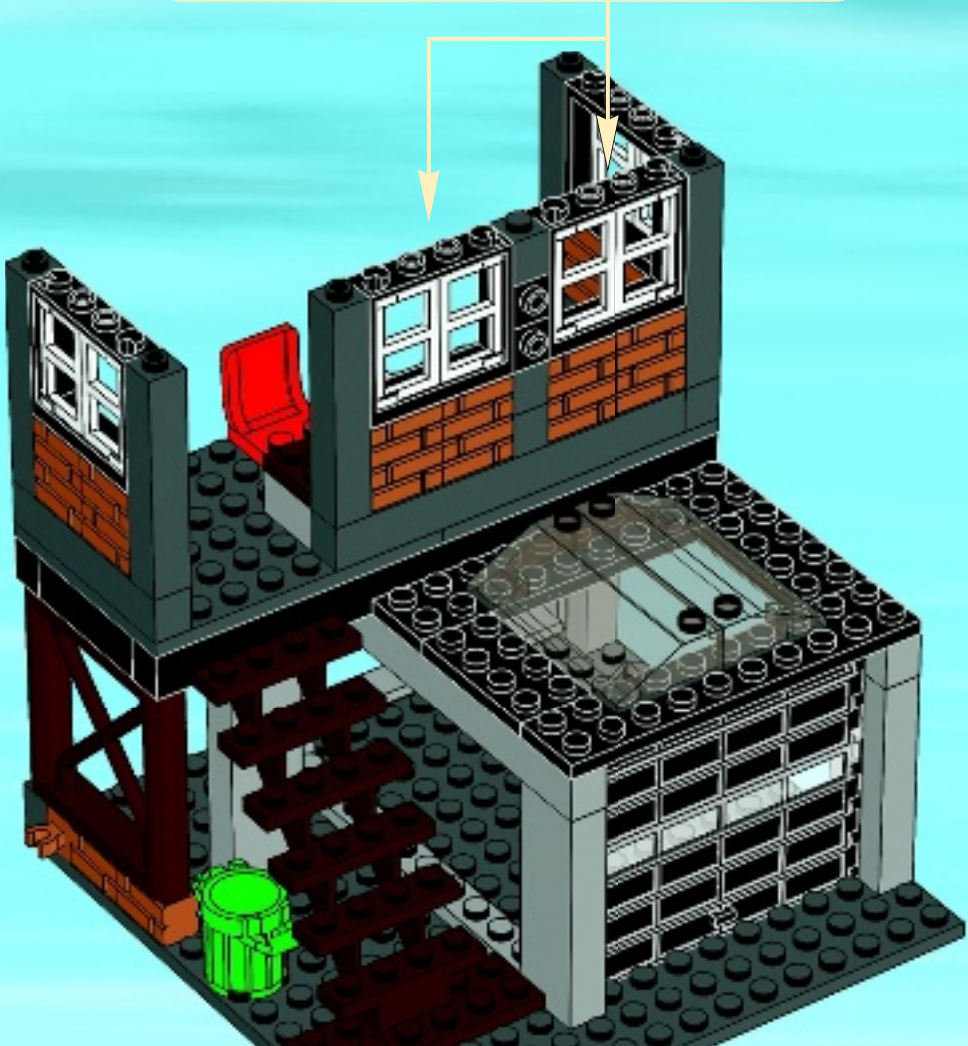
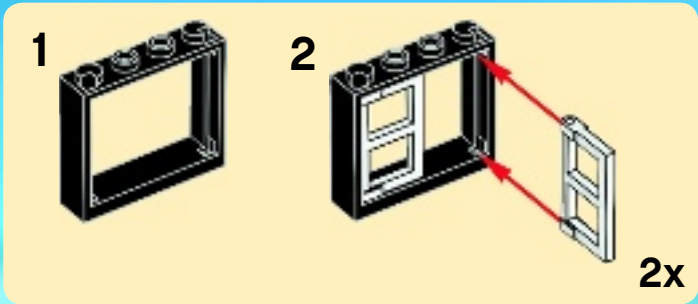
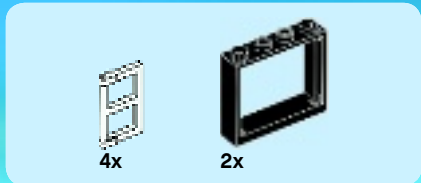



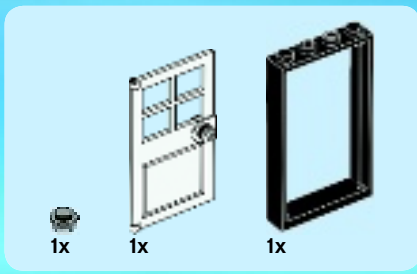

# 30

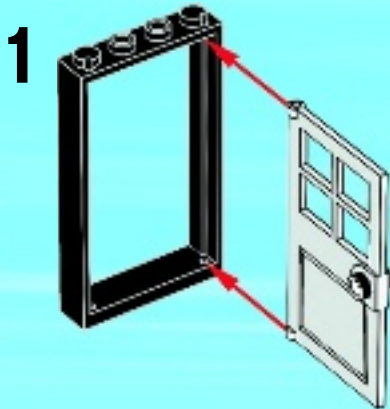

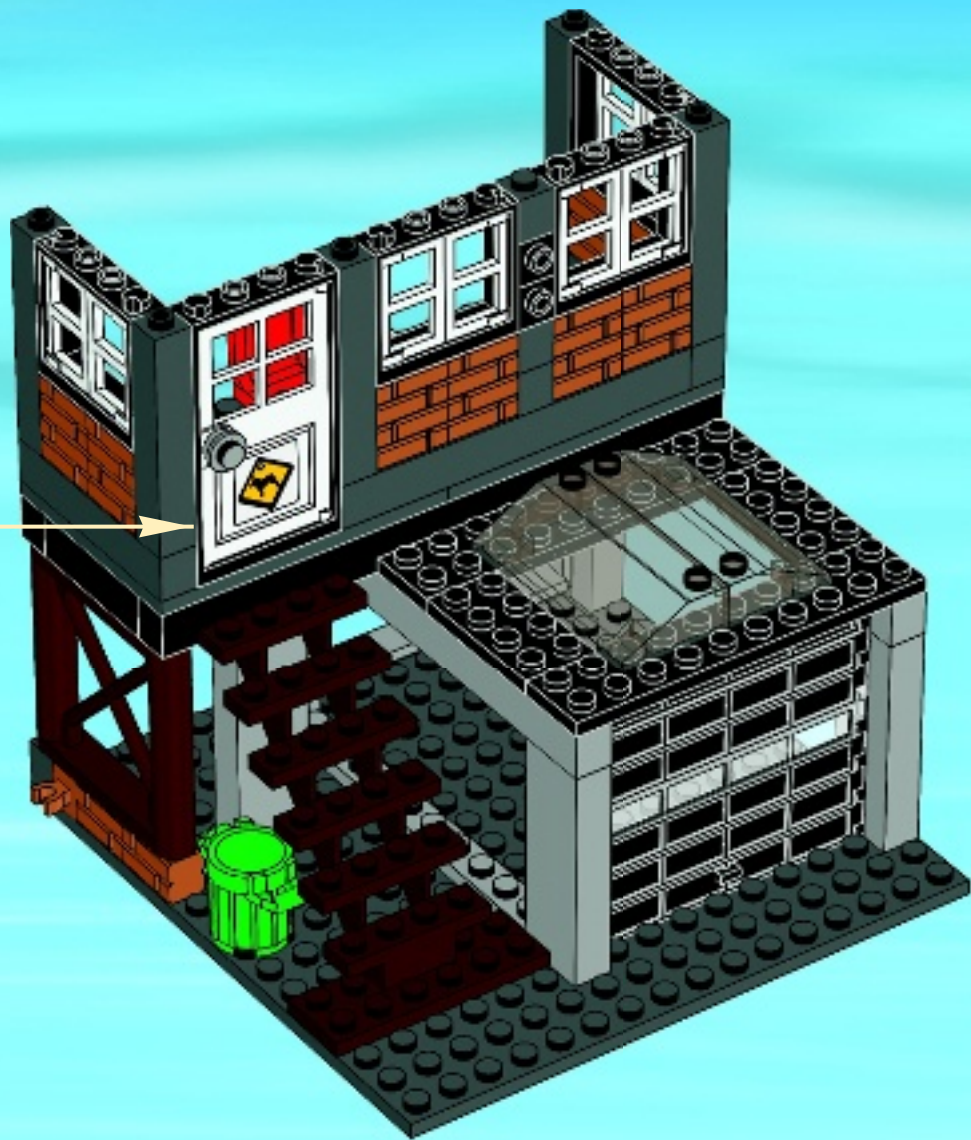



2x



2x

# 31

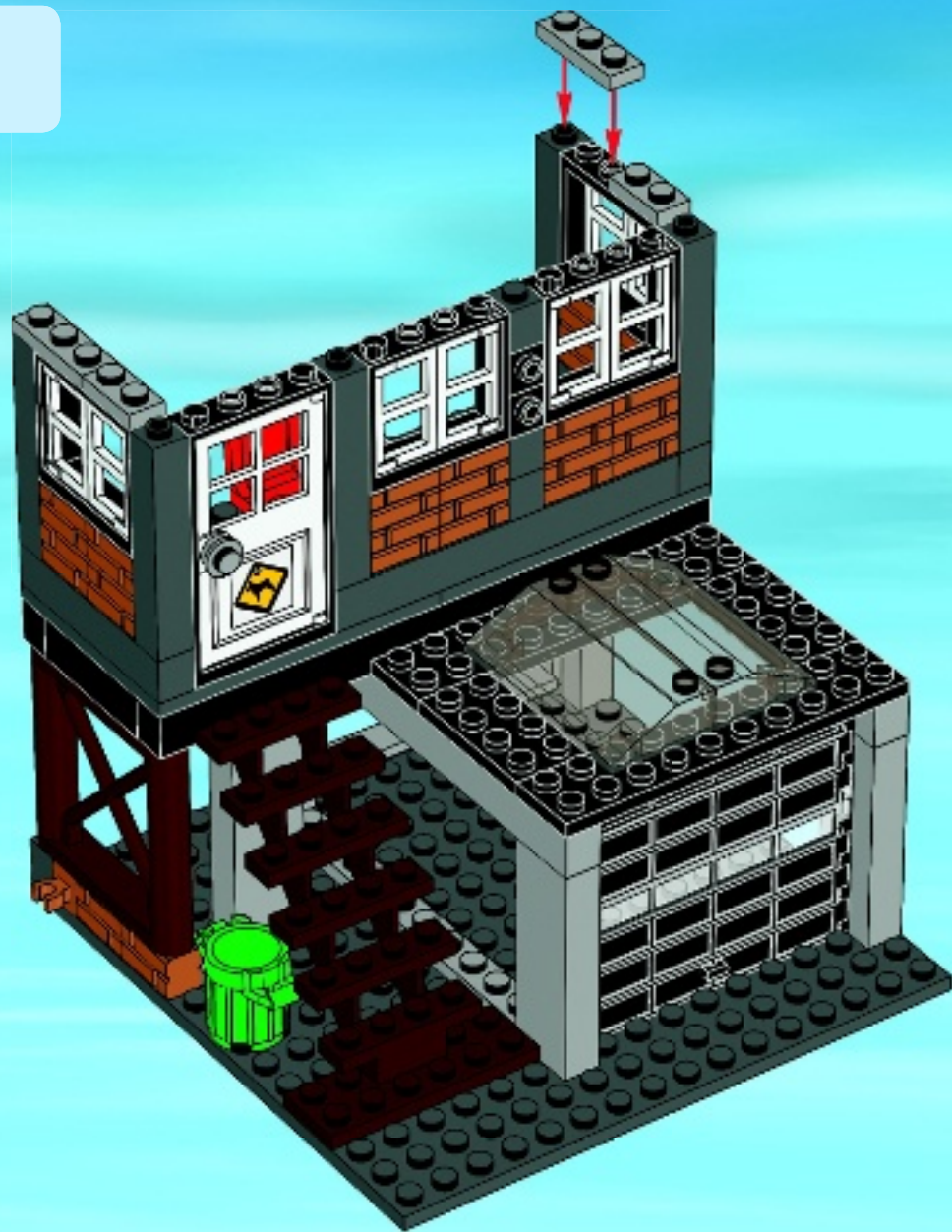

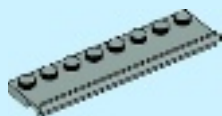

2x

32

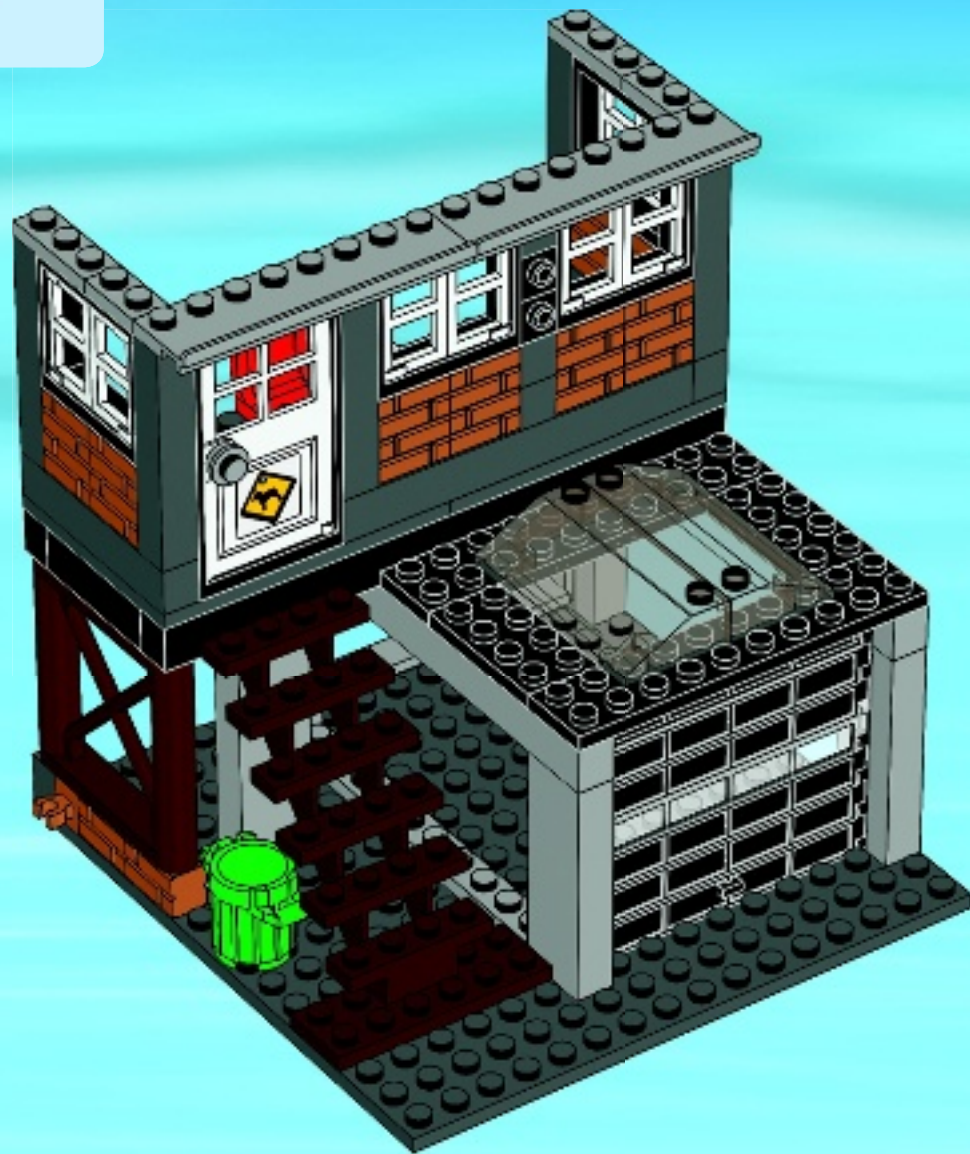



2x

# 33

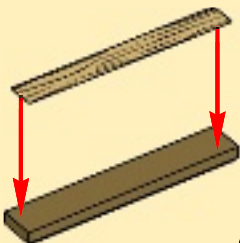

2x





1x

34

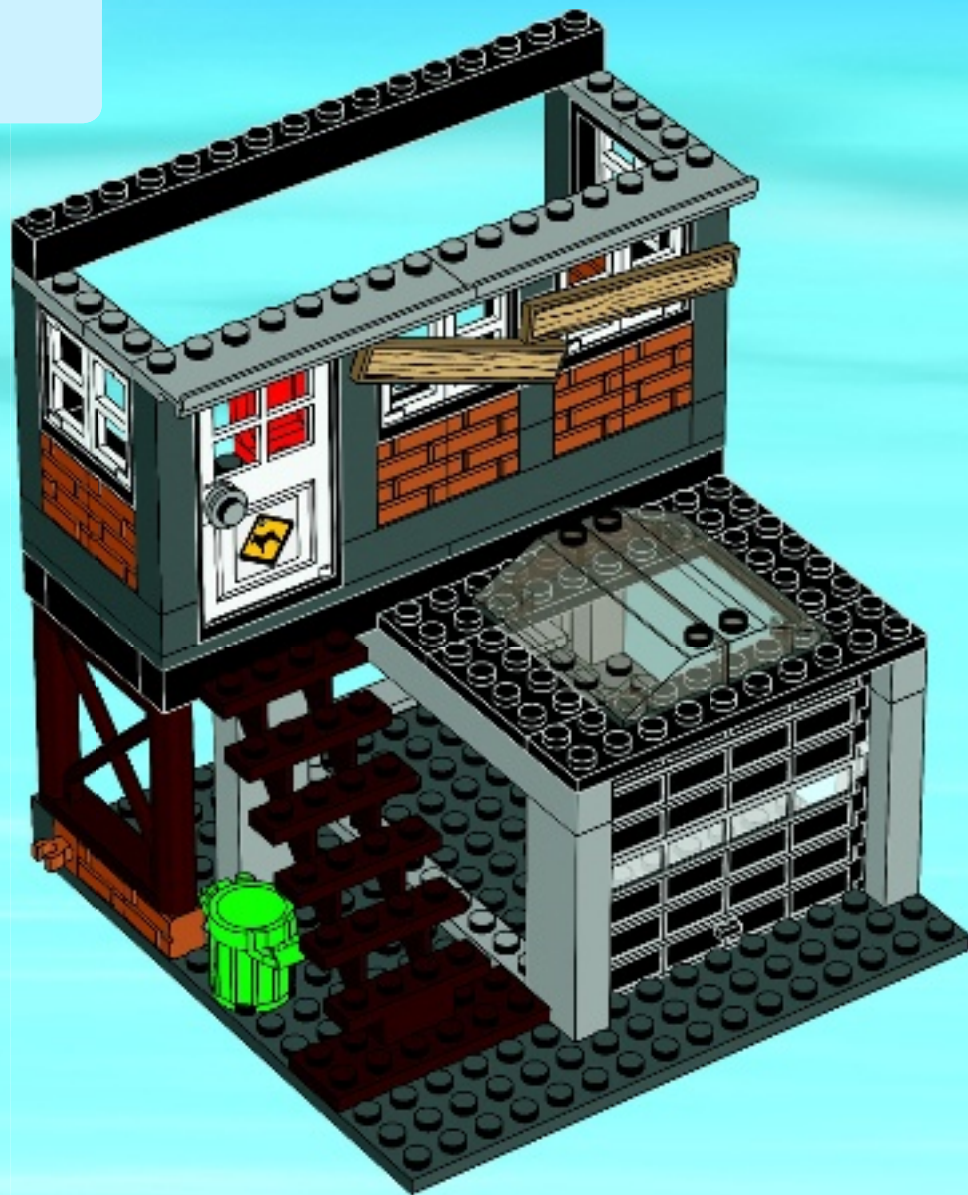



2x

# 35

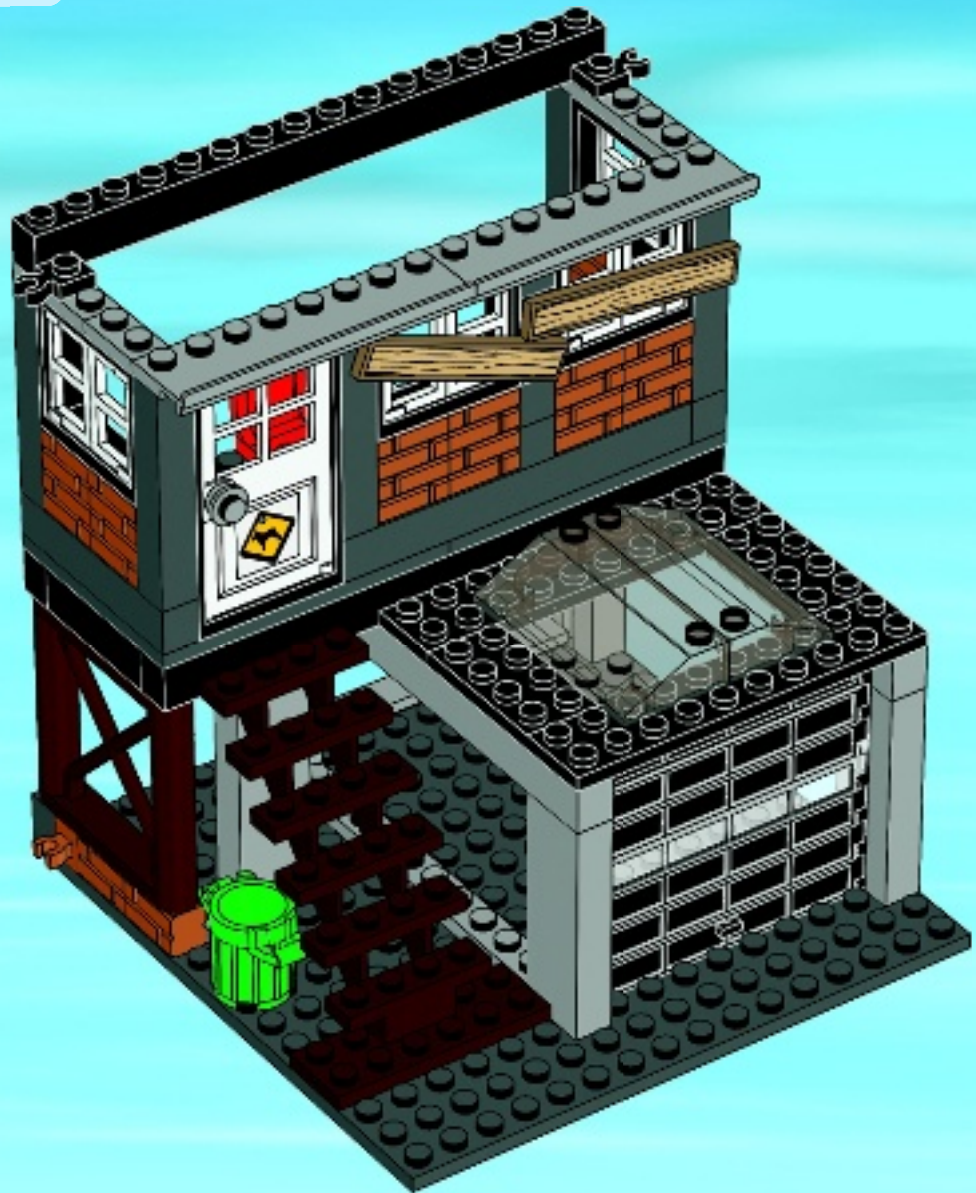

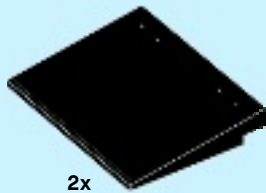

2x

36

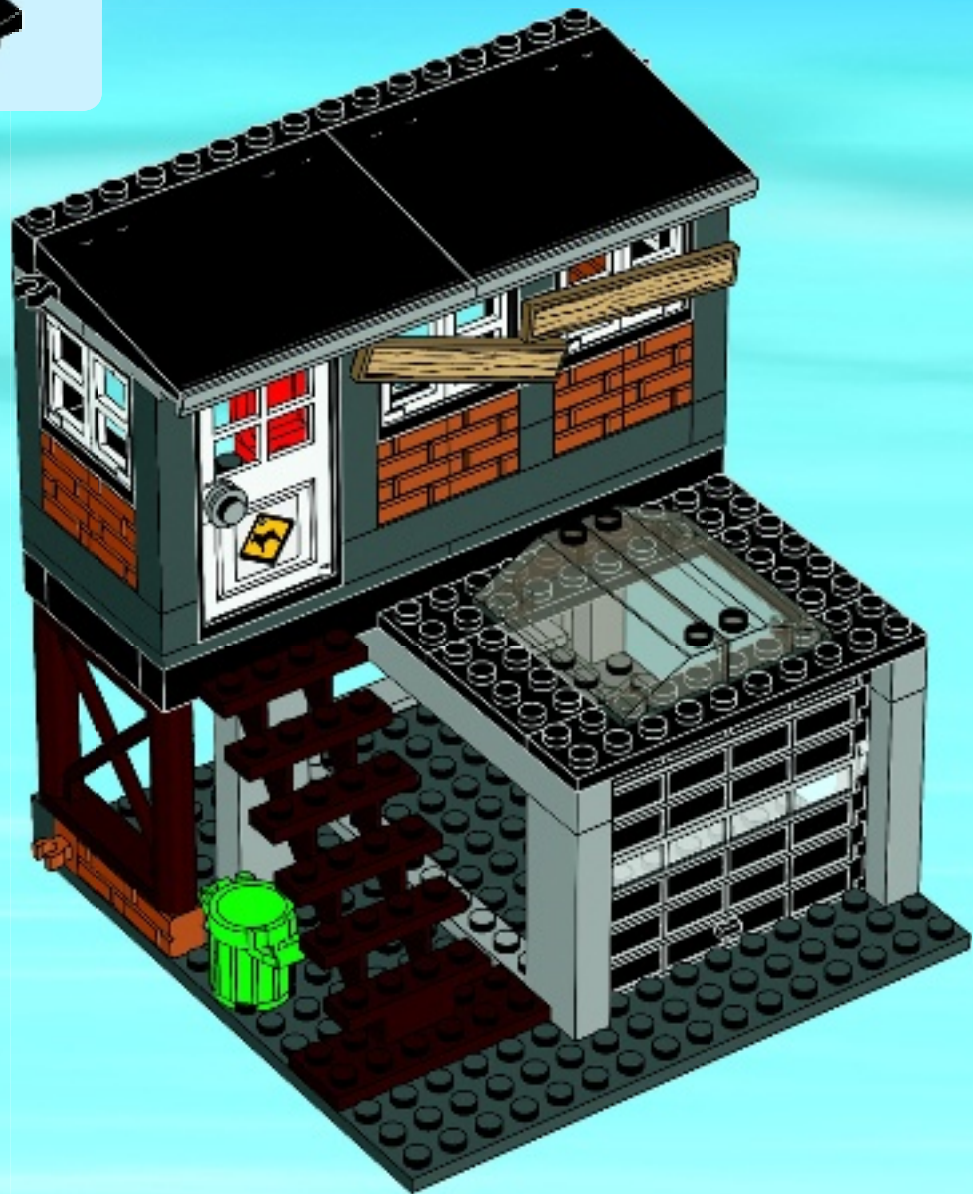



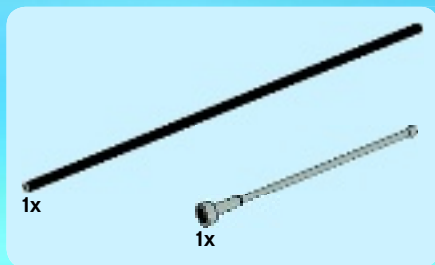

37

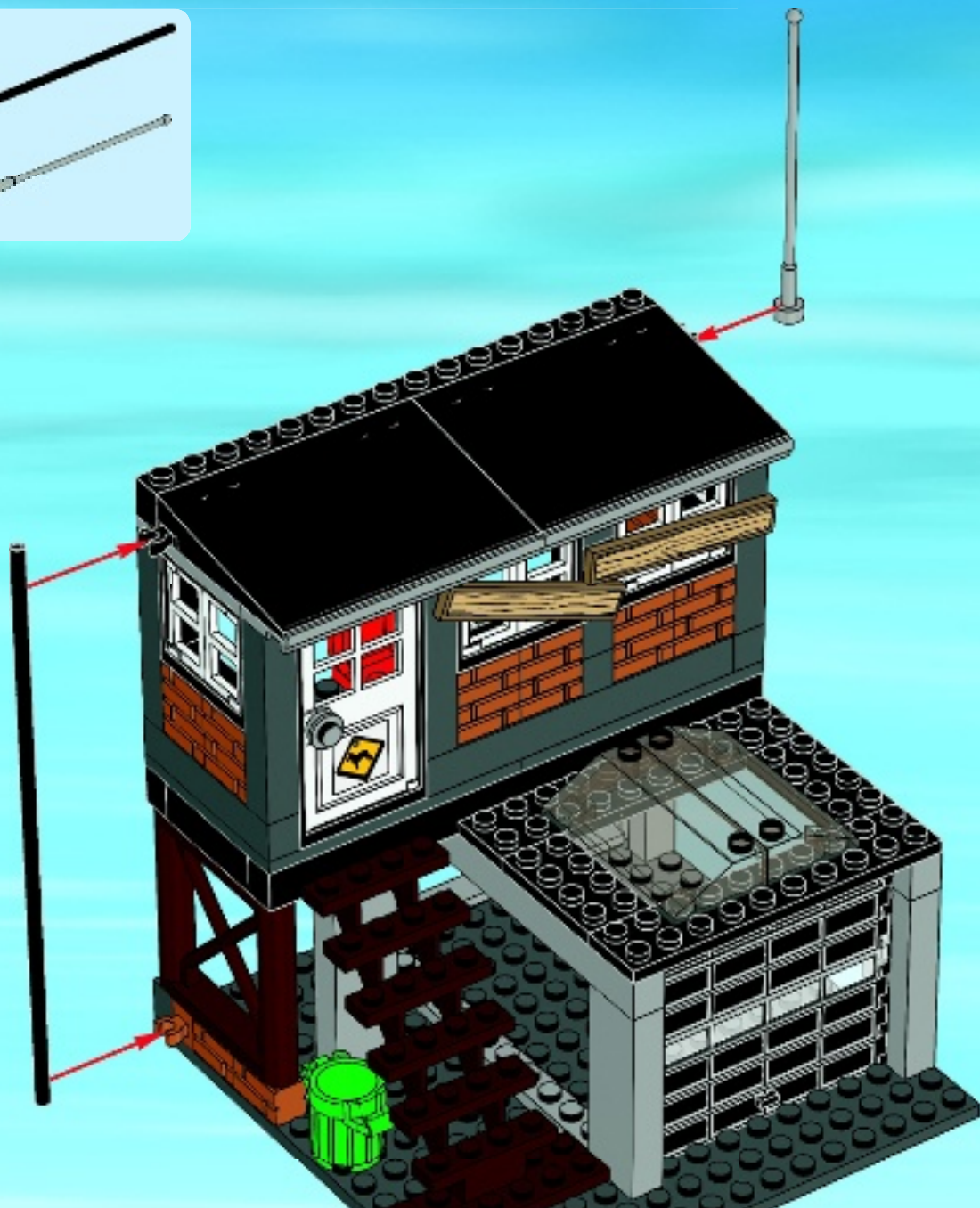

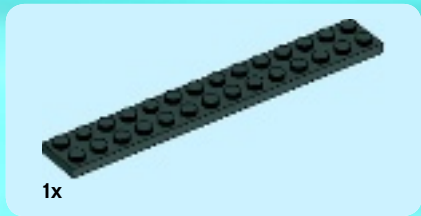

1

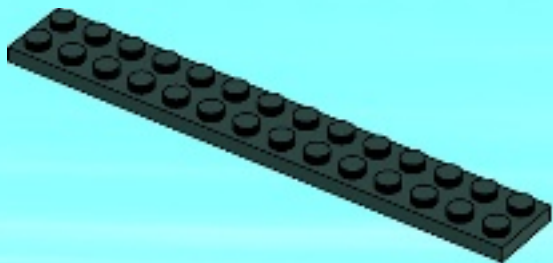

2

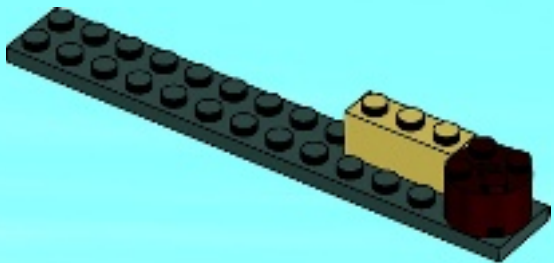



1x

3

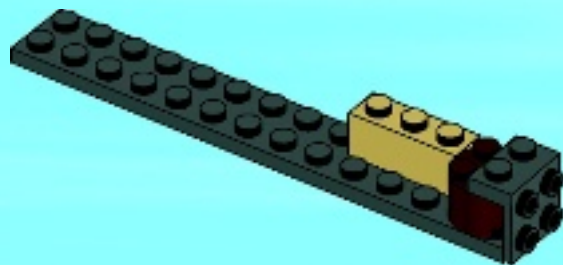

1x



1x

4

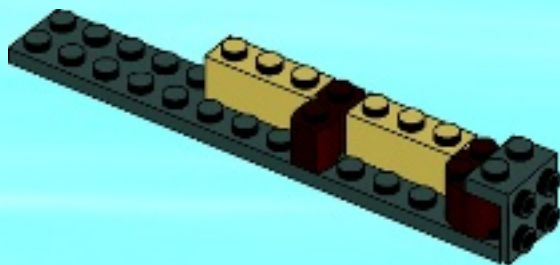



1x



1x



1x

5

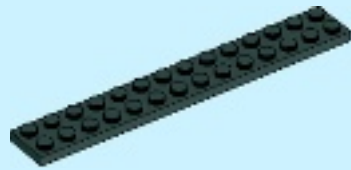
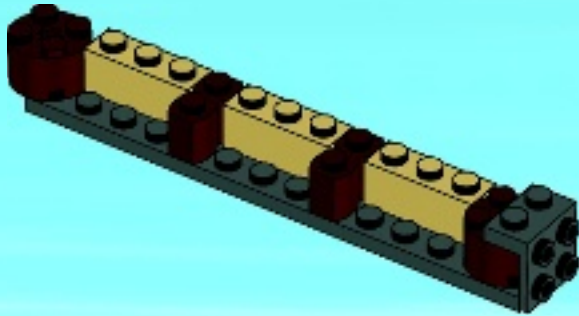

1x

6

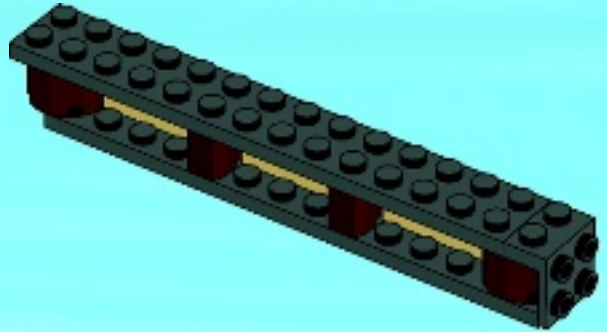



2x



1x

7

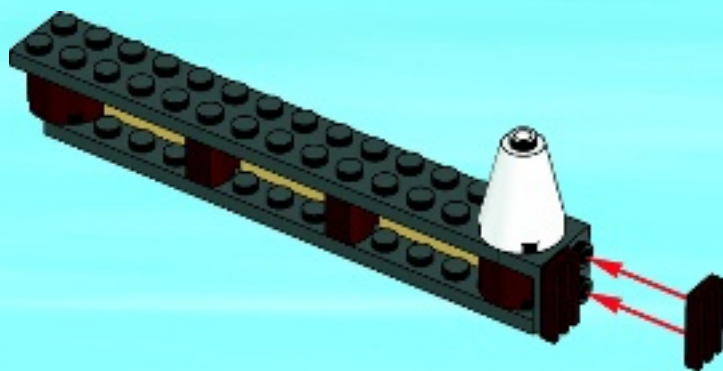



2x



2x

8

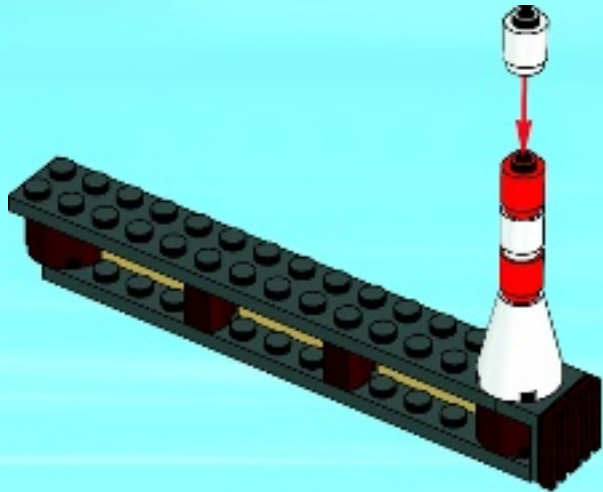

1x



1x

9

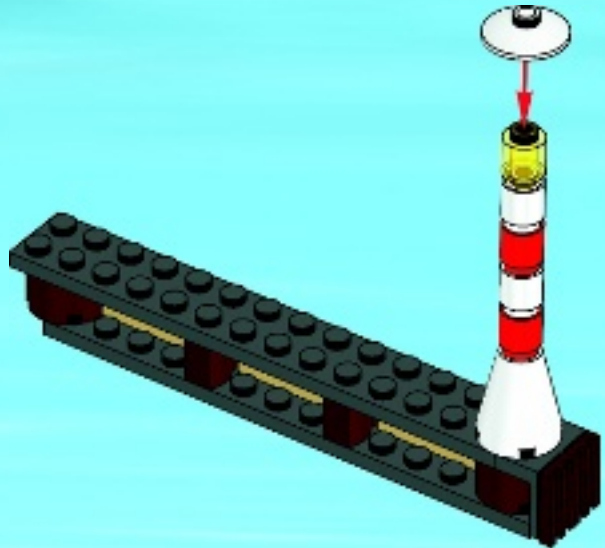

38

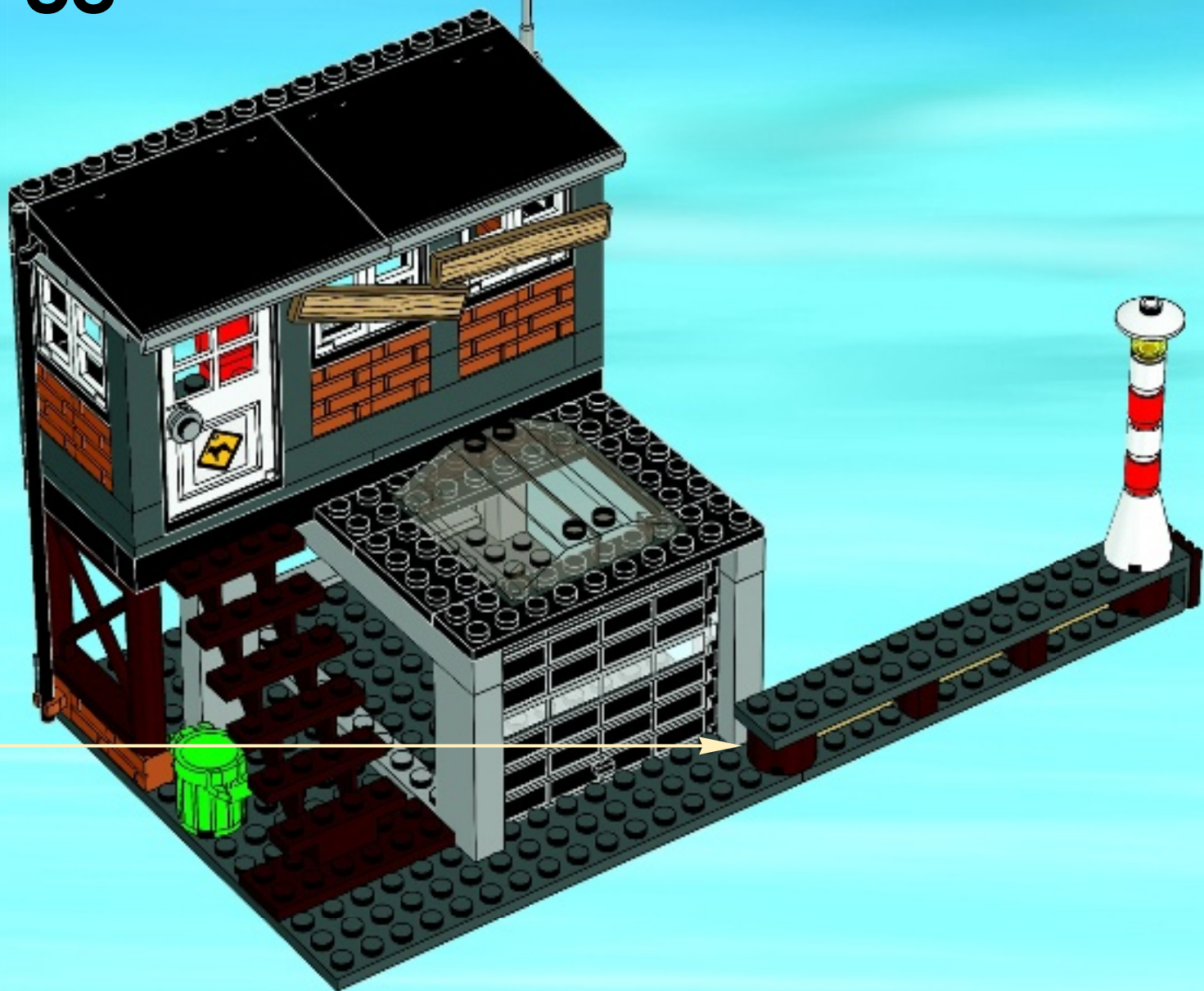



**EXPLORE TONS OF GAMES,  
MOVIES AND FUN CHALLENGES**



Entdecke viele Spiele, Filme und spannende Herausforderungen  
Découvre de nombreux films, jeux et défis amusants  
Explora abundantos xogos, películas e divertidos desafíos  
Explora una variedade de xogos, filmes e oportunidades de divertimento  
Fedezek fel sok-sok játékot, filmet, és érdekes kihívást!



2x  
4210934

3x  
4278274

2x  
6018686

1x  
4527082

1x  
4596895

1x  
4560184

4x  
4260124

1x  
4508553

1x  
4521572

1x  
4595710

1x  
4595708

1x  
4259673

2x  
4264898

1x  
4239373

2x  
4211100

2x  
4621917

1x  
4210997

1x  
4210794

2x  
4257526

1x  
4211107

2x  
6000970

1x  
6004927

1x  
6019987

6x  
4211098

5x  
4210690

2x  
4210797

1x  
4648256

1x  
4211052

2x  
4540386

2x  
4611703

1x  
4277928

2x  
4211053

3x  
4163306

1x  
4496442

2x  
4498370

2x  
4507047

1x  
4598955

2x  
4566927

2x  
4650498

1x  
4522255

1x  
4599045

1x  
4567994

7x  
4260426

2x  
3005748

1x  
4113955

2x  
6018507

4x  
4173805

2x  
4121967

2x  
6023970

2x  
4524929

2x  
4177932

1x  
4118782

2x  
4526363

1x  
4545313

1x  
4545315

1x  
6004919

1x  
4650976

2x  
306201



1x  
6022158



1x  
6016723



2x  
4183035



1x  
4655208



1x  
4183048



1x  
4558168



1x  
4179875



1x  
4179874



1x  
474001



8x  
4520842



1x  
4298609



1x  
4600294



4x  
4170457

50



1x  
4249112



1x  
371001



1x  
4521943



1x  
4521943



2x  
4530590



2x  
4530590



2x  
234001

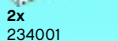

1x  
663601



1x  
4259937



1x  
4259937



1x  
244501



1x  
4560930



1x  
4560930



1x  
6023974



1x  
6023974



2x  
362221



1x  
4181138



2x  
306221



1x  
370021



2x  
428621



2x  
4160406



2x  
4226876



2x  
4530734



3x  
407921



1x  
389921



2x  
4540382



1x  
4227155



3x  
4162465



1x  
4618652



1x  
4618652



4x  
302026



4x  
4160393



2x  
4161067



1x  
4667008



5x  
4582536



2x  
383226

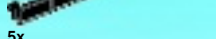

1x  
4209683



2x  
4527604



2x  
4527604



3x  
246526



1x  
4291611



1x  
4533412



1x  
4533412



1x  
4533412



1x  
4533412



2x  
4541984

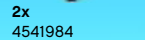

1x  
4535834



4x  
4530589

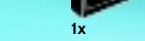

1x  
4599984



4x  
4568644

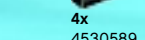

1x  
4599984



4x  
4568644

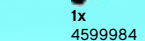

4x  
4568644



4x  
4568644

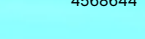

1x  
396026

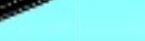

1x  
396026



1x  
396026



1x  
396026



1x  
396026



1x  
396026



2x  
4558954



2x  
4550017



1x  
4144023



4x  
241226



2x  
4183043



1x  
4121715



2x  
9339



2x  
4522653



4x  
6006739



1x  
301026



1x  
4278359



1x  
247926



4x  
4538722



2x  
4660876



2x  
4660876



1x  
4277751



1x  
6002837



2x  
4211180



2x  
4211166



1x  
4211186



1x  
4211247



2x  
4224243



1x  
4211163



1x  
4626650



2x  
4295260



1x  
4516816



1x  
4528605



1x  
4569385



18x  
4656783



1x  
4614195



2x  
4632100



1x  
4248345



2x  
4646864



2x  
3005741



1x  
4113954



1x  
4541537



1x  
3006844



1x  
4194746



1x  
4194535



1x  
4648281



2x  
9553



2x  
4218699



2x  
4239601



1x  
302124



1x  
4613344



2x  
243224



2x  
74156



2x  
4193511



1x  
4259916



1x  
6021844



1x  
4506998



1x  
6021851



1x  
6018687



1x  
4641048



2x  
4211569



1x  
4541978



1x  
4211350



2x  
4211464



4x  
4211388



1x  
4211387



3x  
4211807



2x  
4278756



1x  
4211515



2x  
4211398



3x  
4211429



1x  
6015347



2x  
6023973



1x  
4251149

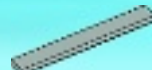

1x  
4211481



2x  
4222019

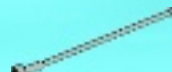

1x  
4251564



1x  
4211452



1x  
4560183

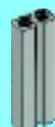

5x  
4582153



1x  
4211525



2x  
6023978



2x  
4530028



1x  
6023399



2x  
6018588



1x  
6032144



1x  
6023972



1x  
6023971



Customer Service

Kundenservice

Service Consommateurs

Servicio Al Consumidor

LEGO.com/service or dial



: 00800 5346 5555

: 1-800-422-5346



# WIN!

Go to [www.LEGOsurvey.com/product](http://www.LEGOsurvey.com/product) to fill out a survey for a chance to win a cool LEGO® Product. No purchase necessary. Open to all residents where not prohibited.

 [LEGO.com](http://LEGO.com)



## [www.LEGOsurvey.com/product](http://www.LEGOsurvey.com/product)

### GEWINNE! WIN!

Nimm an der Umfrage auf [www.LEGOsurvey.com/product](http://www.LEGOsurvey.com/product) teil und hab die Chance ein cooles LEGO® Produkt zu gewinnen!

Die Teilnahme am Gewinnspiel führt zu keinerlei Kaufverpflichtungen. Teilnahme in allen nicht ausgeschlossenen Ländern möglich.

Ga naar [www.LEGOsurvey.com/product](http://www.LEGOsurvey.com/product), vul een enquêteformulier in en maak kans op een cool LEGO® product.

Geen aankoopverplichting. Iedereen mag deelnemen, uitgezonderd ingezetenden van landen waar een enquêteverbod geldt.

### GAGNE! 当てよう!

Visite [www.LEGOsurvey.com/product](http://www.LEGOsurvey.com/product) pour répondre à un questionnaire et avoir une chance de gagner un produit LEGO® très cool!

Aucune obligation d'achat. Ouvert à tous les résidents des pays autorisés.

[www.LEGOsurvey.com/product](http://www.LEGOsurvey.com/product) にアクセスして、アンケートにご記入ください。当選者にはレゴ®製品を差し上げます。

お買い上げの必要はありません

禁止されていない限り、すべての皆様にご利用いただけます。