



# CITY

60047





+

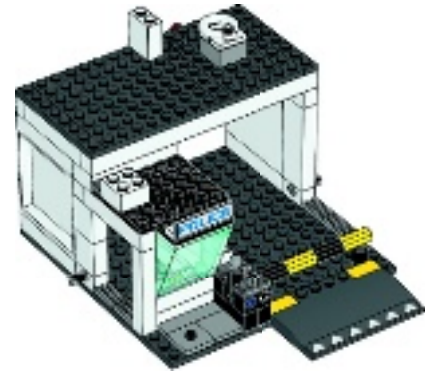

2x

1

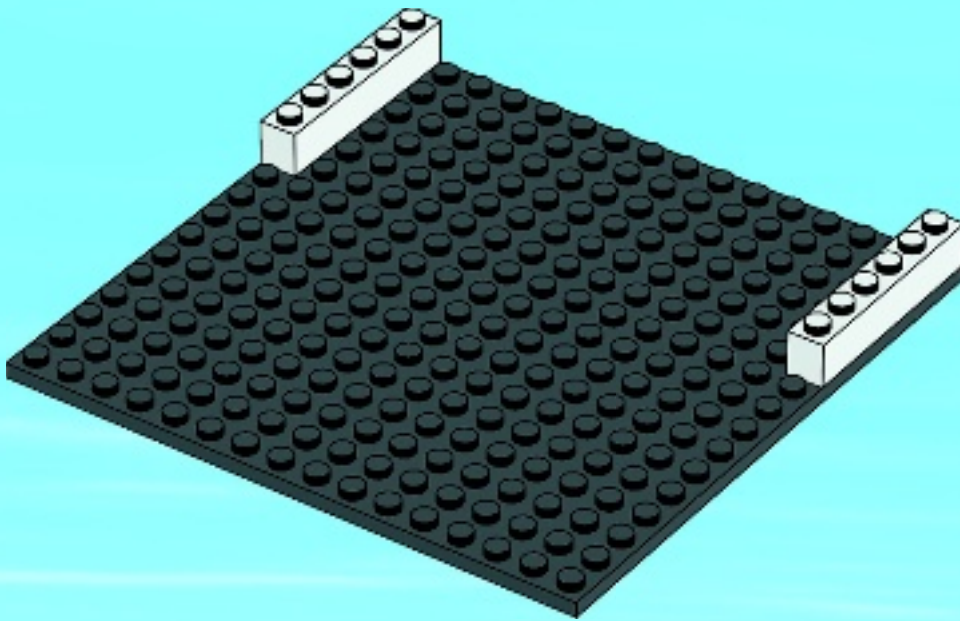



2x



2x

# 2

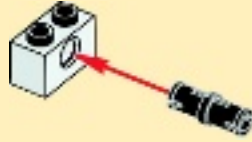

2x

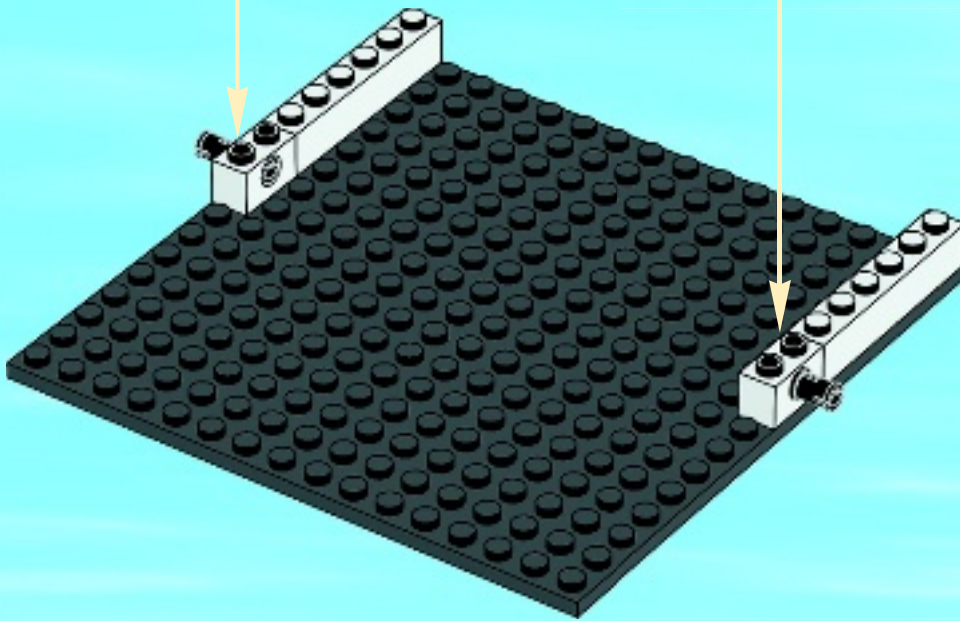





4x

3

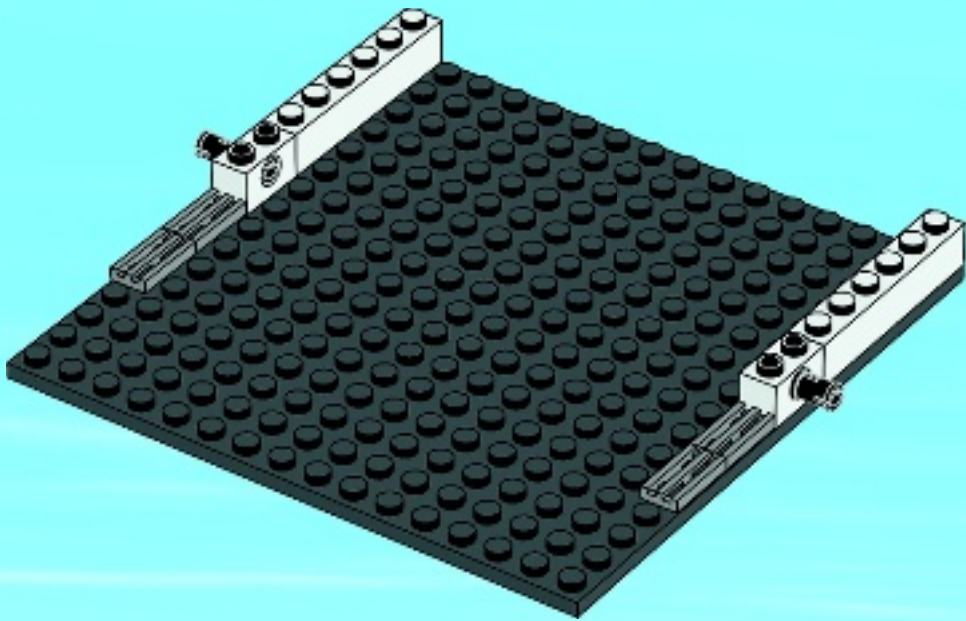



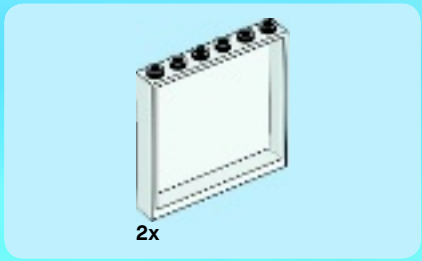

4

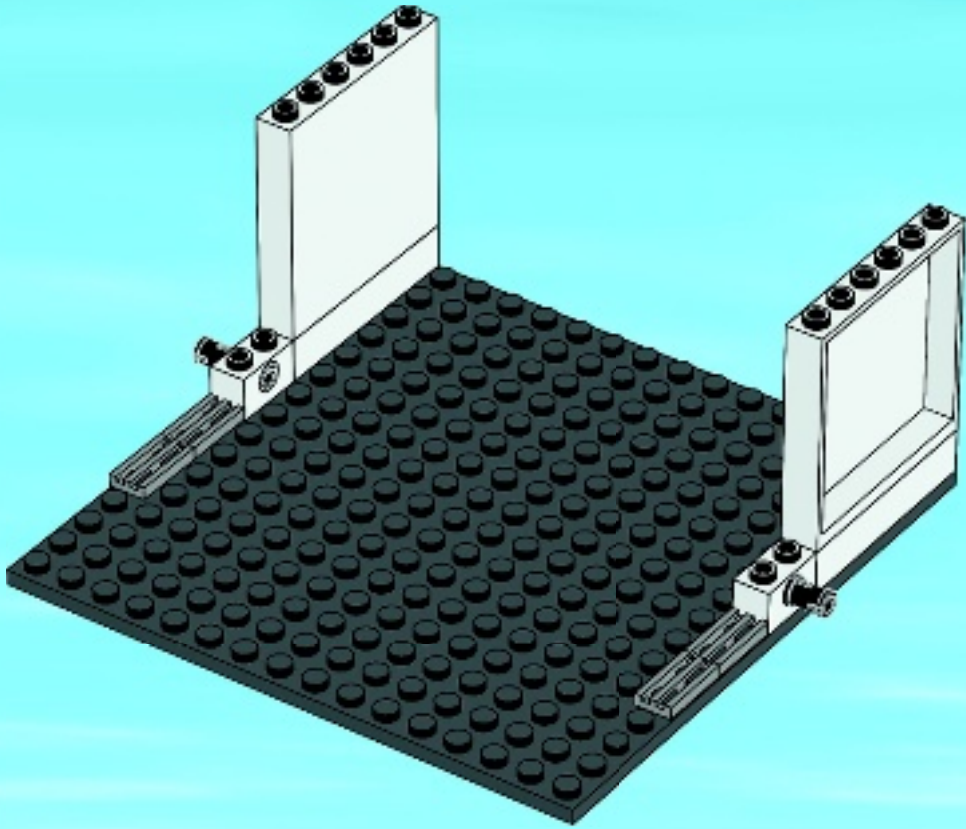

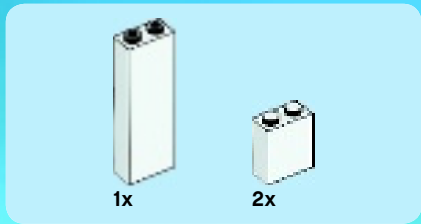

5

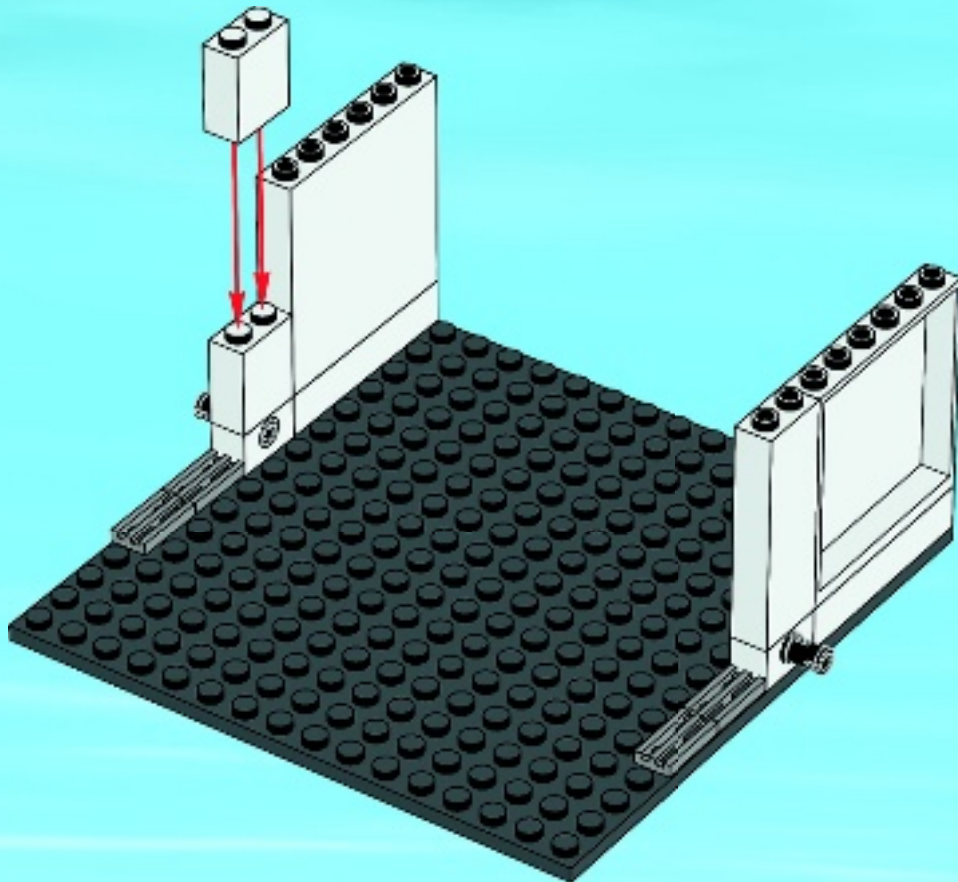

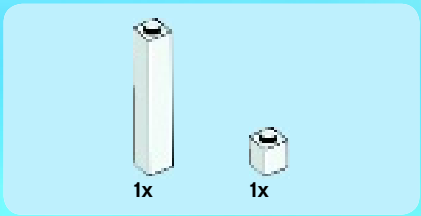

6

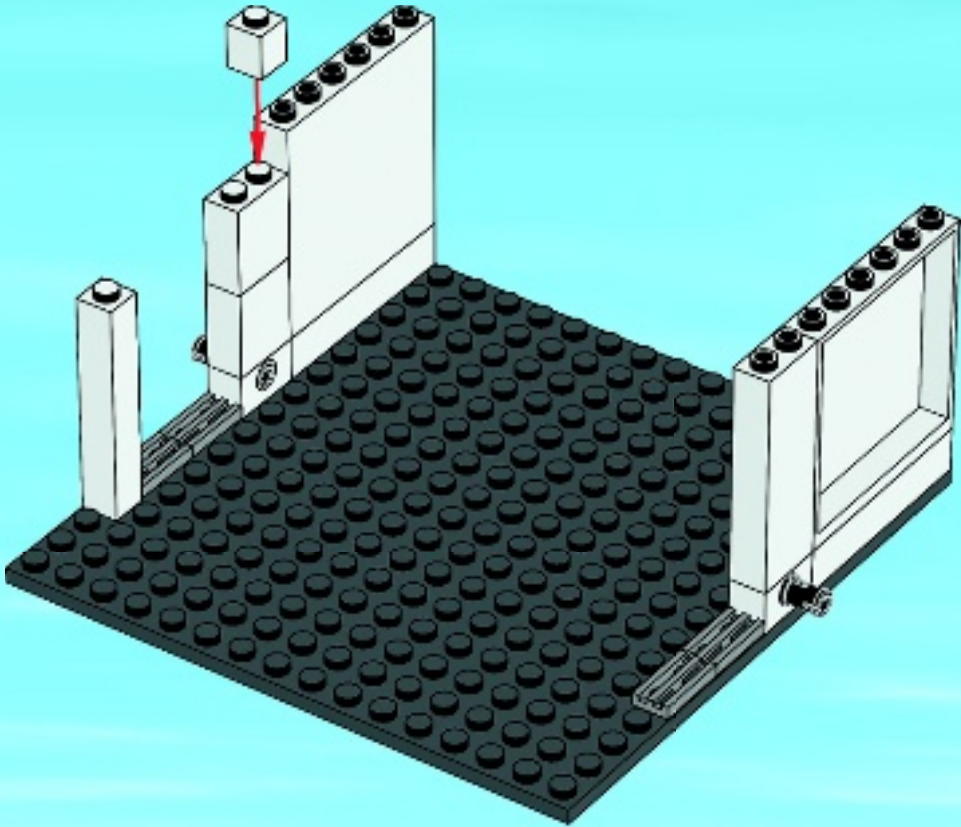



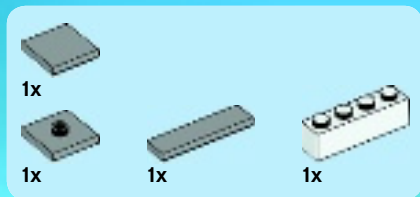

7

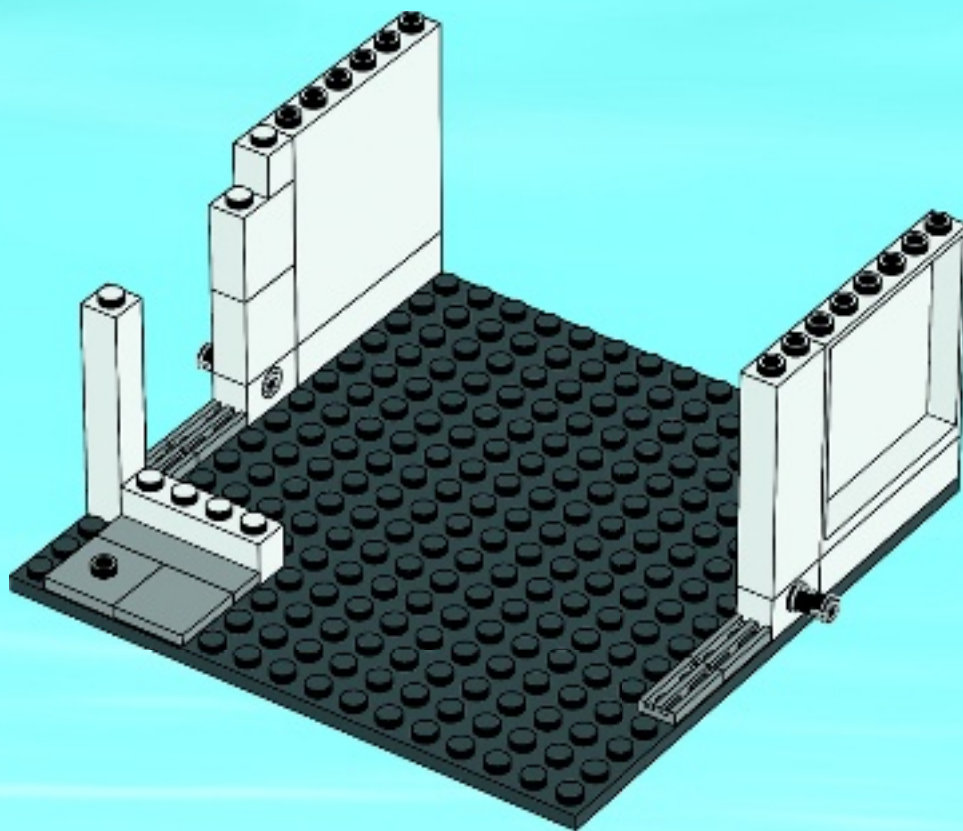





1x



1x

9

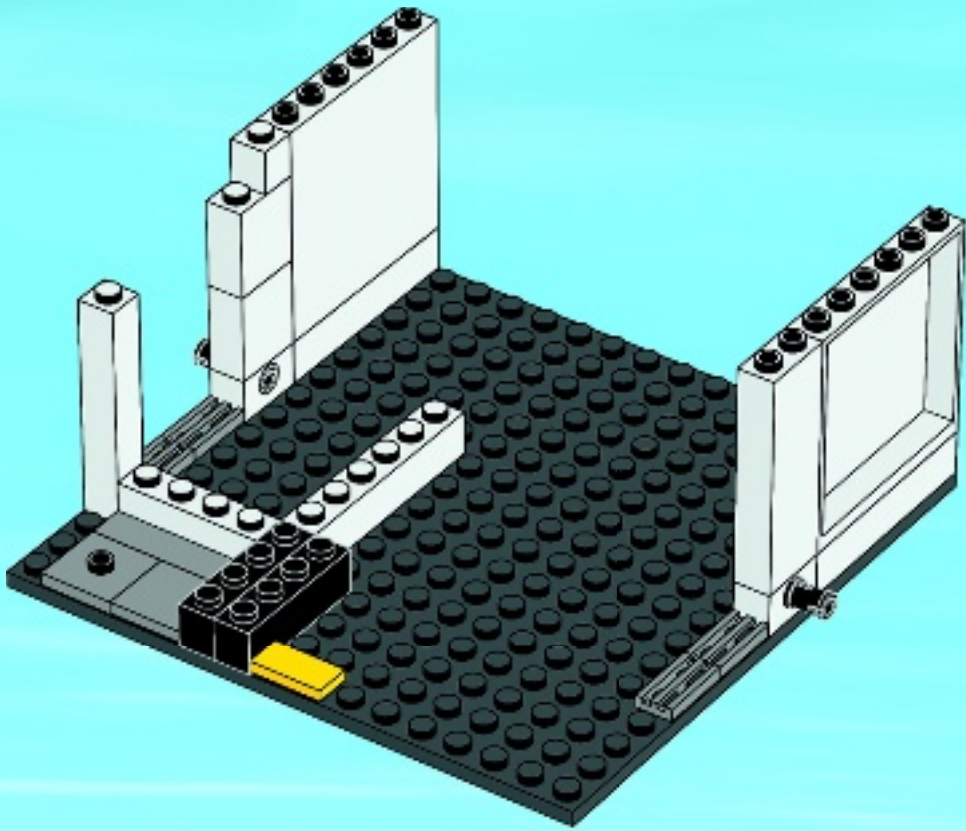









1x



2x



1x



1x



1x

# 12

1



2



3

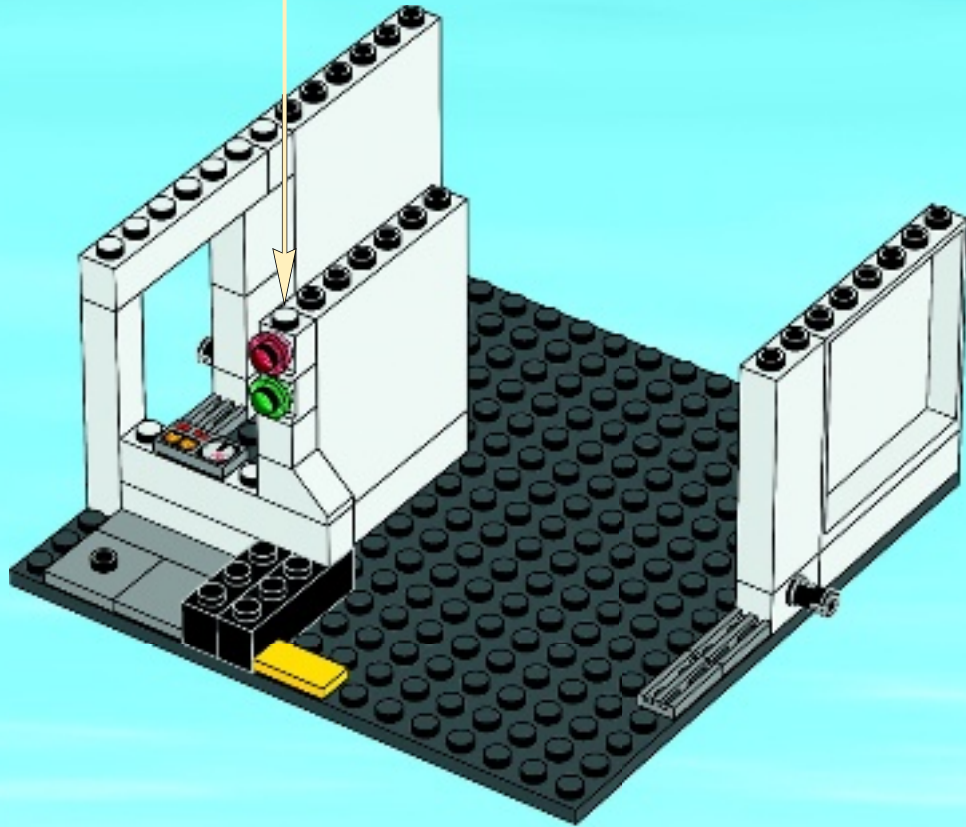
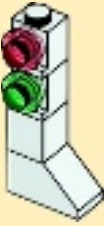



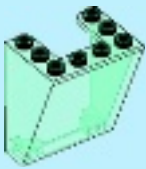

1x

# 13

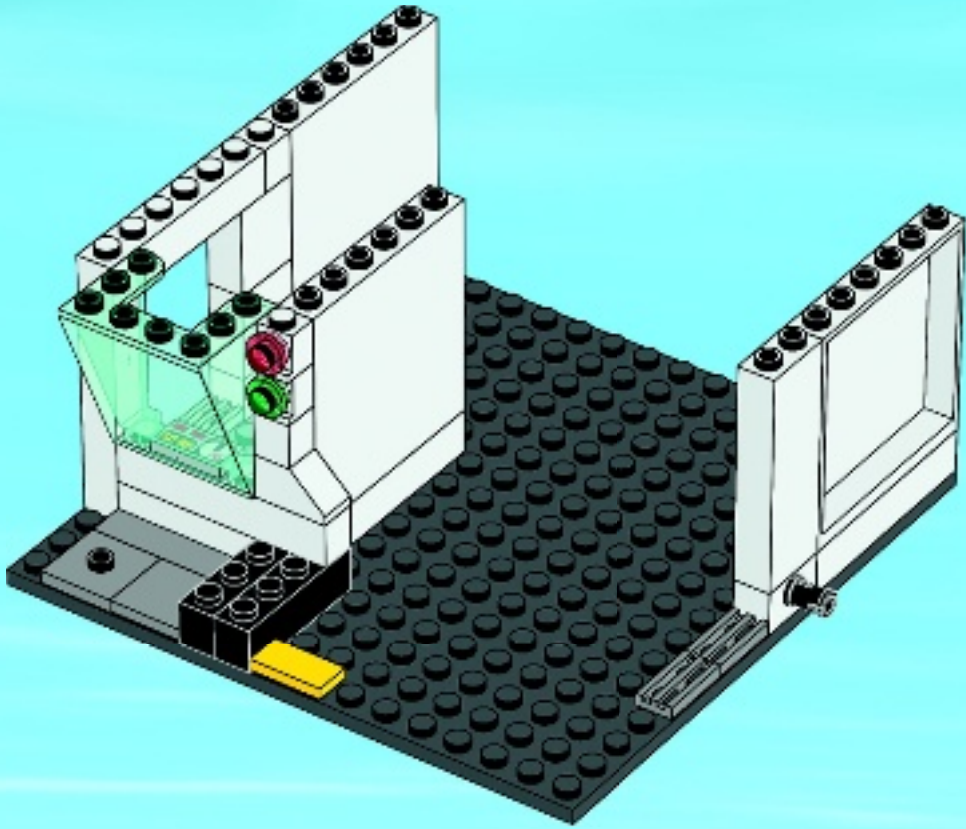

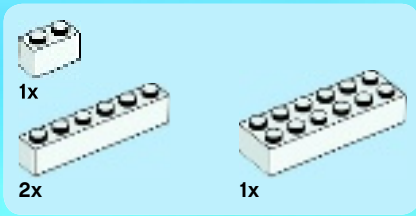

# 14

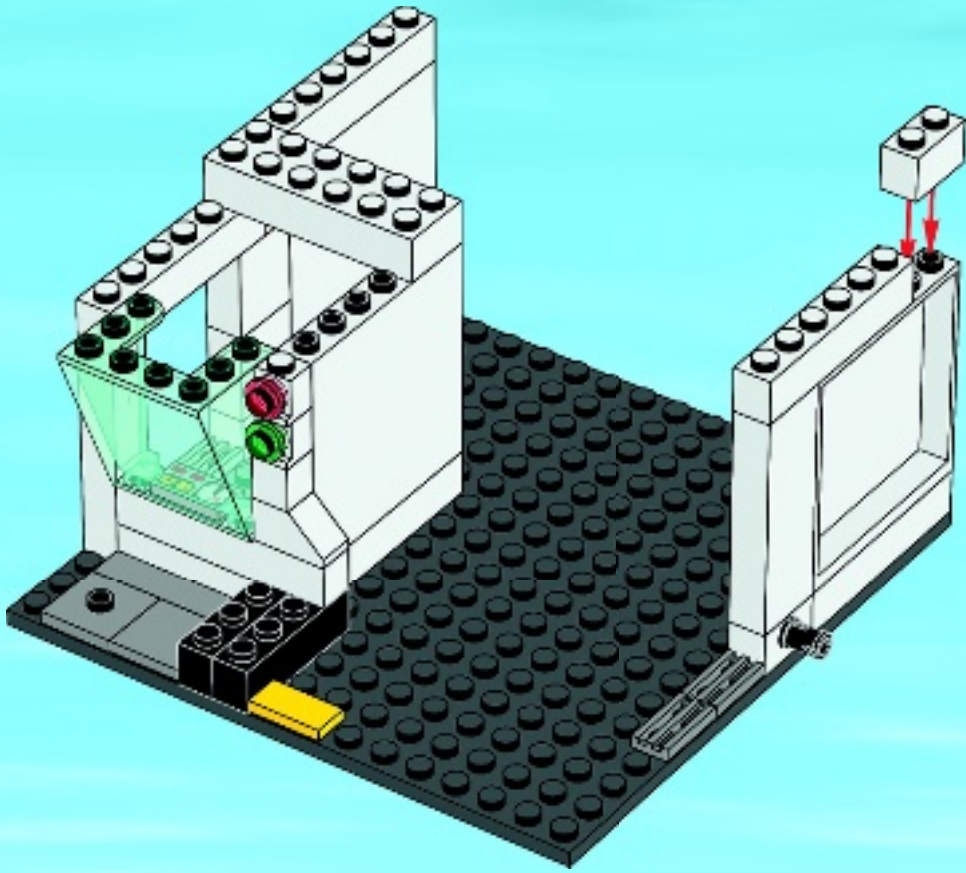



15

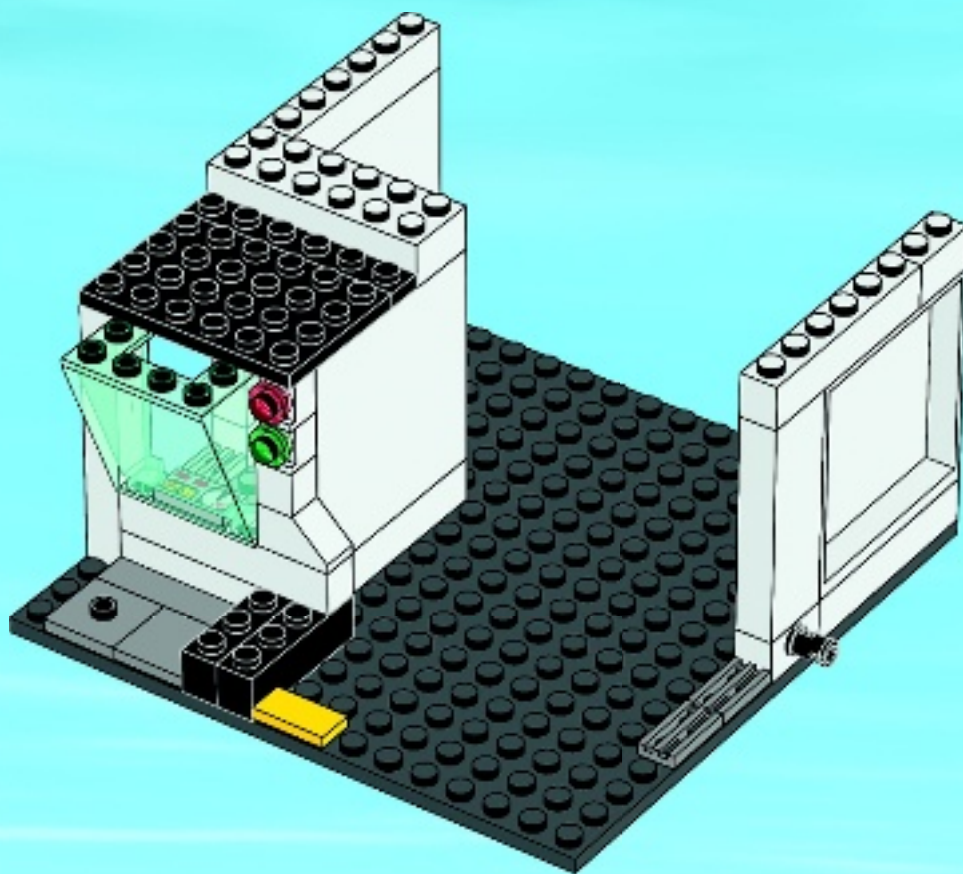





1x



1x

# 16

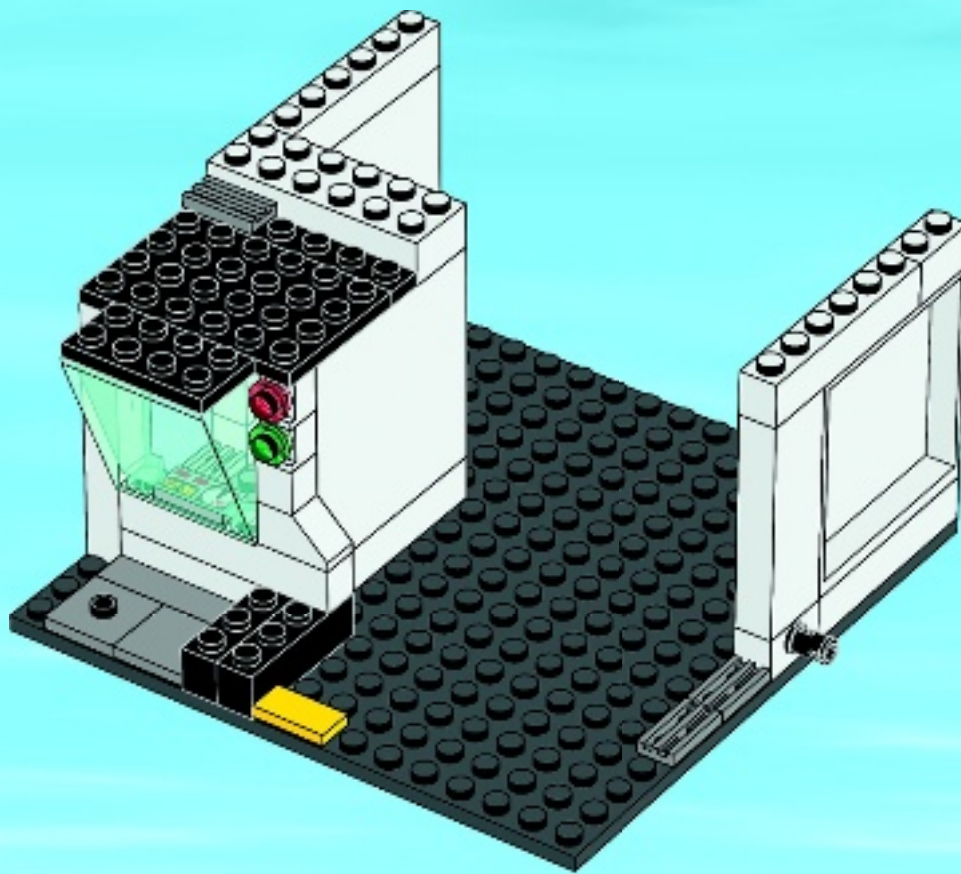



1x



1x

# 17

1



2

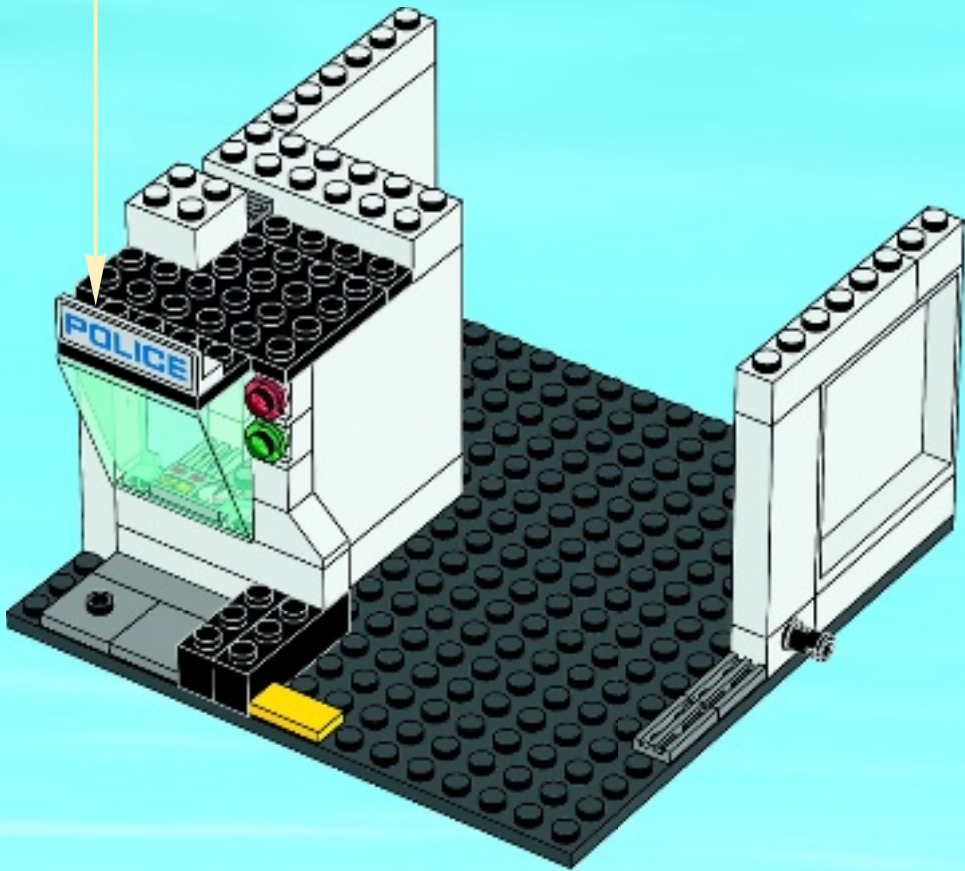

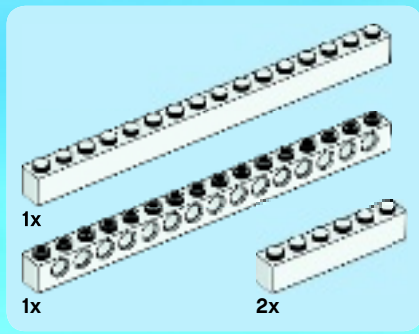

18

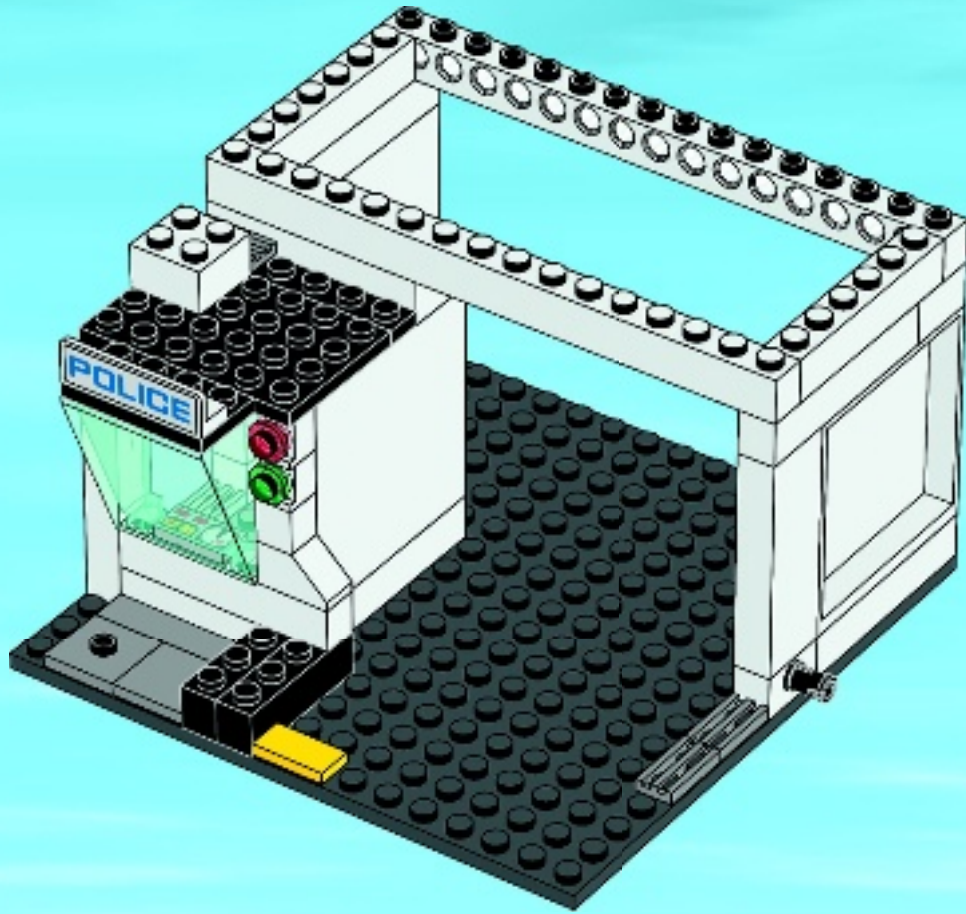

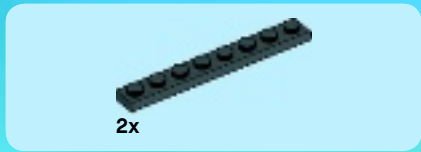

# 19

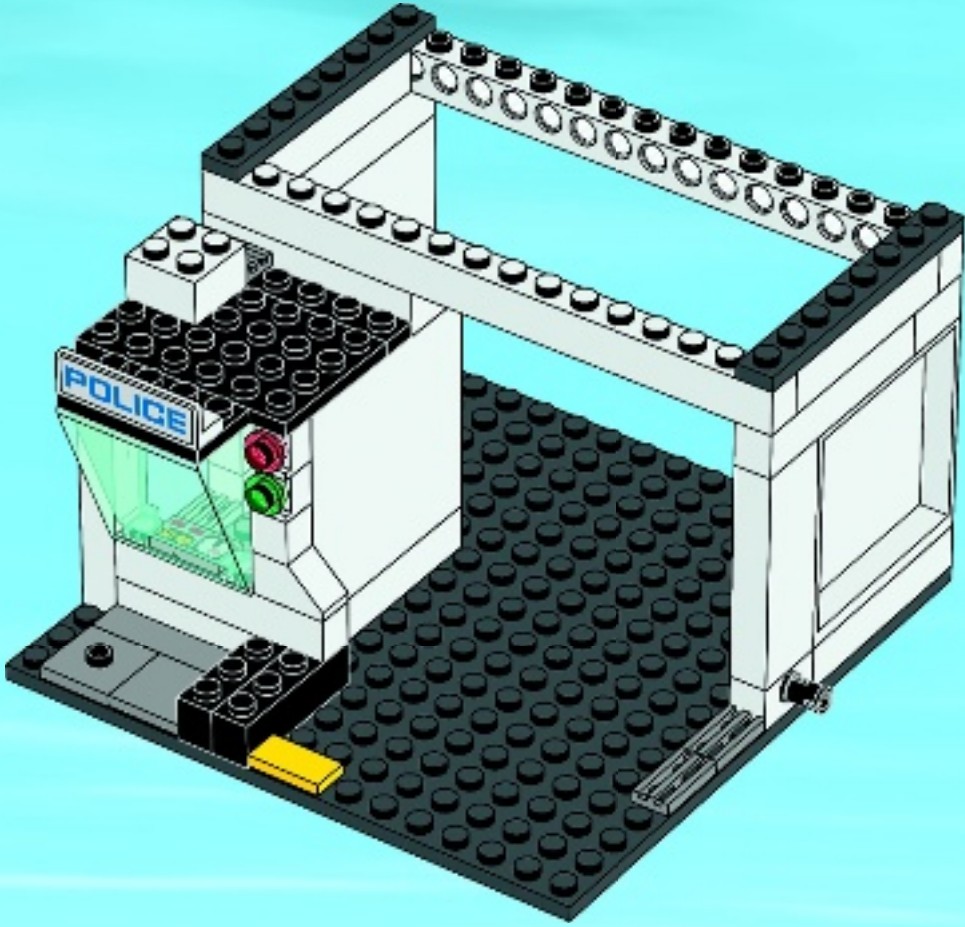



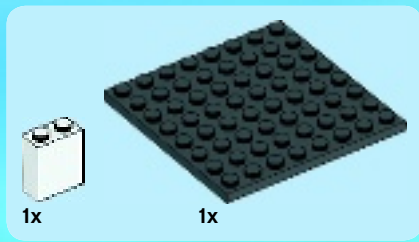

20

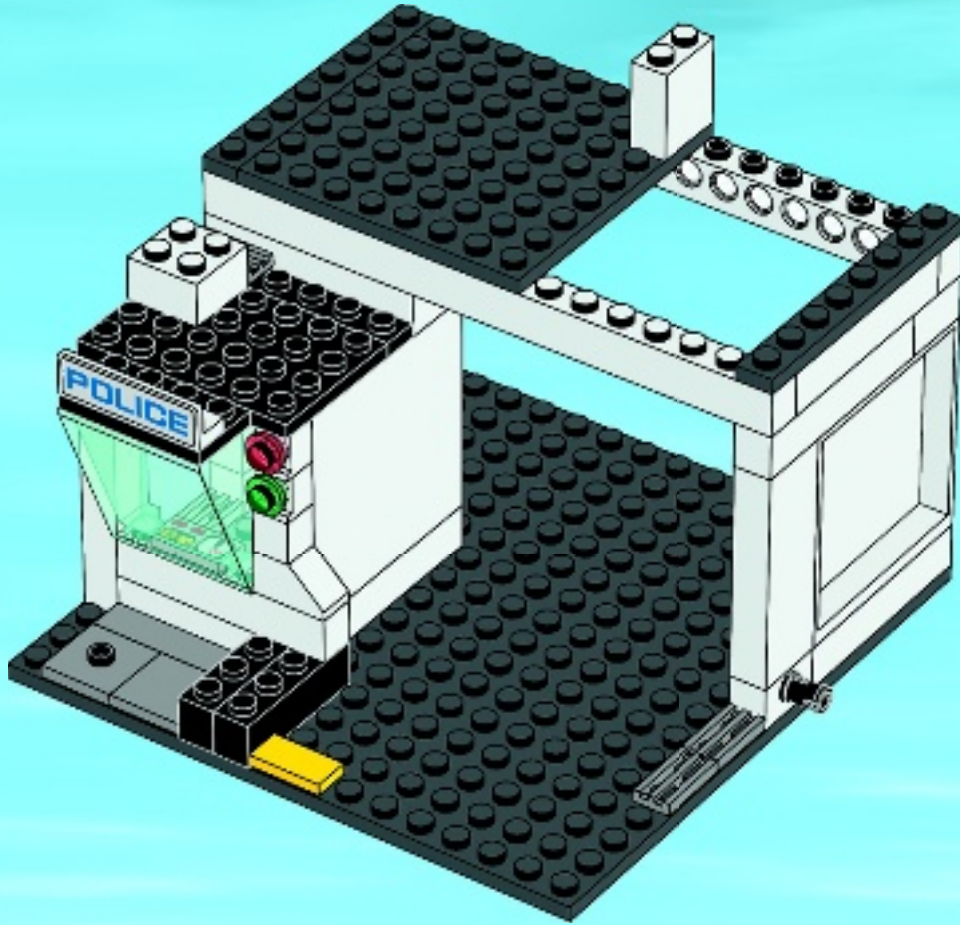

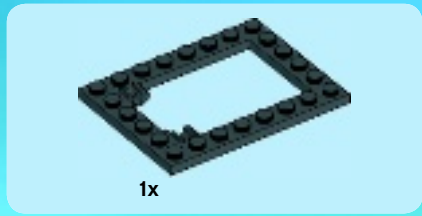

21

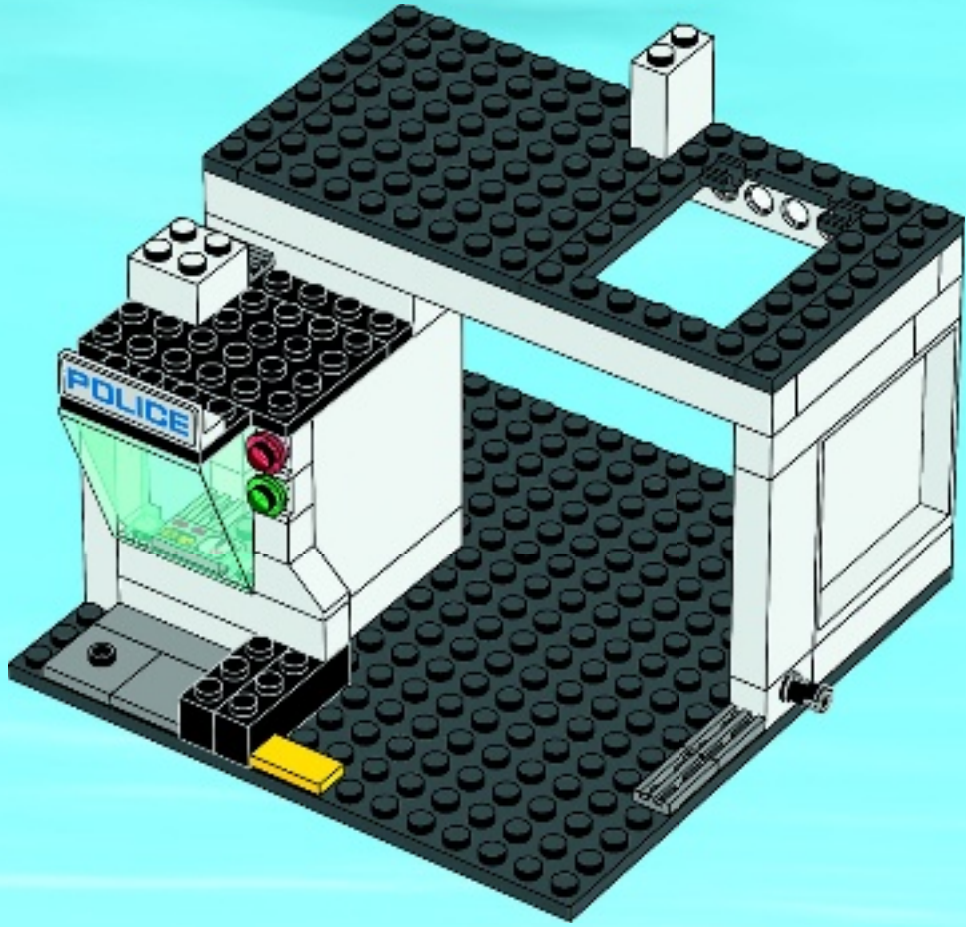



1x



1x

# 22

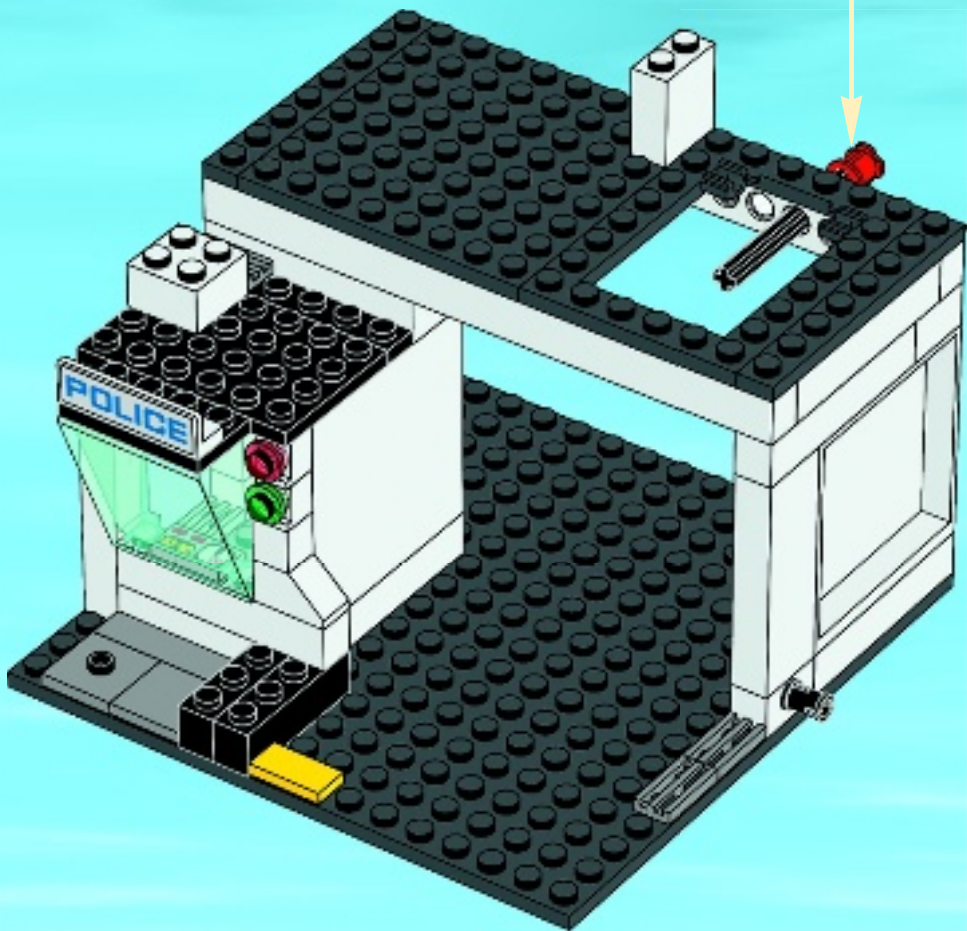
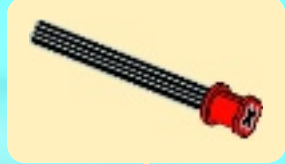

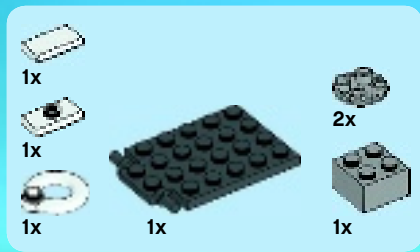

# 23

1



2

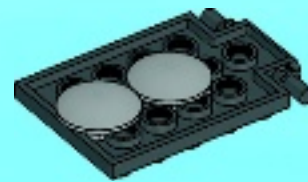





**3**

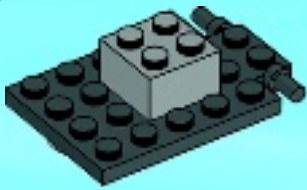

**4**

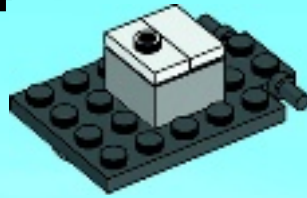

**5**



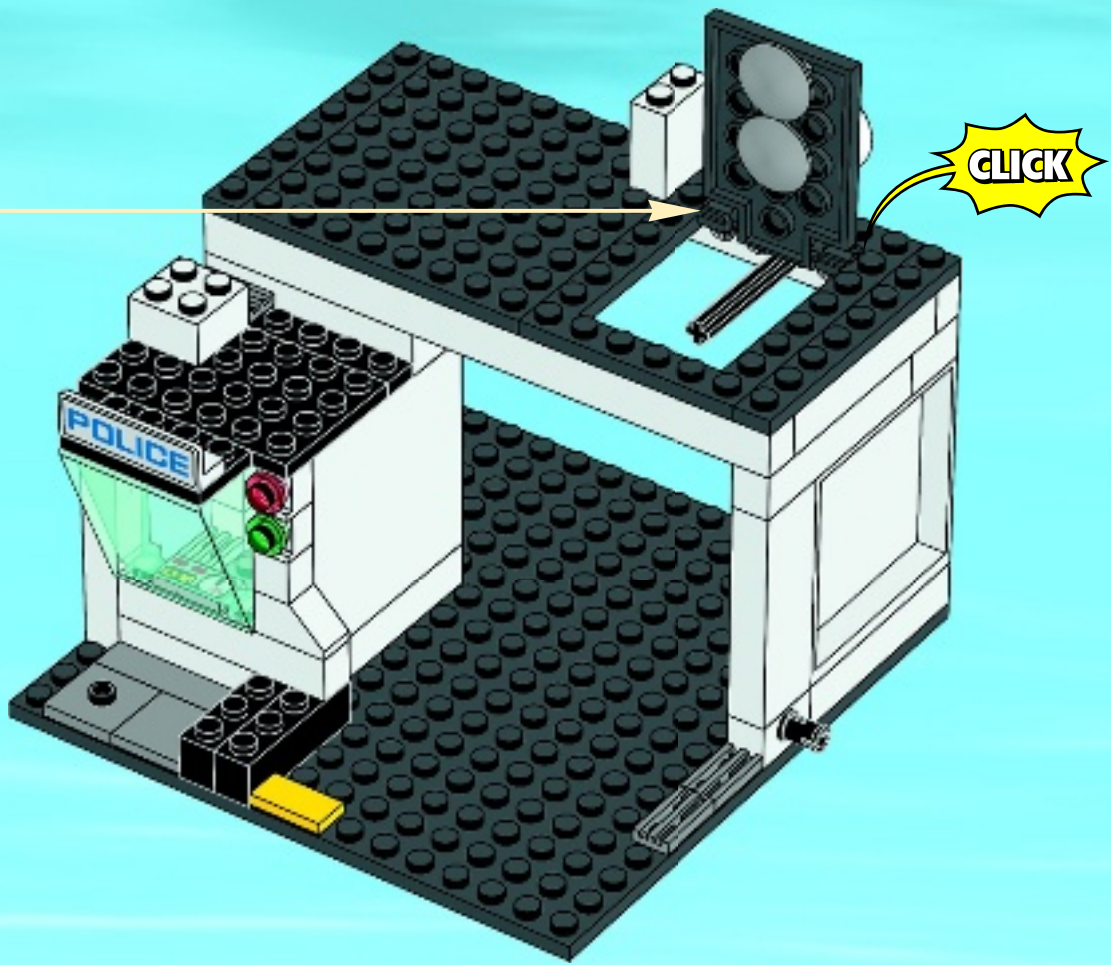

24

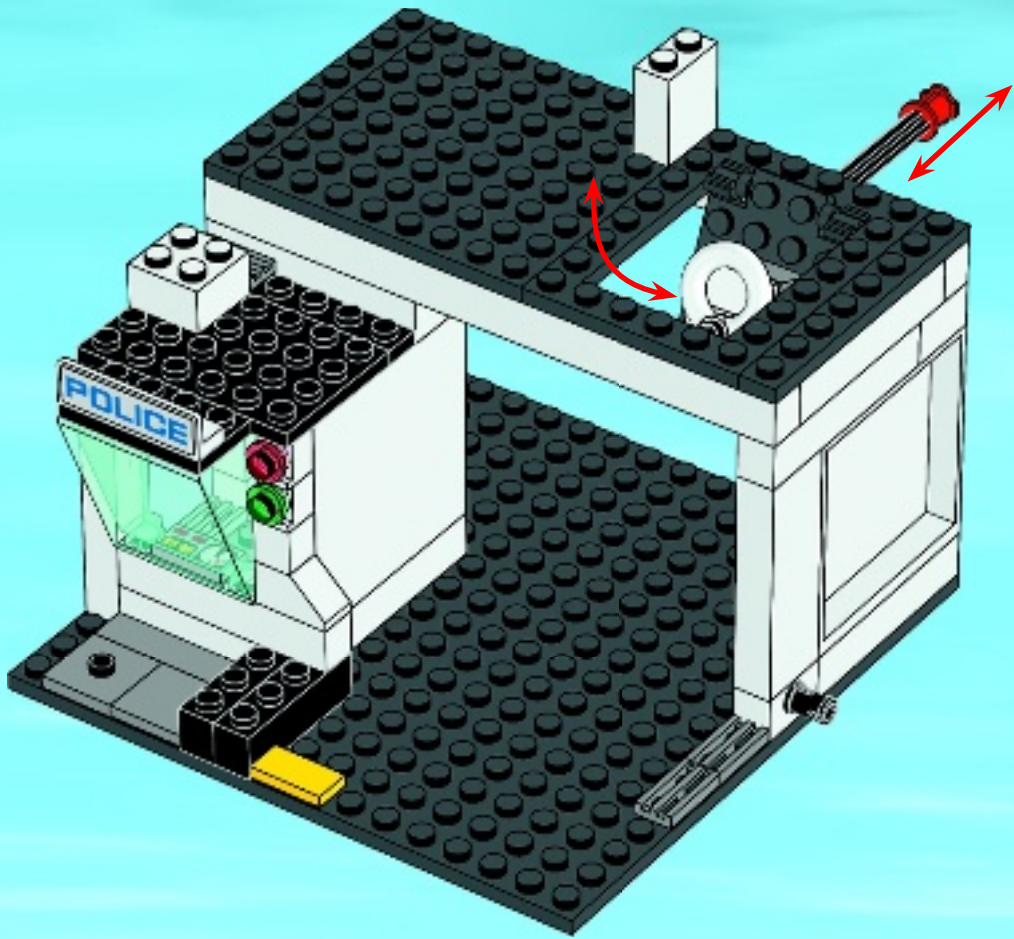

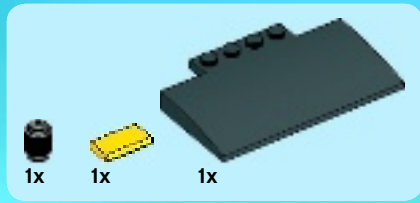

# 25

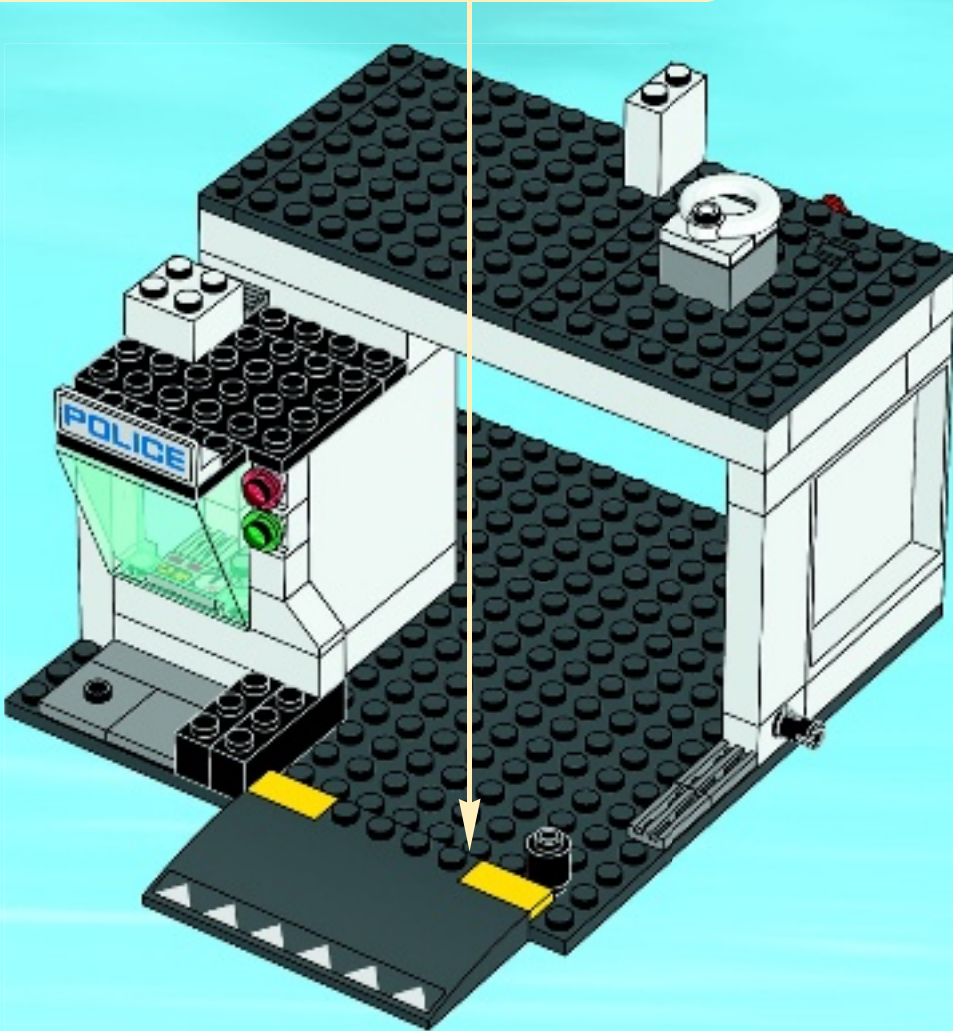
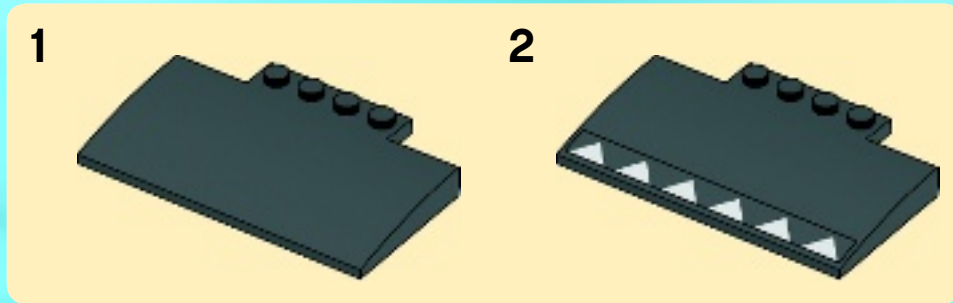





# 26

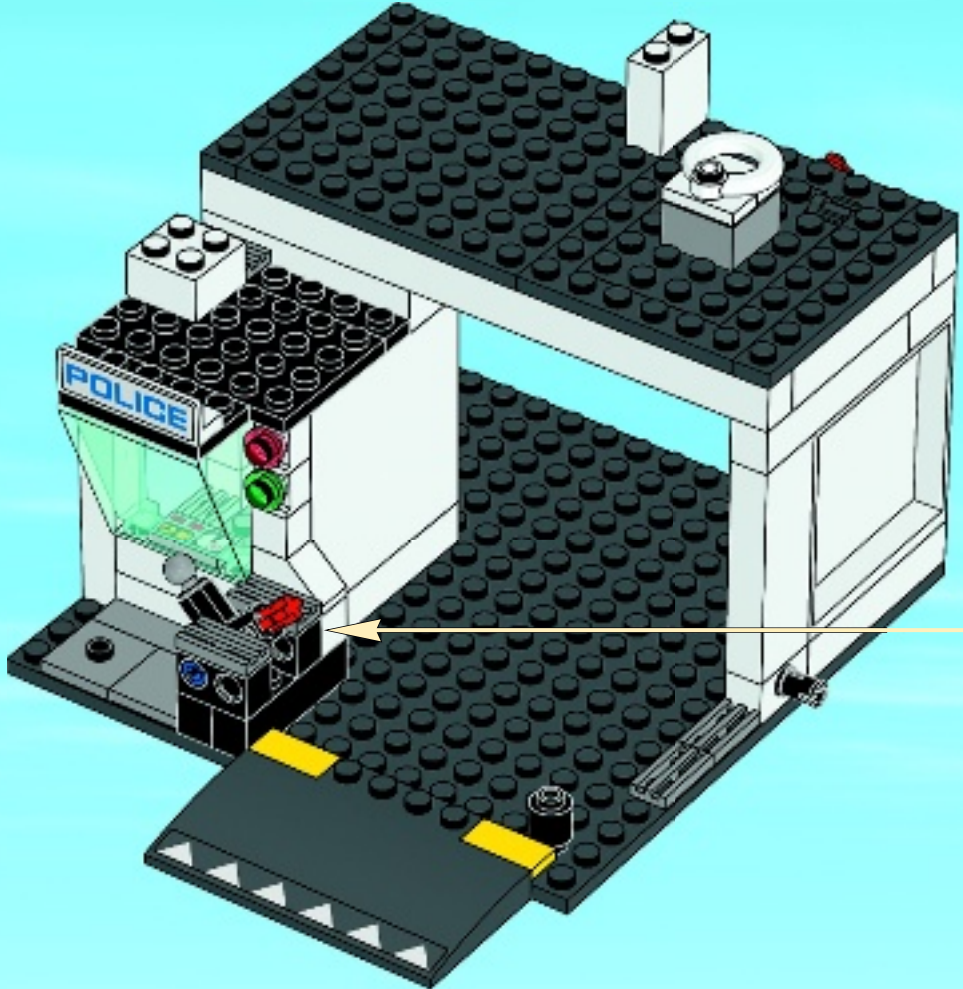
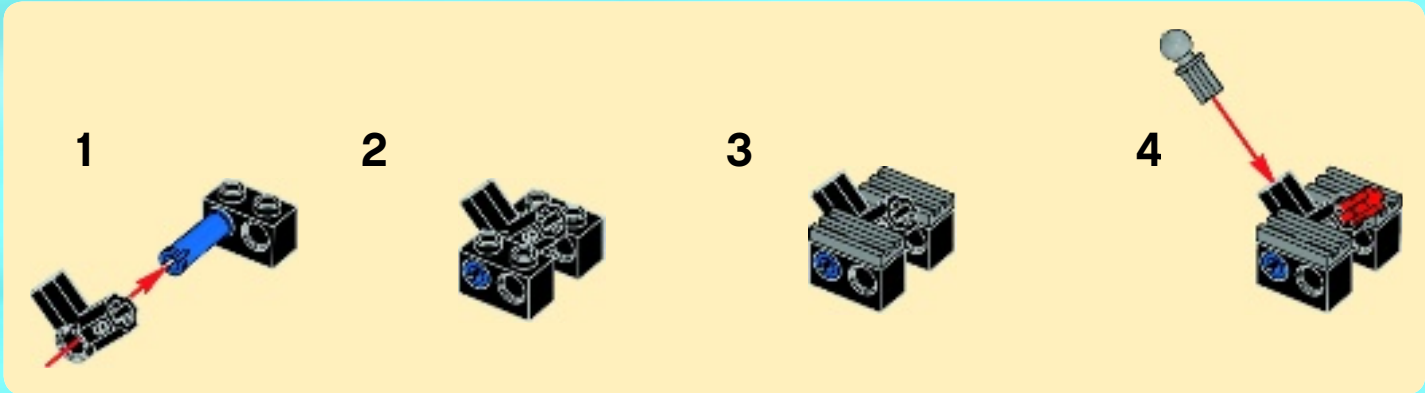



3x



2x



2x

# 27

1

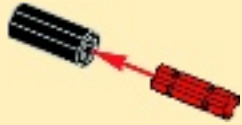

2

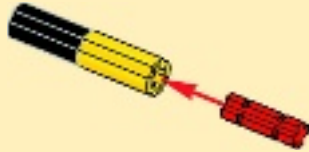

3

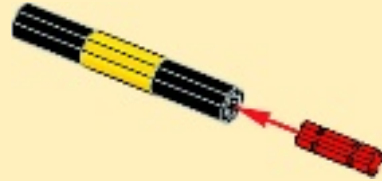

4

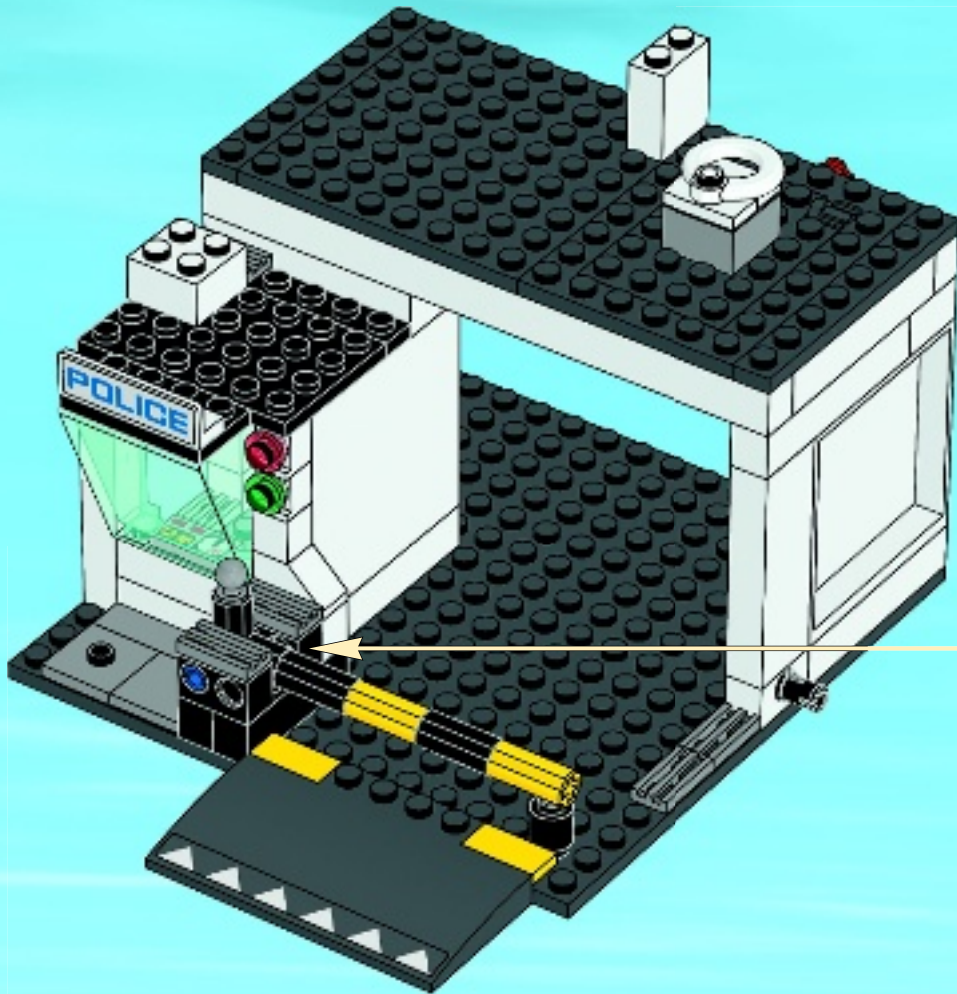
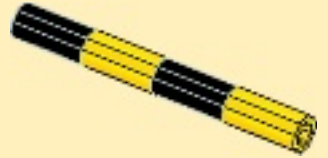

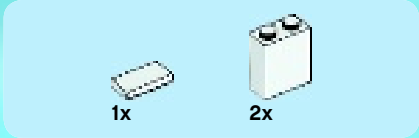
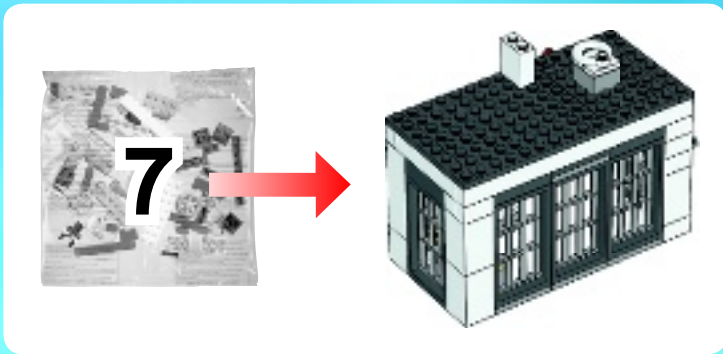

28

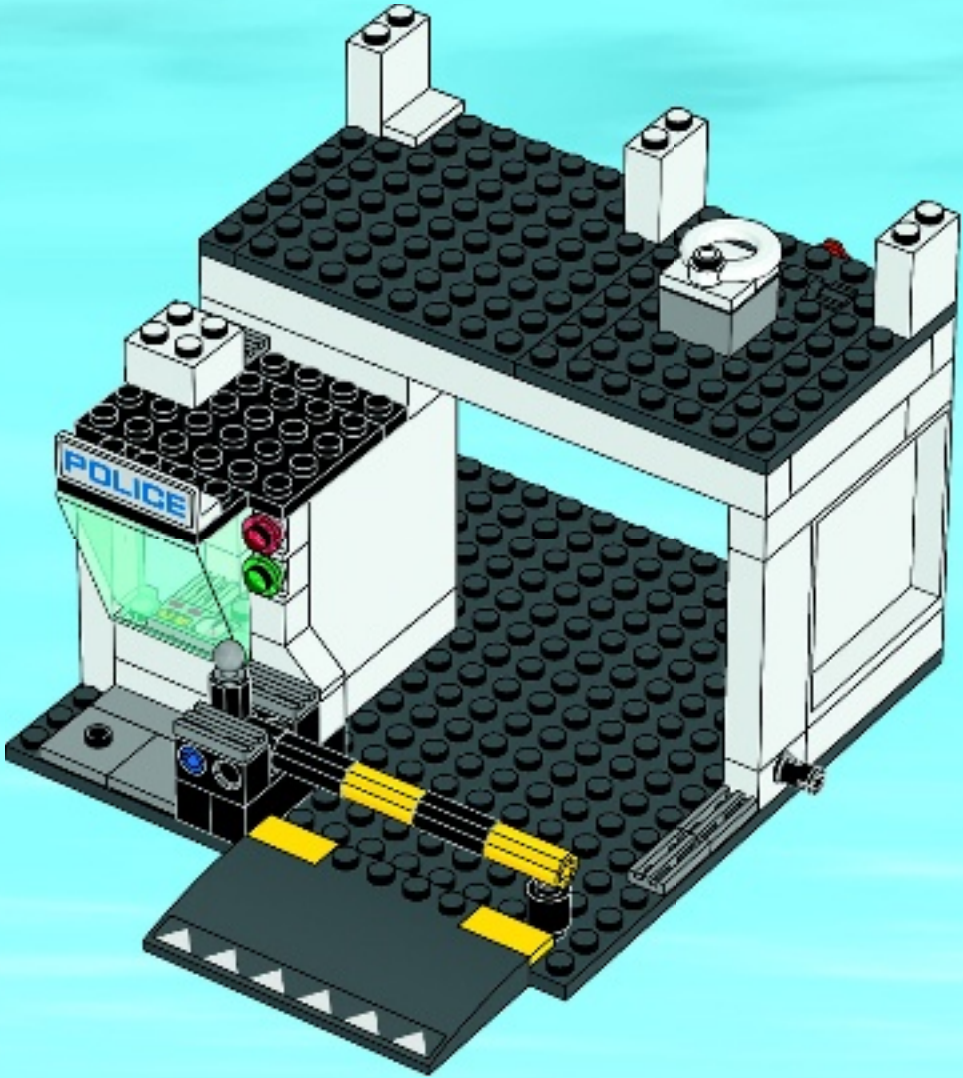





1x



1x



2x



1x

# 29

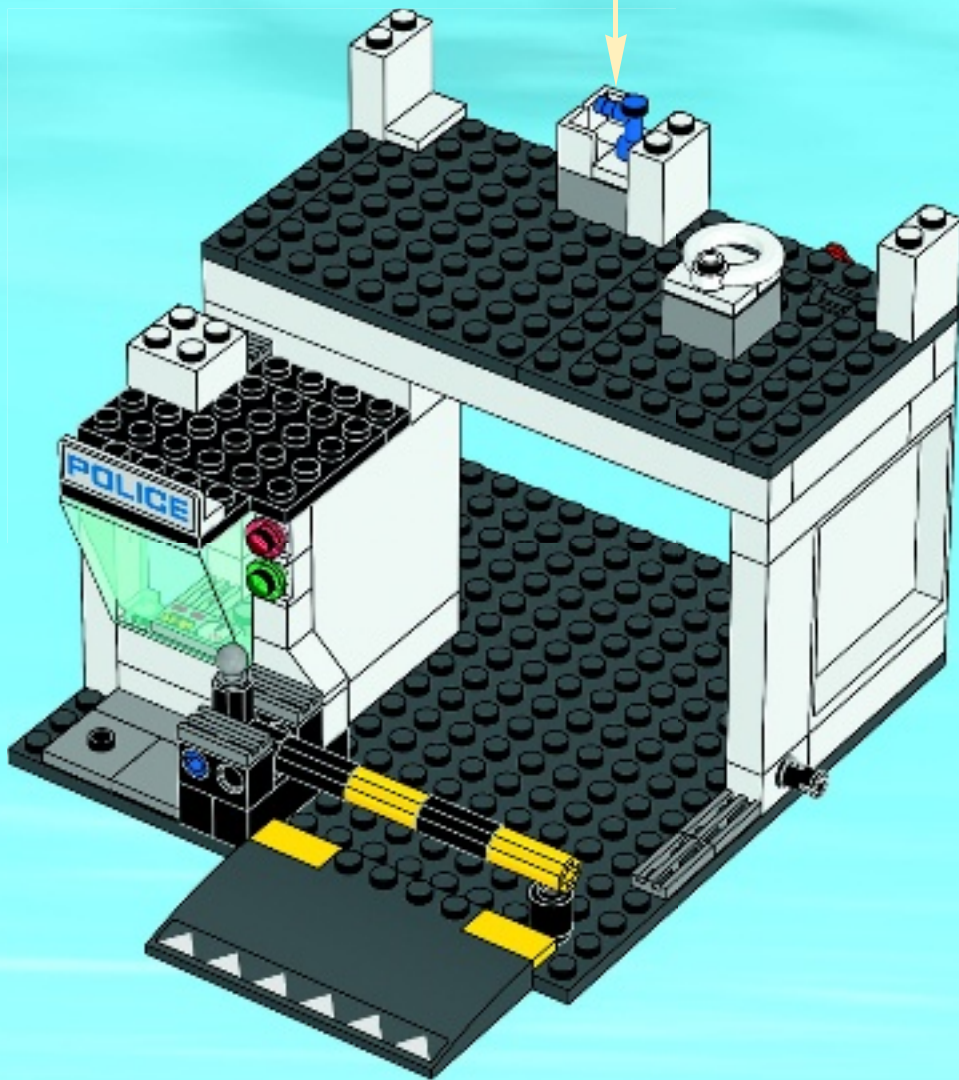
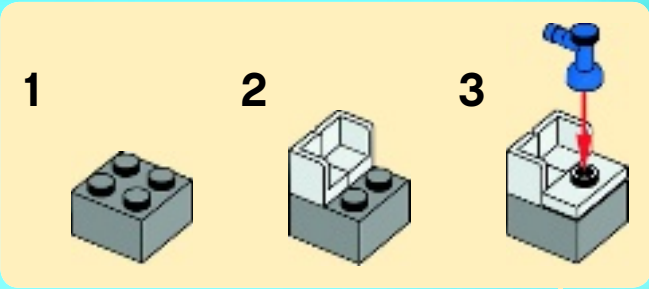





1x

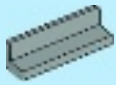

2x



2x

# 30

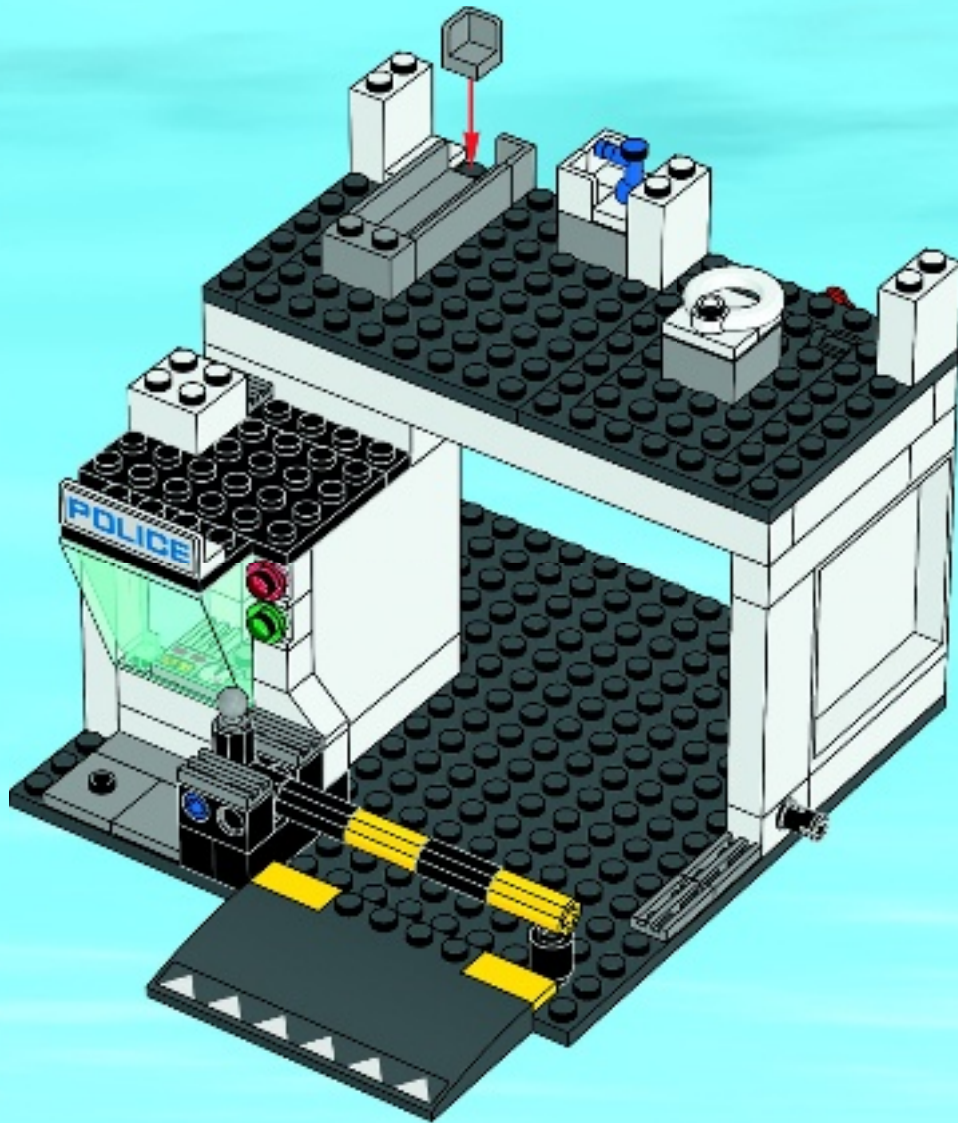

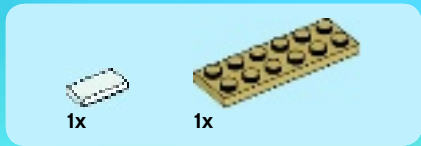

# 31

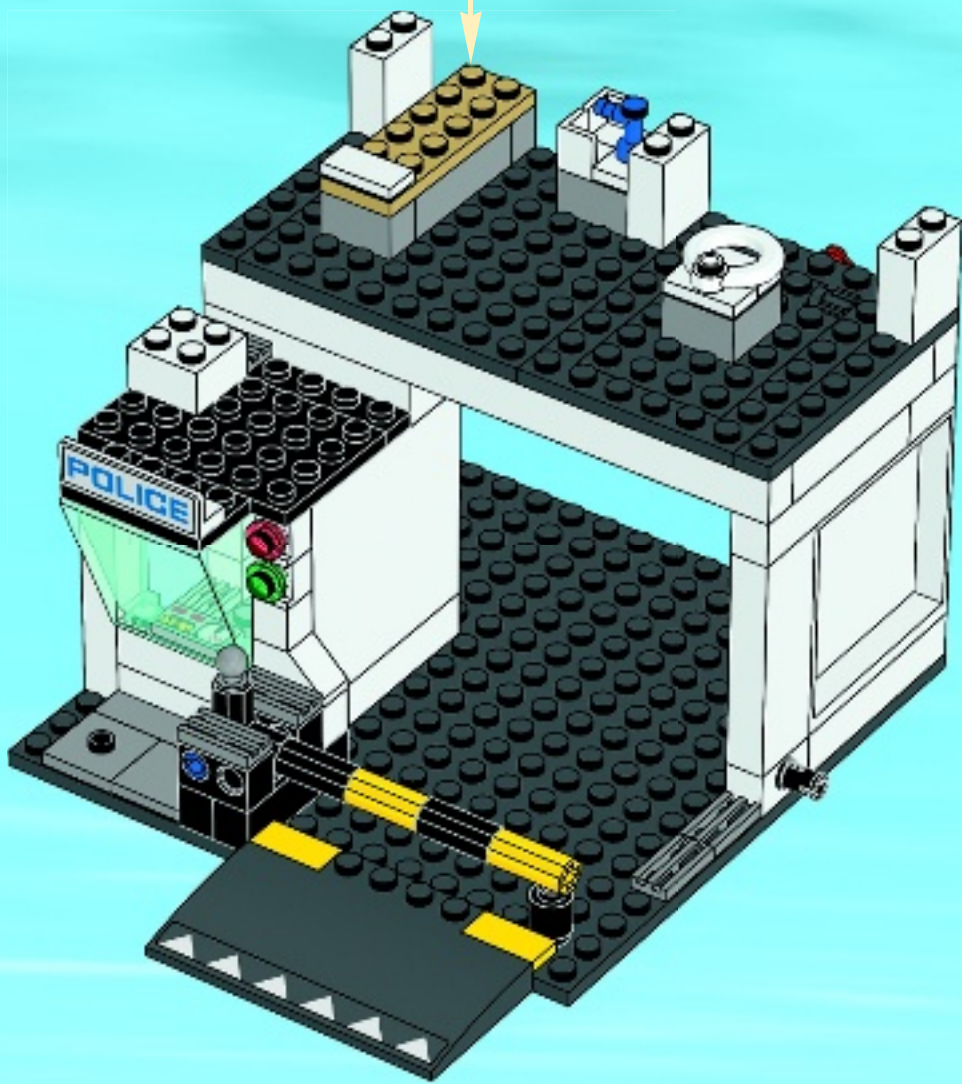
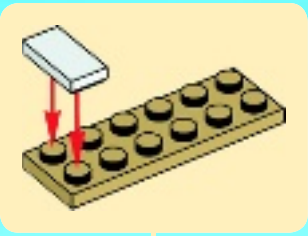

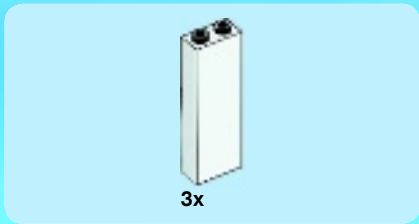

# 32

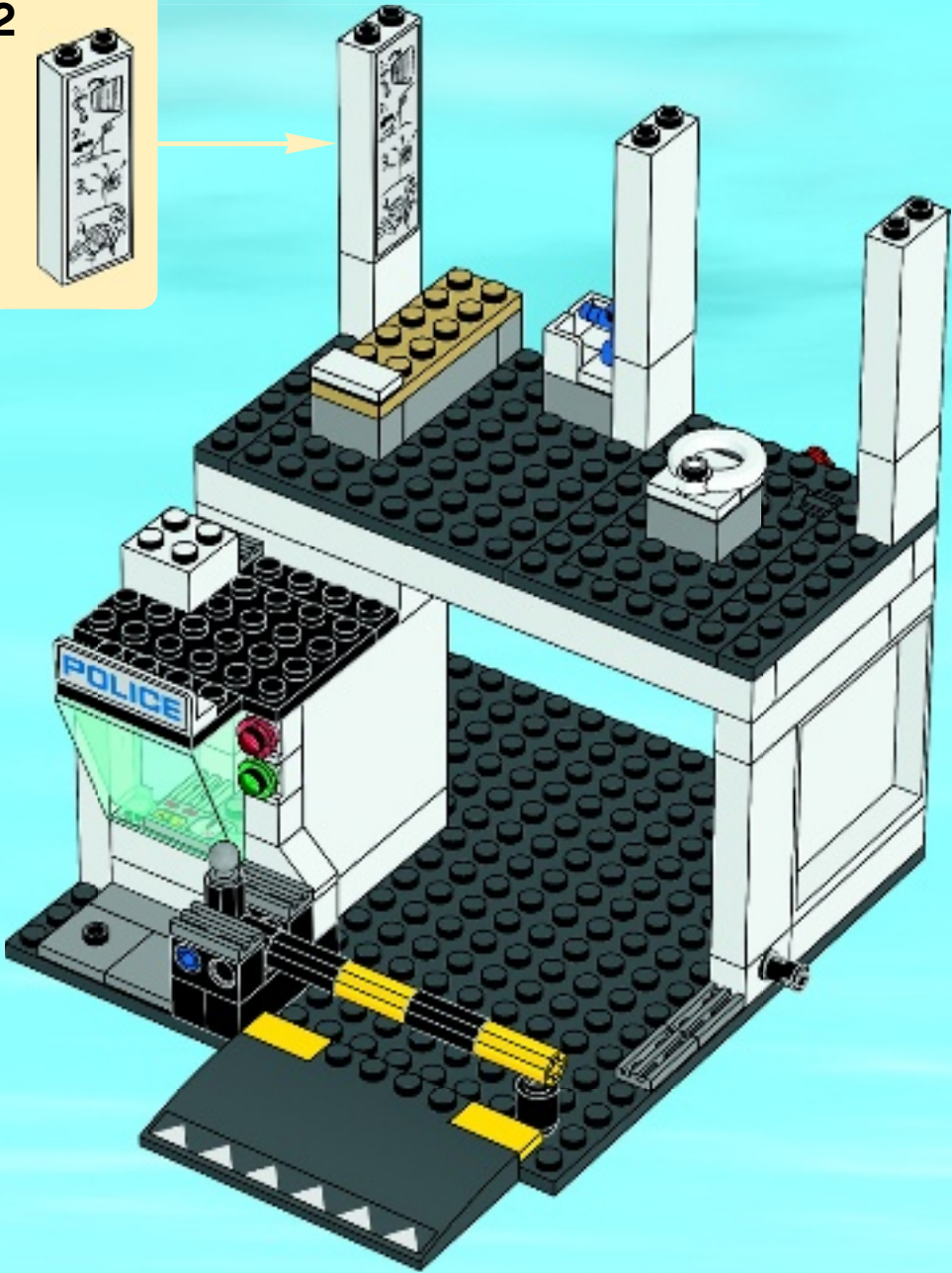
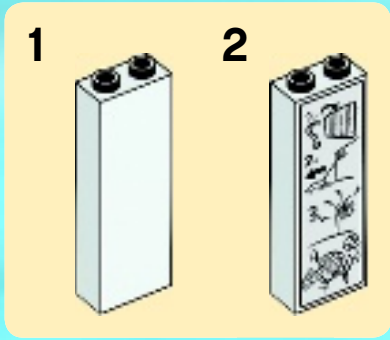







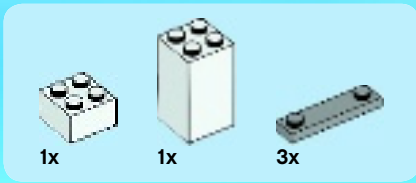

# 34

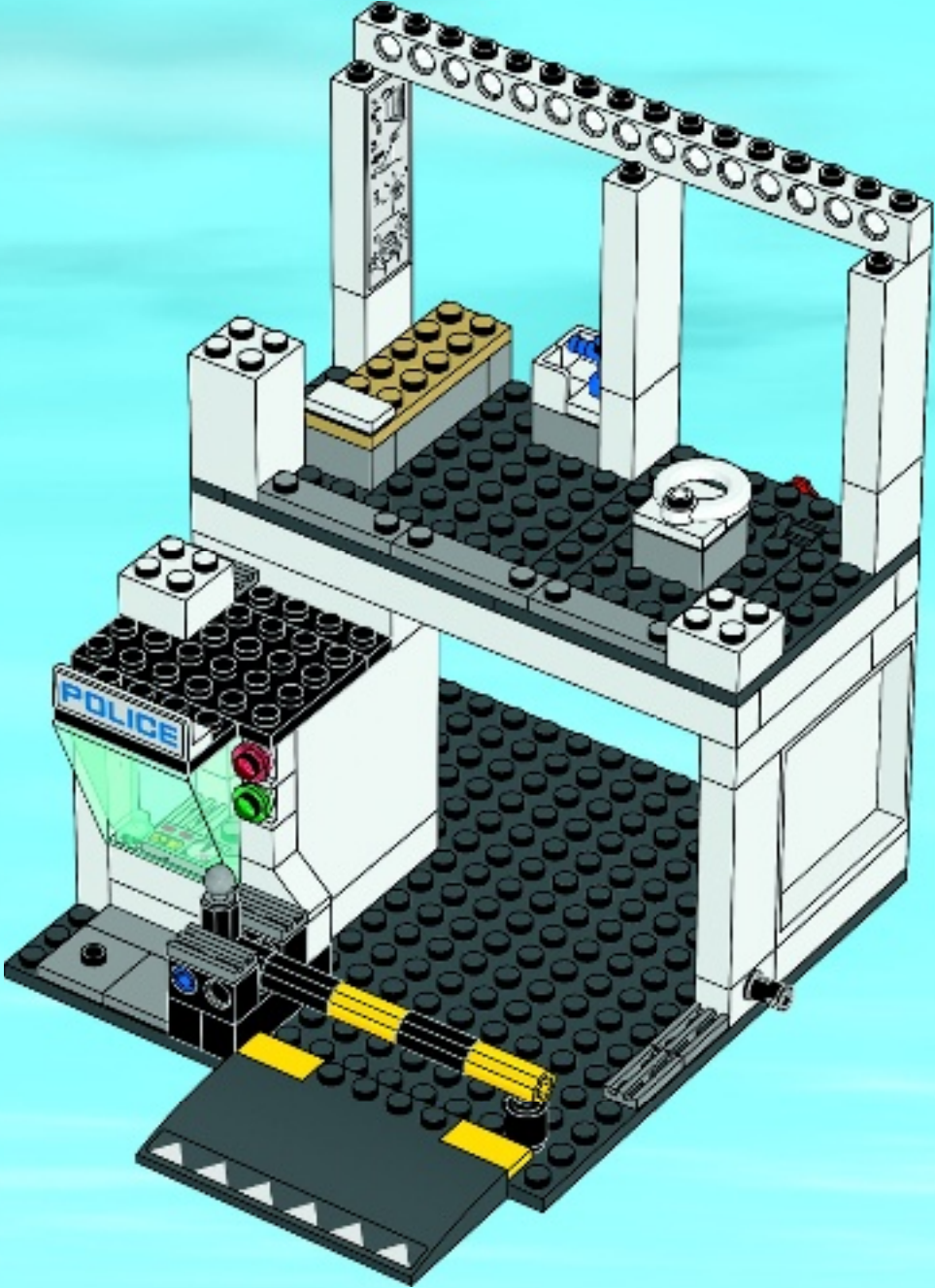

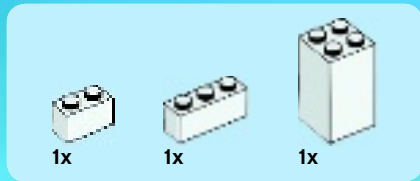

35

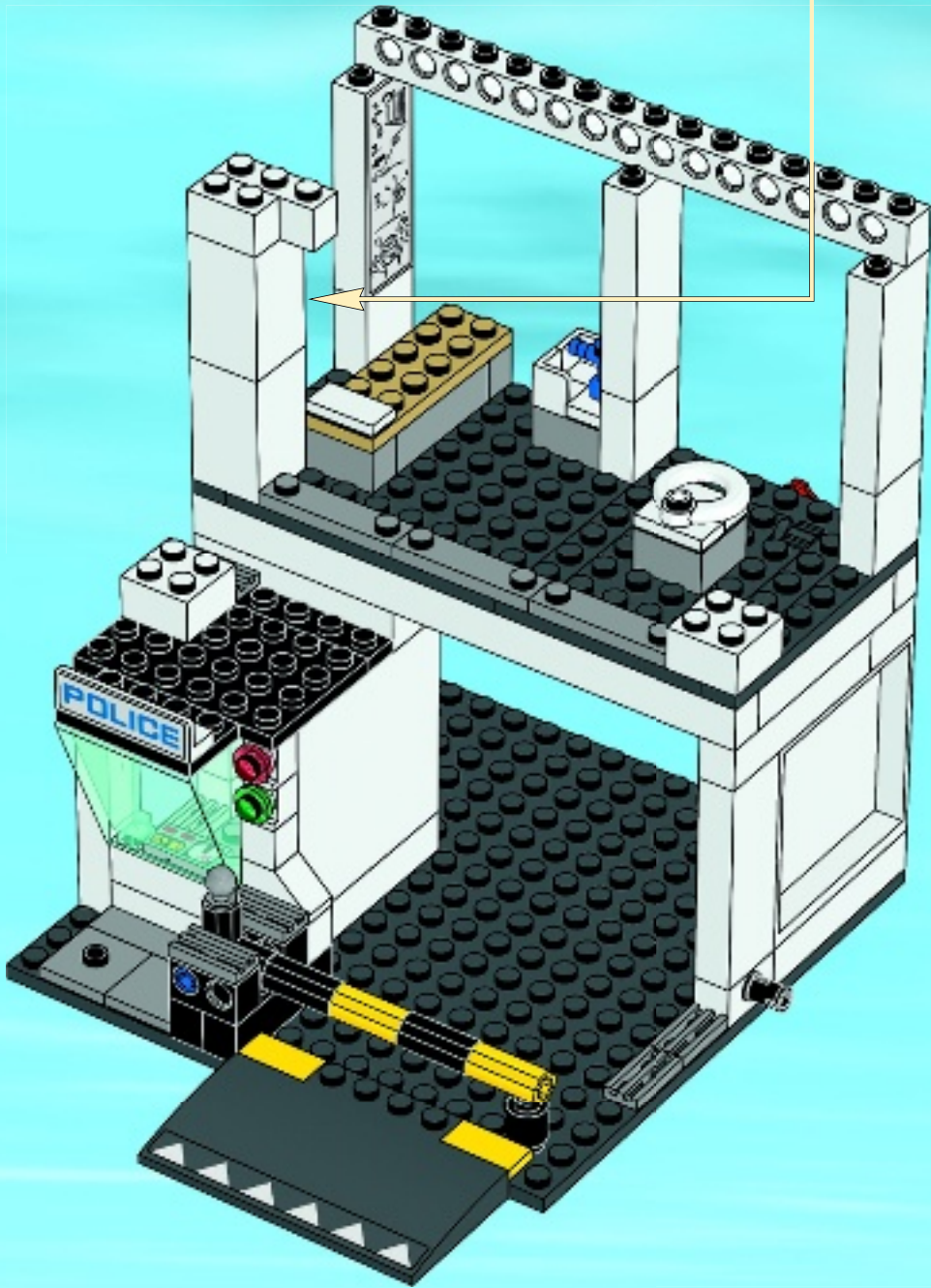
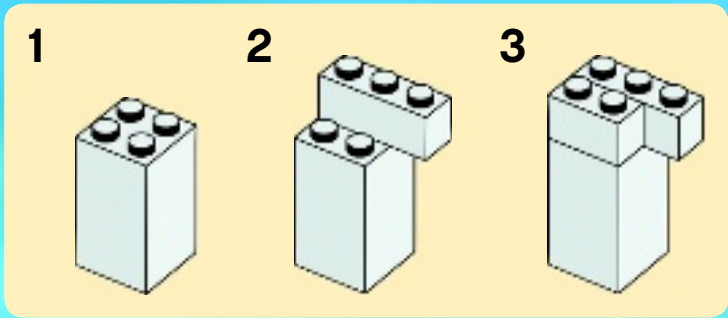

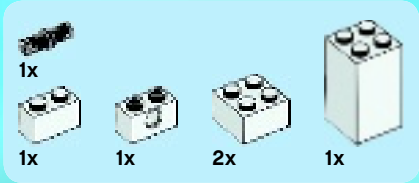

# 36

1



2

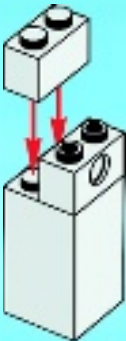

3



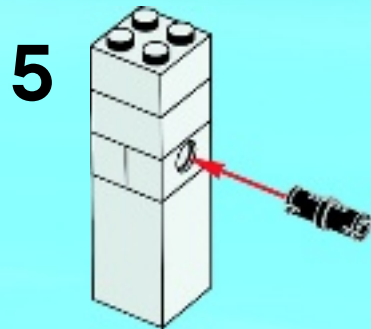
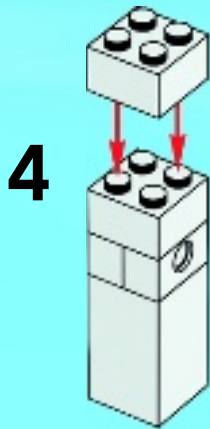



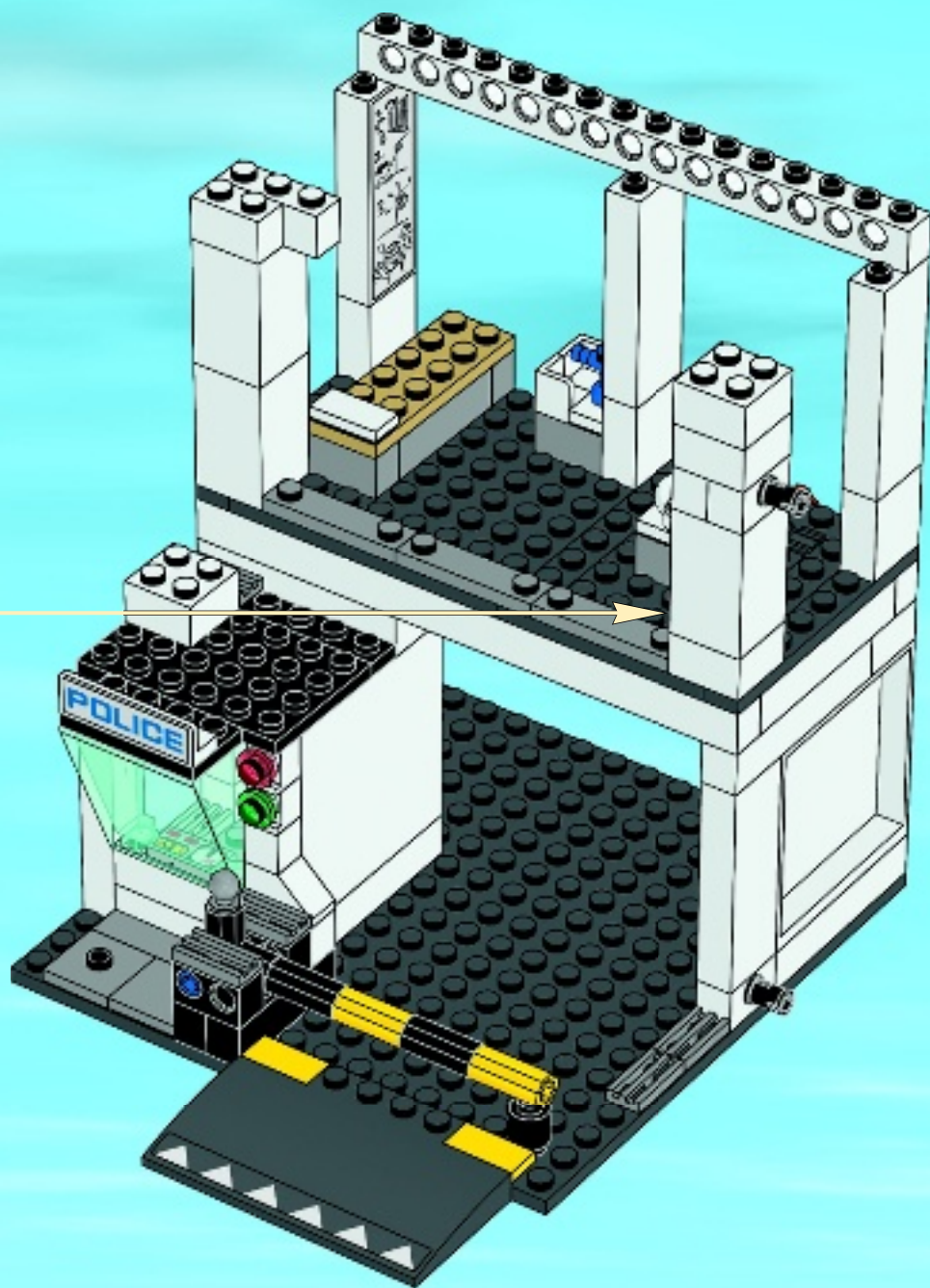

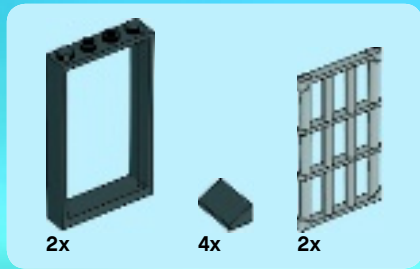

37

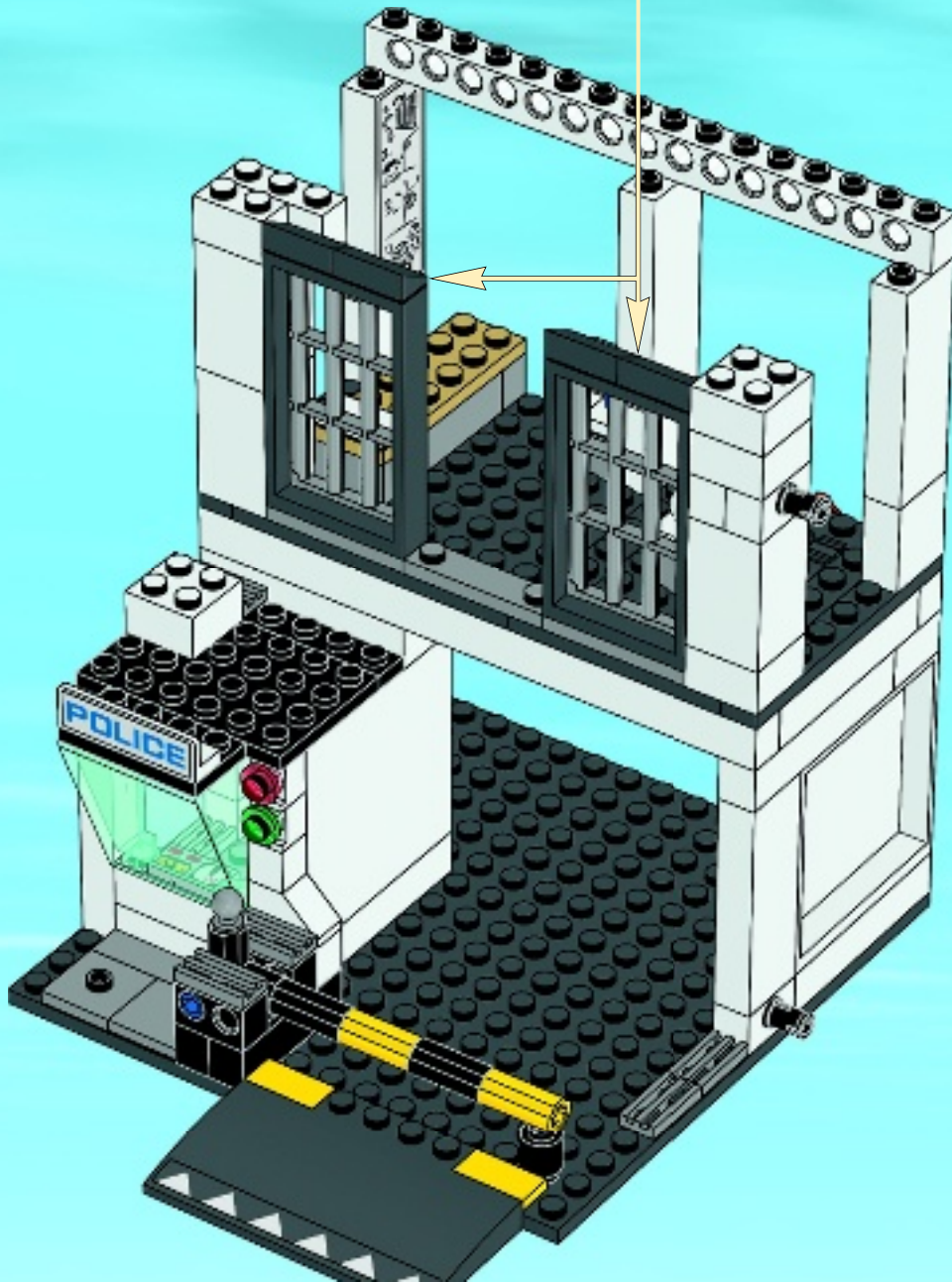
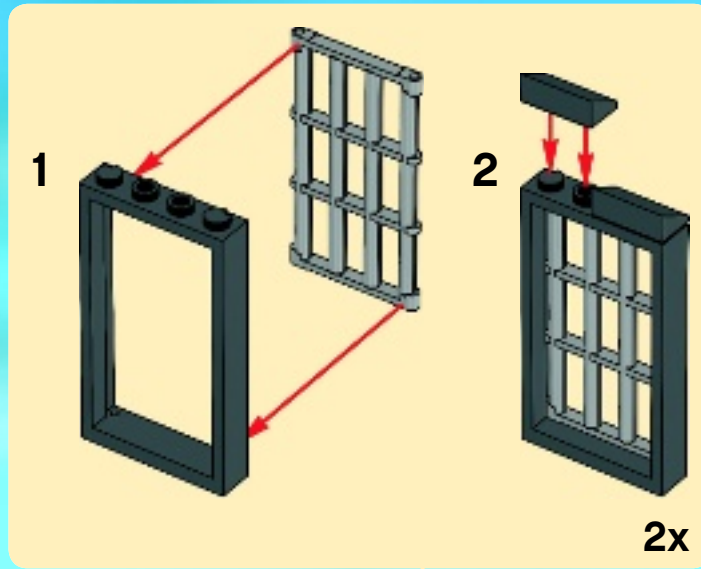



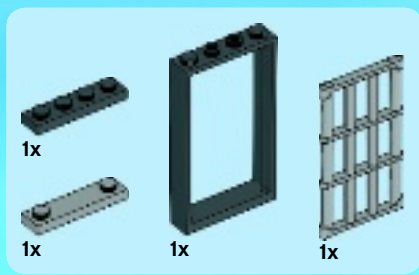

38

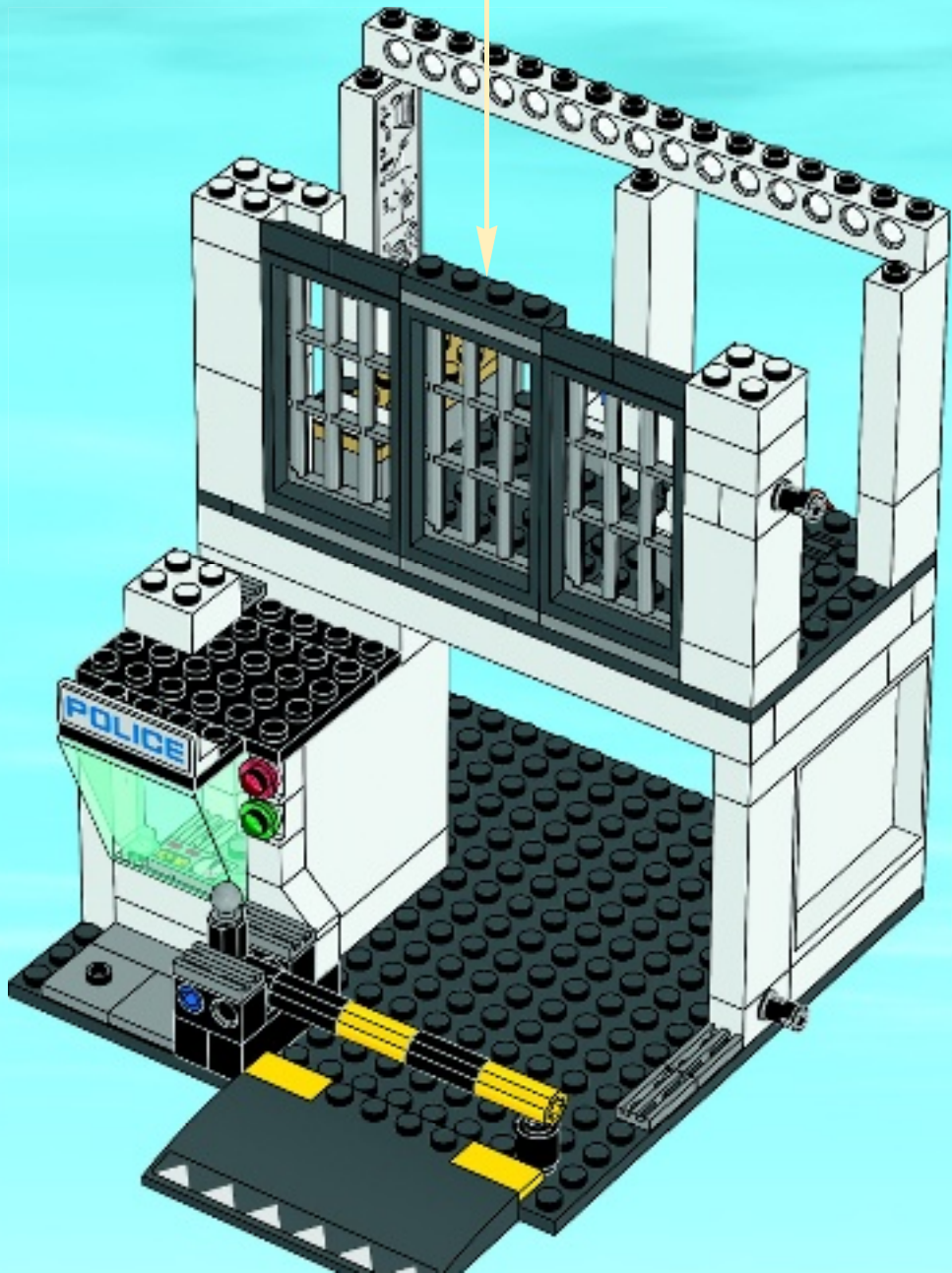
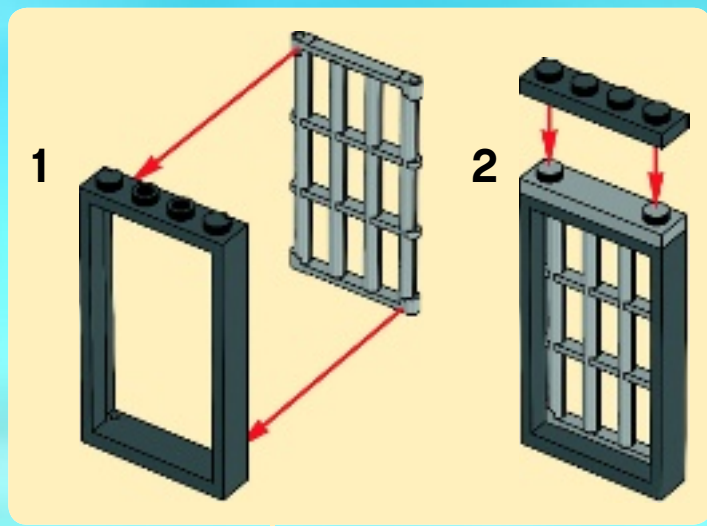

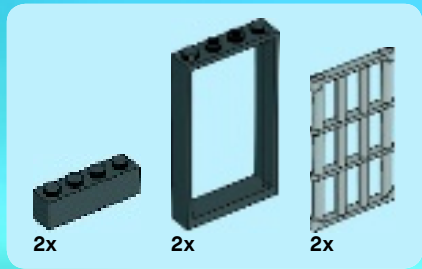

# 39

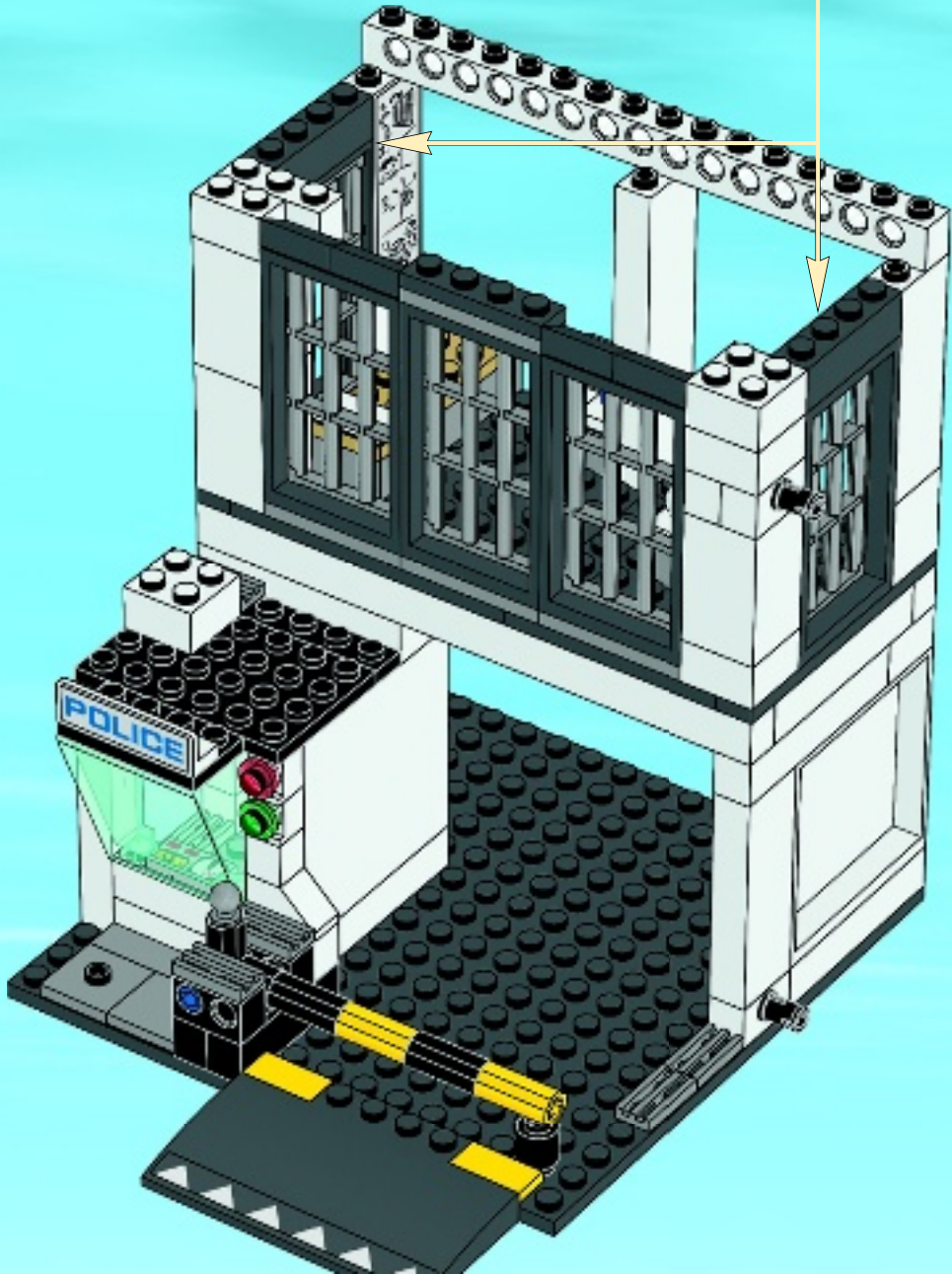
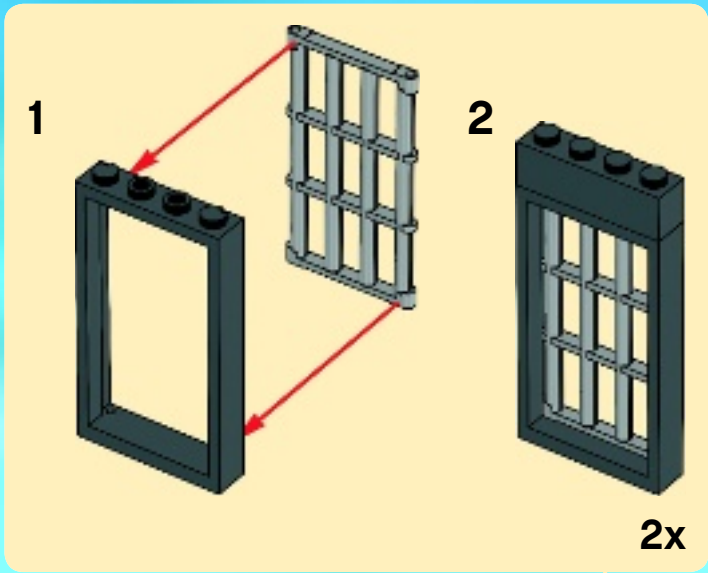





2x

# 40

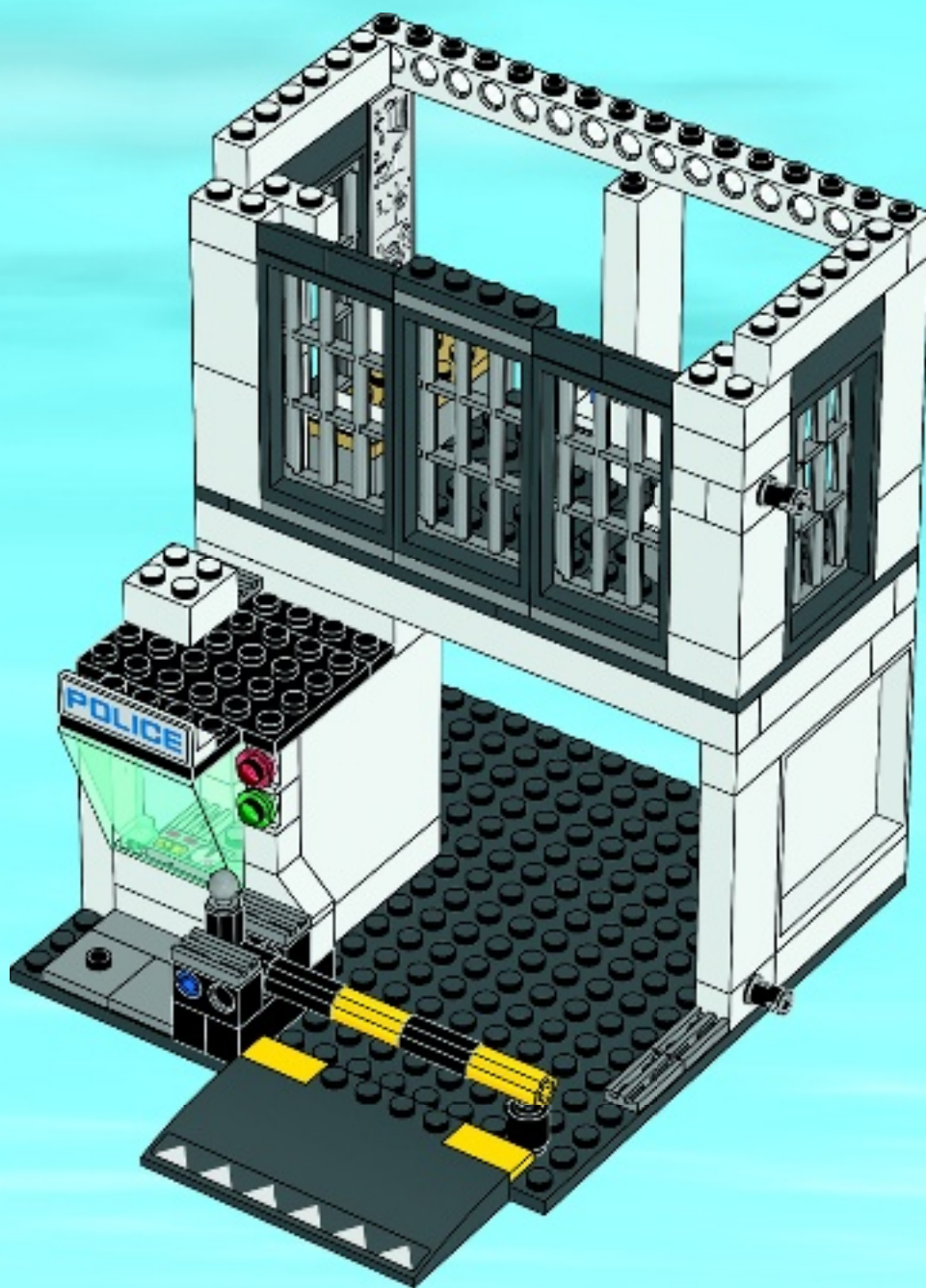

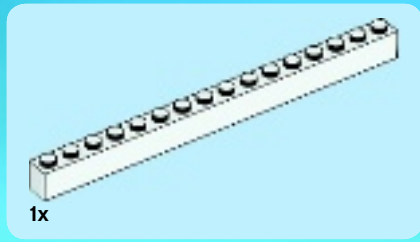

41

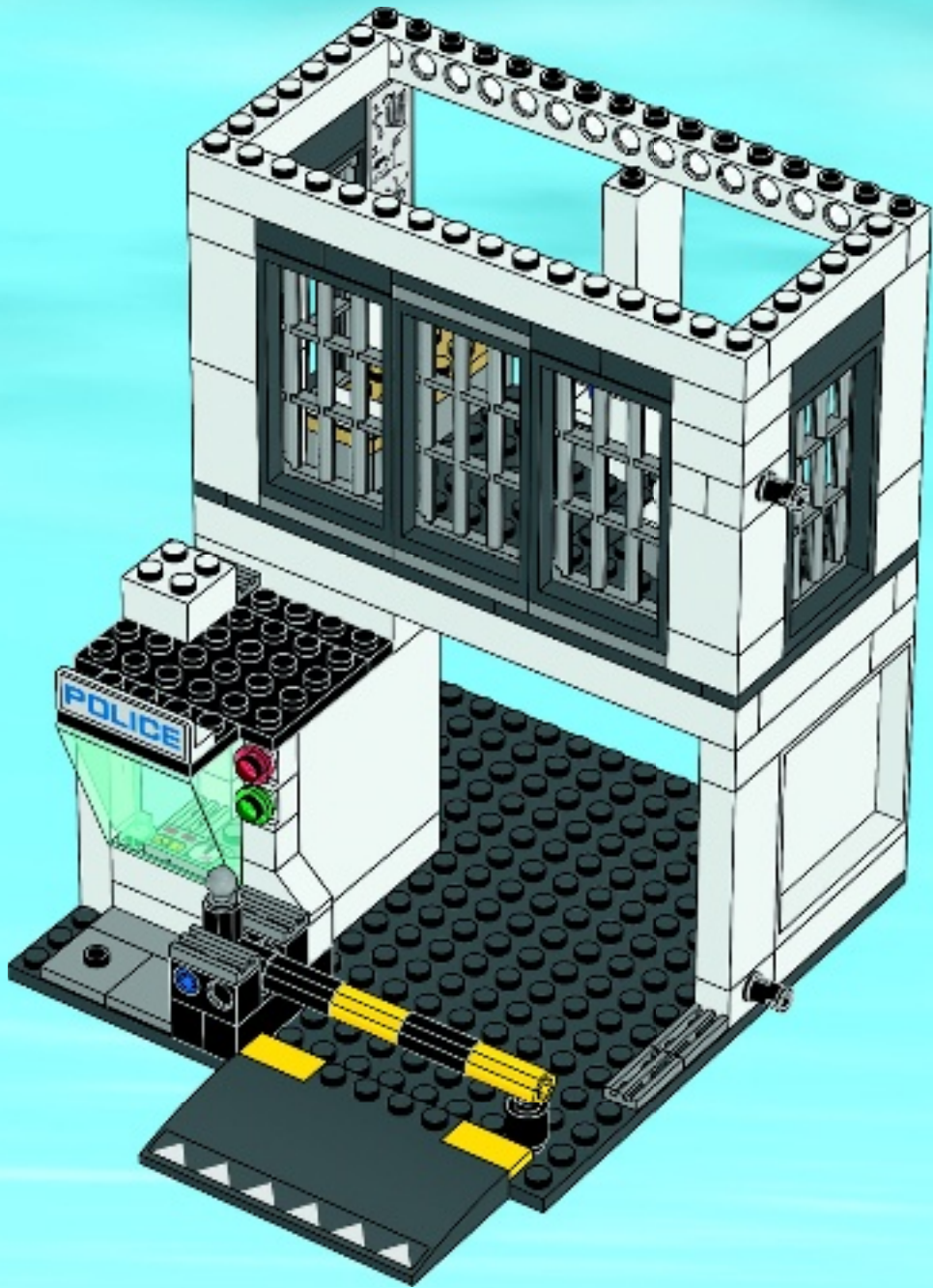





2x

# 42

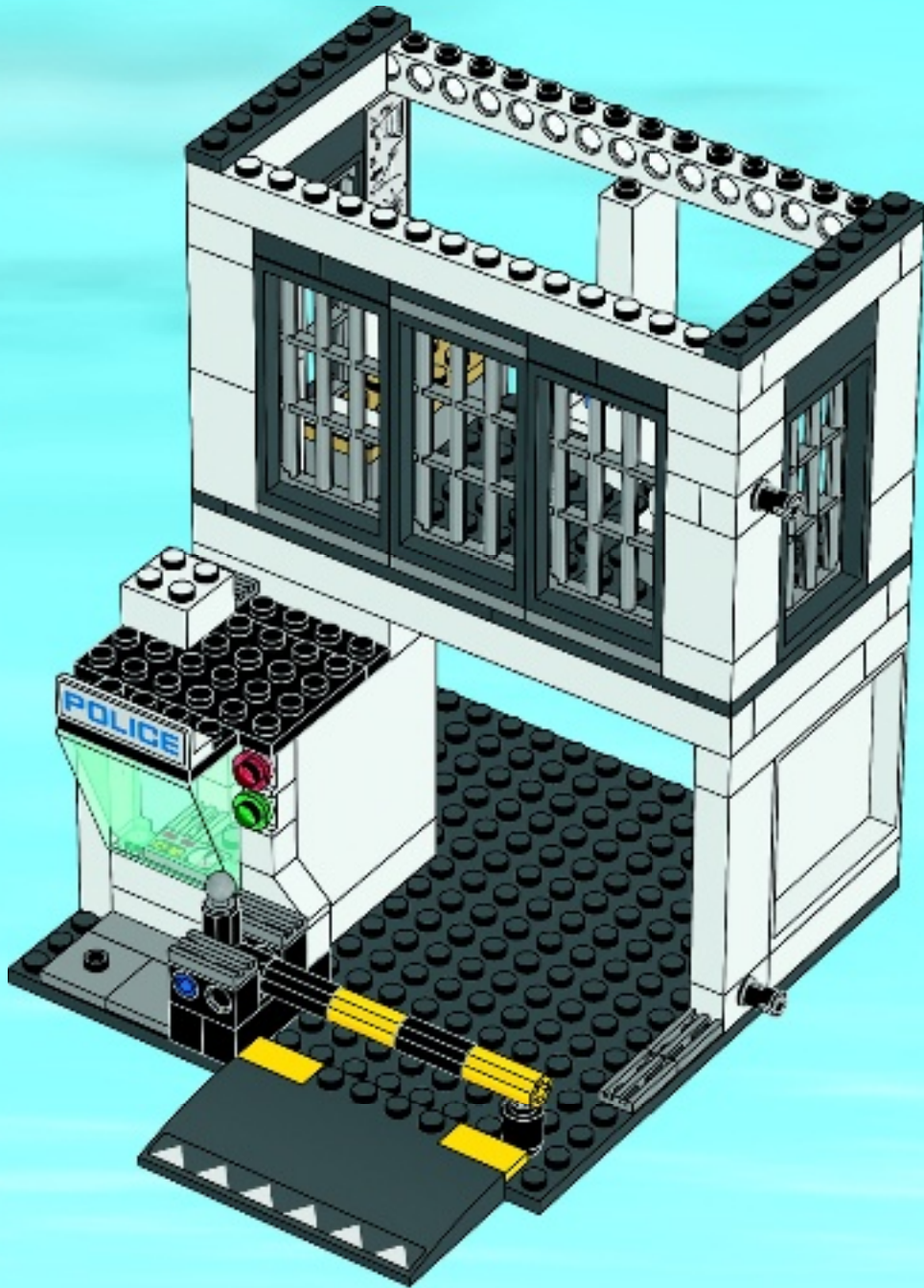

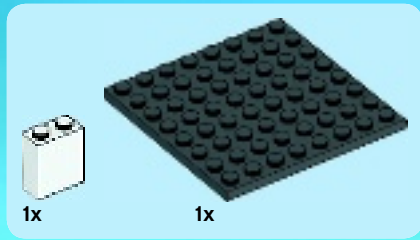

43

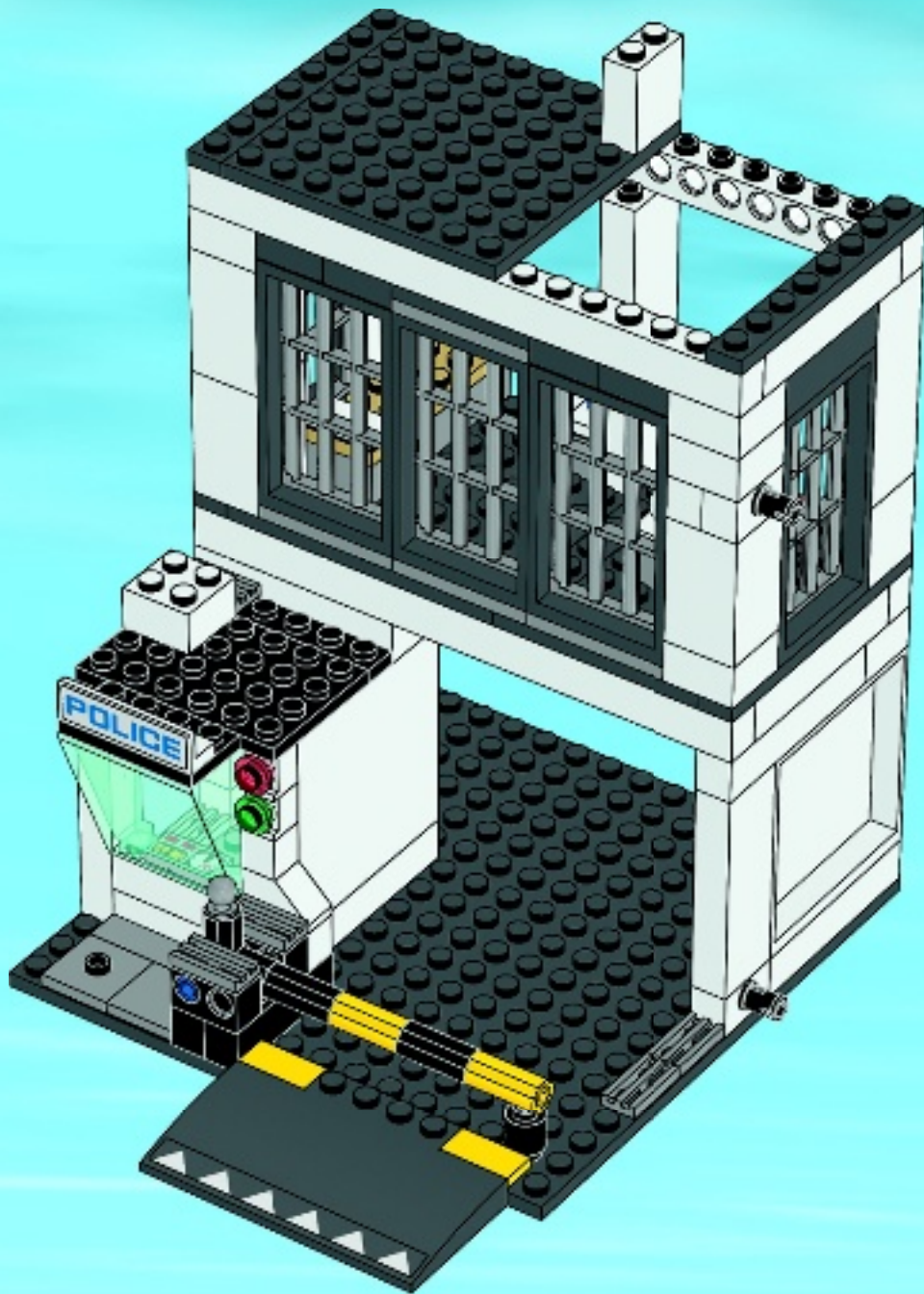



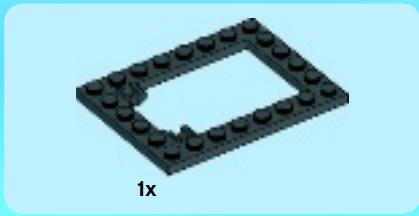

44

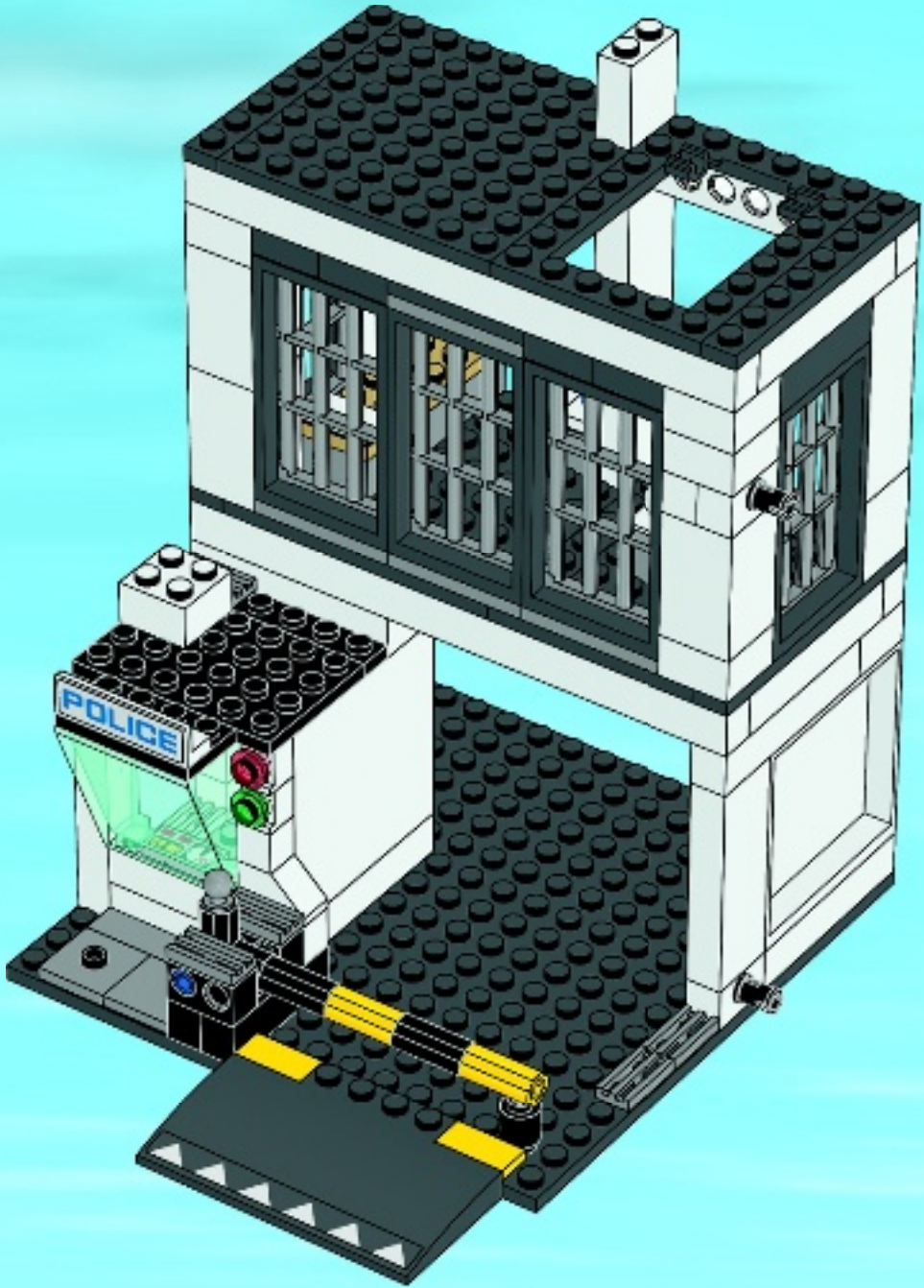



45

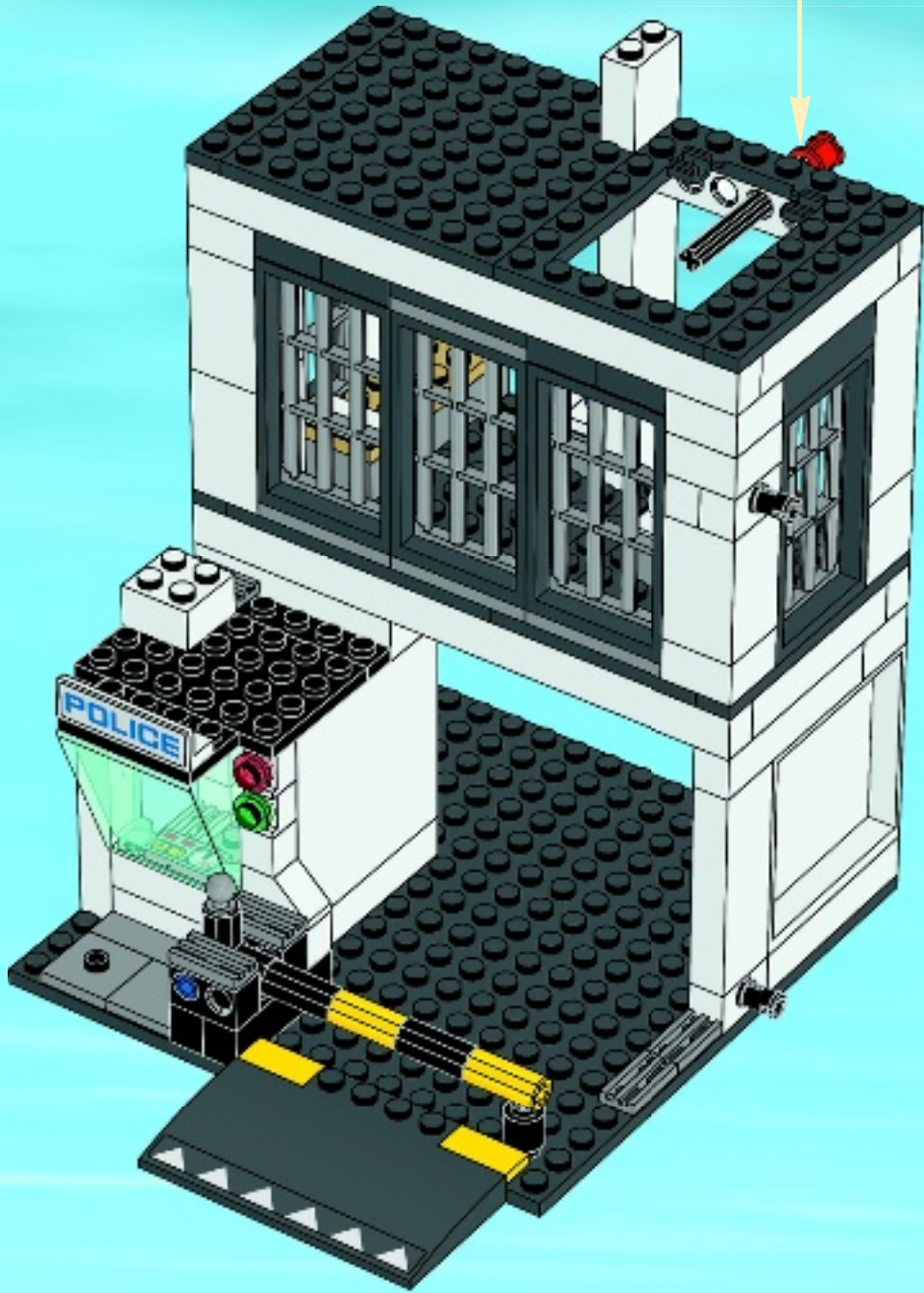

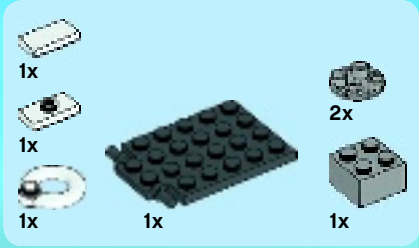

# 46

1



2

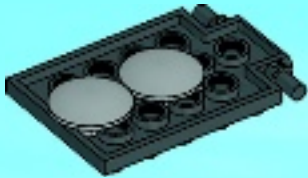



**3**

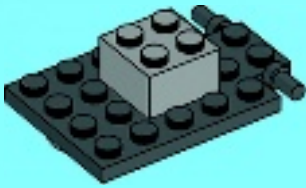

**4**

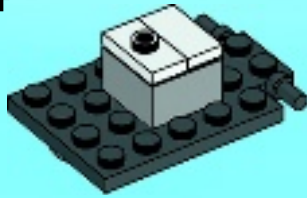

**5**





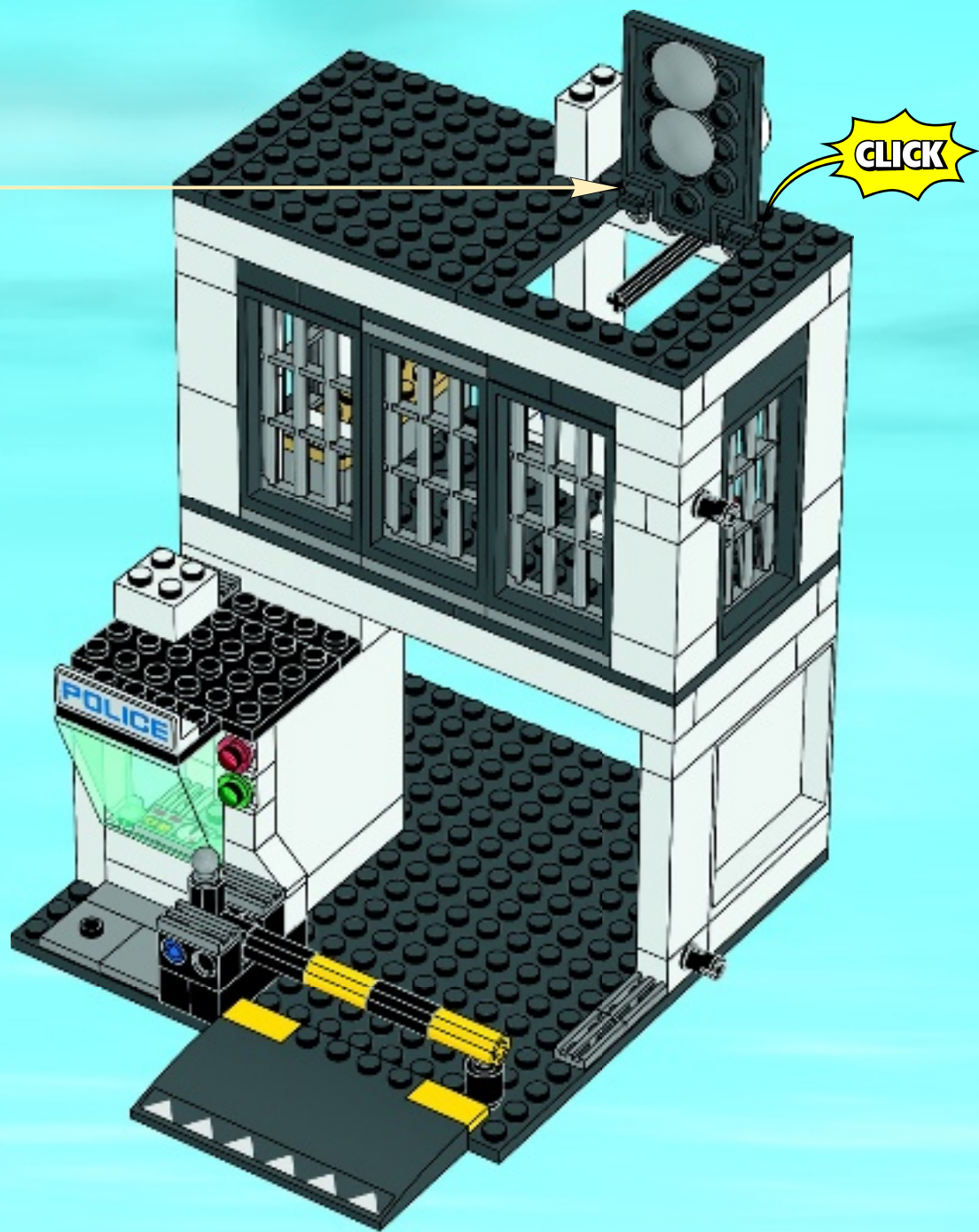

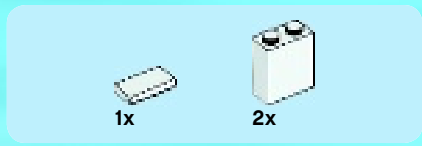
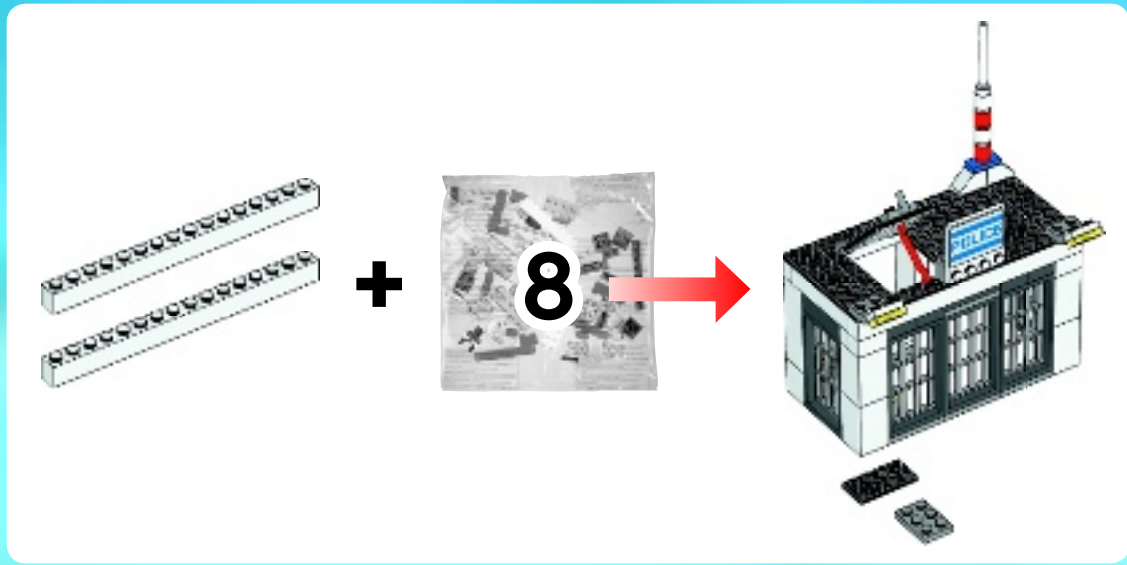

47

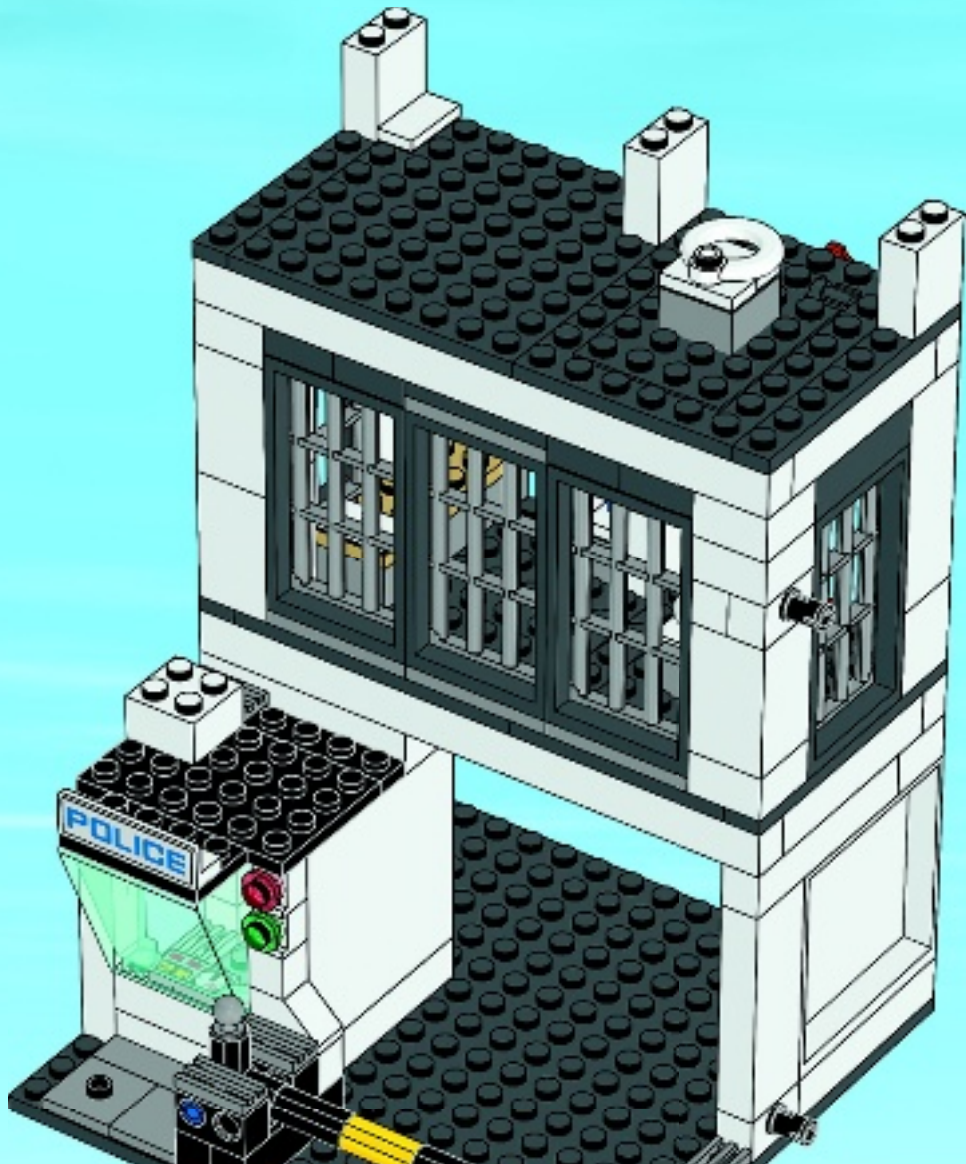





# 48

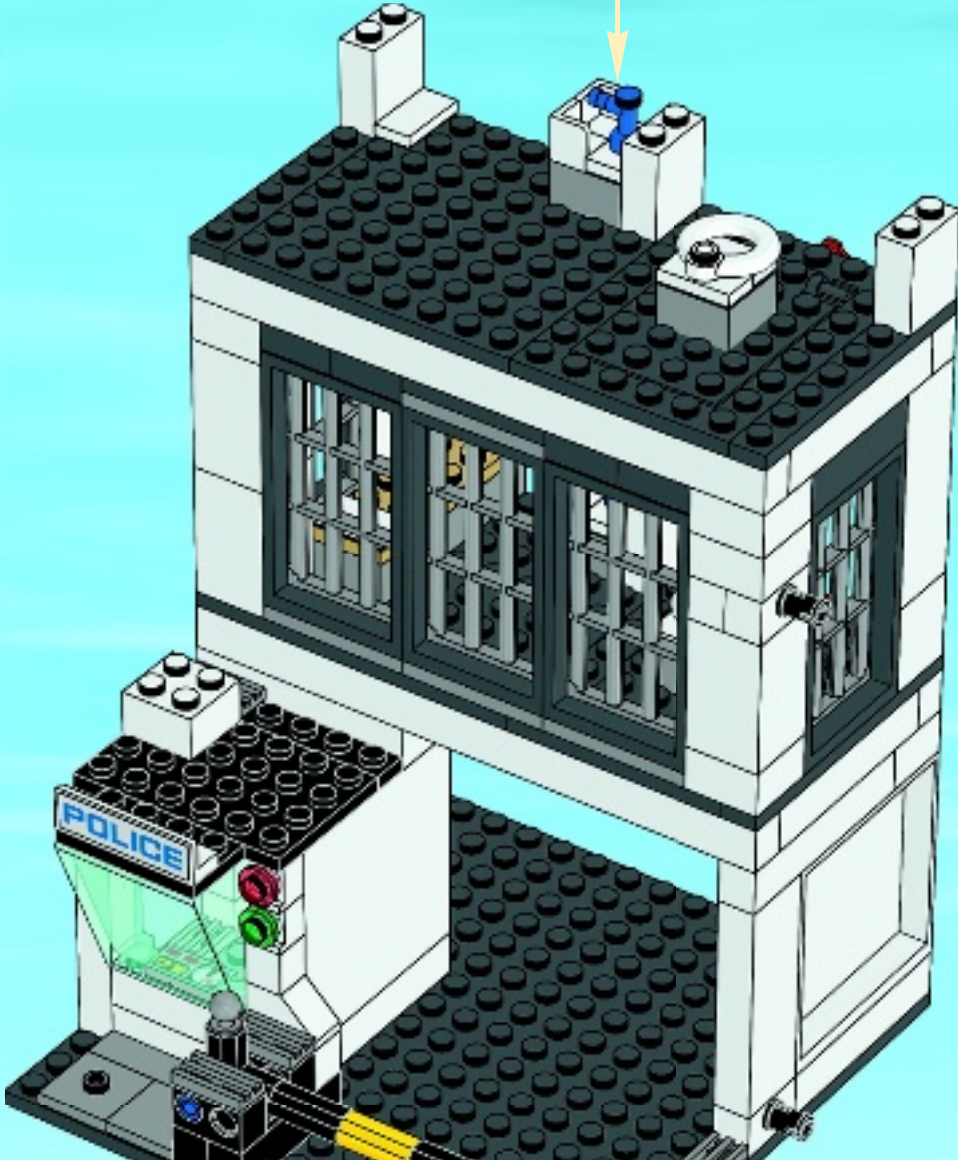
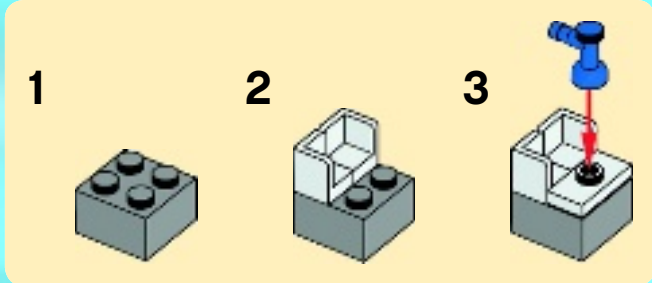



1x



2x



2x

# 49

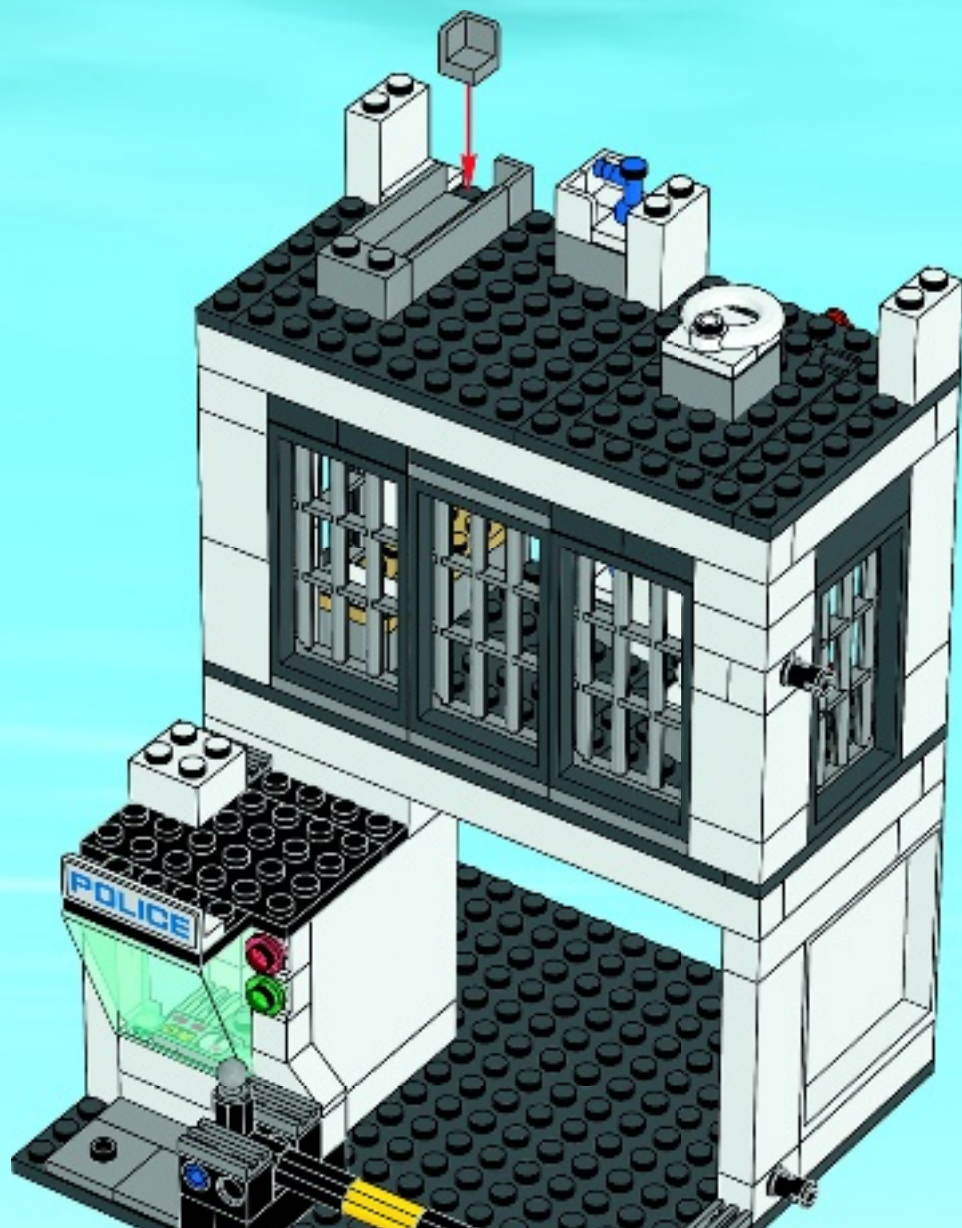





1x



1x

# 50

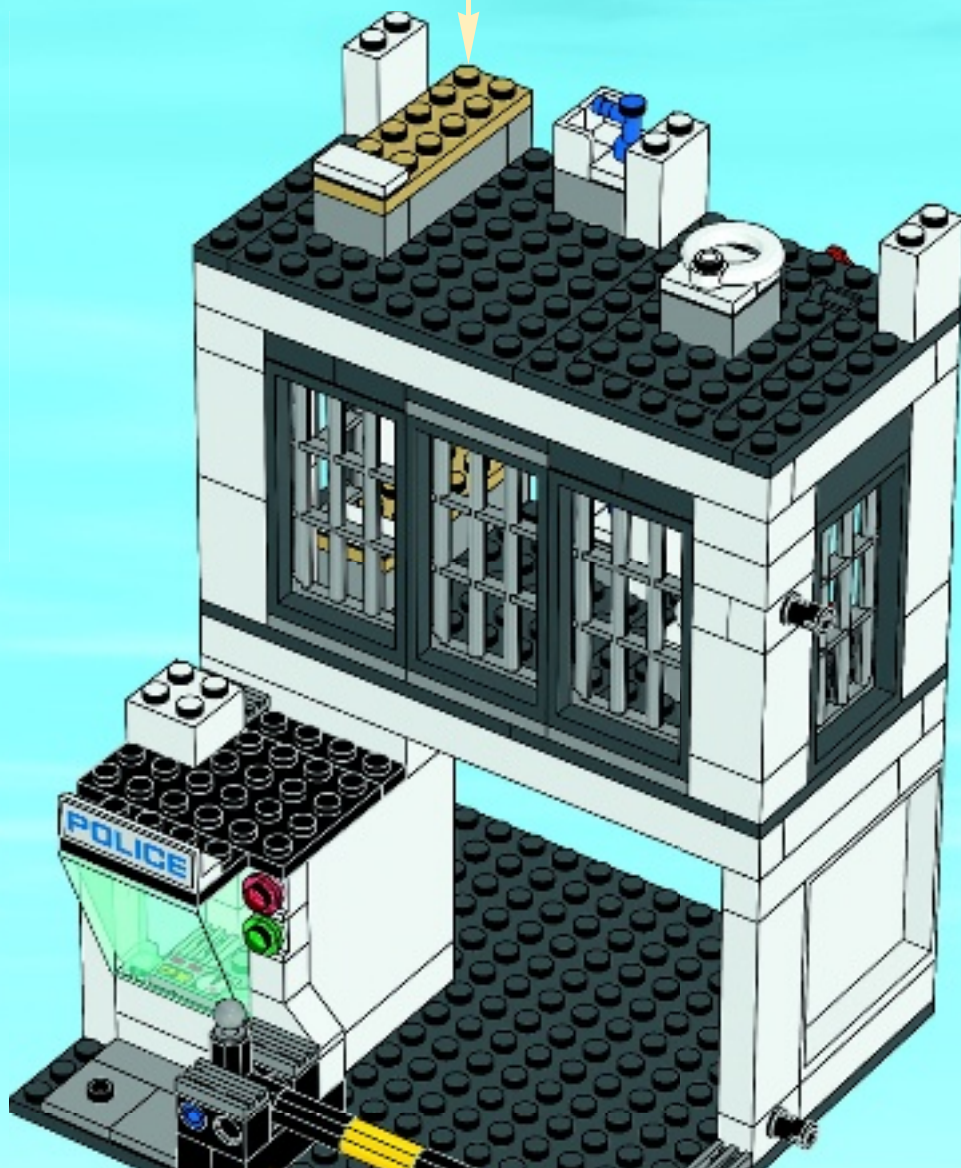
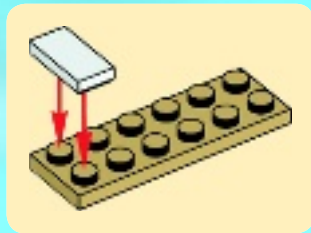



3x

1



2



# 51

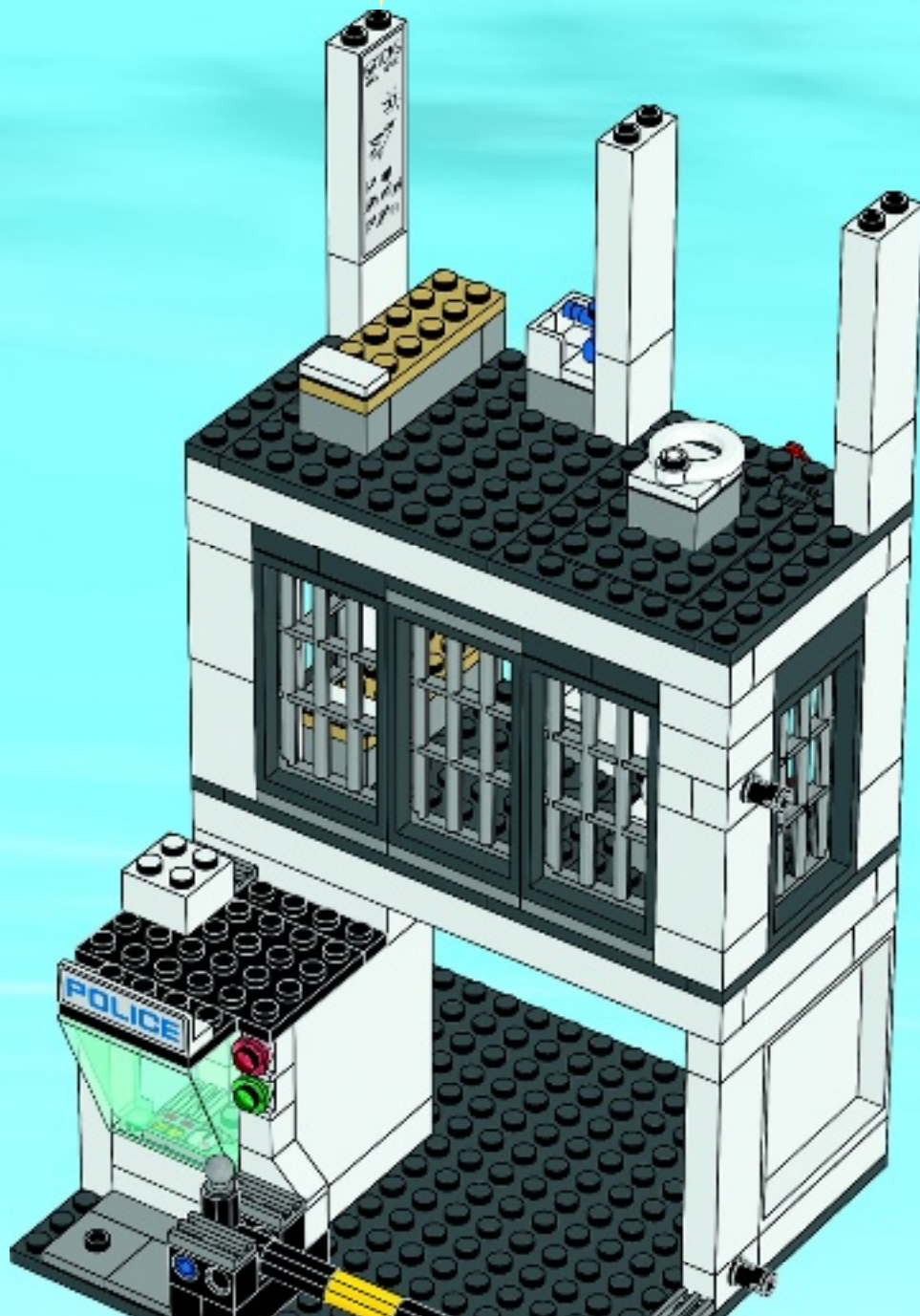



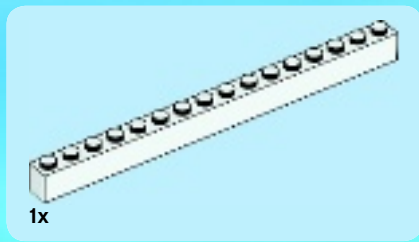

1x

# 52

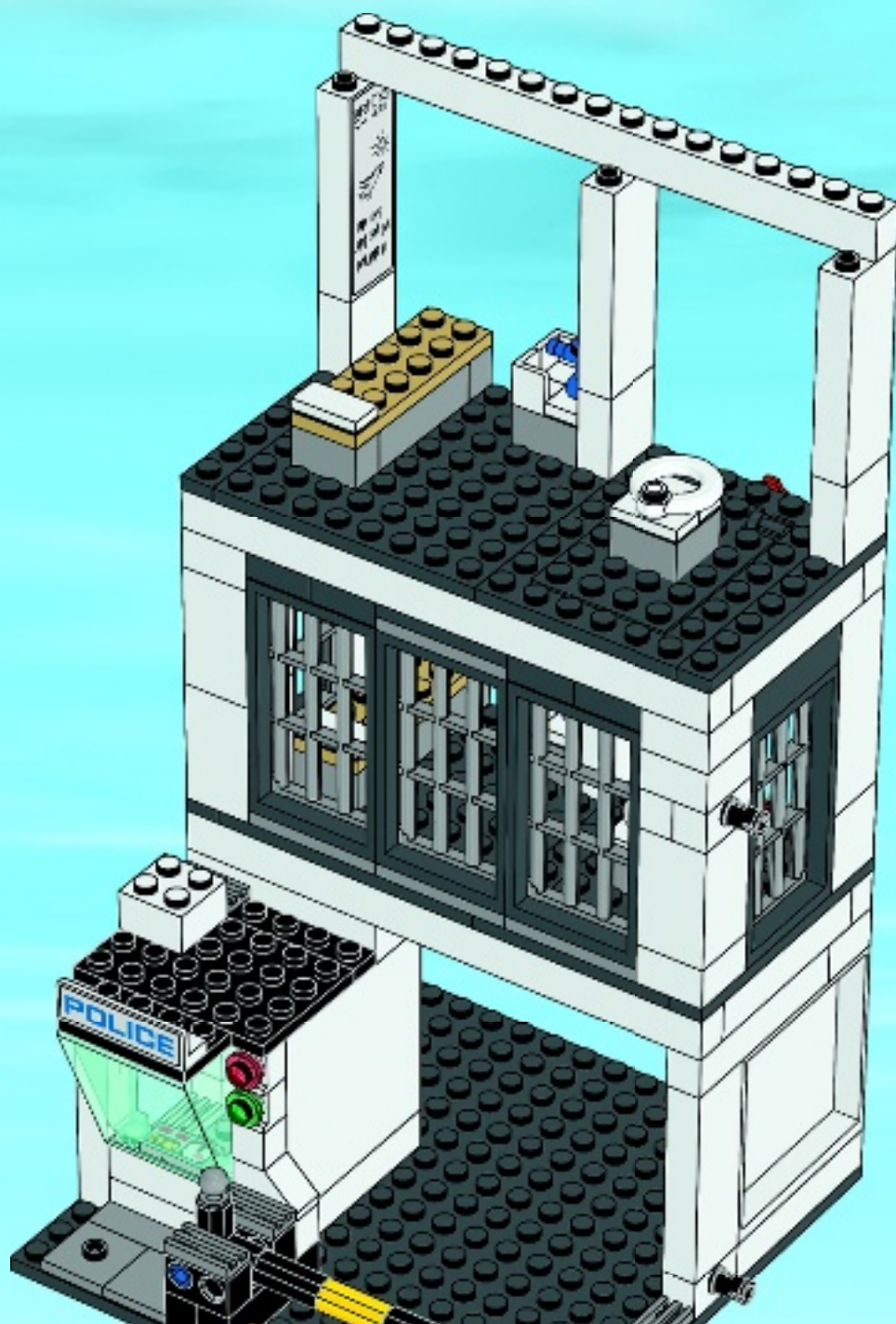





2x



3x

# 53

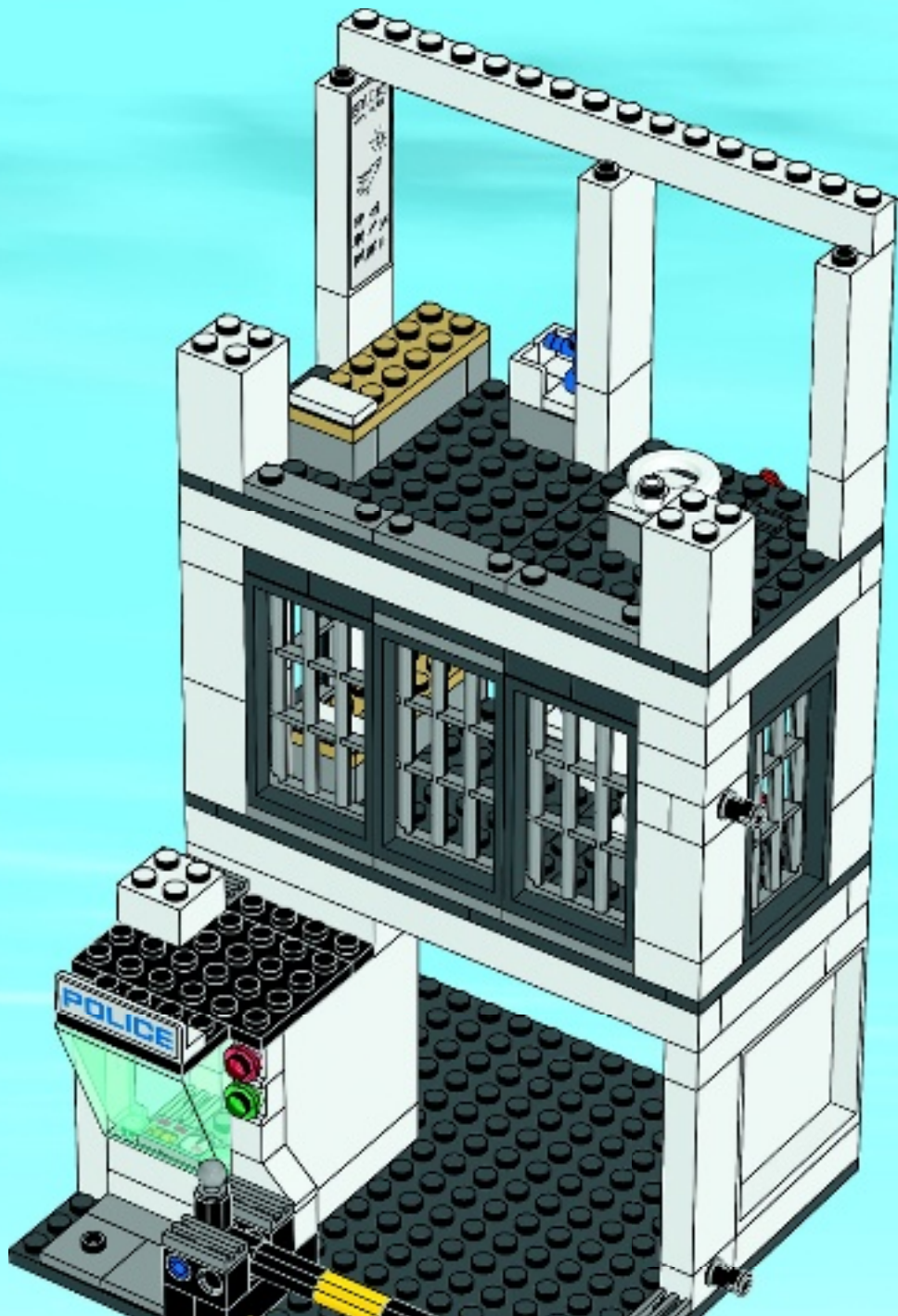

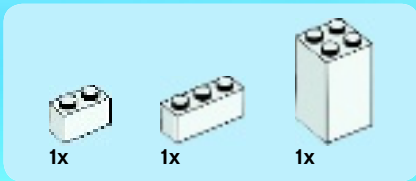

# 54

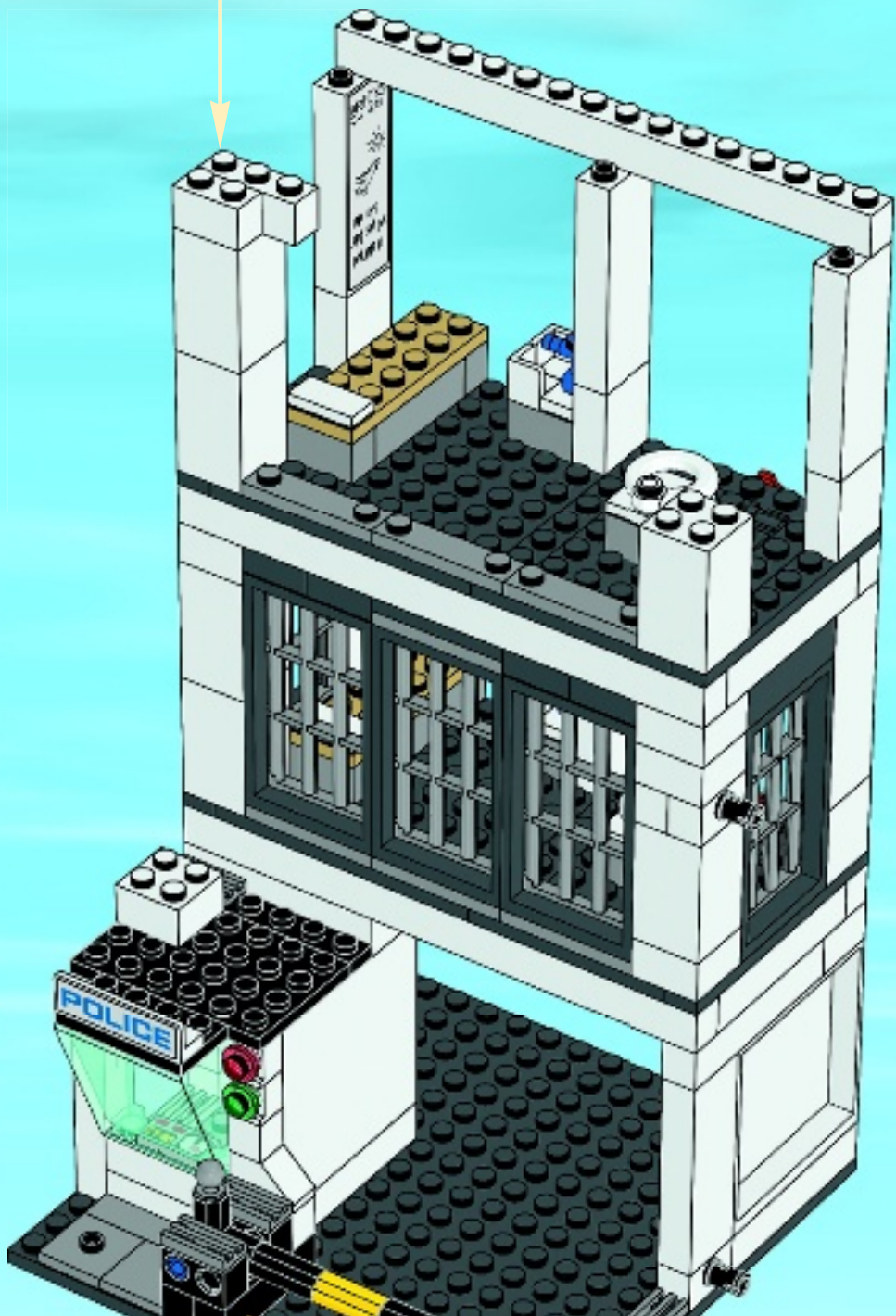
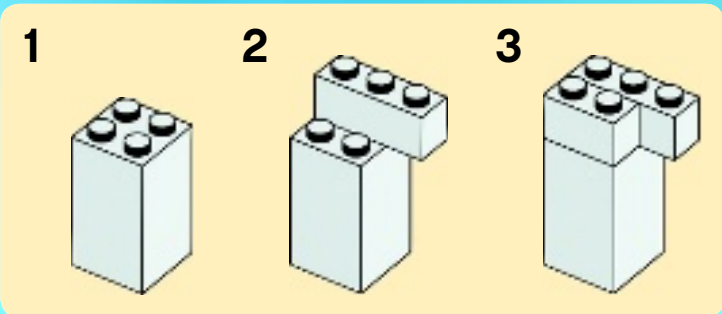



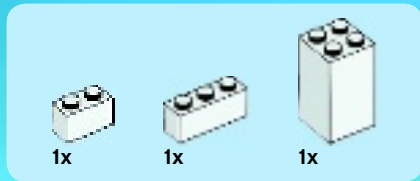

55

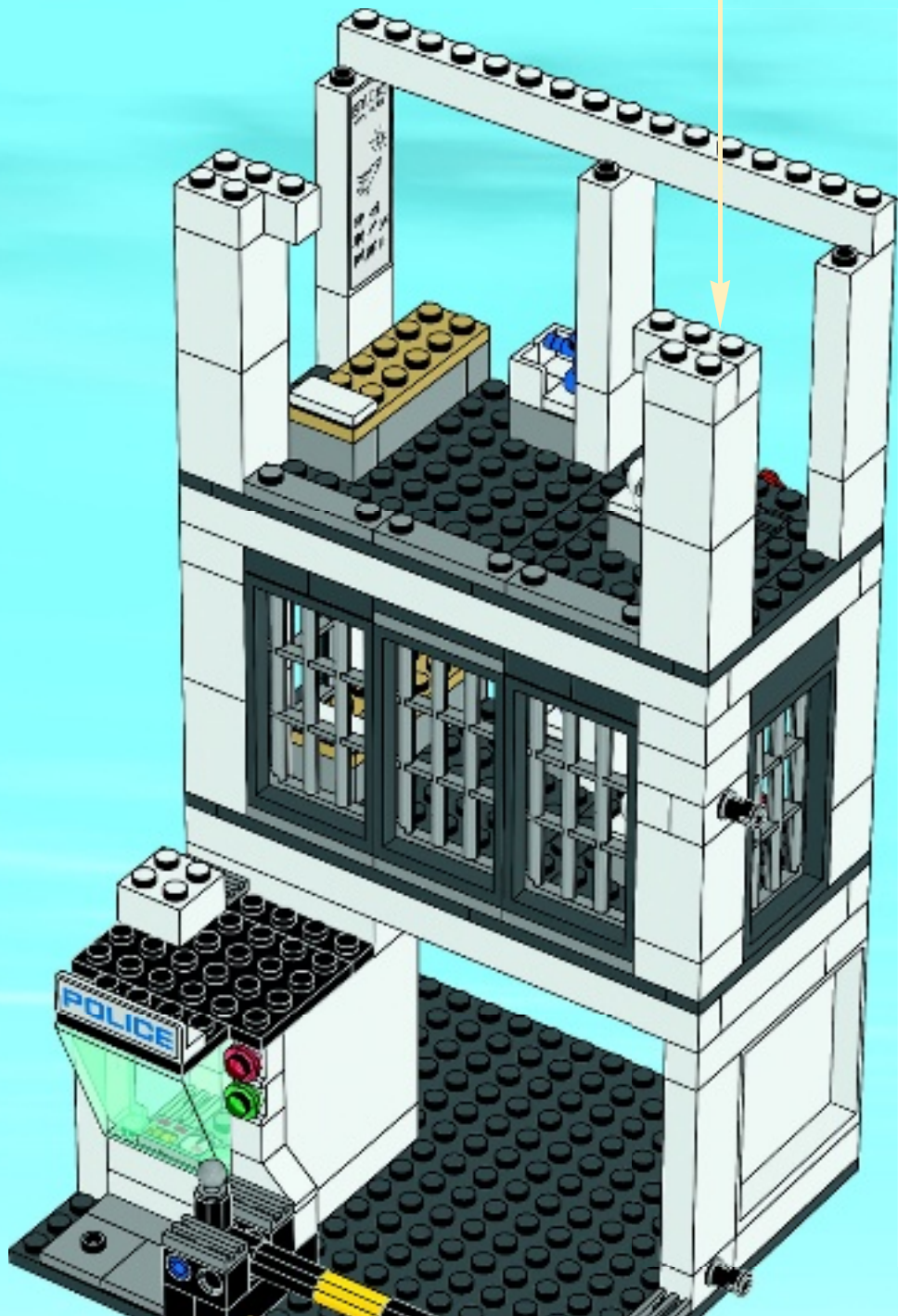
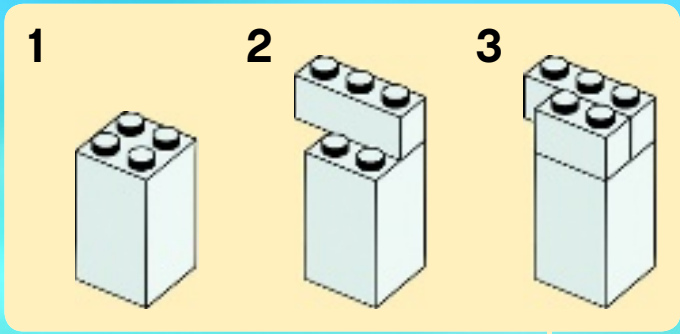



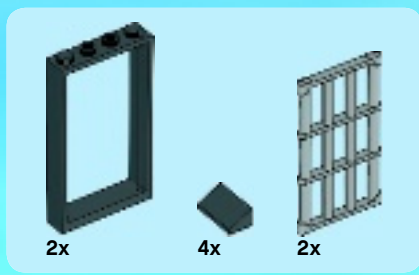

56

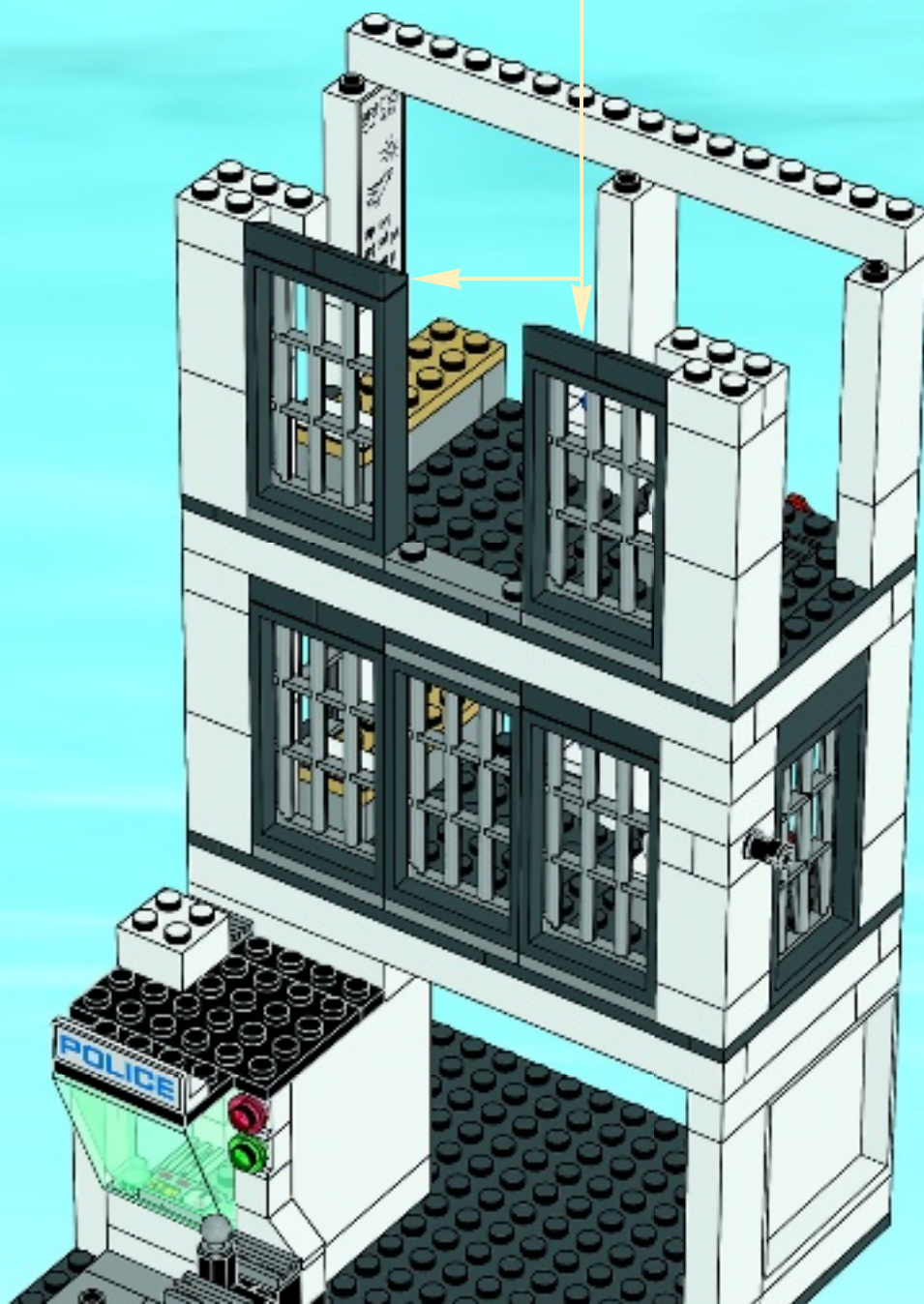
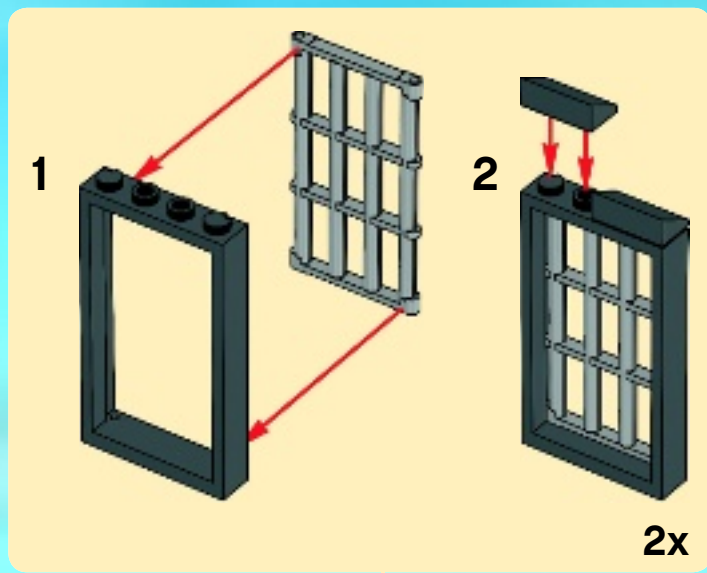

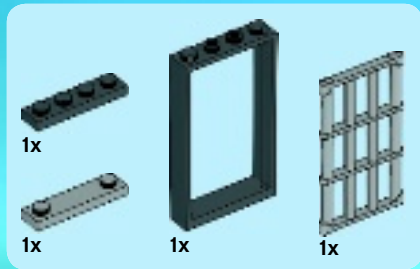

57

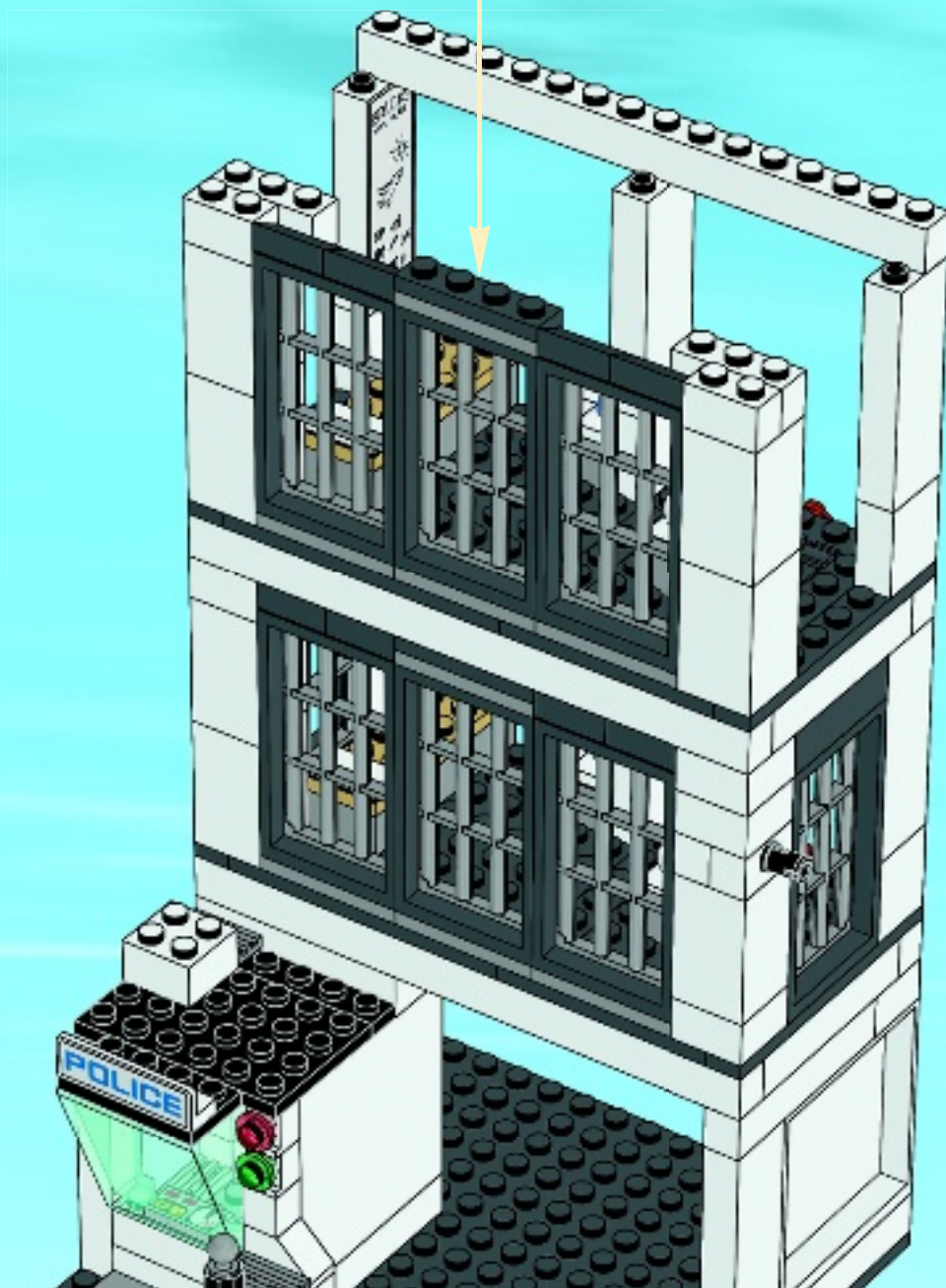
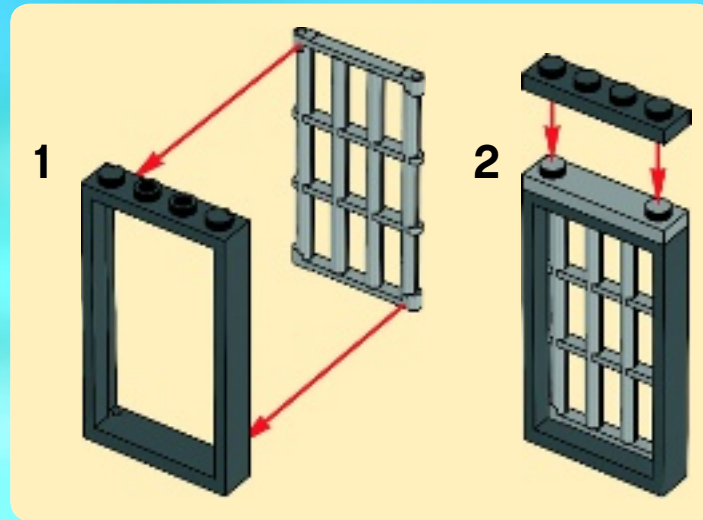



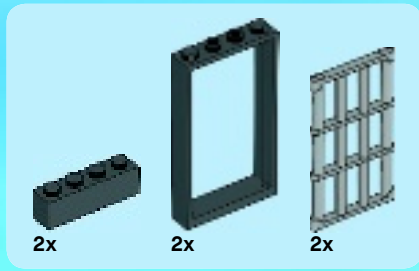

# 58

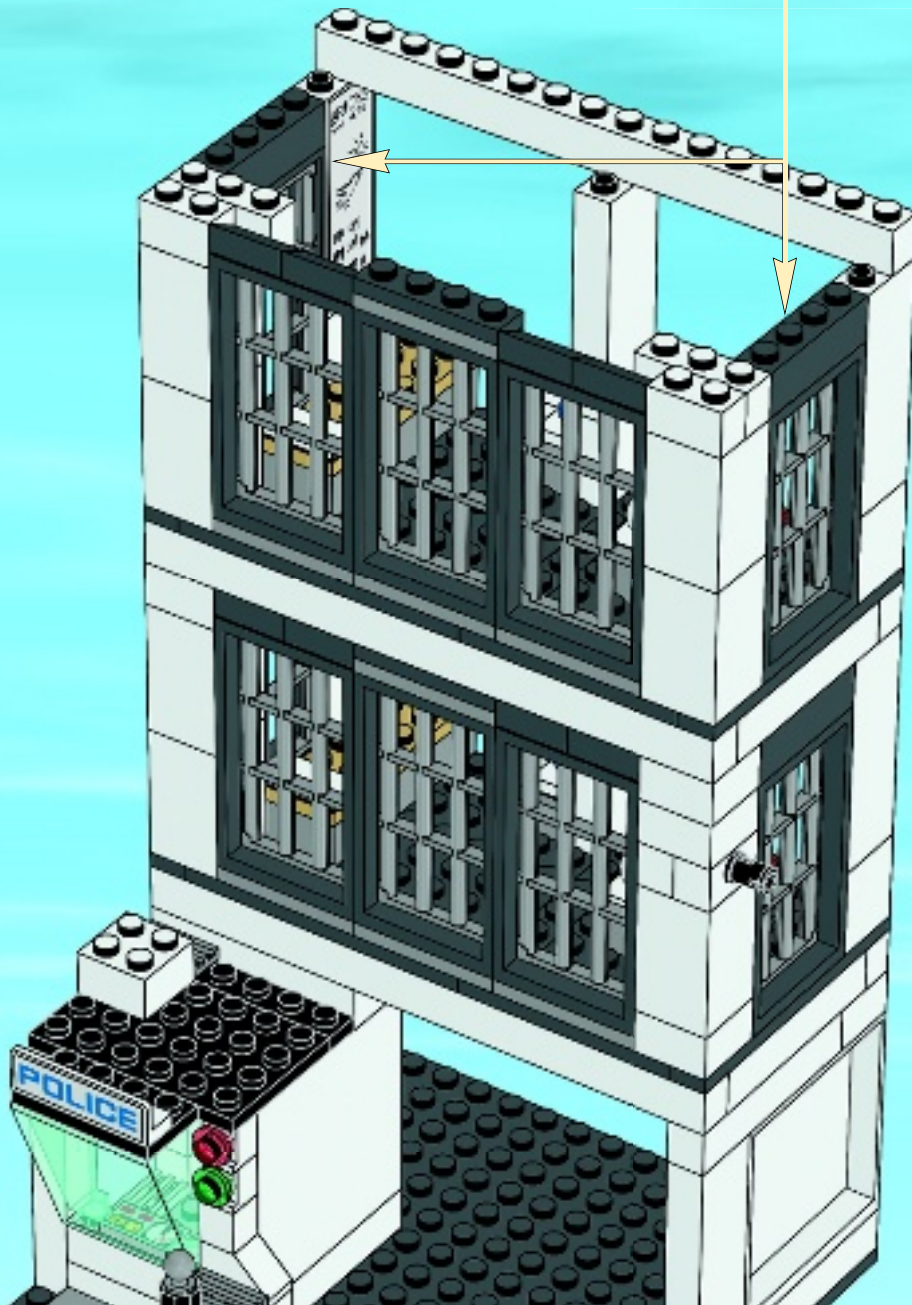
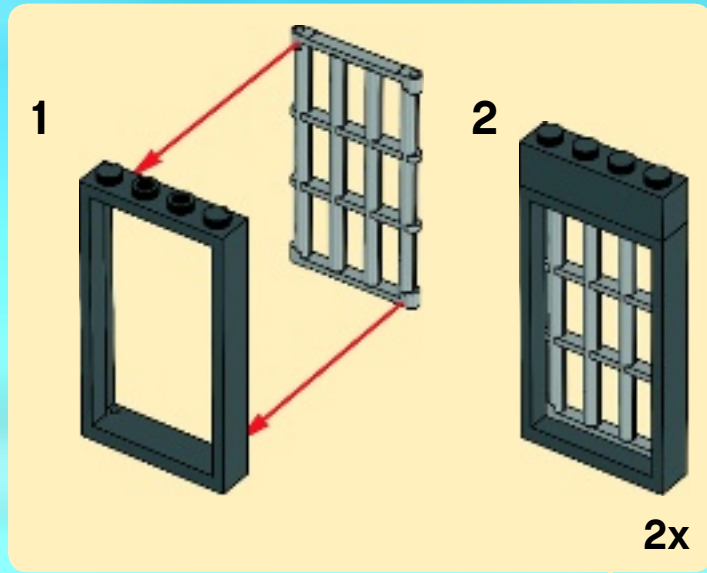





2x

# 59

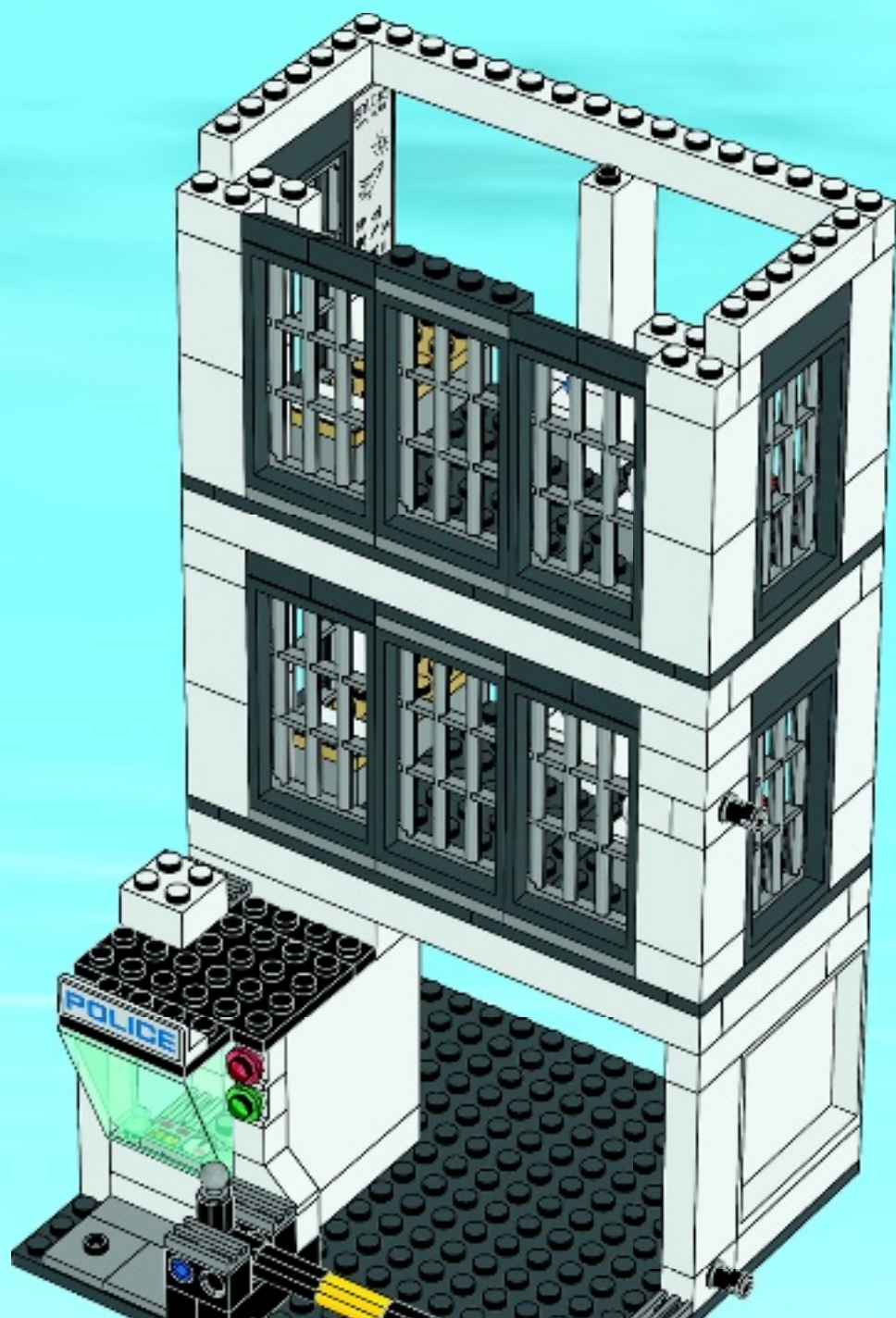

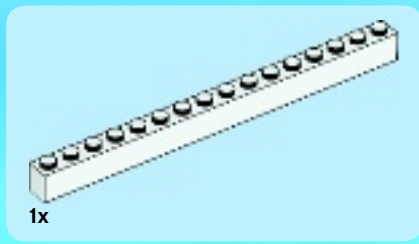

1x

# 60

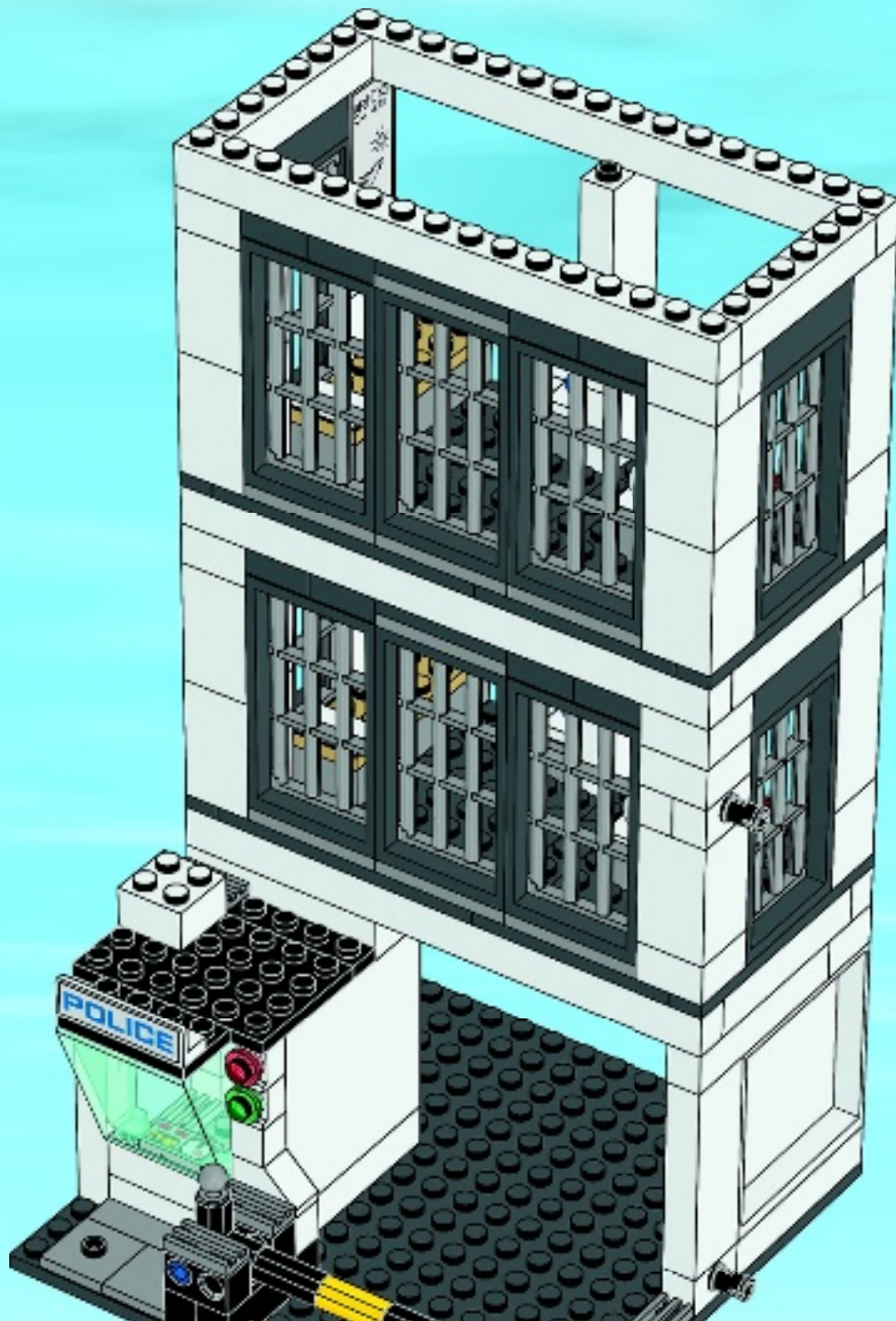





2x

# 61

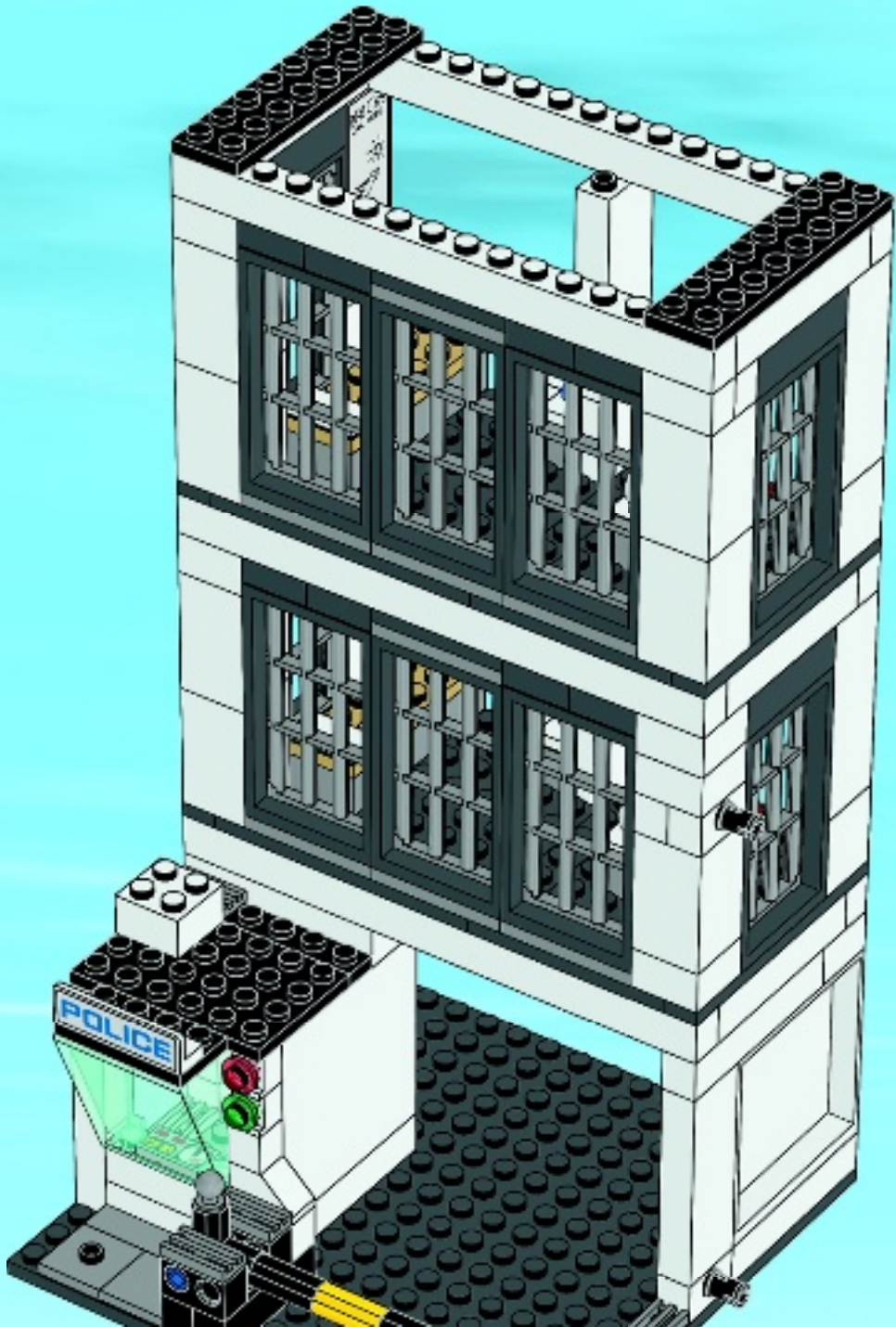



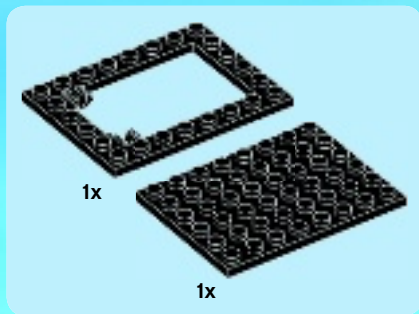

62

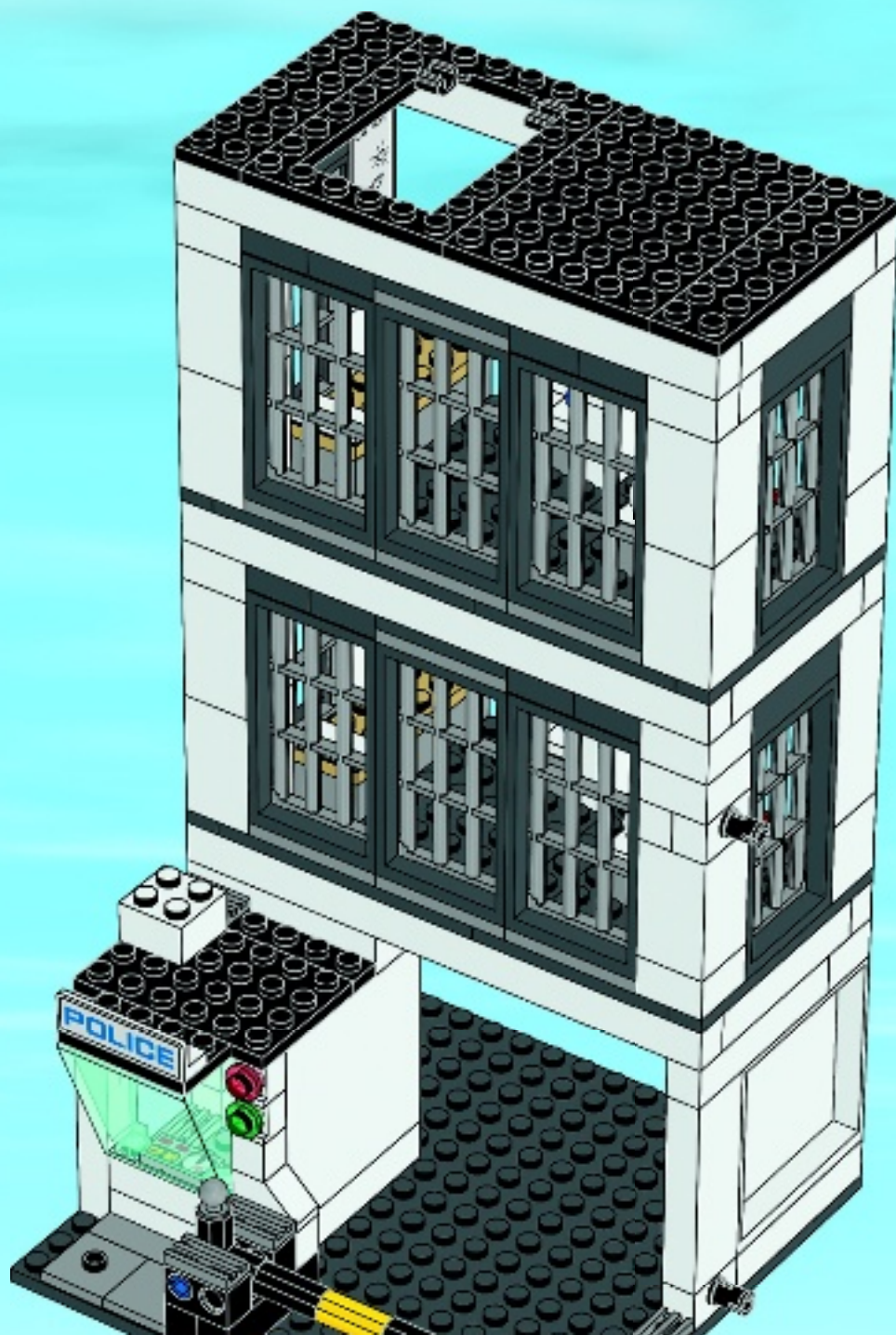

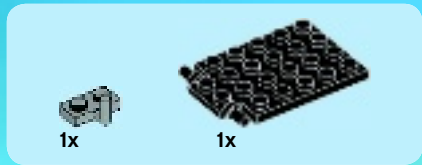

# 63





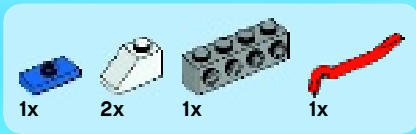

# 64

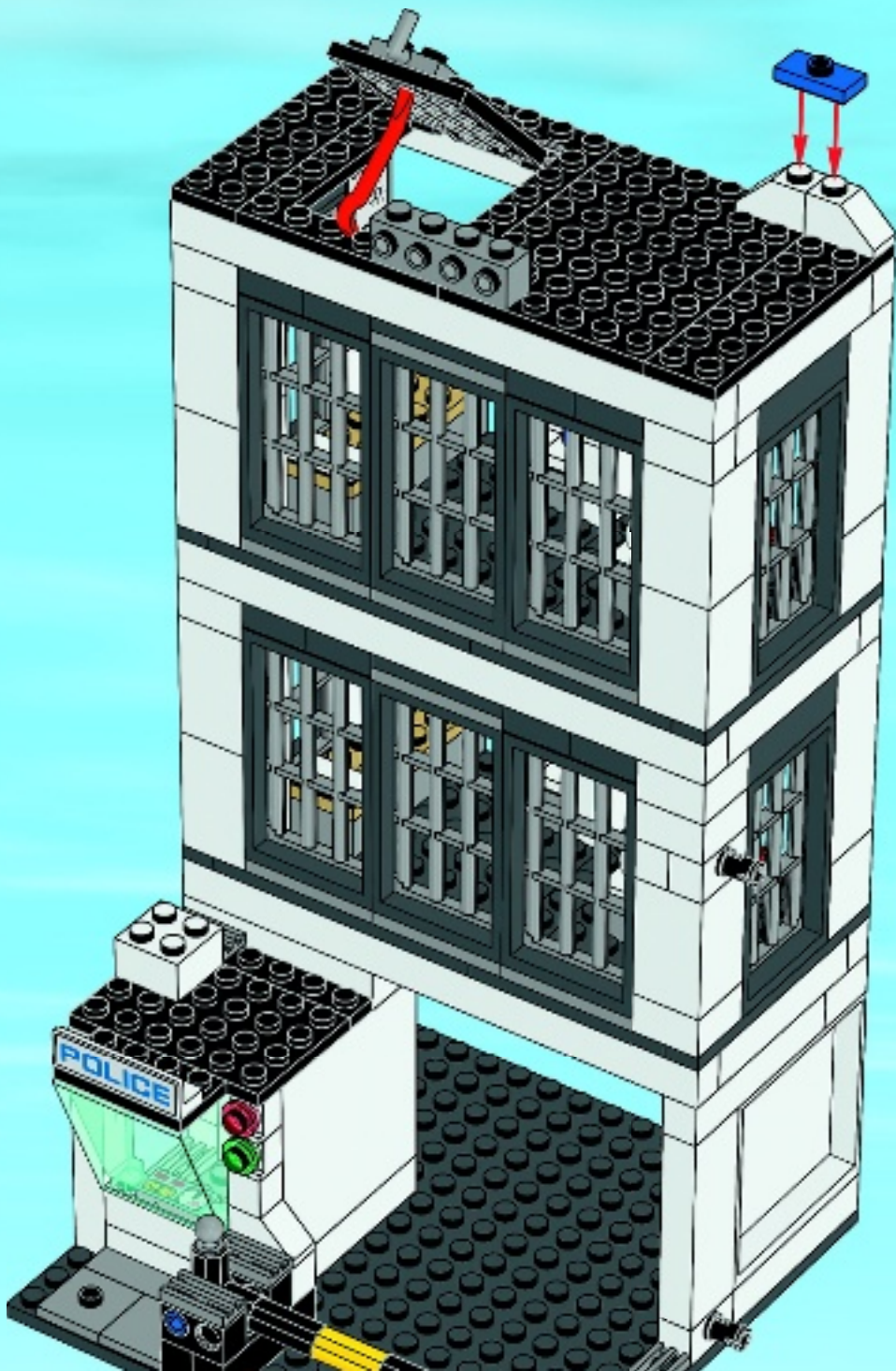



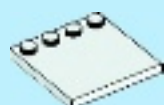

1x

1

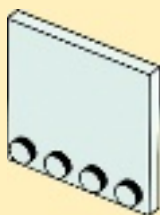

2



# 65

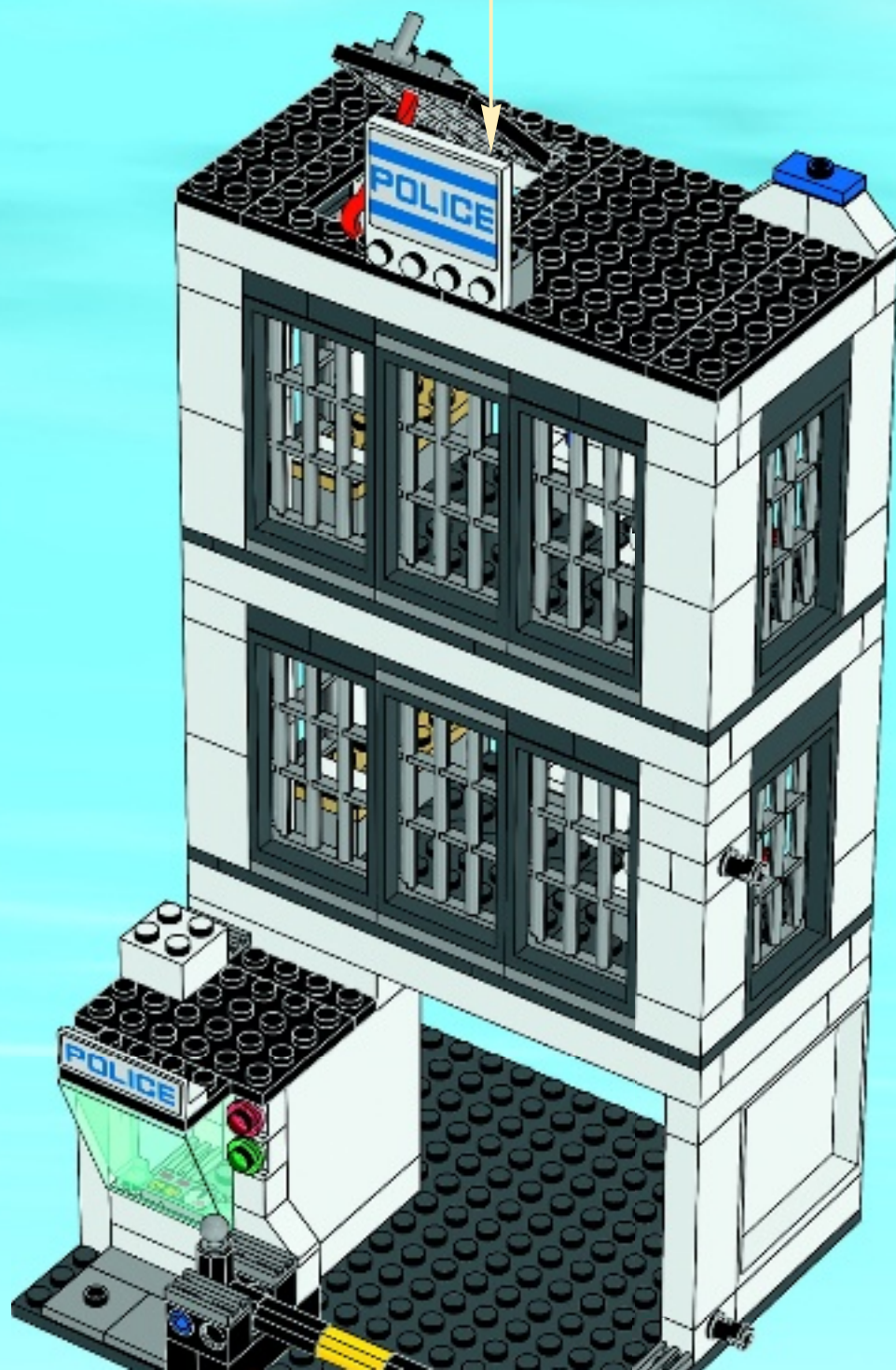



2x



2x



1x

# 66

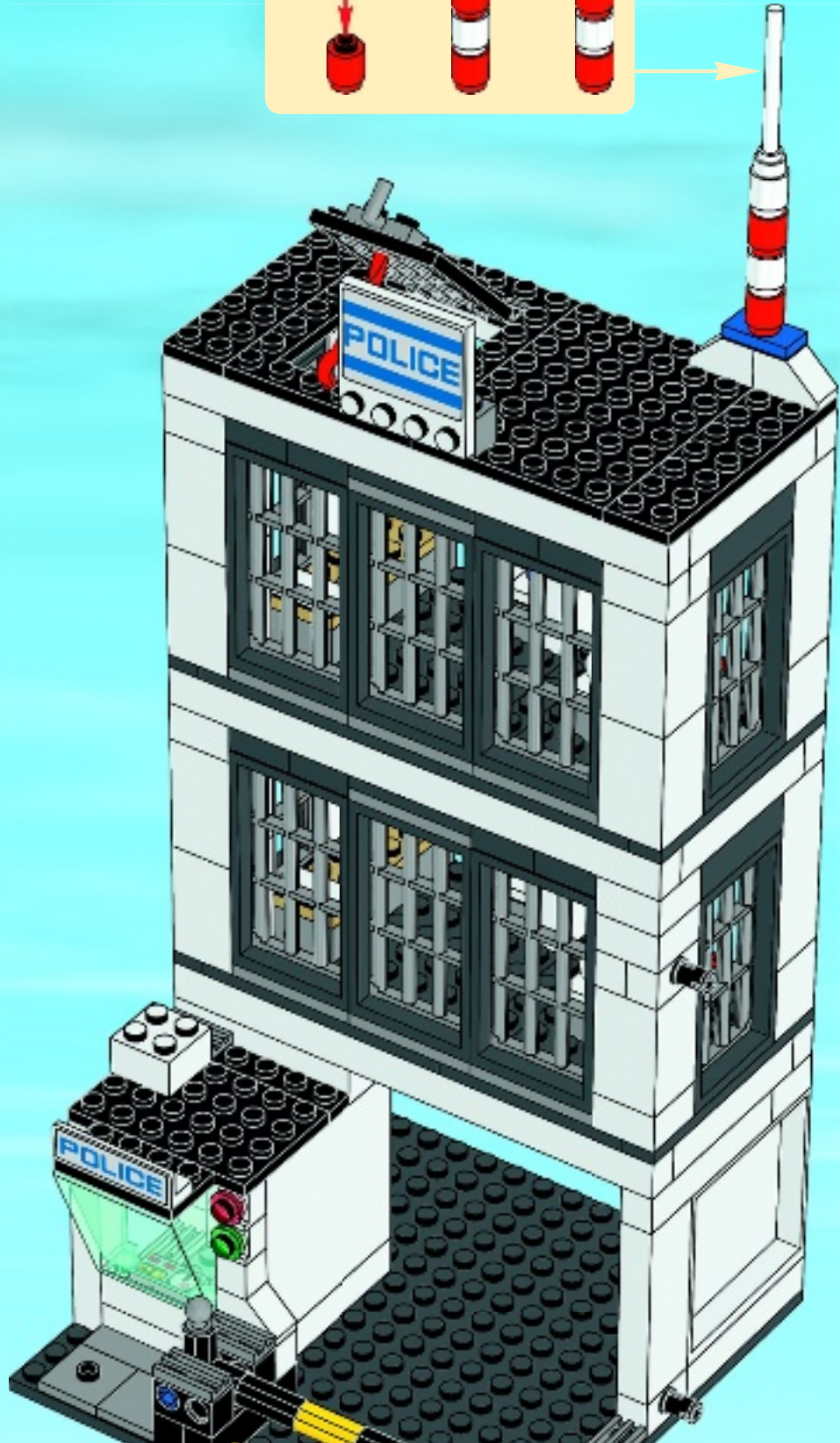
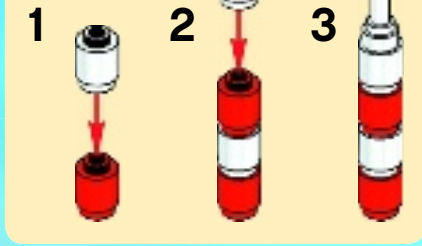





2x



2x



2x

1



2



2x

# 67

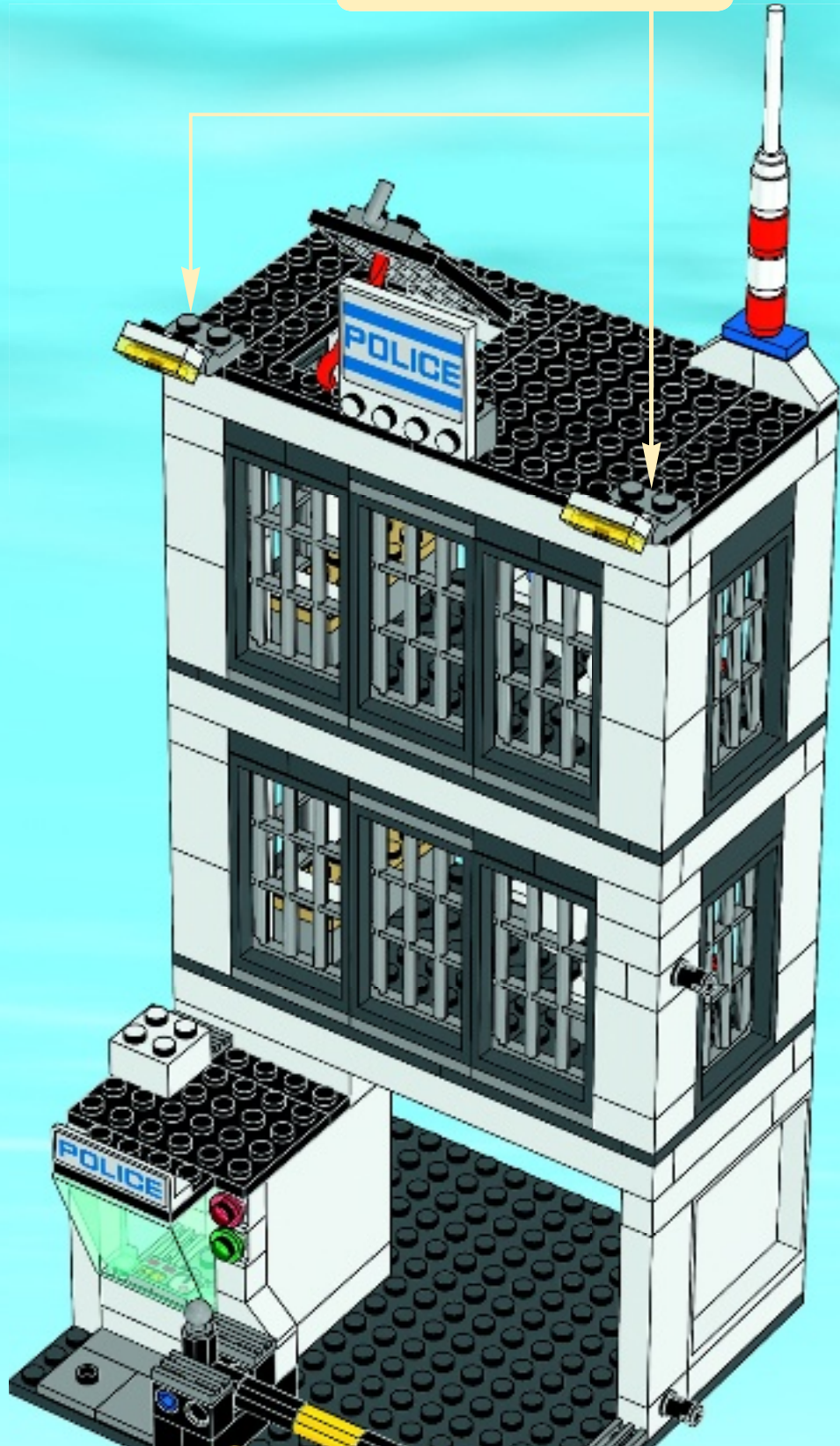



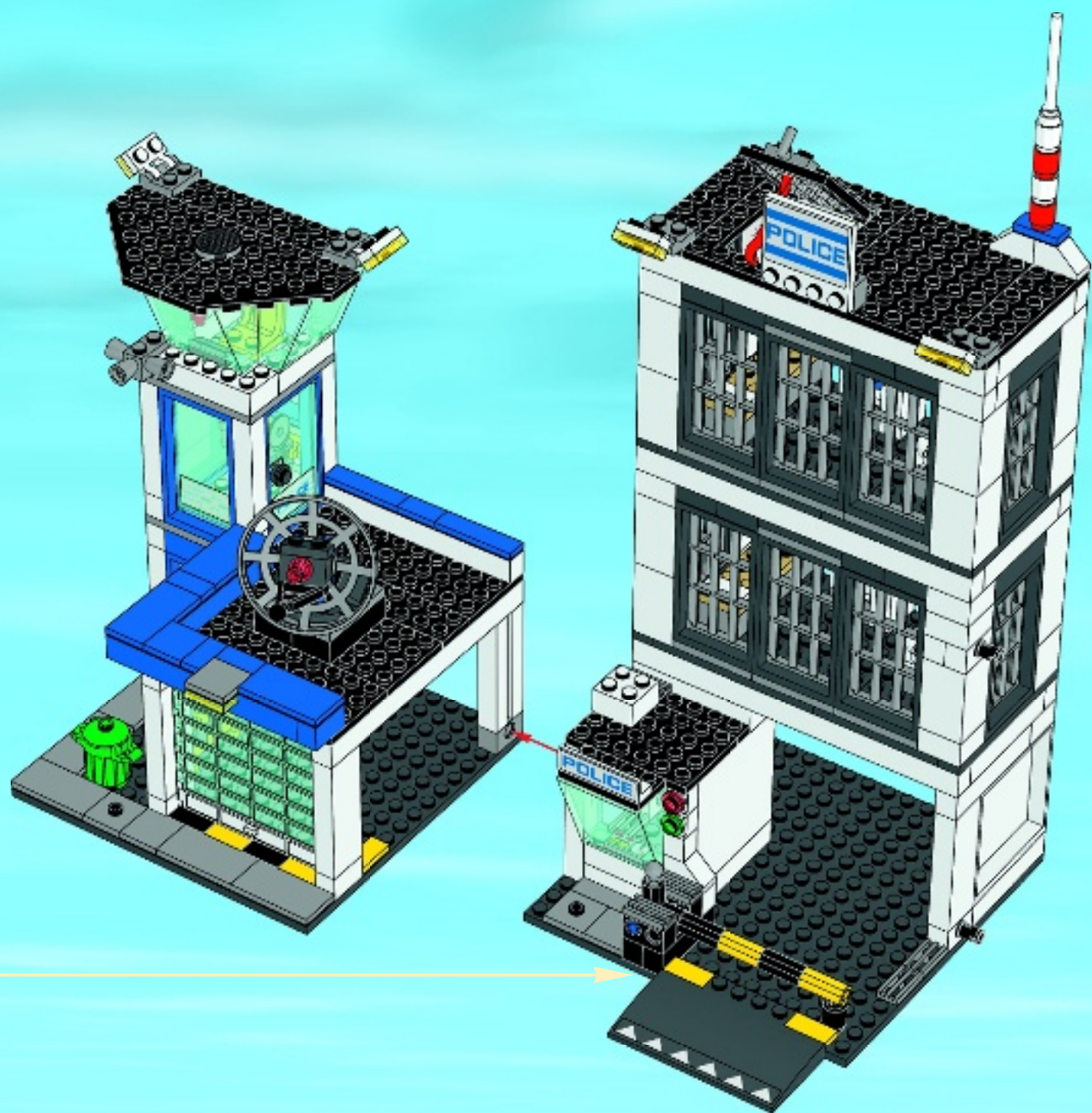



1x



1x

# 69

