

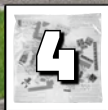

# CITY

60210

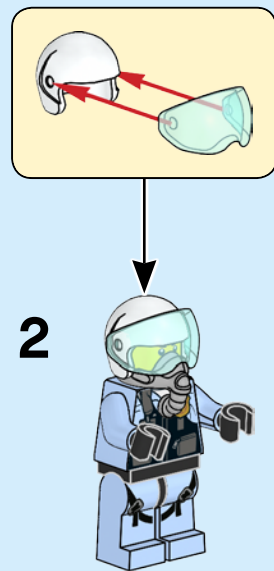

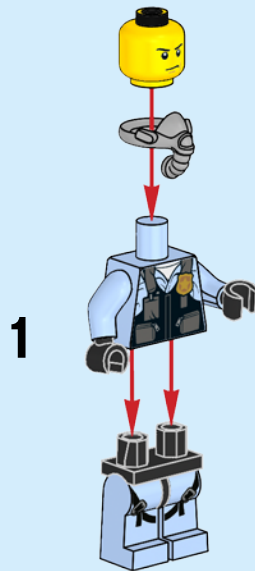
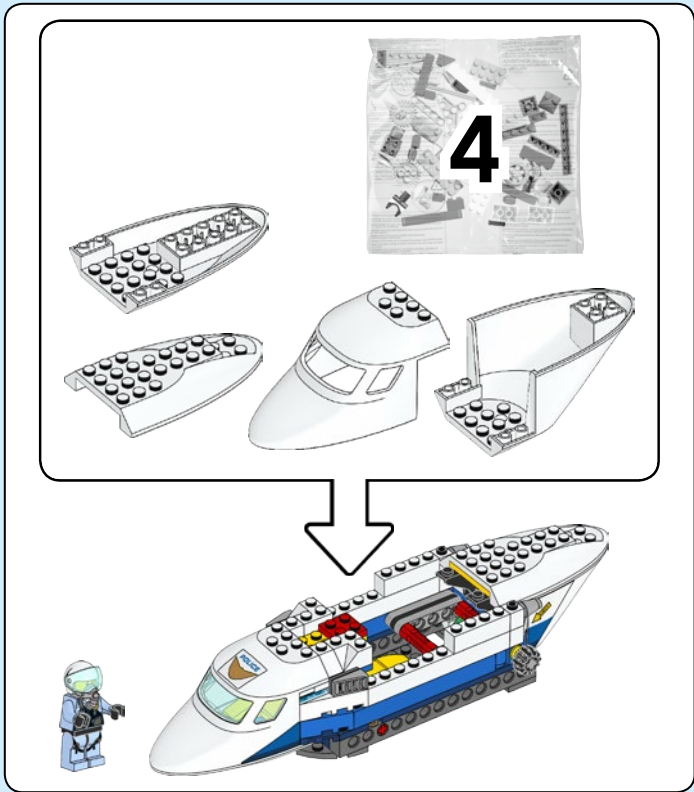

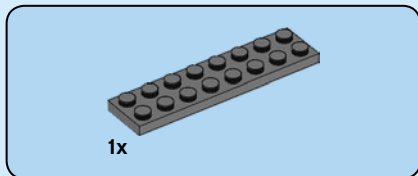

1

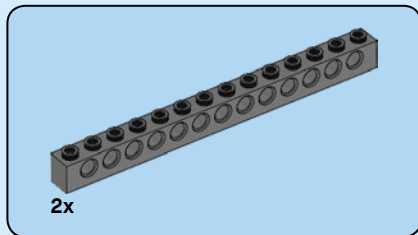
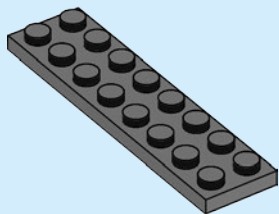

2

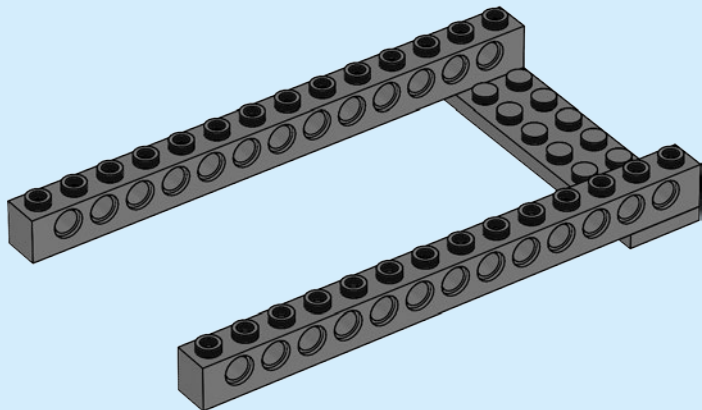

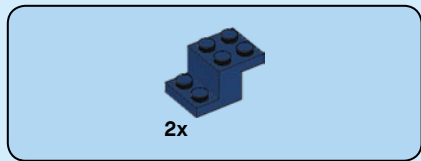

3

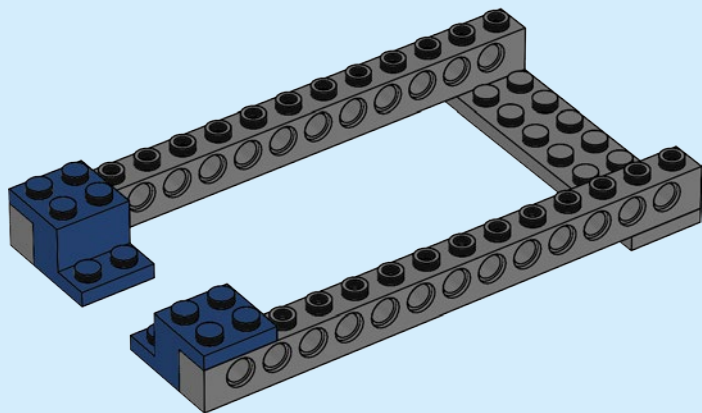

4

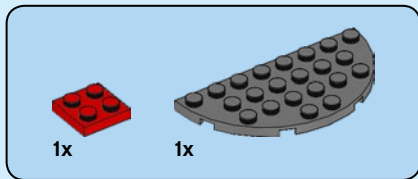

4

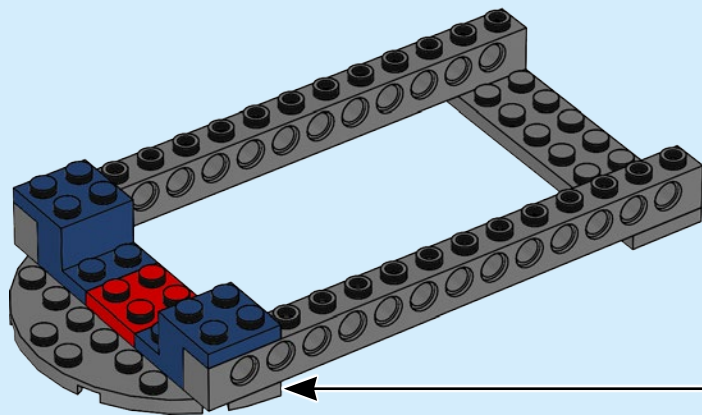
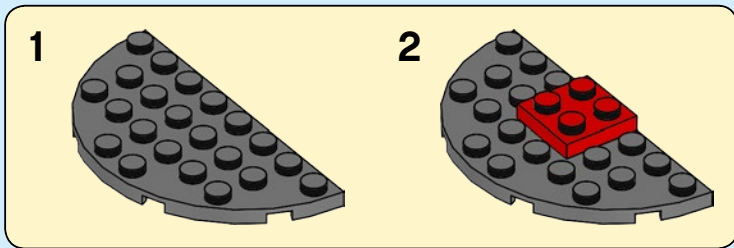

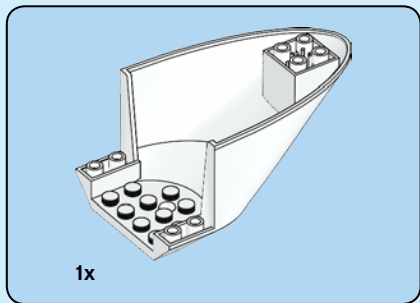

**5**

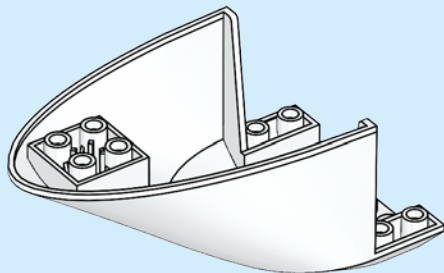

**6**

6

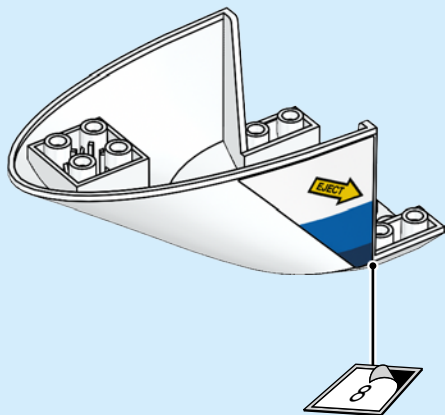

7

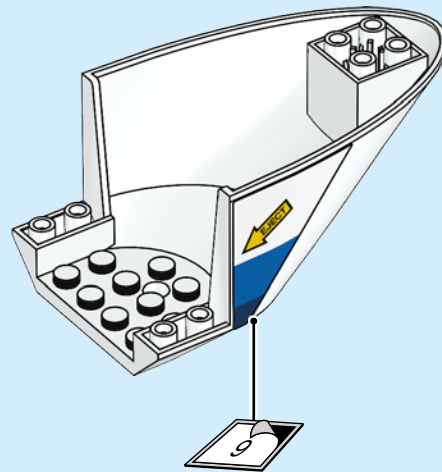
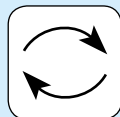

8

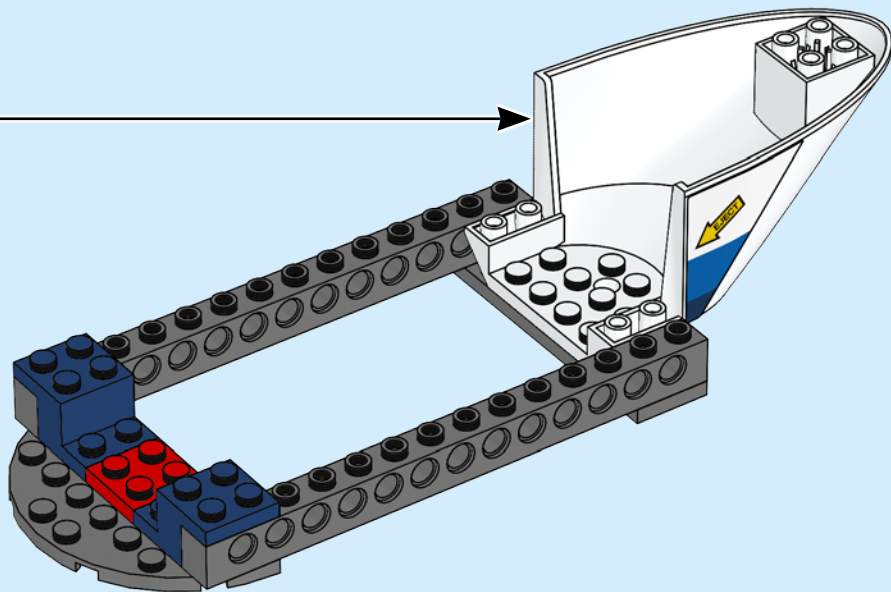



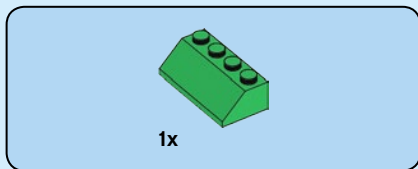

9

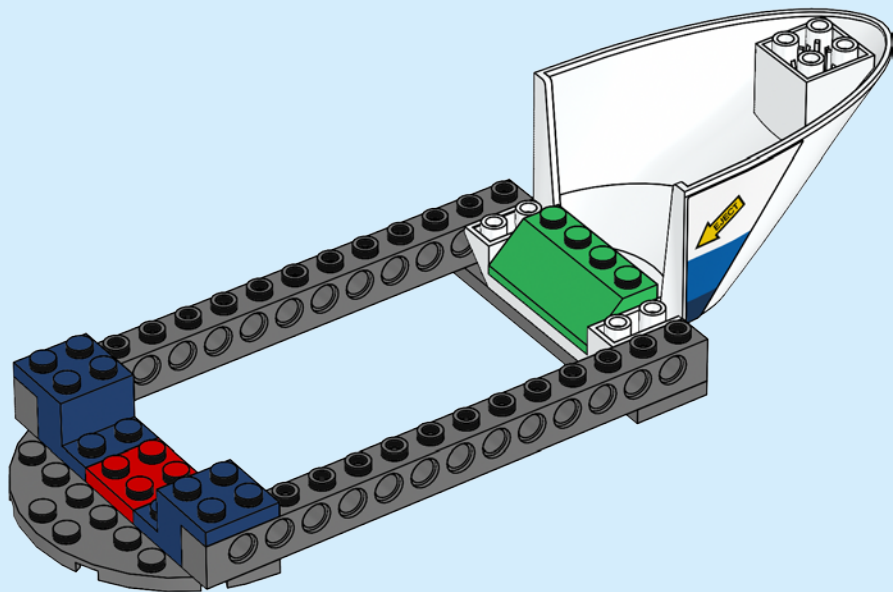



2x

10

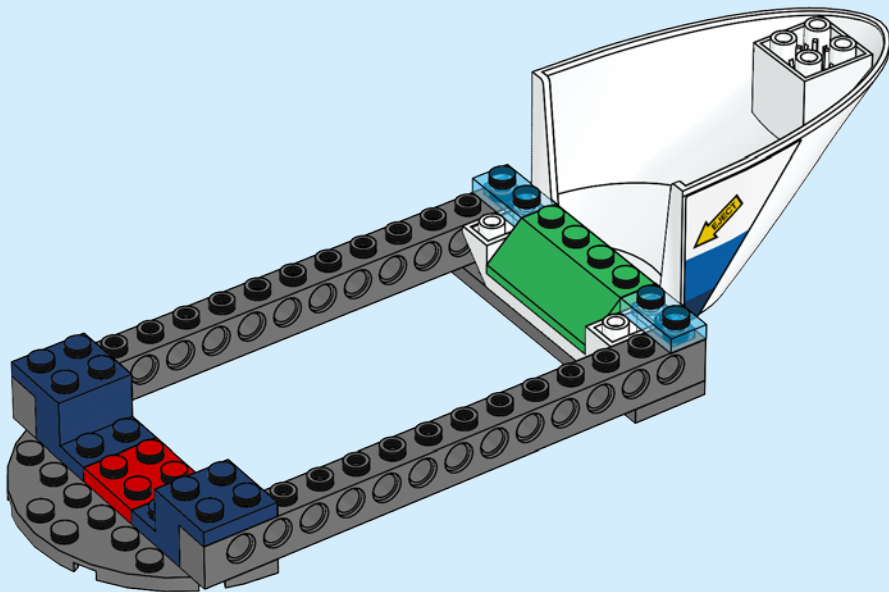

10

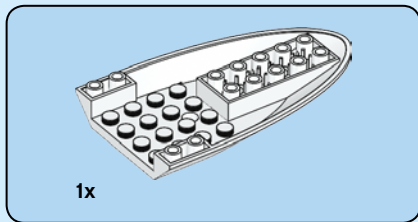

11

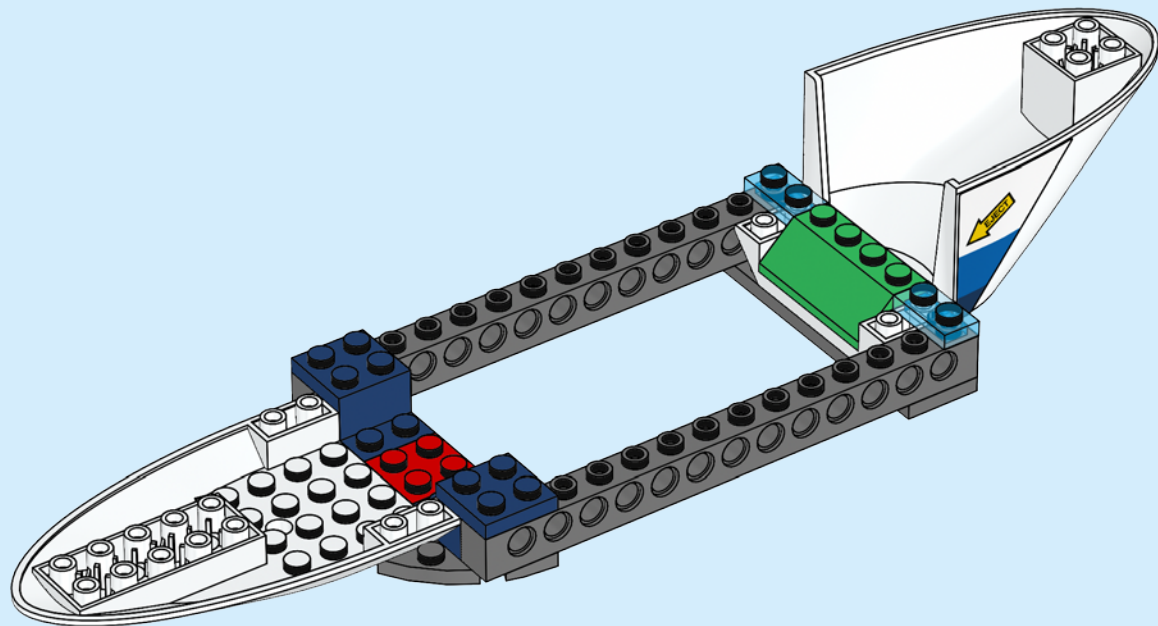



2x

12

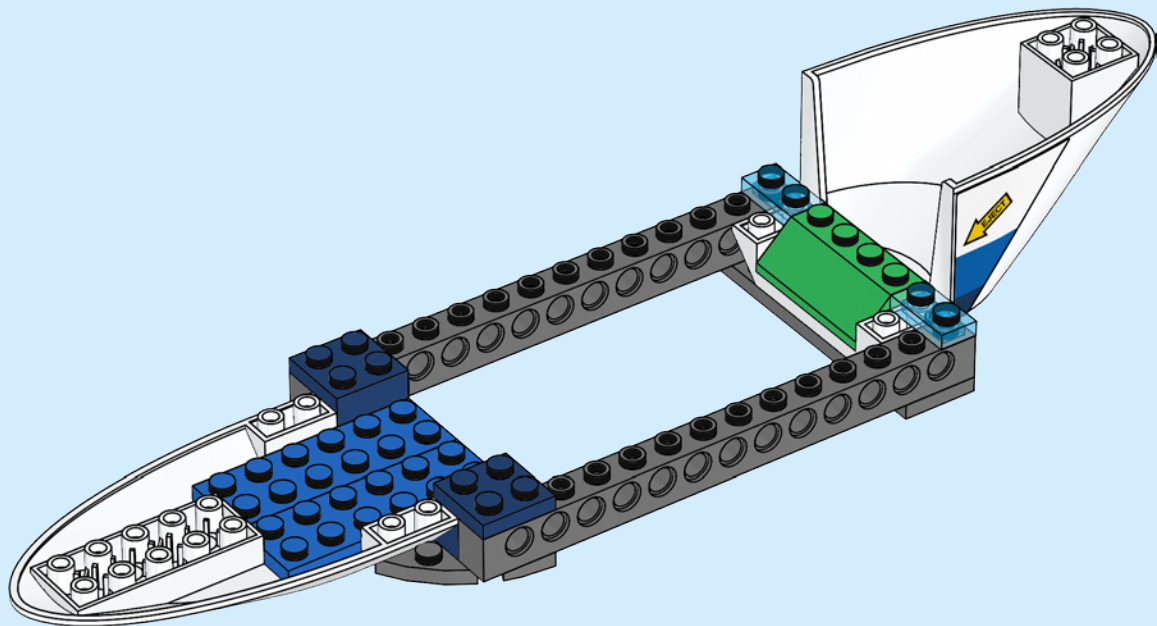

12

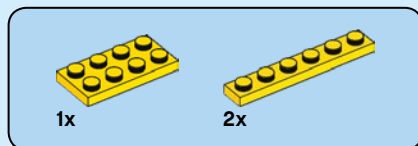

13

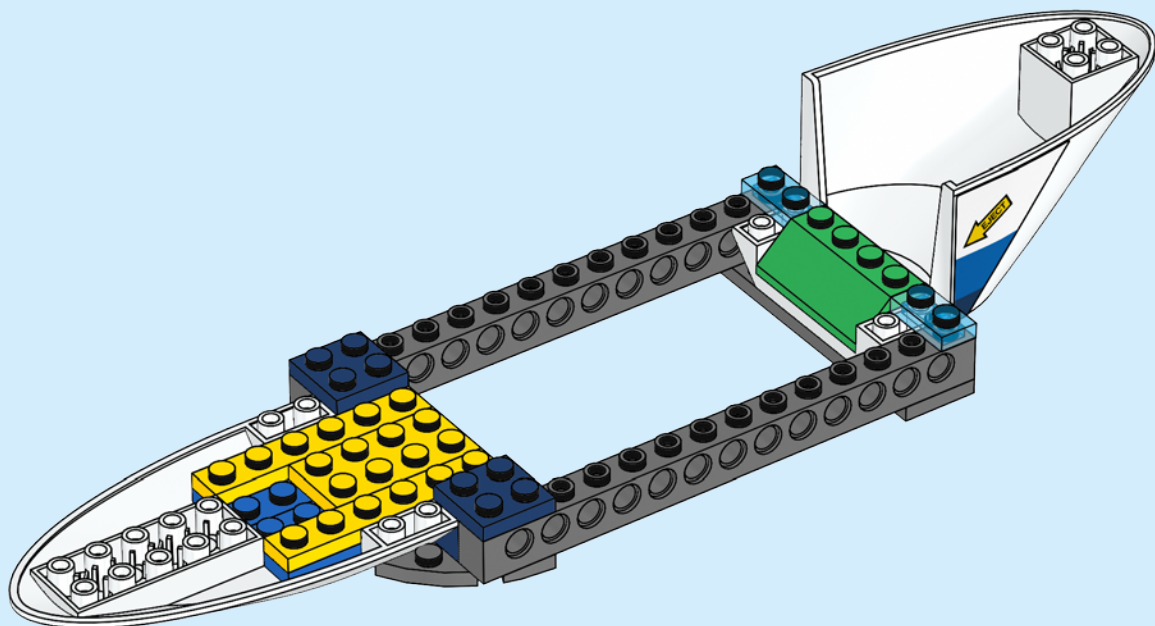



14

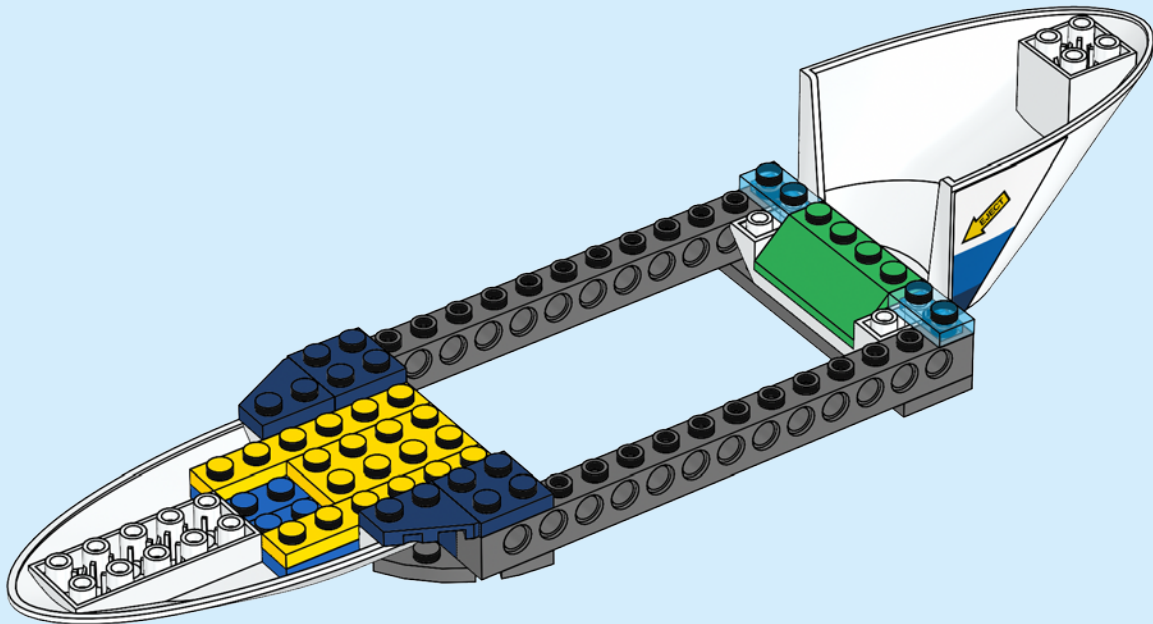



1x

15

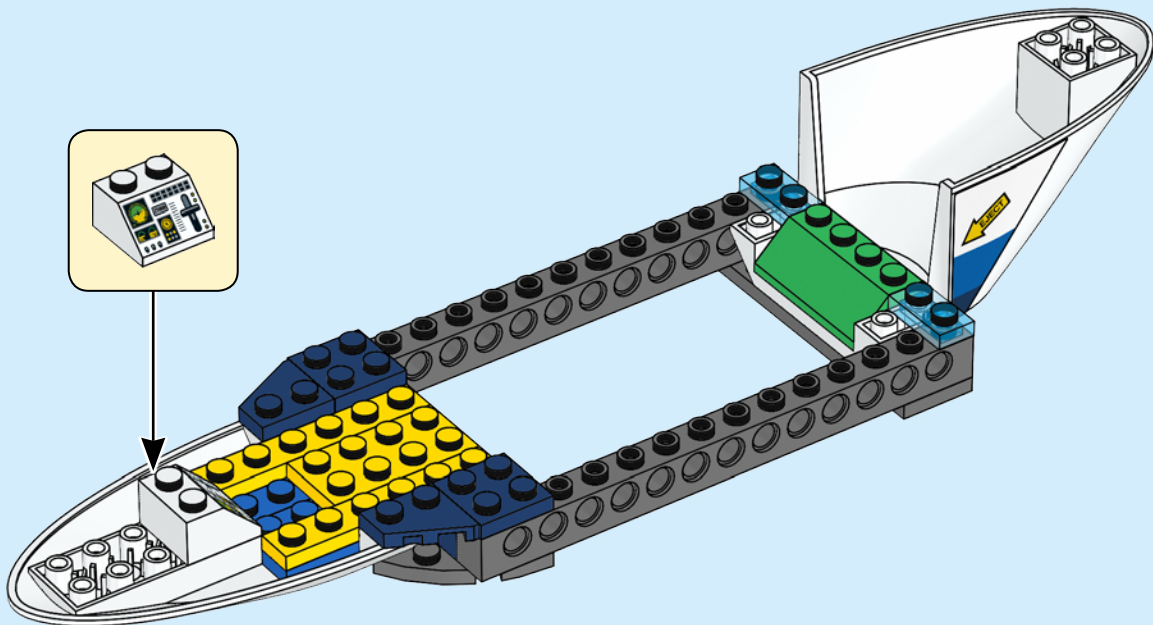

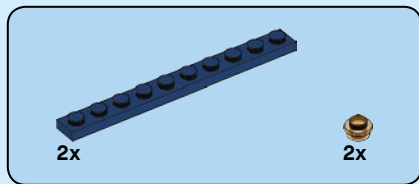

16

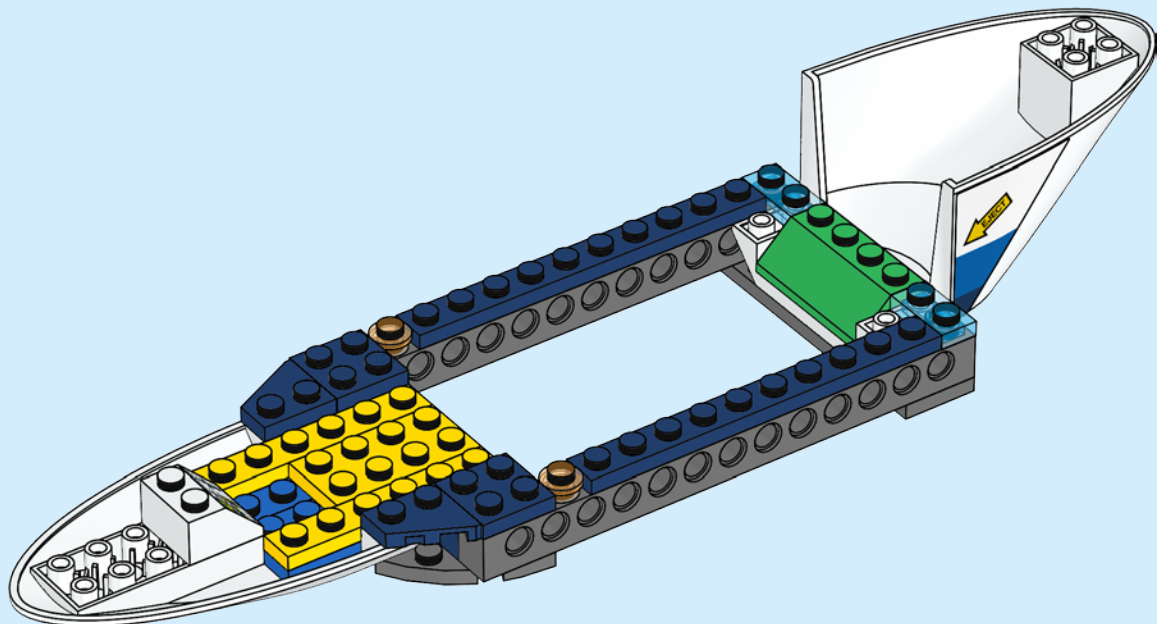





1x



2x

17

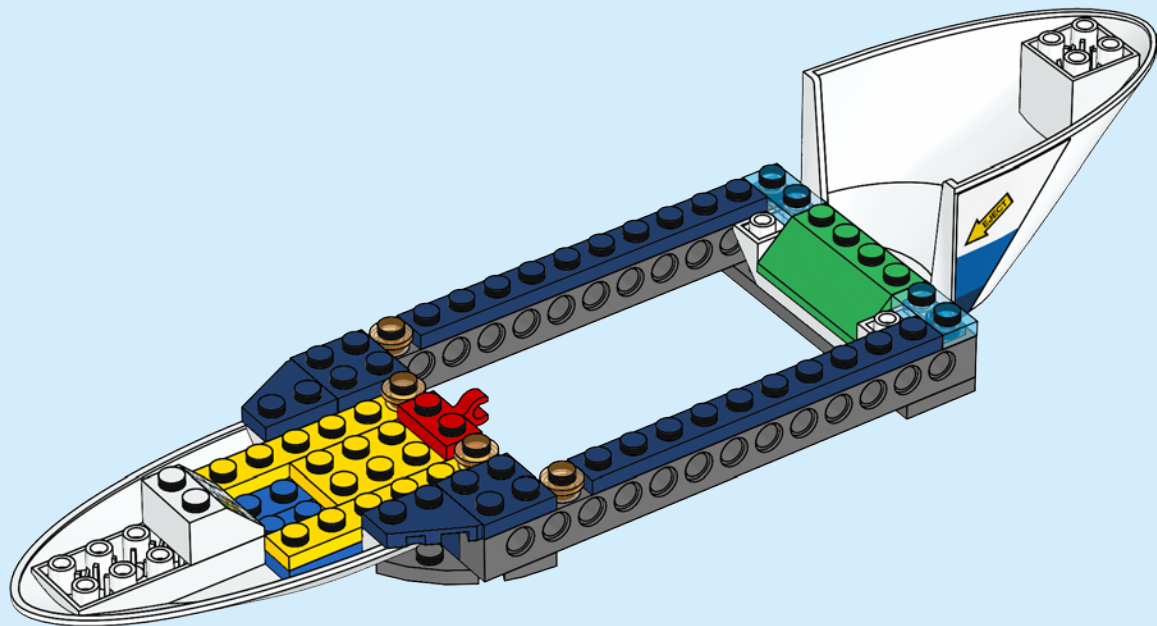

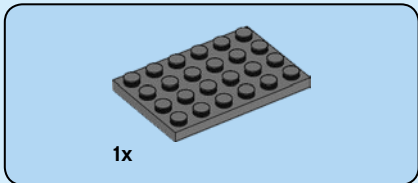
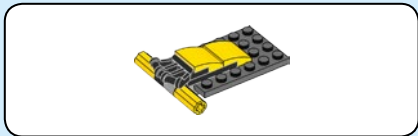

18

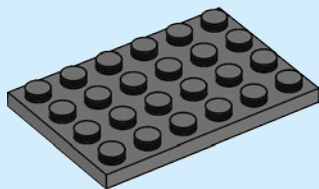

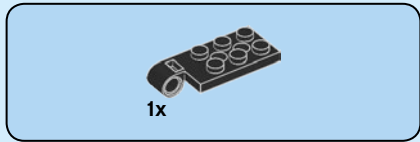

19

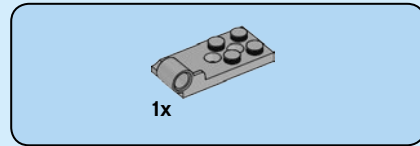
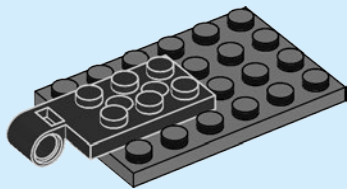

20

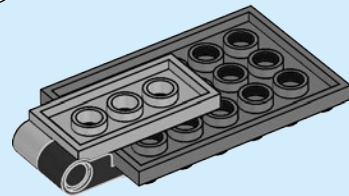
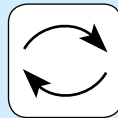



1x

21

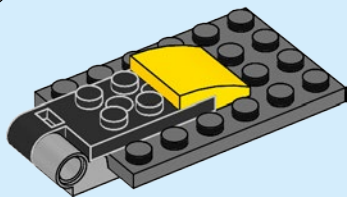
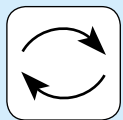

20

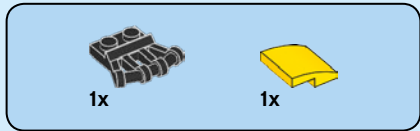

22

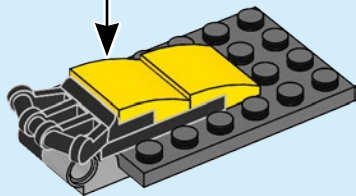

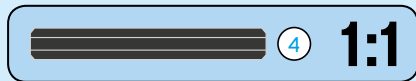
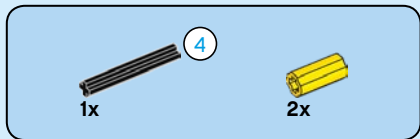

23

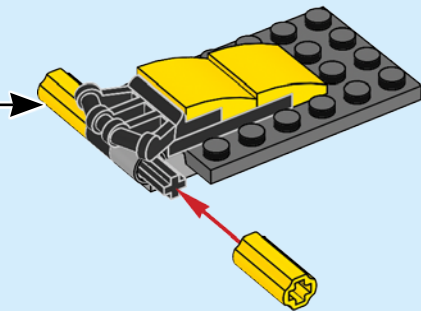
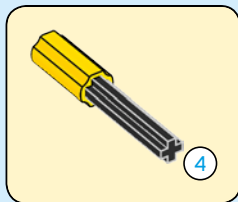

22

24

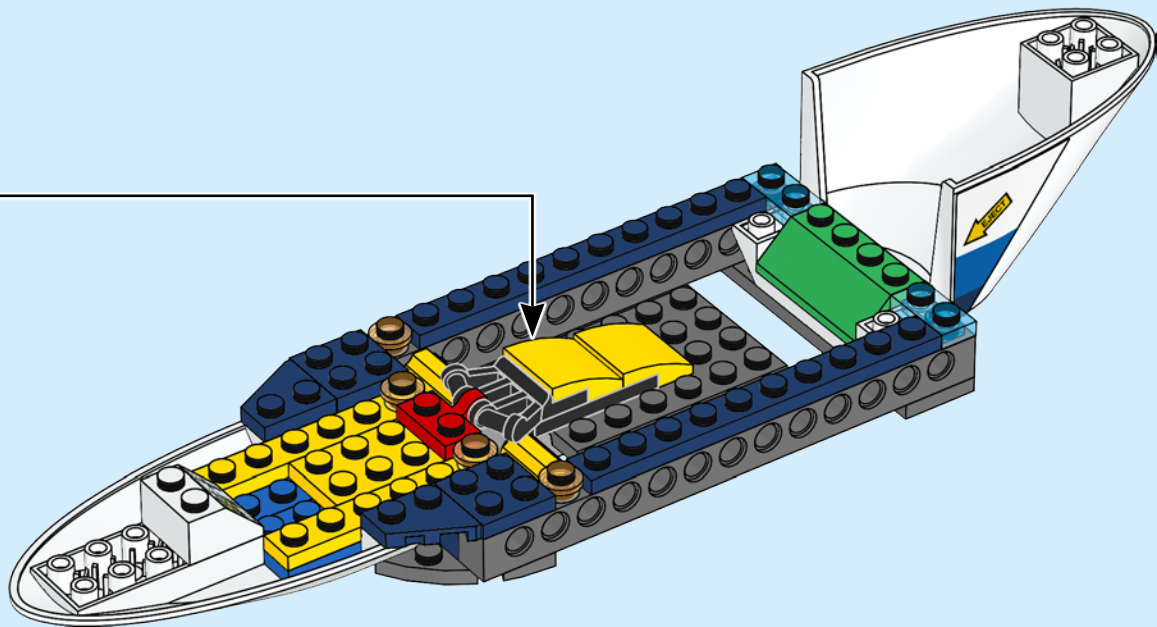



2x

25

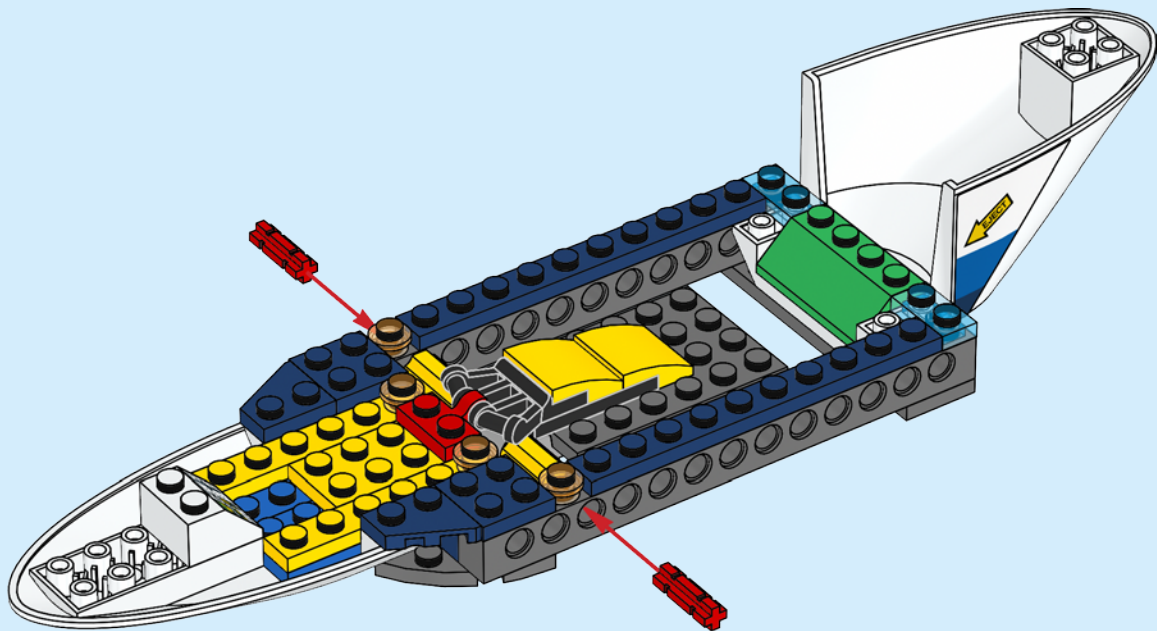

24



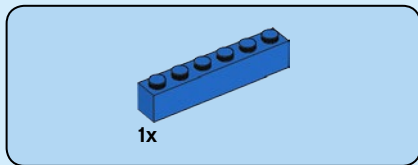

26

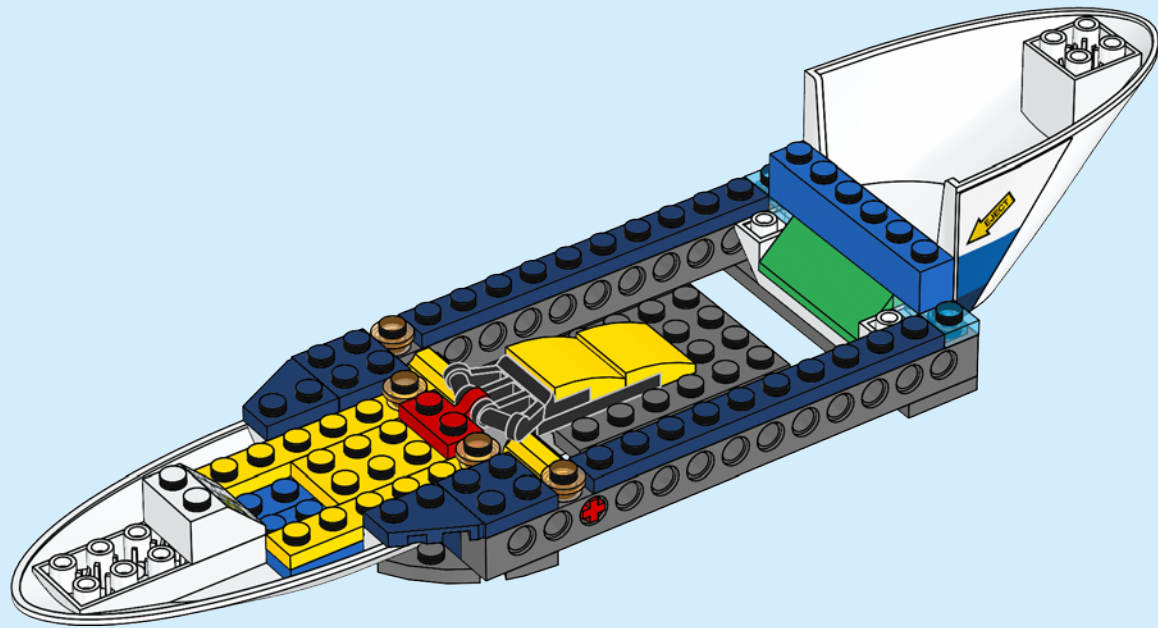

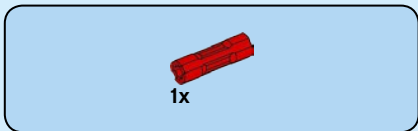
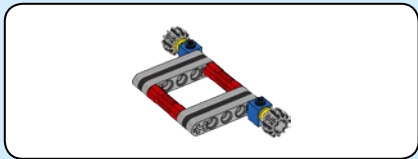

27



26

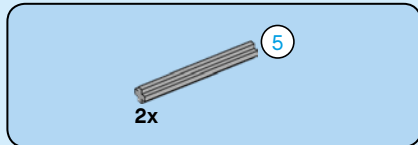

28

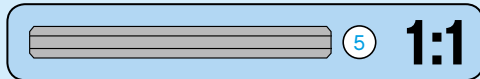
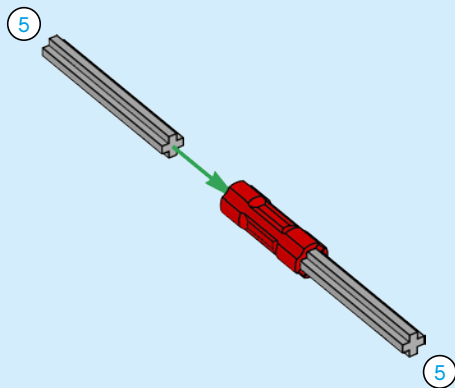

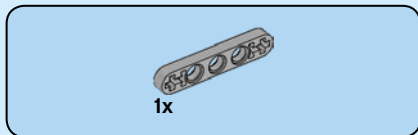

29

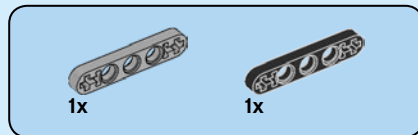
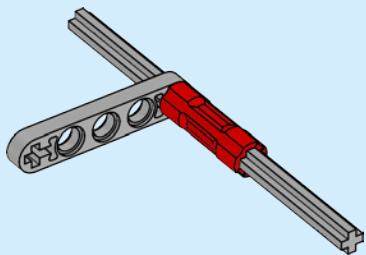

30

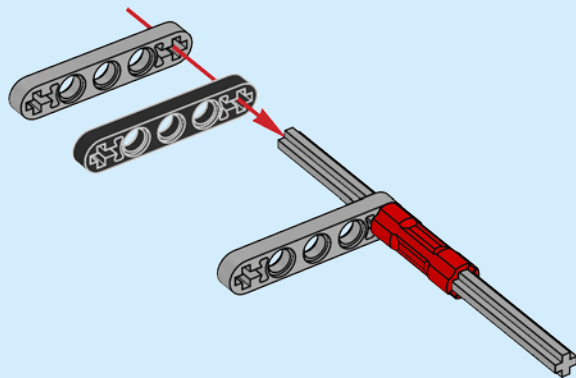



1x



1x

# 31

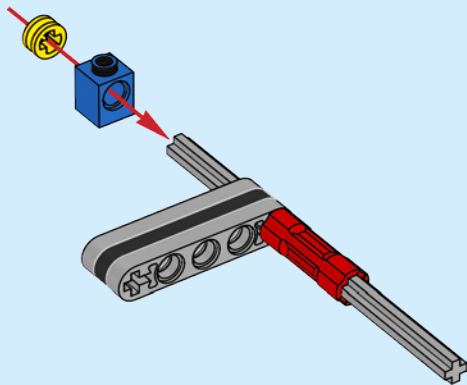

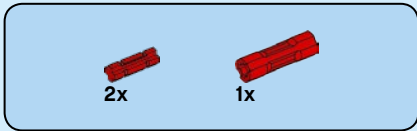

32

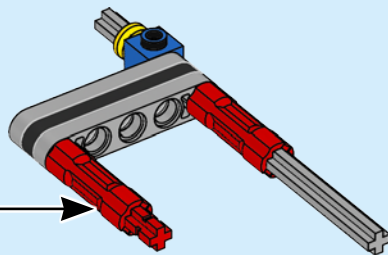
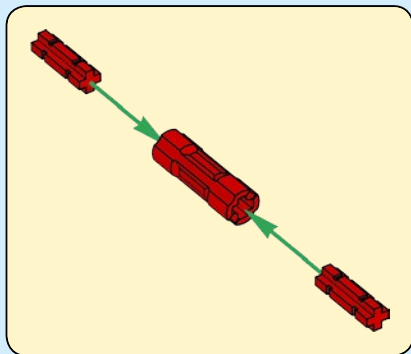

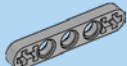

1x

33

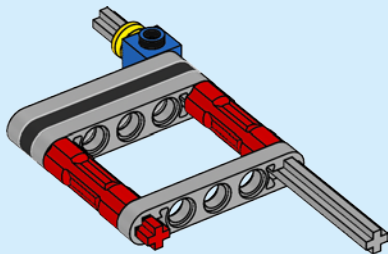

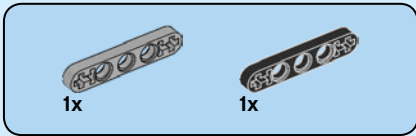

34

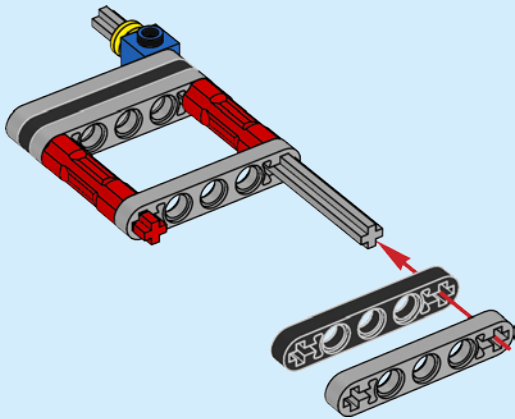

35

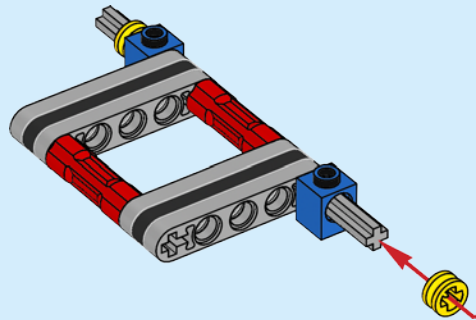



2x

36

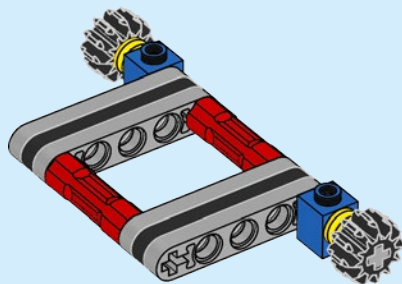



37

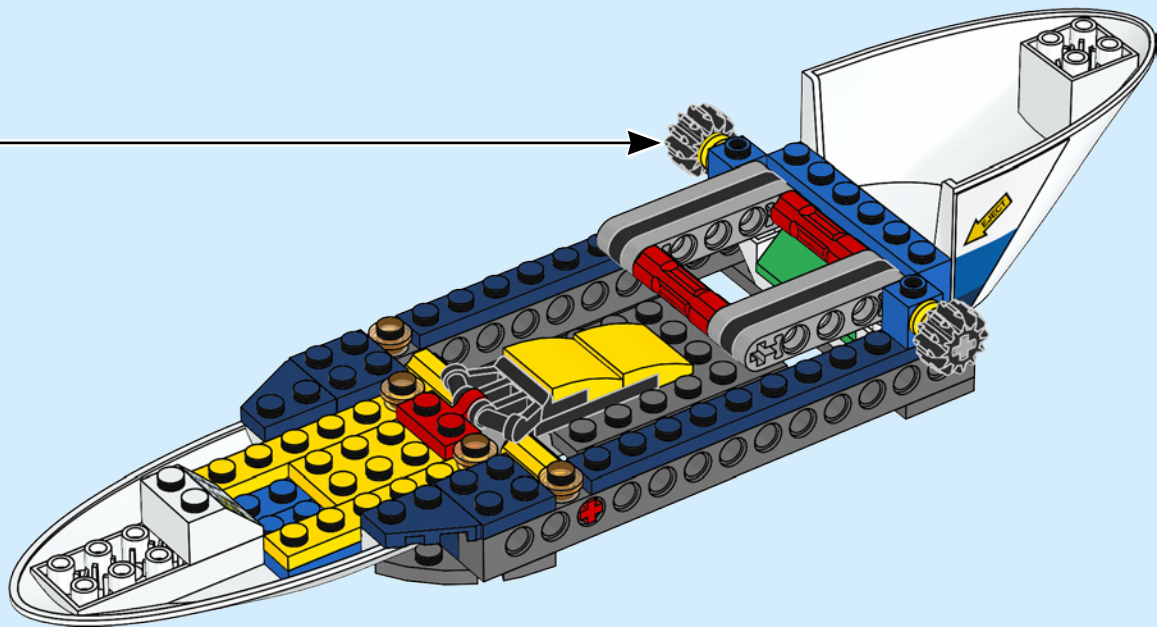

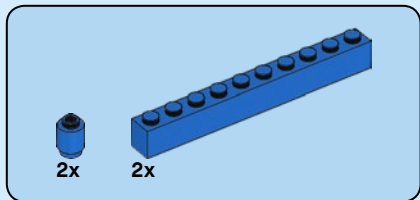

38

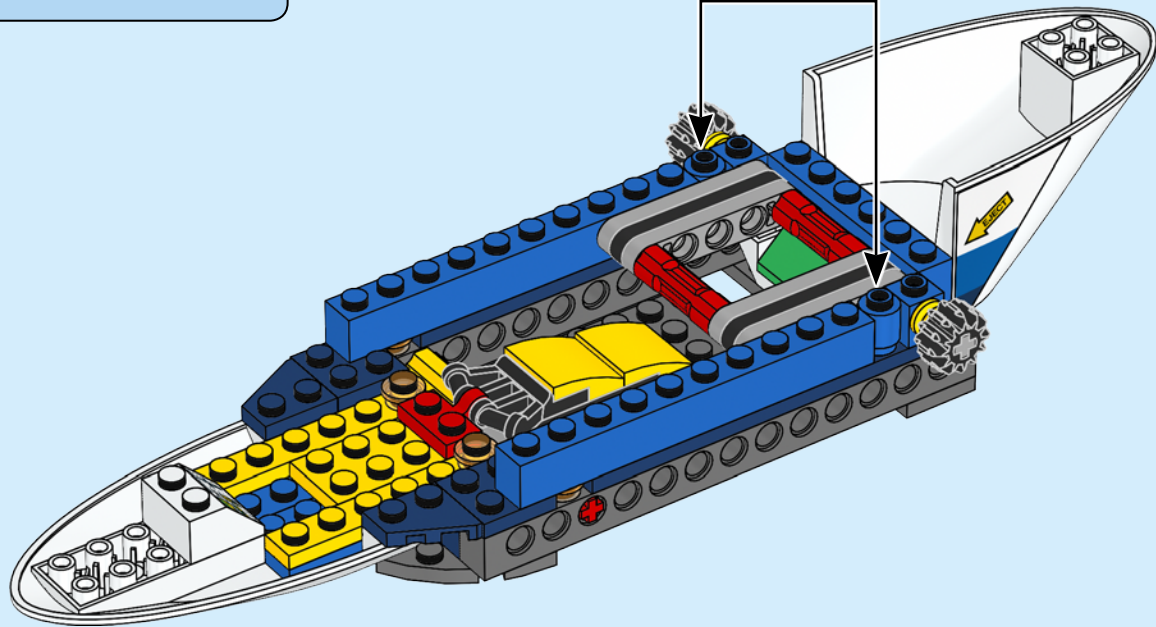
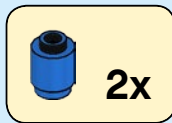

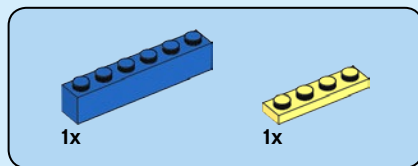

39

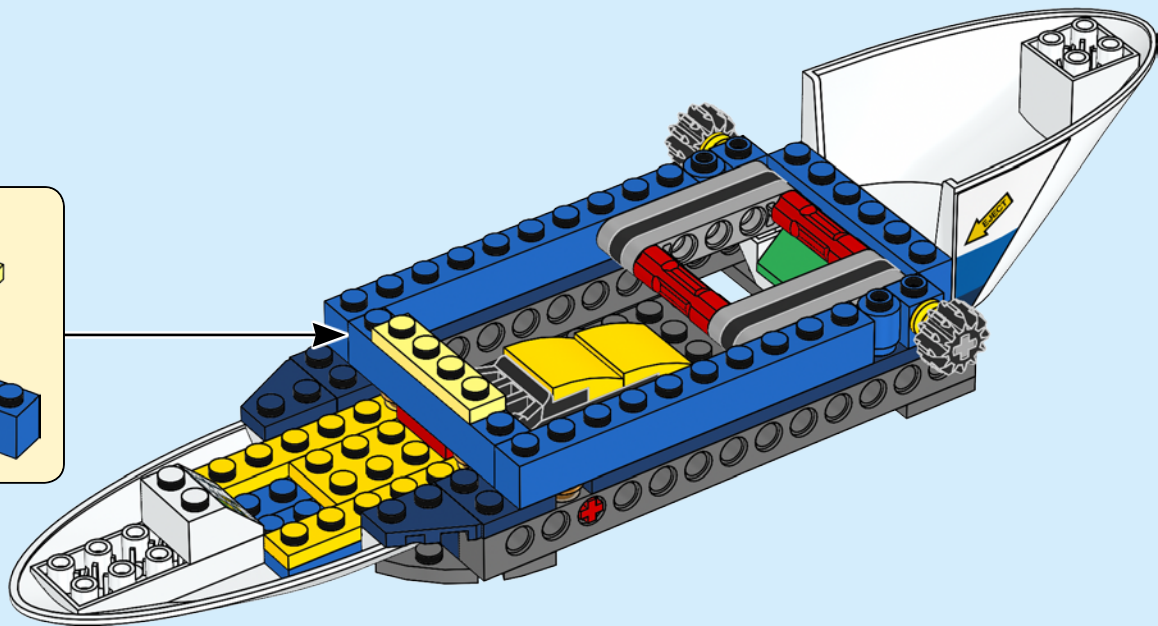
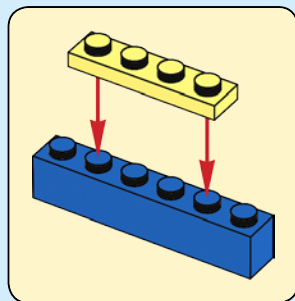

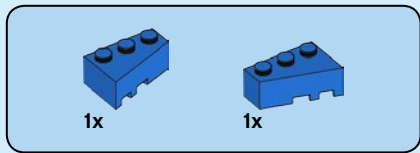

40

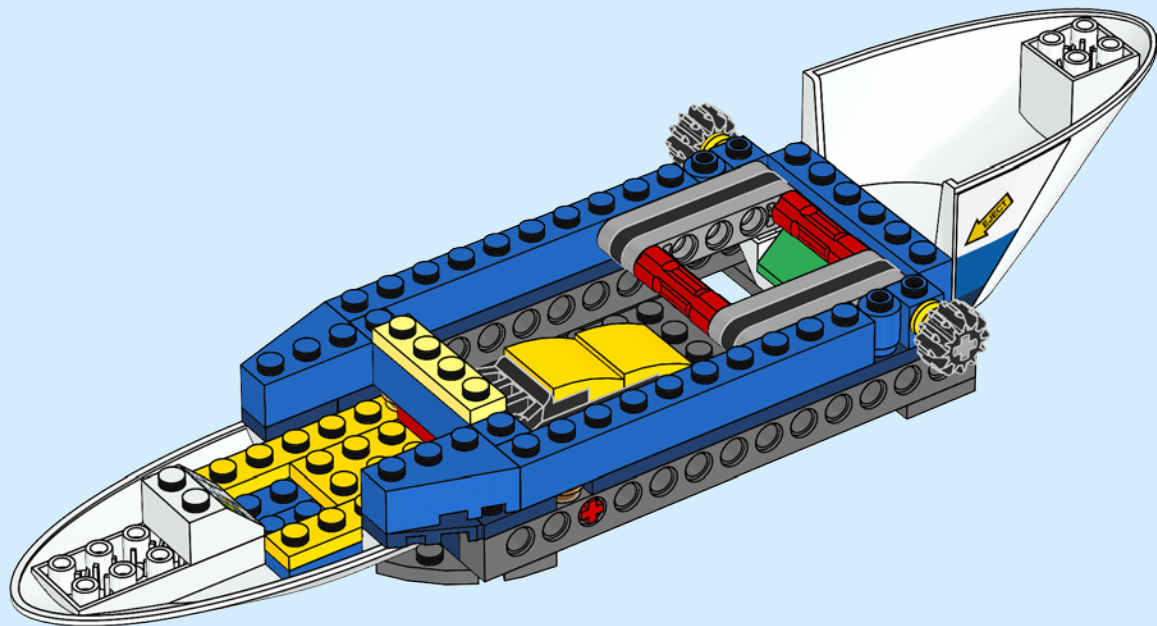

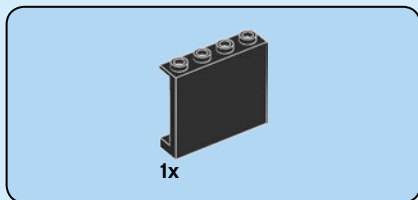

41

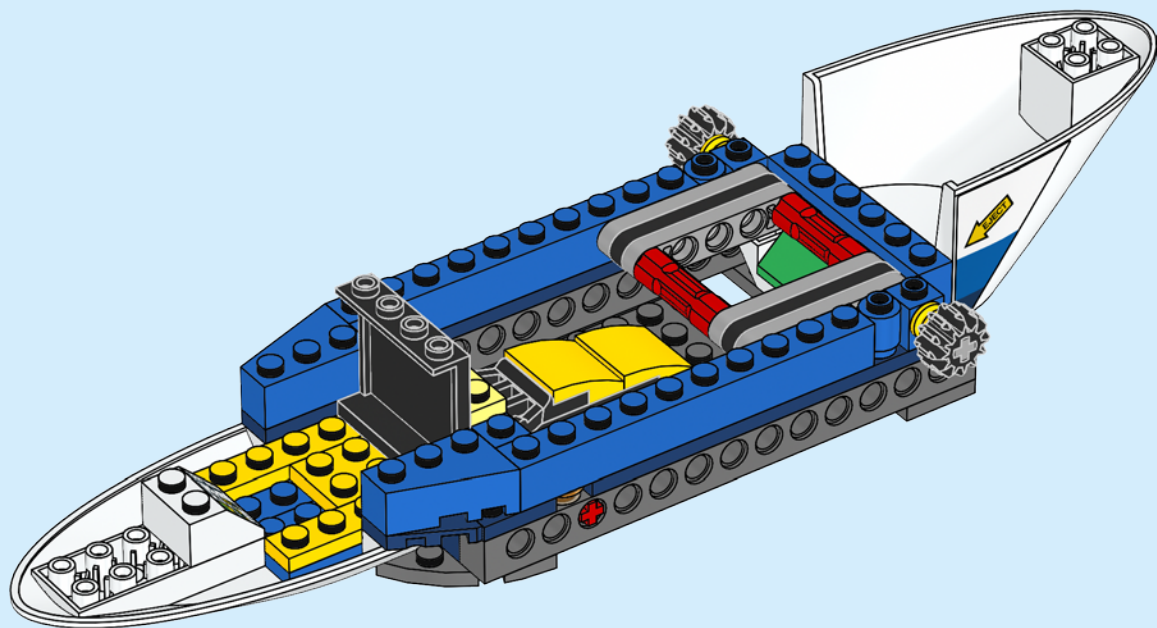



1x

42

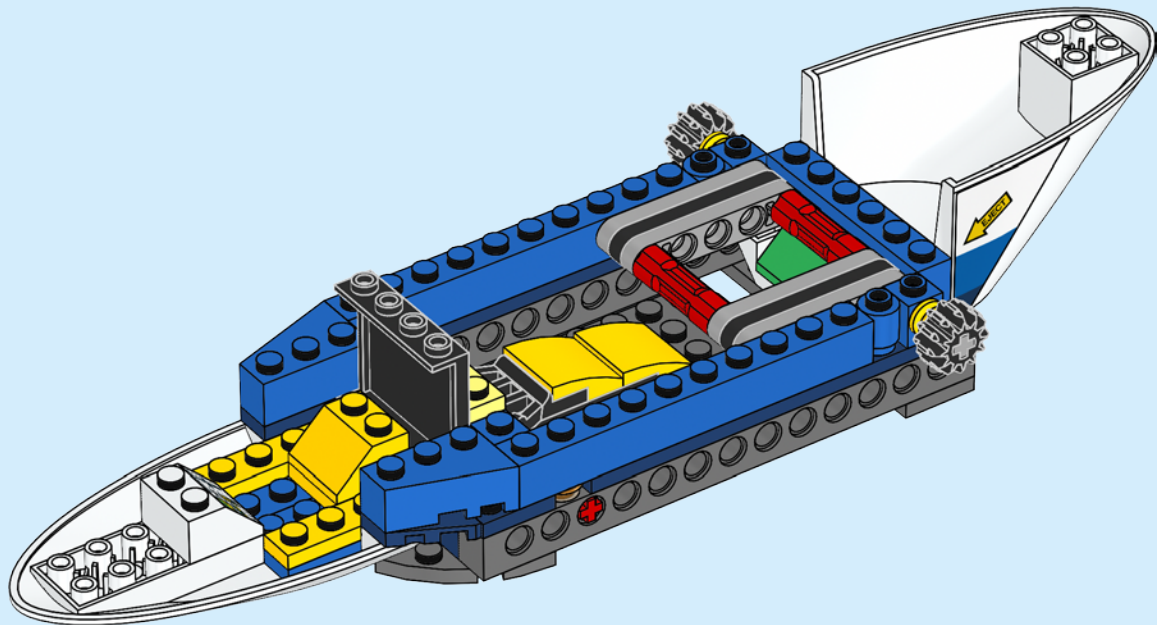



2x

43

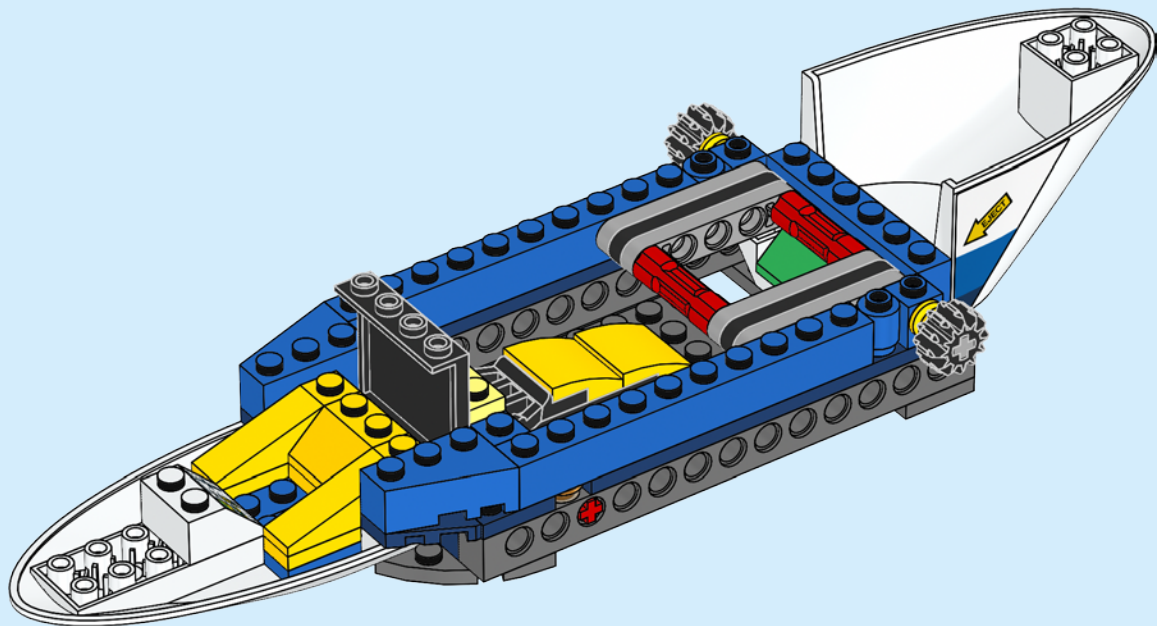



1x

44

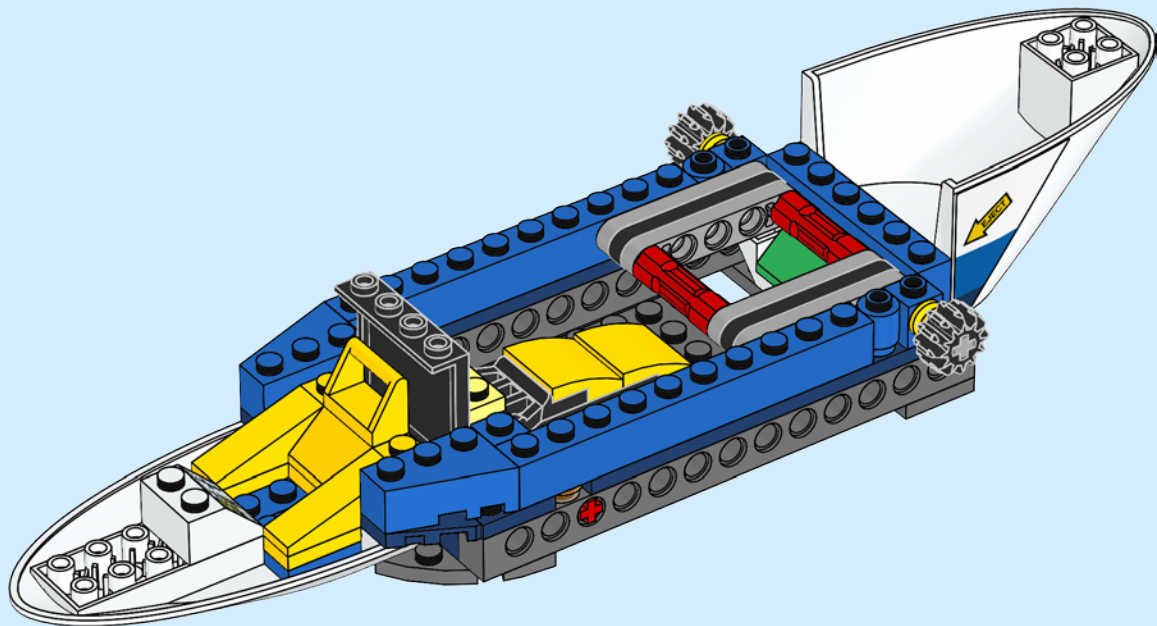





2x

45

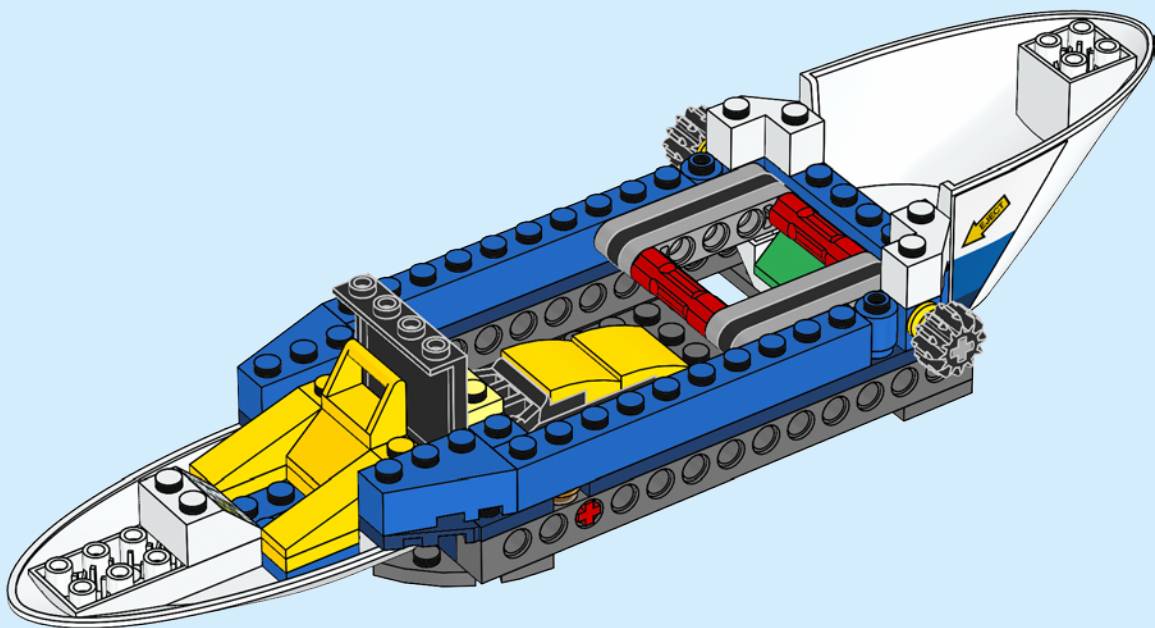



1x

46

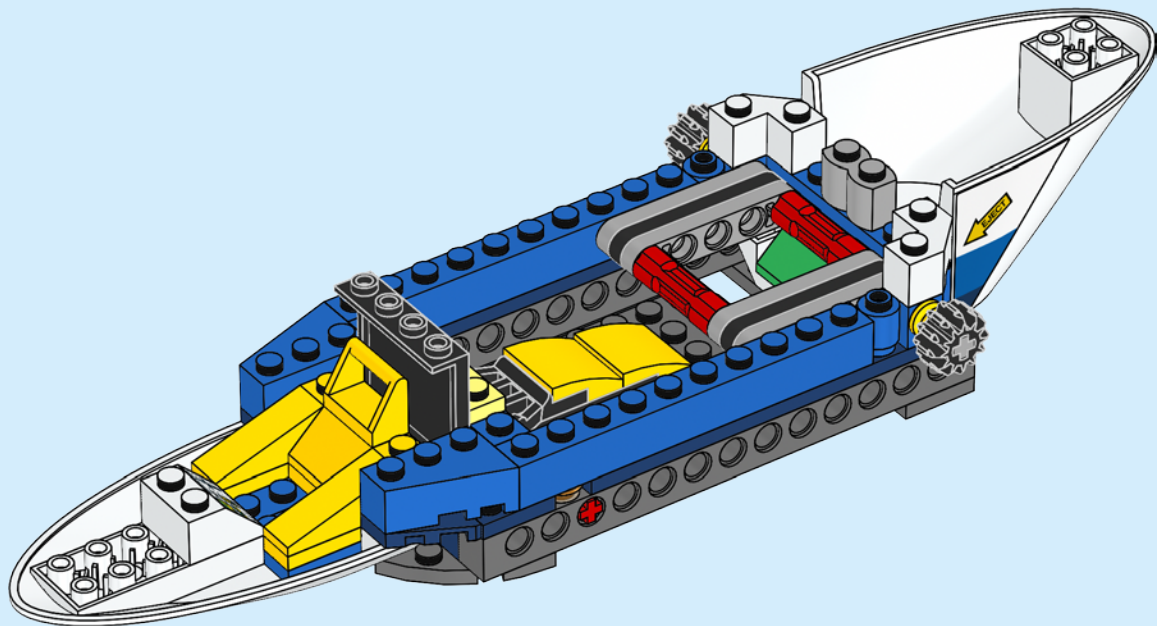

42

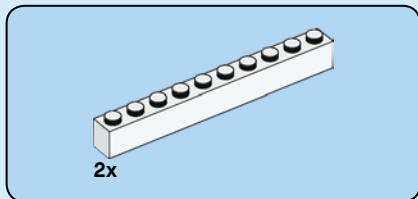

47

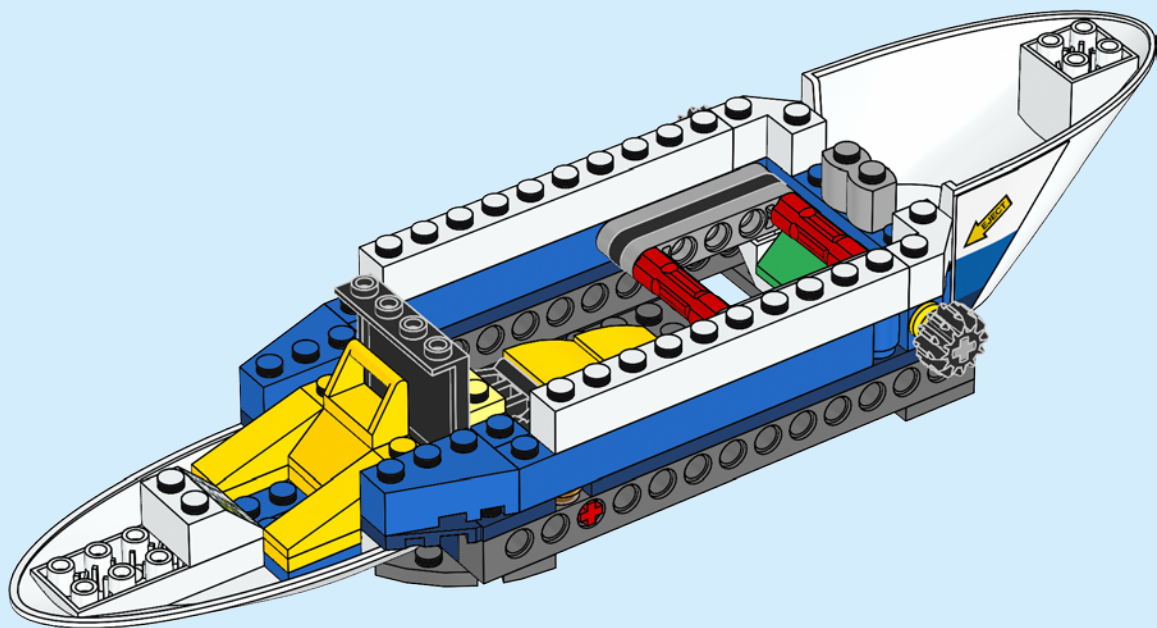



2x

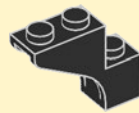

2x

48

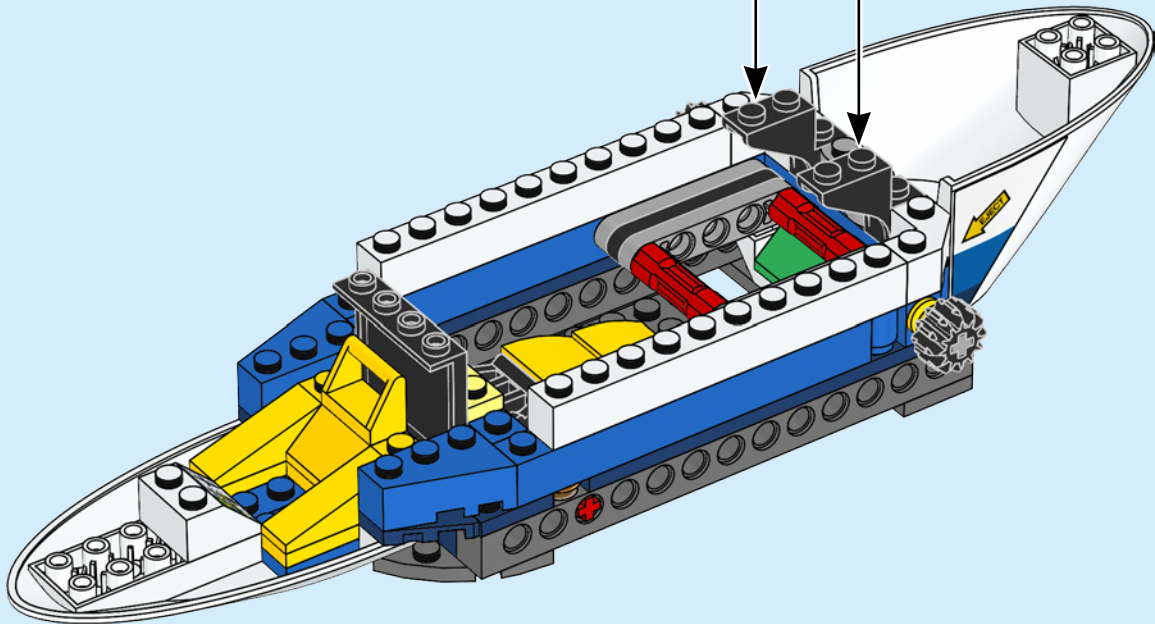

44

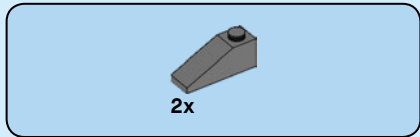

49

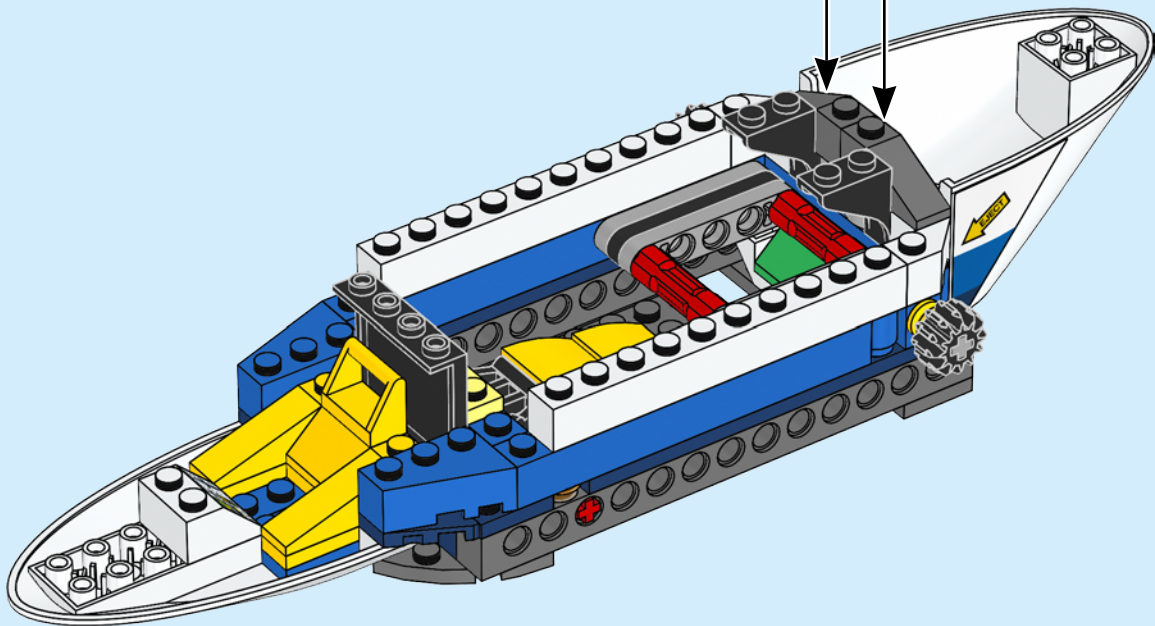
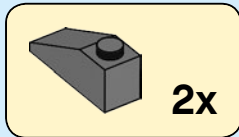

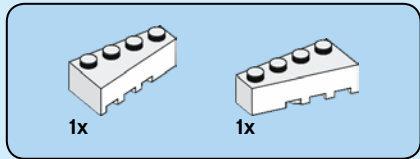

50

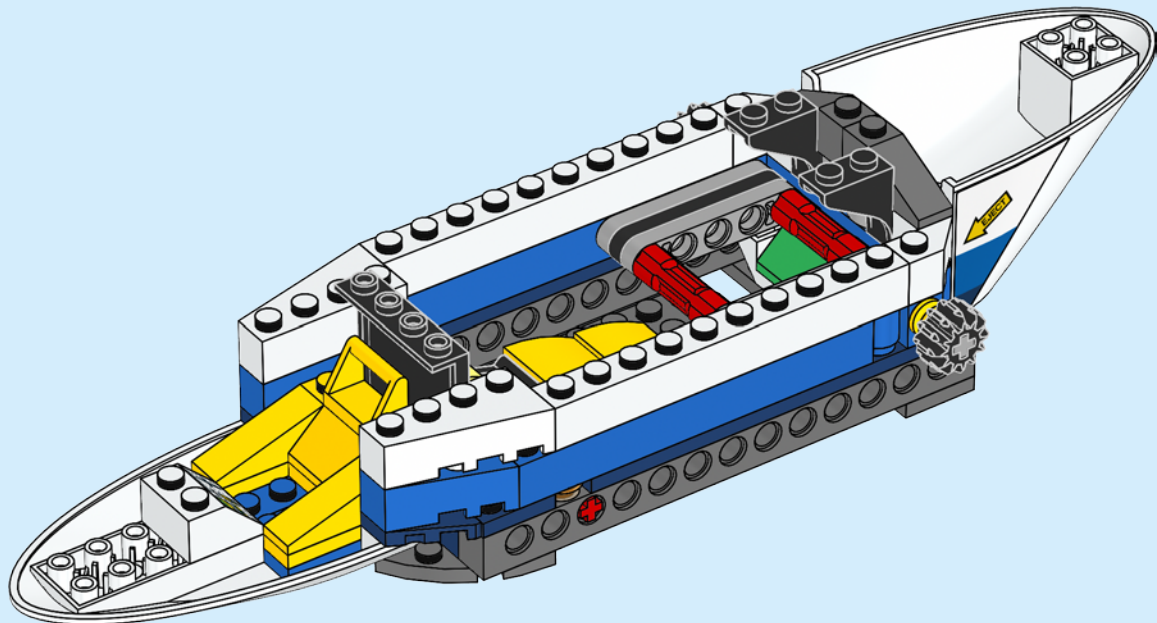



1x

51

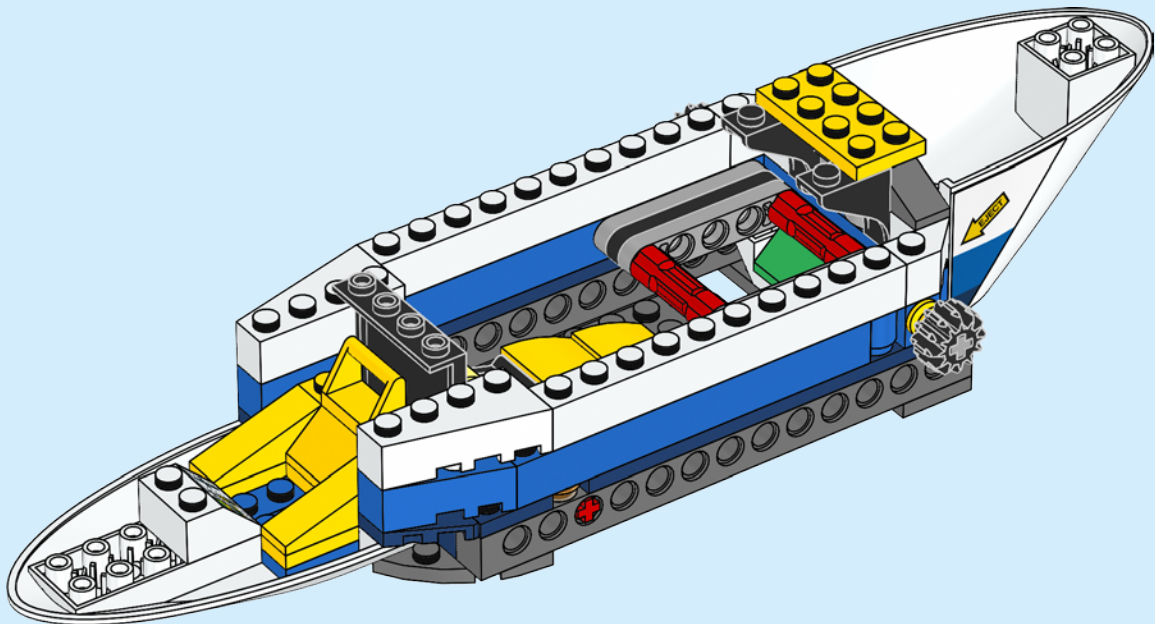

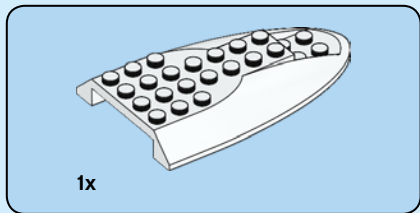

52

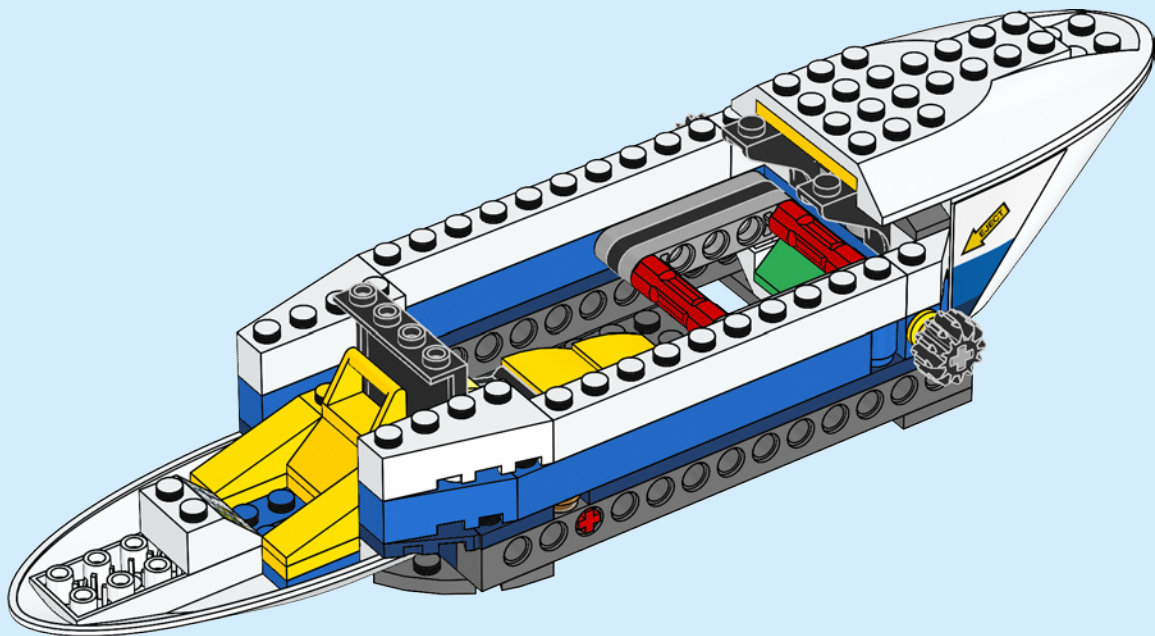



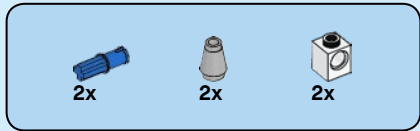

53

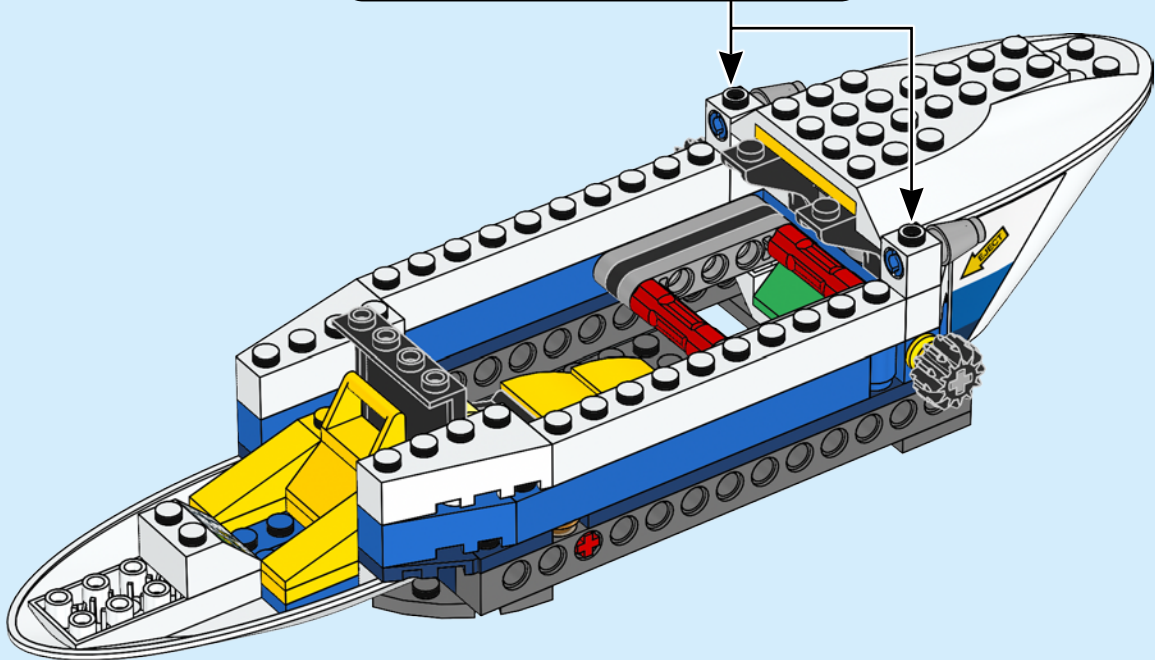
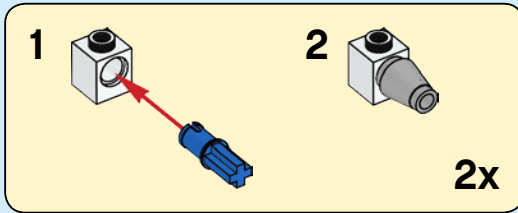

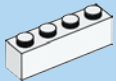

2x

54

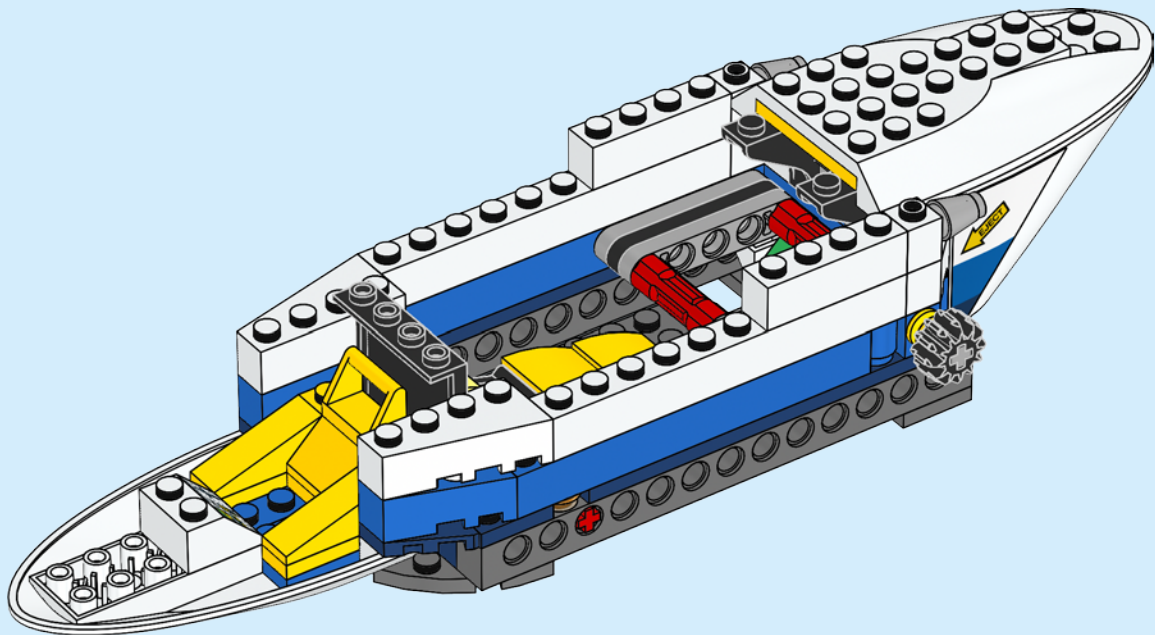

50



55

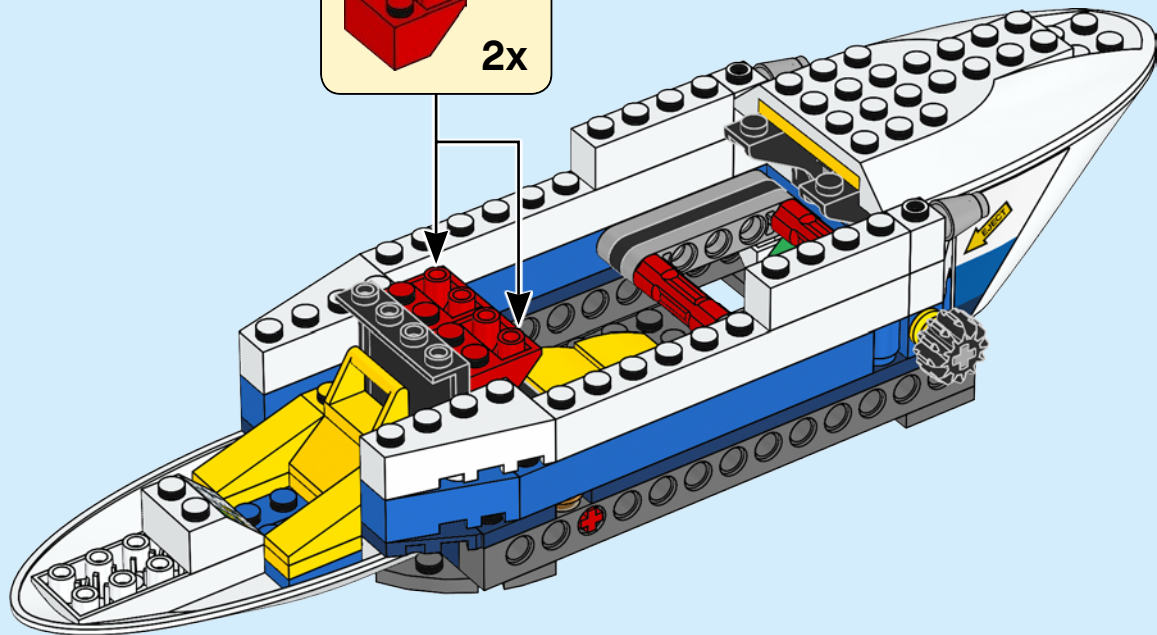
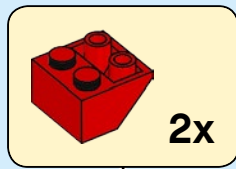



2x



2x

# 56



2x

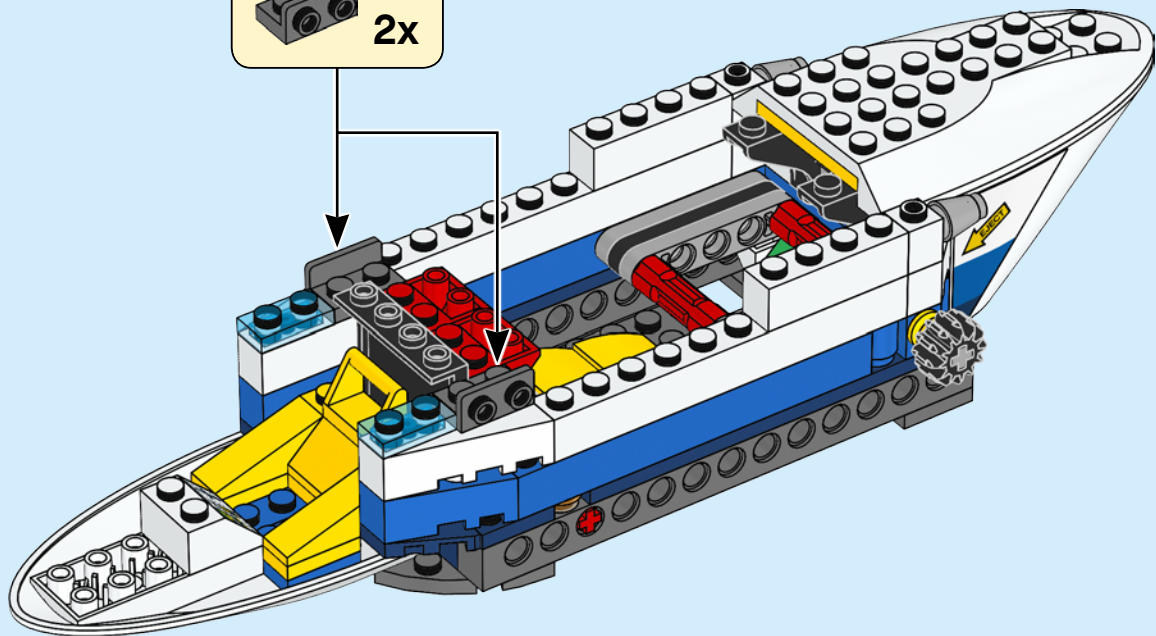



2x

57

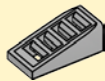

2x

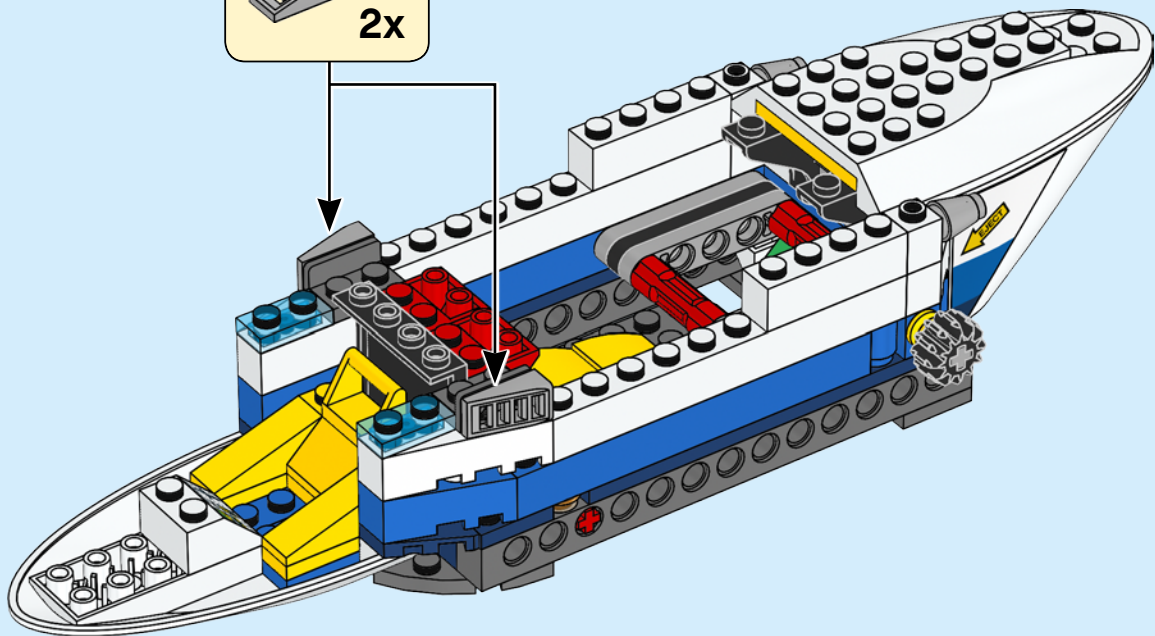



2x



2x

58

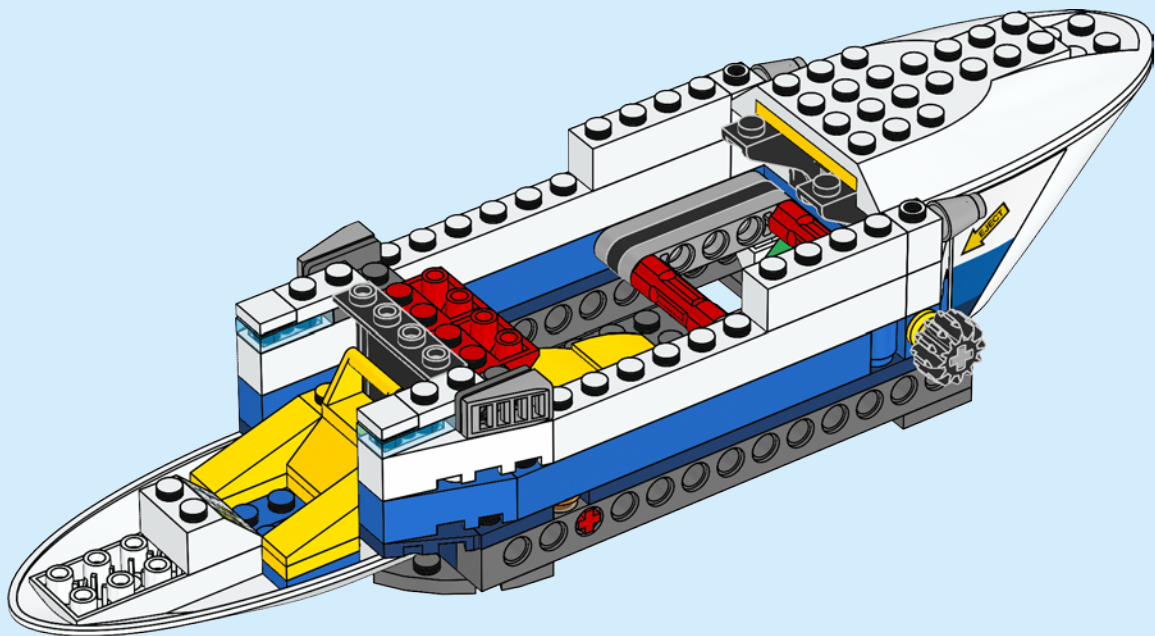

54

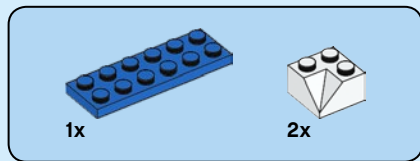

59

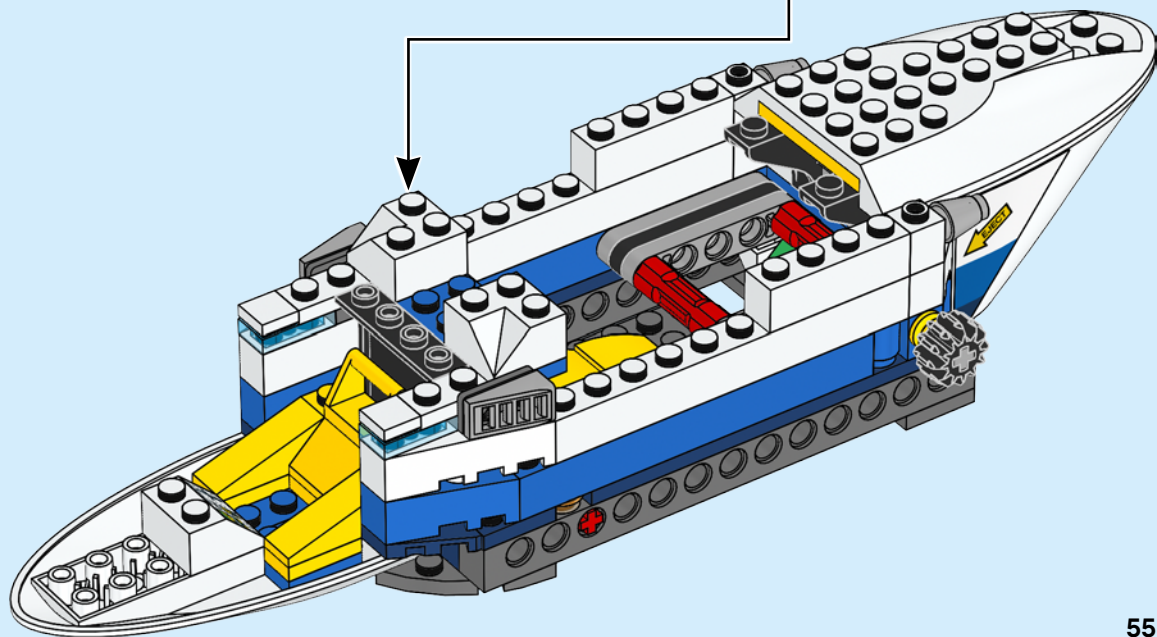
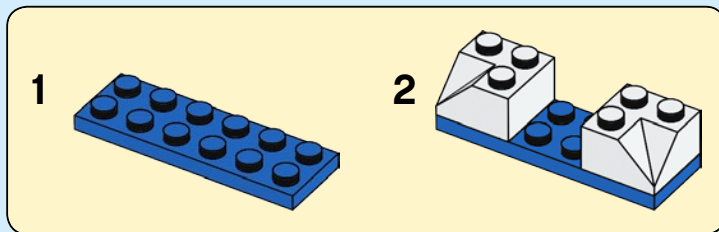



2x

60

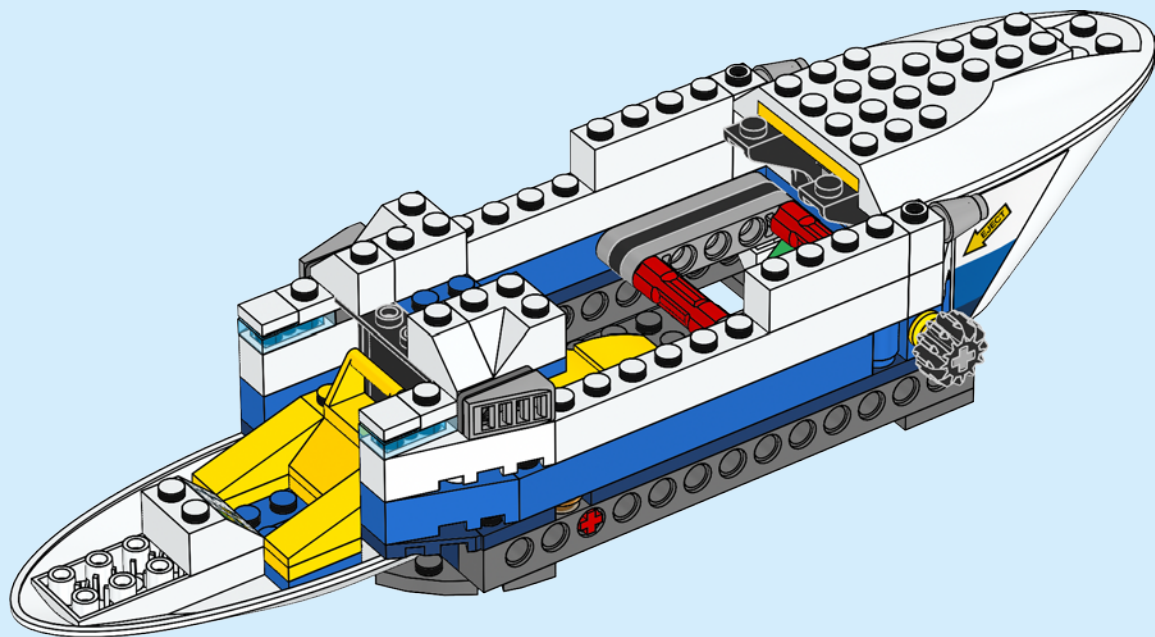

56



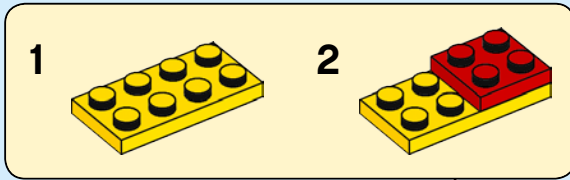

61

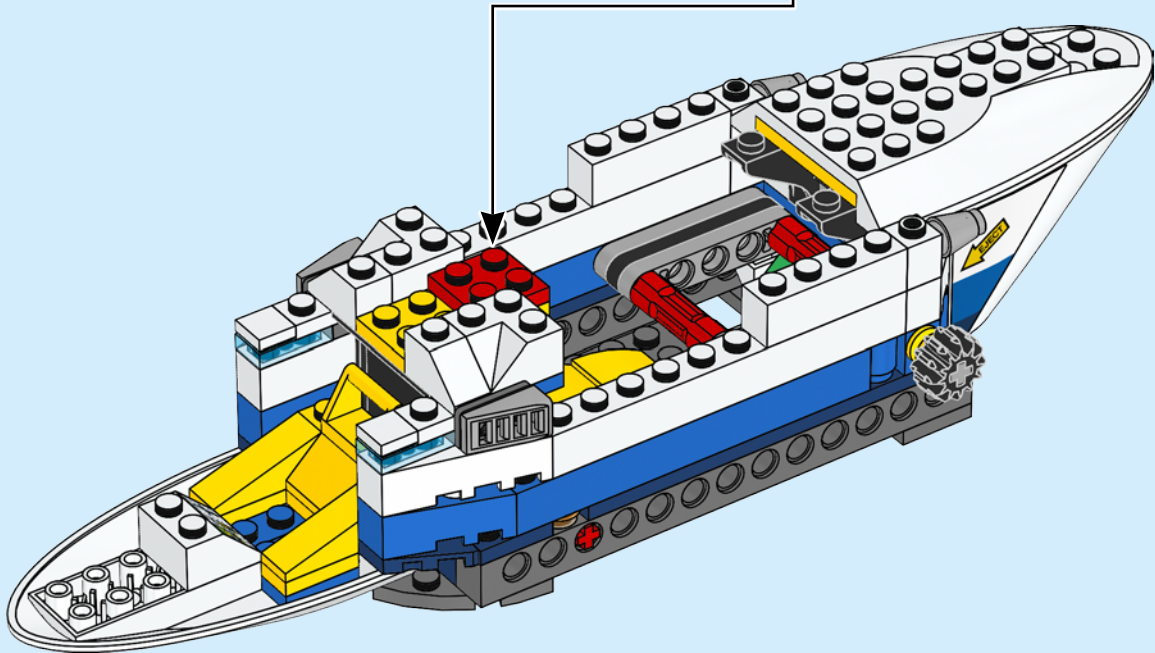

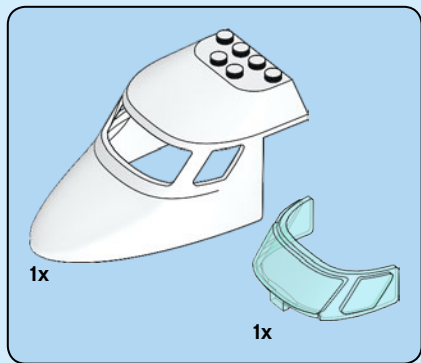

62

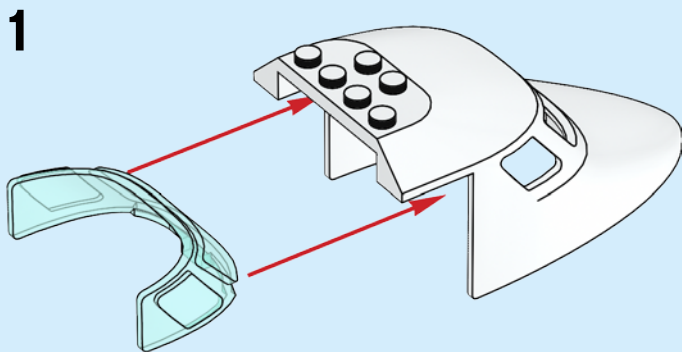

2

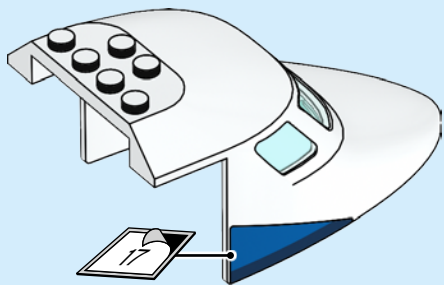

3

