



CITY

60273







- 1** Scan the code on the front cover
Scanne den Code auf der Titelseite
Scanne le code sur la page de couverture
Scanner le code sur la page couverture
Scansiona il codice sulla copertina
Escanea el código de la portada
Faz scan do código na frente da capa
Olvasd be a borítón látható kódot!
Noskenë kodu uz priekšējā vāka
扫描封面上的二维码



- 2** Get Instructions PLUS
Hol dir Instructions PLUS
Obtiens les instructions PLUS
Obtenir les Instructions PLUS
Scarica Instructions PLUS
Descubre Instructions PLUS
Obtém Instruções PLUS
Szerezd be az Instructions PLUS kiegészítőt!
Saņem "Instructions PLUS"
获取更多说明

LEGO.com/apps

Check for compatibility
Kompatibilität prüfen
Vérifier la compatibilité
Controlla la compatibilità
Comprueba tu compatibilidad

Verificar a compatibilidade
Ellenőrizd a kompatibilitást
Pārbaudīt saderību
检查兼容性

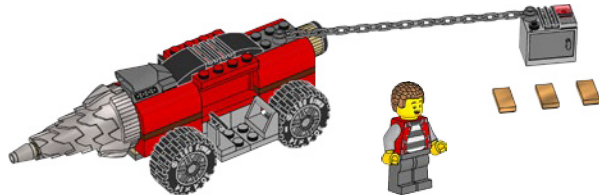
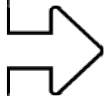

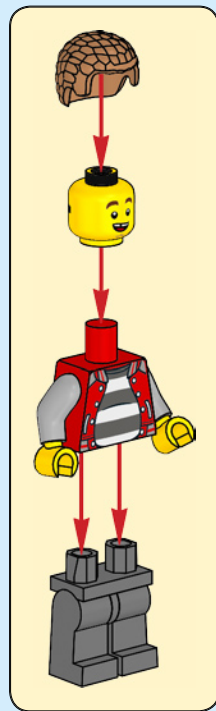

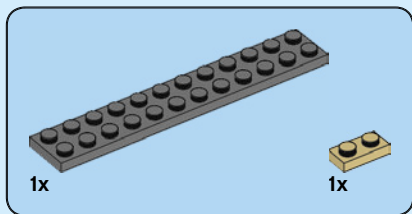
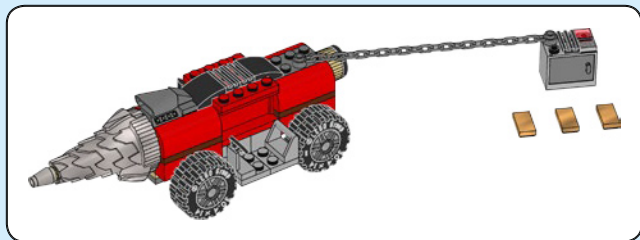

1

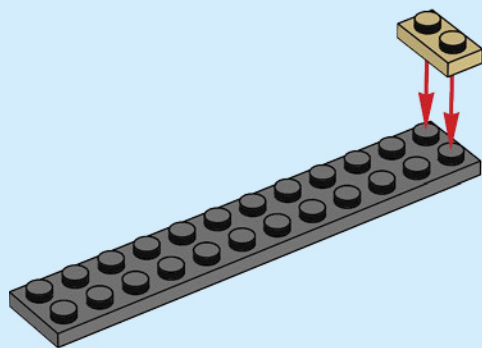

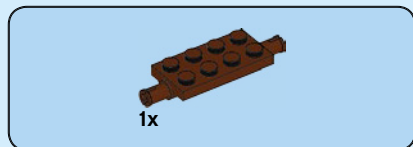

2

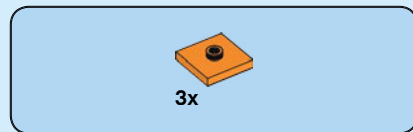
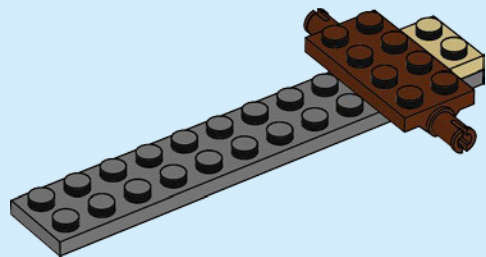

3

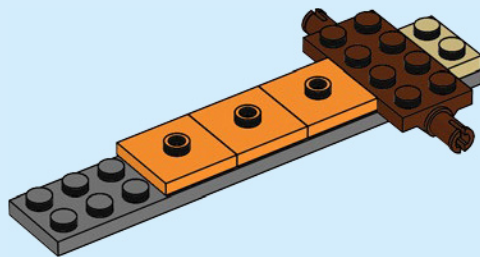

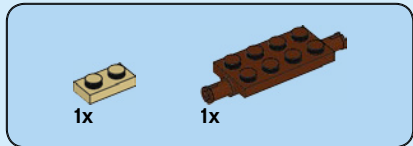

4

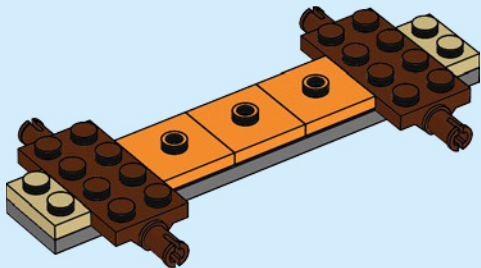

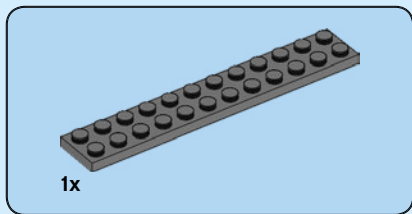

5

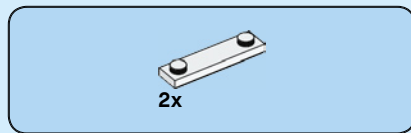
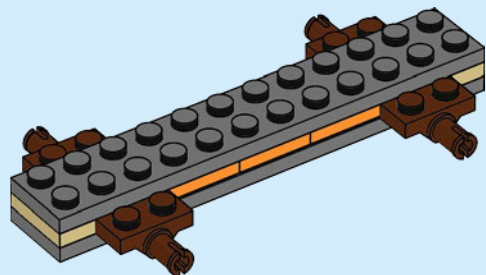

6

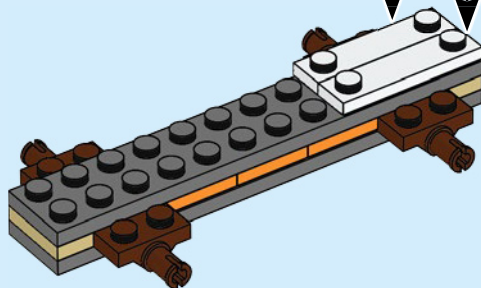
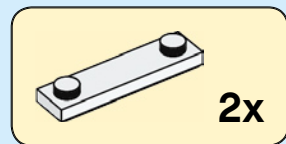

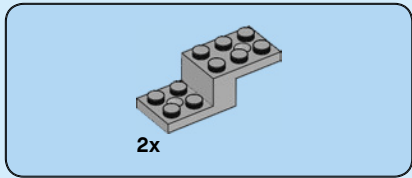

7

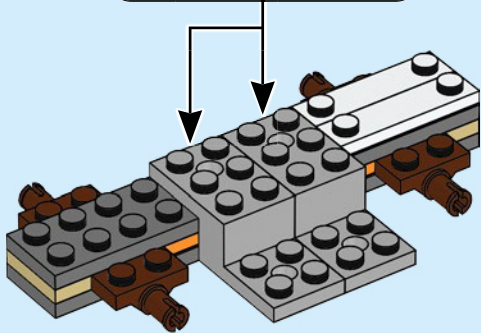
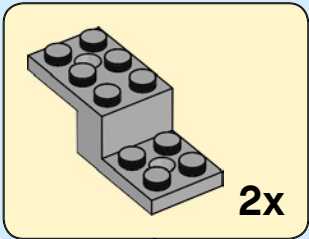

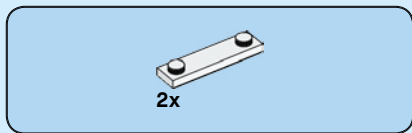

8

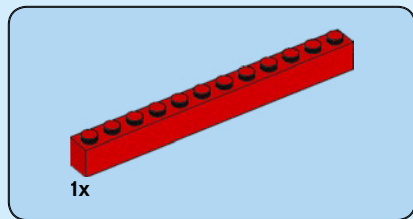
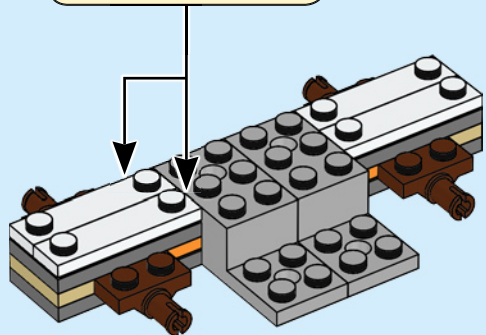
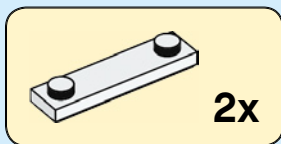

9

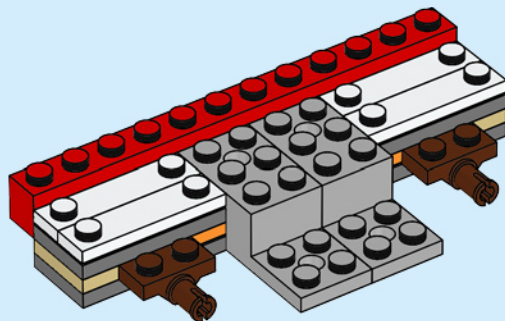

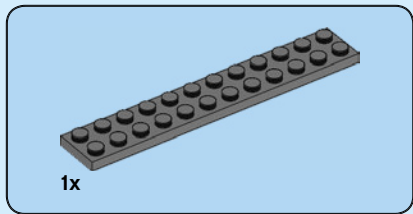

10

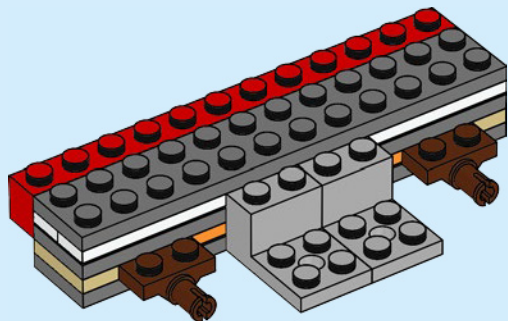

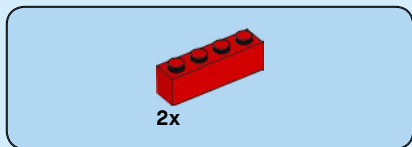

11

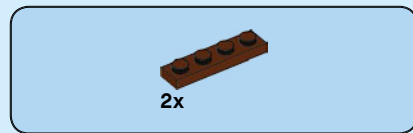
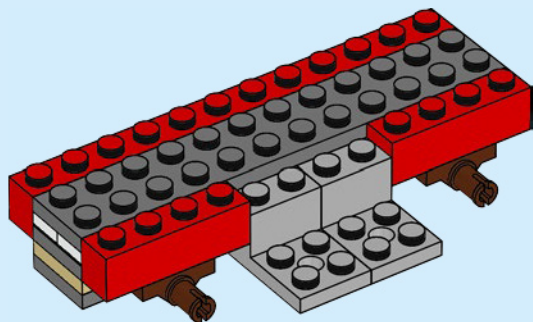

12

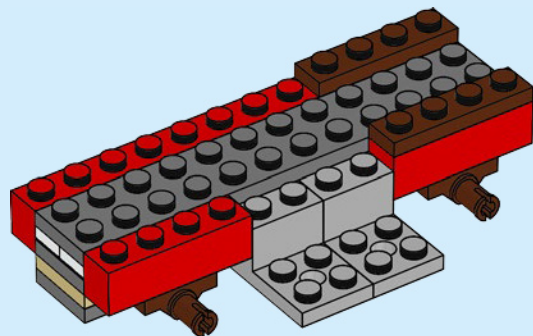

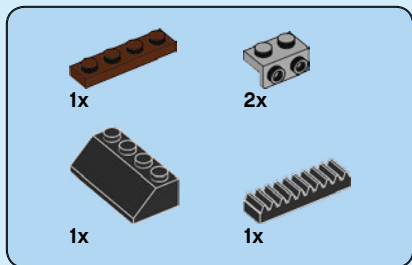

13

1

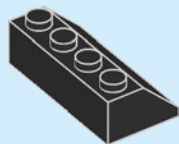

2

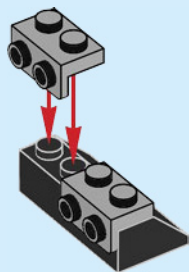

3

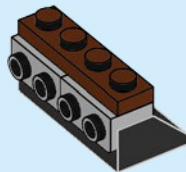

4

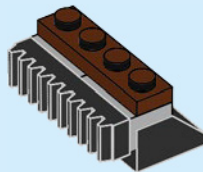

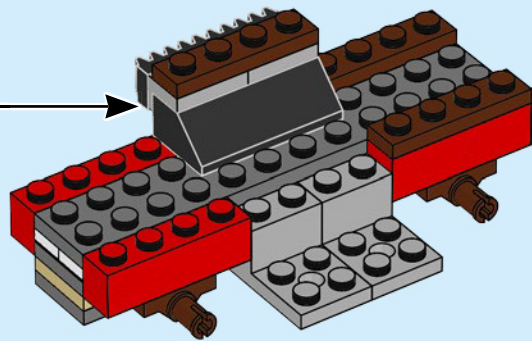



2x

14



2x

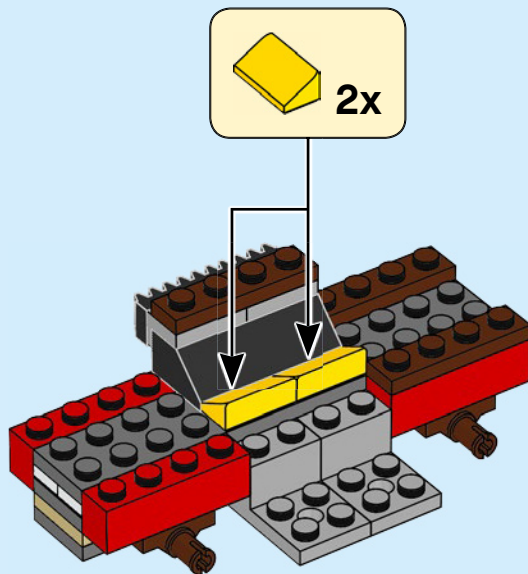



2x

15

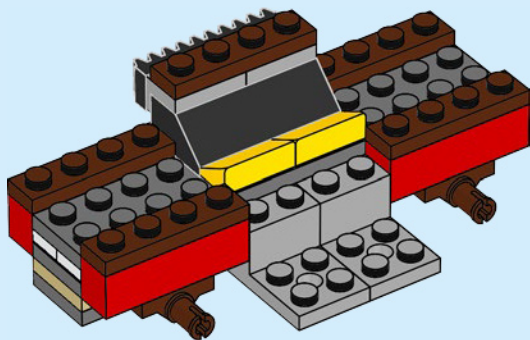

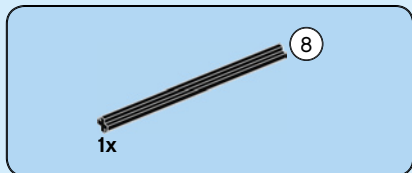
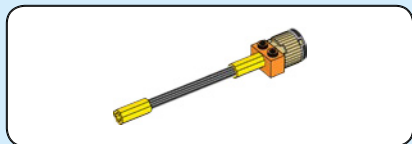

16

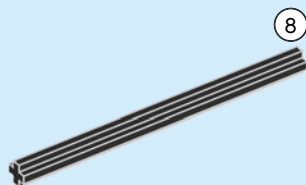

18

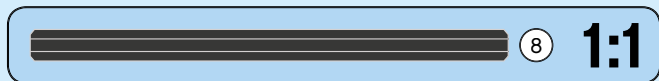



2x

17

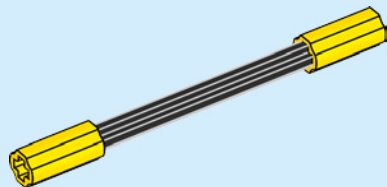

1x

3

18

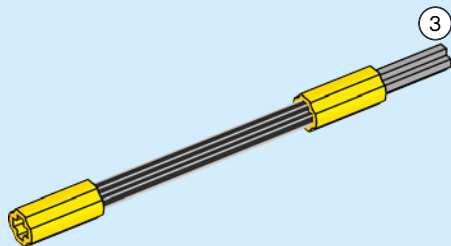

3



3

1:1



1x

19

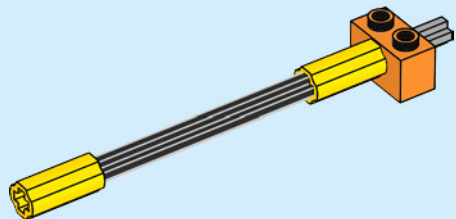

20



1x



1x

20

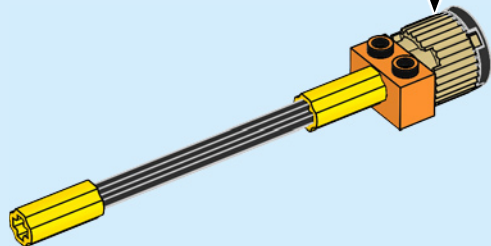
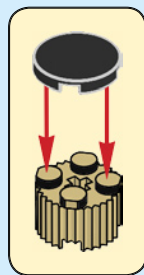

21

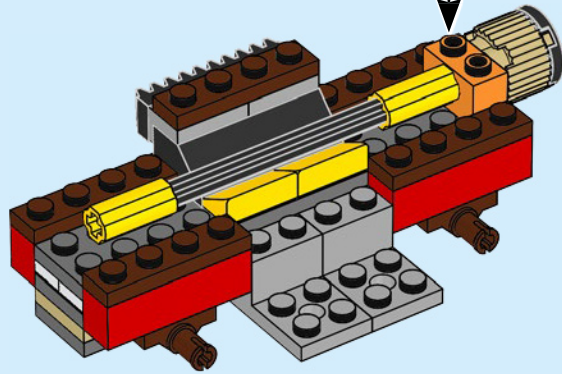



1x

22

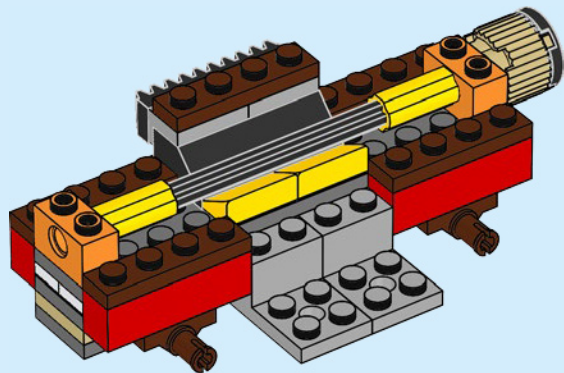

22

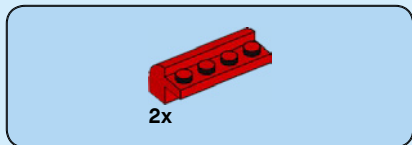

23

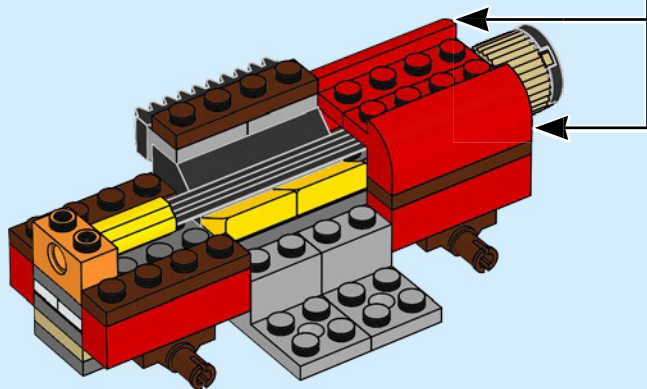
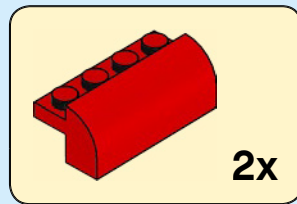



1x

24

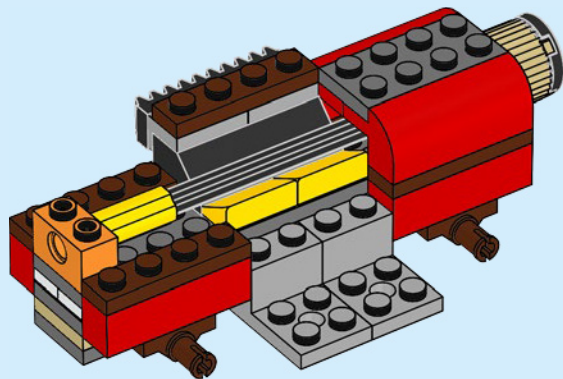

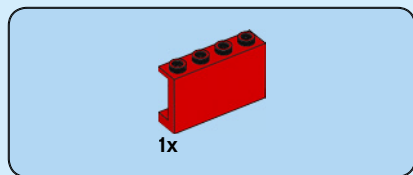

25

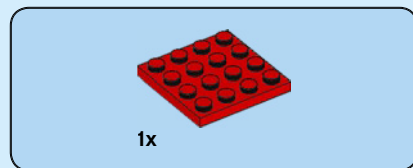
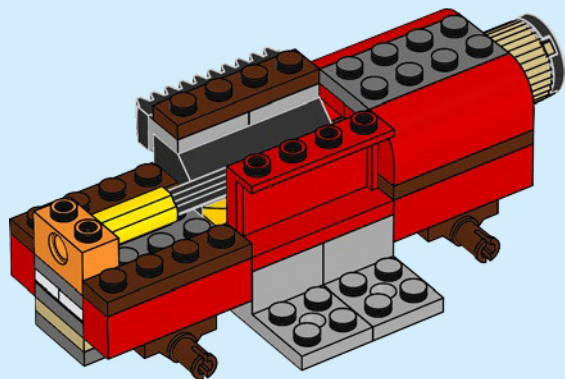

26

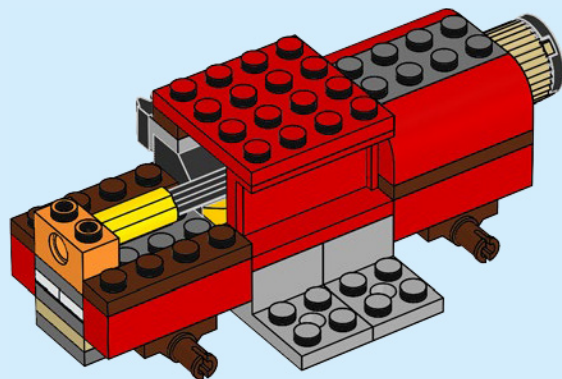



2x

27

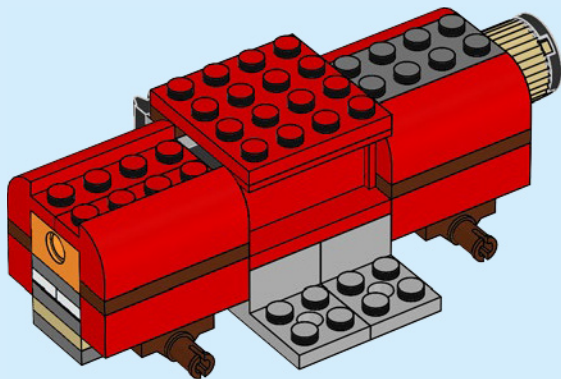

26



1x

28

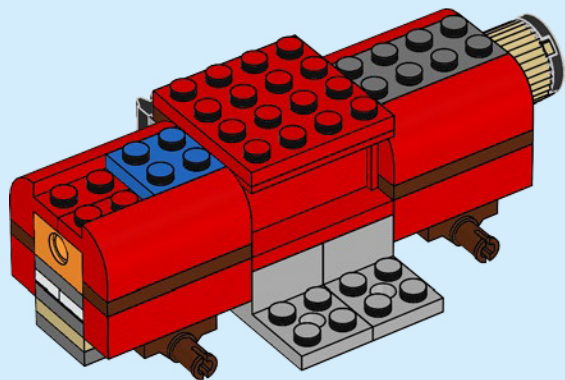

2x

29

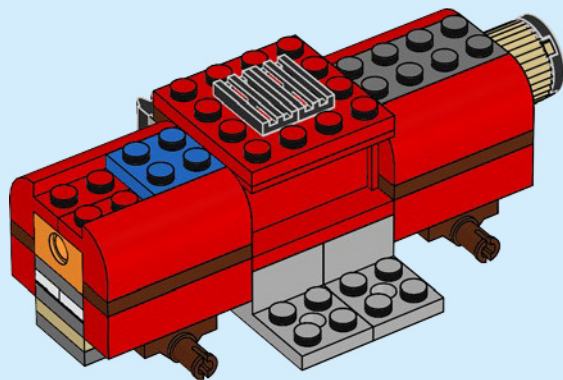



2x

30



2x

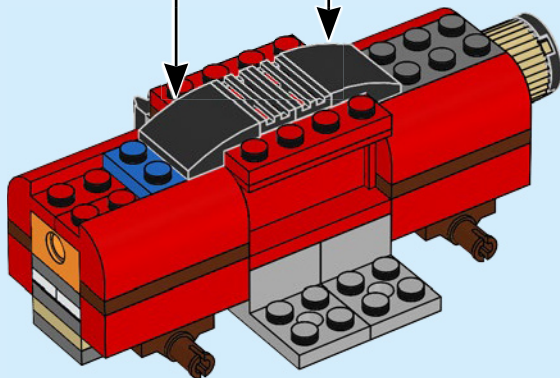



1x



1x

31

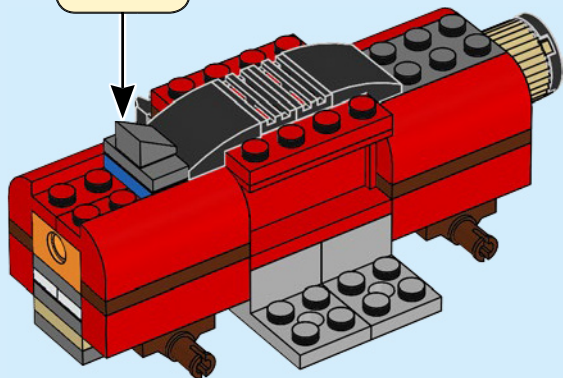
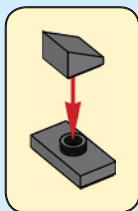

1x

32

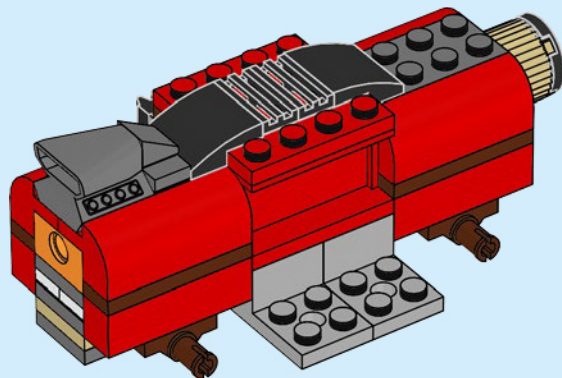



1x



1x

33

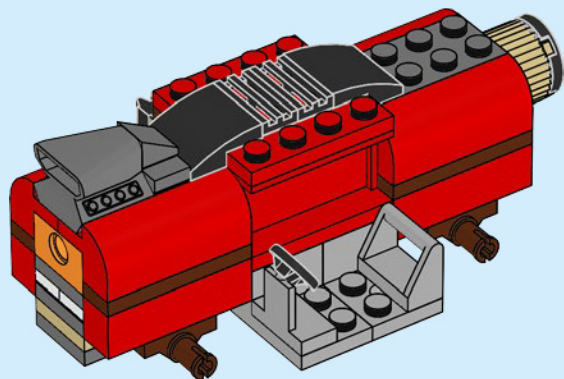

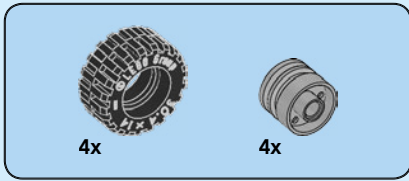

34

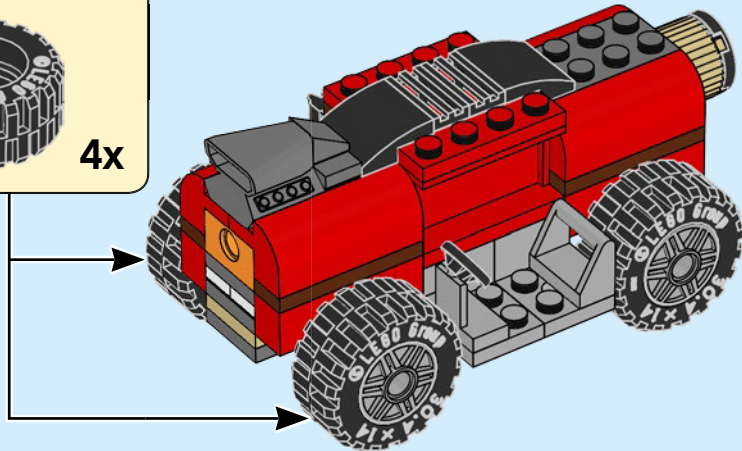
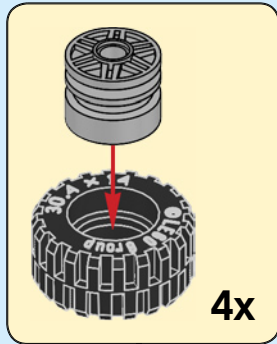

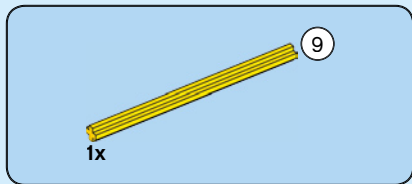

35

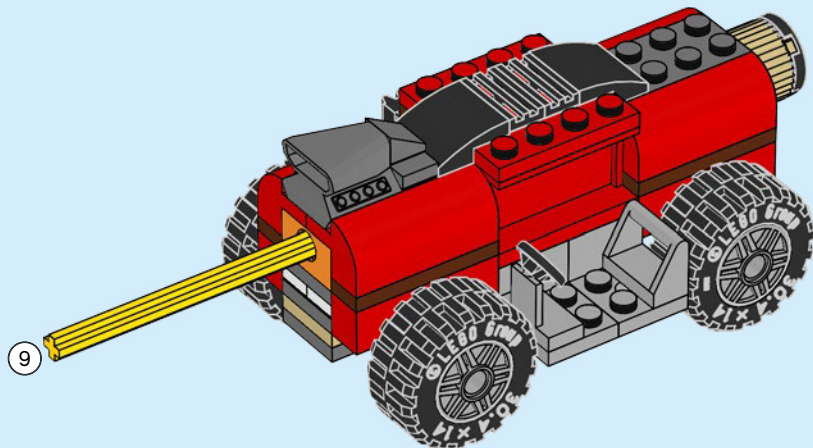



1x

36

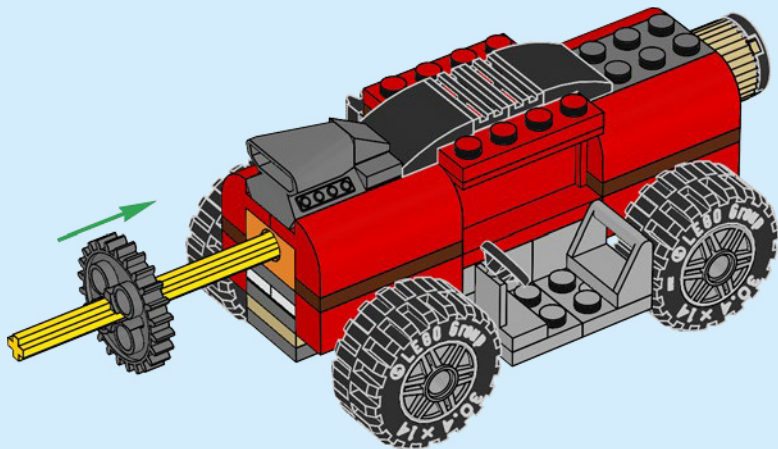

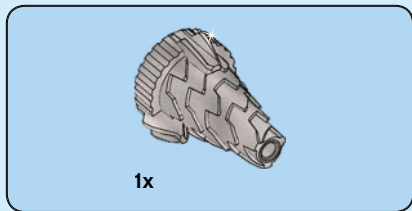

37

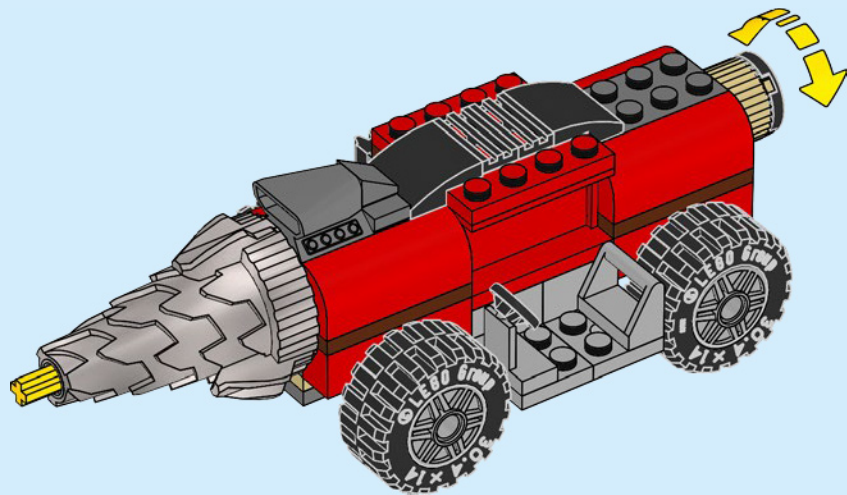

34



1x

38

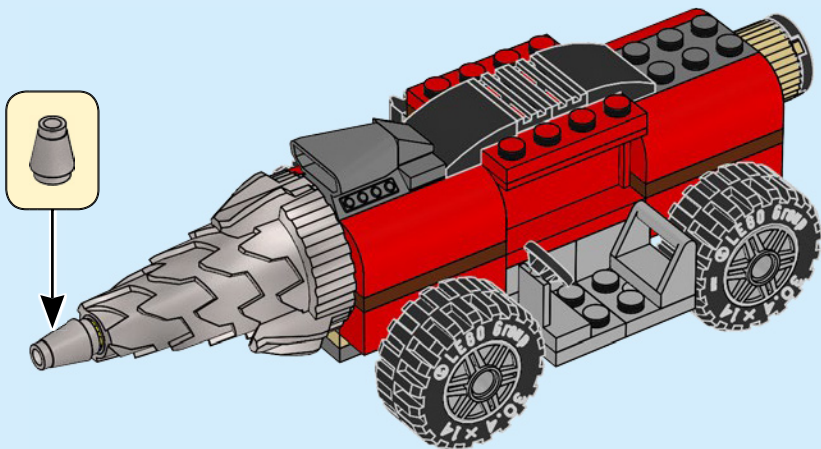

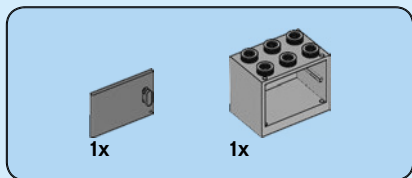

39

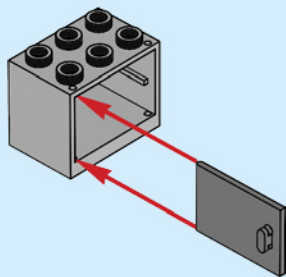



3x

40

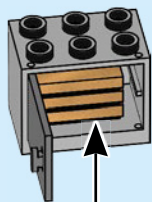

1x



1x



1x

41

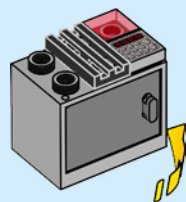

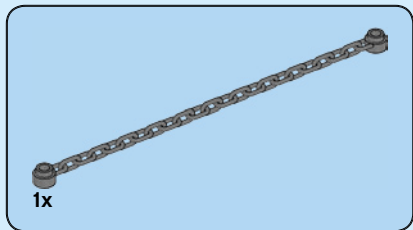

42



43

