

**LEGO**

**CITY**

60350

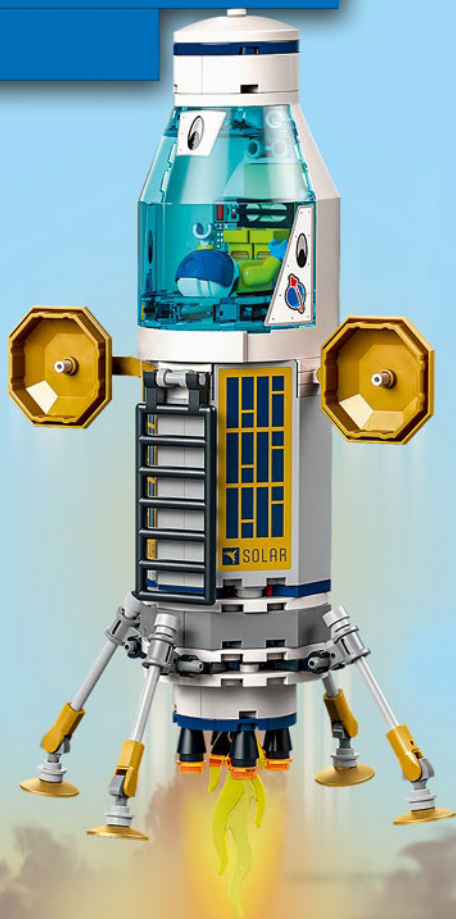

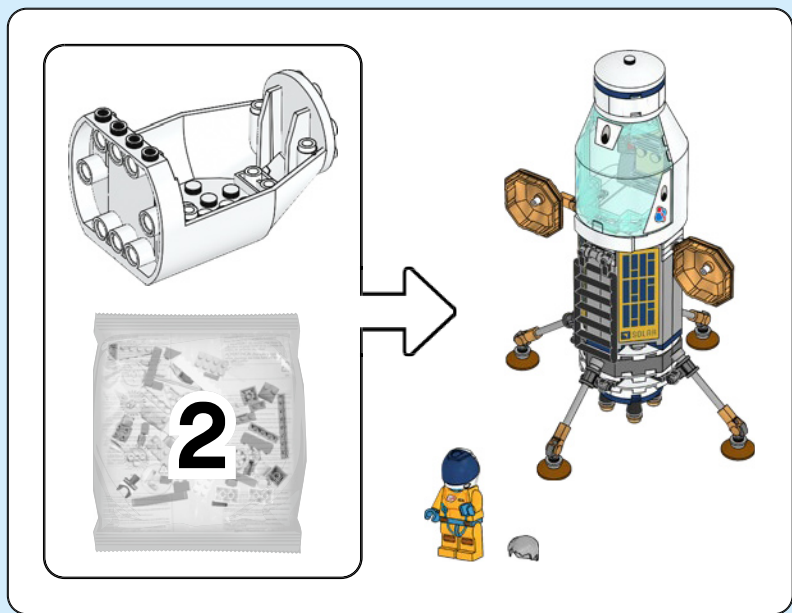

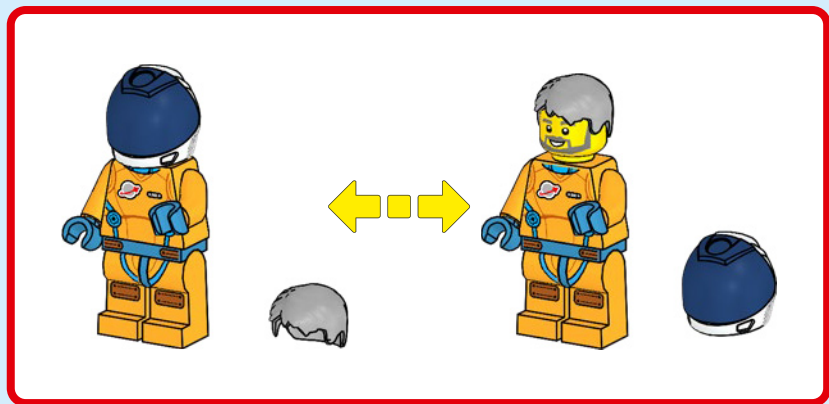
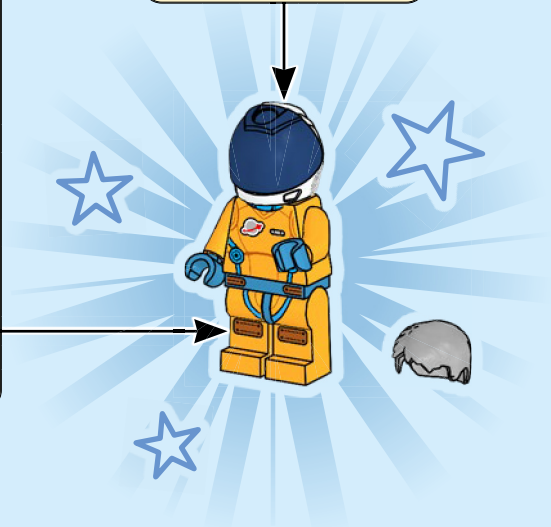
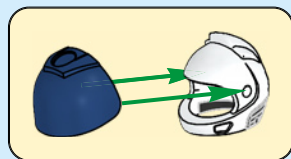
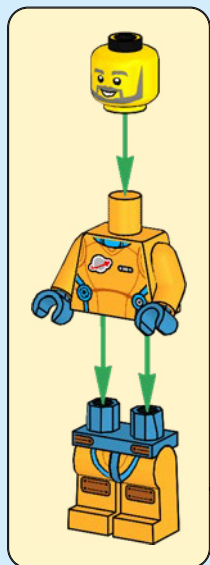

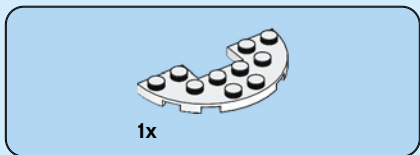
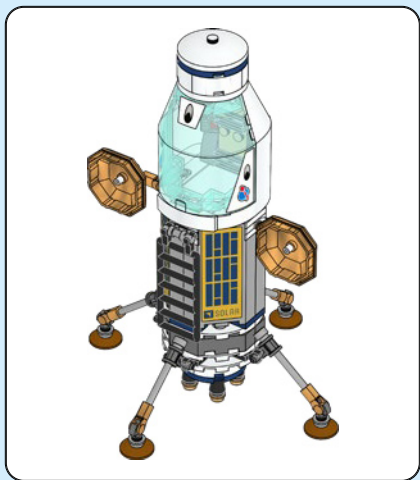

1

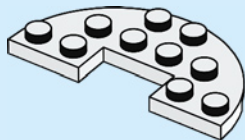



3x

2

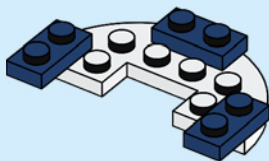

1x

3

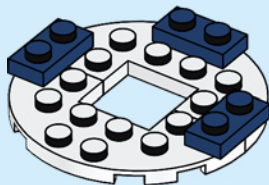



1x



4x

4

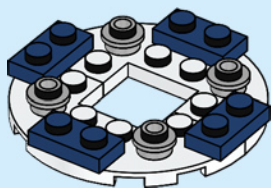

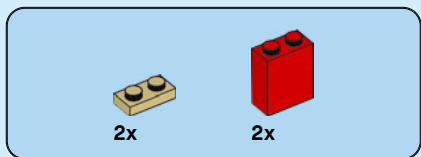

5

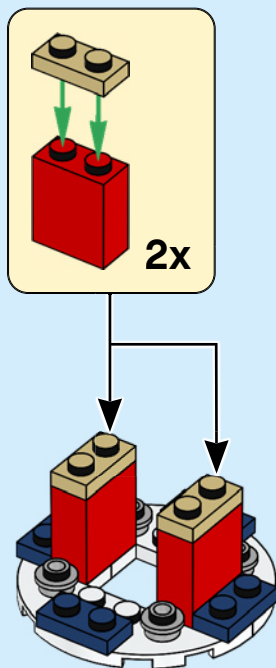

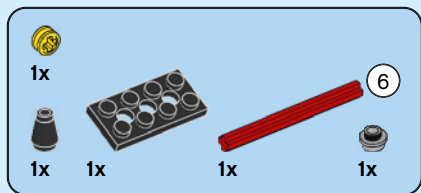

6

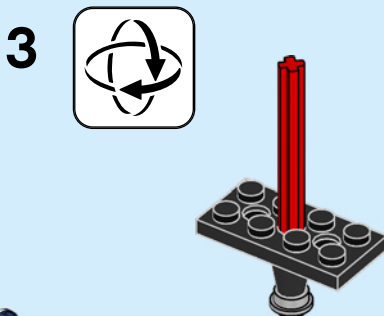
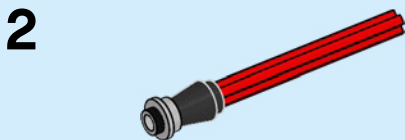
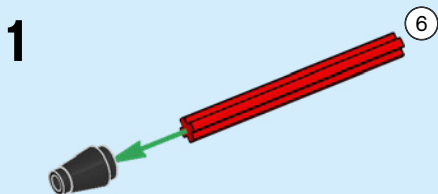



4

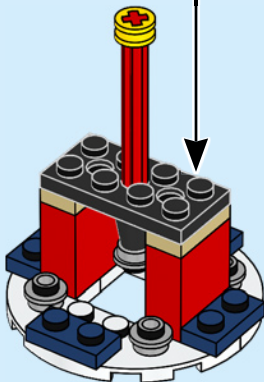
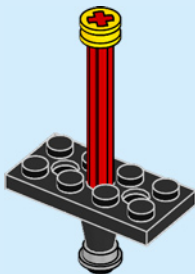

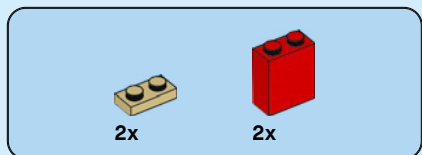

7

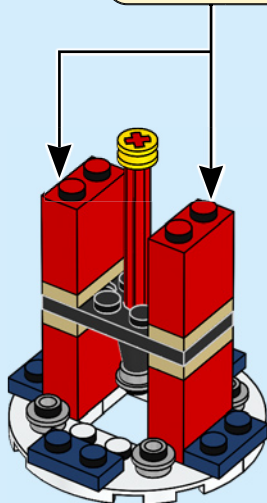
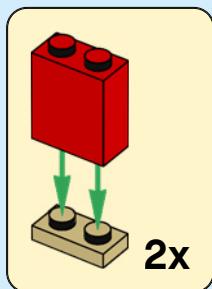

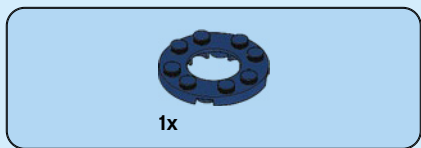

8

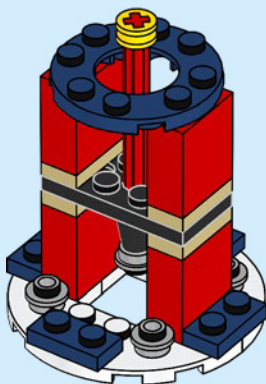



4x

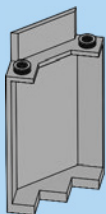

4x

9

1

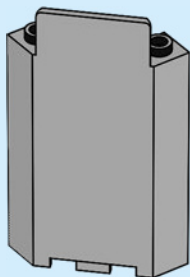

2

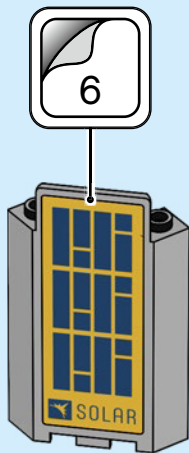

4x



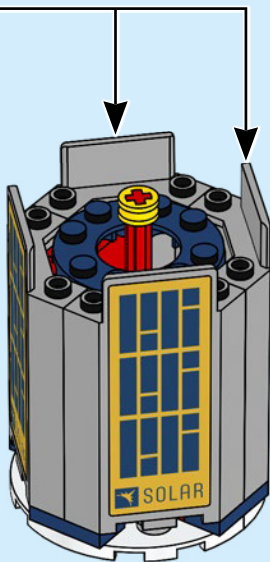

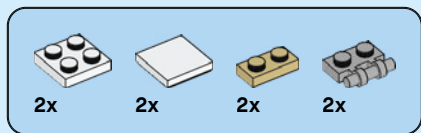

# 10

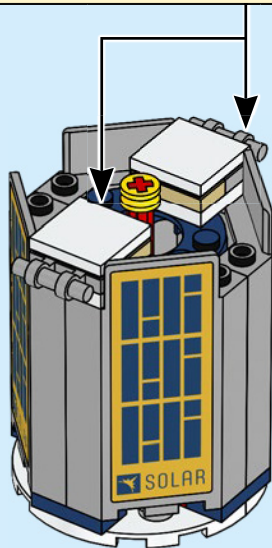
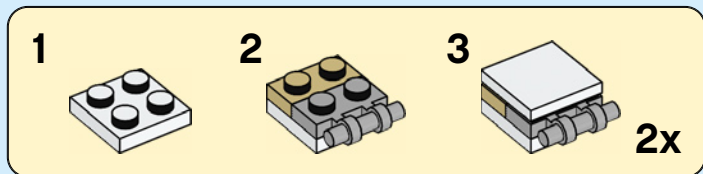



2x



2x



2x

# 11

1



2

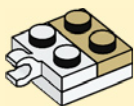

2x

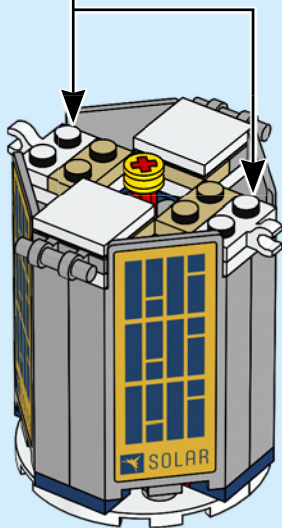

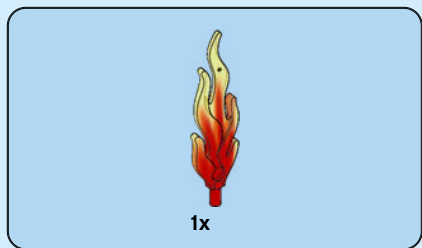

12

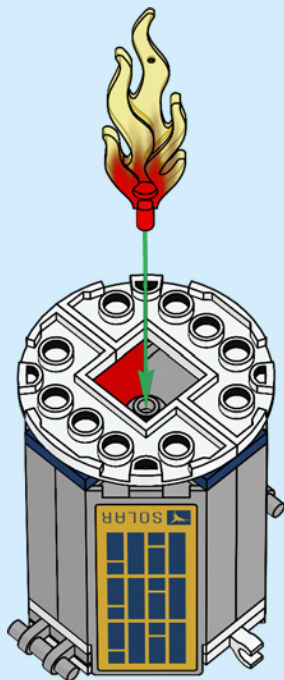
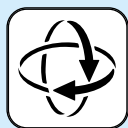





4x

# 13

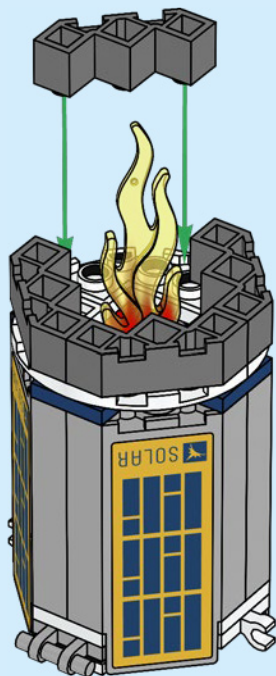



2x

14

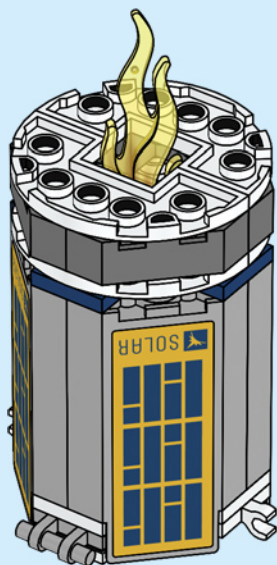



1x

15

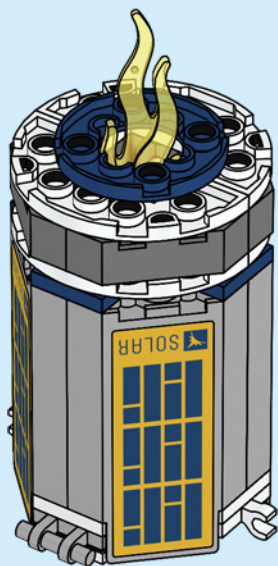



4x

# 16

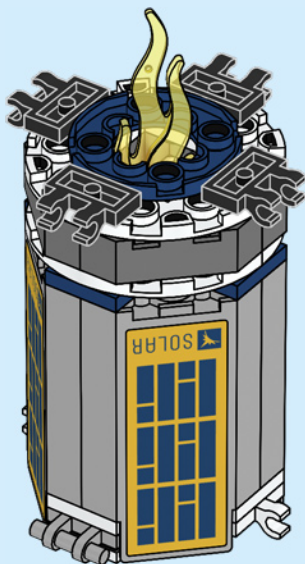



2x

17

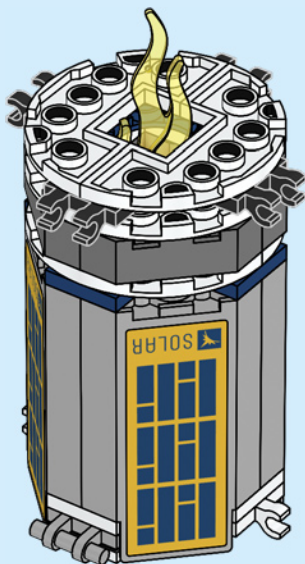



4x



1x

# 18

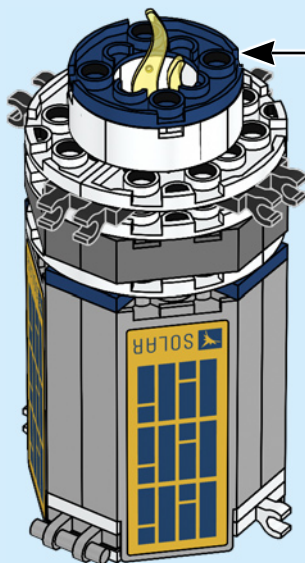
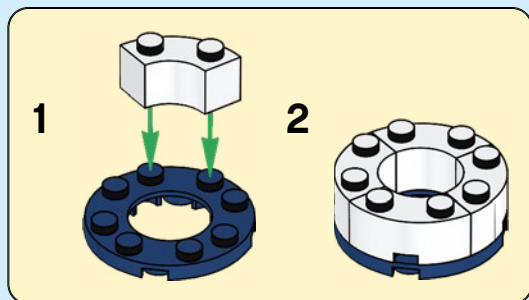



4x



4x

# 19

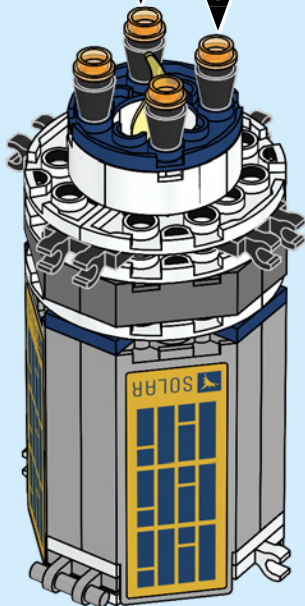
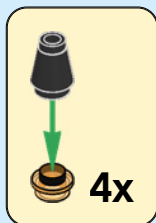



4x



4x



4x



4x

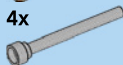

4x



4x



4x

20

1

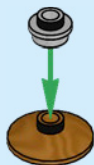

2

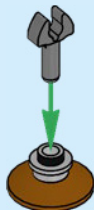



3

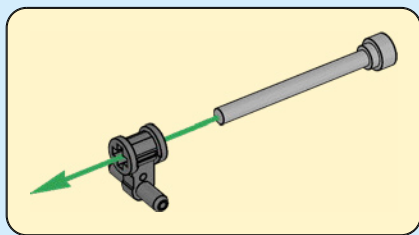
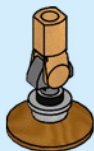

4

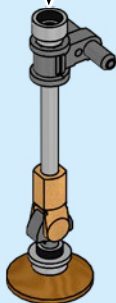

4x



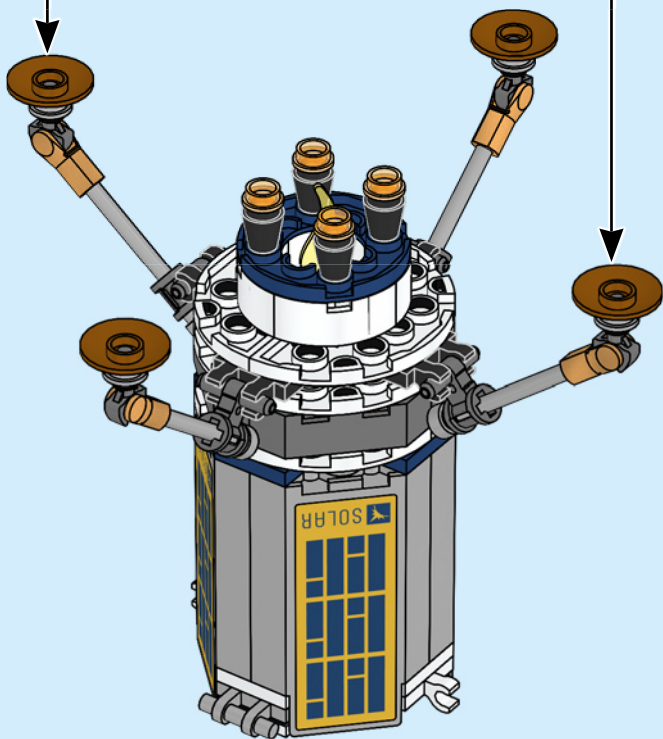



2x

21

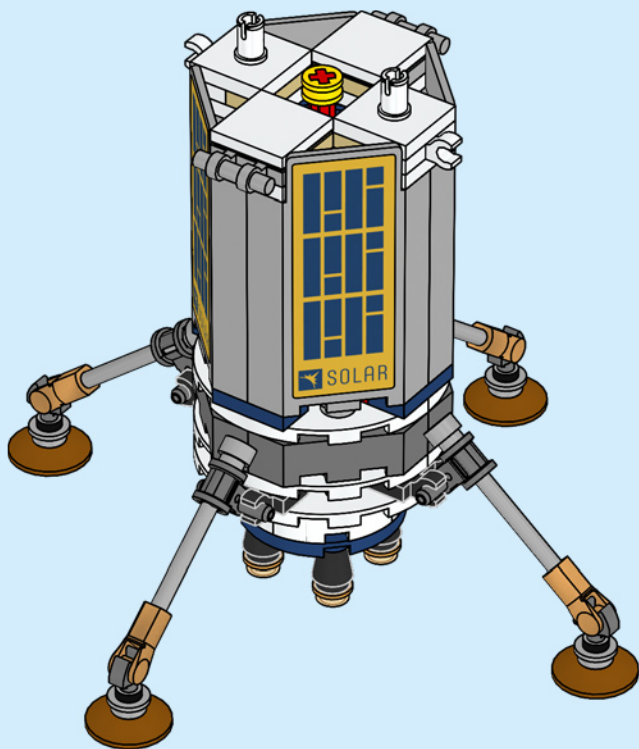
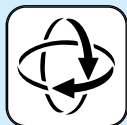

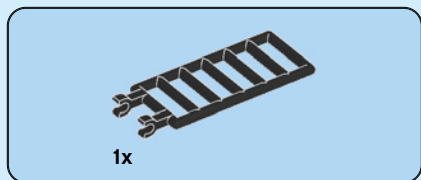

22

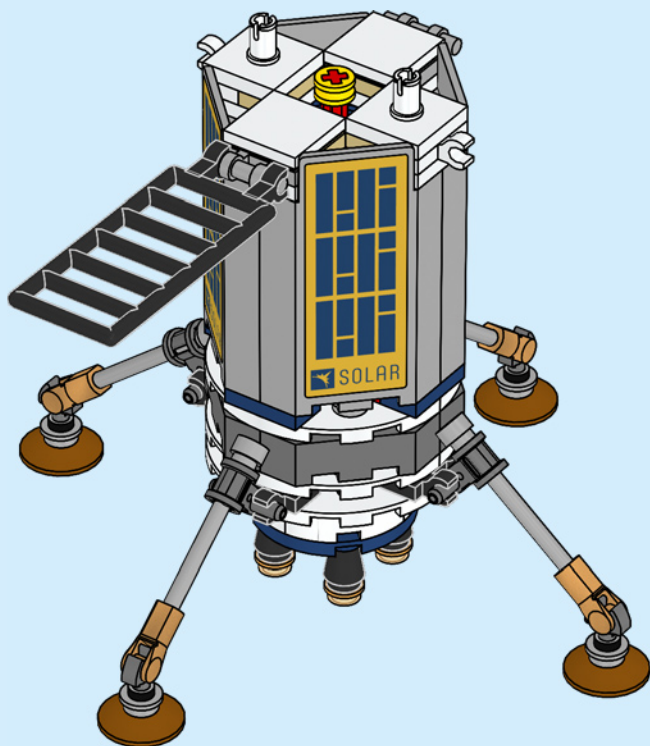

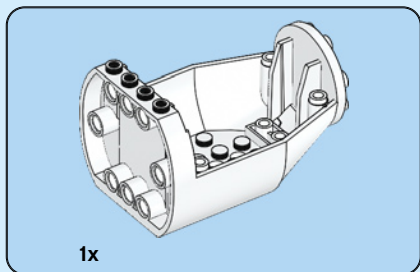

23

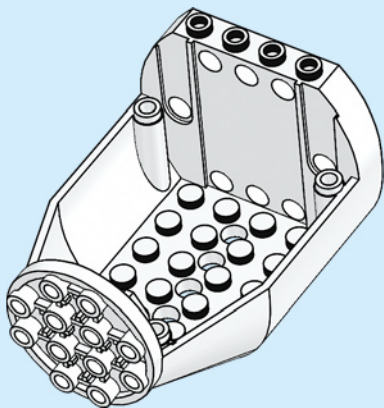



1x

24

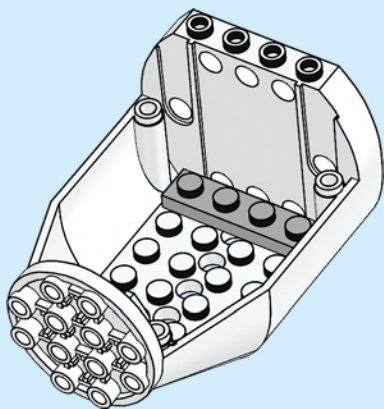



2x

# 25



2x

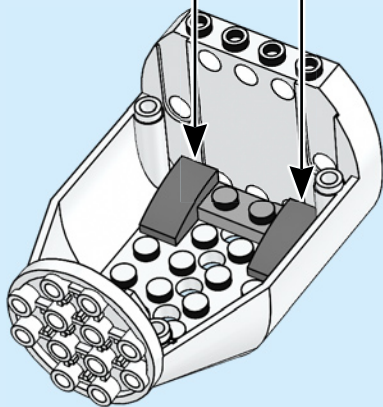



2x

# 26

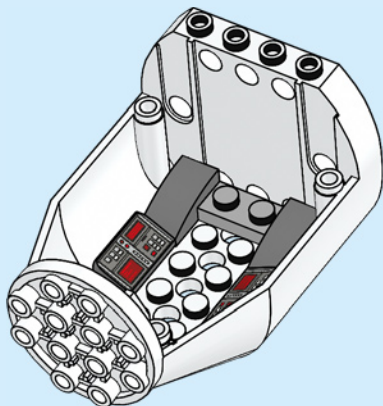

2x

# 27

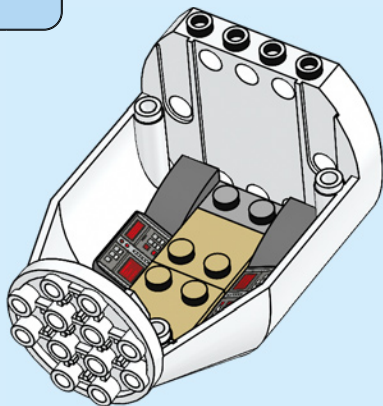





2x

# 28

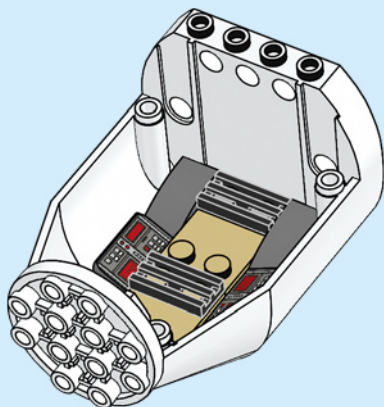

1x



1x

# 29

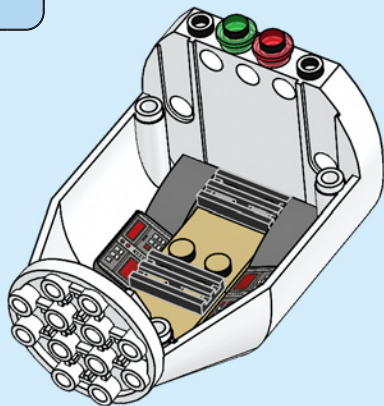



1x

30

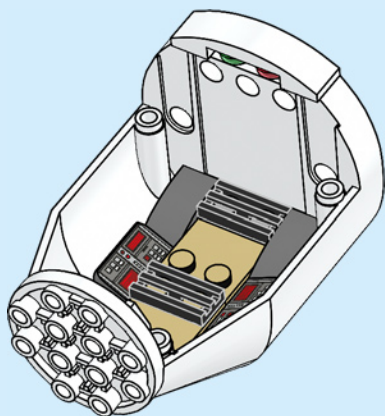

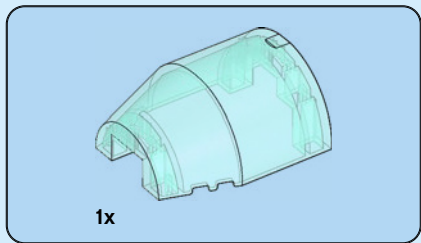

**31**

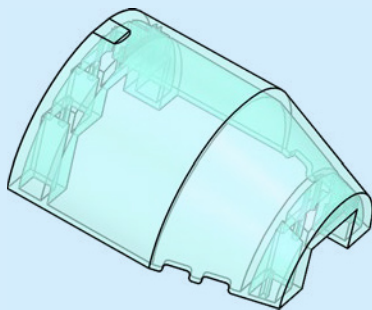

32

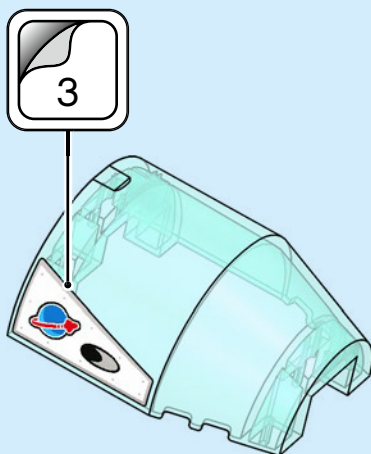

33

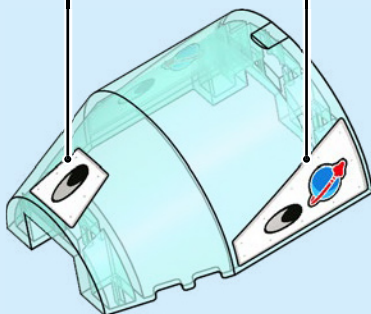

34

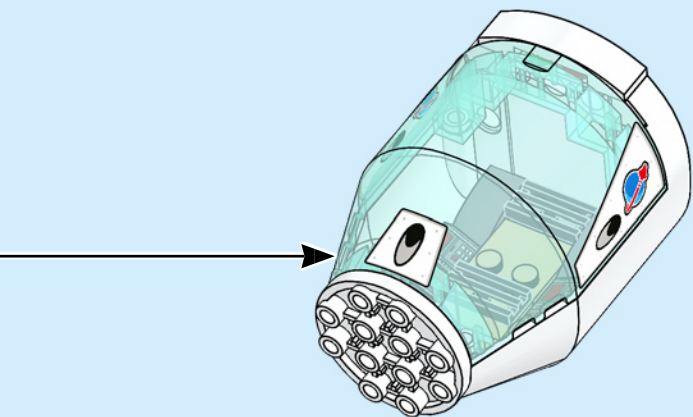



4x

35

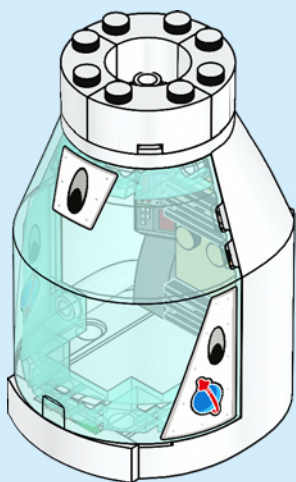
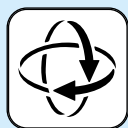



1x

36

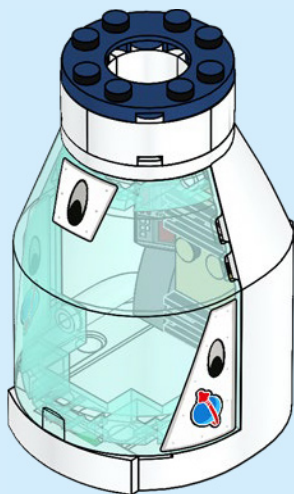

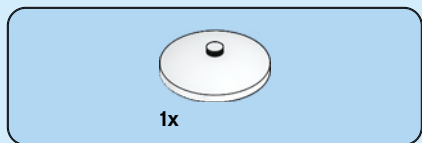

37

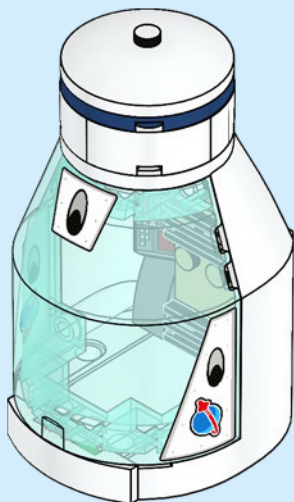



38

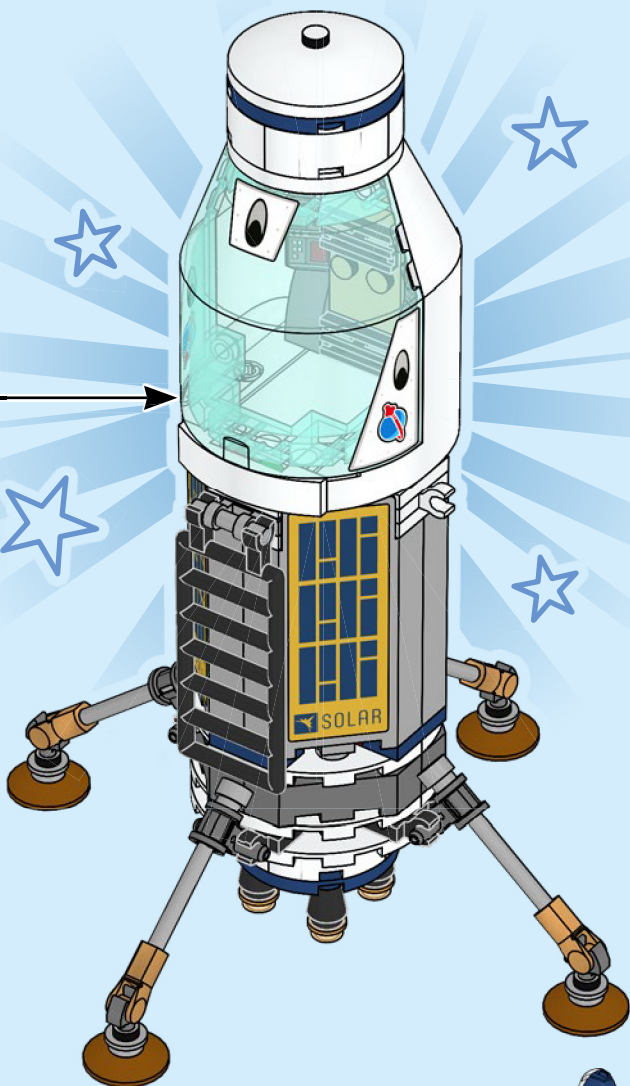



**2x**



**2x**



**2x**



**2x**

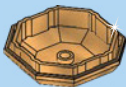

**2x**

**39**

**1**

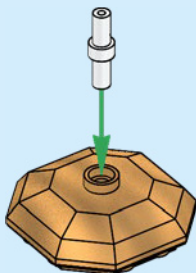

**2**

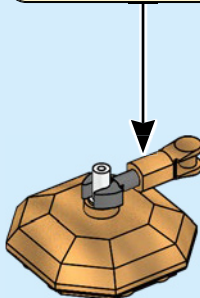
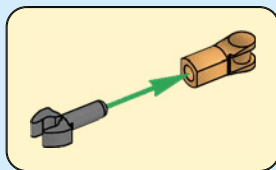

**2x**

