



CITY

60366



1



WARNING: CHOKING HAZARD.
Toy contains small parts and a small ball.
Not for children under 3 years.



Get excited about our new packaging!

We're switching from plastic to paper-based packaging. That's why you might find a mix of paper and plastic in our boxes!

Nos nouveaux emballages vous emballeront !

Nous passons des emballages en plastique aux emballages à base de papier. C'est pourquoi vous pourriez trouver un mélange de papier et de plastique dans nos boîtes !

¡Te presentamos nuestros nuevos empaques!

Estamos sustituyendo las bolsas de plástico por bolsas con base de papel. ¡Por eso, puedes encontrar una mezcla de papel y de plástico en nuestras cajas!

[LEGO.com/sustainable-packaging](https://www.lego.com/sustainable-packaging)

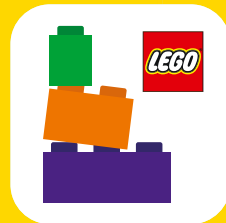

BUILDER



Apple and the Apple logo are trademarks of Apple Inc., registered in the U.S. and other countries and regions. App Store is a service mark of Apple Inc. Google Play and the Google Play logo are trademarks of Google LLC. Tencent and the Tencent logo are trademarks of Tencent Inc.

Q LEGO.com/devicecheck

EN Ask parents' permission before going online | DE Eltern um Erlaubnis bitten, bevor du online gehst | FR Demande l'autorisation d'un parent avant d'aller en ligne | IT Chiedi il permesso ai tuoi genitori prima di andare online | ES Pídeles permiso a tus papás antes de conectarte a Internet | PT Peça autorização aos pais antes de acederes online | ZH 上网前应先征得父母的同意 | PL Poproś rodziców o zgodę, zanim wejdiesz do Internetu | CS Než půjdeš na internet, požádej rodiče o svolení | SK Skôr než půjdeš na internet, vypýtaj si povolenie od rodičov | HU Kérj szülői engedélyt, mielőtt online csatlakoznál! | RO Cere permisiunea părinților înainte de a te conecta online | BG Поискайте разрешение от родител, преди да влезете онлайн | LV Pirms došanās tiešsaistē palūdz atļauju vecākiem | ET Enne Interneti kasutamist küsi vanematelt luba | LT Prieš prisijungdami prie interneto, atsklauskite tėvų

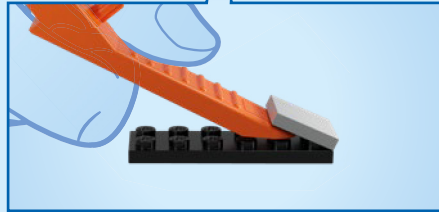
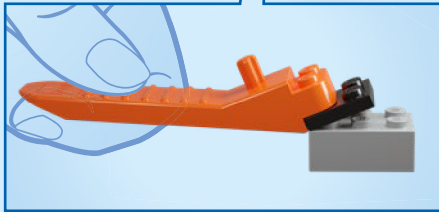
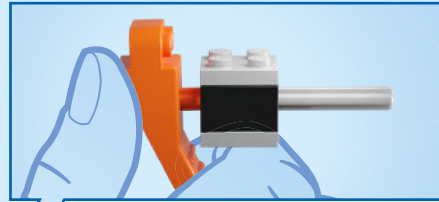
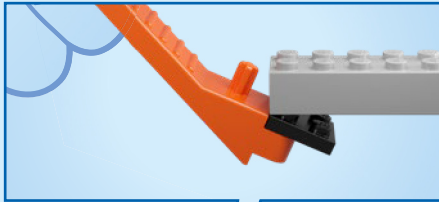

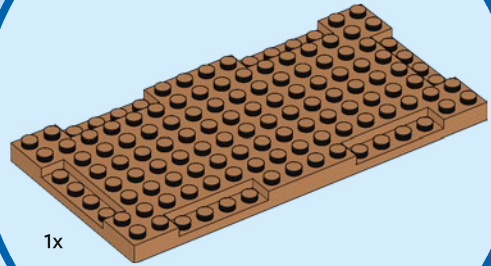
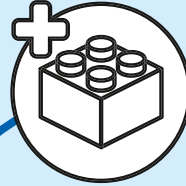
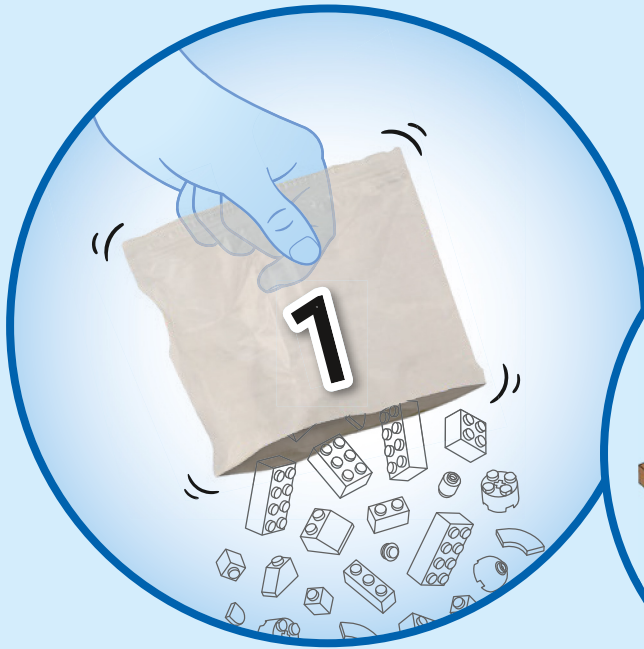



AVERTISSEMENT : RISQUE D'ÉTOUFFEMENT.

Le jouet contient des petites pièces ainsi qu'une petite boule.
Il ne convient pas aux enfants de moins de 3 ans.



ADVERTENCIA: PELIGRO DE ASFIXIA.

Juguete que contiene partes pequeñas y una pelota pequeña.
No recomendado para niños menores de 3 años.

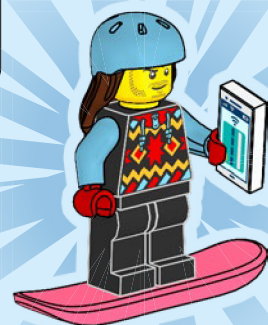
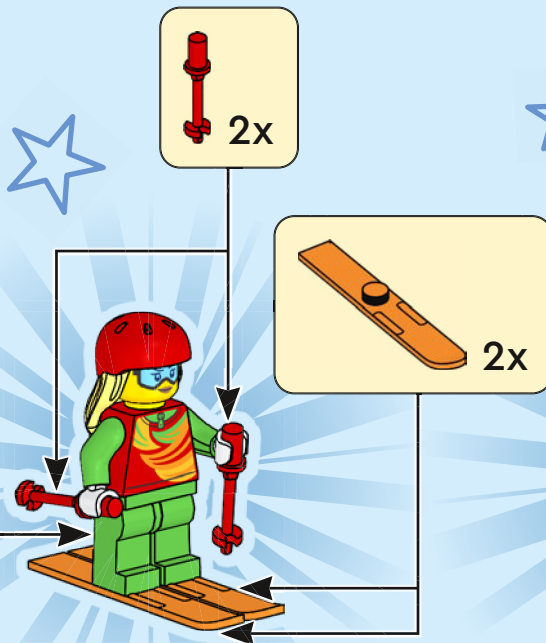

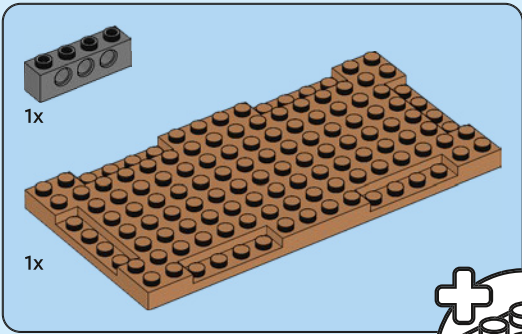

1

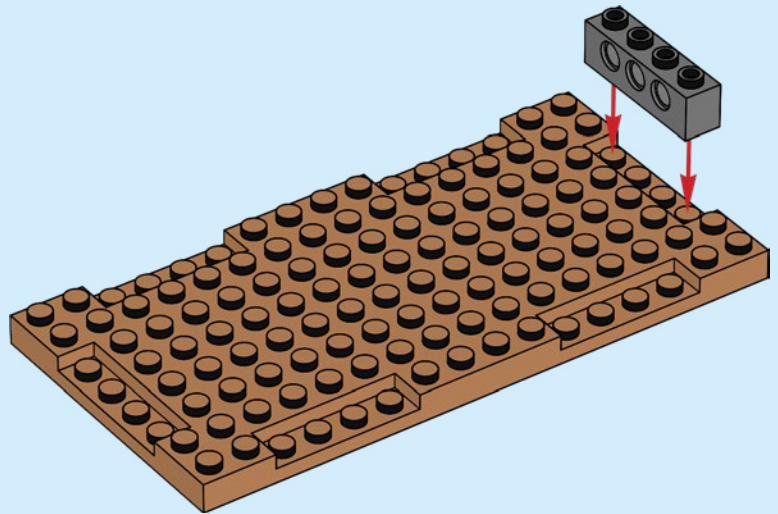
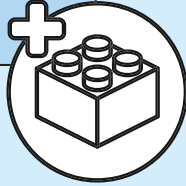



2x

2

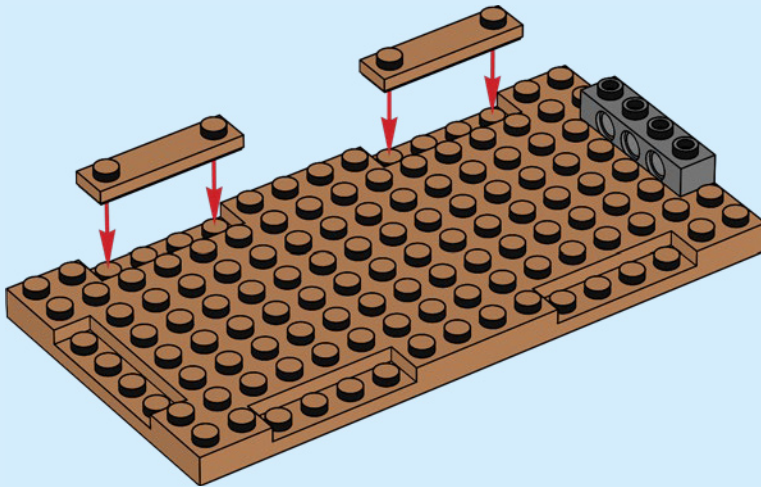

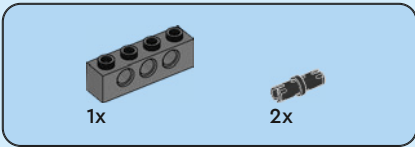

3

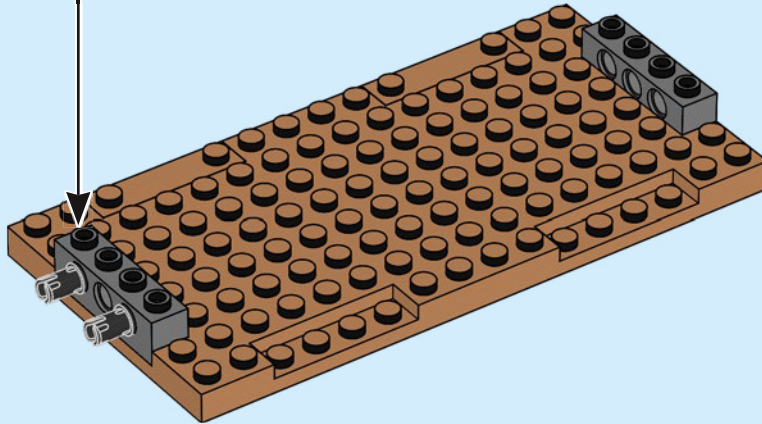
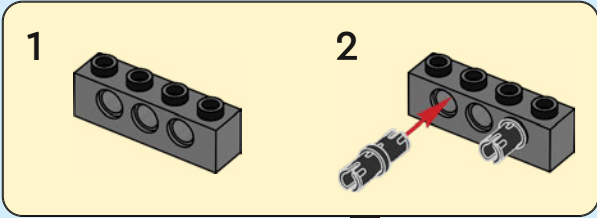

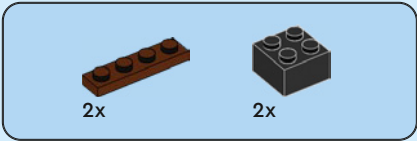

4

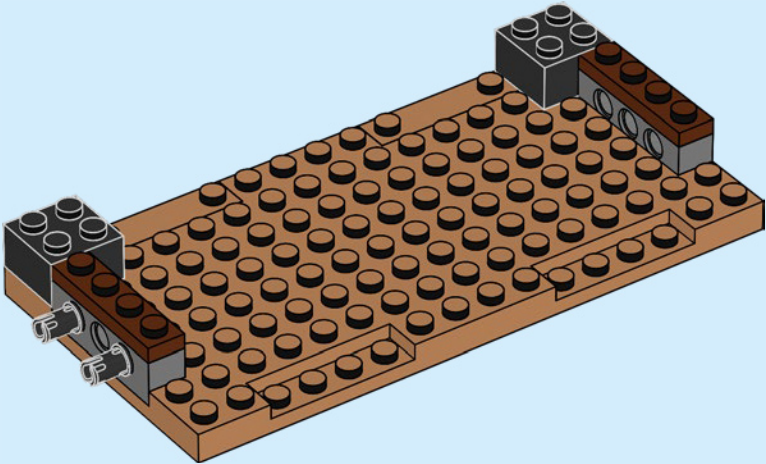



4x

5

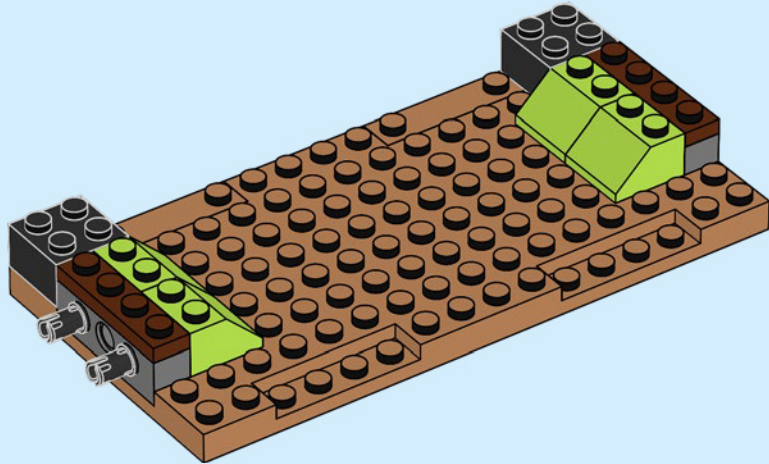

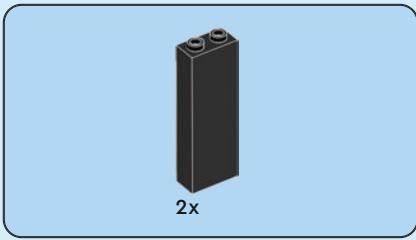

7

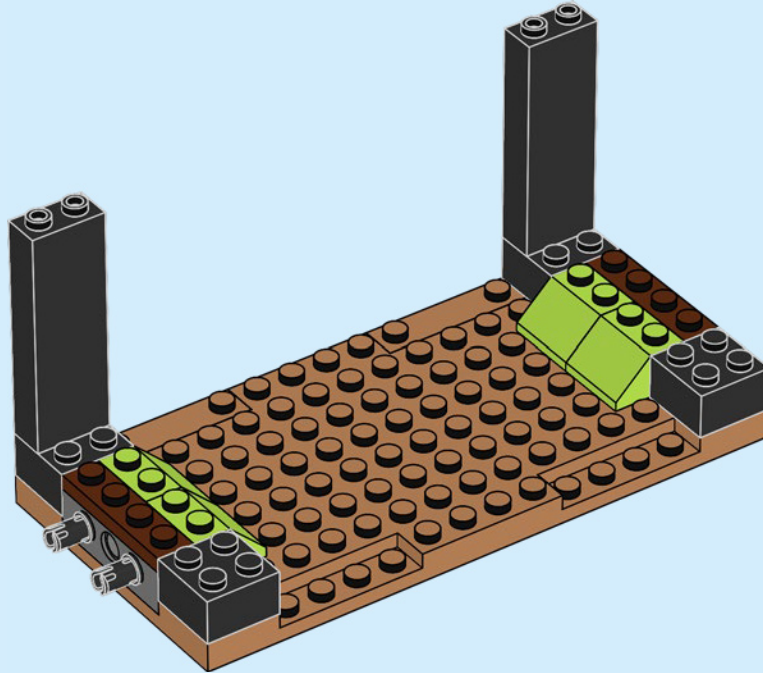

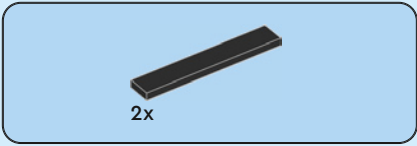

8

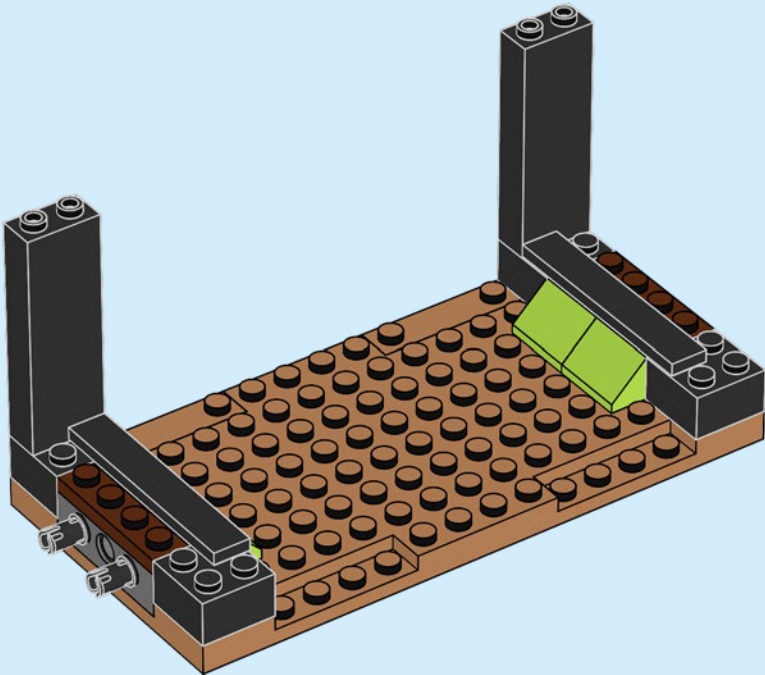

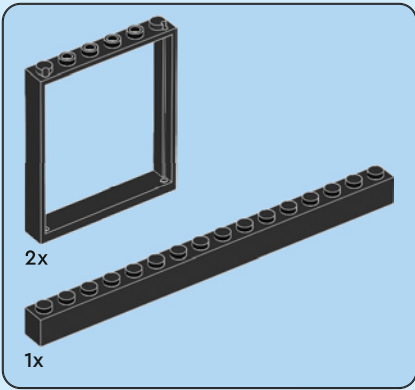

9

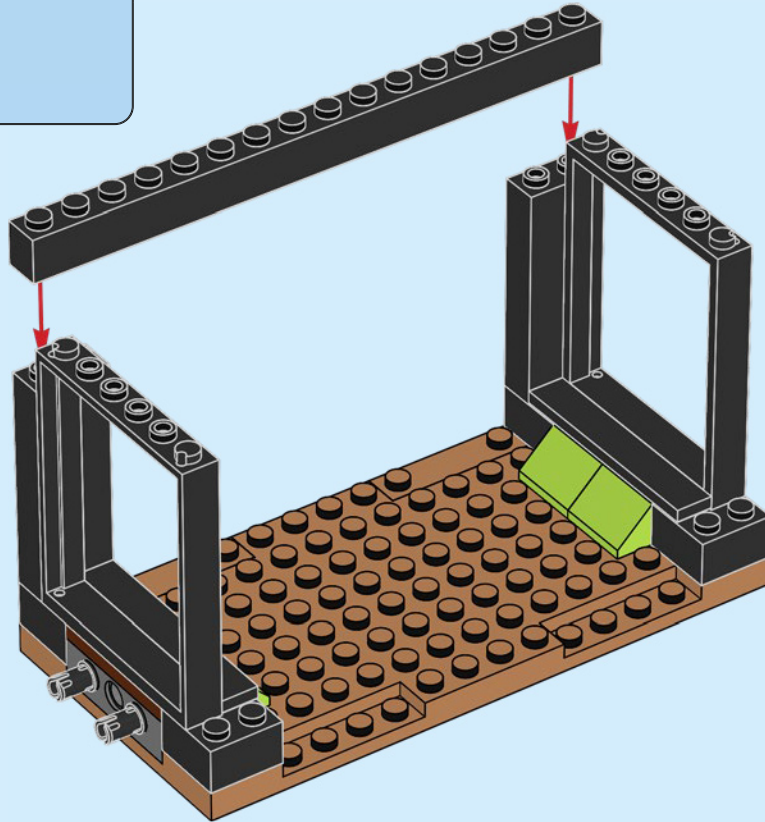



2x

10

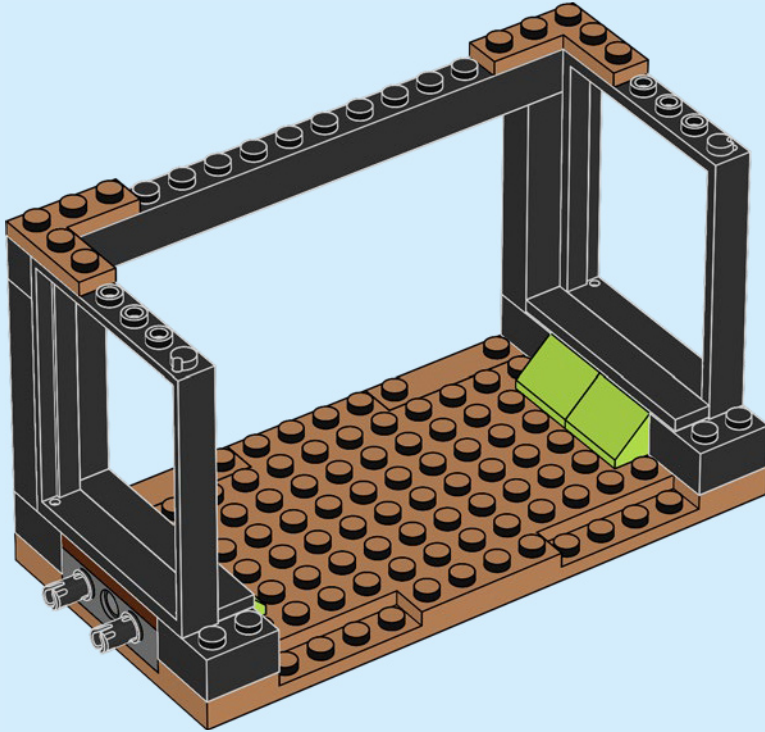

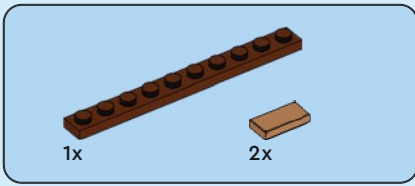

11

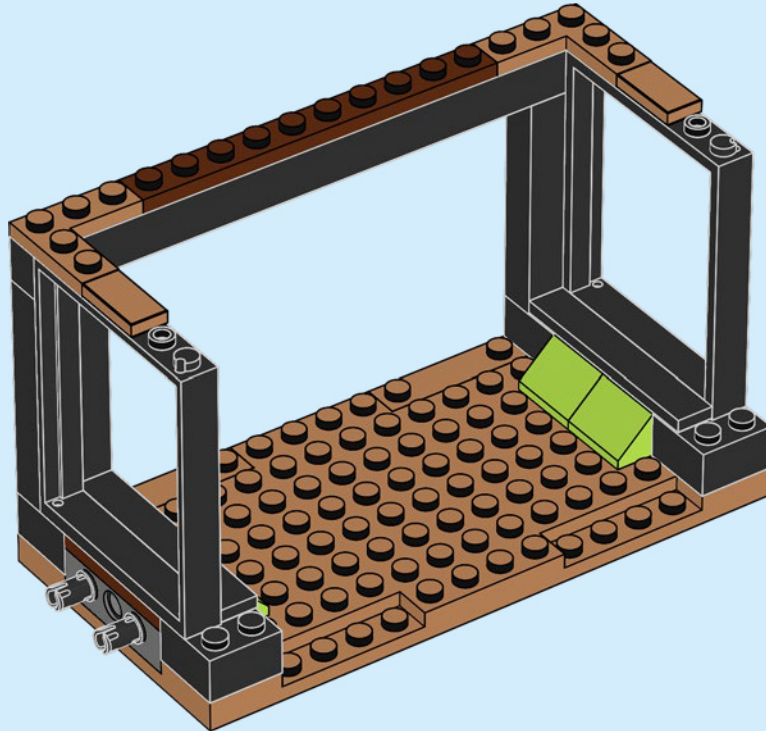

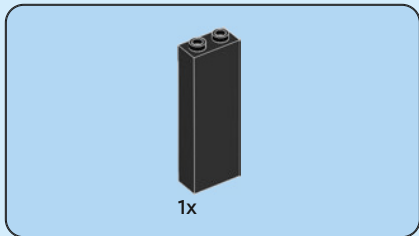

12

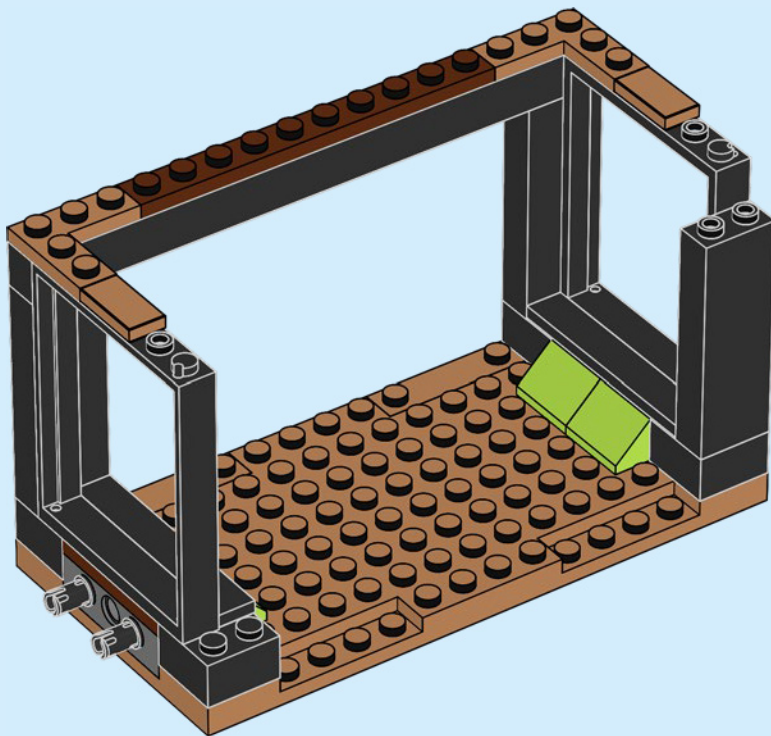

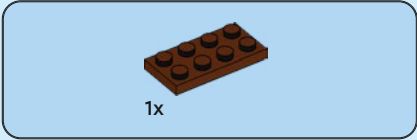
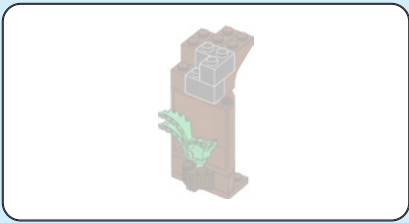

13

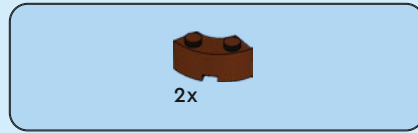
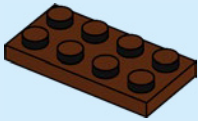

14

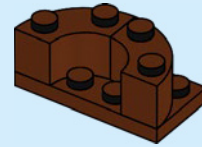

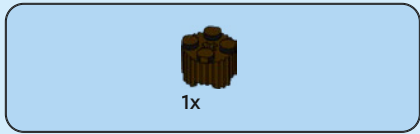

15

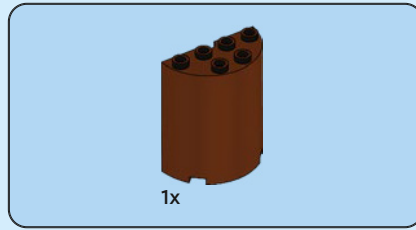
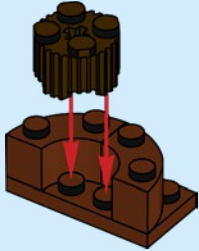

16

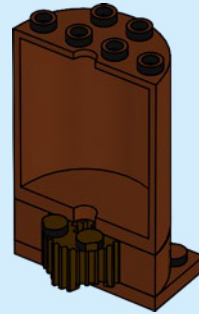

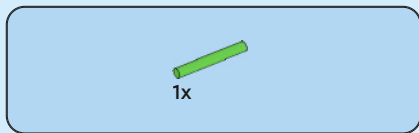

17



18





19



20



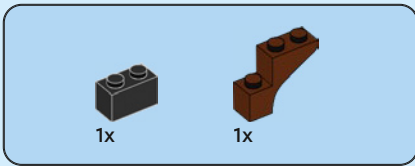

21

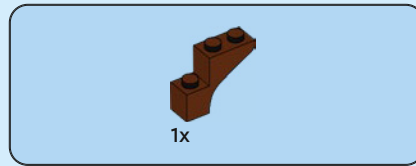
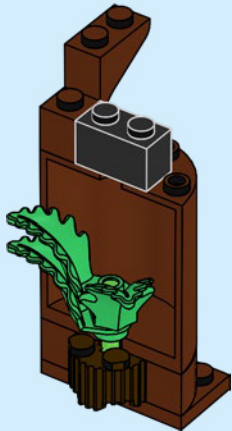

22





1x

23

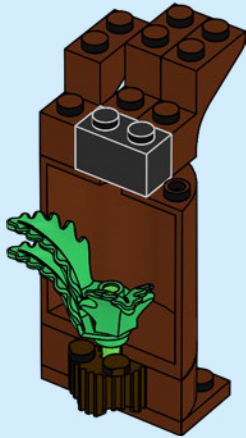

1x

24

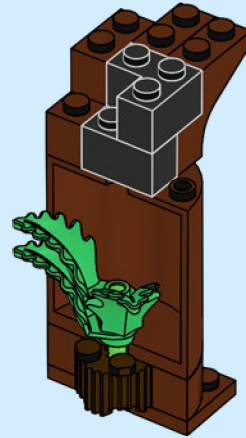

25

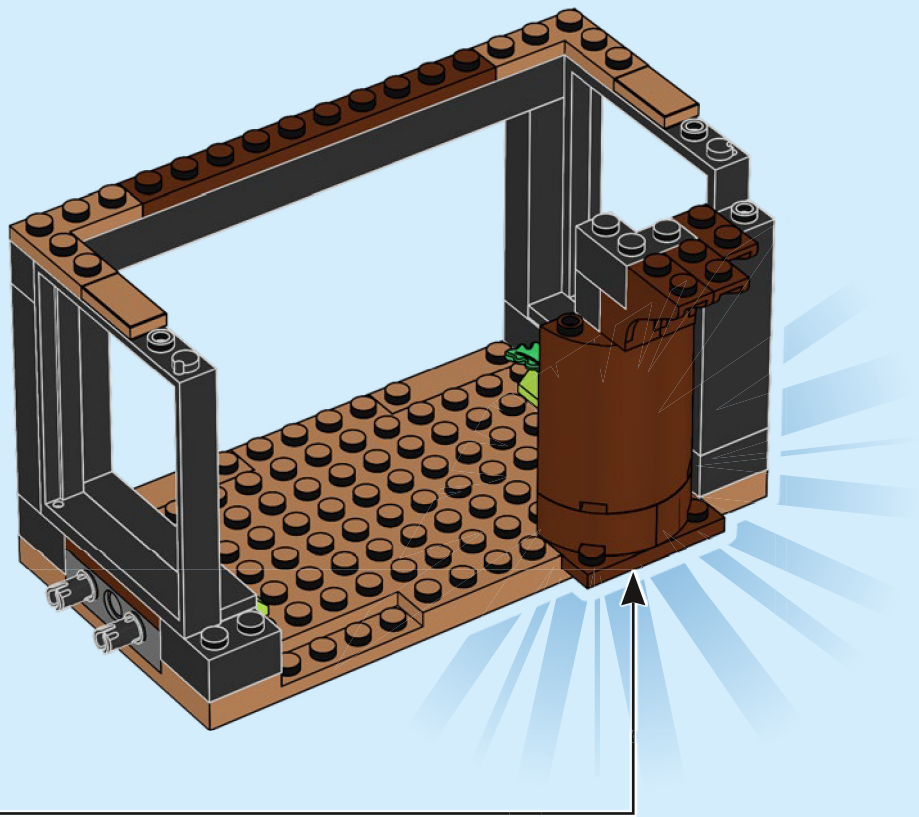

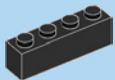

1x

26

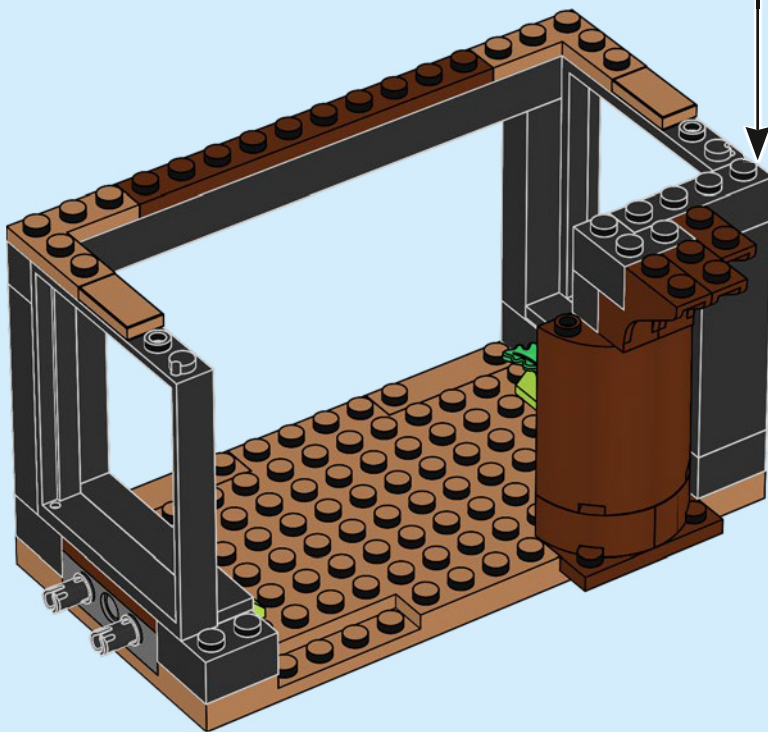
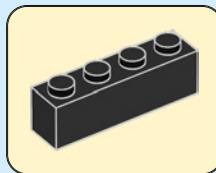

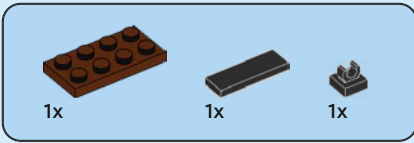

27

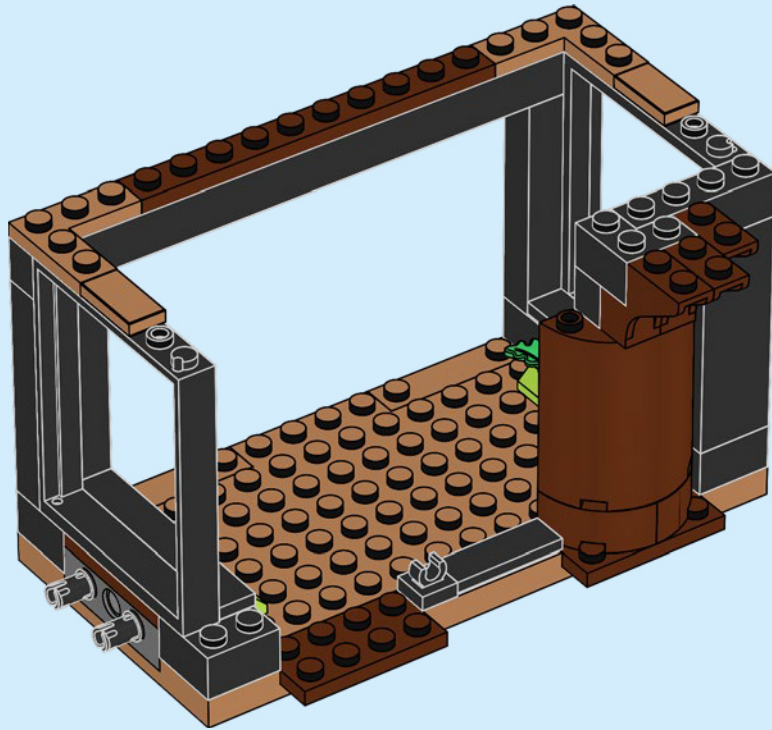

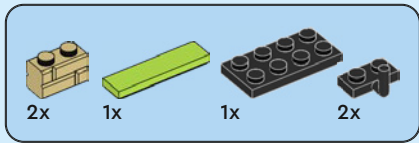

28

1

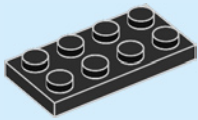

2

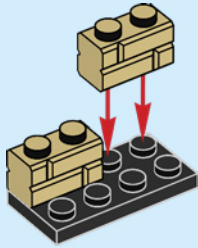

3

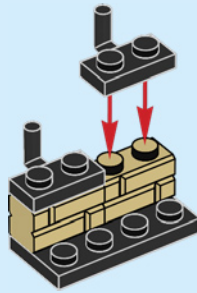

4

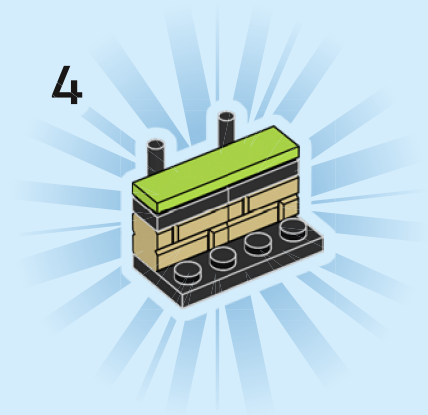

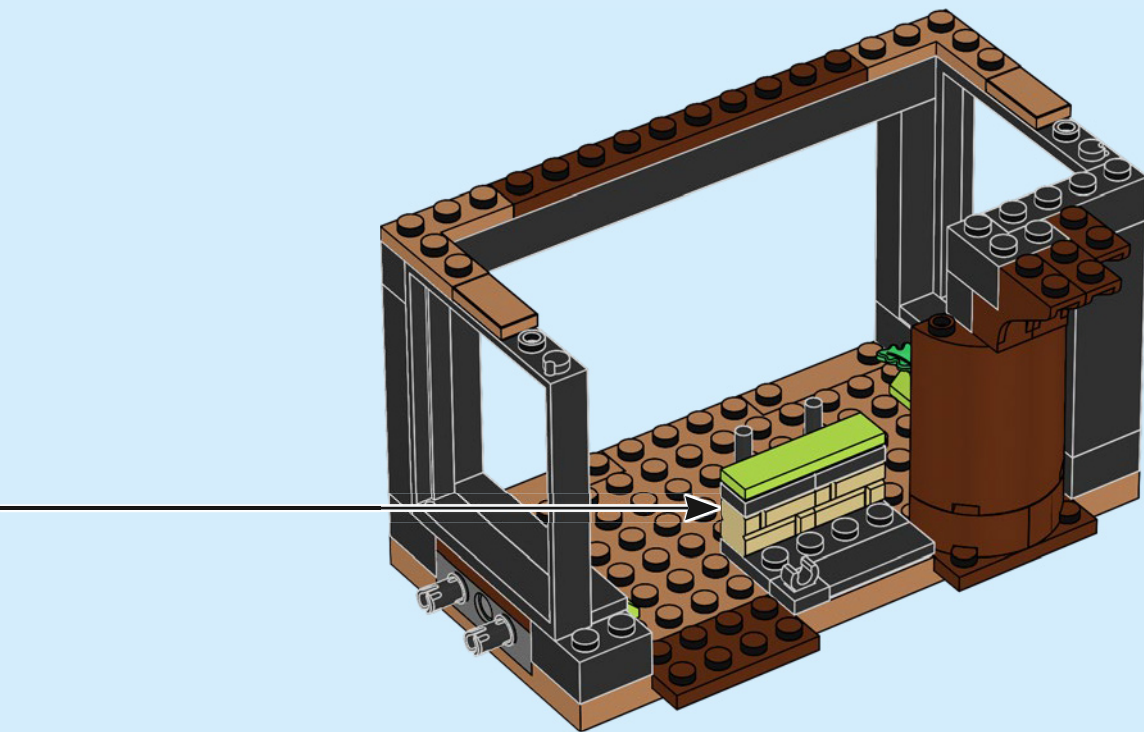

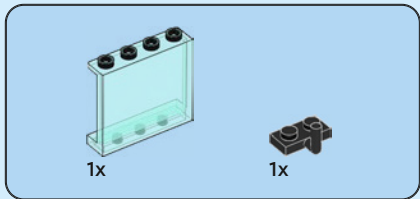

29

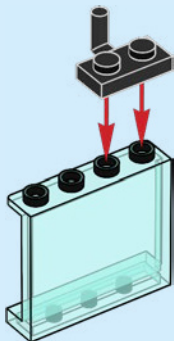

30

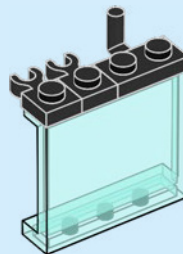

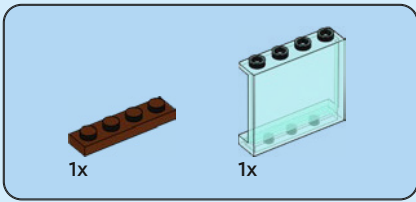

31

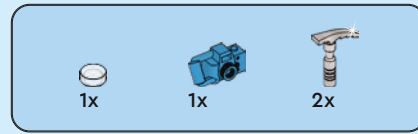
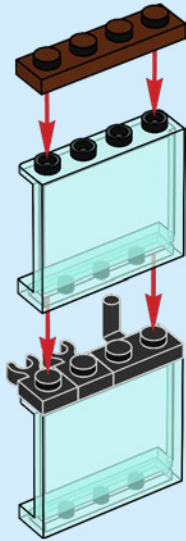

32

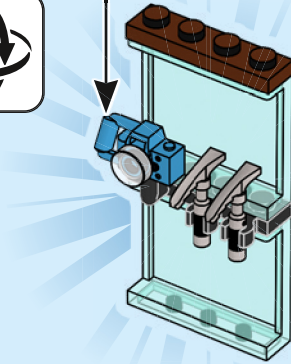
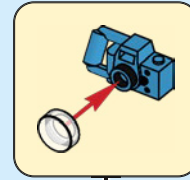

33

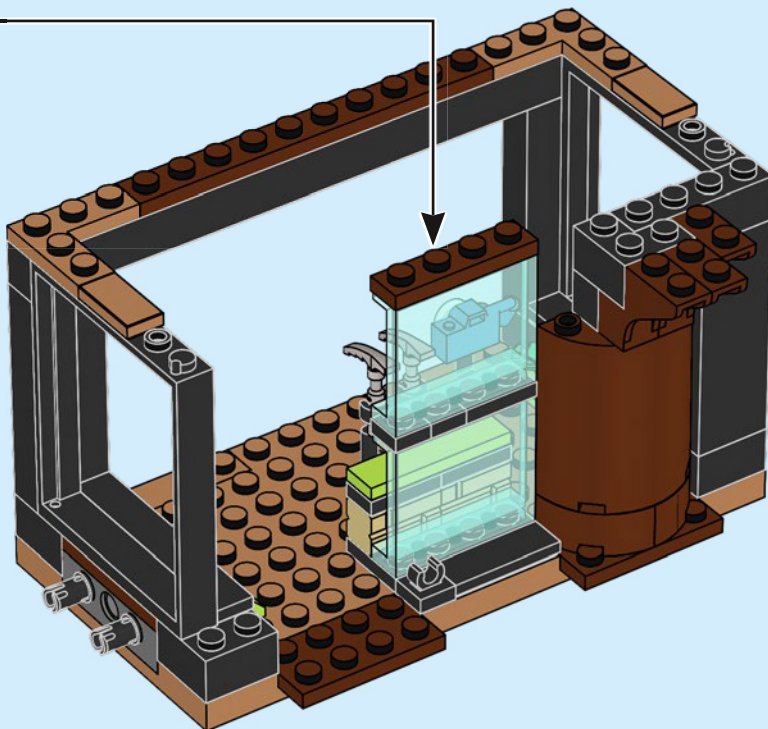

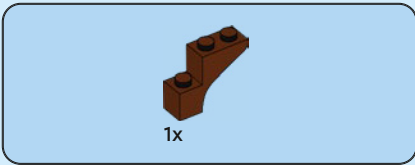

34

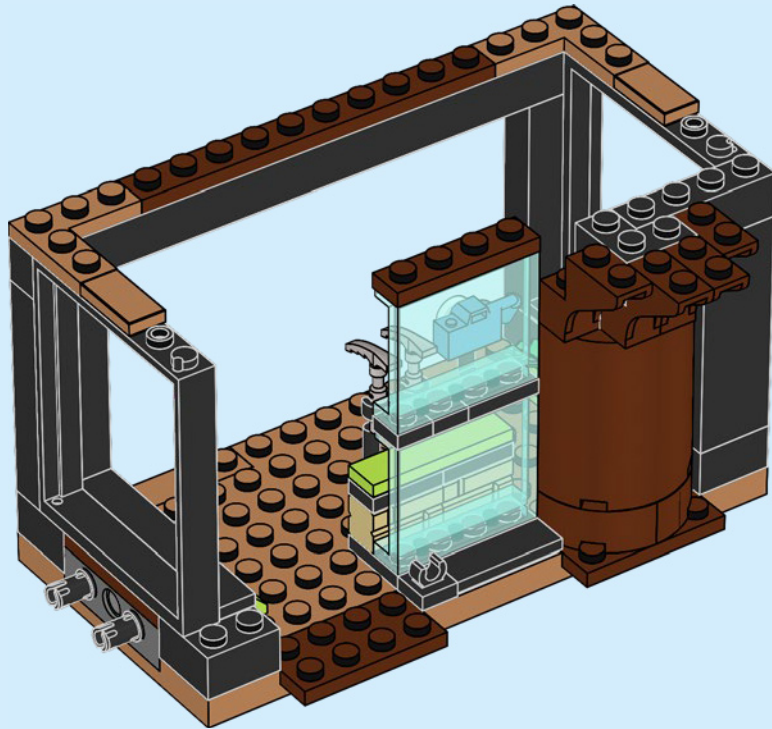



1x

35

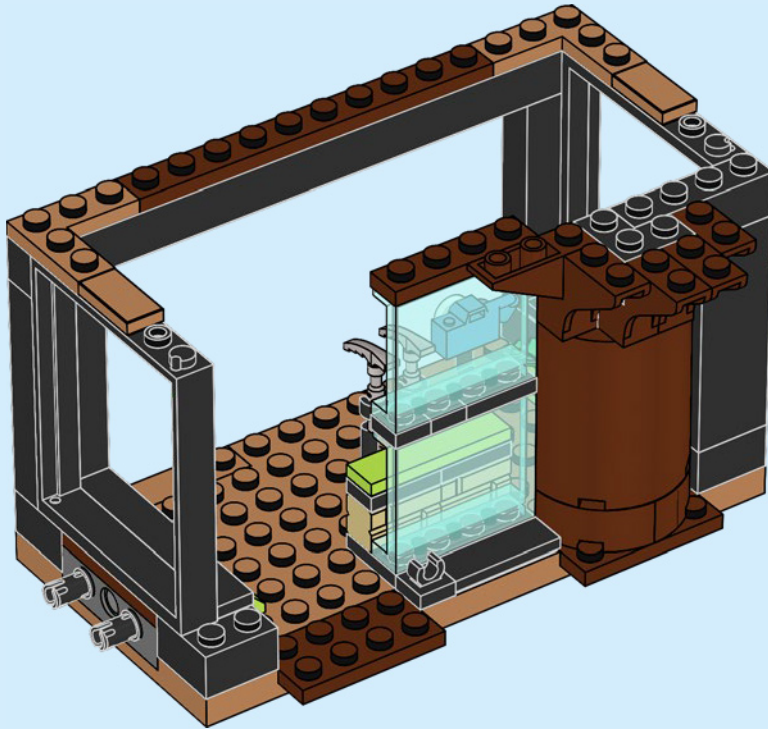



1x



3x

36

1

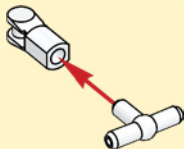

2

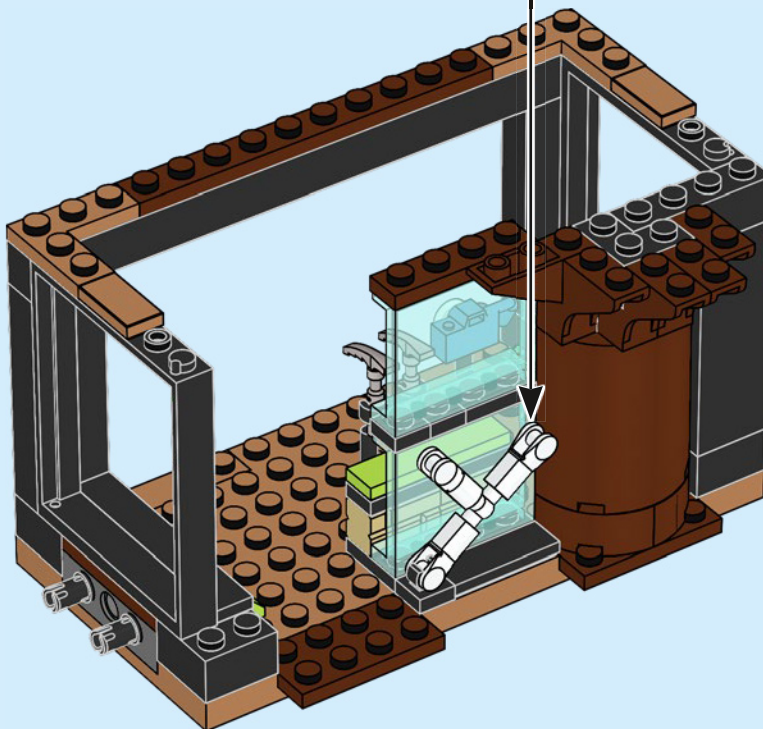
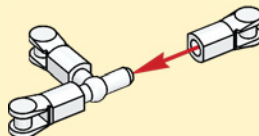

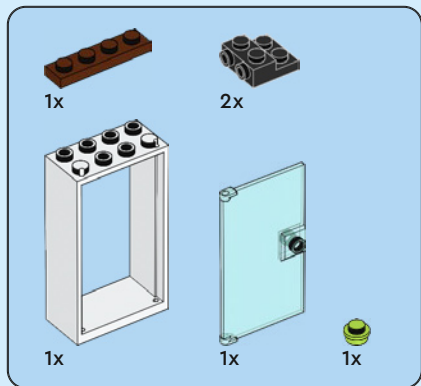

37

1

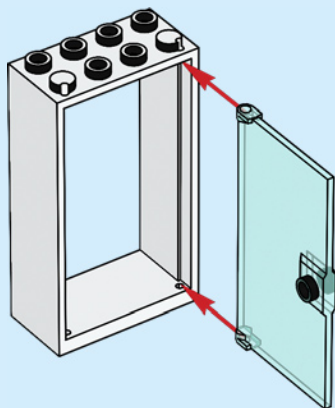

2

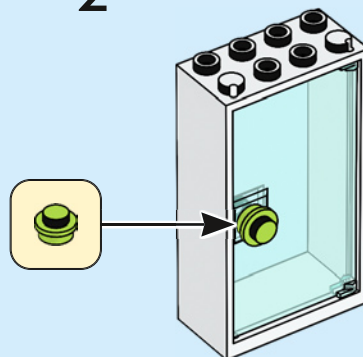

3

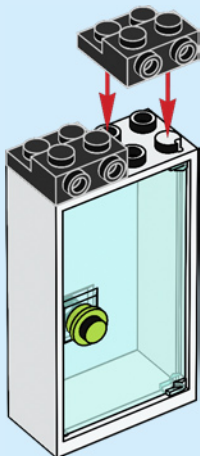

4

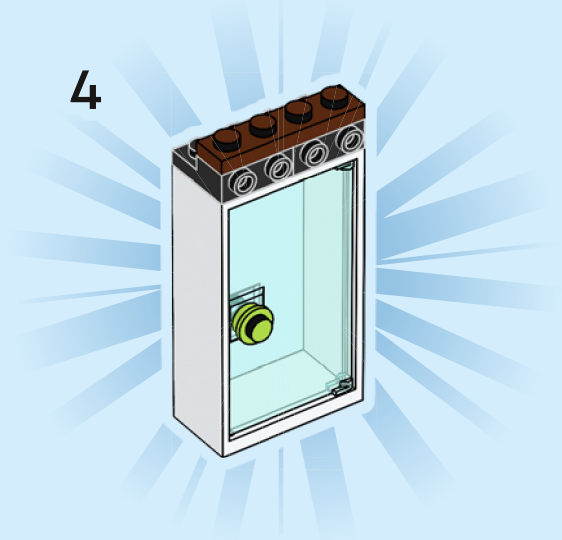

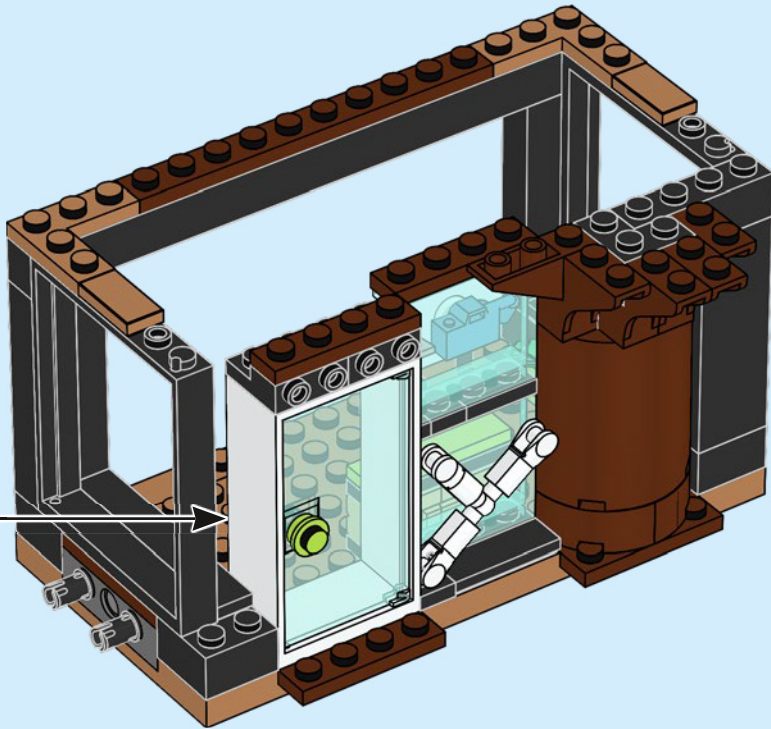

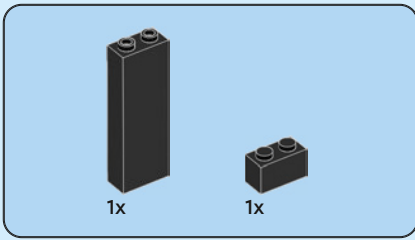

38

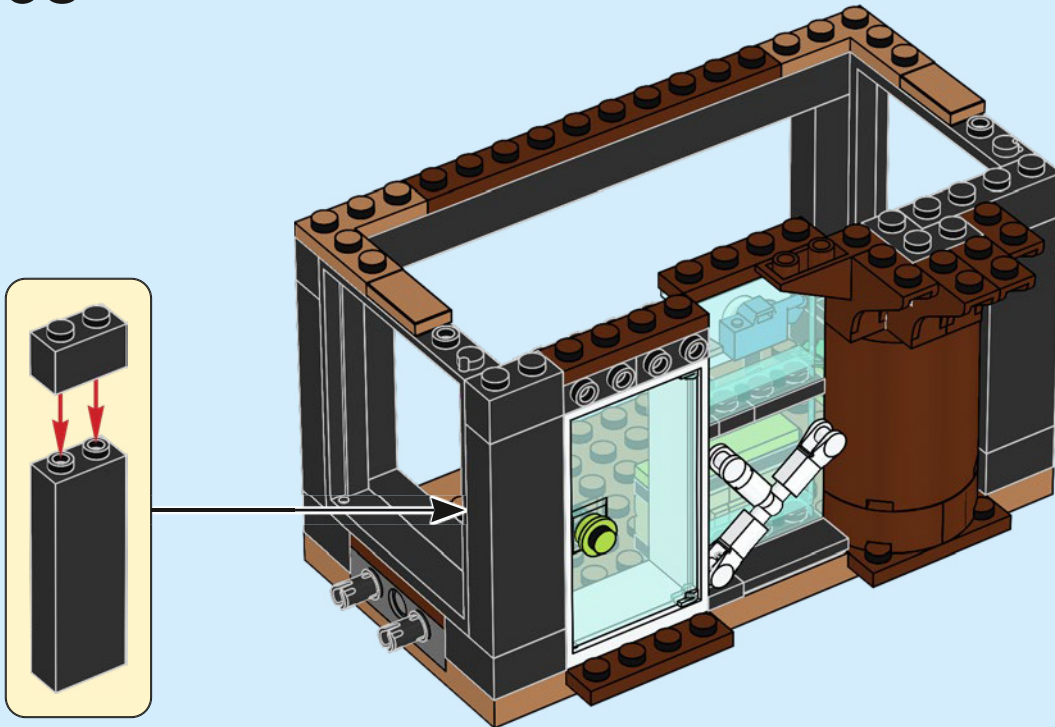

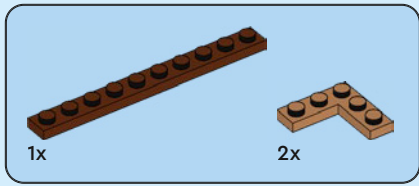

39

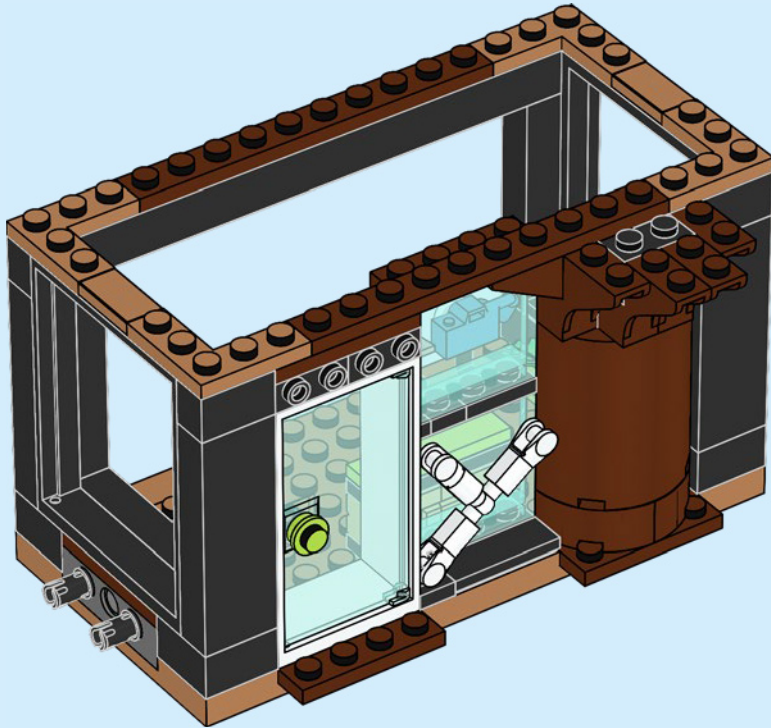



2x

40

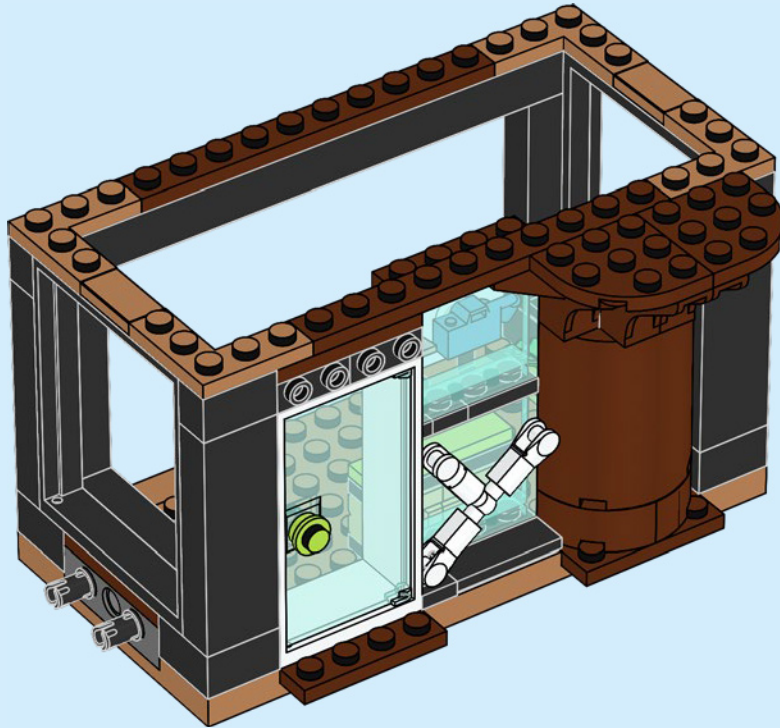

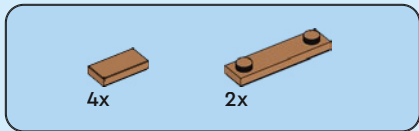

41

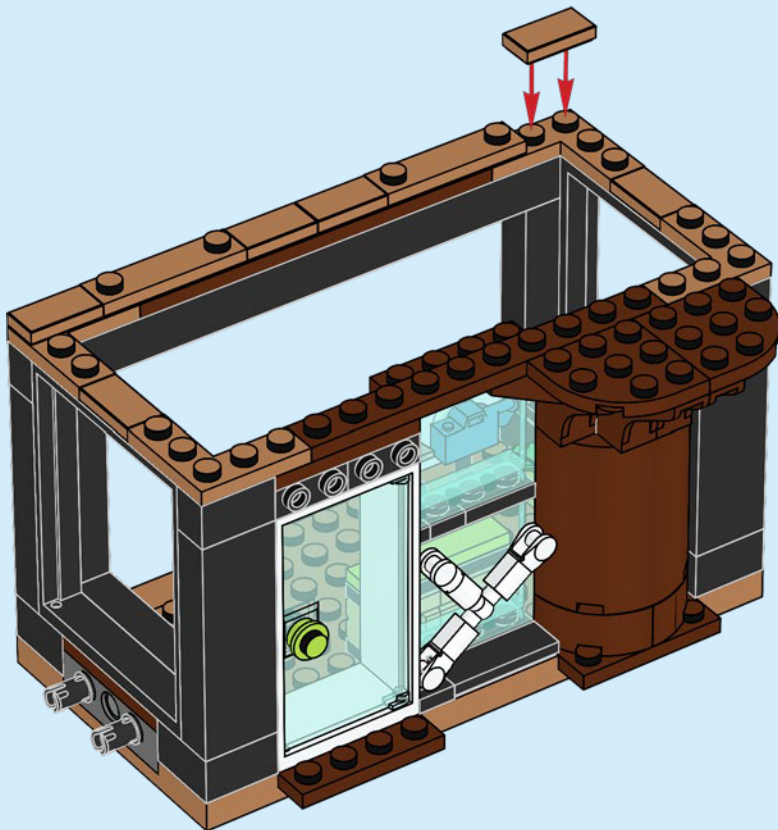

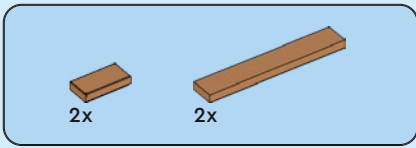

42

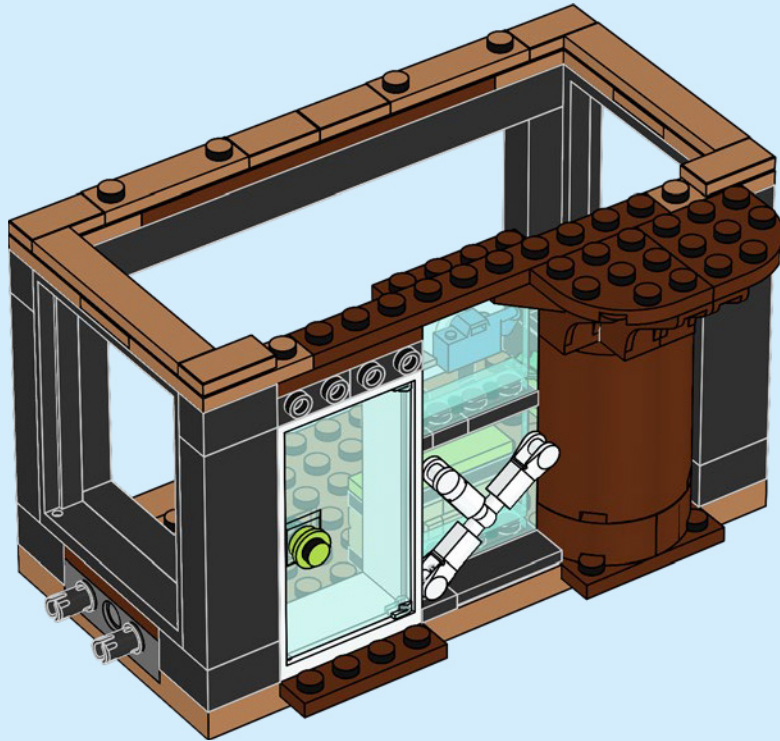



2x

43

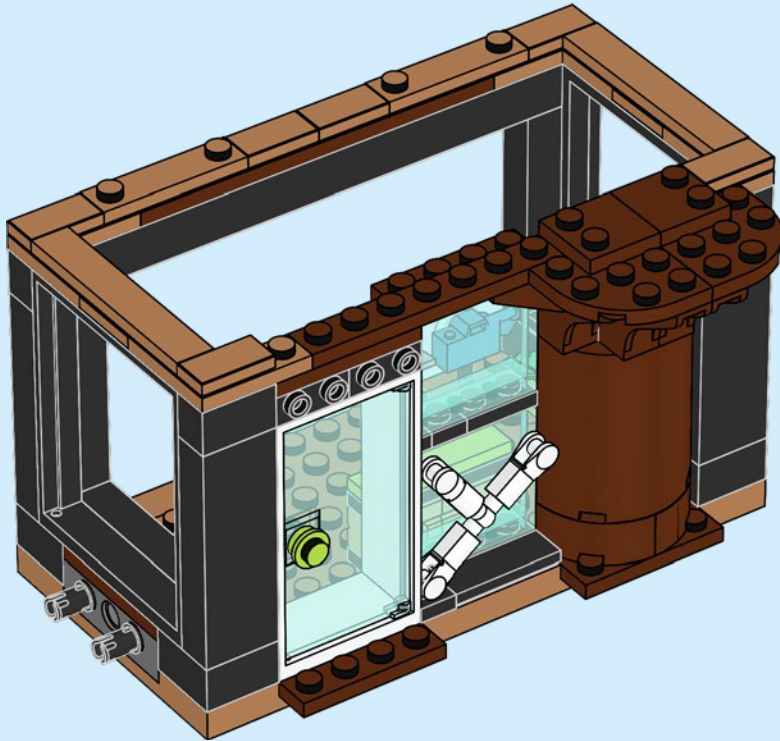



2x

44



2x

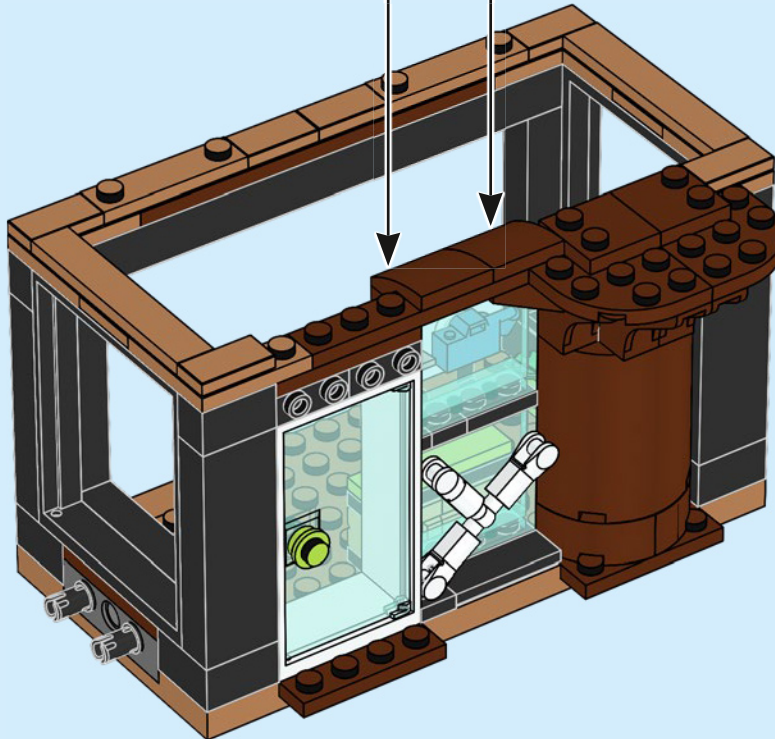



2x

45

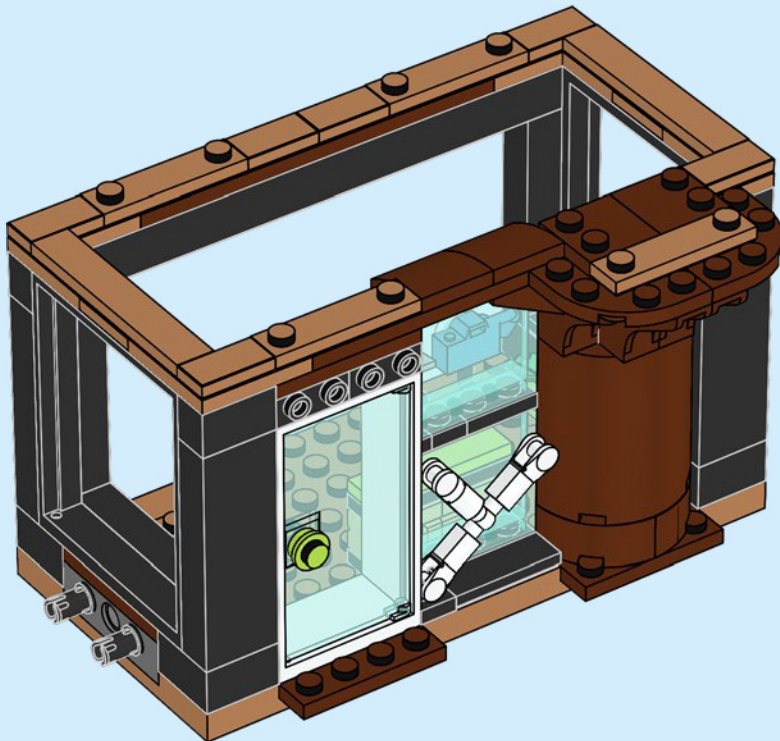



4x

46

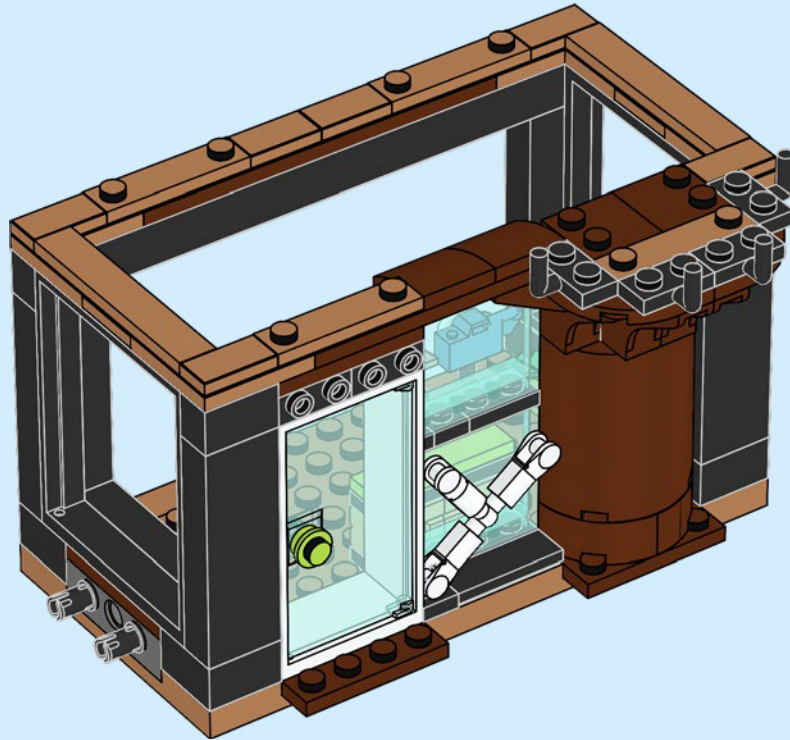



2x

47

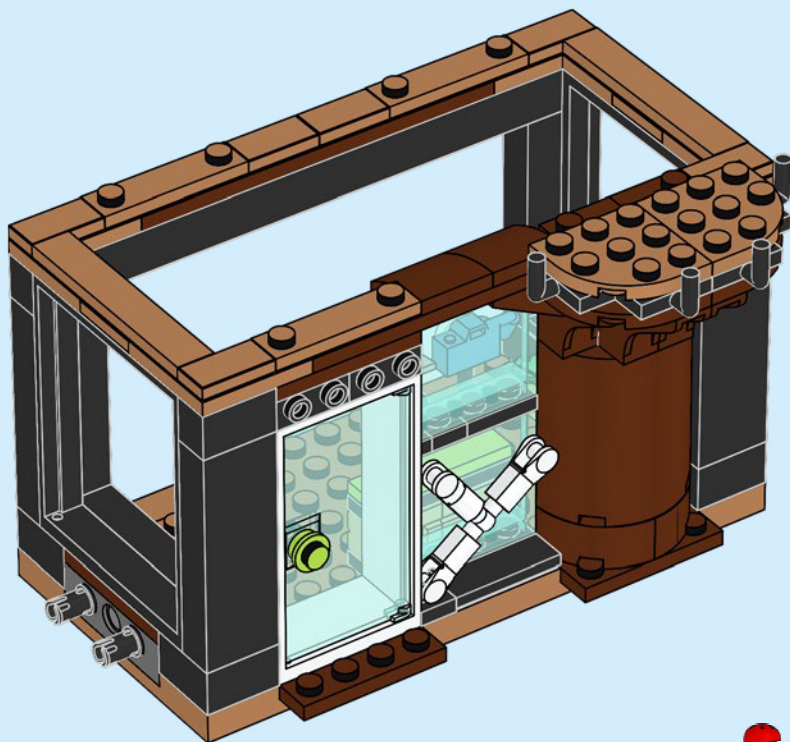

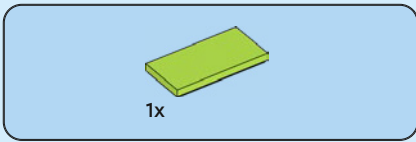

48

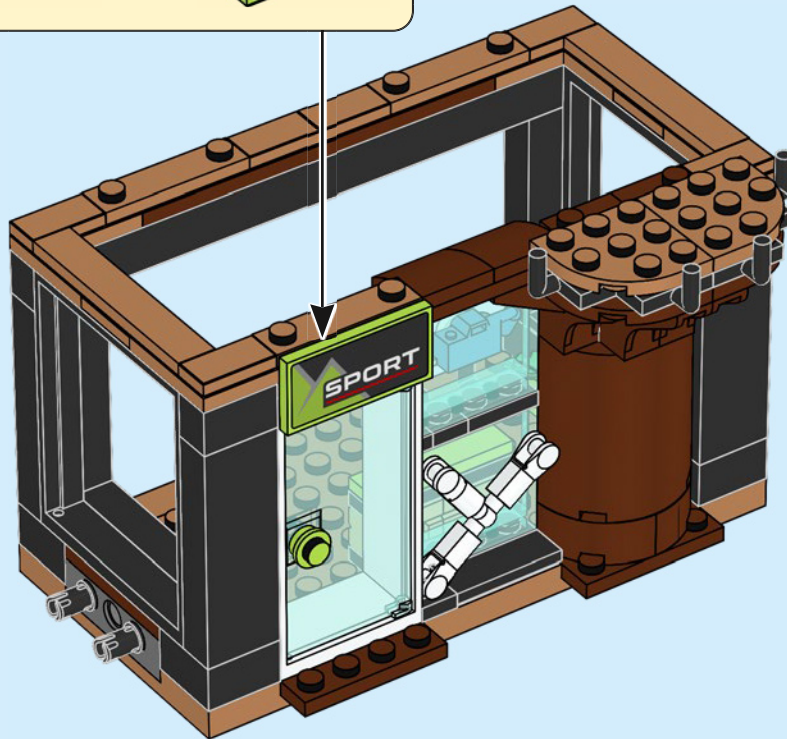
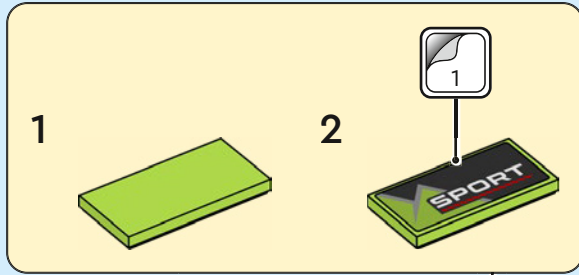



2x

49

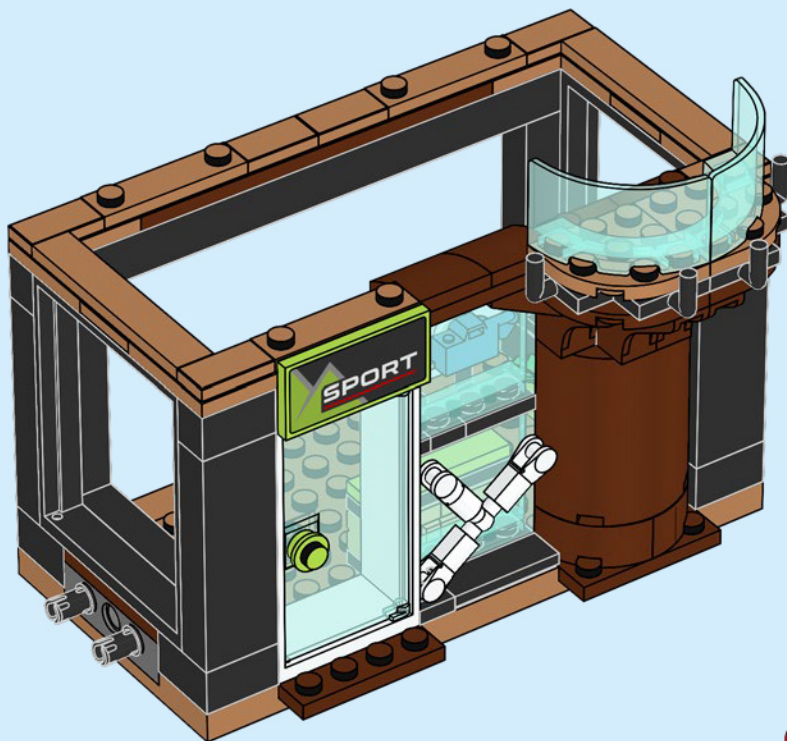



2x



1x

50

1



2

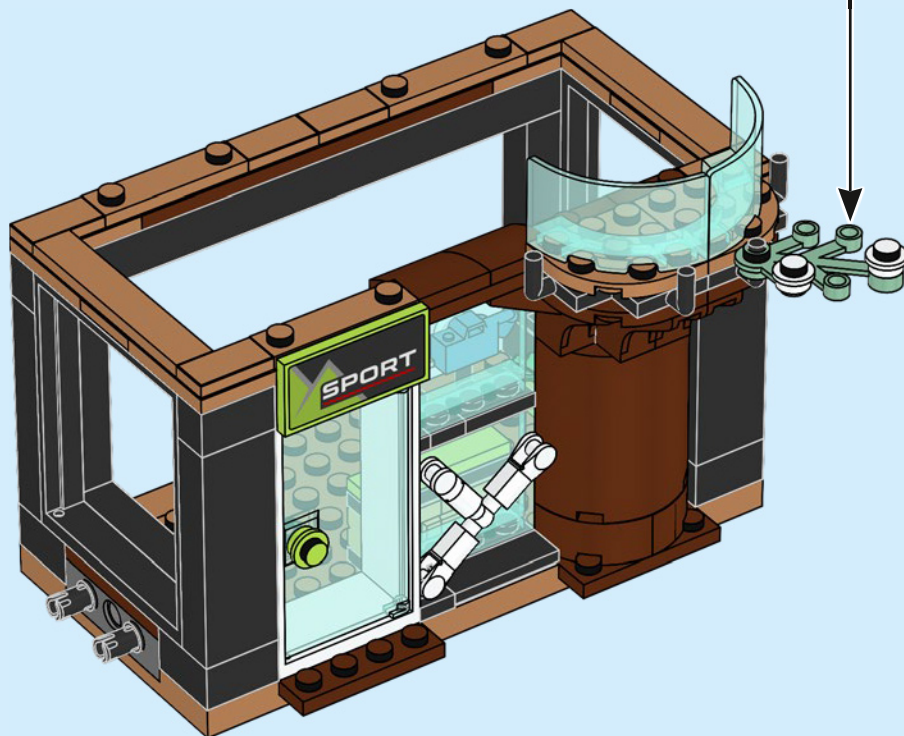

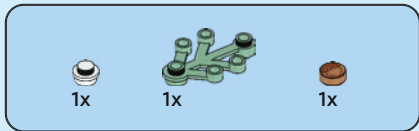

51

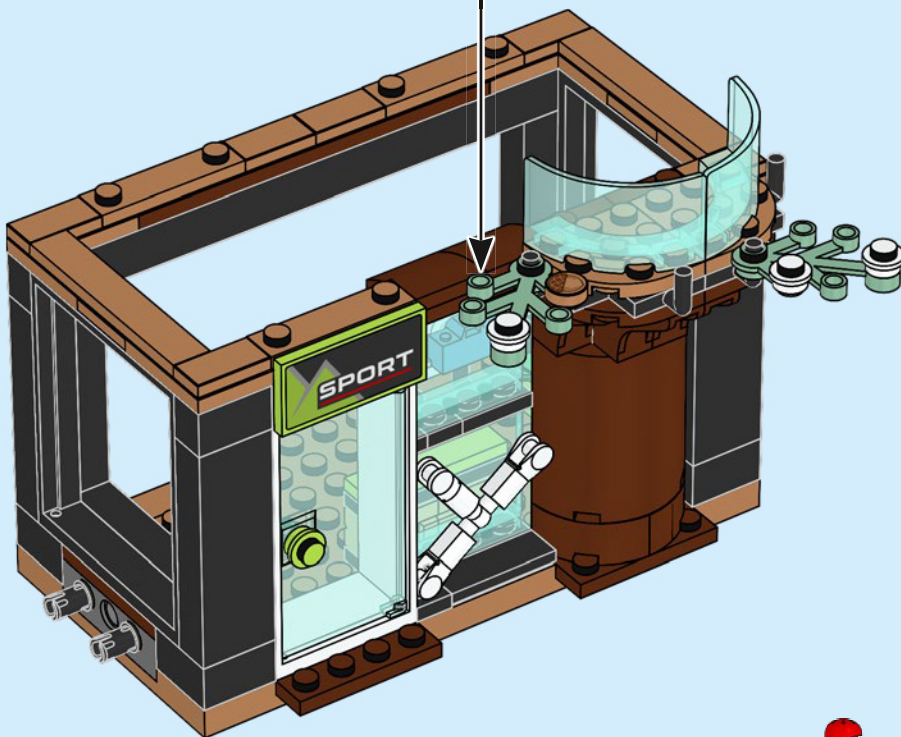
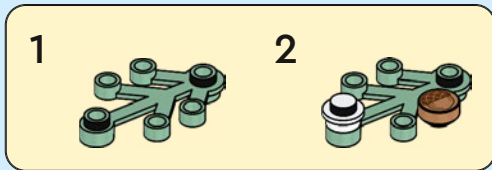

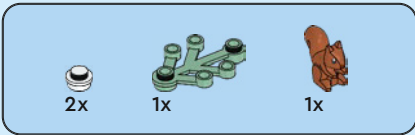

52

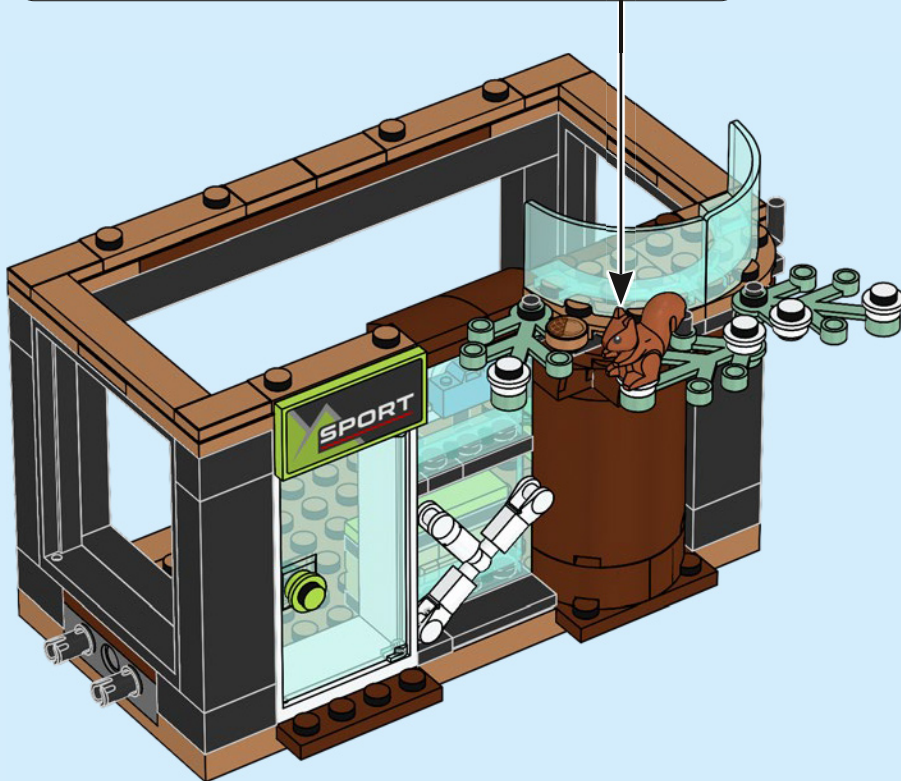
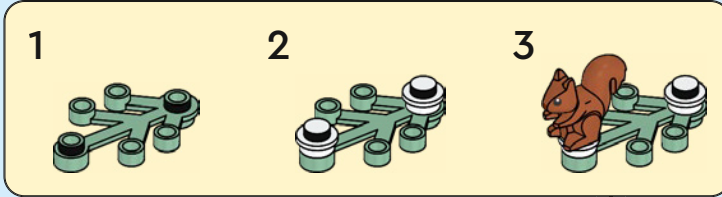

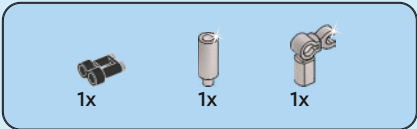

53

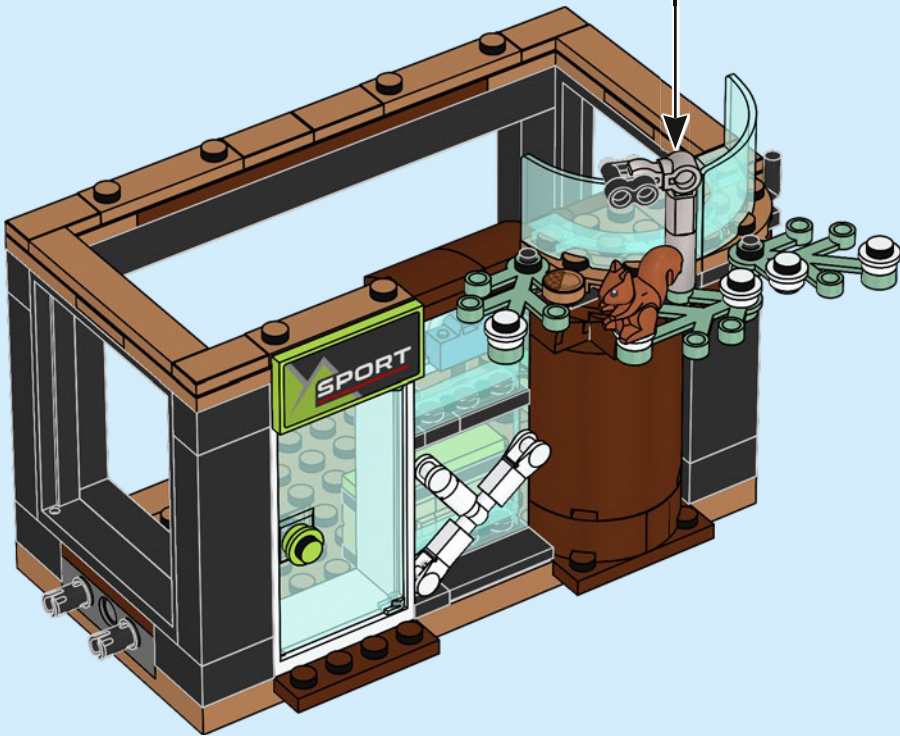
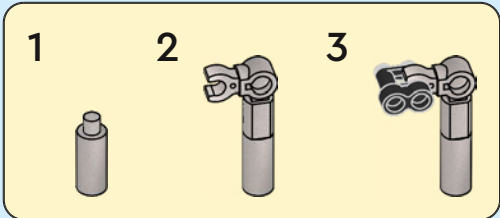



1x



1x

54

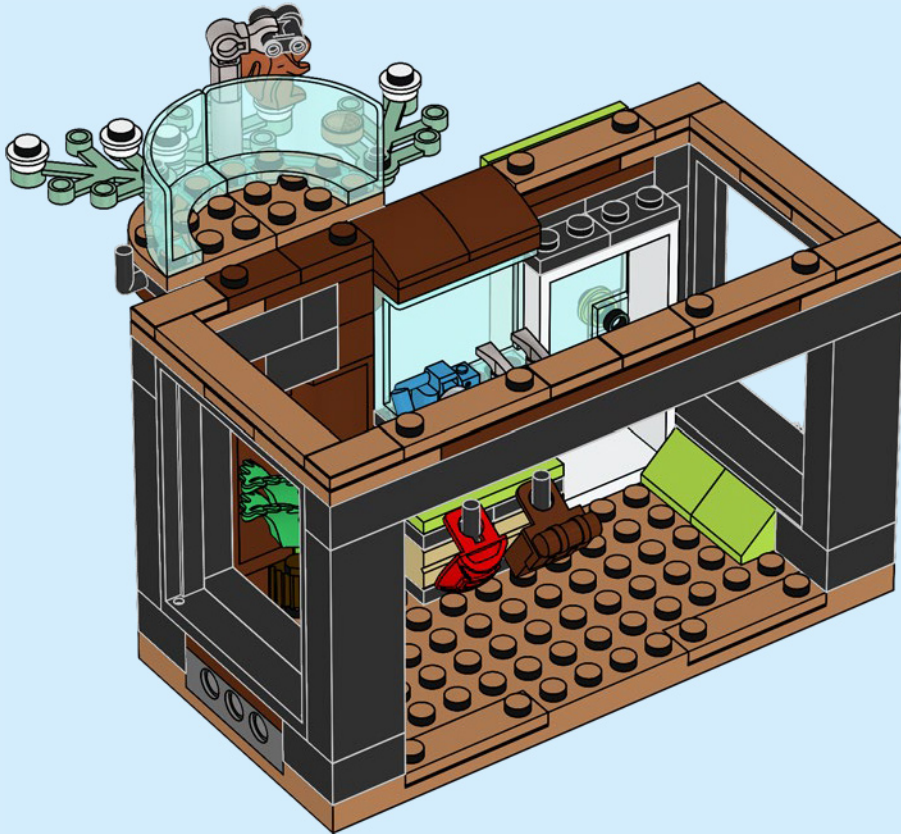

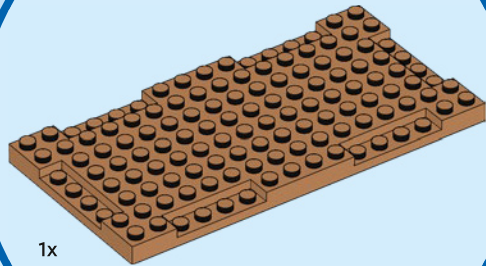
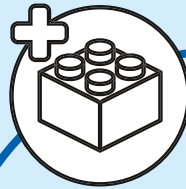

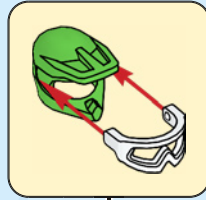
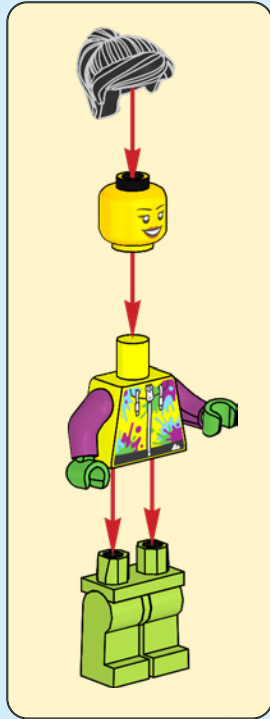

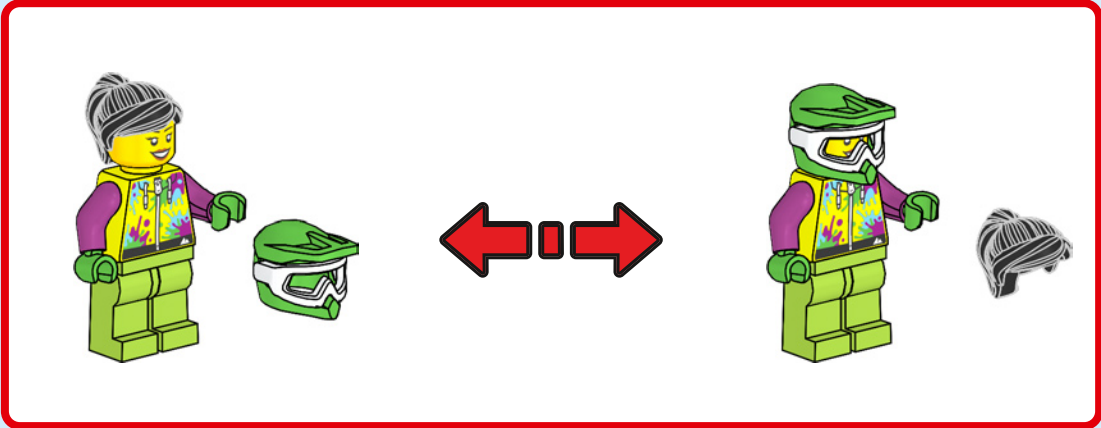

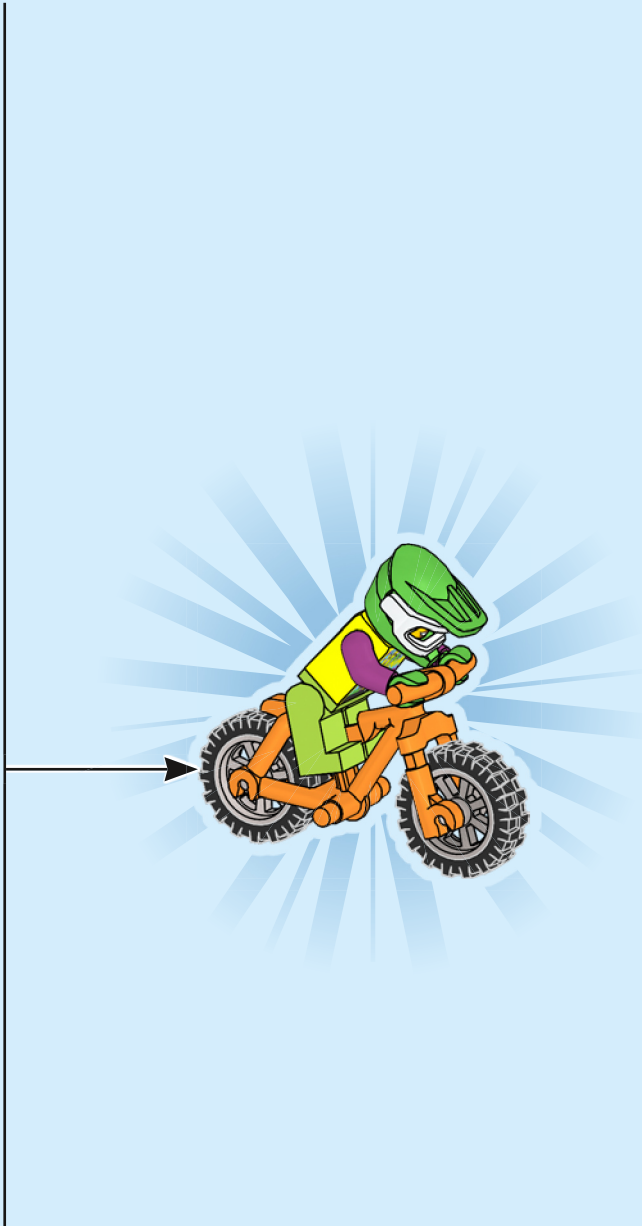
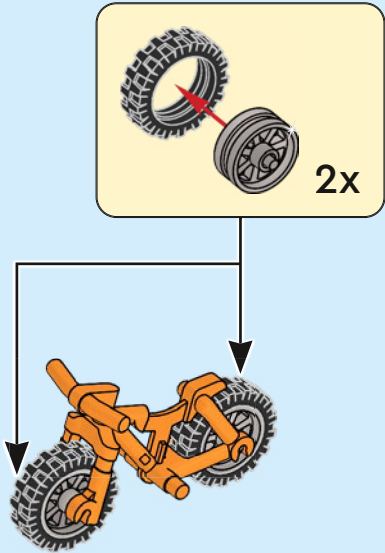

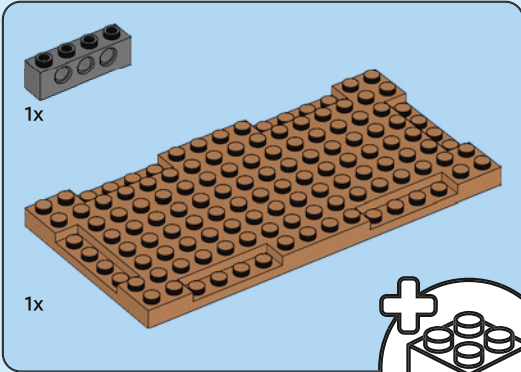
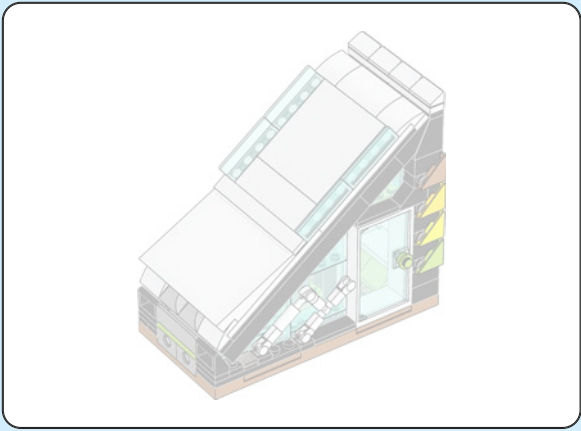

55

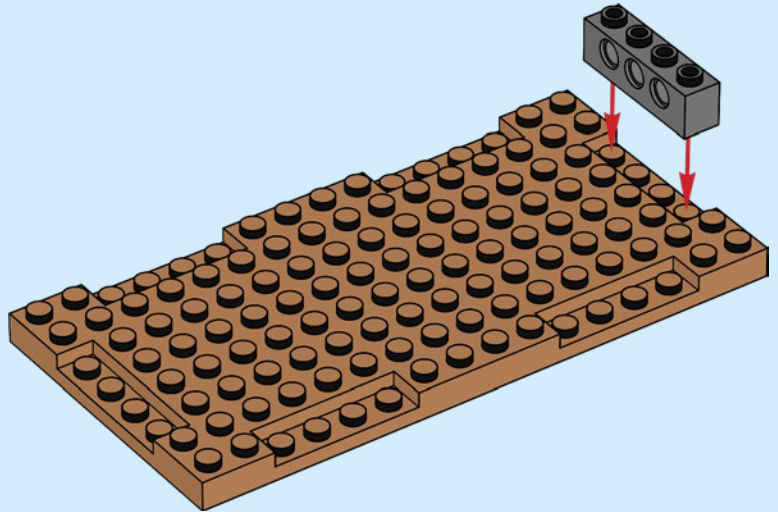

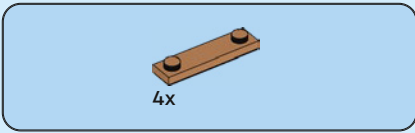

56

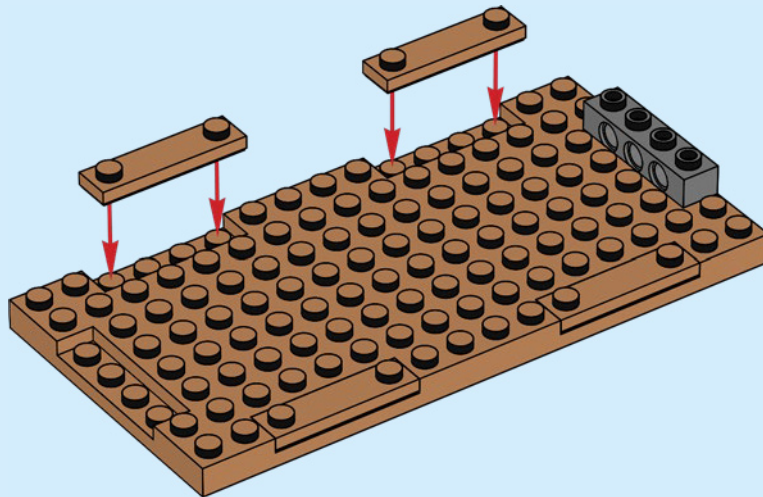

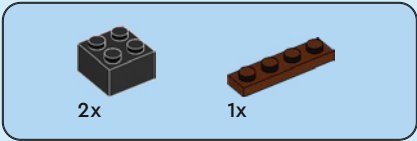

57

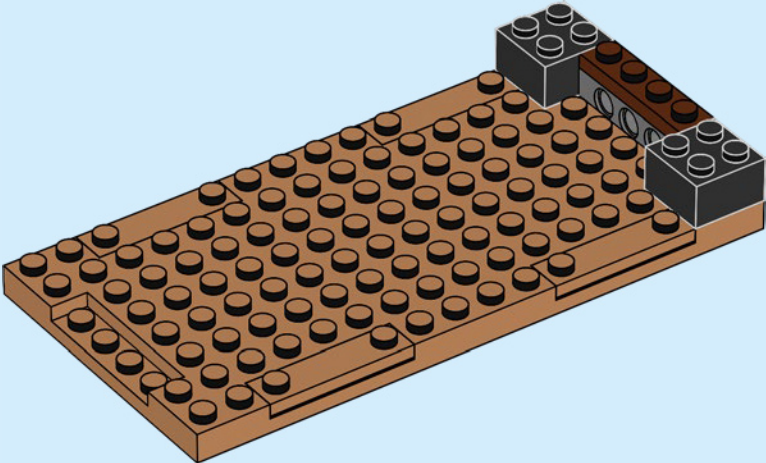



2x

58

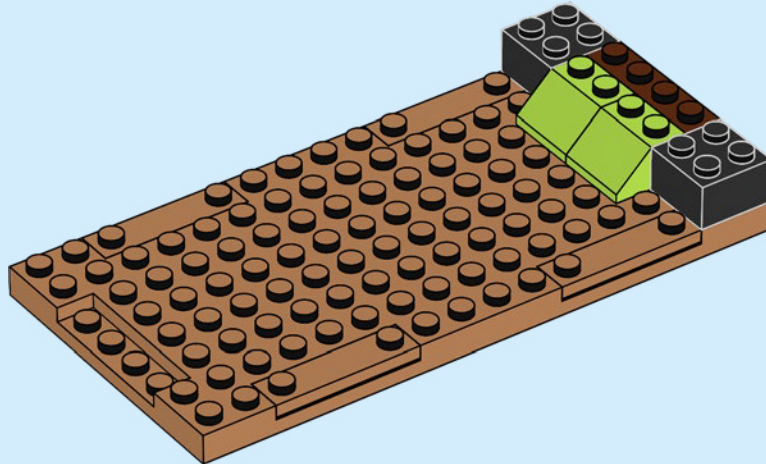

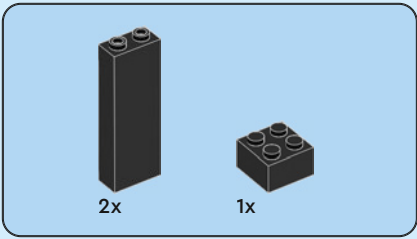

59

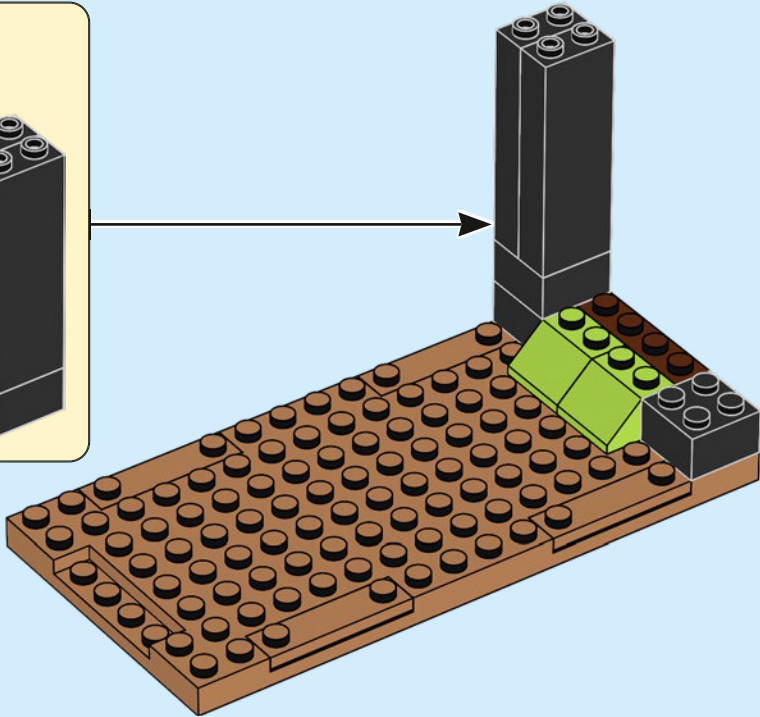
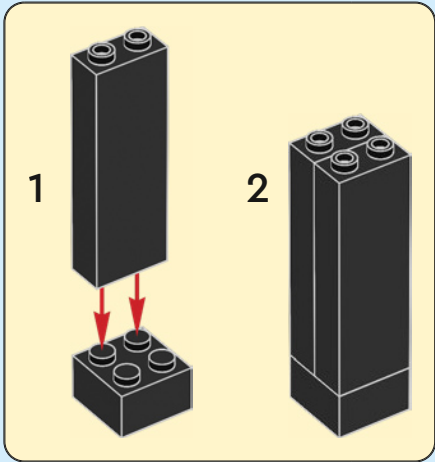

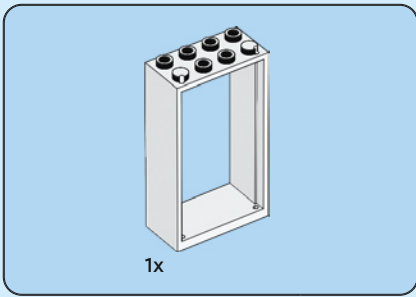

60

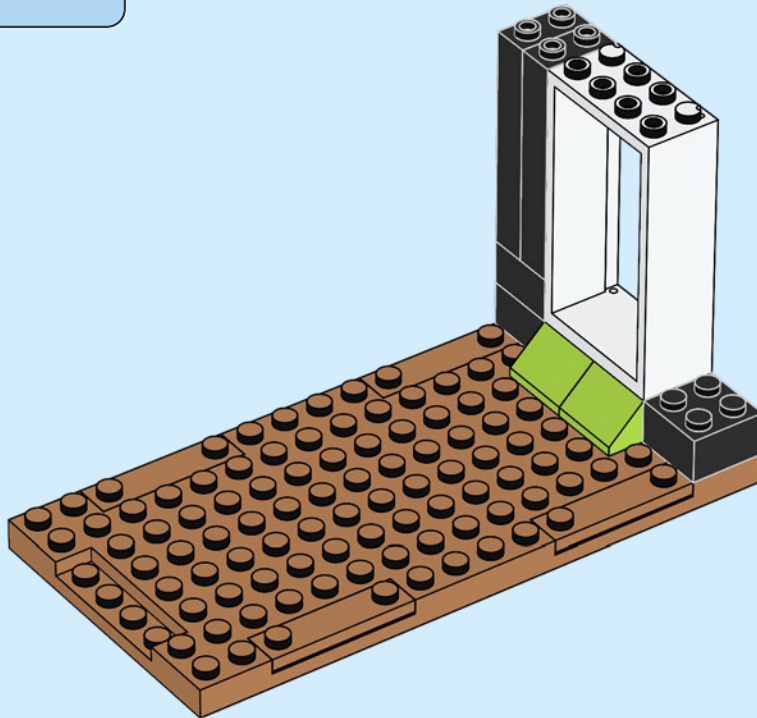

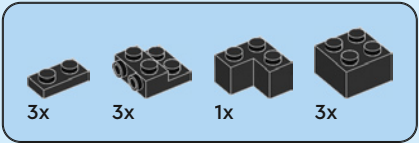

61

1

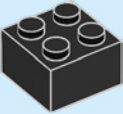

2

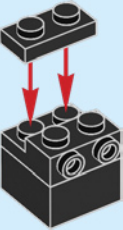

3

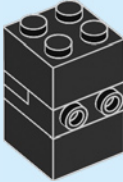

4

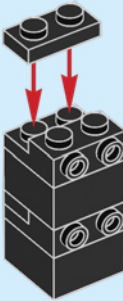

5



6

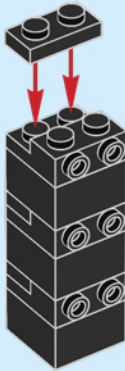

7

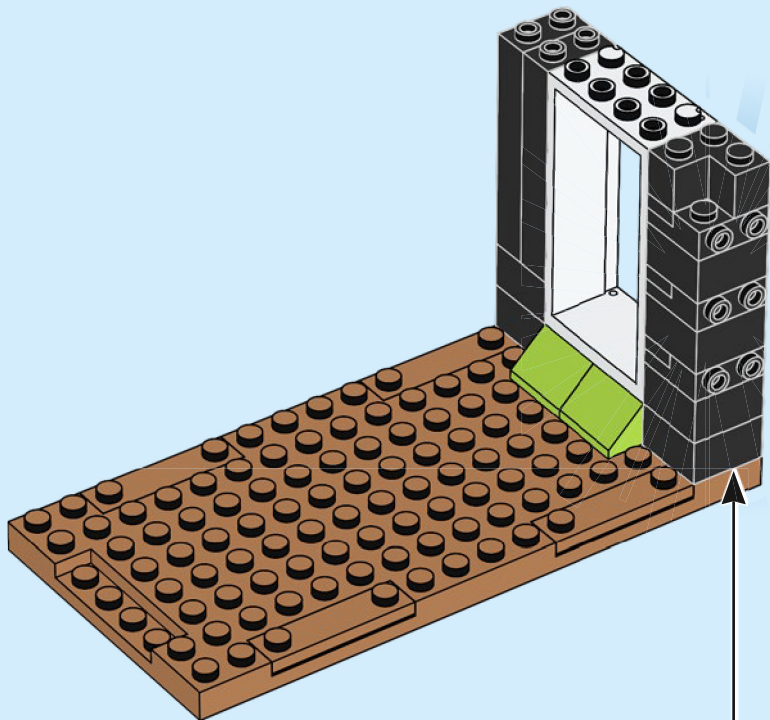

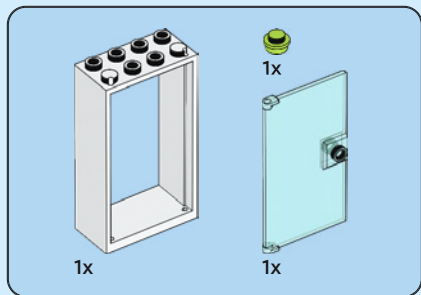

62

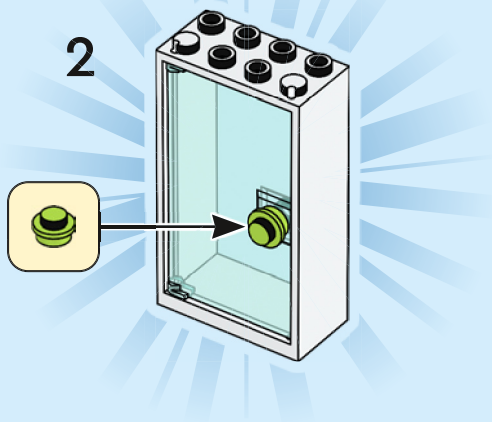
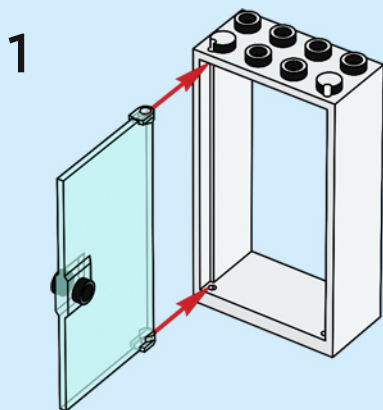

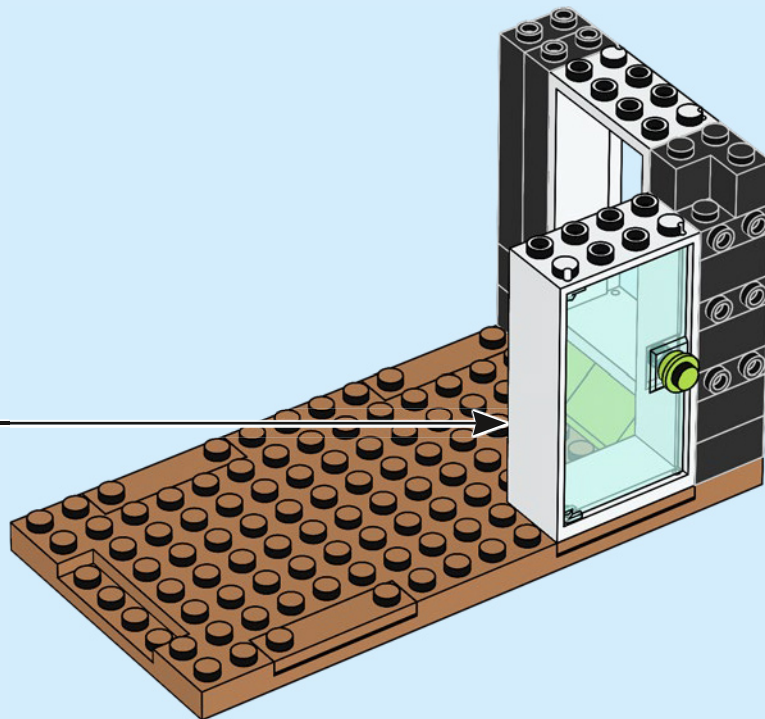



1x



1x

63

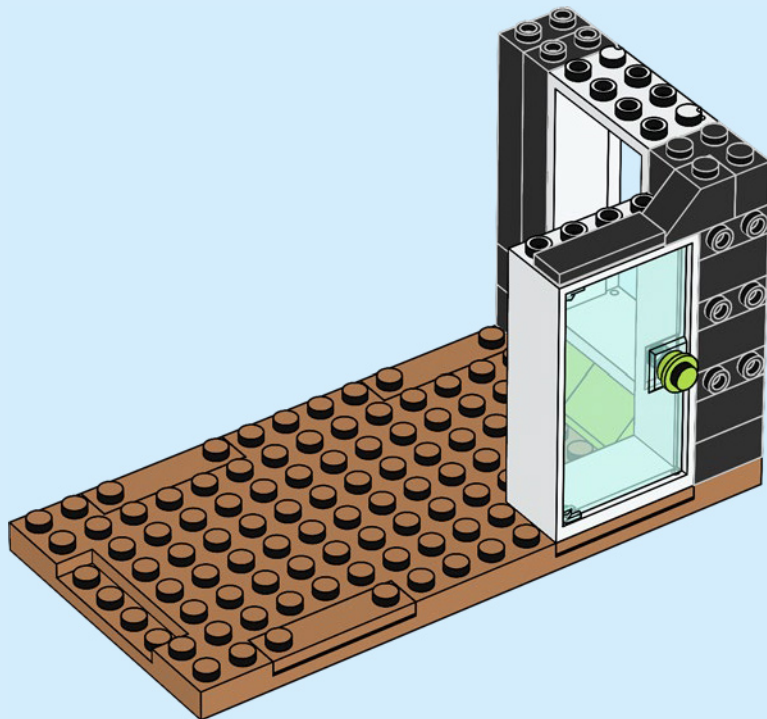

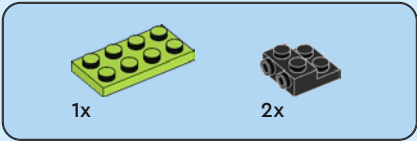

64

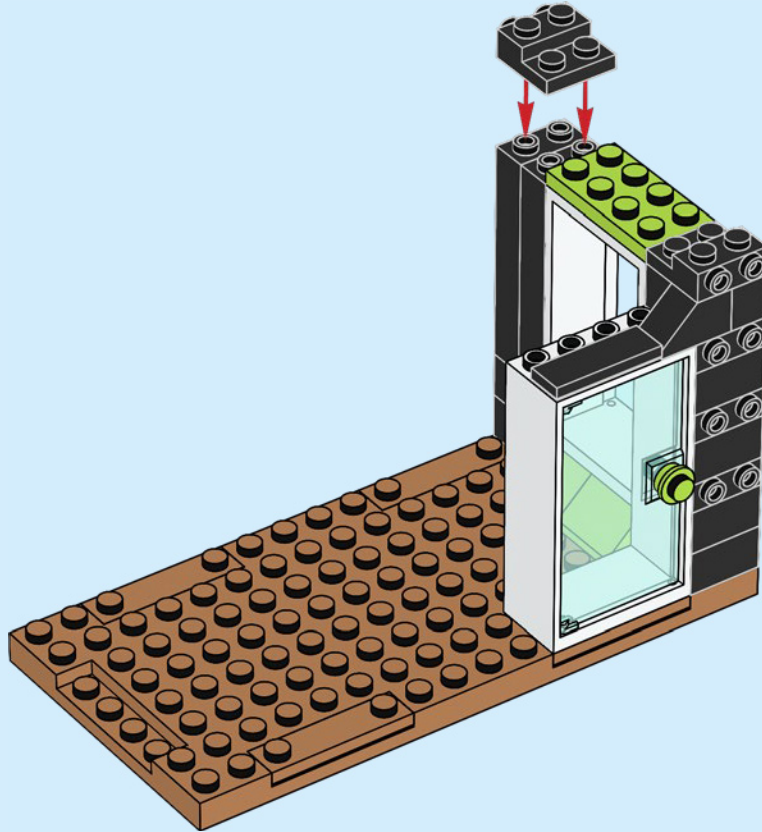

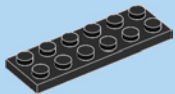

1x

65

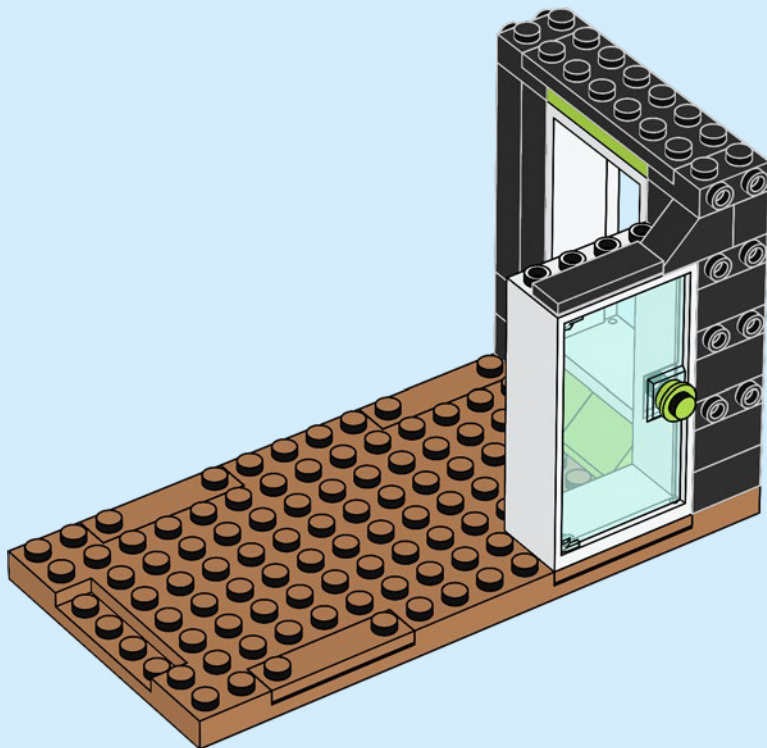

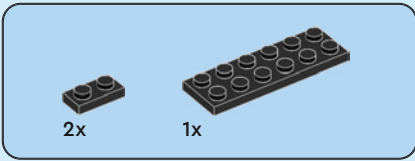

66

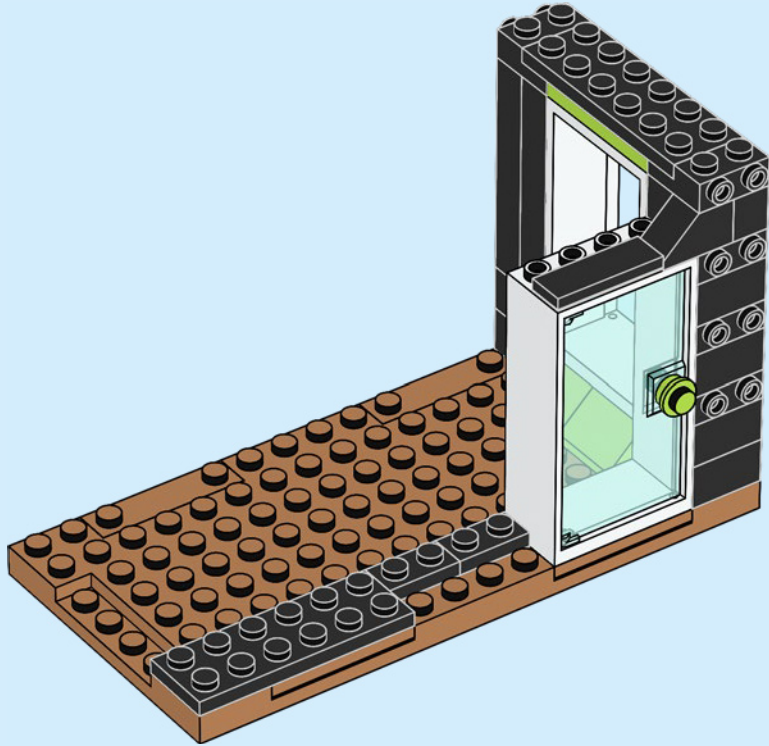



1x



1x

67

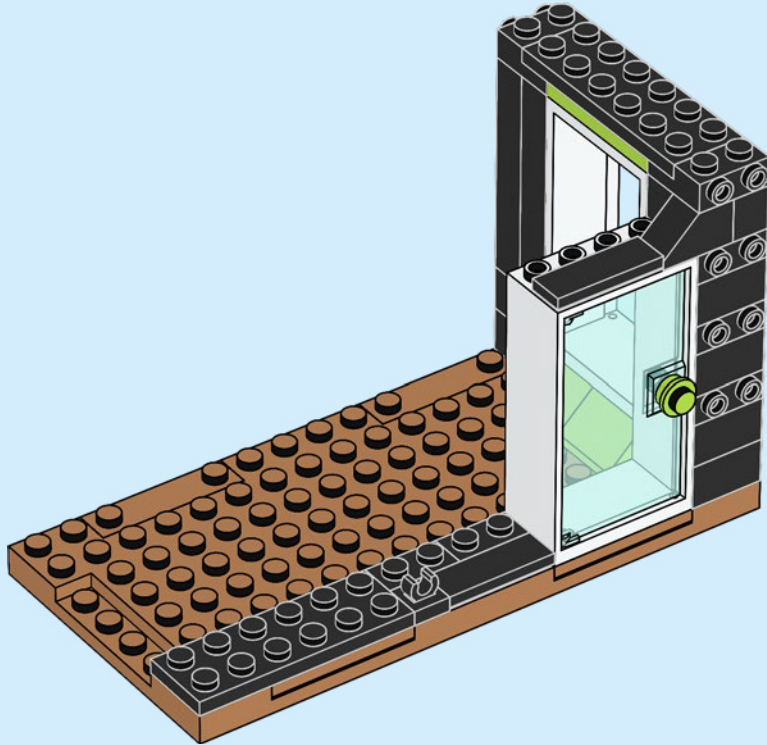



2x

68

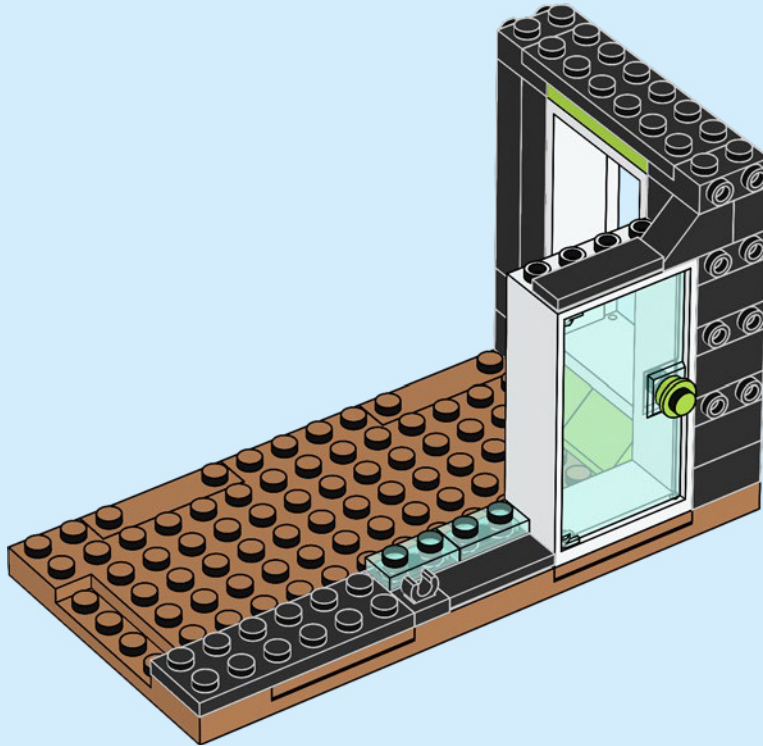

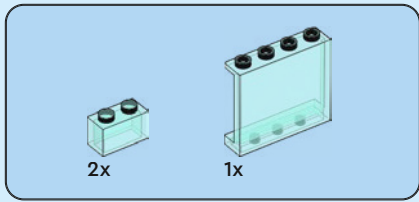

69

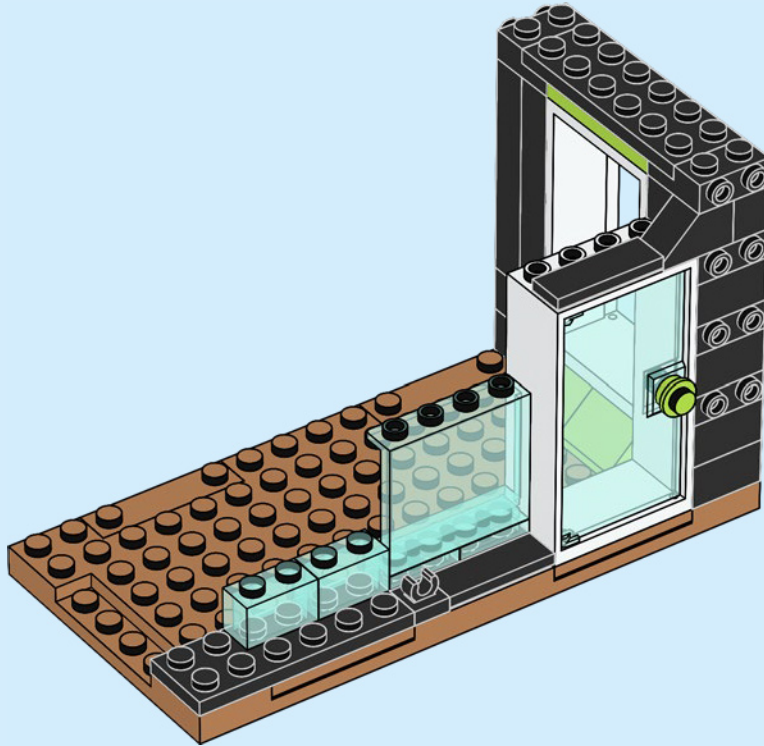



1x



1x

70

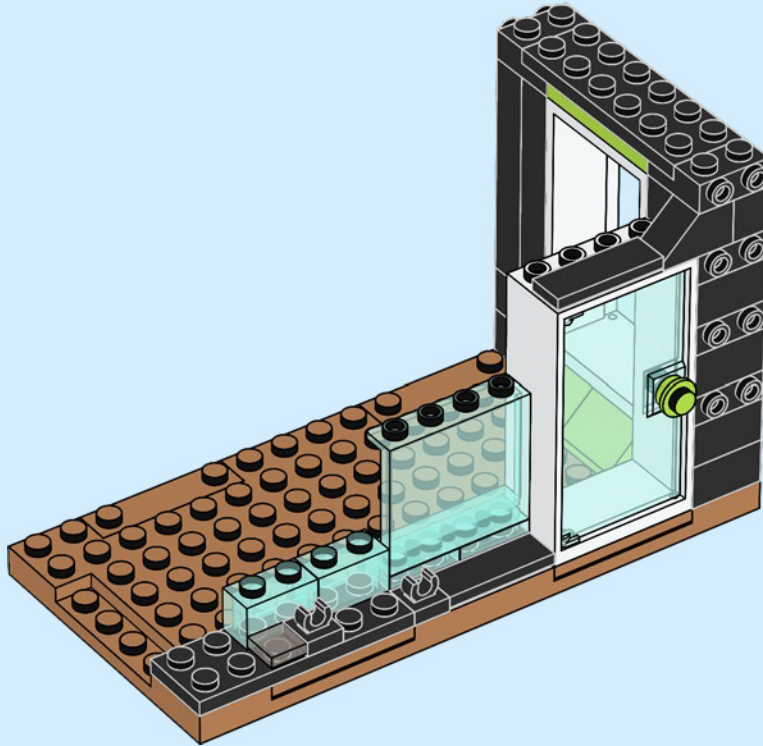

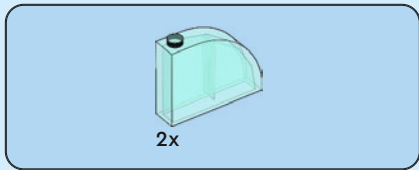

71

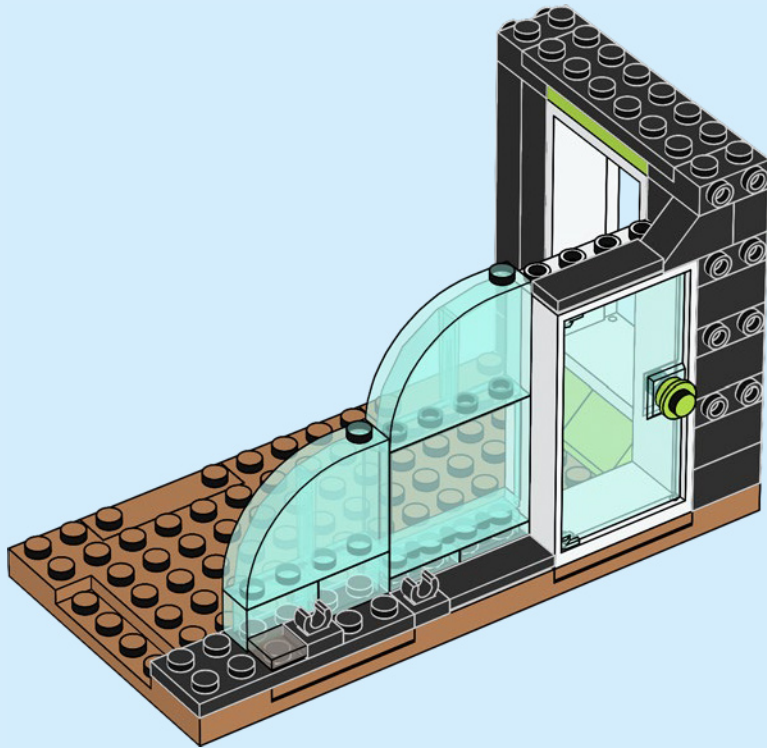

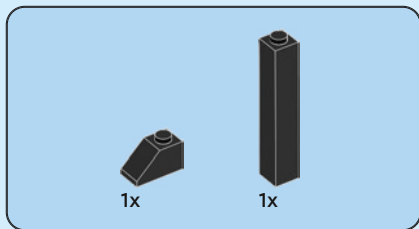

72

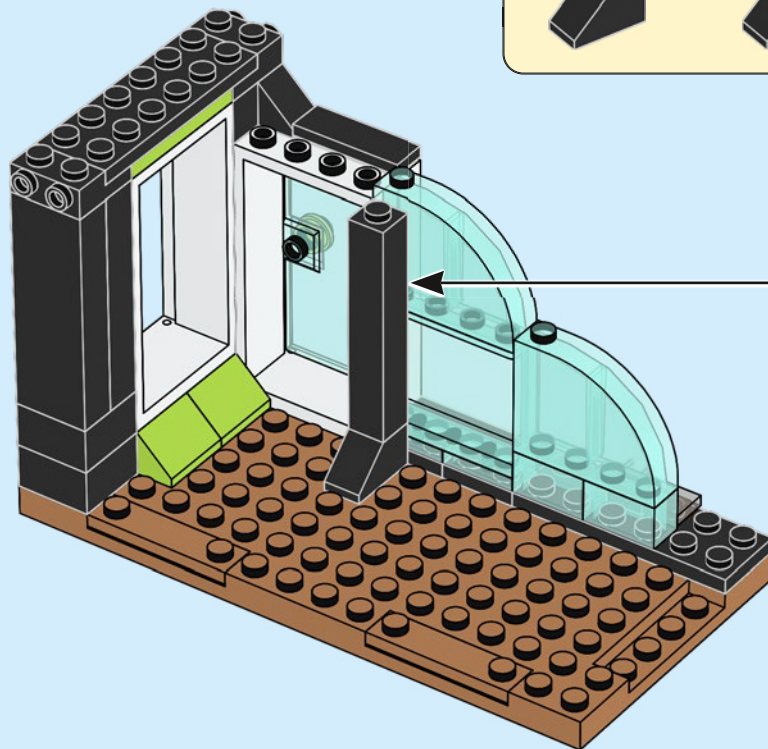
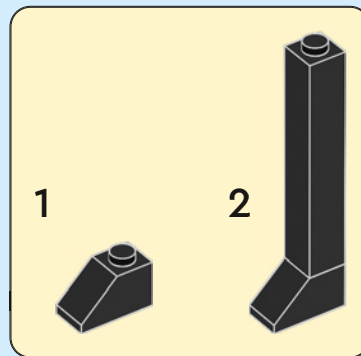

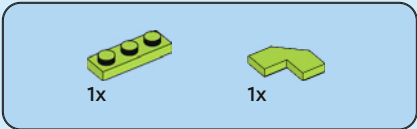

73

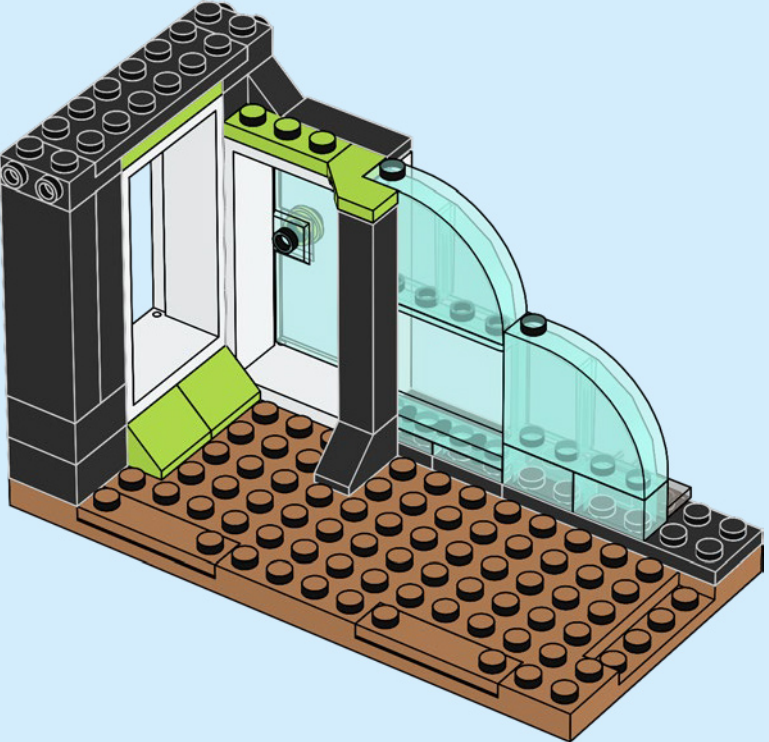

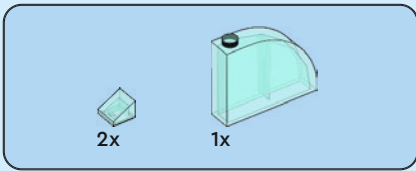

74

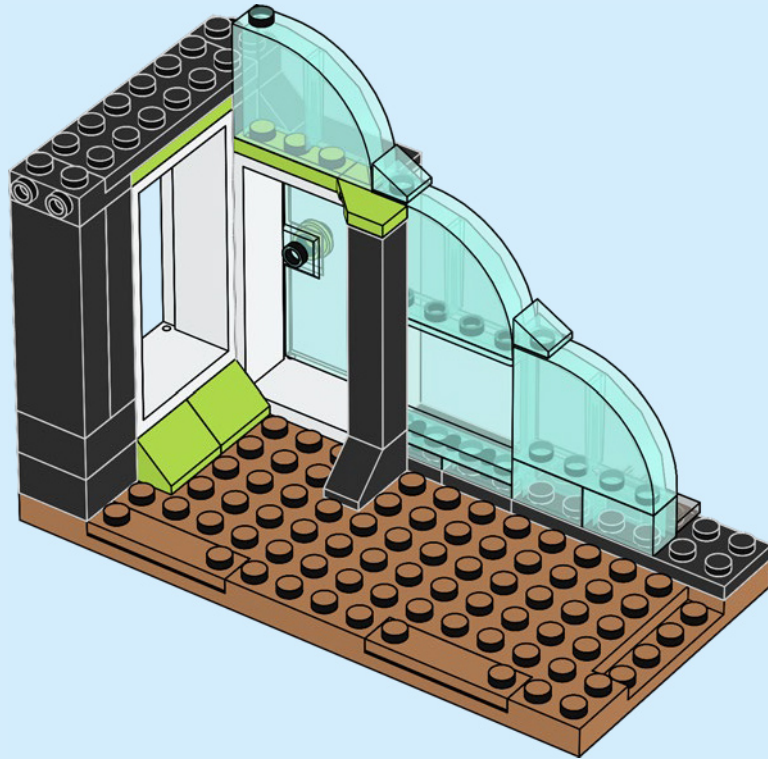

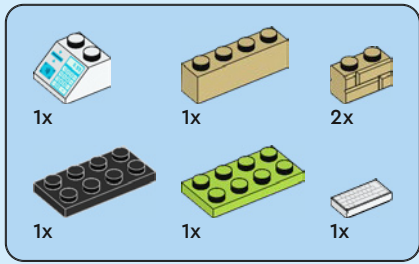

75

1

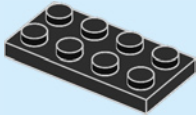

2

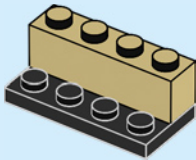

3

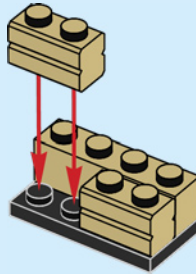

4

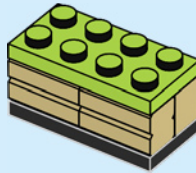

5



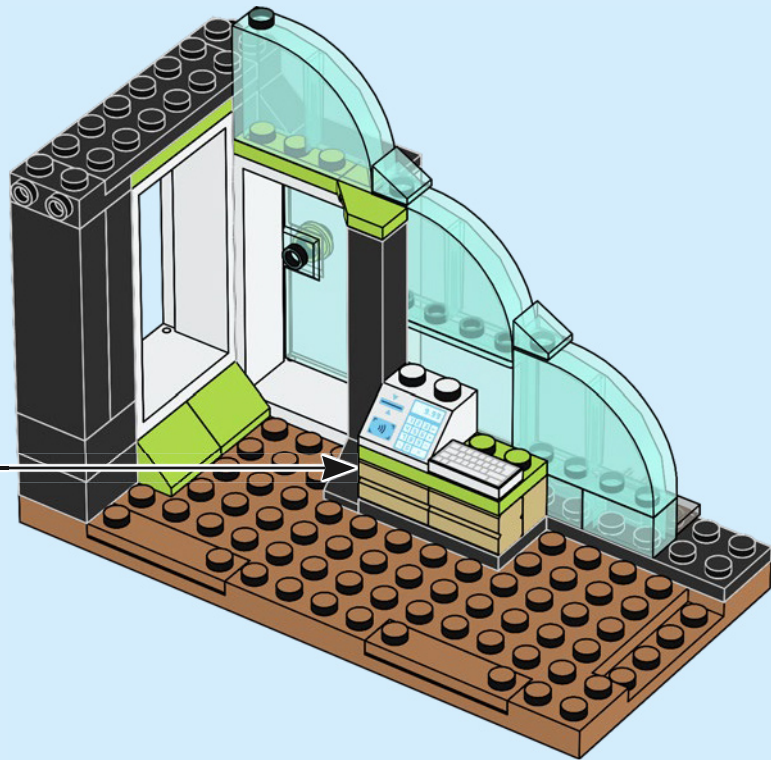



2x

76

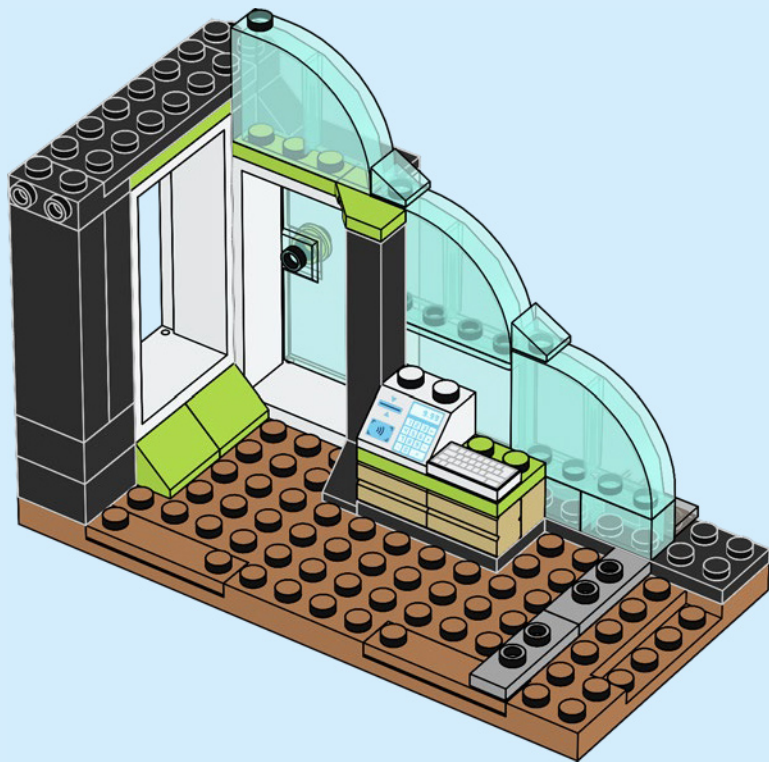



2x

77

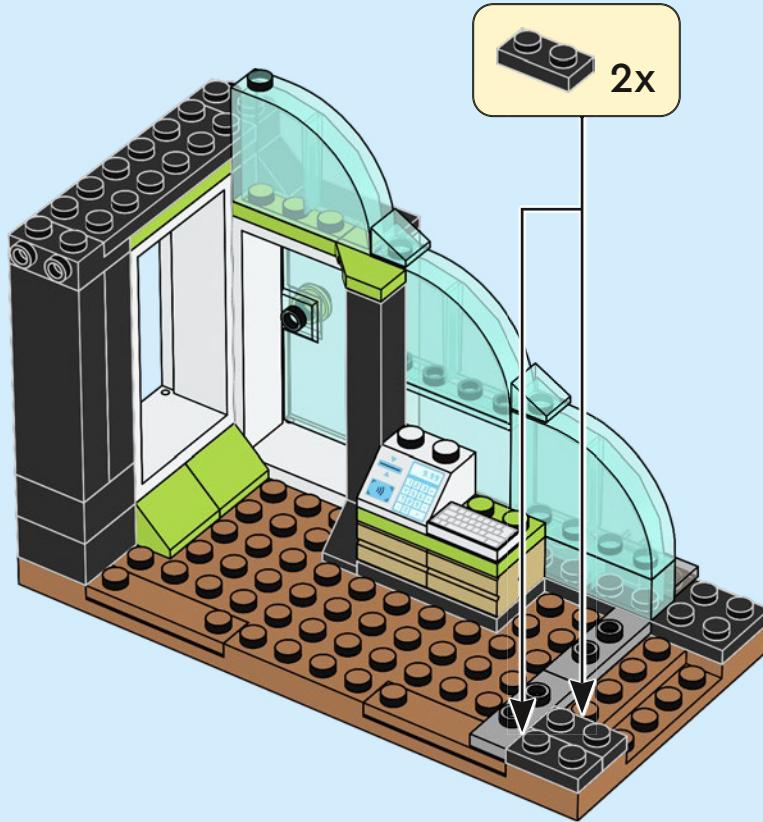



2x

78

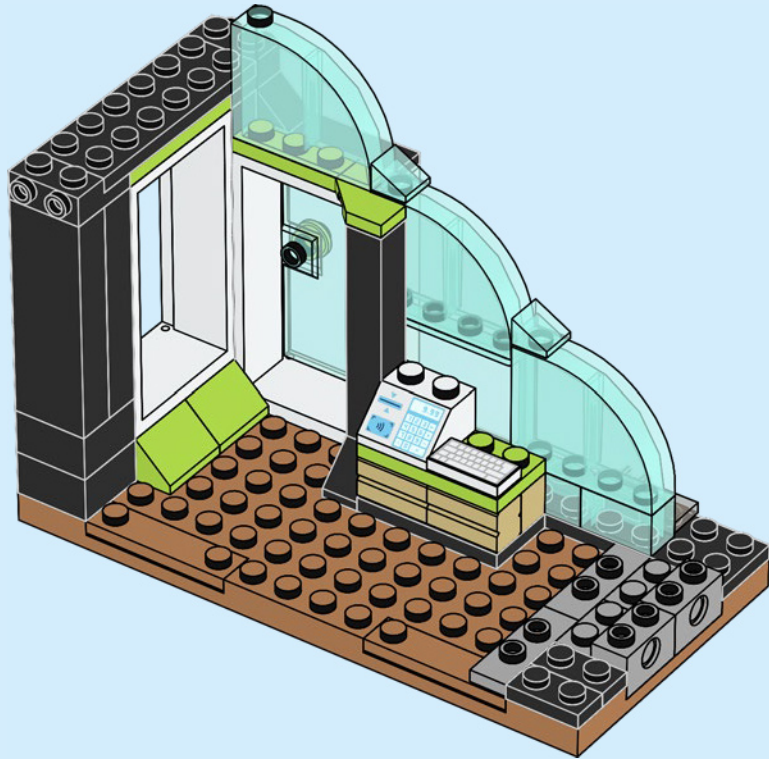

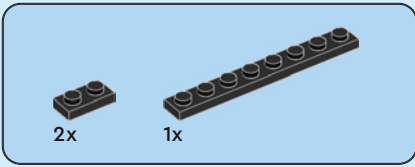

79

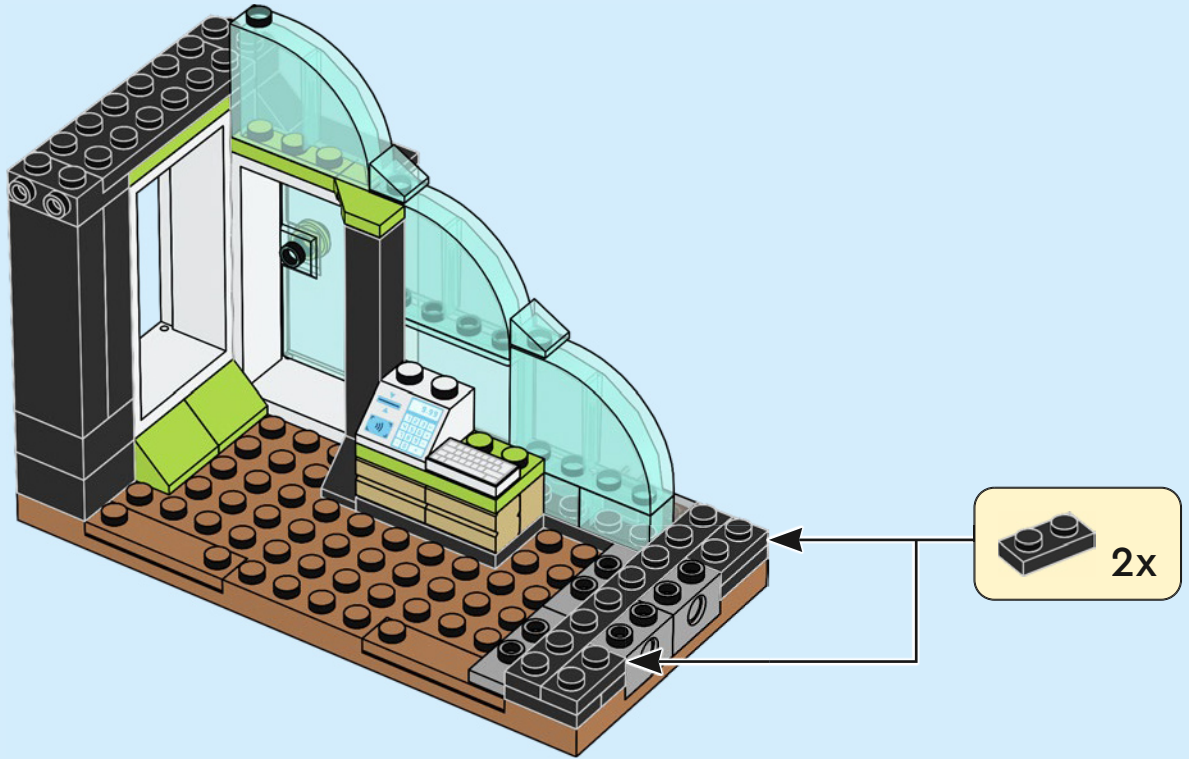

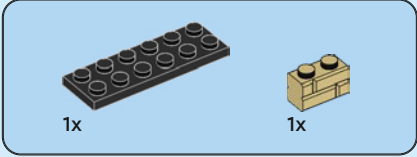
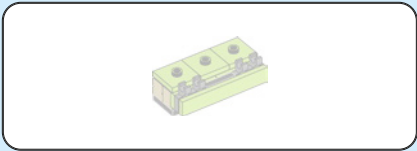

80

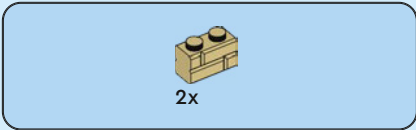
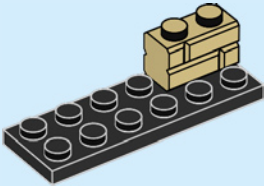

81

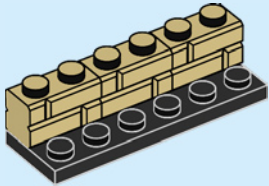



82

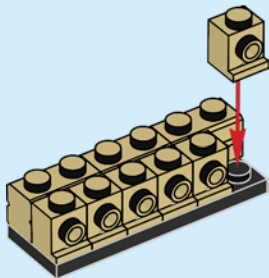

83

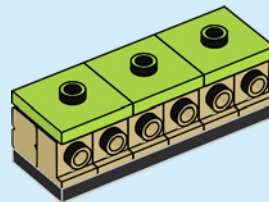



2x

84

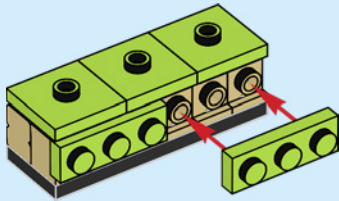

1x



2x

85

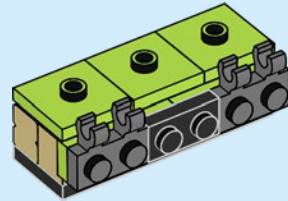

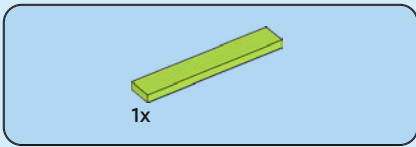

86

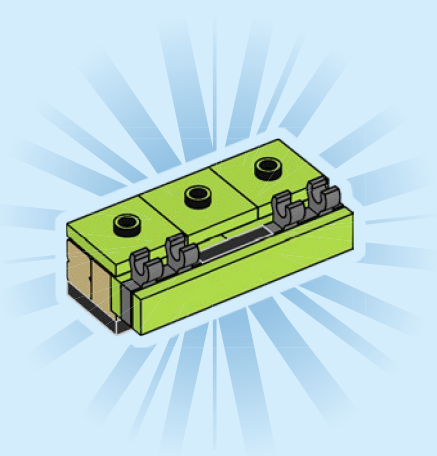

87

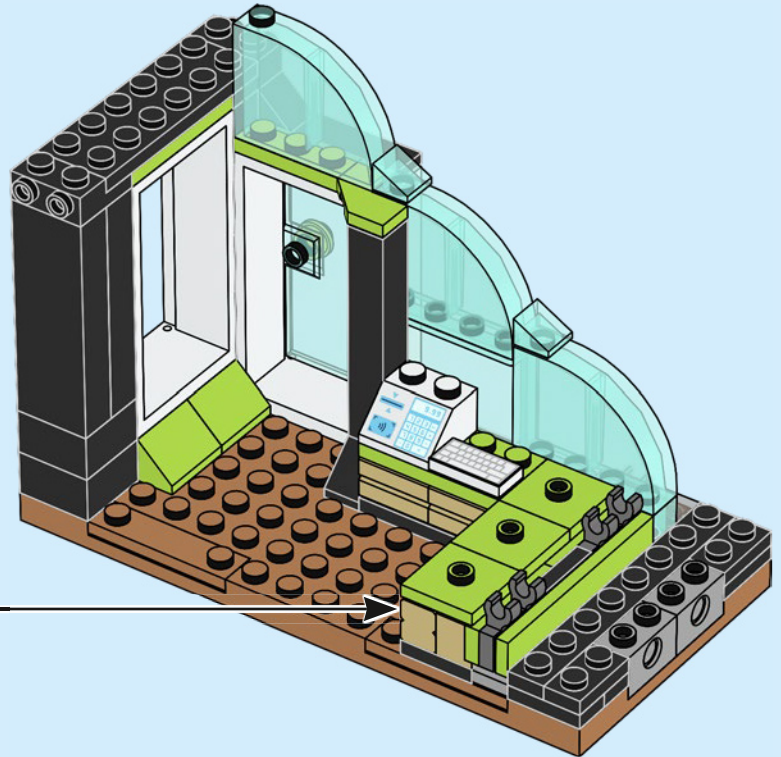

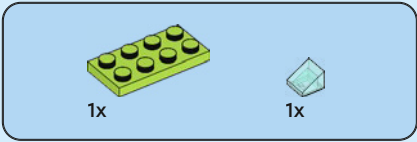

88

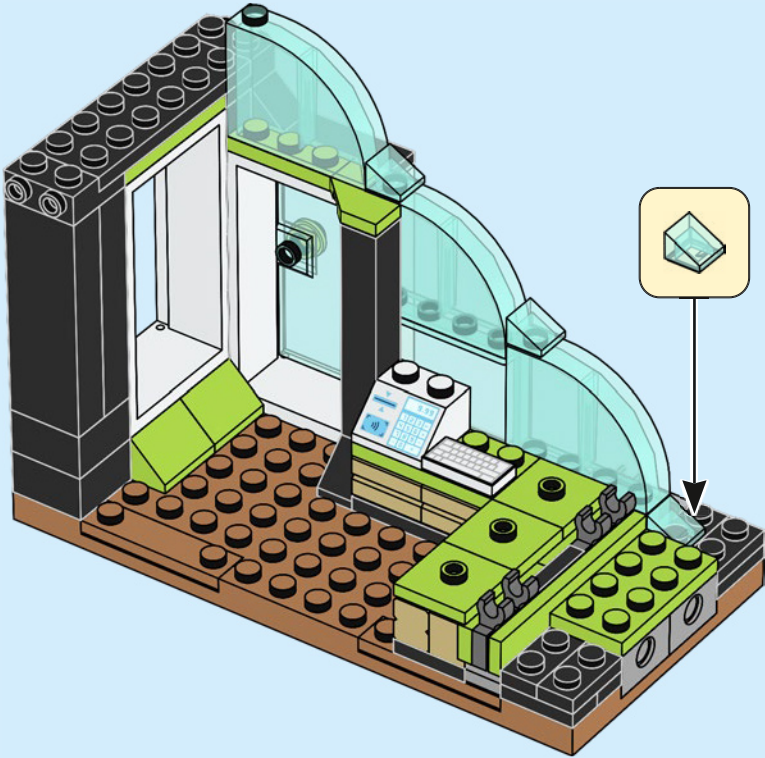



2x

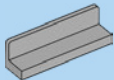

1x

89

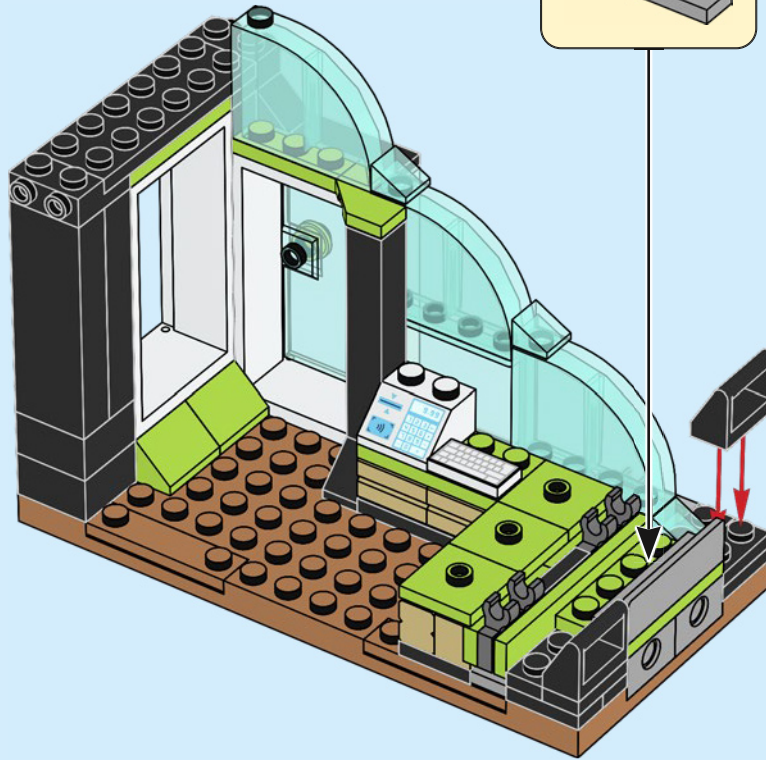
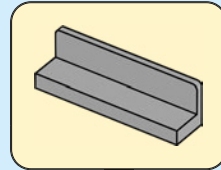

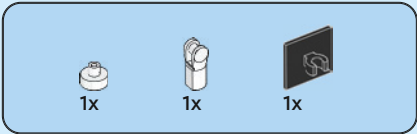

90

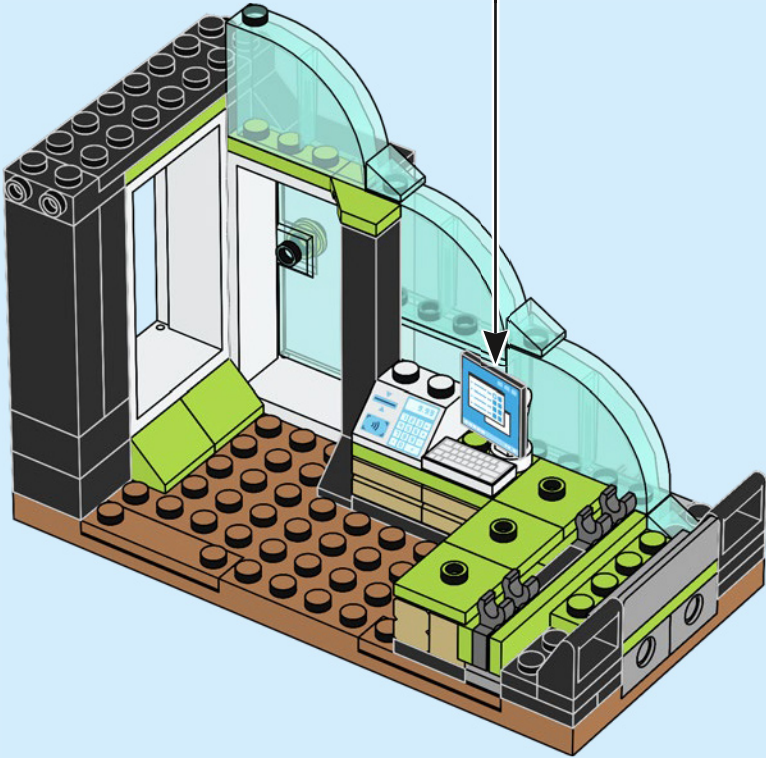
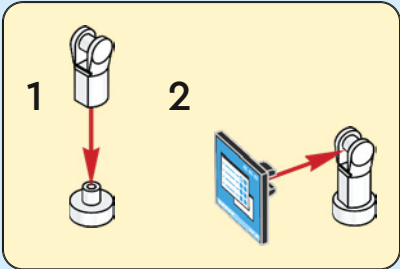



1x



1x

91

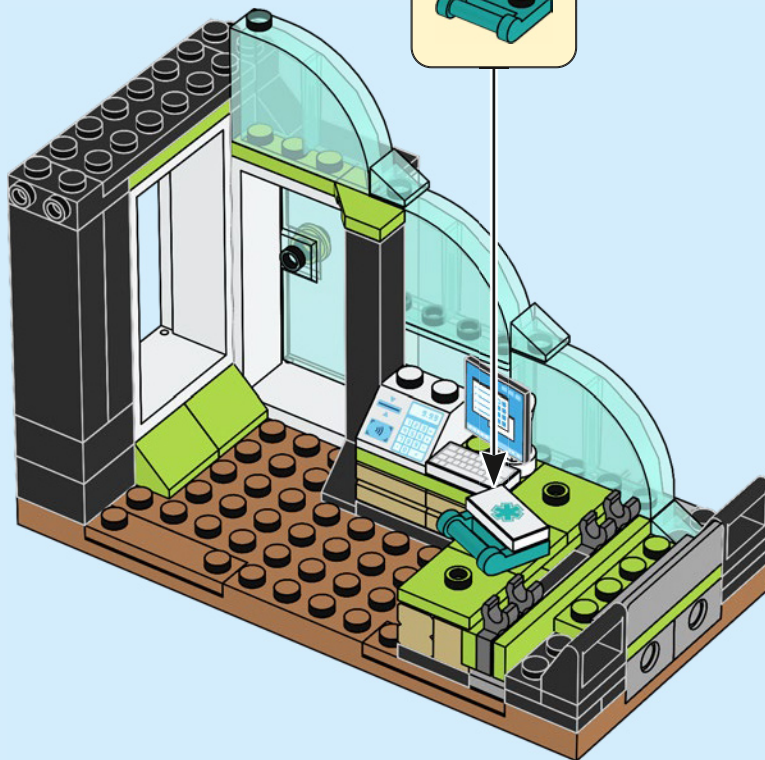
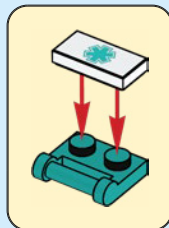

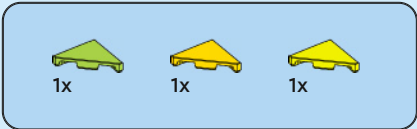

92

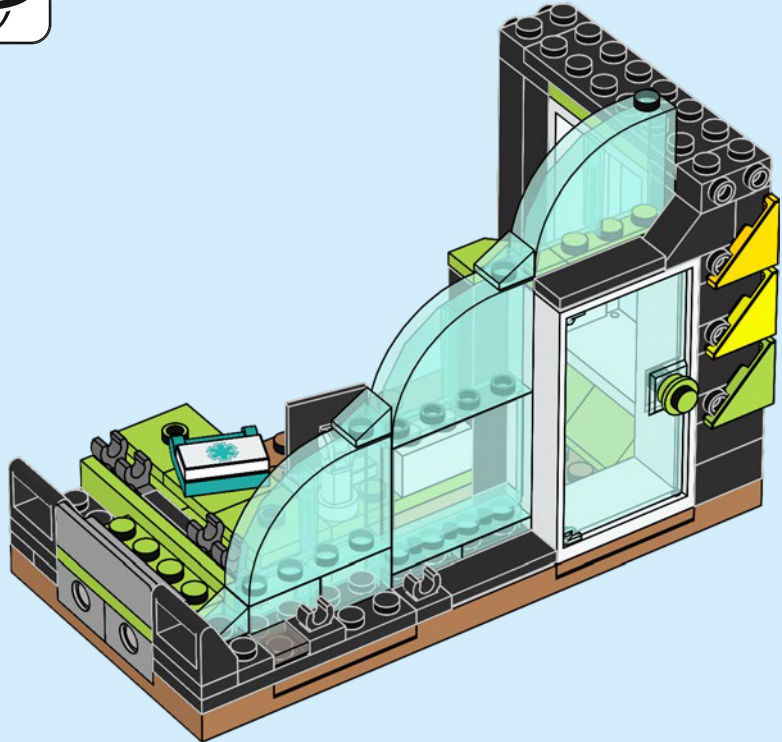



1x



3x

93

1

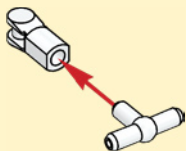

2

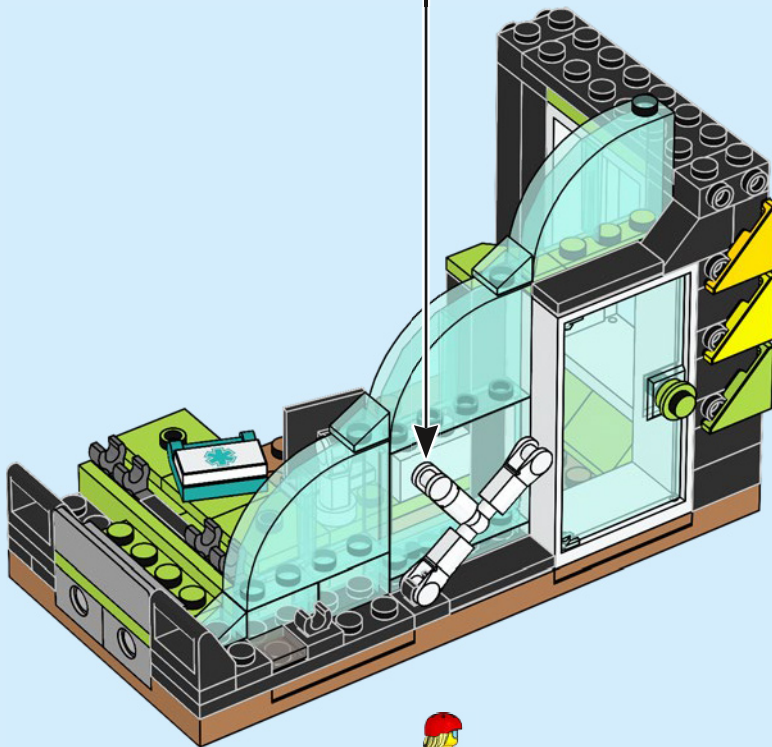
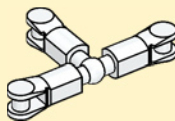



1x



1x



1x

94

1

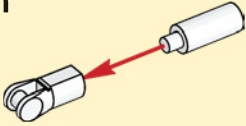

2

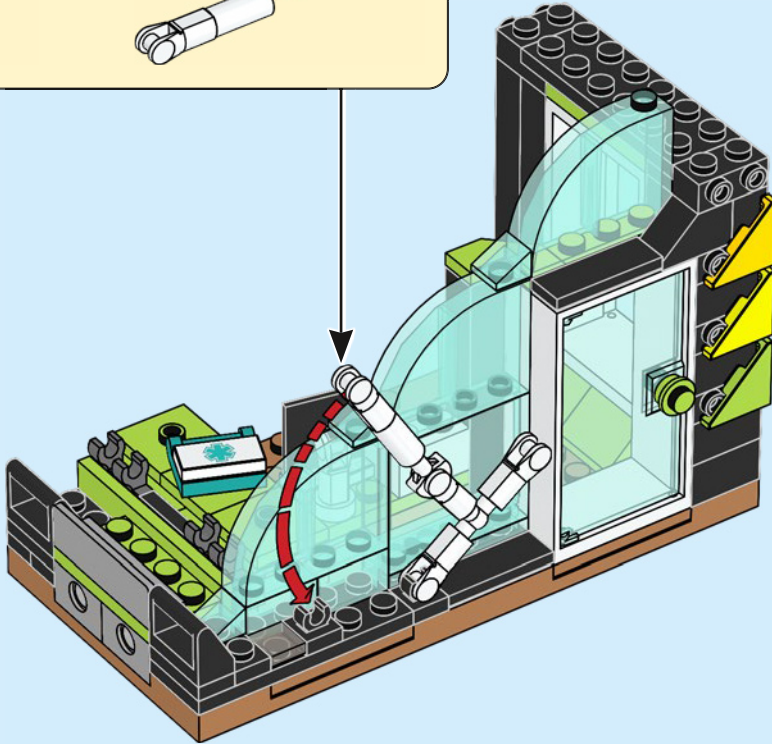
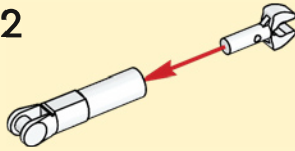

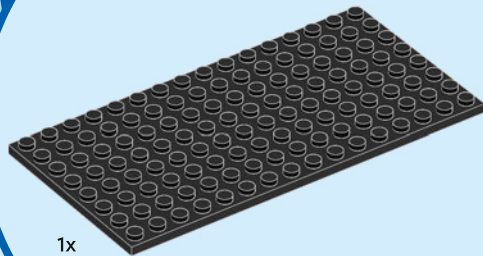
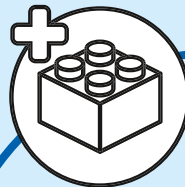

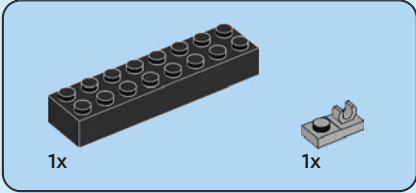
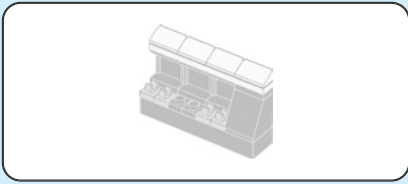

95

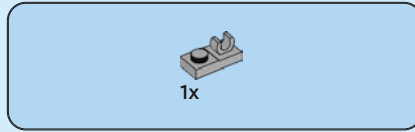
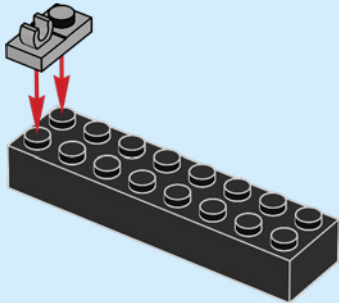

96

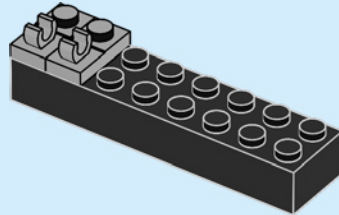



2x

97

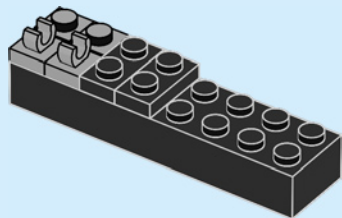

2x

98

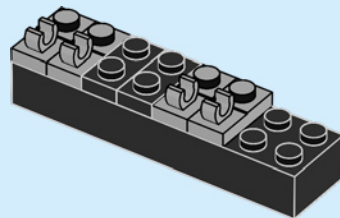

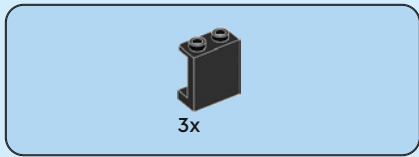

99

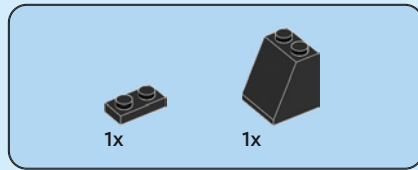
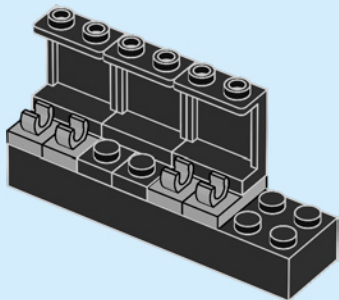

100

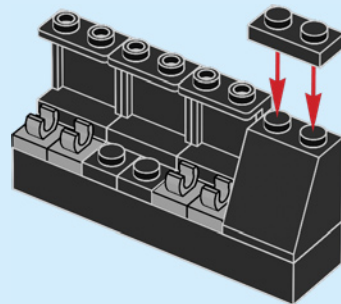

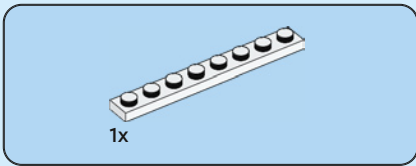

101

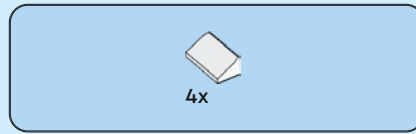
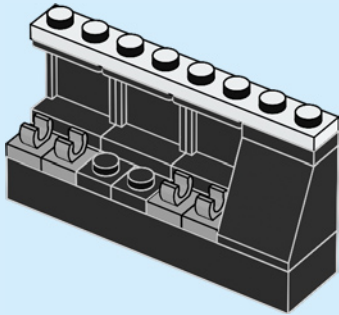

102

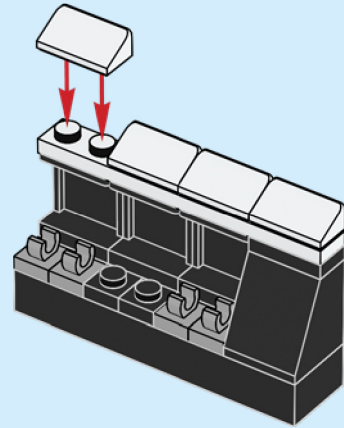

103

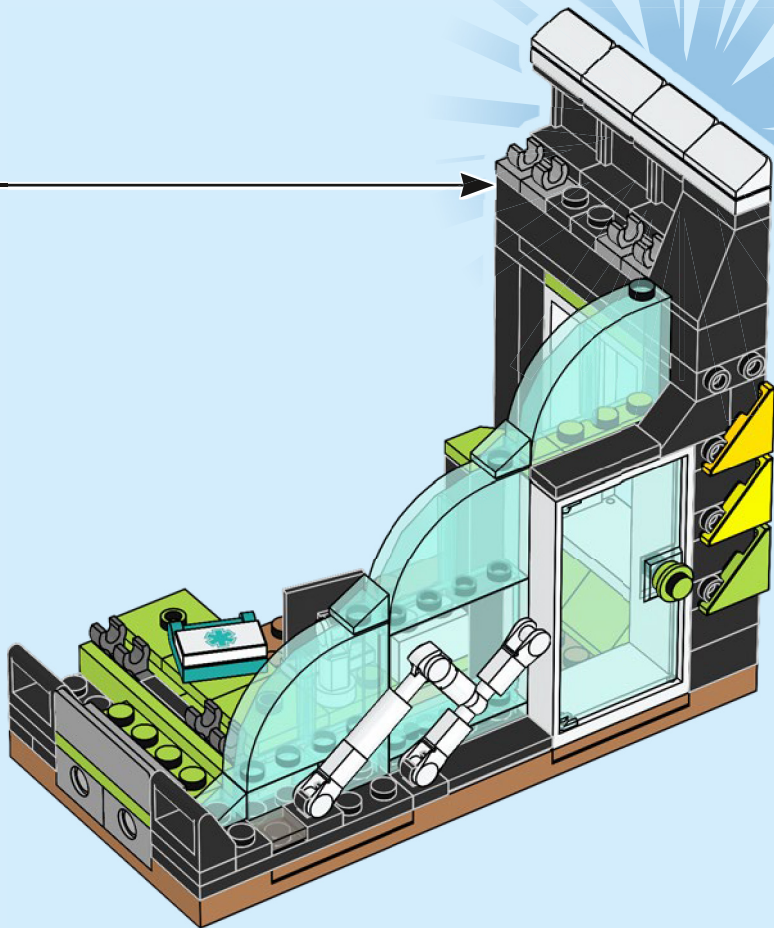



2x

104

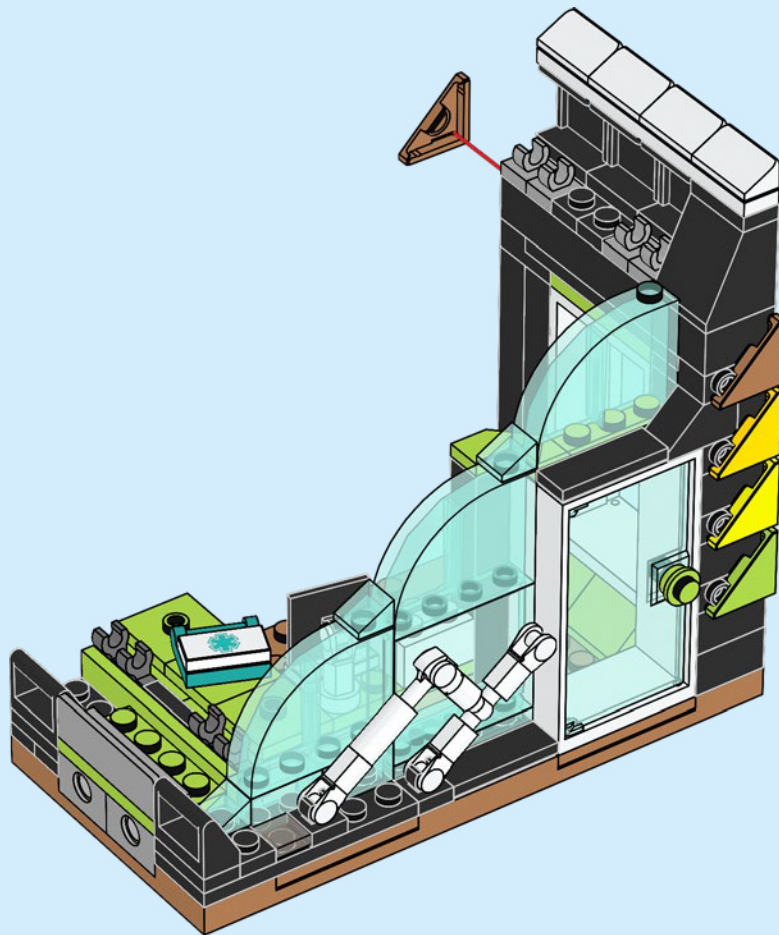

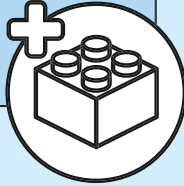
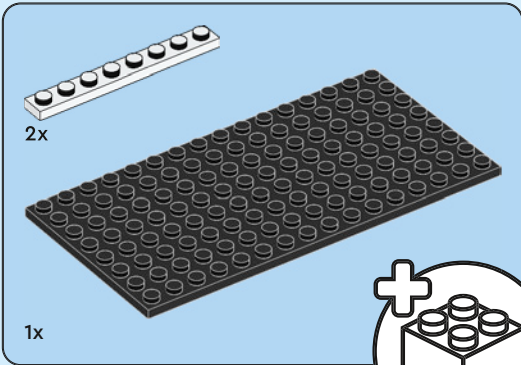
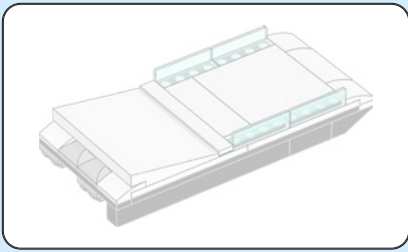

105

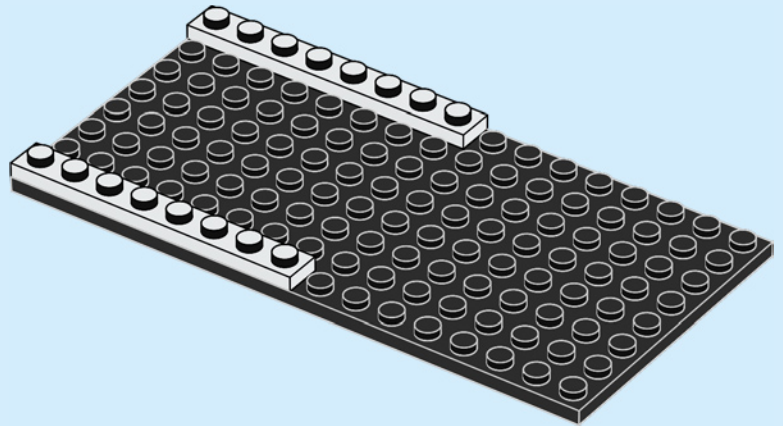

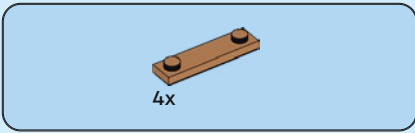

106

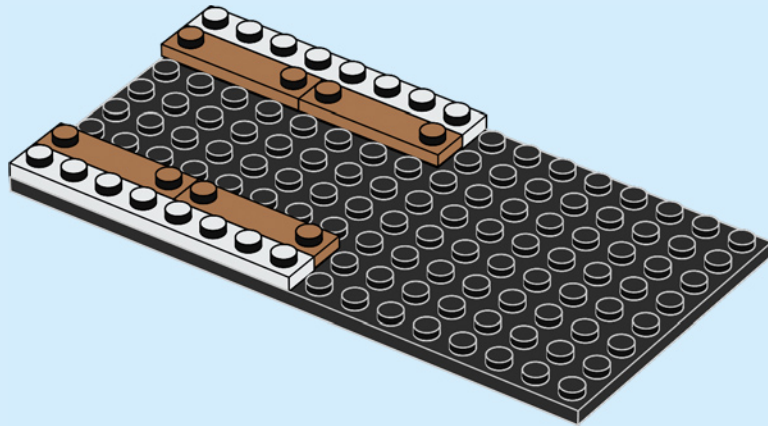

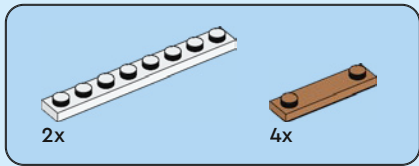

107

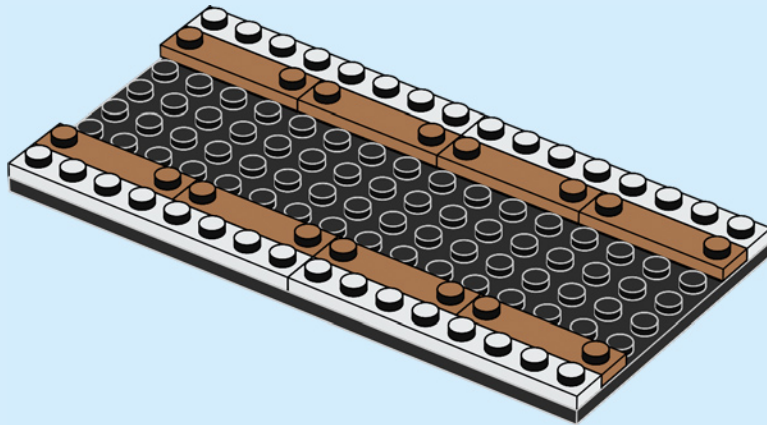

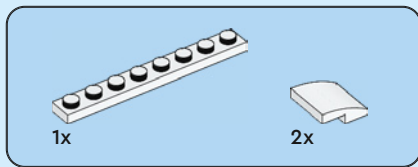

108

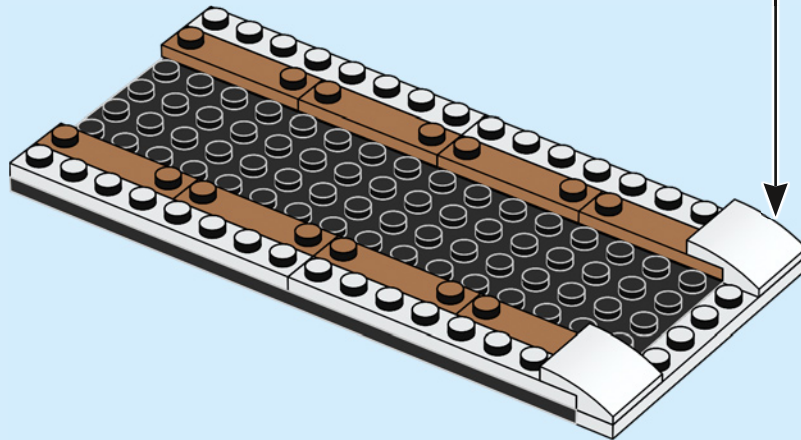
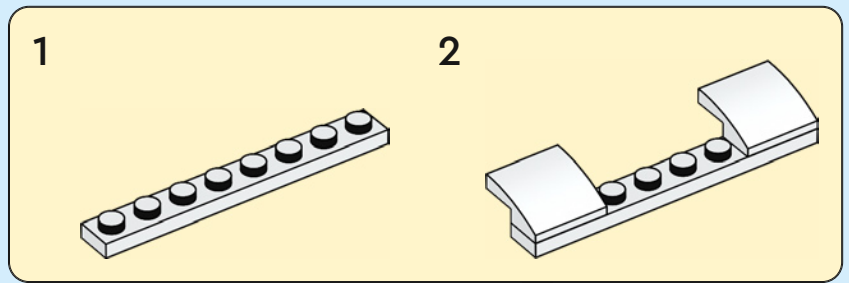

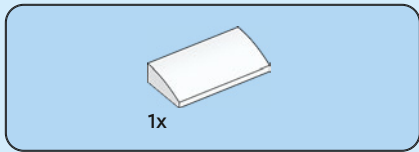

109

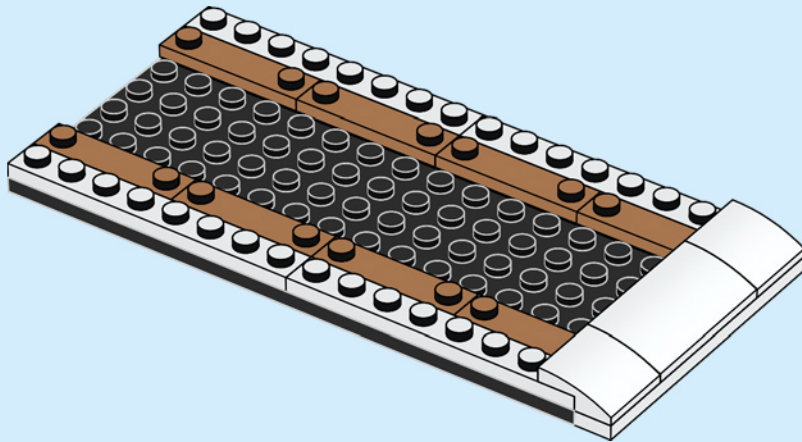

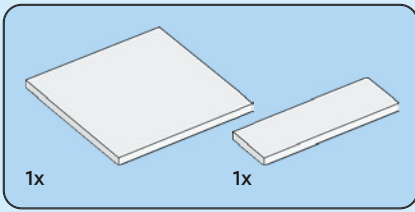

110

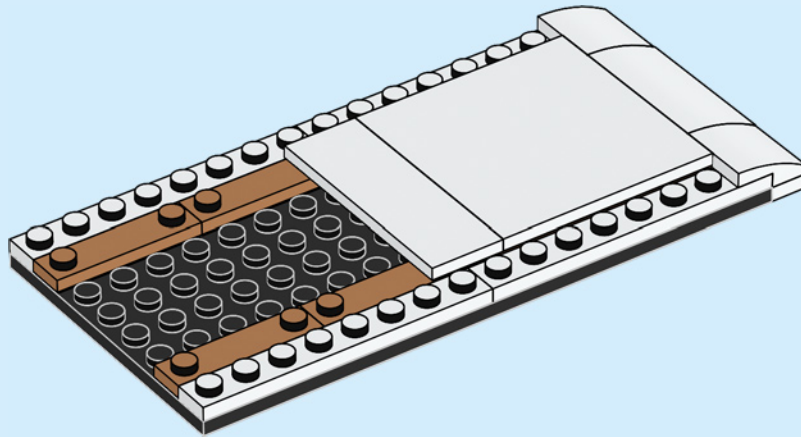

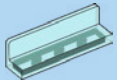

4x

111

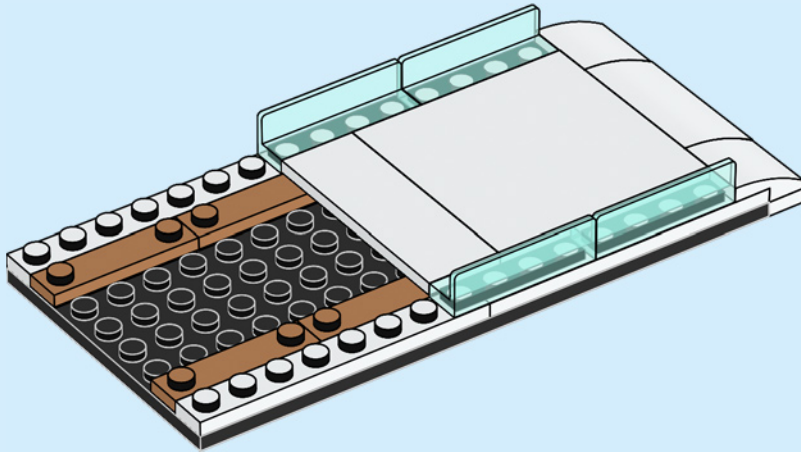

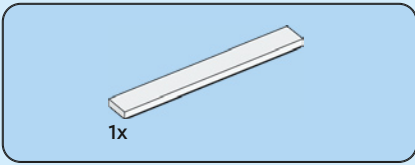

112

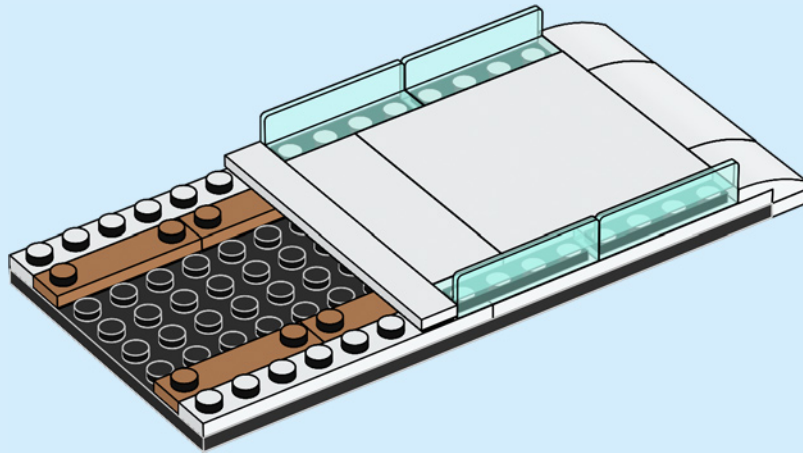

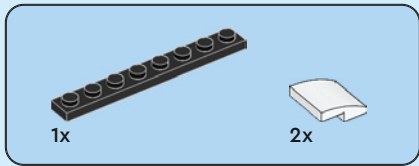

113

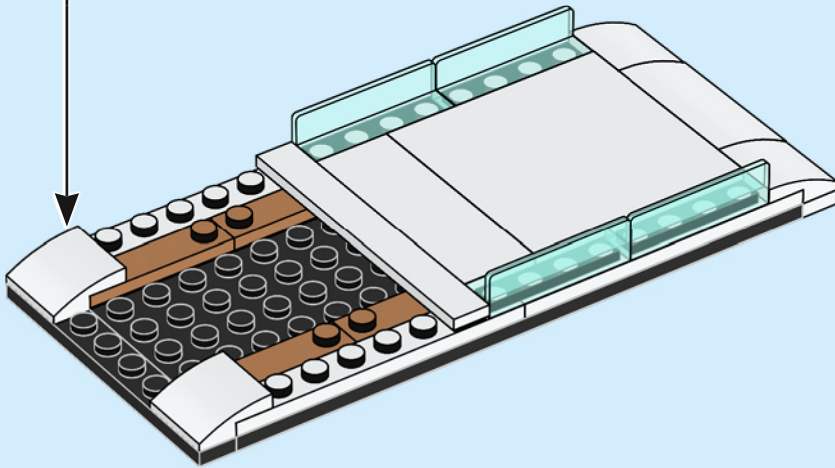
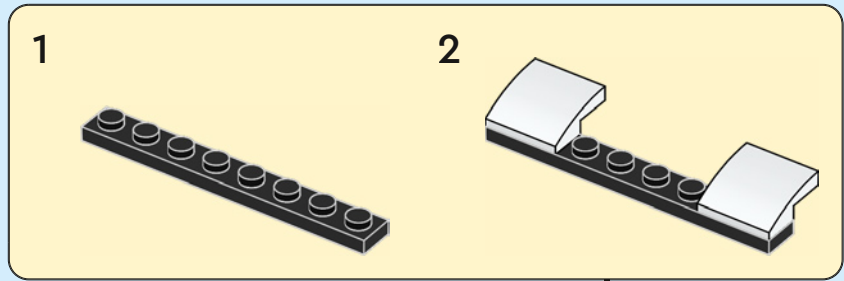



2x

114

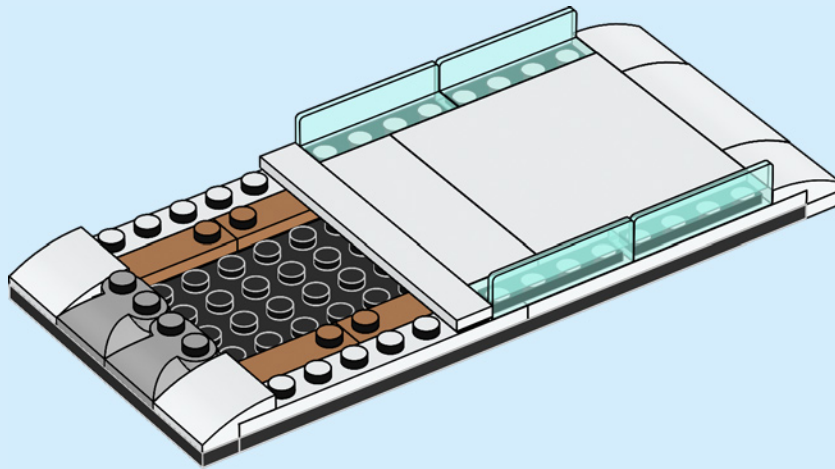

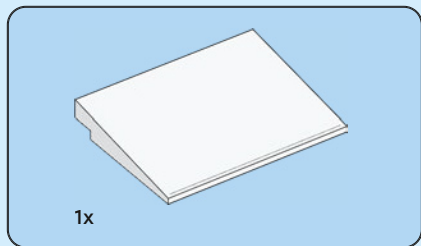

115

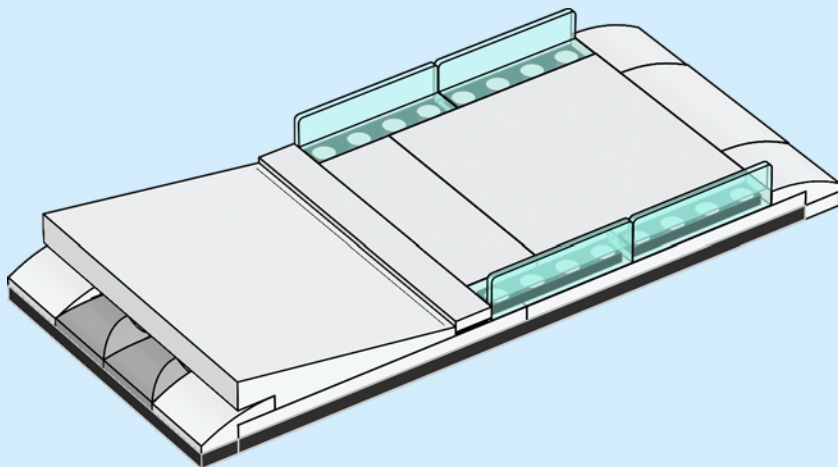

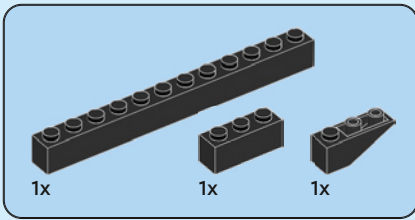

116

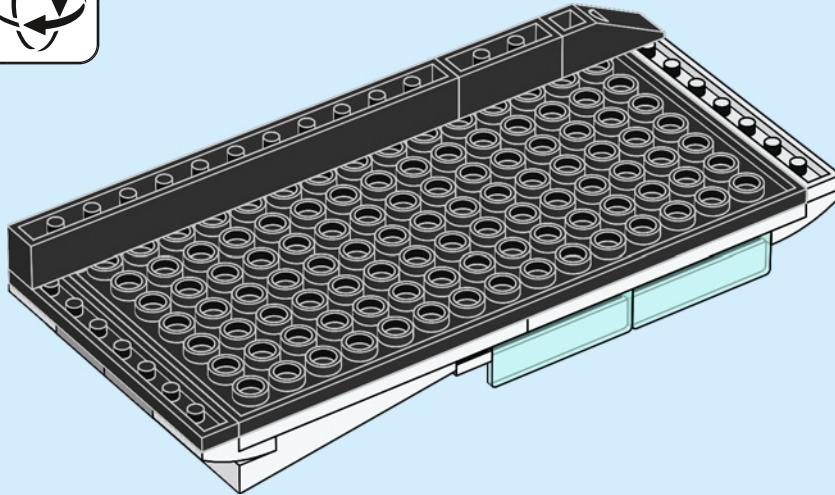

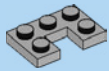

2x

117

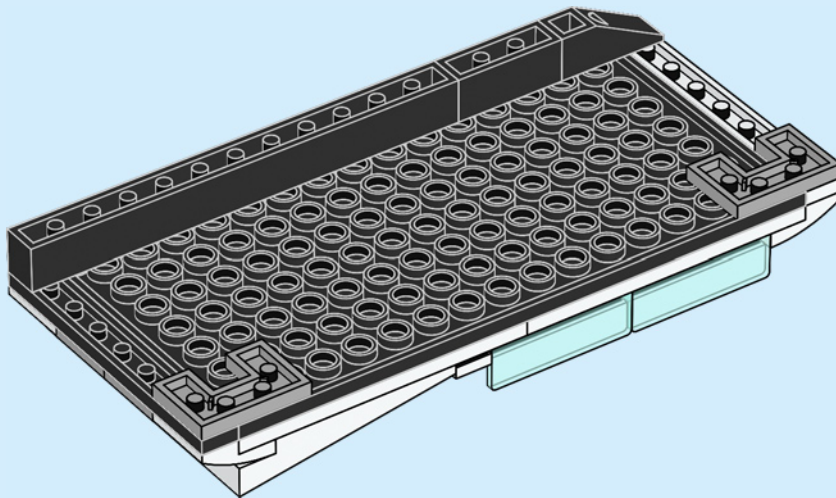



2x

118

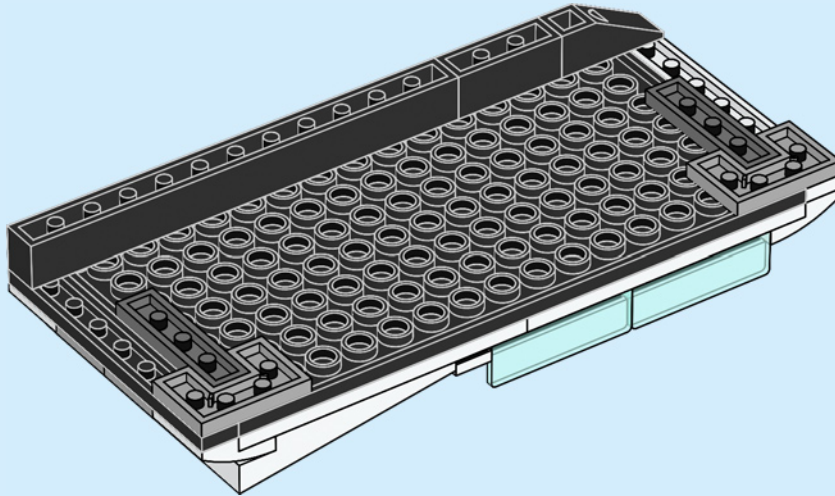

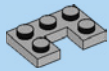

2x

119

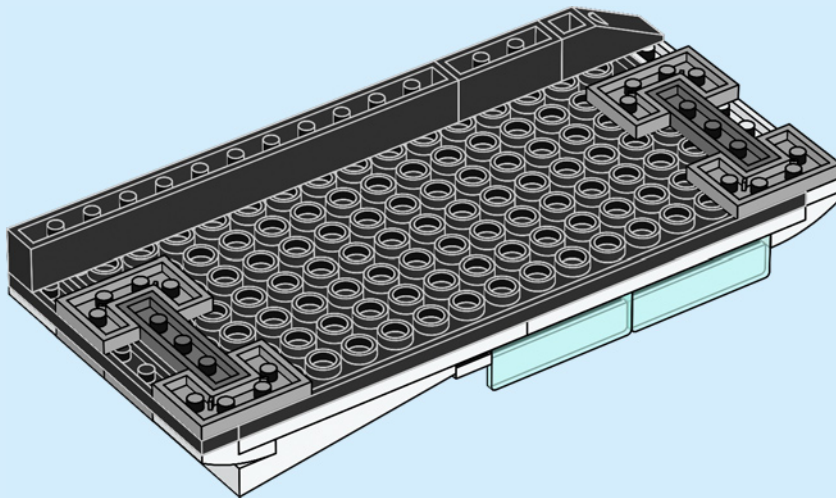



4x

120

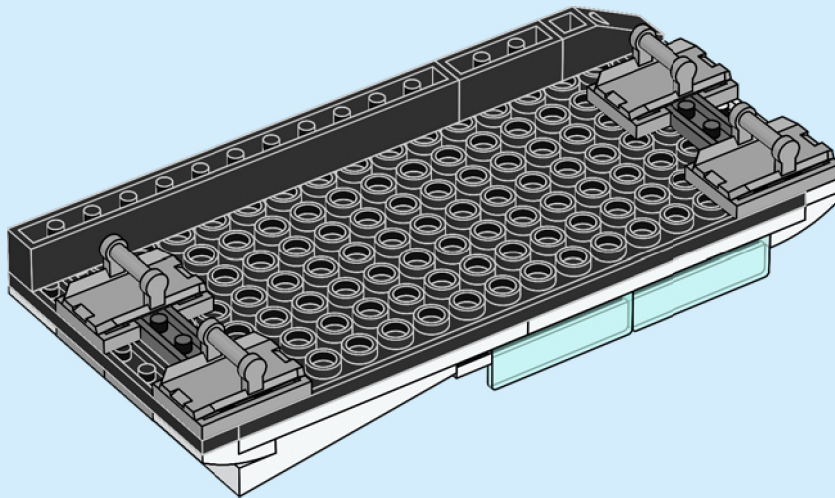

121

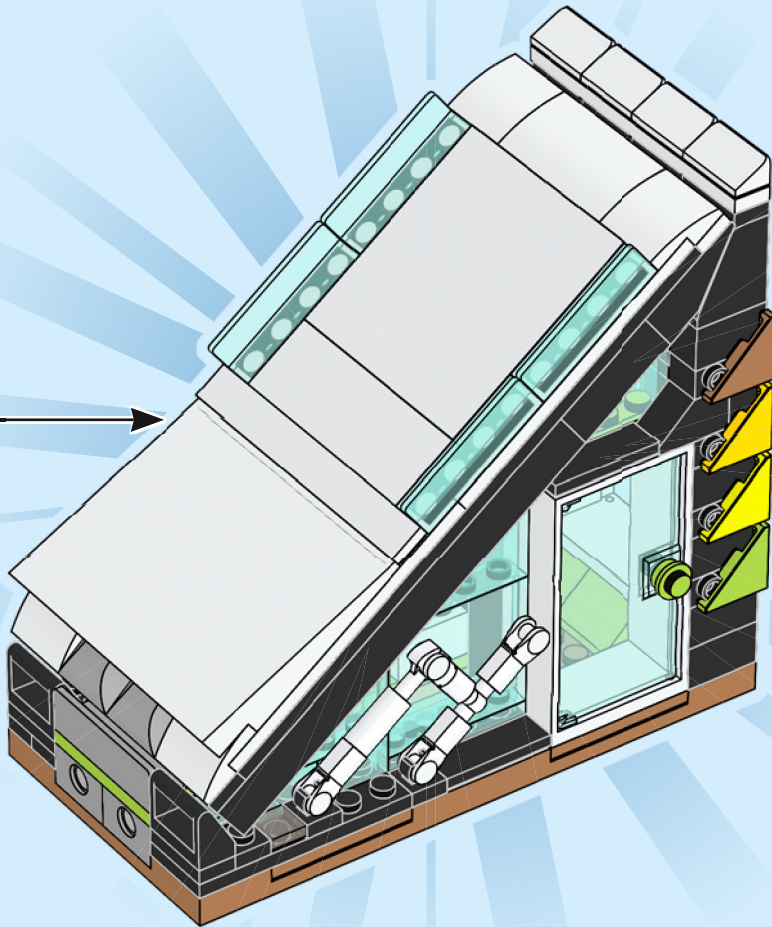

122

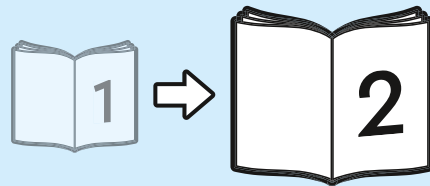
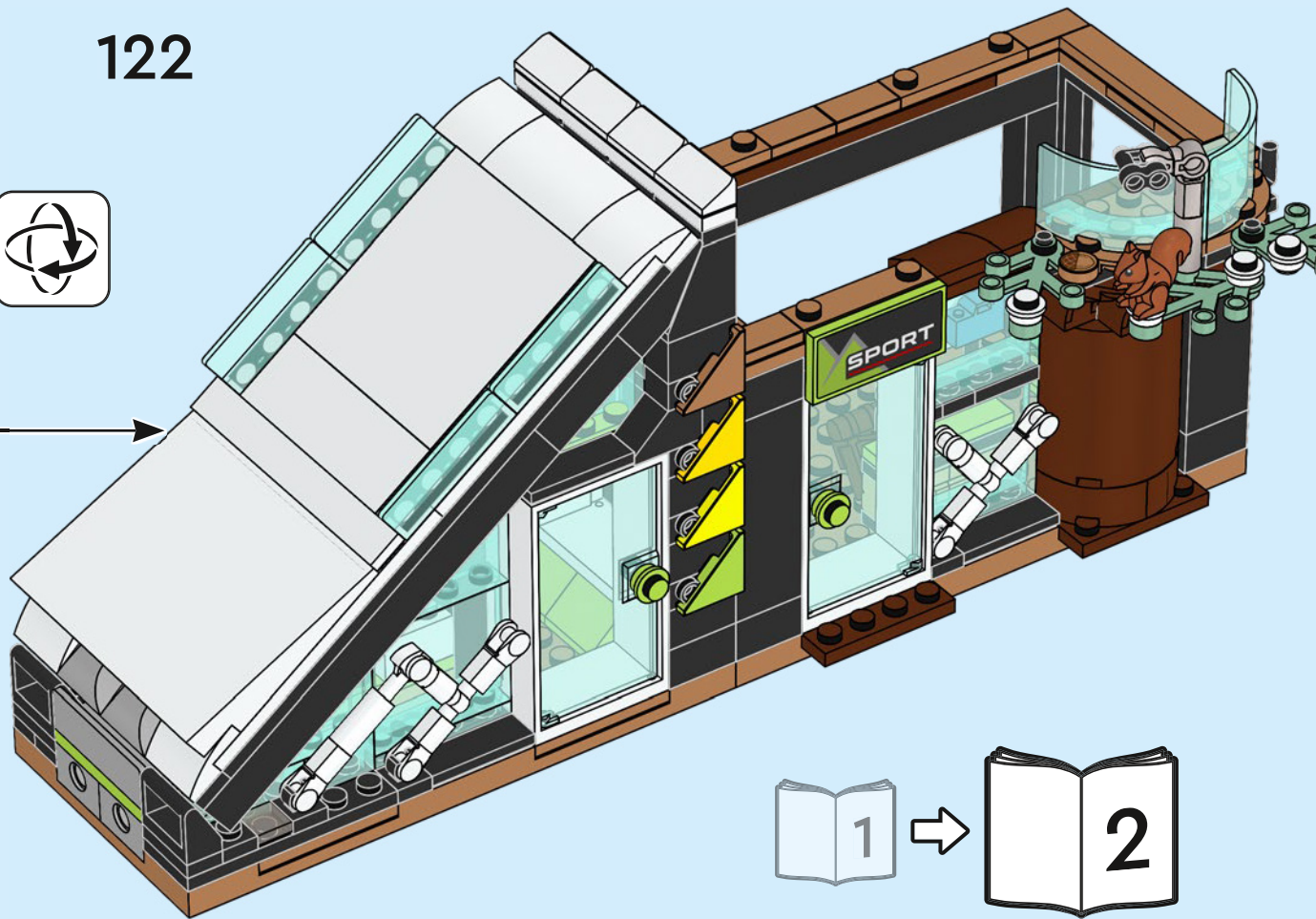

YOU COULD **WIN**



Scan this QR code or go to **LEGO.COM/PRODUCTFEEDBACK** and give us your short feedback about this LEGO® set for a chance to win a cool LEGO prize.

Terms and Conditions apply*

EN: YOU COULD WIN. Terms and Conditions apply* **DE: Du könntest GEWINNEN.** Es gelten die Teilnahmebedingungen* **FR: Tu pourrais GAGNER.** Des conditions s'appliquent* **IT: Potresti VINCERE tu.** Termini e condizioni sono applicabili* **ES: Puedes GANAR.** Aplican términos y condiciones* **PT: Poderá GANHAR.** Aplicam-se termos e condições* **ZH: 轻松获奖. 条款和条件适用*** **PL: Szansa na WYGRANĄ.** Obowiązują warunki korzystania* **CS: Máte šanci VYHRÁT.** Platí všeobecné smluvní podmínky* **SK: Máte šancu VYHRAŤ.** Platia všeobecné zmluvné podmienky* **HU: TE IS NYERHETSZ.** Felhasználási feltételek érvényesek* **RO: Ai putea CÂȘTIGA.** Se aplică termeni și condiții* **BG: Можете да СПЕЧЕЛИТЕ.** Има определени правила и условия* **LV: Tu vari LAIMĒT.** Ir spēkā noteikumi un nosacījumi.* **ET: Sul on võimalus VÕITA.** Kehtivad tingimused* **LT: Jūs galite LAIMĖTI.** Taikomos sąlygos*

*[LEGO.com/productfeedback-terms](https://www.lego.com/productfeedback-terms)