

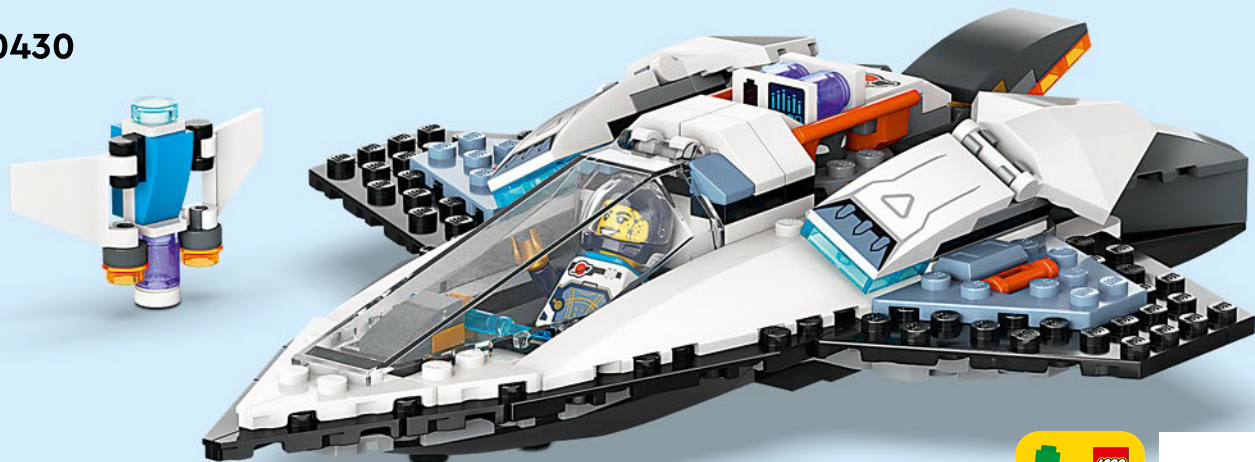

# CITY

60430



LEGO® Builder



[LEGO.com/sustainable-packaging](https://LEGO.com/sustainable-packaging)



 <sup>FR</sup> **DONNEZ**  
OU  
**RECYCLEZ**

 OU  OU 

ASSOCIATION    MAGASIN    DÉCHÈTERIE

Adresses sur [quefairedemesdechets.fr](https://quefairedemesdechets.fr)



# BUILDER



Apple and the Apple logo are trademarks of Apple Inc., registered in the U.S. and other countries and regions. App Store is a service mark of Apple Inc. Google Play and the Google Play logo are trademarks of Google LLC. Tencent and the Tencent logo are trademarks of Tencent Inc.

Q [LEGO.com/devicecheck](https://www.lego.com/devicecheck)

**EN** Ask parents' permission before going online | **DE** Eltern um Erlaubnis bitten, bevor du online gehst | **FR** Demande l'autorisation d'un parent avant d'aller en ligne | **IT** Chiedi il permesso ai tuoi genitori prima di andare online | **ES** Pídeles permiso a tus papás antes de conectarte a Internet | **PT** Pede autorização aos pais antes de acederes online | **ZH** 上网前应先征得父母的同意 | **PL** Poproś rodziców o zgodę, zanim wejdziesz do Internetu | **CS** Než půjdeš na internet, požádej rodiče o svolení | **SK** Skôr než pôjdeš na internet, vypýtaj si povolenie od rodičov | **HU** Kérj szülői engedélyt, mielőtt online csatlakoznál! | **RO** Cere permisiunea părinților înainte de a te conecta online | **BG** Поискайте разрешение от родител, преди да влезете онлайн | **LV** Pirms došanās tiešsaistē palūdz atļauju vecākiem | **ET** Enne Interneti kasutamist küsi vanematelt luba | **LT** Prieš prisijungdami prie interneto, atsiklauskite tėvų

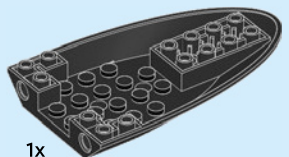
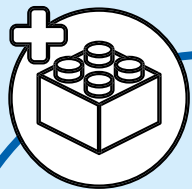

1x

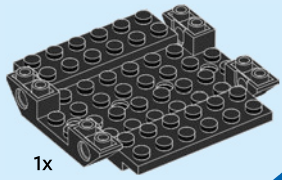

1x





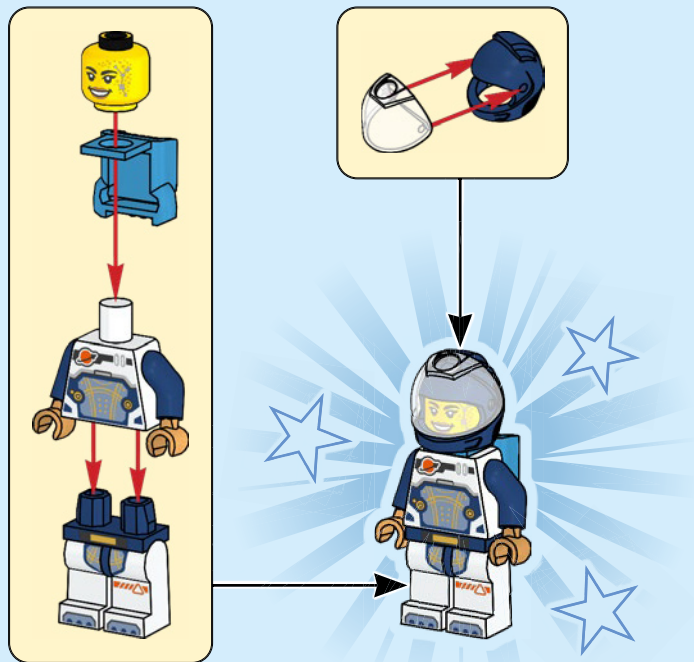



1x



1x

1

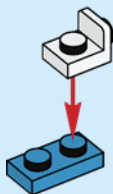



1x

2

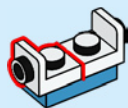

1x

3

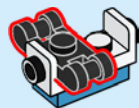



1x

4

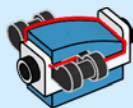

8



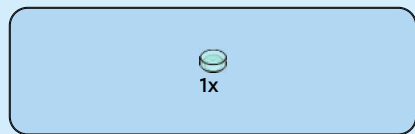

5

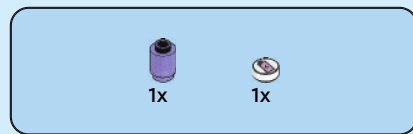
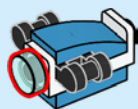

6

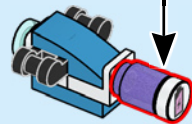
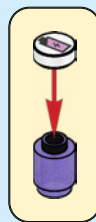



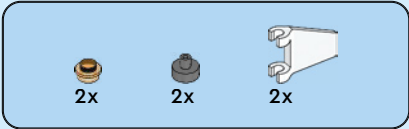

7

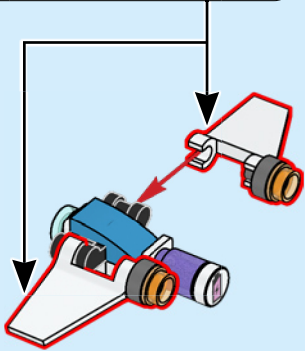
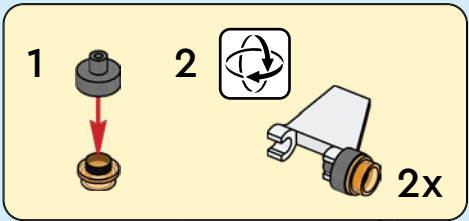

8

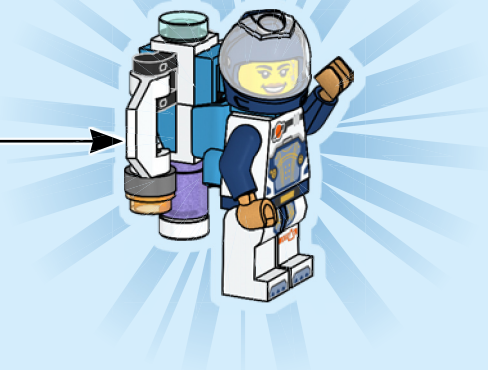

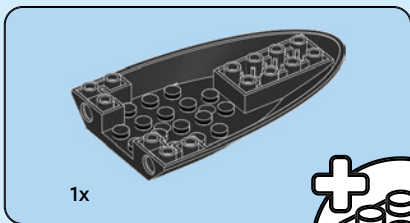
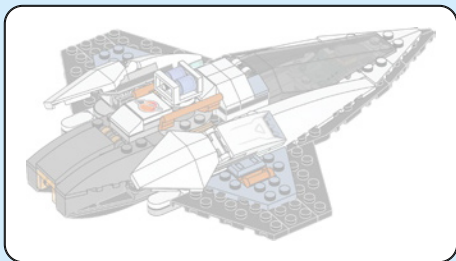

1

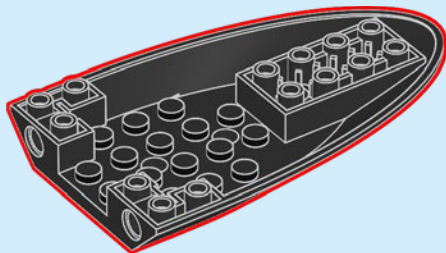
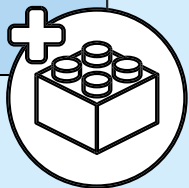



2x

2

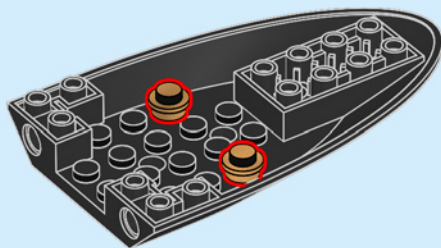

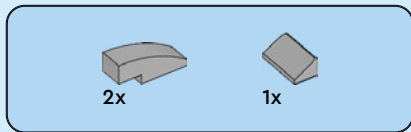

3

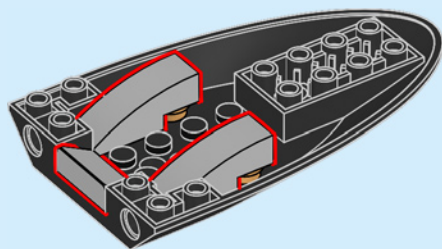

4

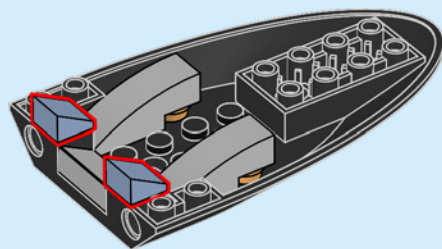



2x

5

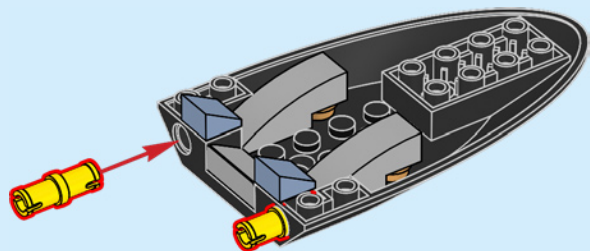



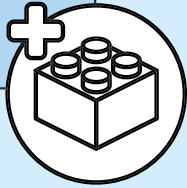
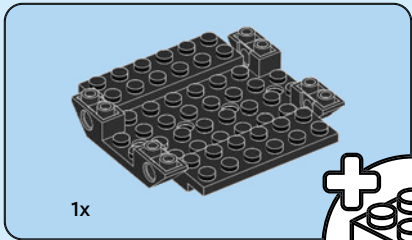

6

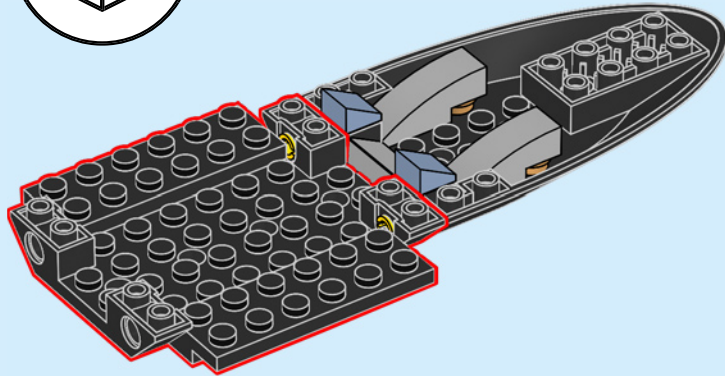

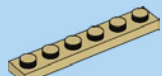

2x

7

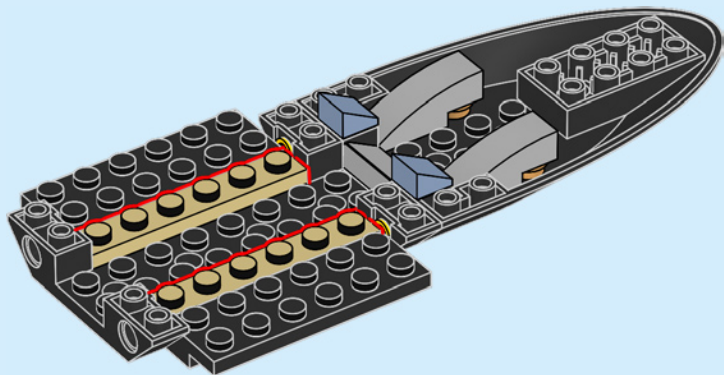

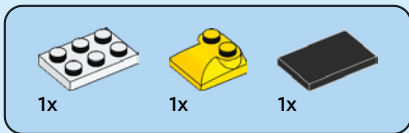

8

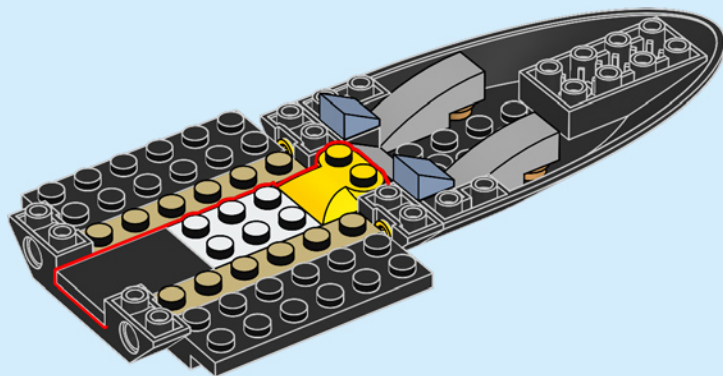



4x

9

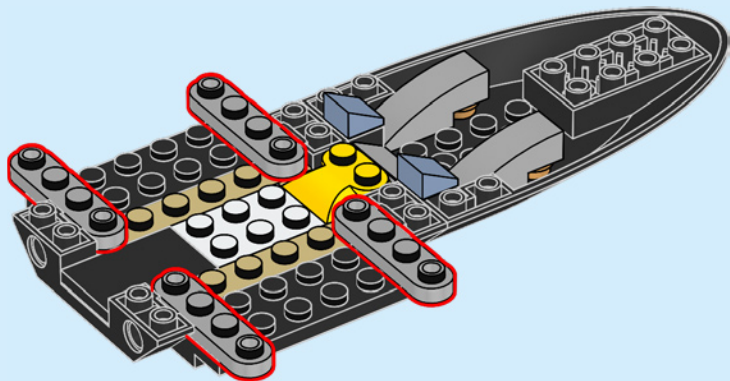

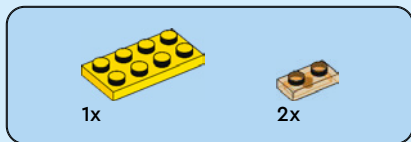

10

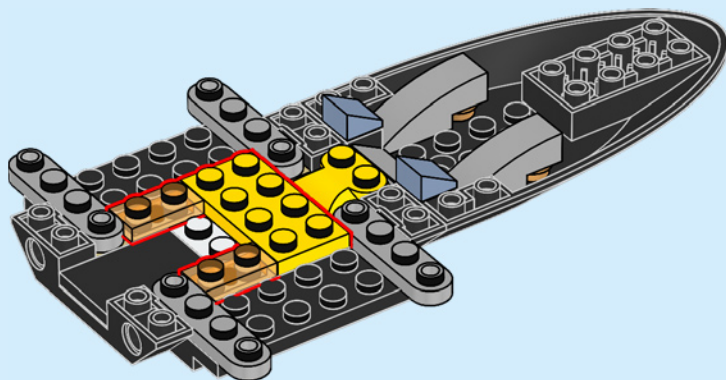



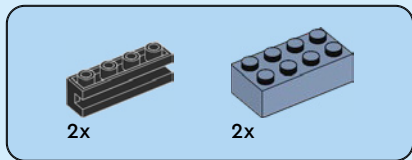

11

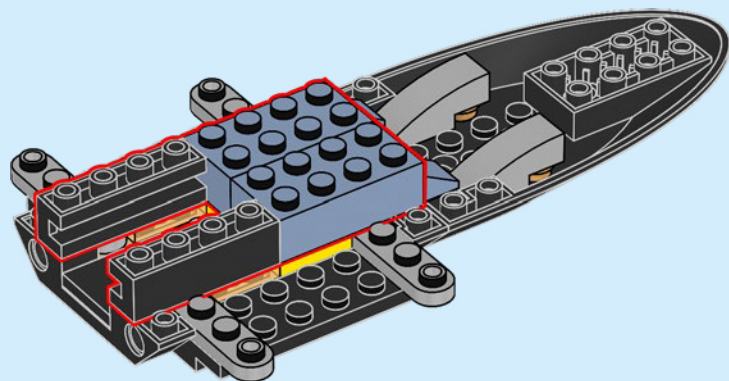



4x

12

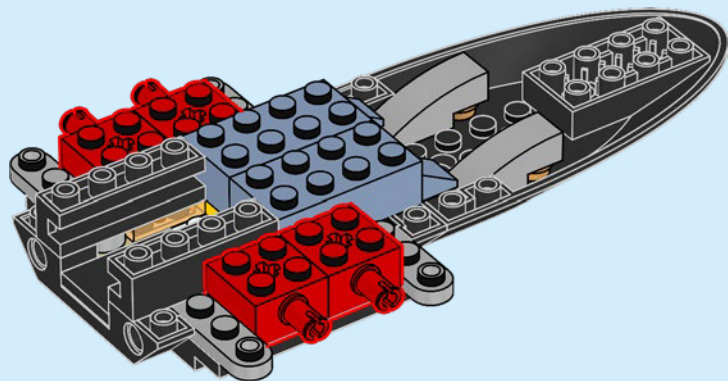



2x

13

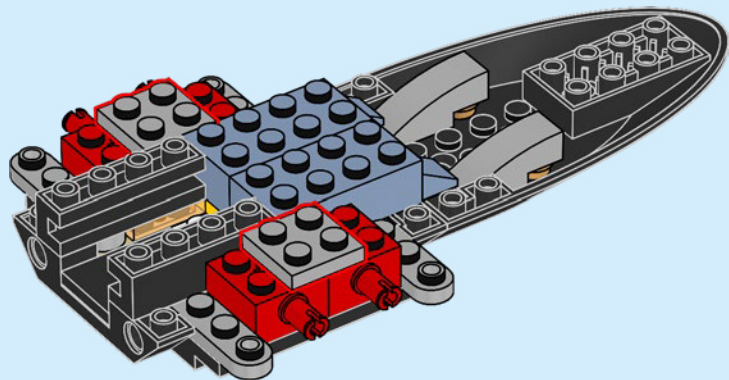



1x

14



1x

15

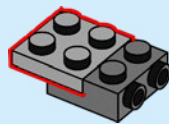



1x

16

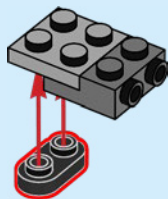





1x

17

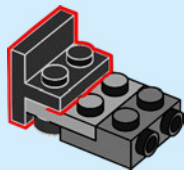

2x

18

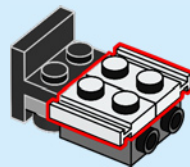



1x

19

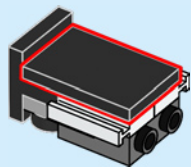



1x



1x

20

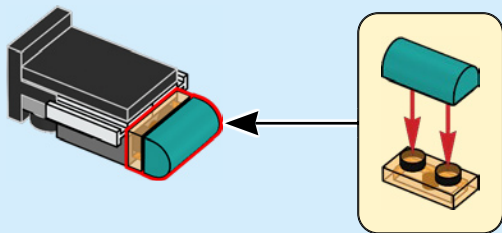

1x

21

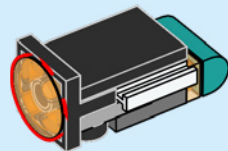

22

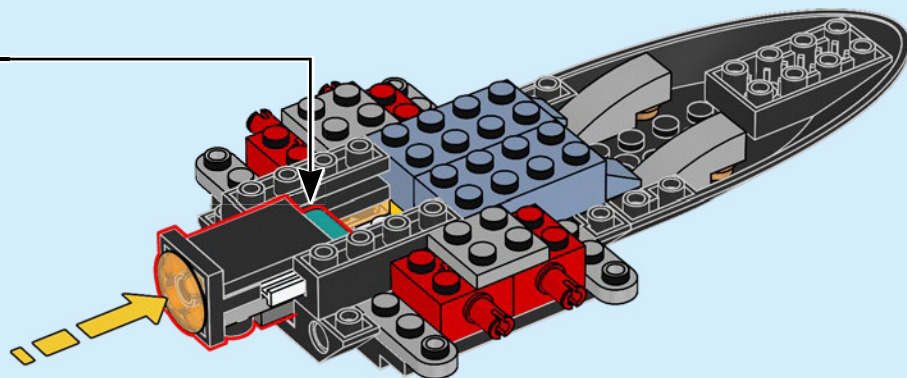

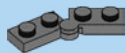

2x

23

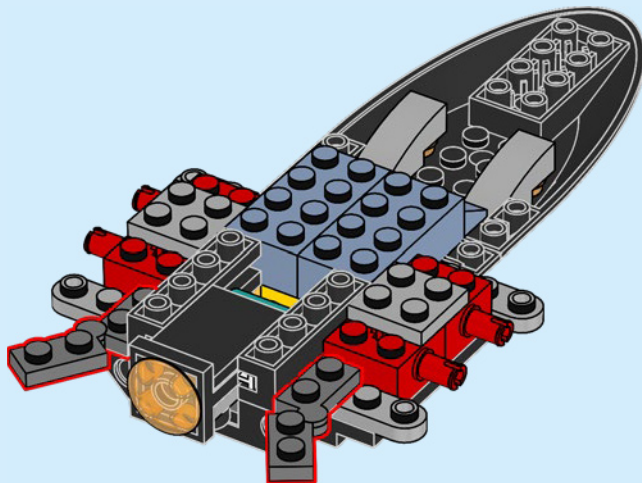



2x

24

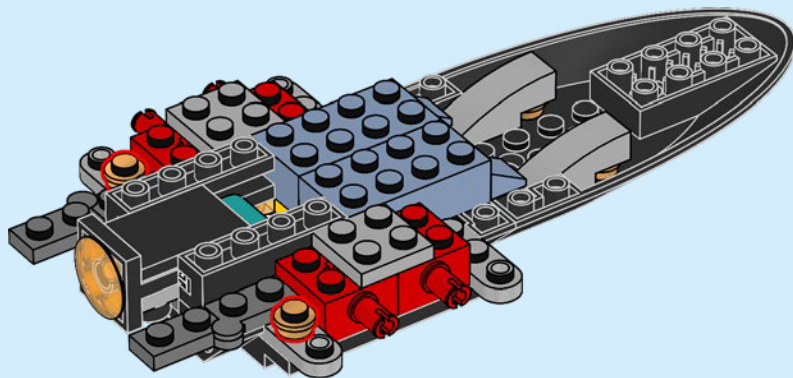



25

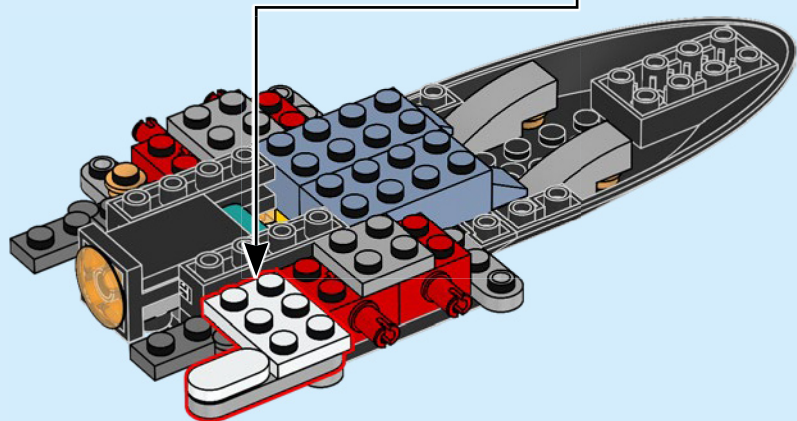
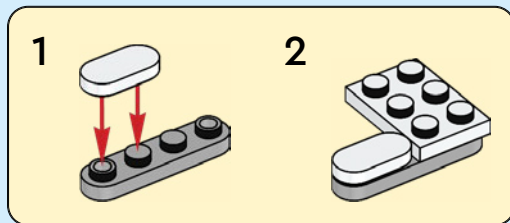

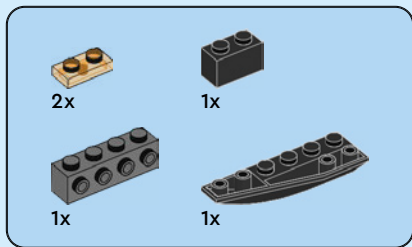

26

1

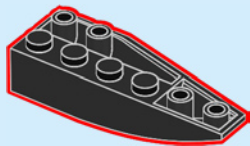

2

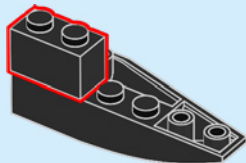

3

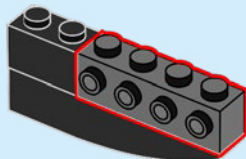

4

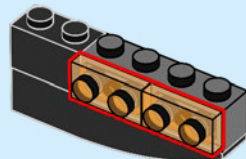



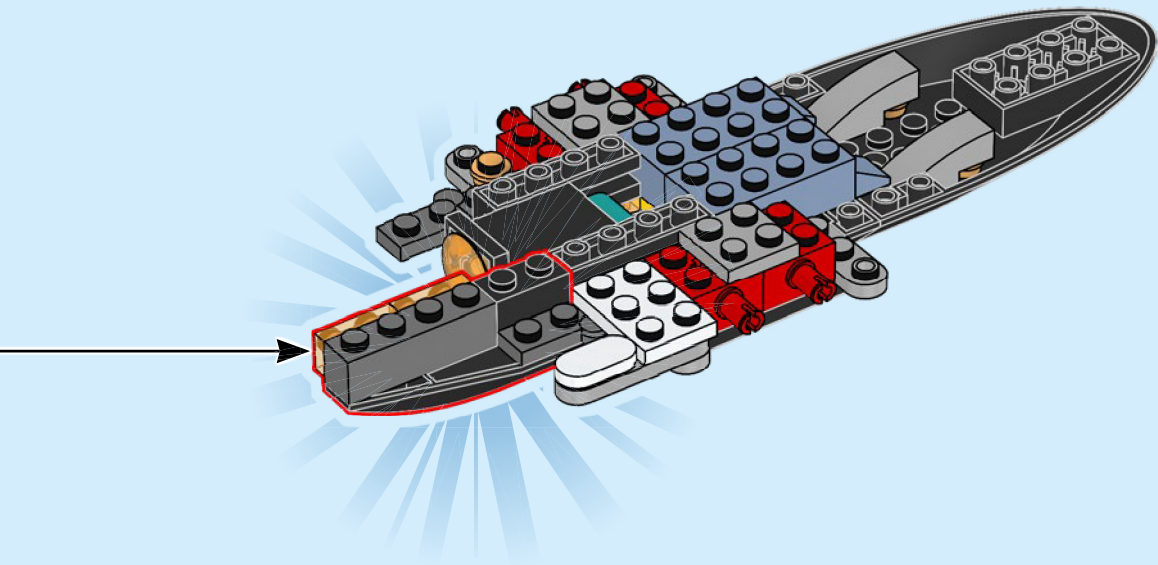

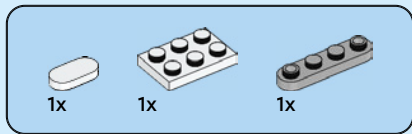

27

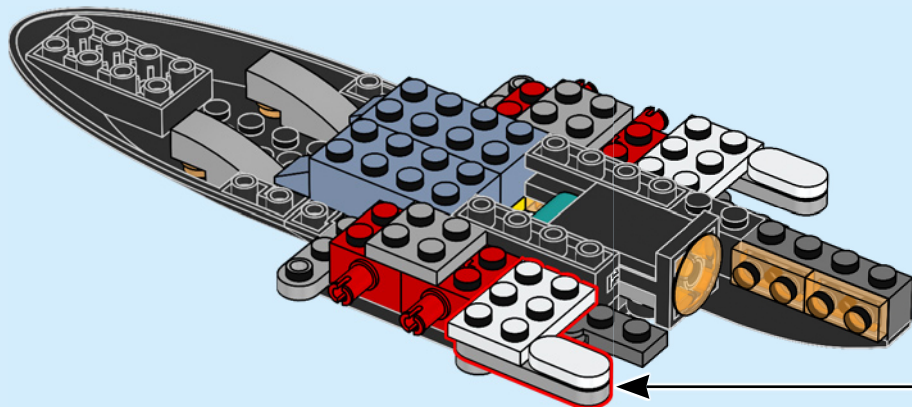
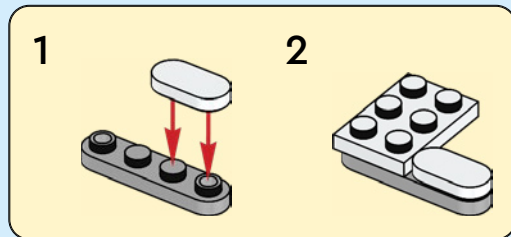

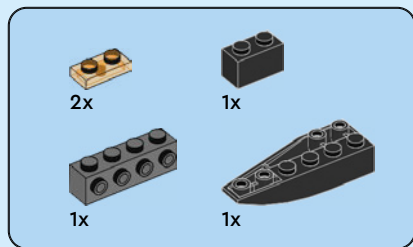

28

1

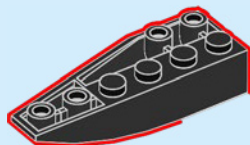

2

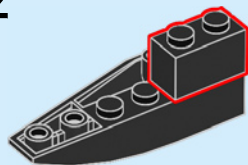

3

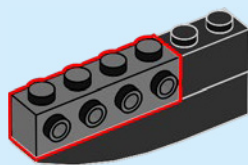

4

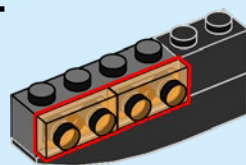

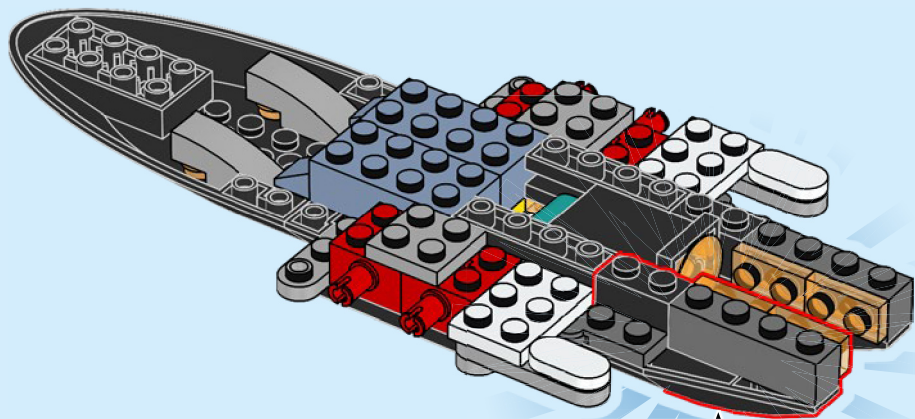

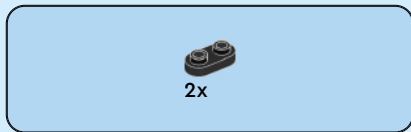

29

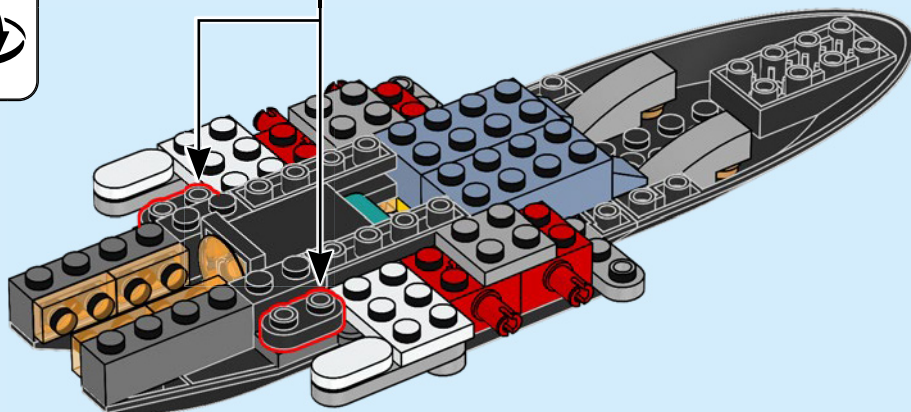



2x

30

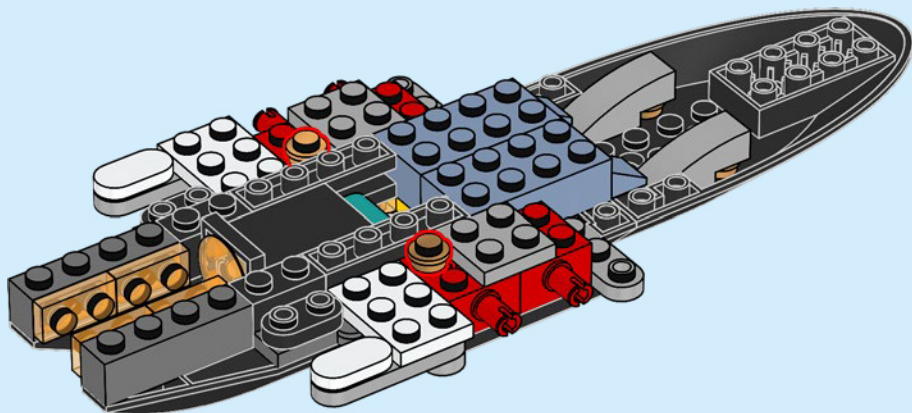

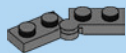

2x

31

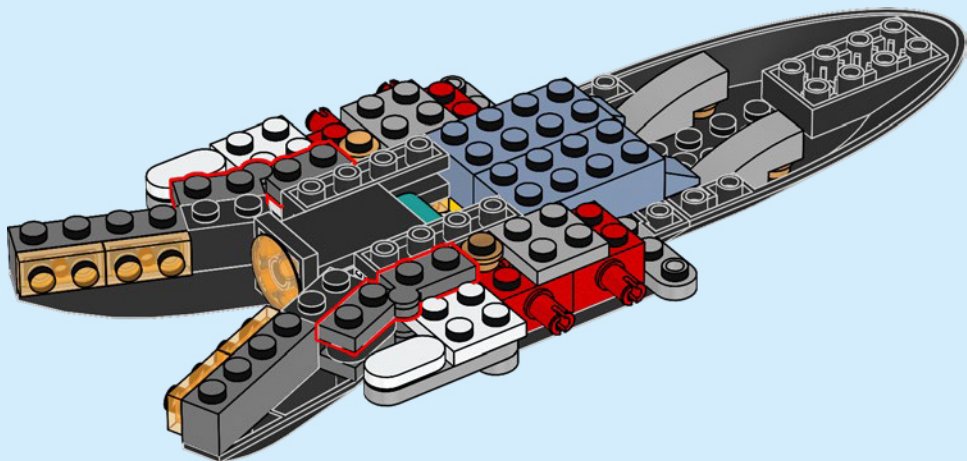



32

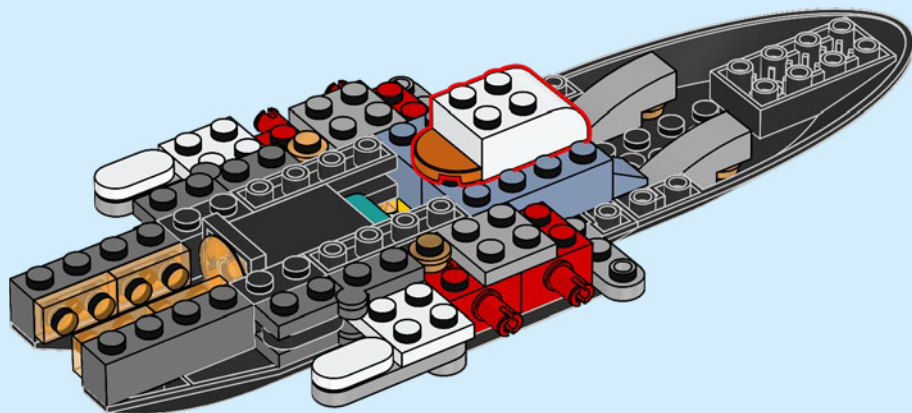





2x



2x

# 33

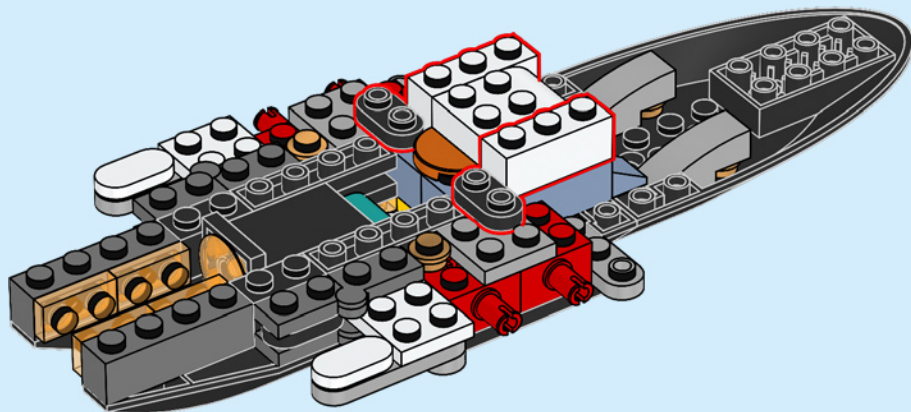



2x

34

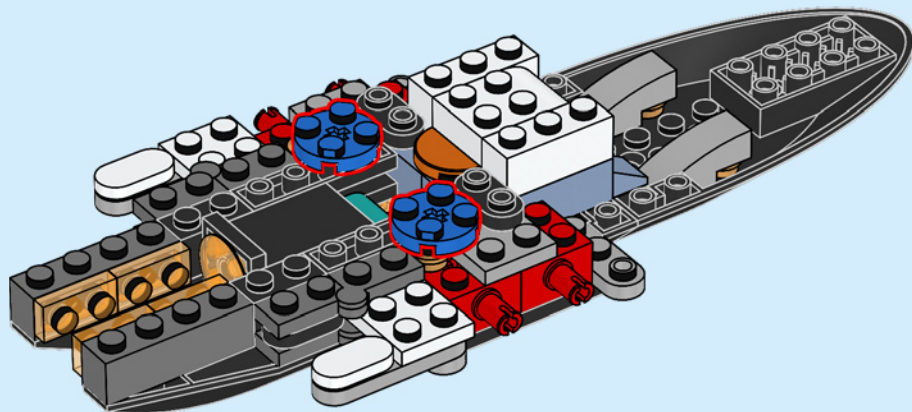

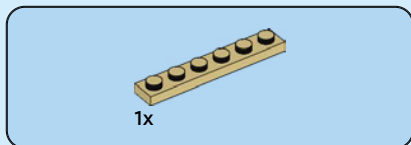

35

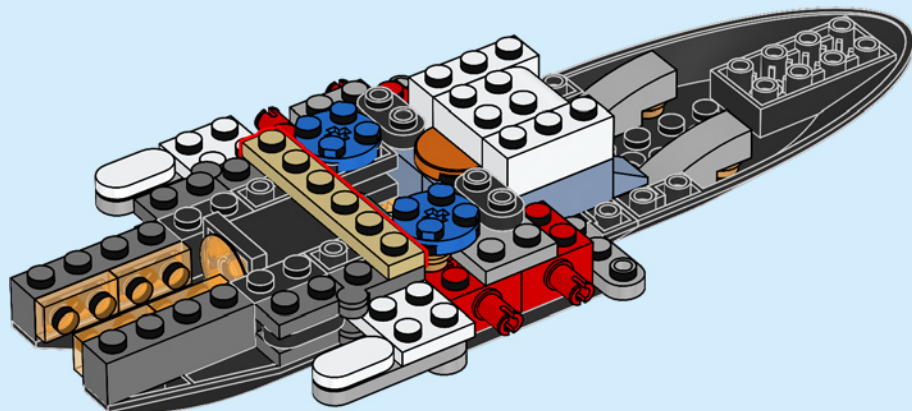



36

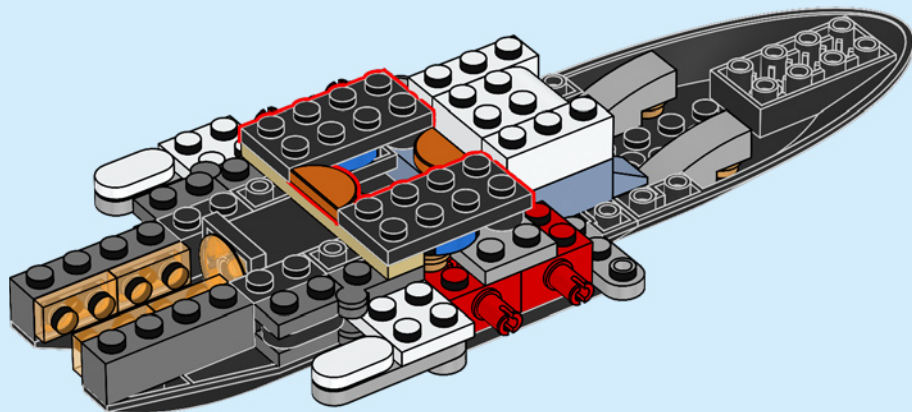



1x

37

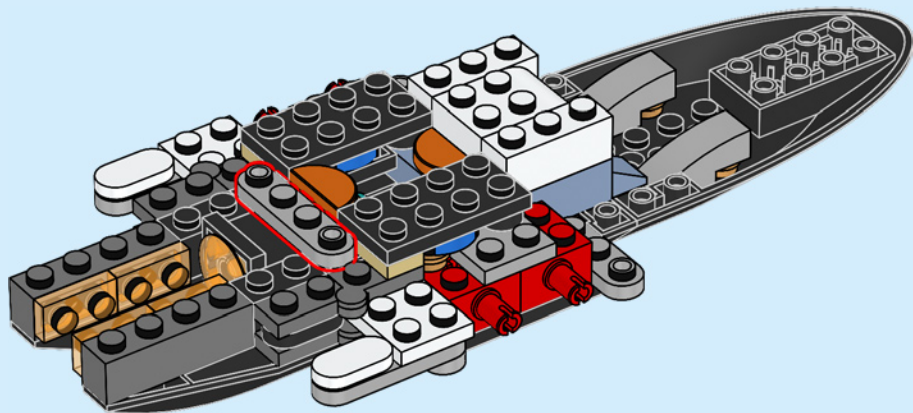



2x

# 38

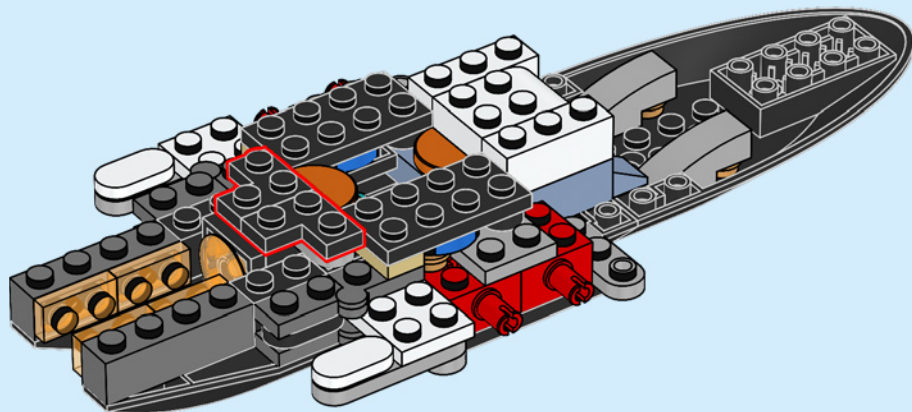



2x

39

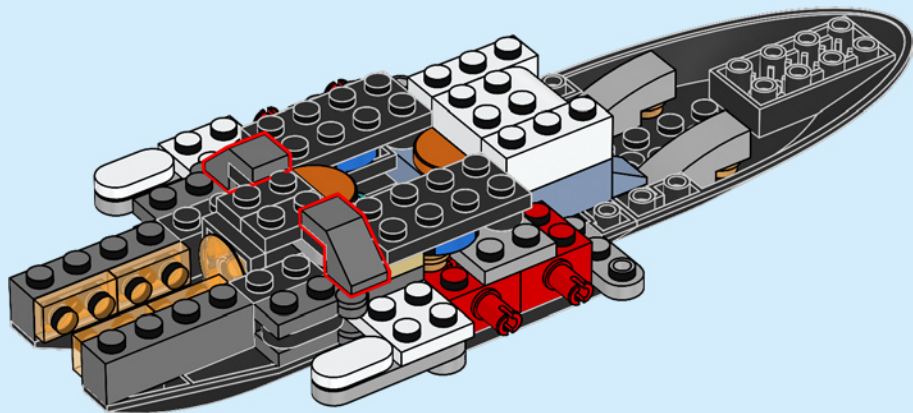

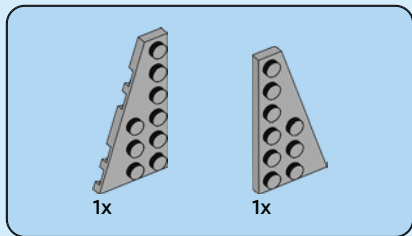

40

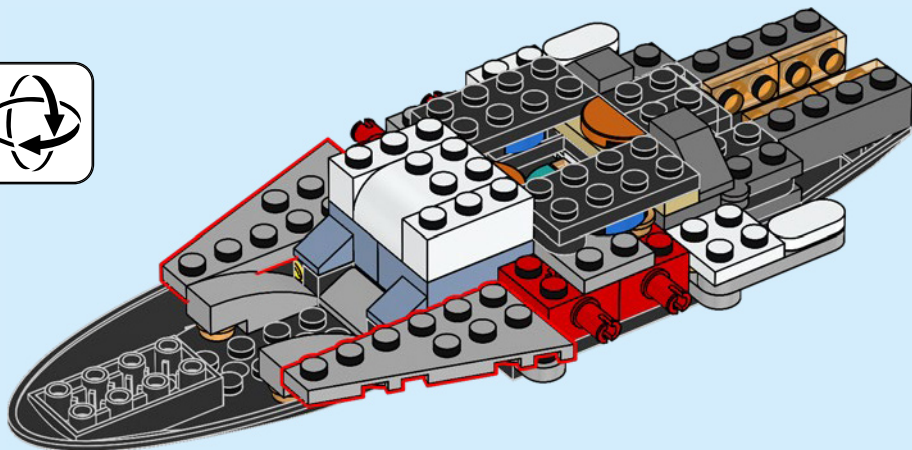



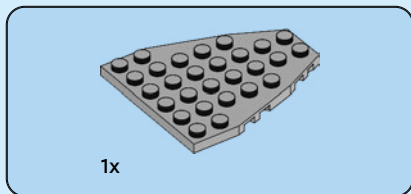

41

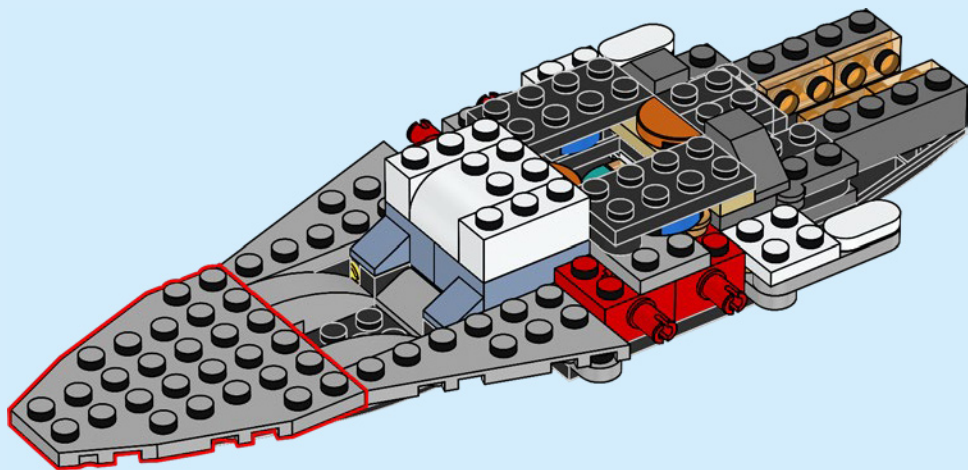



2x

42

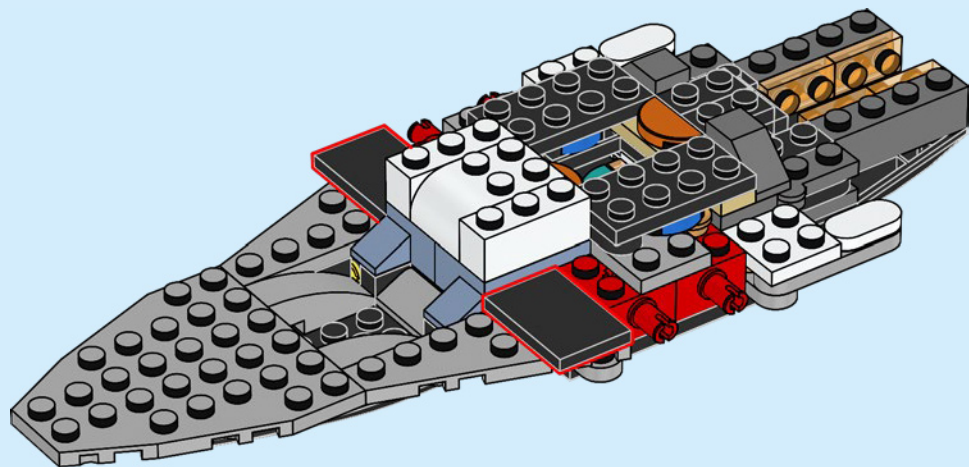

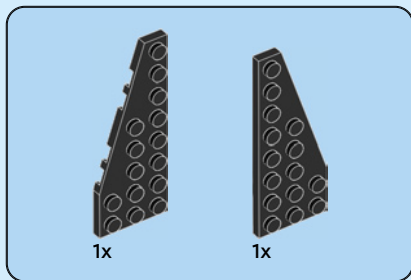

43

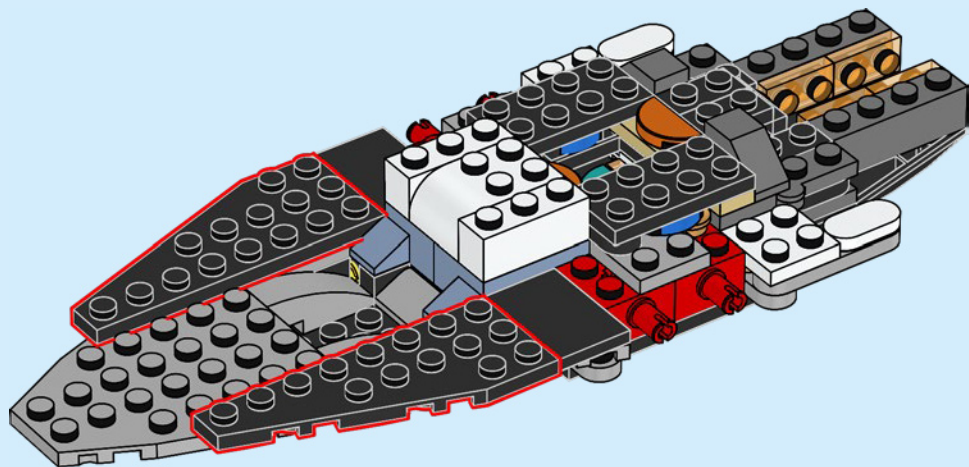



2x

44

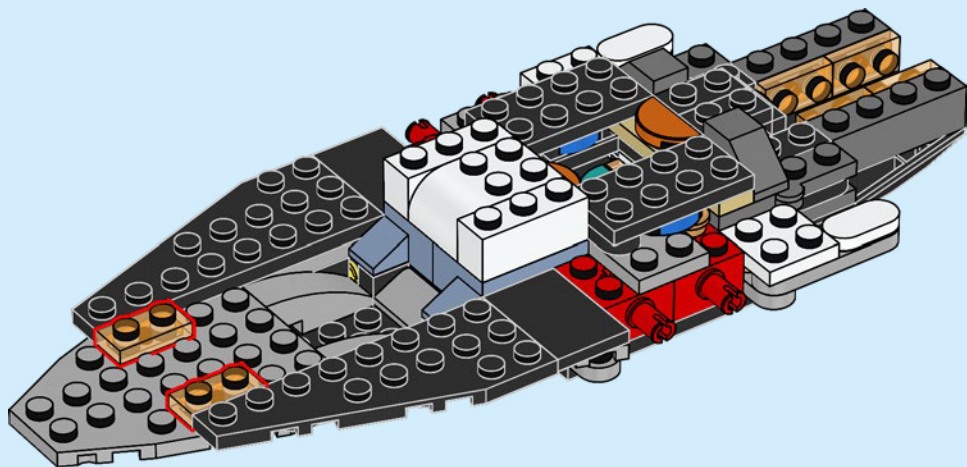



2x



2x

# 45

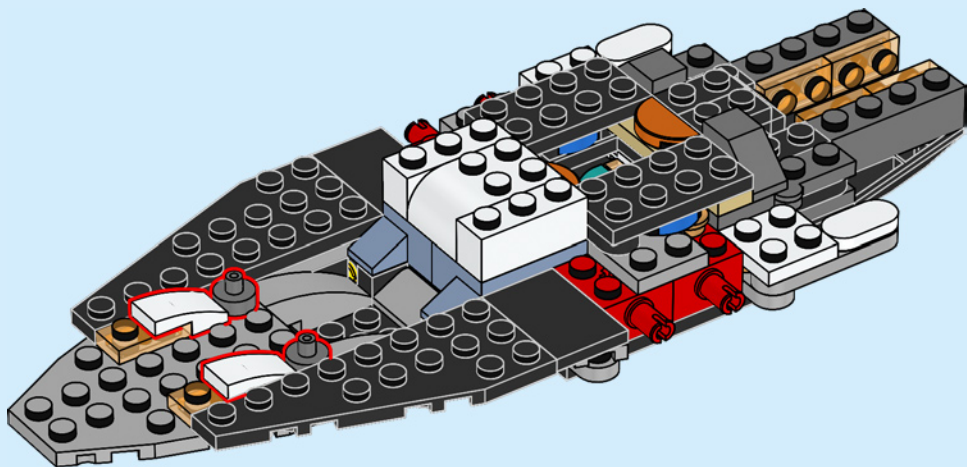



46

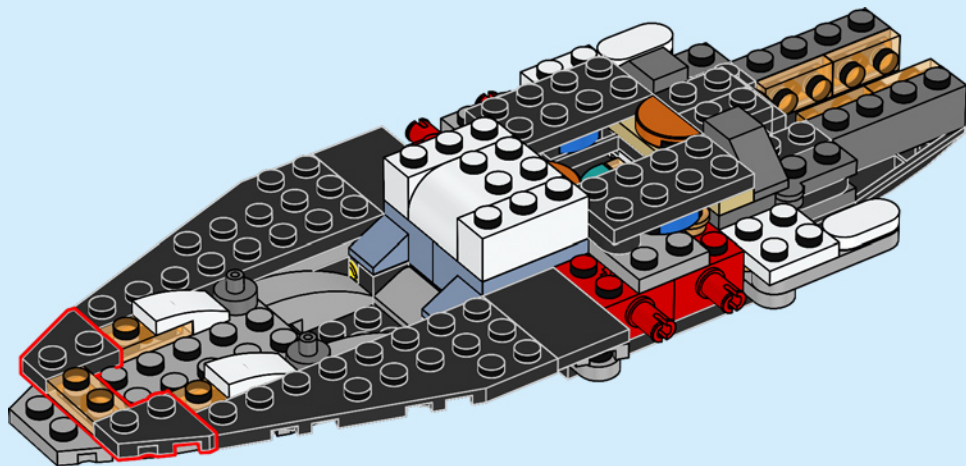



2x

47

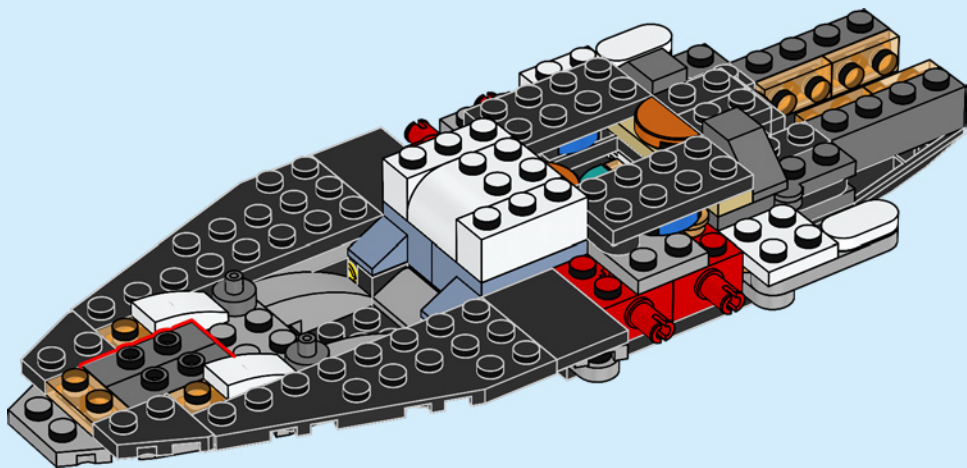





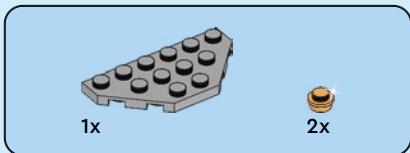
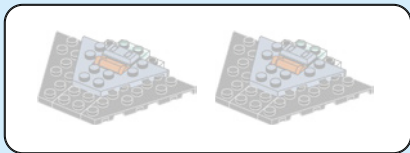

48

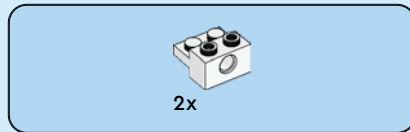

49

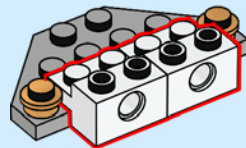

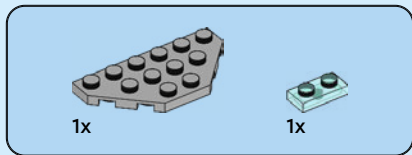

50

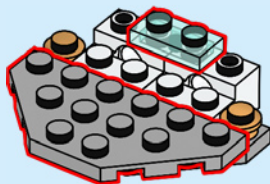
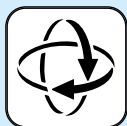

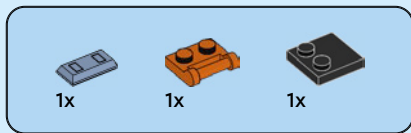

51

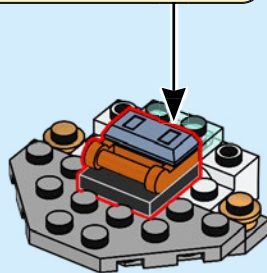
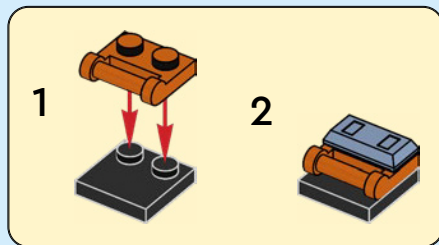

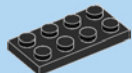

1x

52

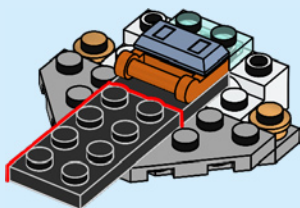

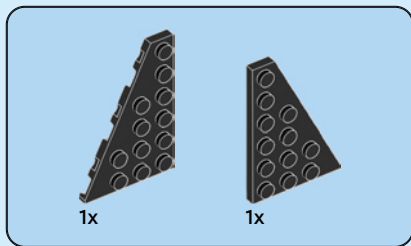

53

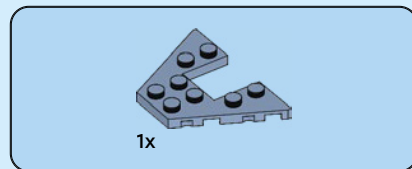
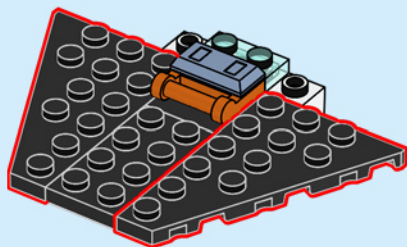

54

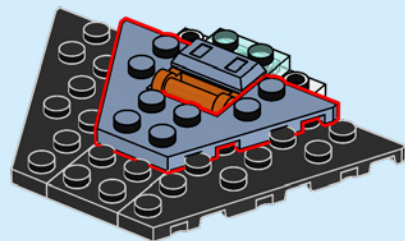

2x

55

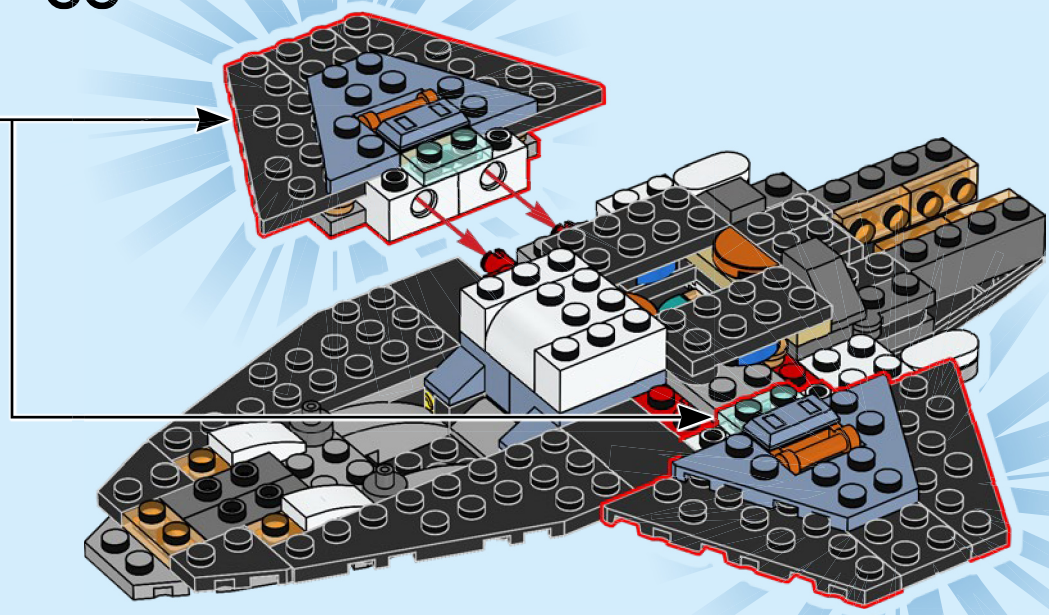

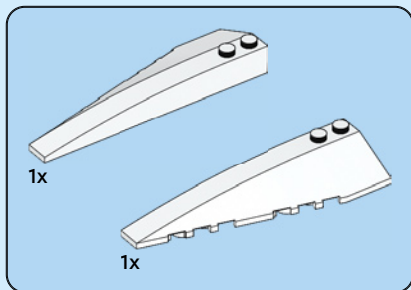

56

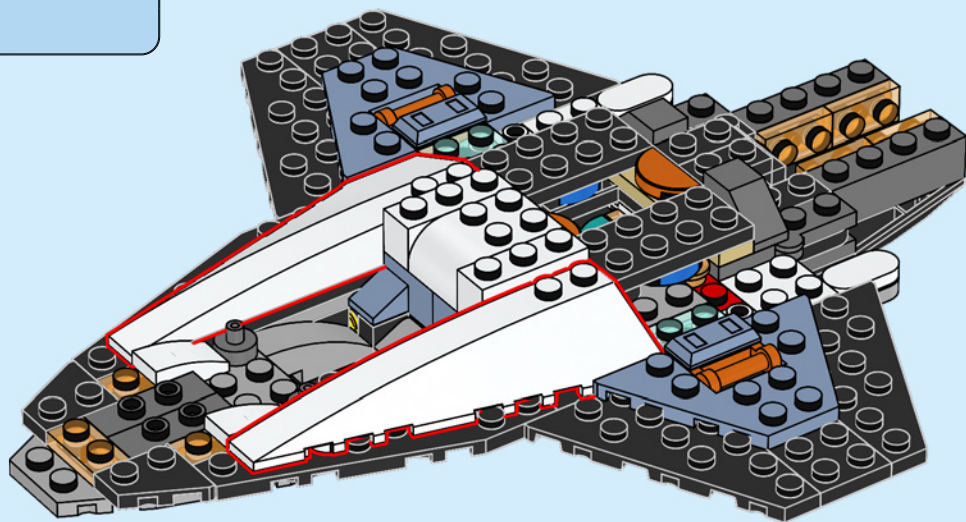



2x

57

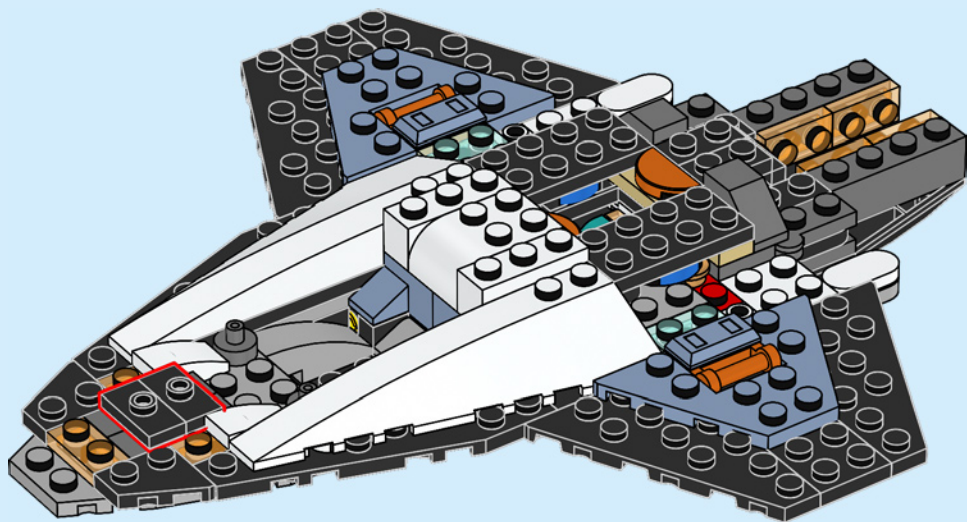





58

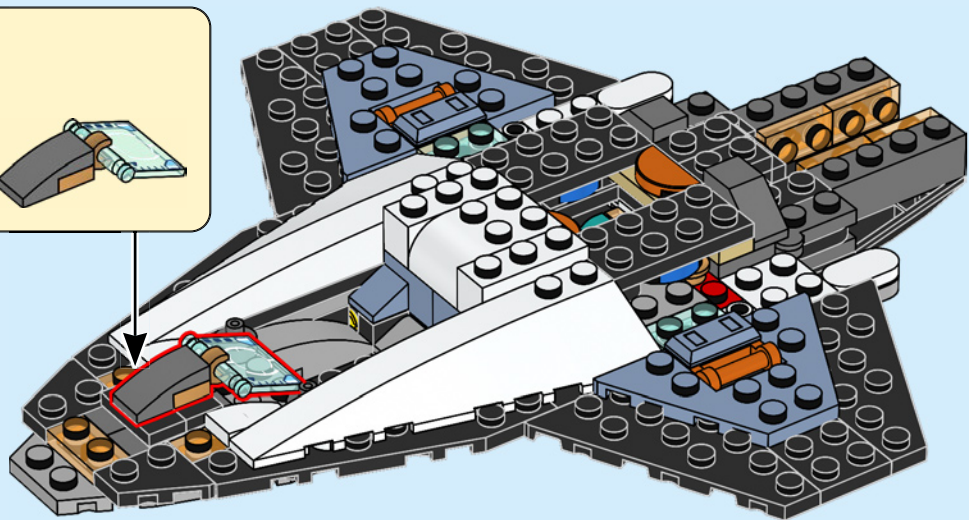
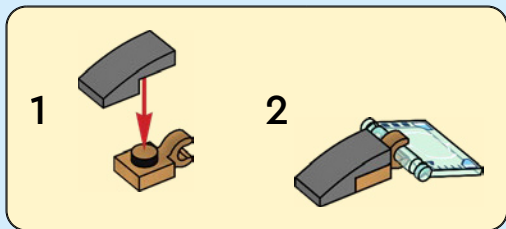



1x



1x

# 59

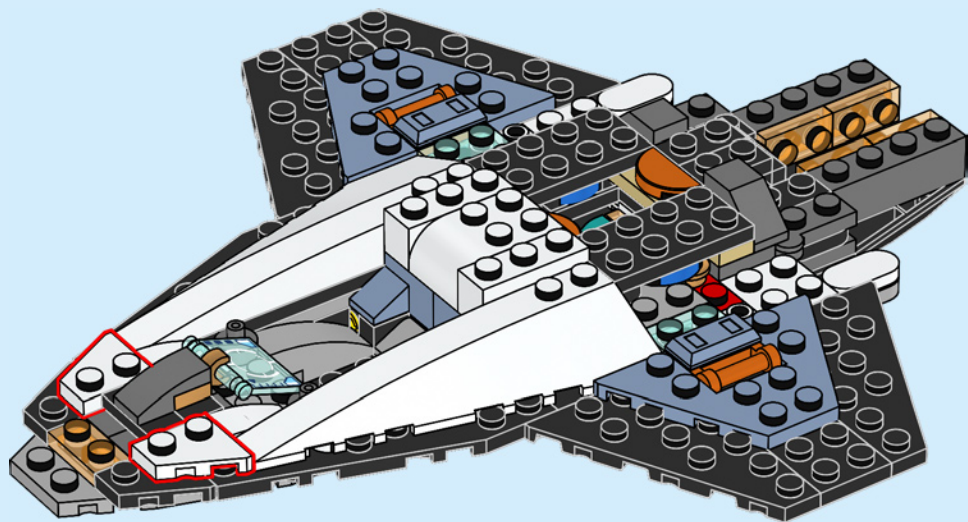

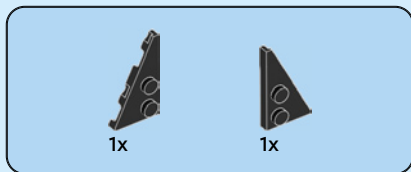

60

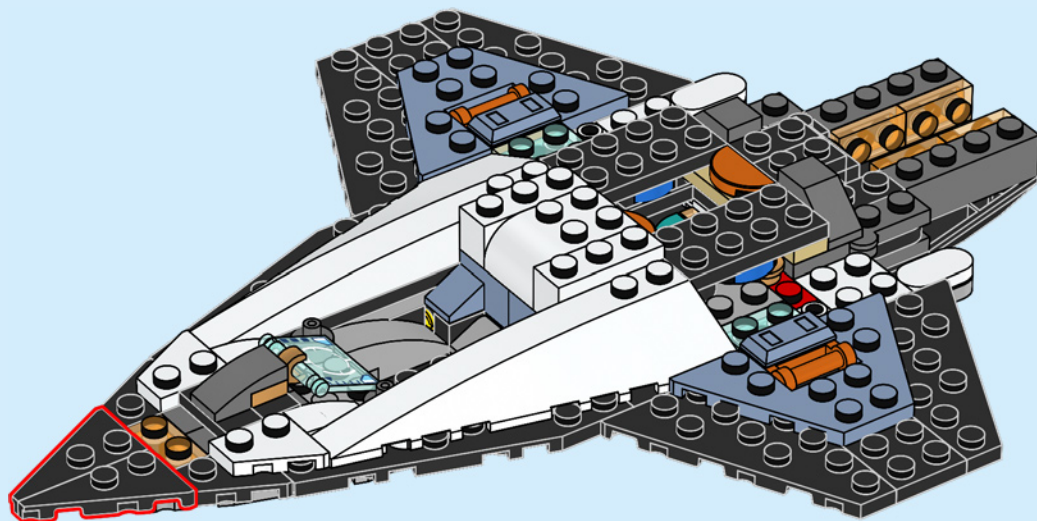

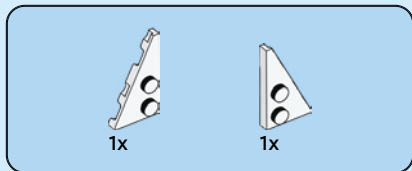

61

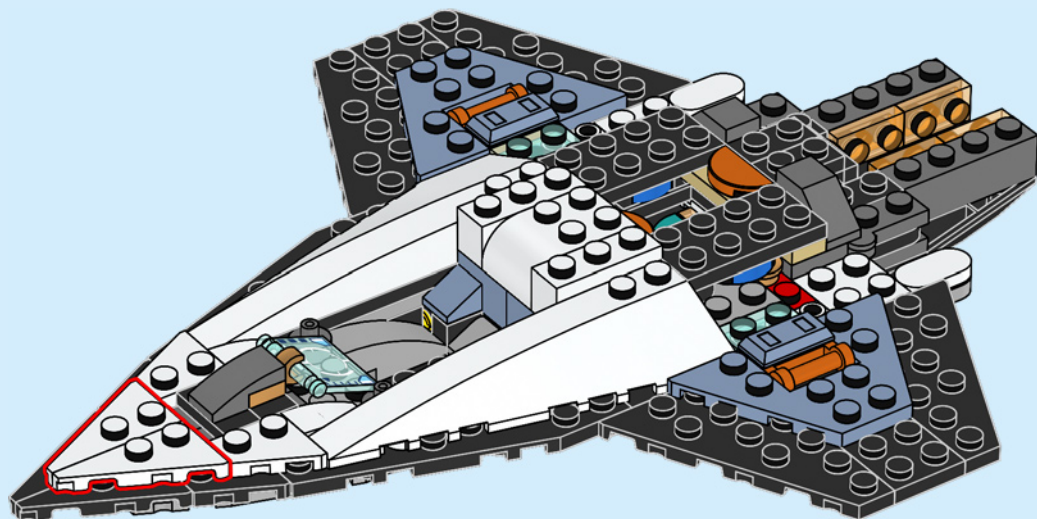



1x



1x

62

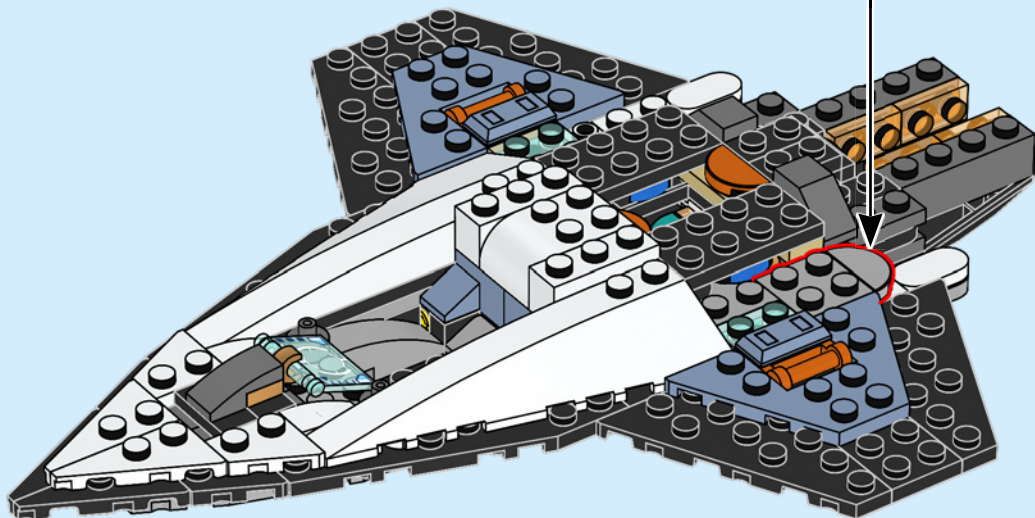



2x

63

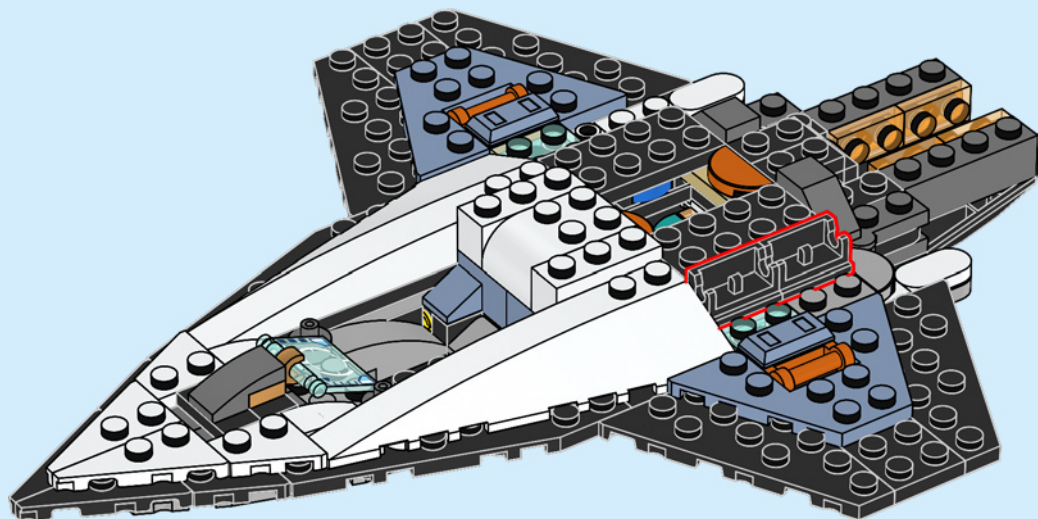





2x

64

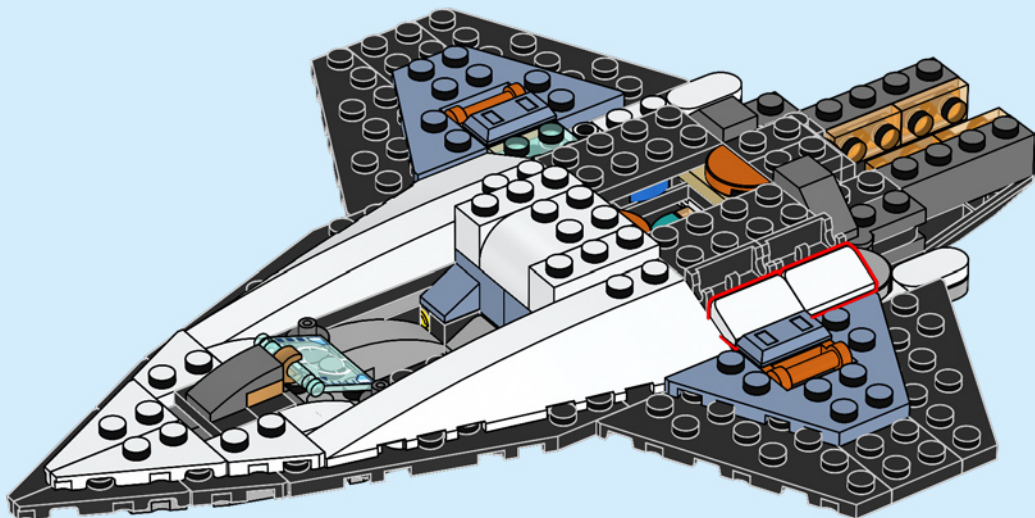



1x



1x

65

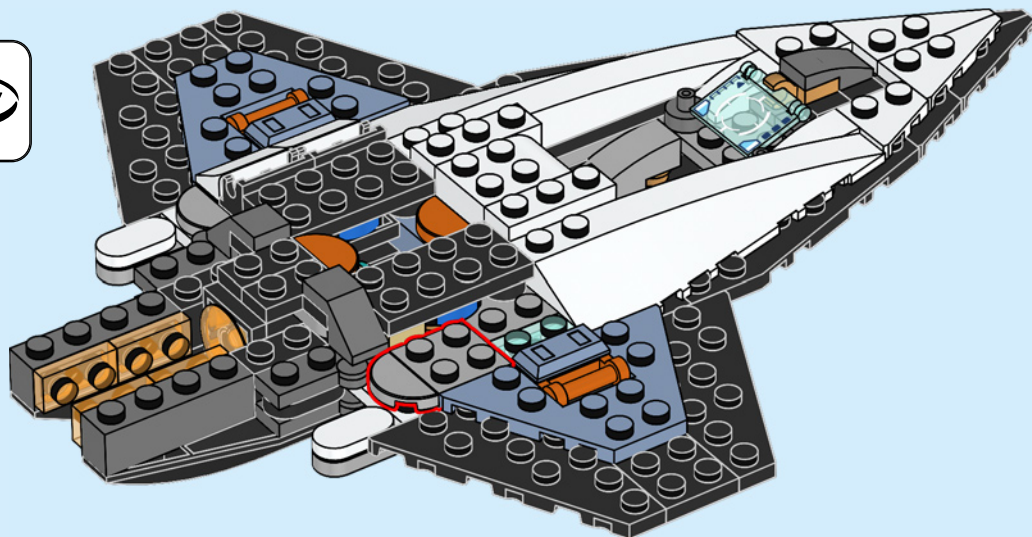





2x

66

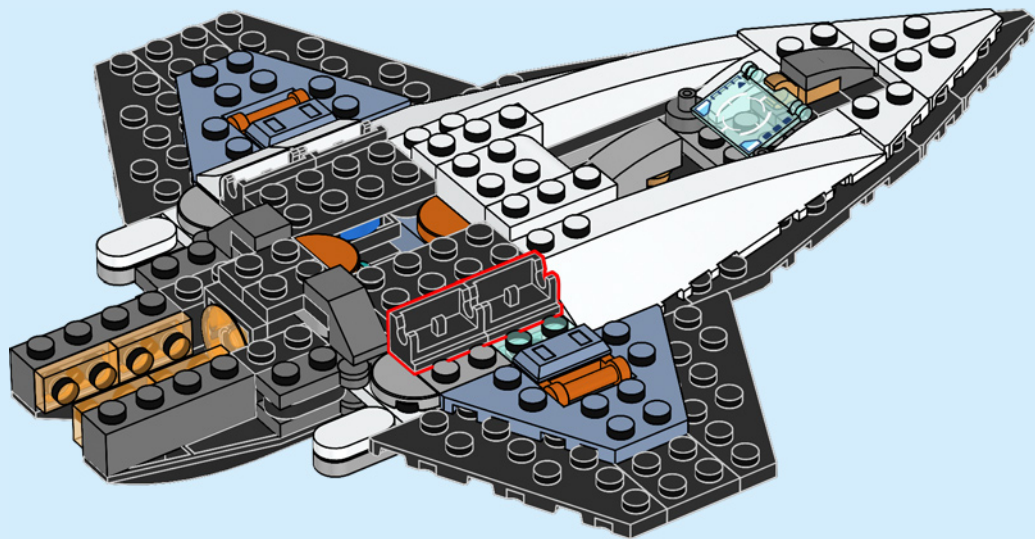



2x

67

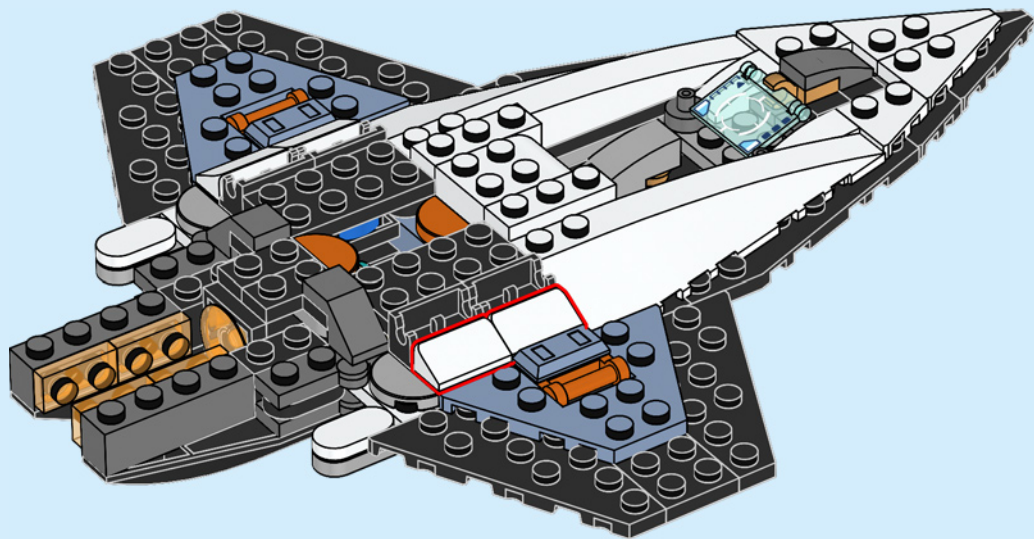



2x

68

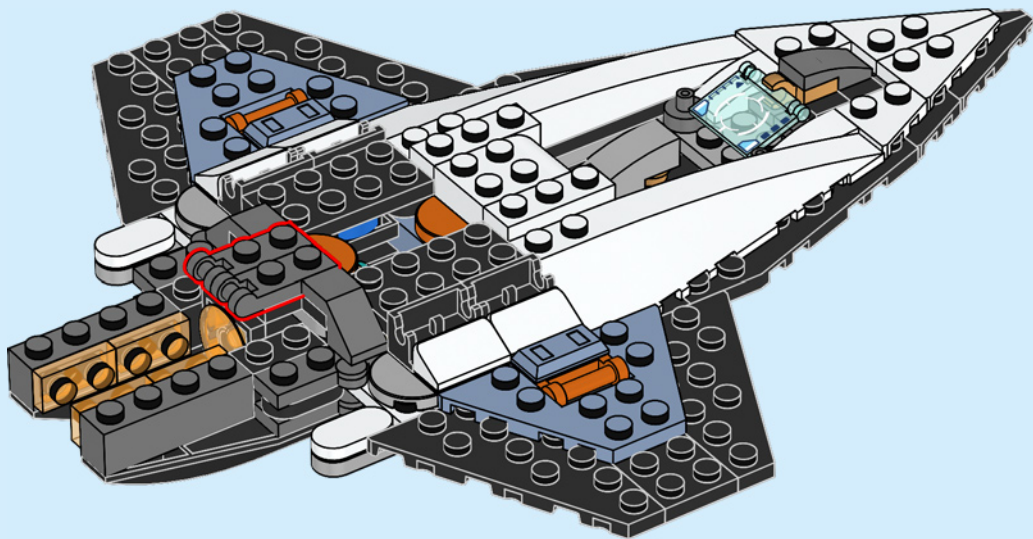

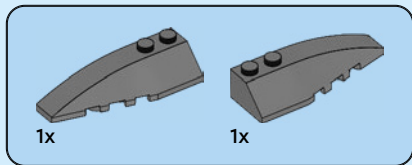

69

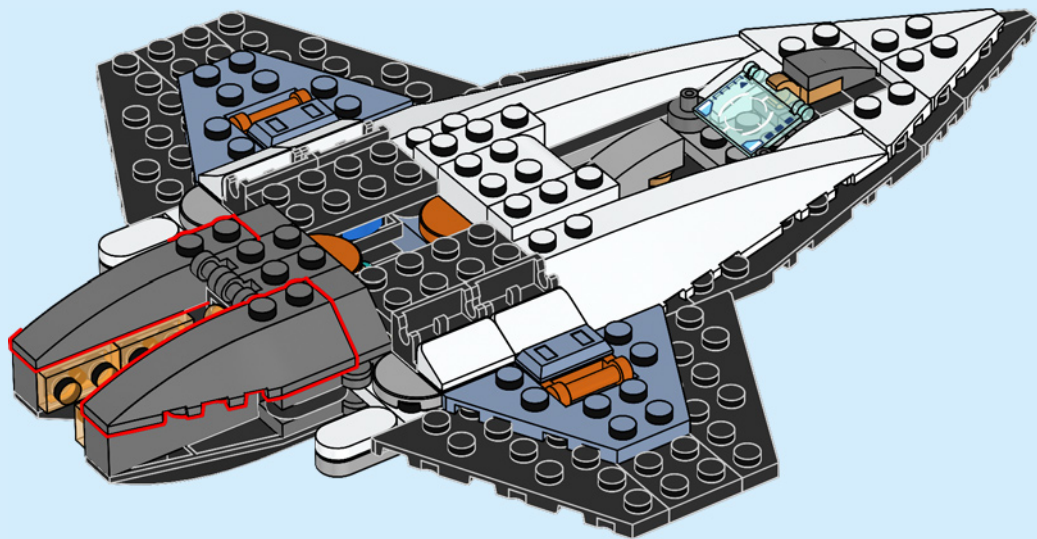

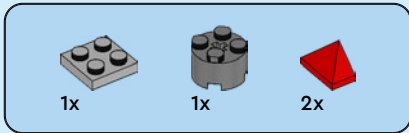

70

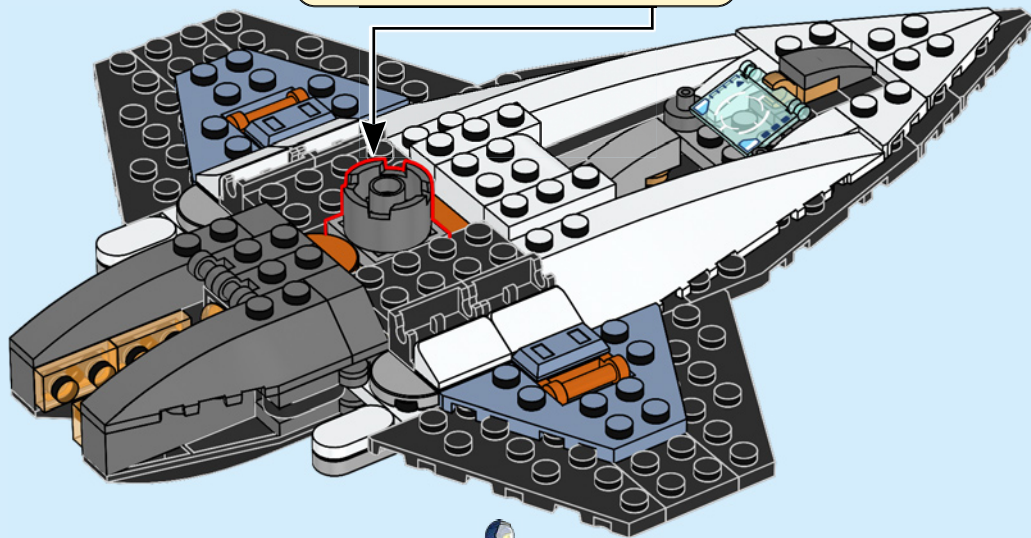
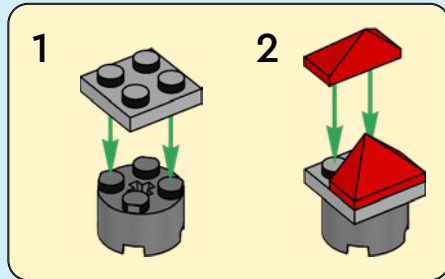

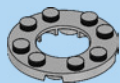

1x

71

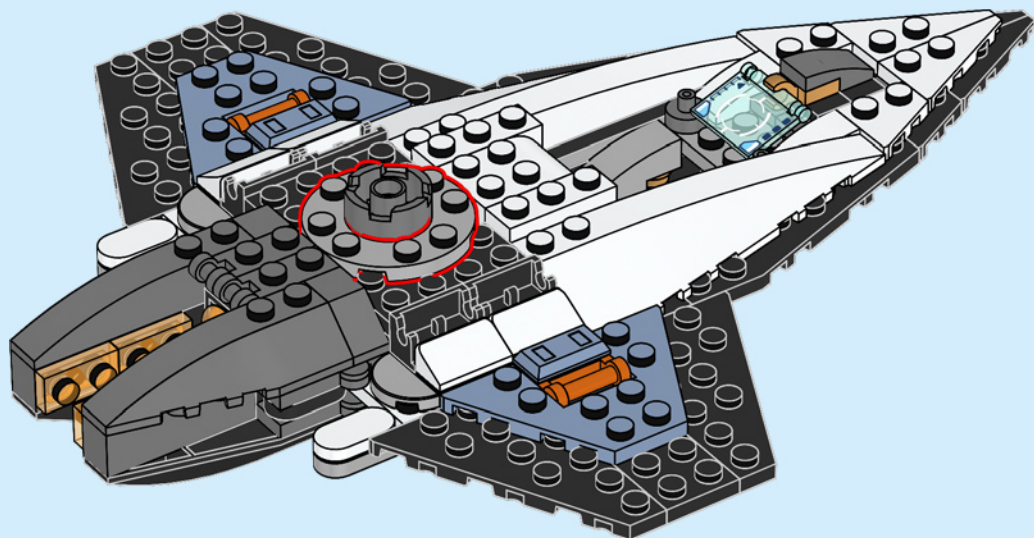



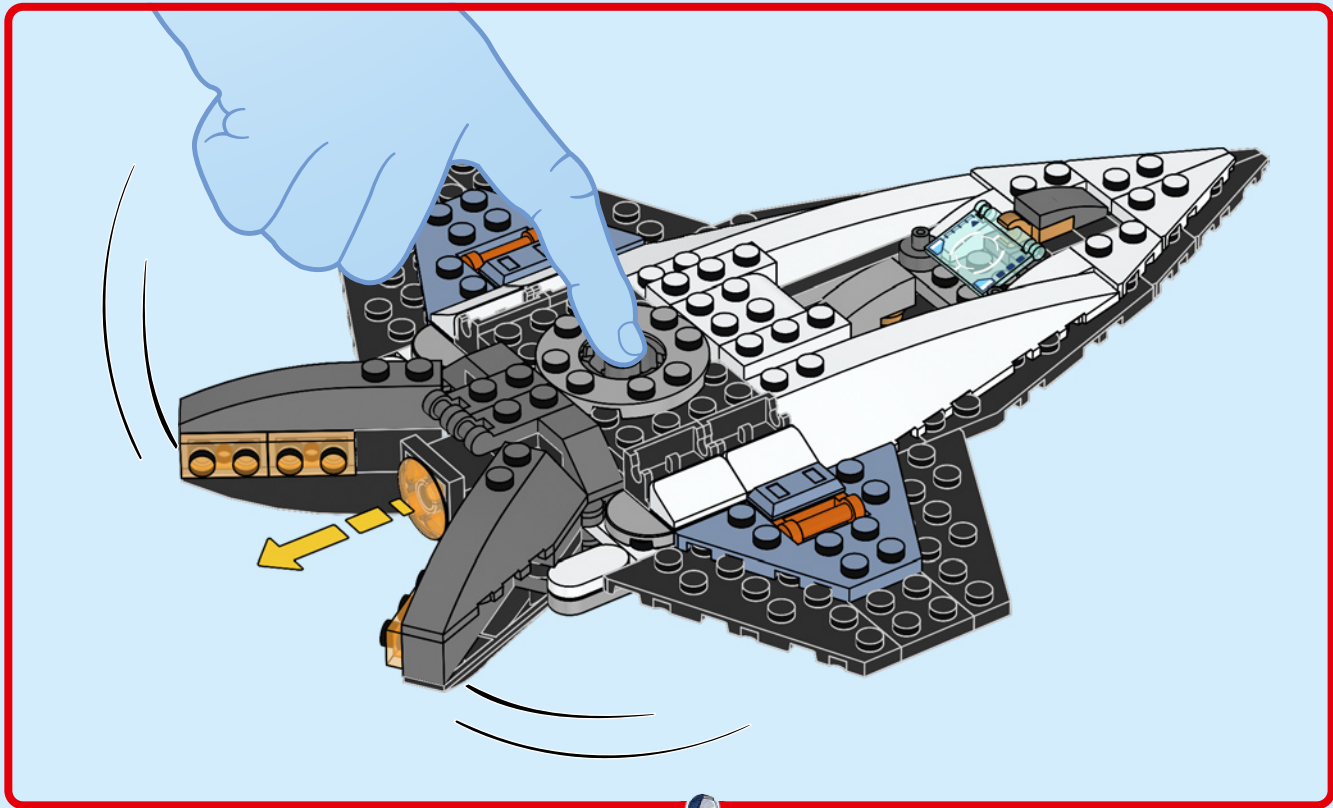



72

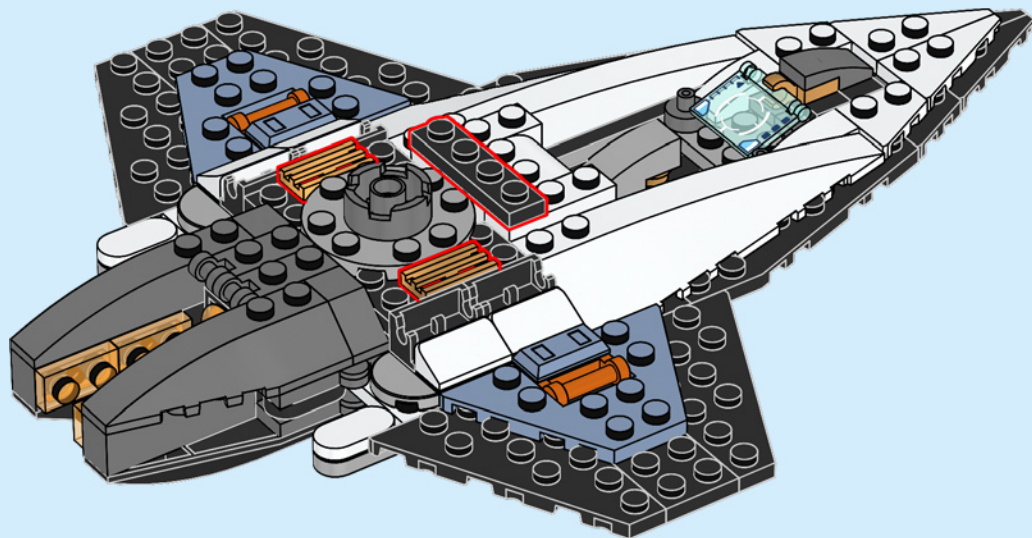





2x

73

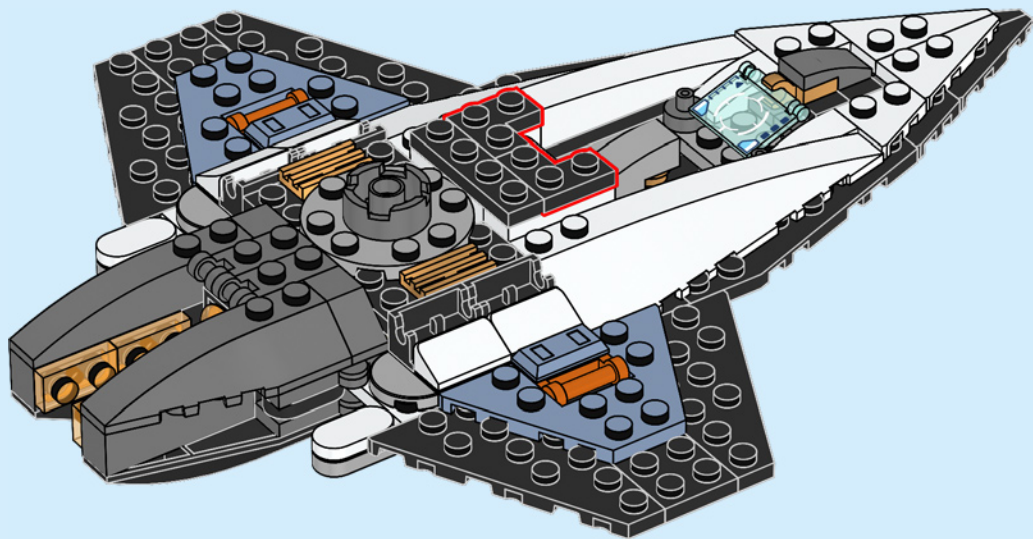

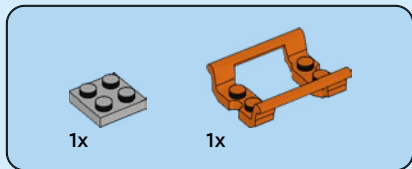

74

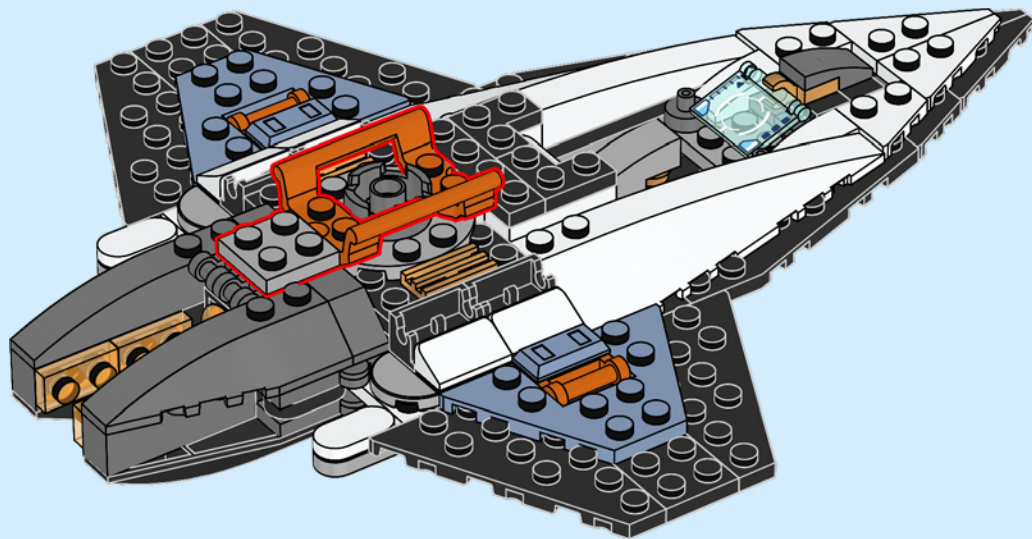

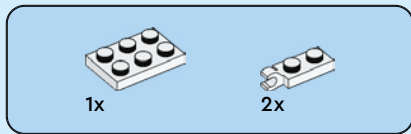

75

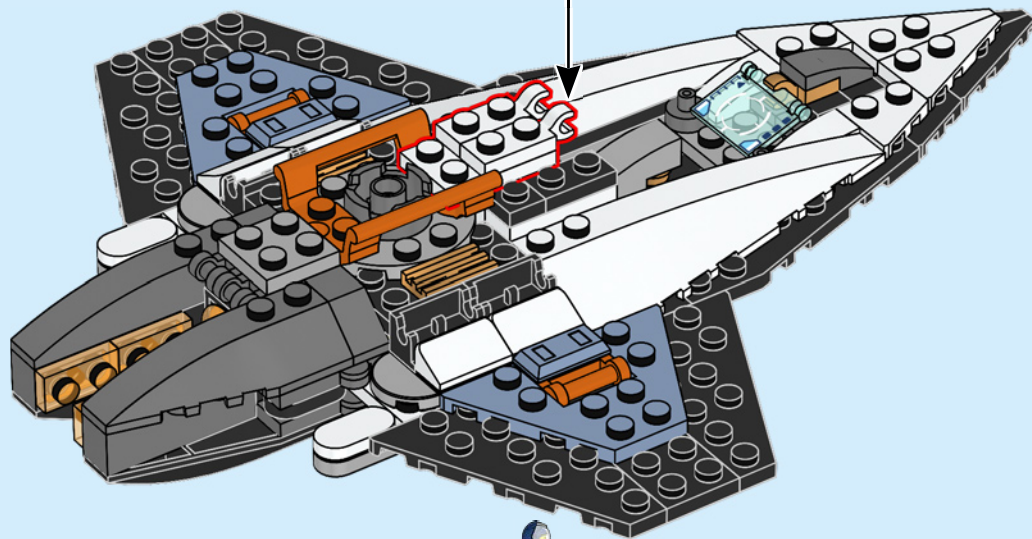
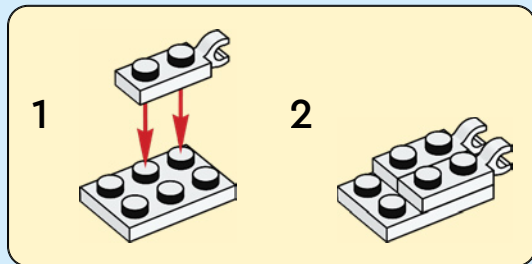



2x

76

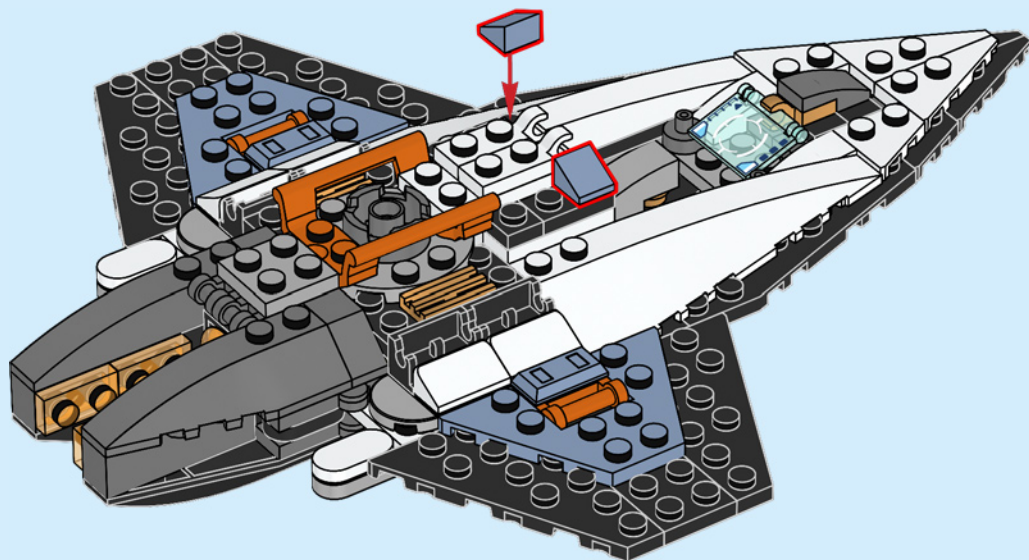



4x

77

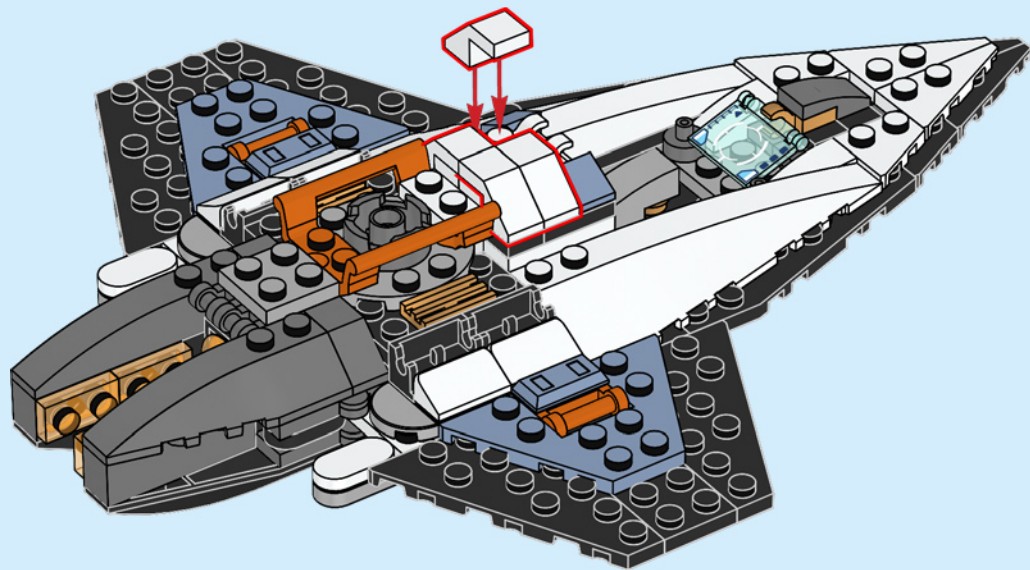

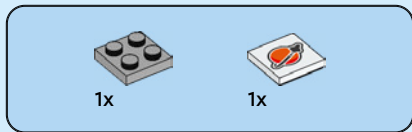

78

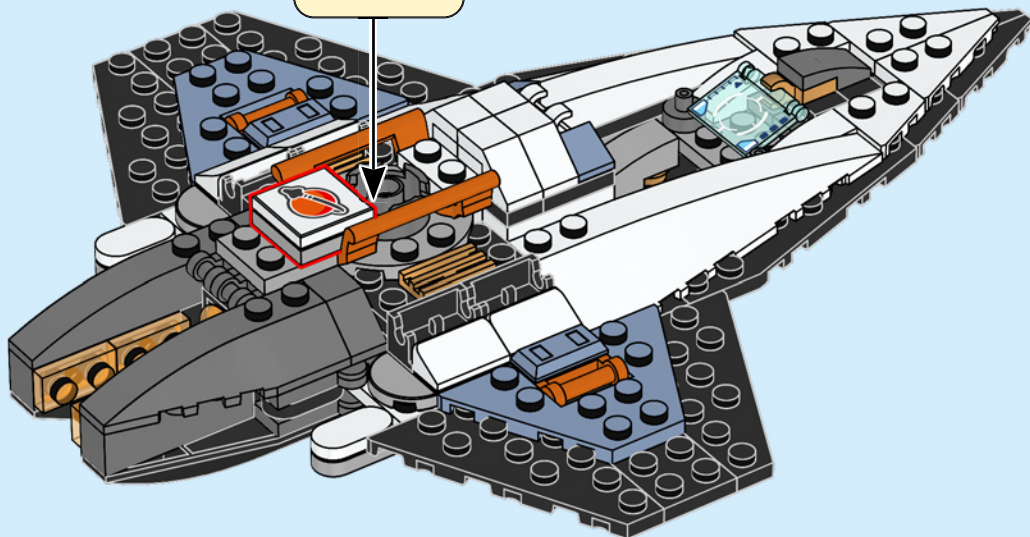
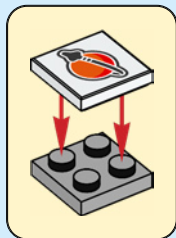





2x

79

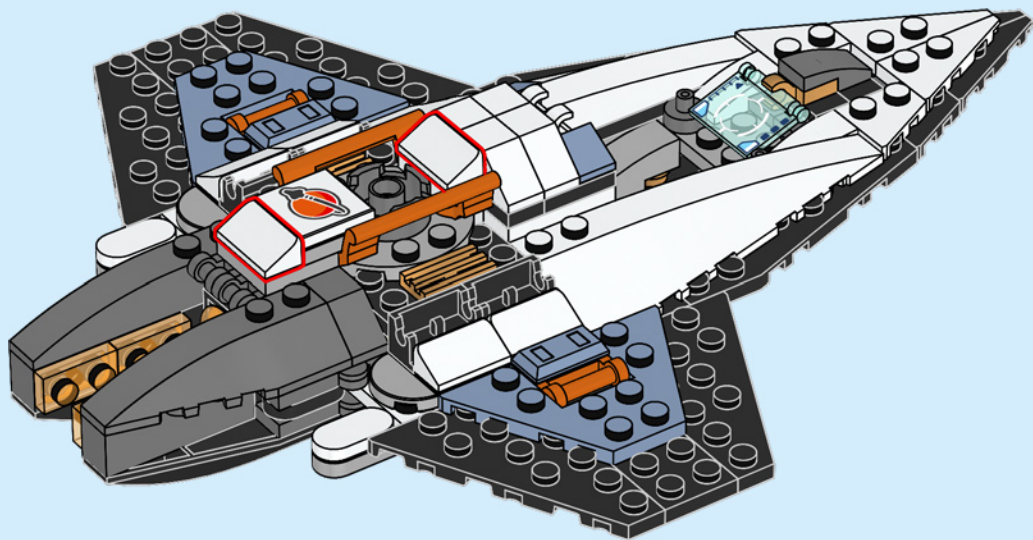



4x

80

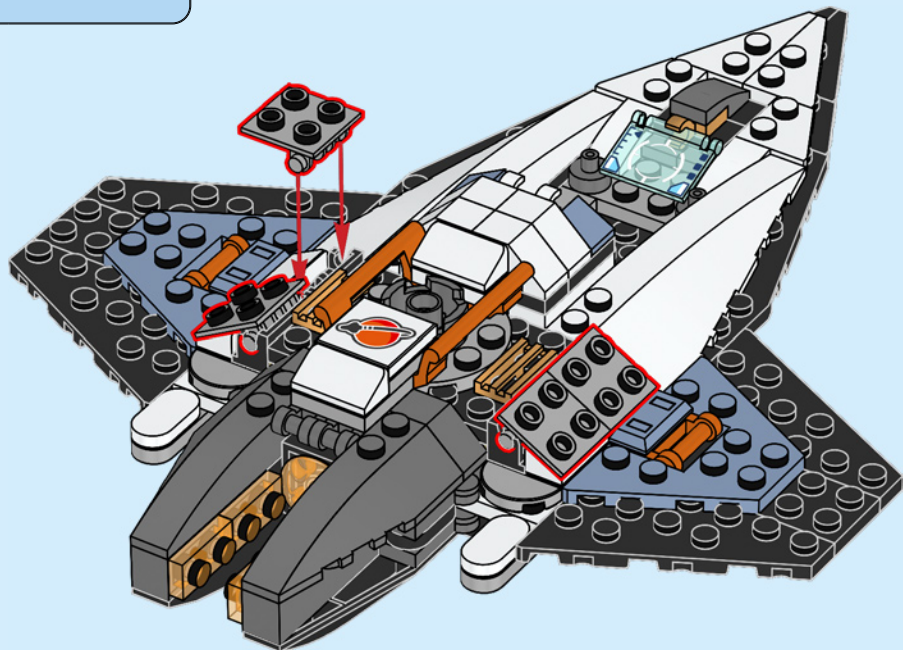



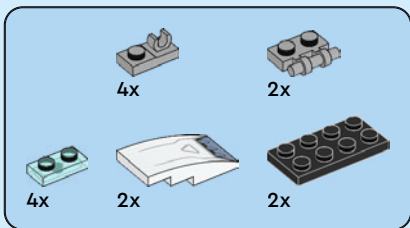
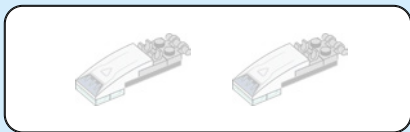

# 81

1

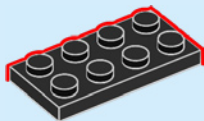

2

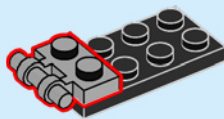

3

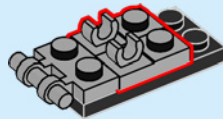

4

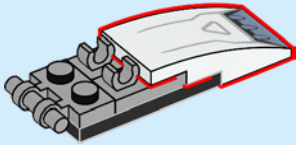

5

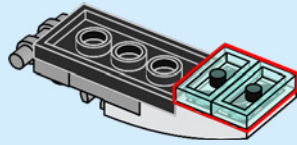
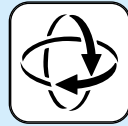

2x

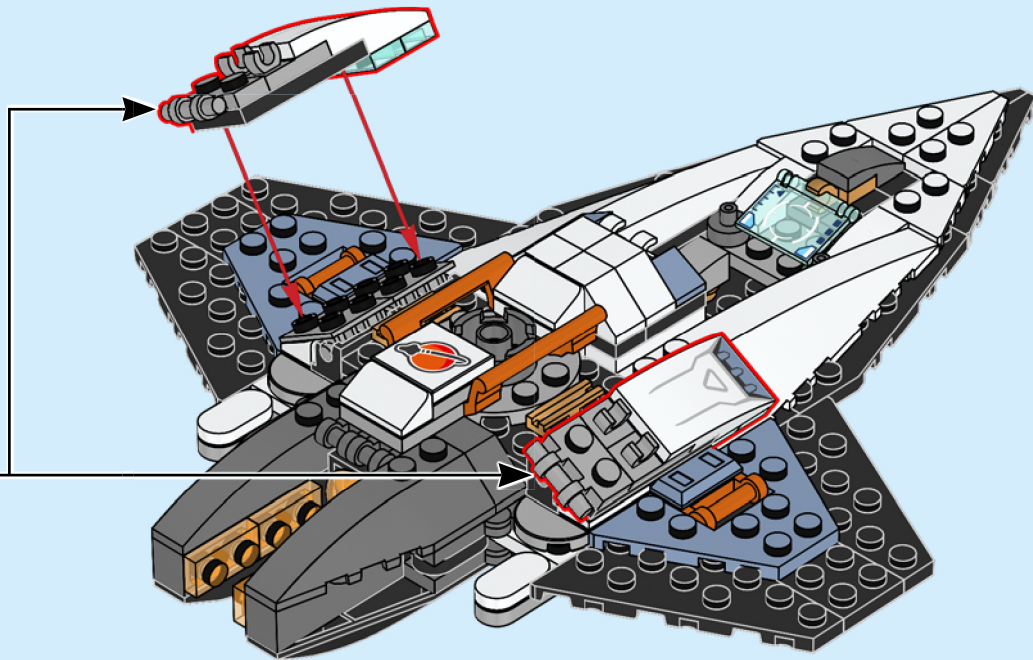

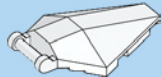

2x

82

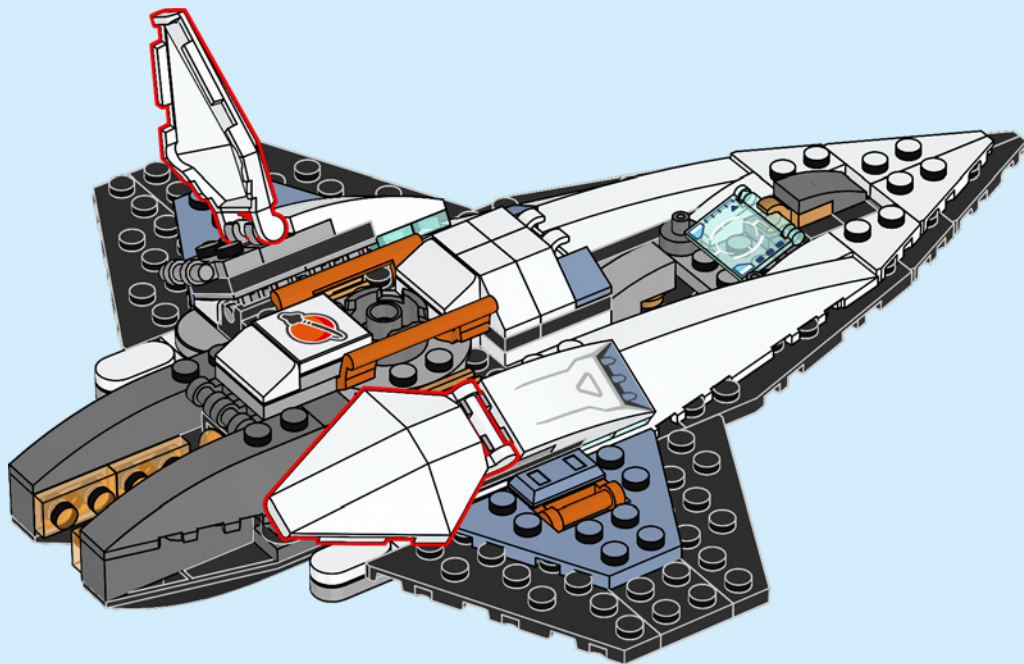

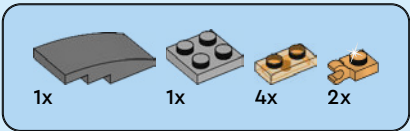
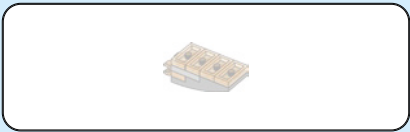

83

1

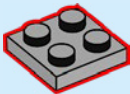

2

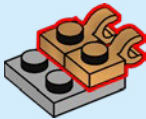

3

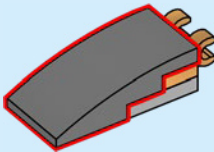

4

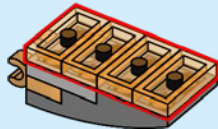

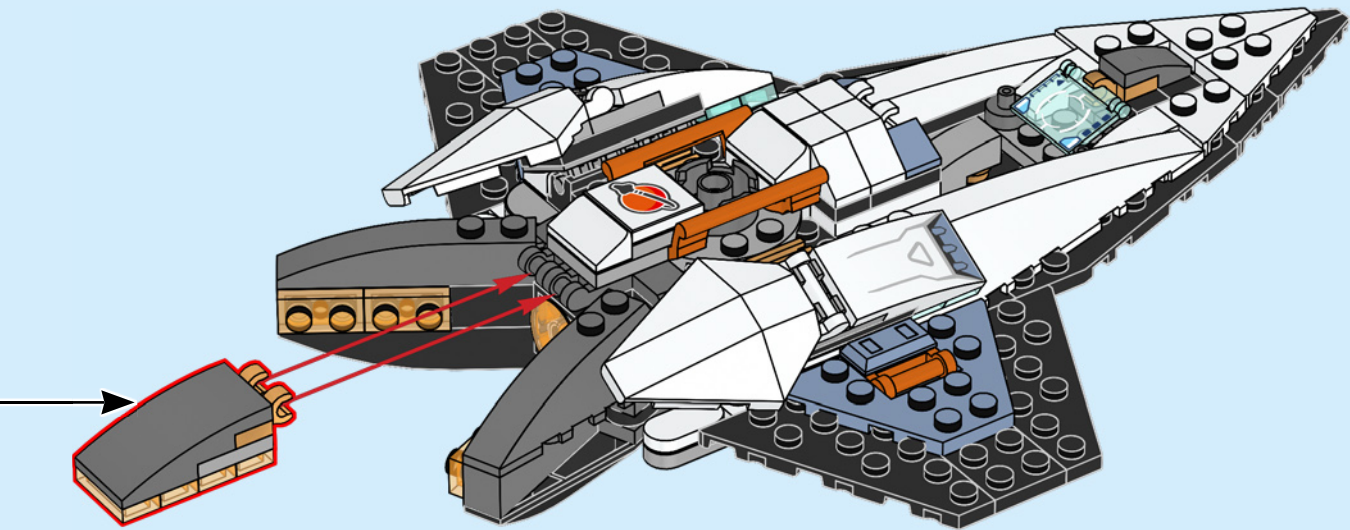

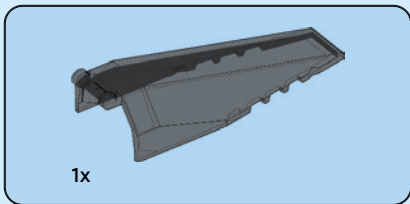

84

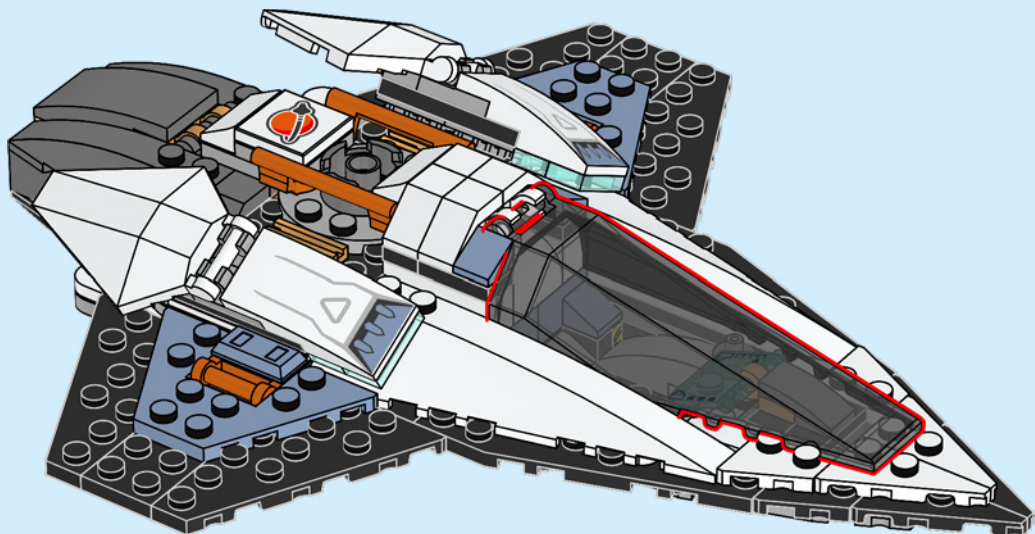

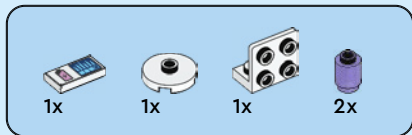

85

1



2

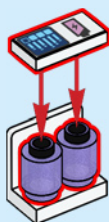

3







86

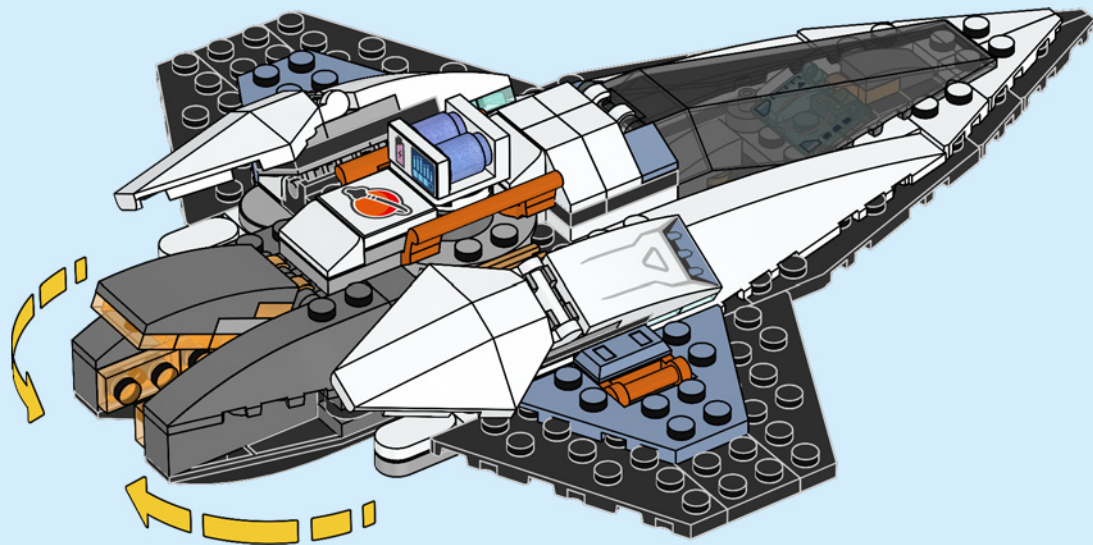

87

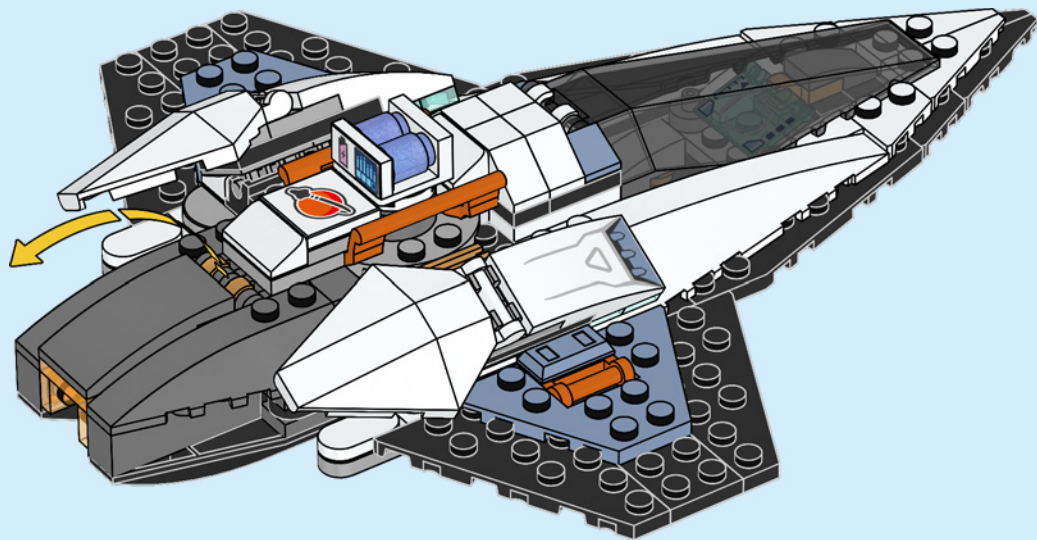

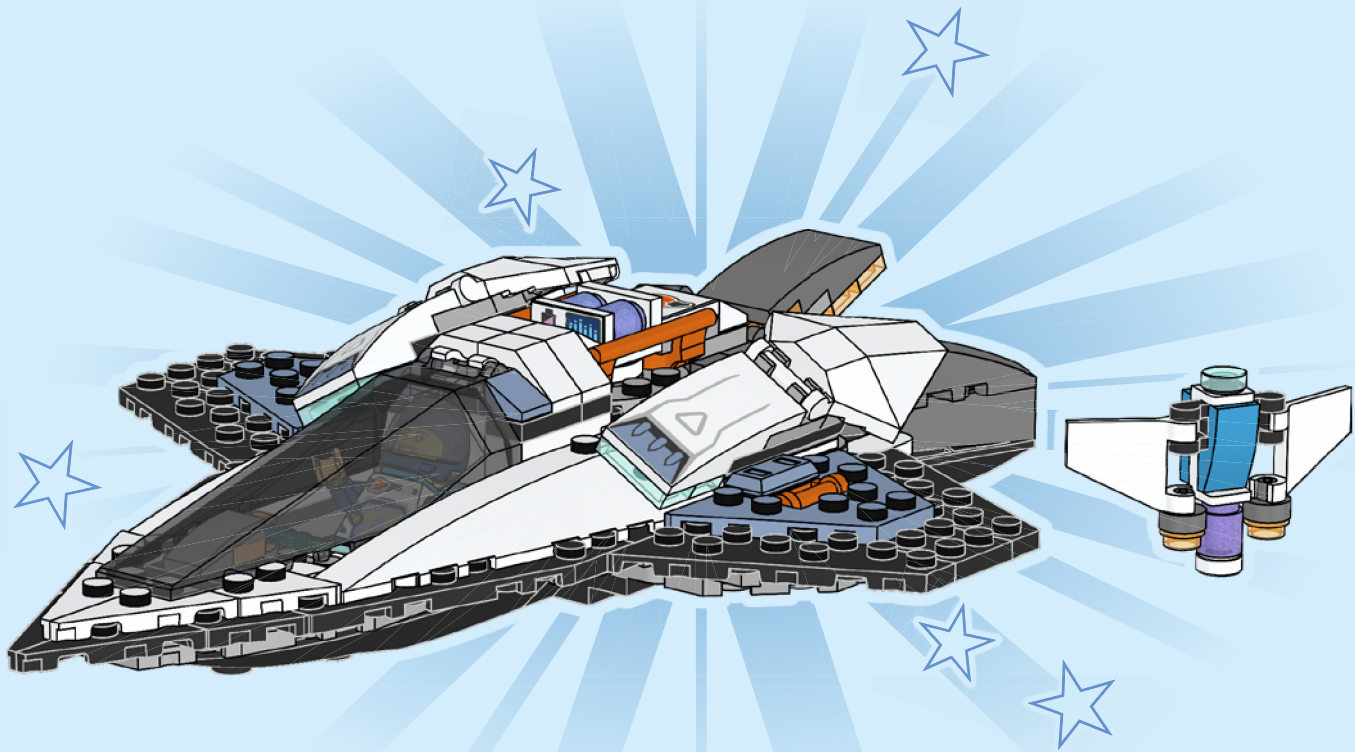





# CITY

# SPACE



60430



60433

60434



60431

Space	Spazio	太空	Világűr	Kosmos
Weltraum	Espacio	Kosmos	Spațiu	Erdvė
L'espace	Espaço	Vesmír	Kośmos	



1x  
6465627



2x  
6242241



1x  
6354823



1x  
6132203



2x  
6448745



1x  
6354822



1x  
6132204



6x  
4547489



1x  
6093053



1x  
6465630



4x  
6166894



2x  
6034044



1x  
6097637



2x  
4249563



2x  
6365500



2x  
6361170



1x  
6465626



4x  
6342970



2x  
362201



1x  
6475147



4x  
302101



1x  
621501



2x  
6469017



2x  
6341902



1x  
6015477

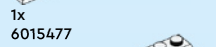

1x  
6015474



3x  
4124067



2x  
6075074



4x  
6347696



2x  
403223



2x  
6331822



1x  
4218699



1x  
6465631



1x  
302024



1x  
6295295



1x  
6141554



1x  
6295293



1x  
6141556



5x  
6210270



2x  
300426



4x  
393726



2x  
6092585



1x  
6250020



1x  
4251394



1x  
4251393



1x  
6398391



4x  
242026



2x  
6192346



2x  
6258209



2x  
6258214



4x  
6162892



1x  
371026



2x  
265326



6x  
302026



1x  
6468984



1x  
6468980

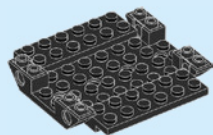

1x  
6472684

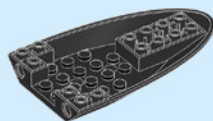

1x  
6472688



1x  
6469829



1x  
6274739



1x  
6469015



6x  
6240222



1x  
6466044



4x  
6062686



2x  
6372479



2x  
6406007



2x  
6468983



1x  
6465624



1x  
6475149



2x  
6240227



1x  
6171727



14x  
6240217



2x  
6408629



1x  
4568637



4x  
6326078



2x  
4211632



1x  
4282789



1x  
4282786



9x  
4211397



4x  
4211881



2x  
4251163



7x  
6456718



1x  
6167798



4x  
4211352

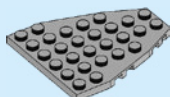

1x  
6038296



10x  
4523159



3x  
6284379



2x  
4490599



3x  
6464814



4x  
6271752



1x  
4249139



2x  
6168776



1x  
6029948



1x  
6469463



2x  
4521187



2x  
6343852



2x  
4210725



4x  
6416526



1x  
6005668



1x  
6063685



1x  
6063681

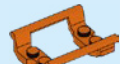

1x  
6468985



1x  
6440101



2x  
6474749



2x  
6468361



1x  
6471481



1x  
4653988



1x  
6137300



 [LEGO.com/service](https://www.LEGO.com/service)

YOU COULD **WIN**



Scan this QR code or go to **LEGO.COM/PRODUCTFEEDBACK** and give us your short feedback about this LEGO® set for a chance to win a cool LEGO prize.

Terms and Conditions apply\*

**EN: YOU COULD WIN.** Terms and Conditions apply\* **DE: Du könntest GEWINNEN.** Es gelten die Teilnahmebedingungen\* **FR: Tu pourrais GAGNER.** Des conditions s'appliquent\* **IT: Potresti VINCERE tu.** Termini e condizioni sono applicabili\* **ES: Puedes GANAR.** Aplican términos y condiciones\* **PT: Poderá GANHAR.** Aplicam-se termos e condições\* **ZH: 轻松获奖. 条款和条件适用\*** **PL: Szansa na WYGRANĄ.** Obowiązują warunki korzystania\* **CS: Máte šanci VYHRÁT.** Platí všeobecné smluvní podmínky\* **SK: Máte šancu VYHRAŤ.** Platia všeobecné zmluvné podmienky\* **HU: TE IS NYERHETSZ.** Felhasználási feltételek érvényesek\* **RO: Ai putea CÂȘTIGA.** Se aplică termenii și condiții\* **BG: Можете да СПЕЧЕЛИТЕ.** Има определени правила и условия\* **LV: Tu vari LAIMĒT.** Ir spēkā noteikumi un nosacījumi.\* **ET: Sul on võimalus VÕITA.** Kehtivad tingimused\* **LT: Jūs galite LAIMĖTI.** Taikomos sąlygos\*

\*[LEGO.com/productfeedback-terms](https://www.lego.com/productfeedback-terms)

LEGO and the LEGO logo are trademarks of the LEGO Group. ©2024 The LEGO Group.

6492832