

The LEGO logo is positioned in the top left corner of the advertisement. It consists of the word "LEGO" in a bold, white, sans-serif font, set against a red rectangular background.

# HERO FACTORY



6293



**WARNING: CHOKING HAZARD.**  
Toy contains small parts and a small ball.  
Not for children under 3 years.

HEROFACTORY.LEGO.COM



# HERO FACTORY

# +300

# GAME POINTS

Use the code - get 300 game points  
Utilise le code - obtiens 300 points bonus  
Consigue 300 puntos para el juego en la web con este código







1

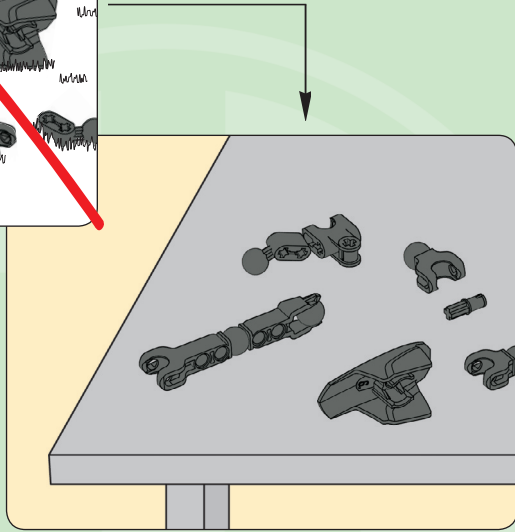
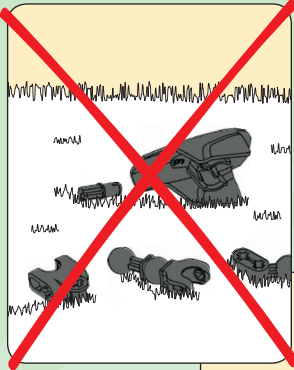

2

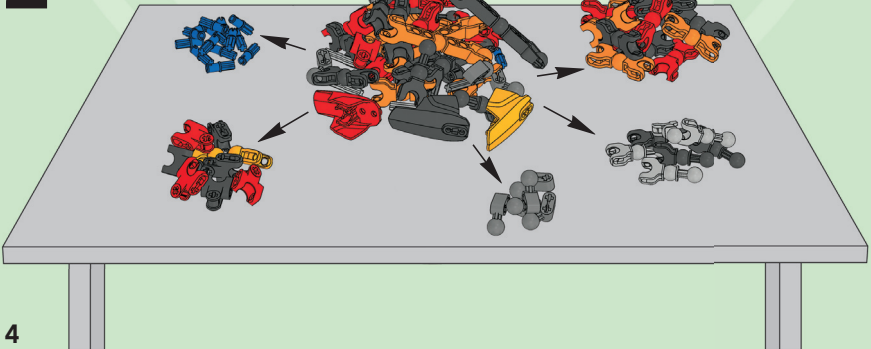

4



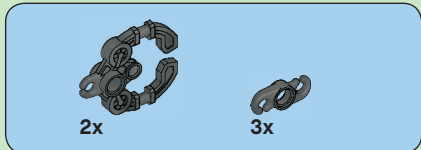

**1**

**⚠ AVERTISSEMENT : RISQUE D'ÉTOUFFEMENT.**  
 Le jouet contient des petites pièces ainsi qu'une petite boule.  
 Il ne convient pas aux enfants de moins de 3 ans.

**⚠ ADVERTENCIA: PELIGRO DE ASFIXIA.**  
 Juguete que contiene partes pequeñas y una pelota pequeña.  
 No recomendado para niños menores de 3 años.

**1**

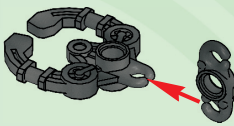

**2**

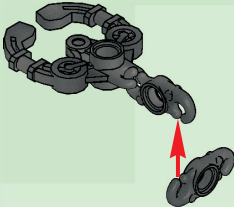

**3**

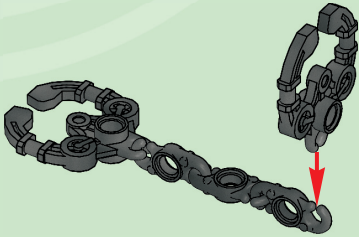

**5**



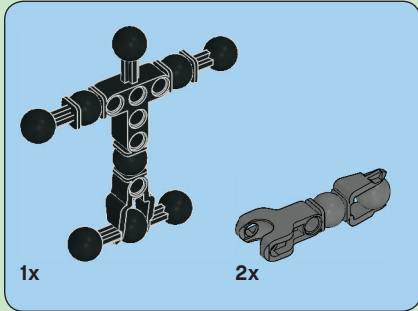

1

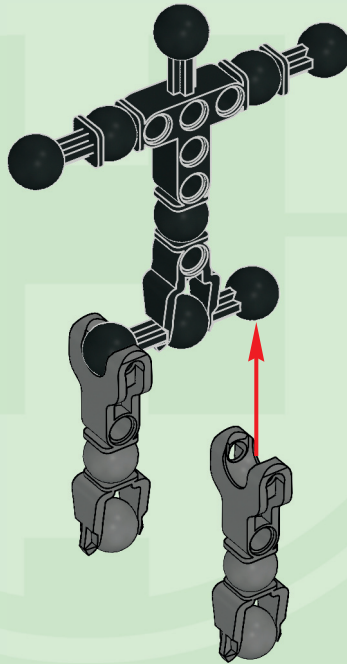

6



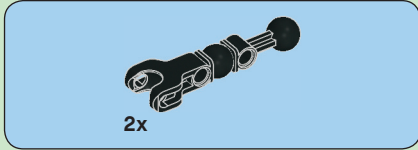

2

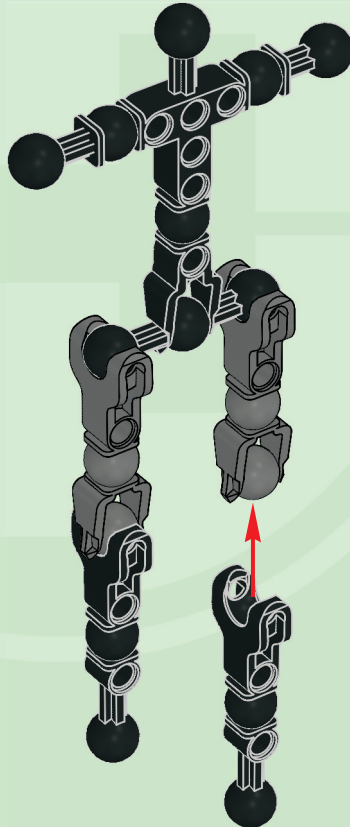

7



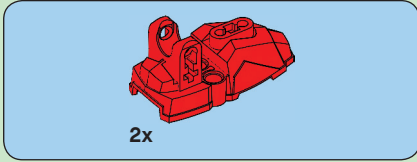

3

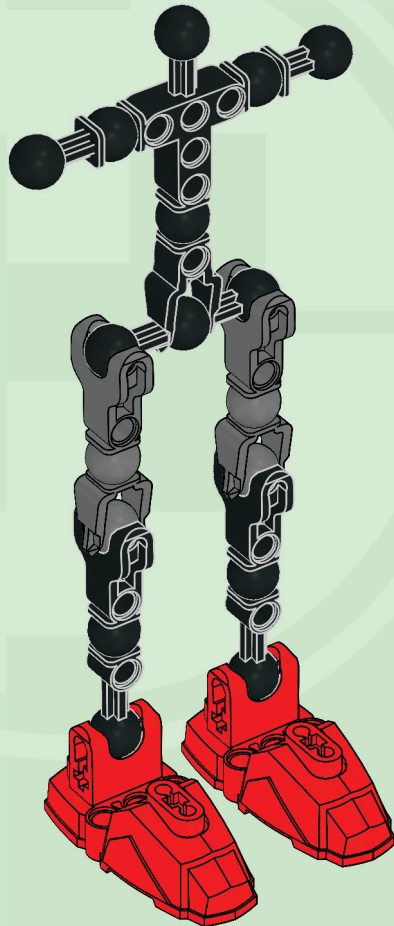

8





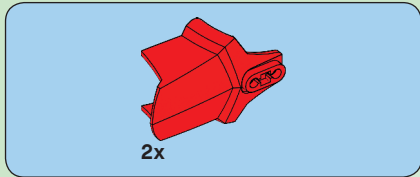

4

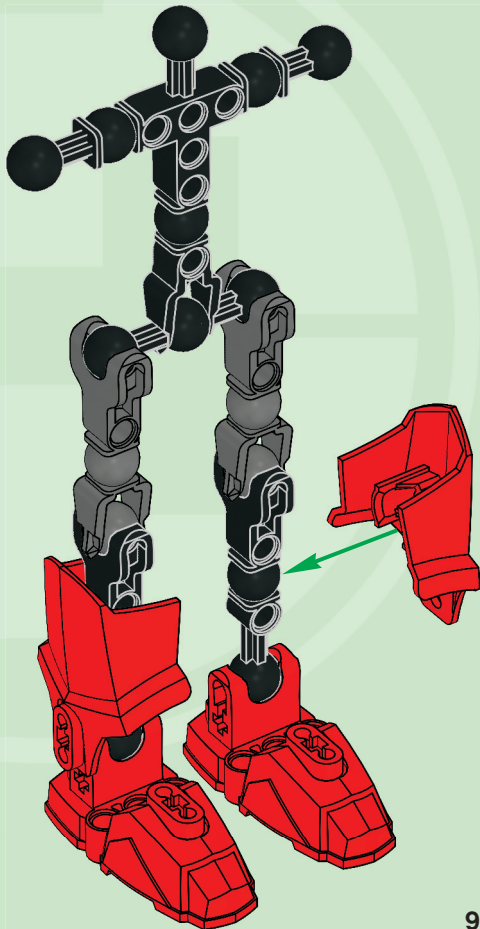

9



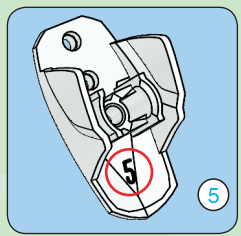
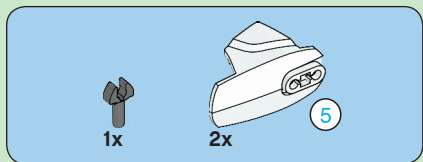

5

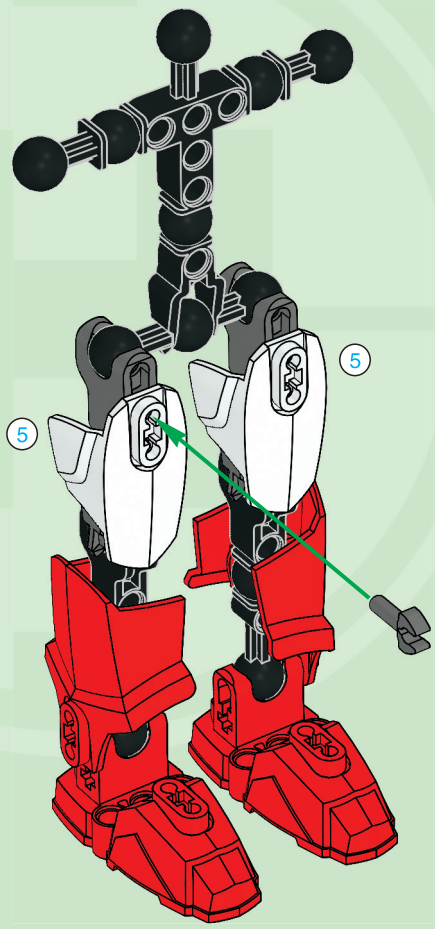

10



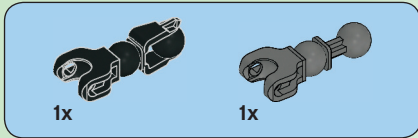
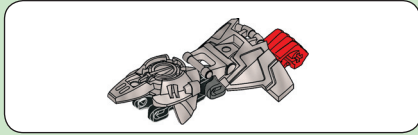

1

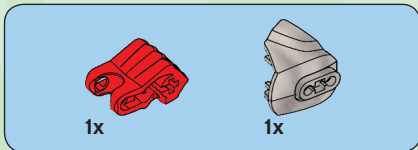
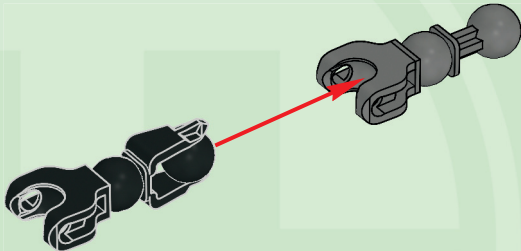

2

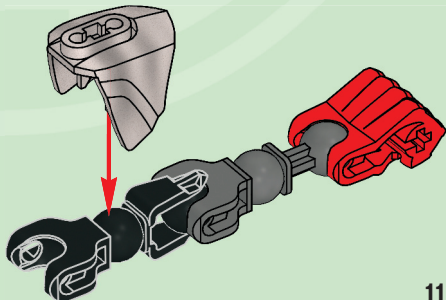

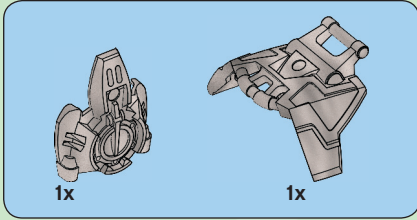

**3**

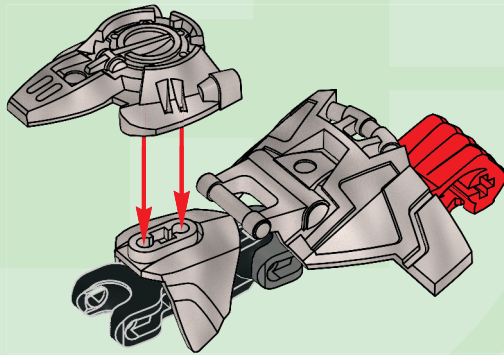

**12**





6

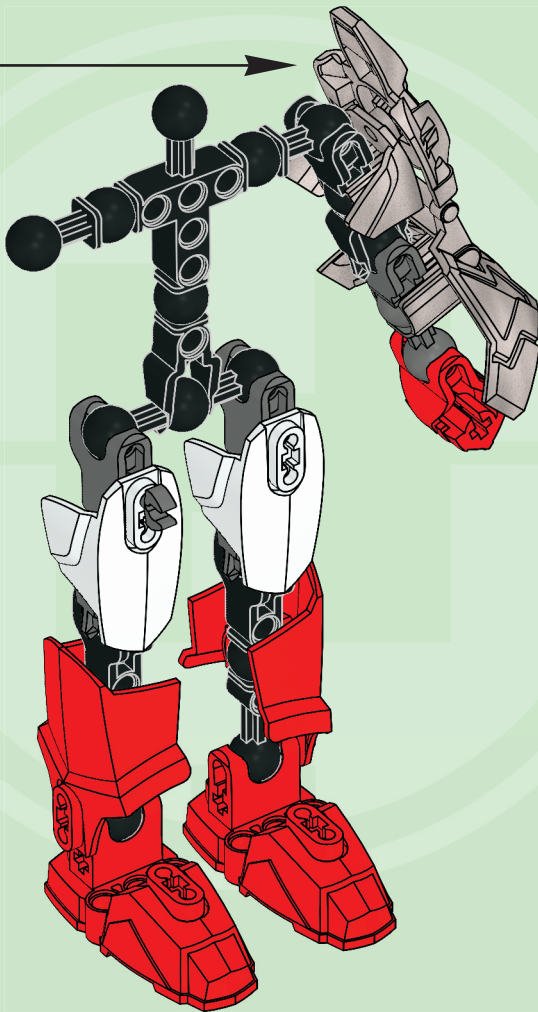

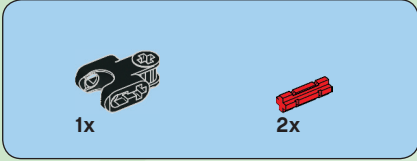
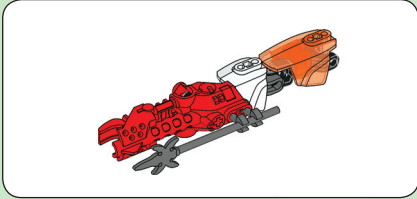

1

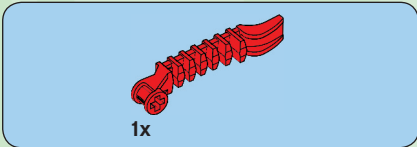
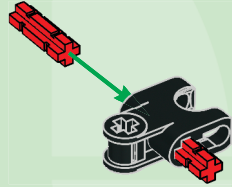

2

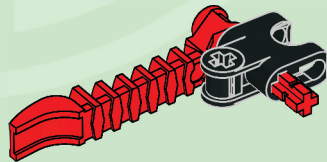

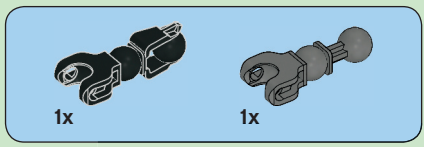

**3**

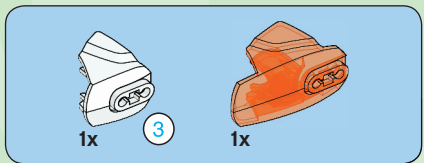
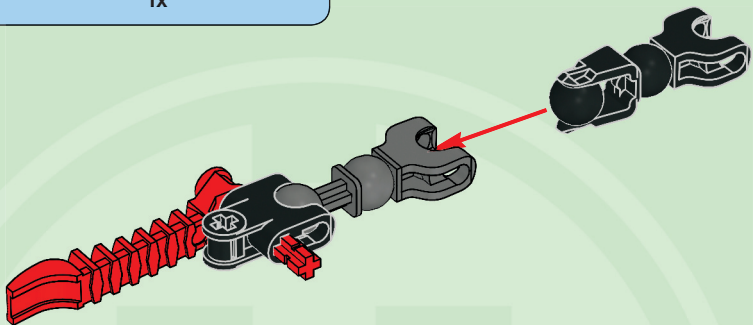

**4**

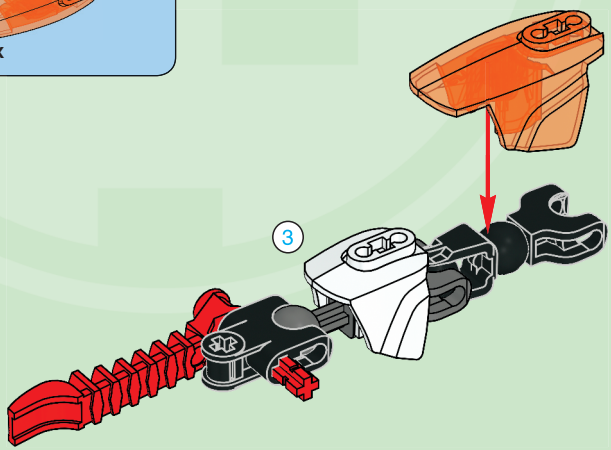
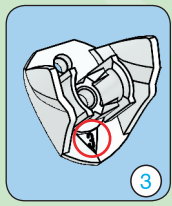

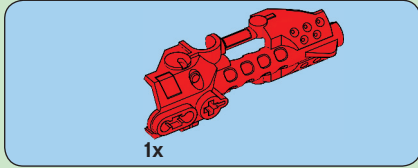

5

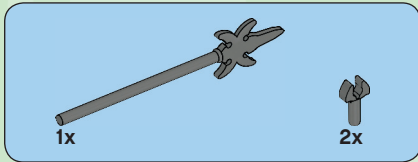
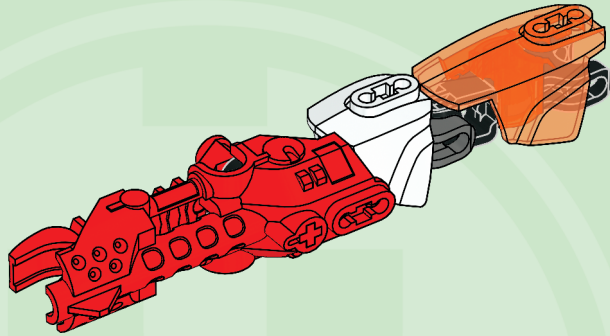

6

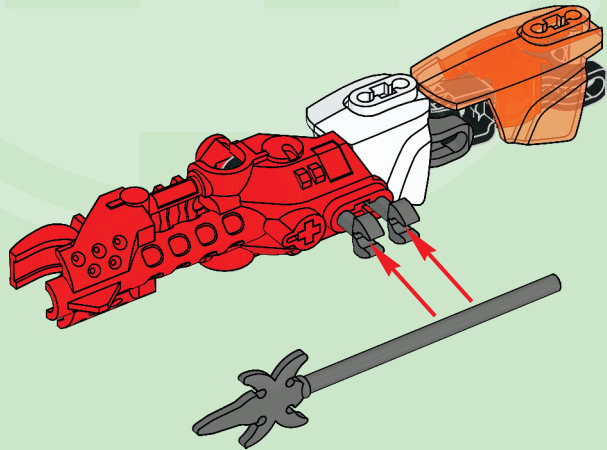

16







7

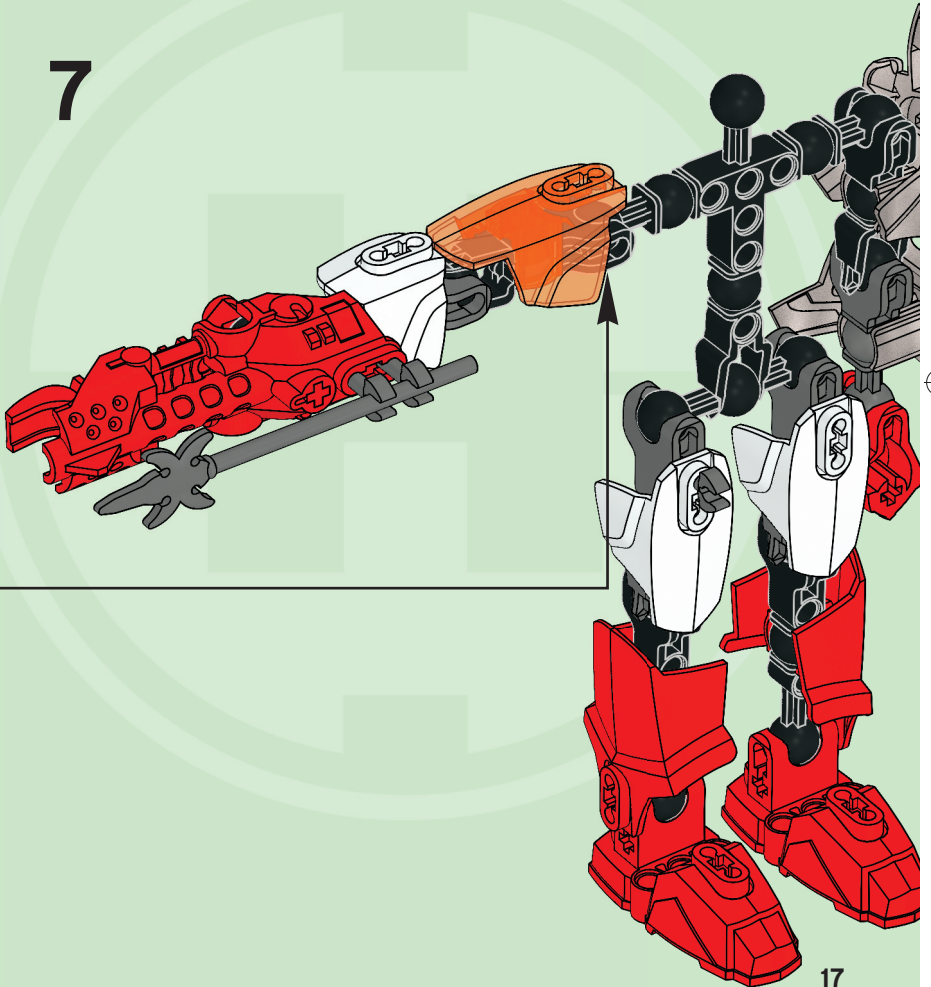

17





8

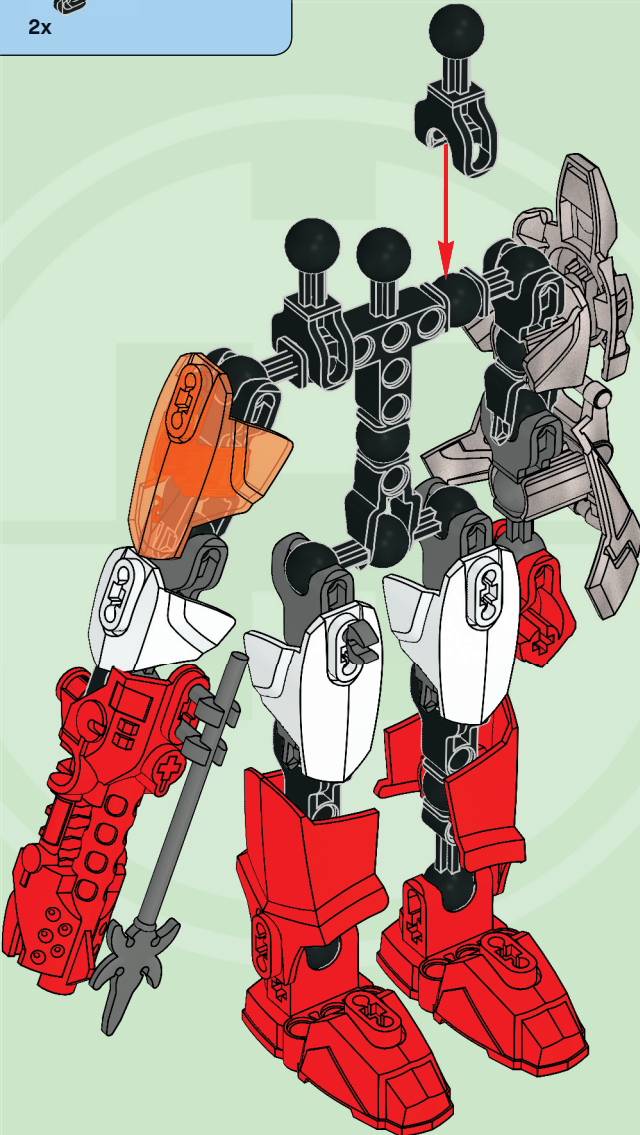

18





9

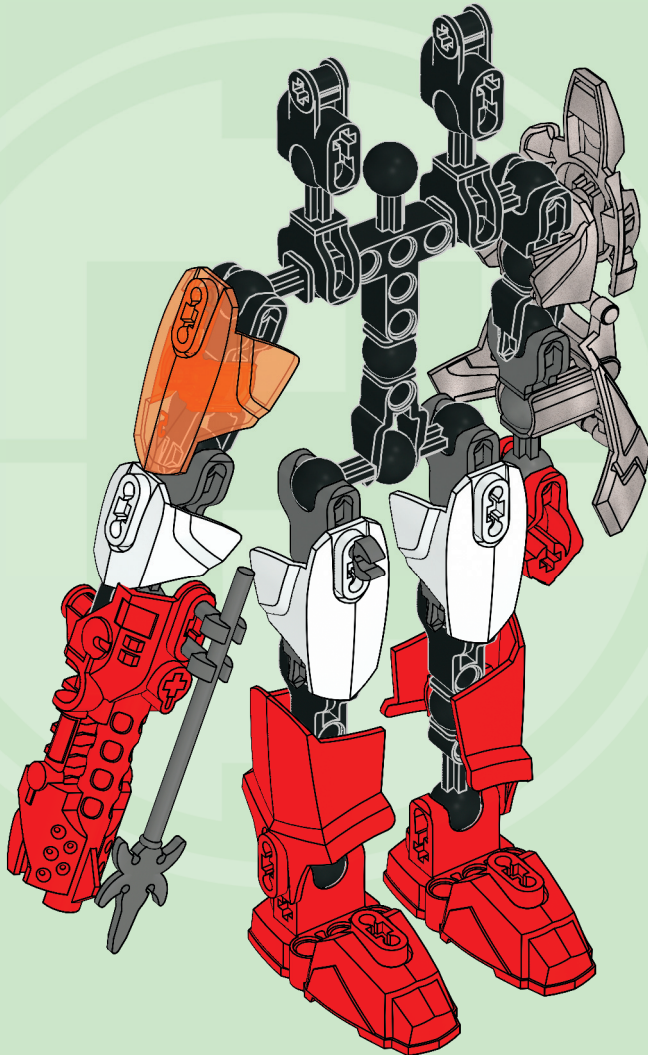

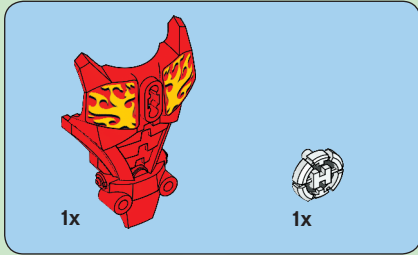

10

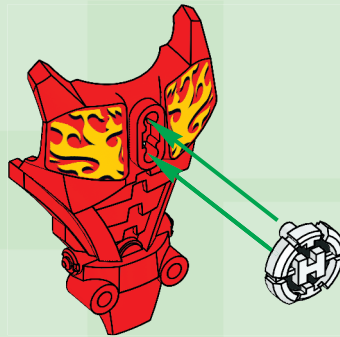

20



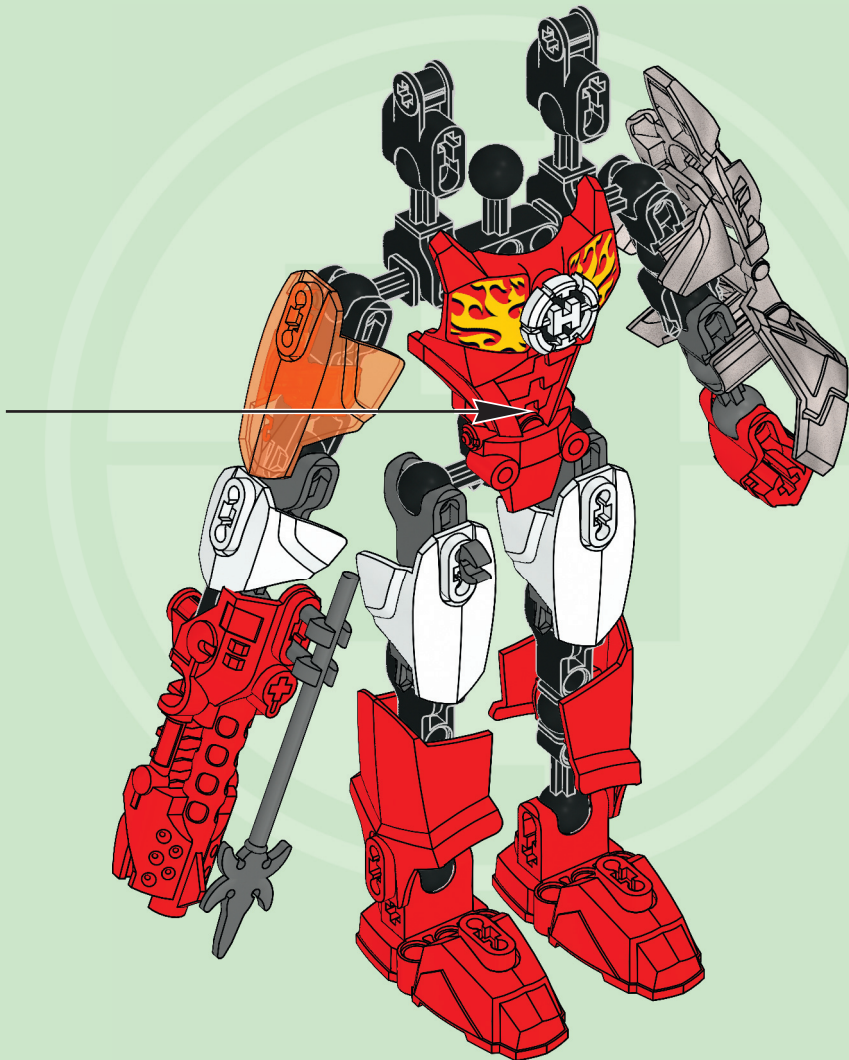

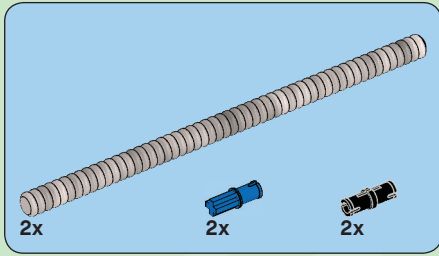

11

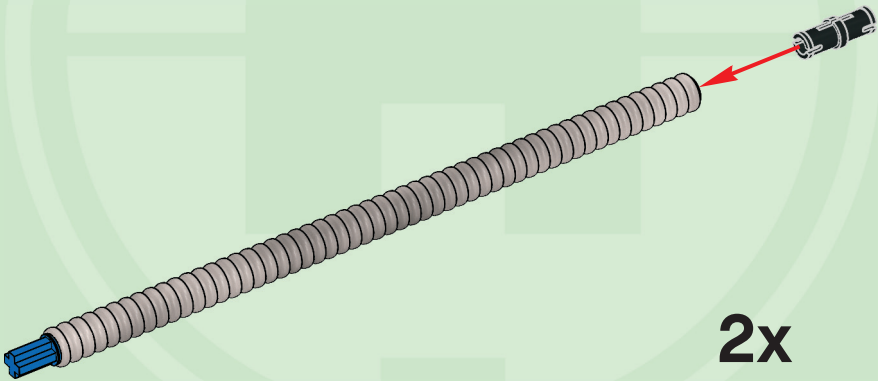

22



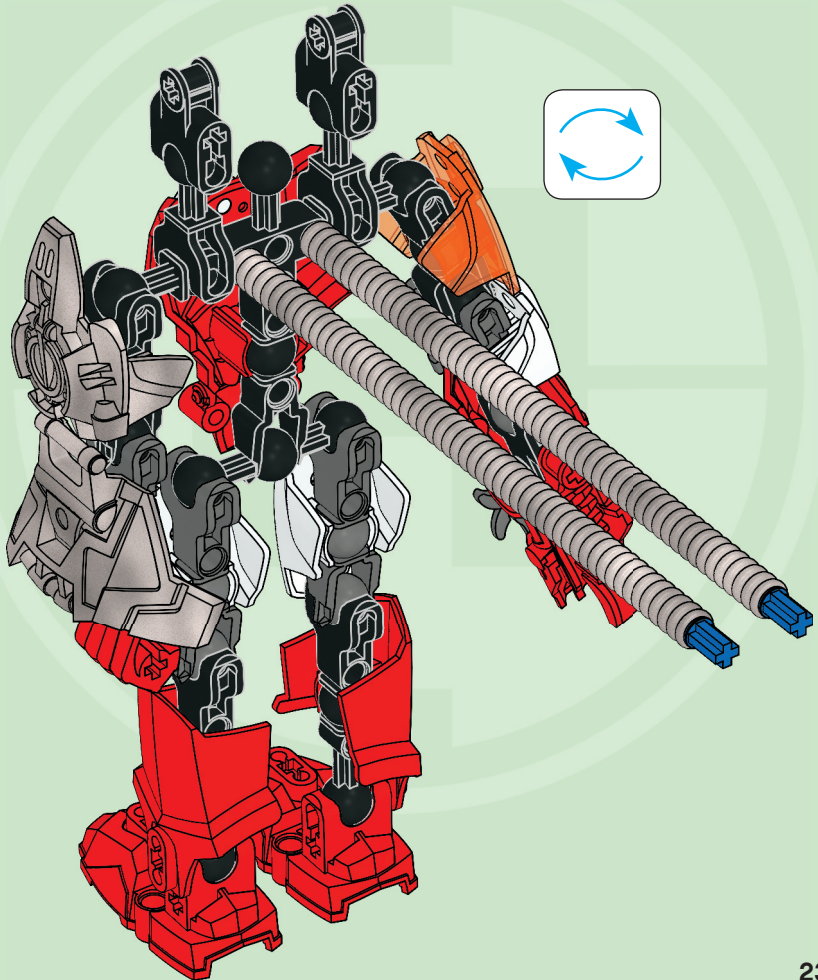





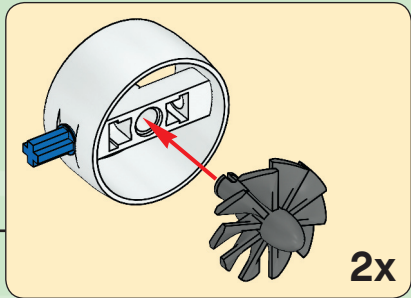
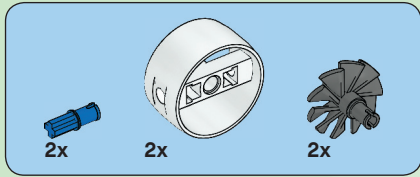

12

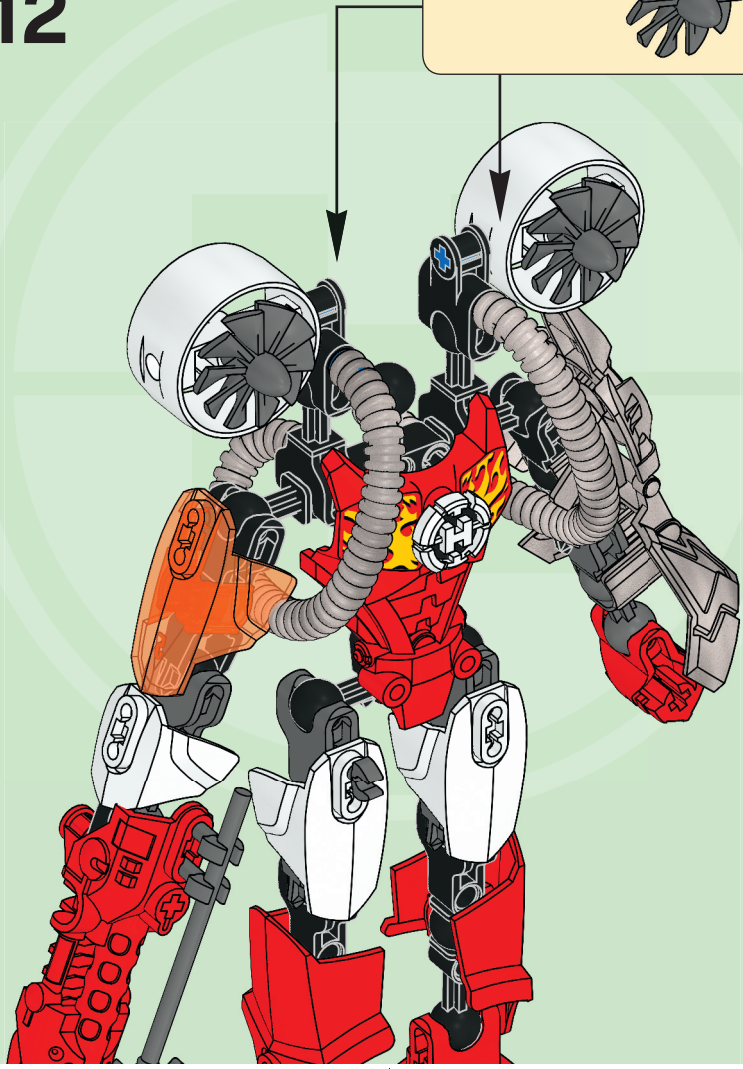

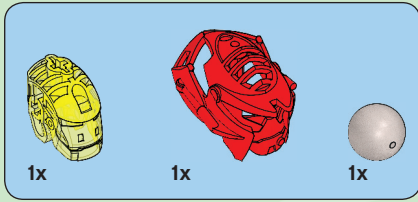

# 13

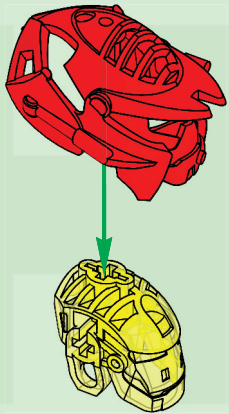

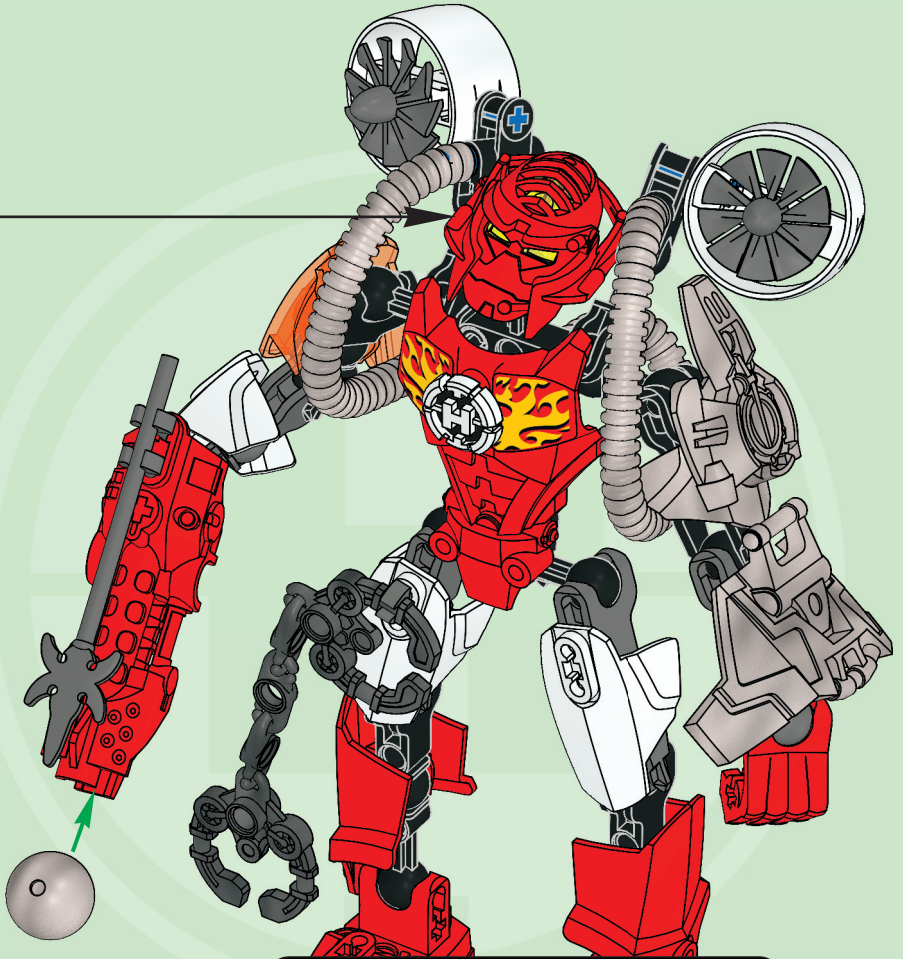



4x  
4206482



1x  
4632640



1x  
4543428

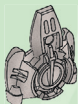

1x  
4614349



1x  
4632610



1x  
4625600



2x  
4620068



3x  
4289542

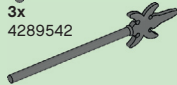

1x  
4210886



2x  
4295253

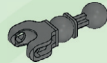

2x  
4618992

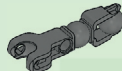

2x  
4655899



1x  
4655097



2x  
4652053



3x  
4654504



2x  
4142865



1x  
4610915

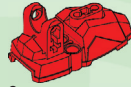

2x  
4632578



1x  
4579005



1x  
4652056

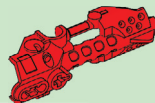

1x  
4652054



1x  
4655826

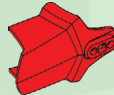

2x  
4611198



2x  
4121715



3x  
4610948



2x  
4609682



2x  
4589952



2x  
4593553



1x  
4593571



2x  
4289534



1x  
6000979



1x  
4632612



2x  
4632643



**Customer Service**

**Kundenservice**

**Service Consommateurs**

**Servicio Al Consumidor**

[www.lego.com/service](http://www.lego.com/service) or dial



00800 5346 5555 :



1-800-422-5346 :





6293

6216





# HERO FACTORY



6216



6293



HEROFACORY.LEGO.COM/BI





# WIN!

Go to [www.LEGOsurvey.com/product](http://www.LEGOsurvey.com/product)  
to fill out a survey for a chance  
to win a cool LEGO® Product.  
No purchase necessary.  
Open to all residents where not prohibited.



[www.LEGO.com](http://www.LEGO.com)



## [www.LEGOsurvey.com/product](http://www.LEGOsurvey.com/product)

### GEWINNE!

Nimm an der Umfrage auf  
[www.LEGOsurvey.com/product](http://www.LEGOsurvey.com/product)  
teil und hab die Chance ein cooles  
LEGO® Produkt zu gewinnen!  
Die Teilnahme am Gewinnspiel führt zu keinerlei  
Kaufverpflichtungen, Teilnahme in allen nicht  
ausgeschlossenen Ländern möglich.

### WIN!

Ga naar [www.LEGOsurvey.com/product](http://www.LEGOsurvey.com/product),  
vul een enquêteformulier  
in en maak kans op een  
cool LEGO® product.  
Geen aankoopverplichting.  
Iedereen mag deelnemen, uitgezonderd  
ingezetenden van landen waar een  
enquêteverbod geldt.

### GAGNE!

Visite [www.LEGOsurvey.com/product](http://www.LEGOsurvey.com/product)  
pour répondre à un  
questionnaire et avoir une  
chance de gagner un produit  
LEGO® très cool!  
Aucune obligation d'achat.  
Ouvert à tous les résidents des pays  
autorisés.

### 当てよう!

[www.LEGOsurvey.com/product](http://www.LEGOsurvey.com/product)  
にアクセスして、  
アンケートにご記入ください。  
当選者にはレゴ®製品を  
差し上げます。  
お買い上げの必要はありません。  
禁止されていない限り、すべての皆様にご利用いただけます。

6005912

LEGO and the LEGO logo are trademarks of the/sonnt des marques de commerce de/  
son marcas registradas de LEGO Group. ©2012 The LEGO Group.