

1

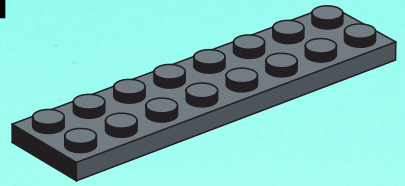

2

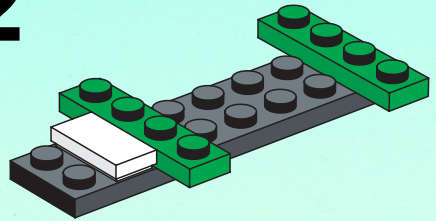

3

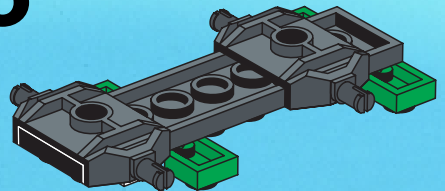

4

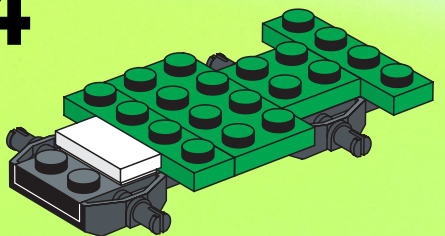

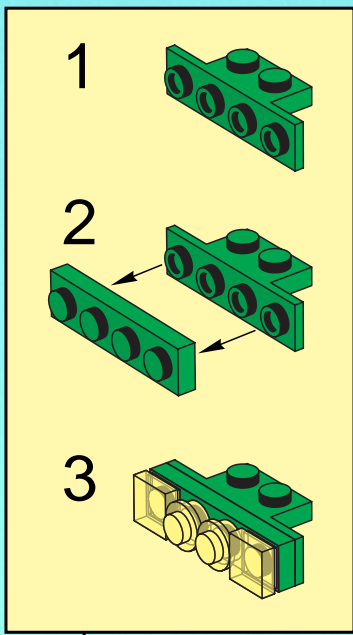

5

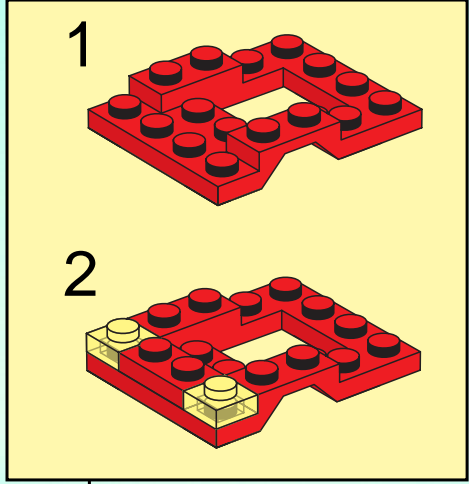
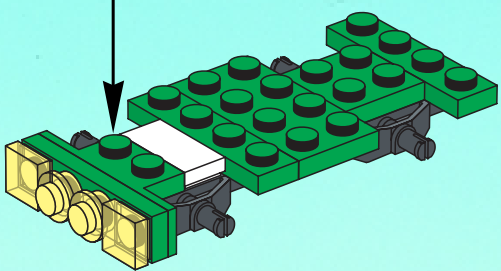

6

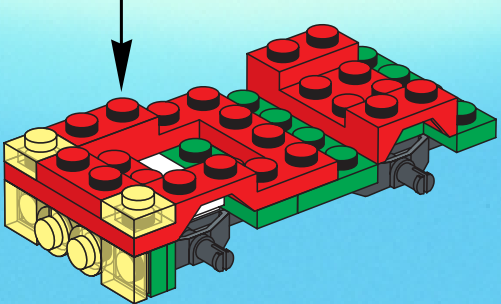

7

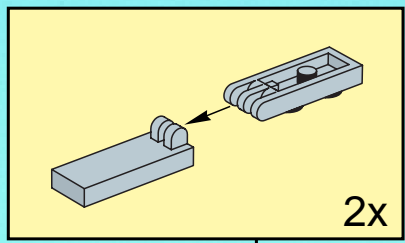
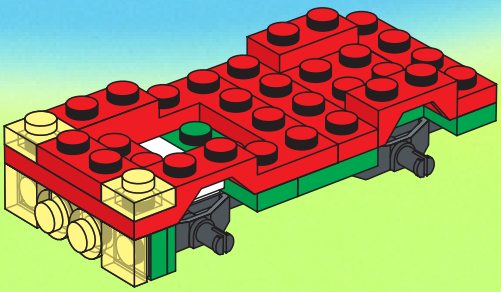

2x

8

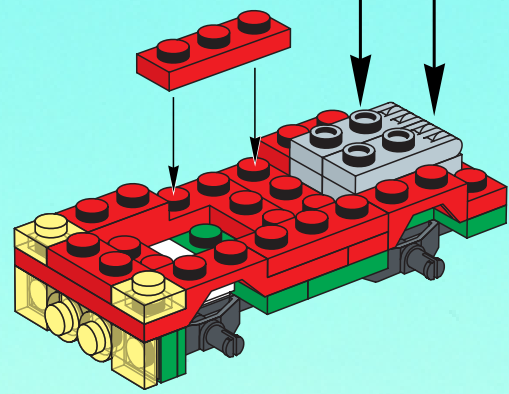

9

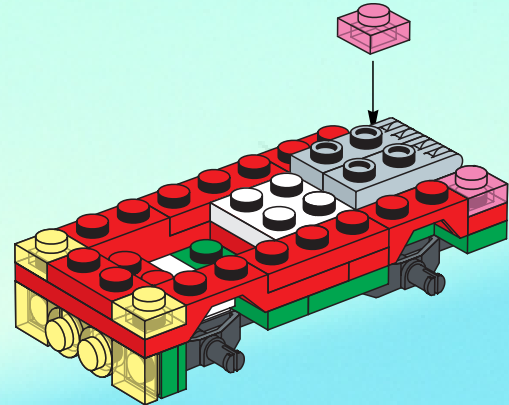

10

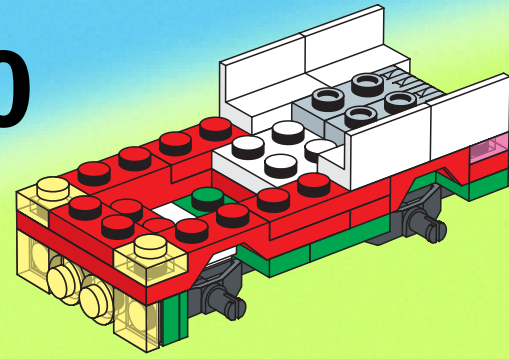

11

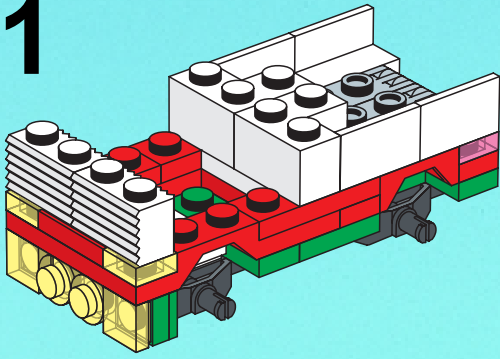

12

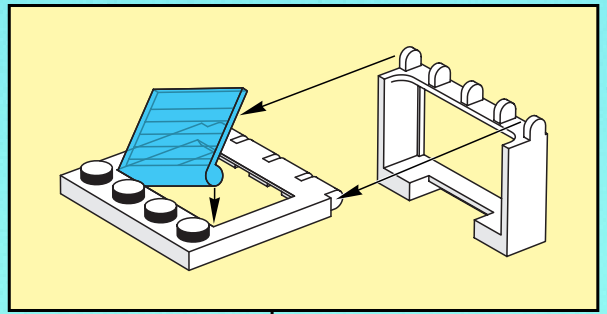
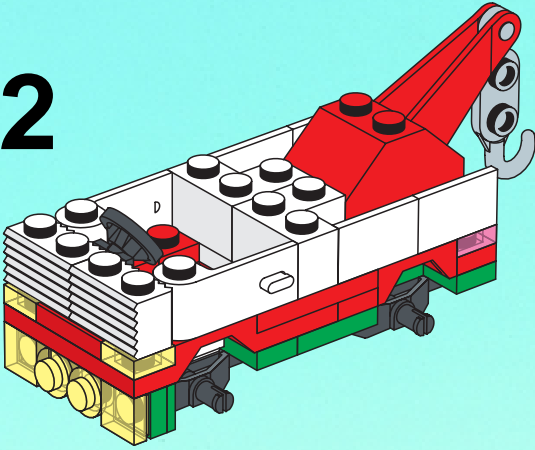

14

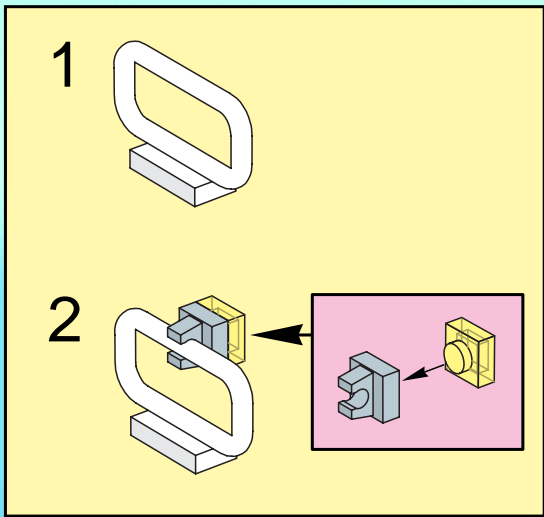
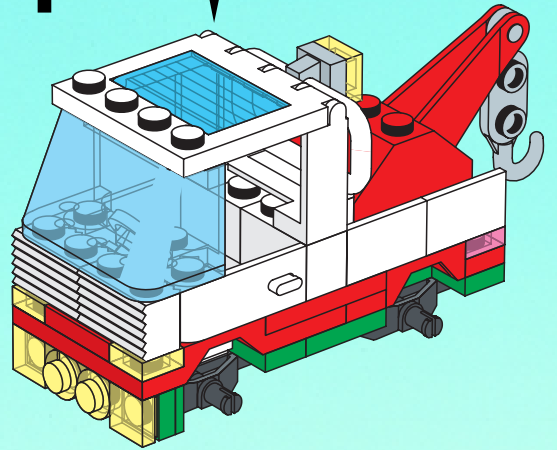

13

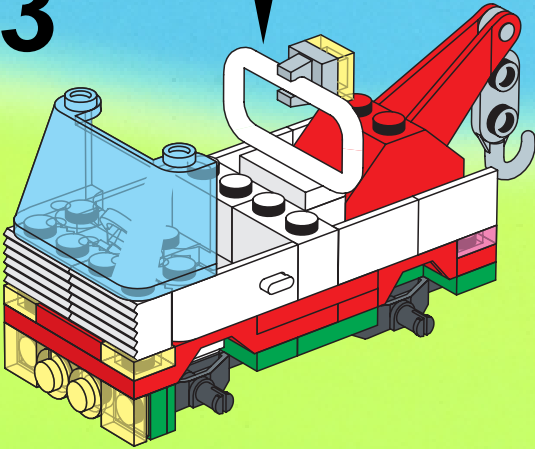

15

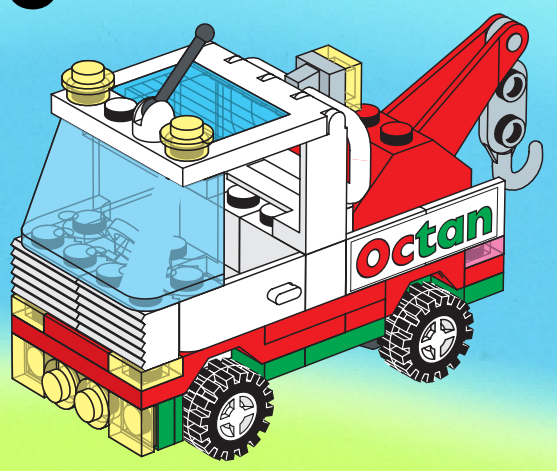

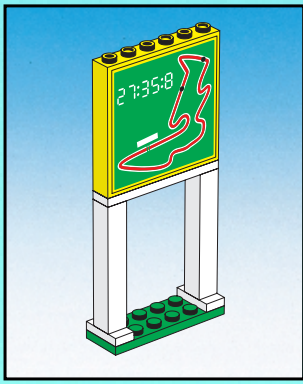

1

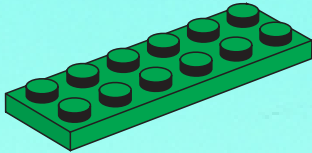

2

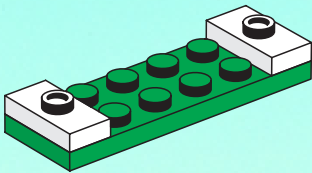

3

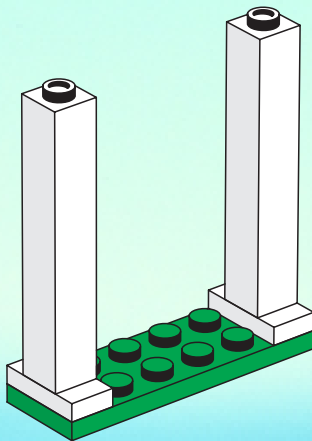

4

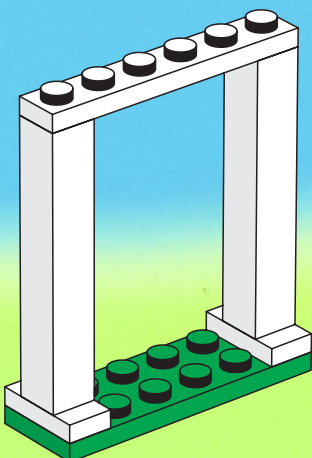

5

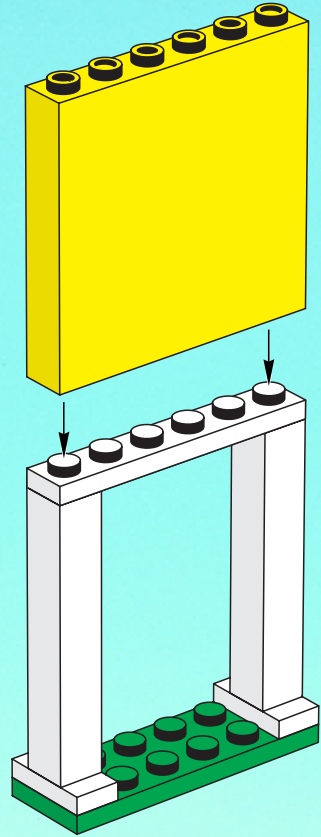

6

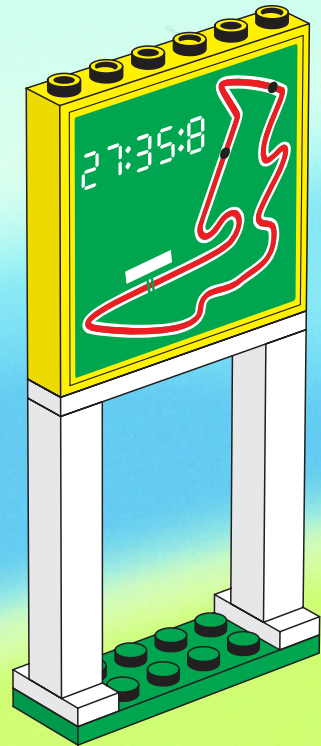

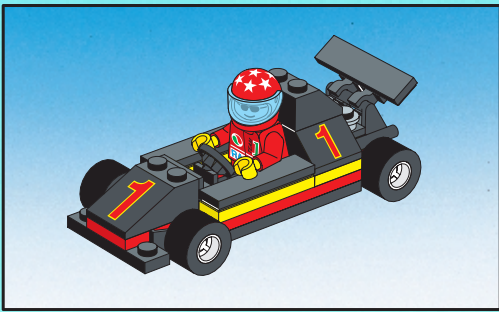

1

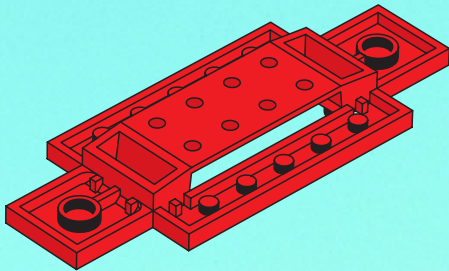

2

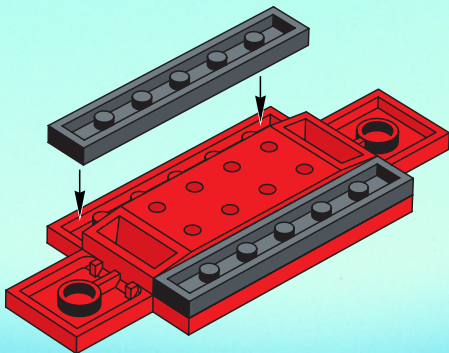

3

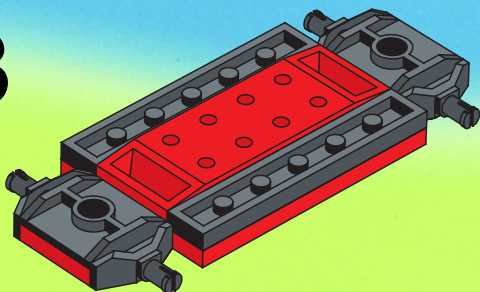

4

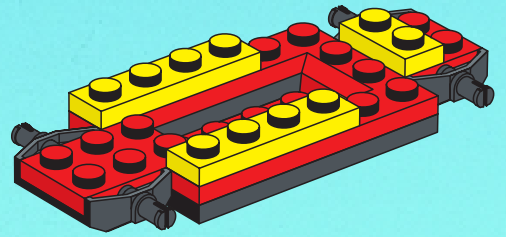

5

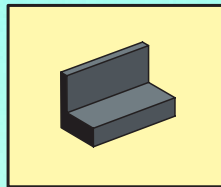
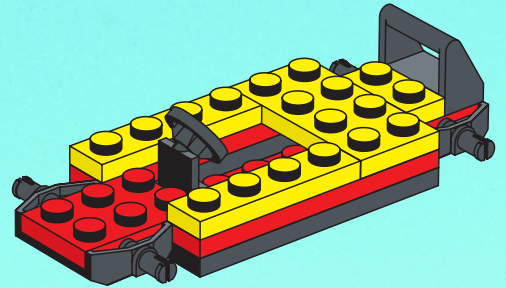

6

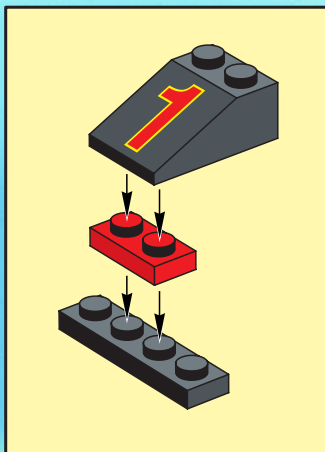
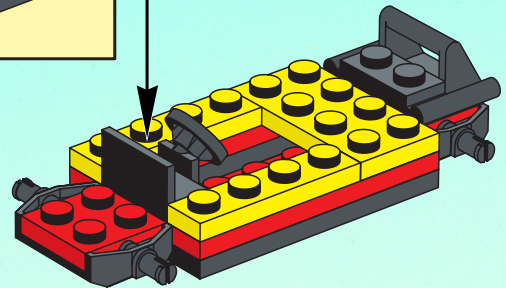

7

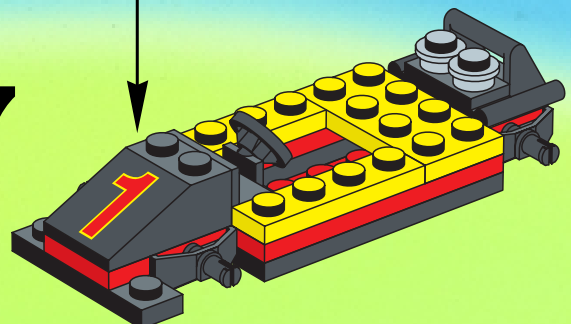

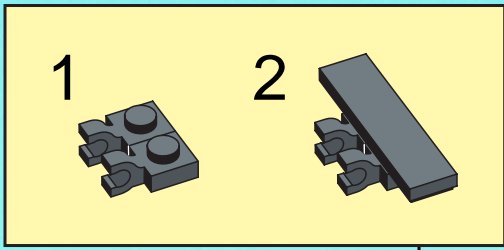

8

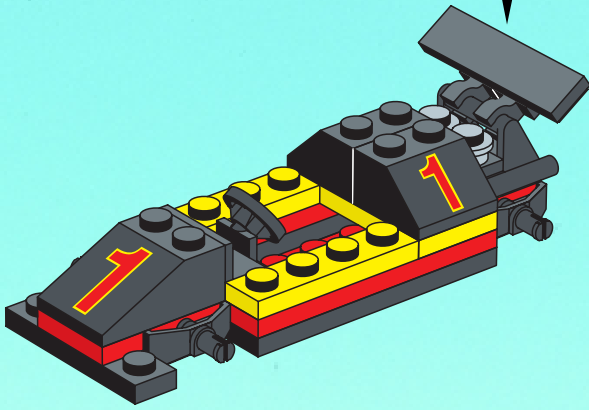

9

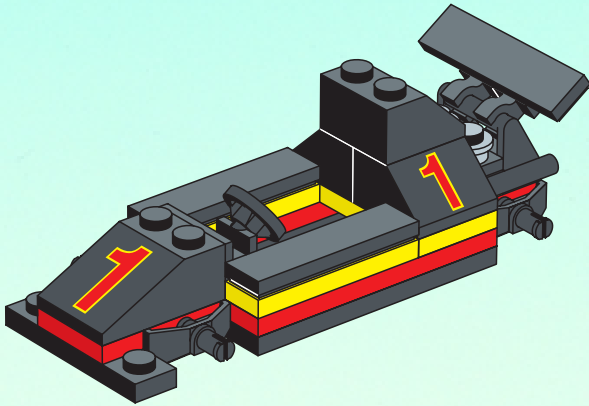

10

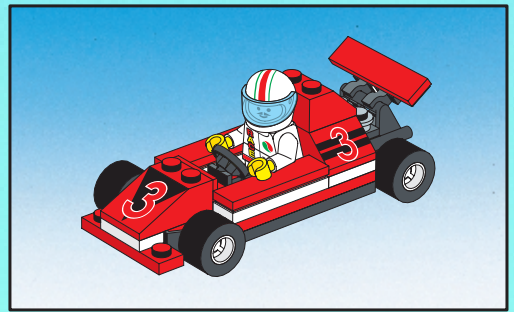
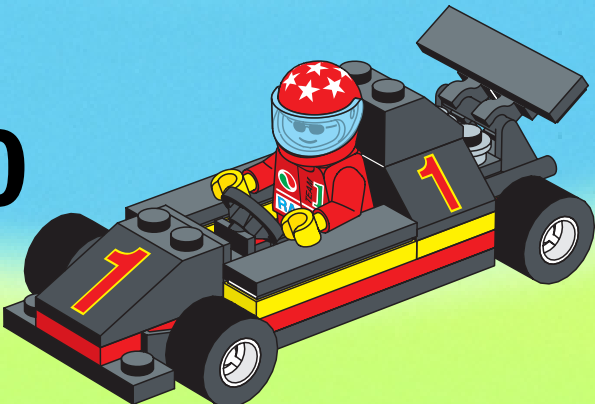

1

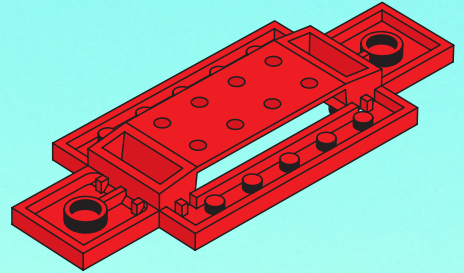

2

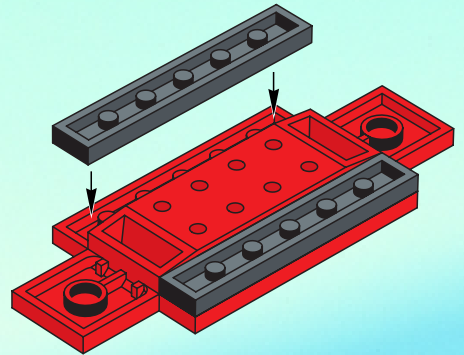

3

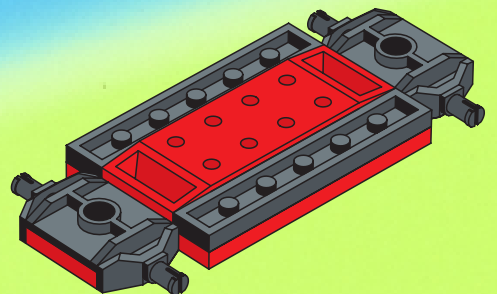

4

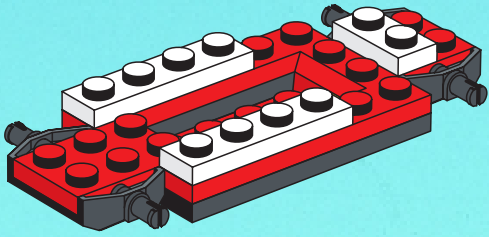

5

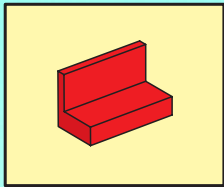
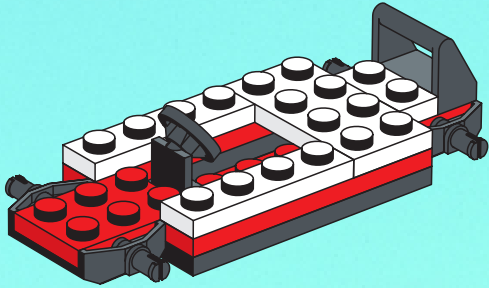

6

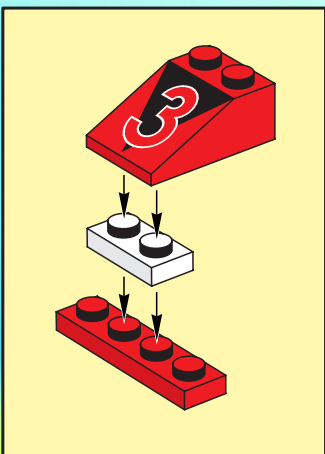
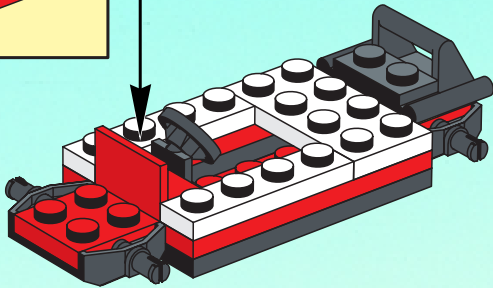

7

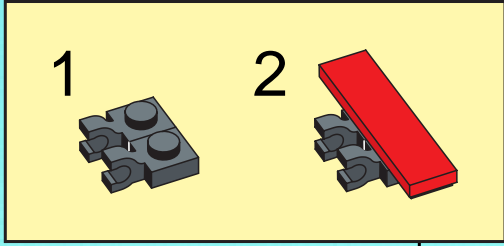
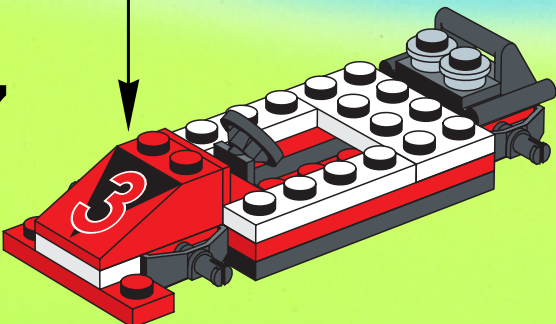

8

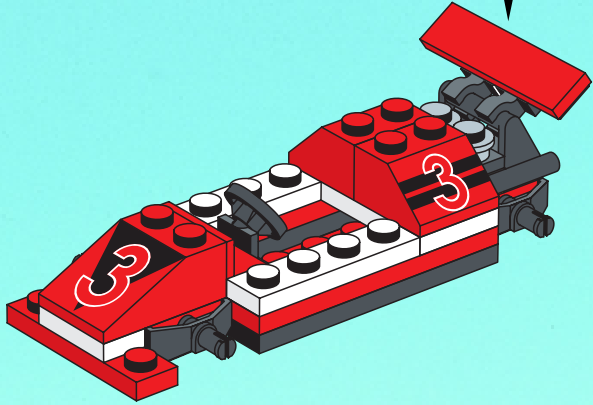

9

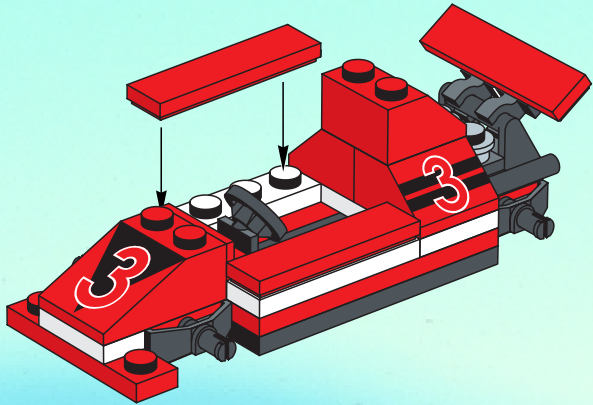

10

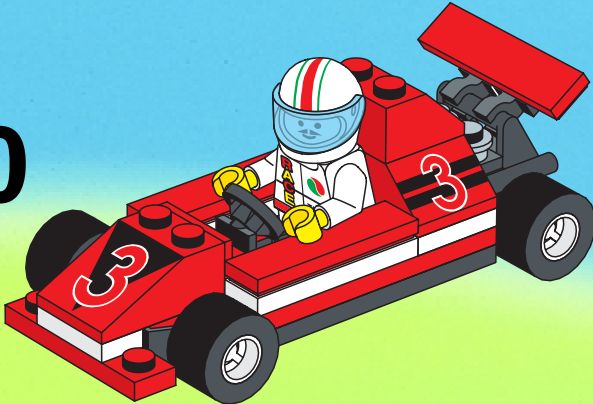

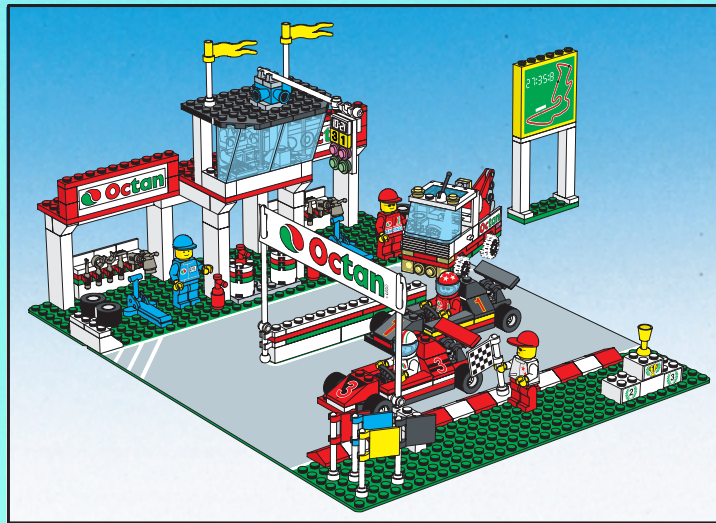

<p>1</p>	<p>3</p>	<p>5</p>
<p>2</p>	<p>4</p>	<p>2x</p>

1

2

3

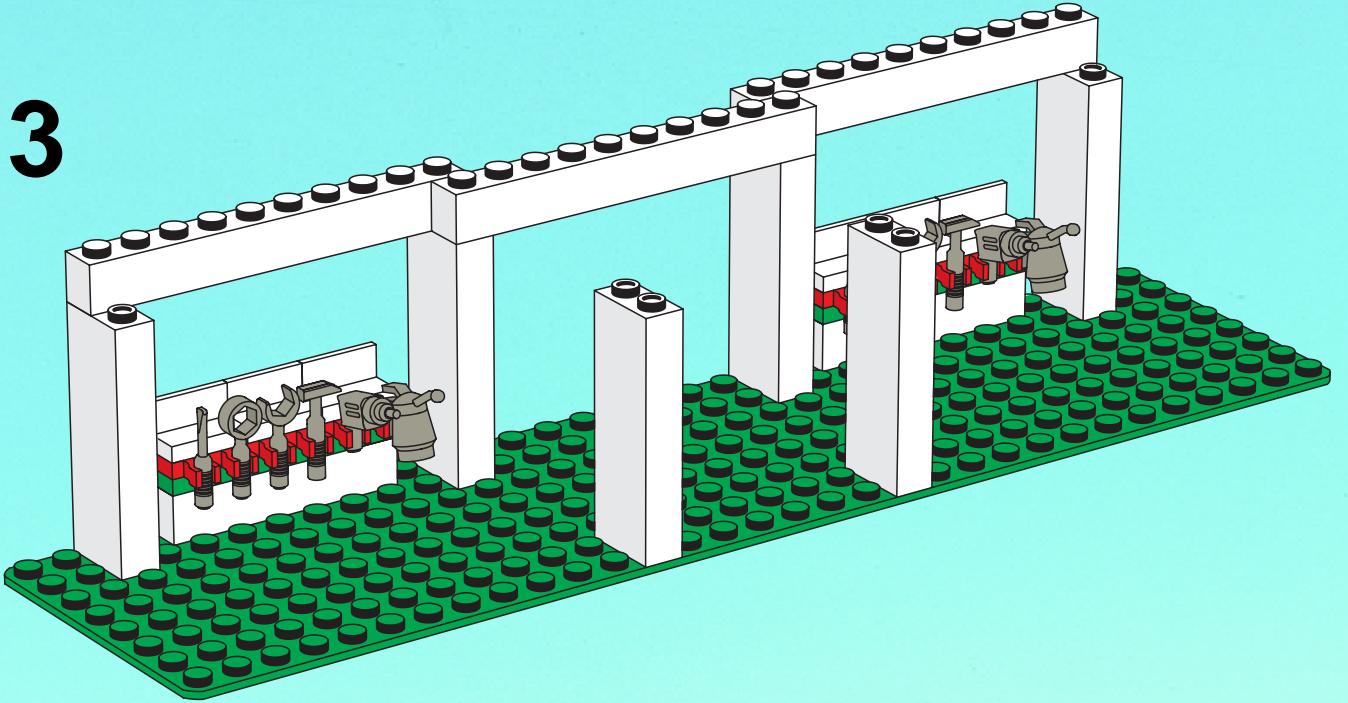

4

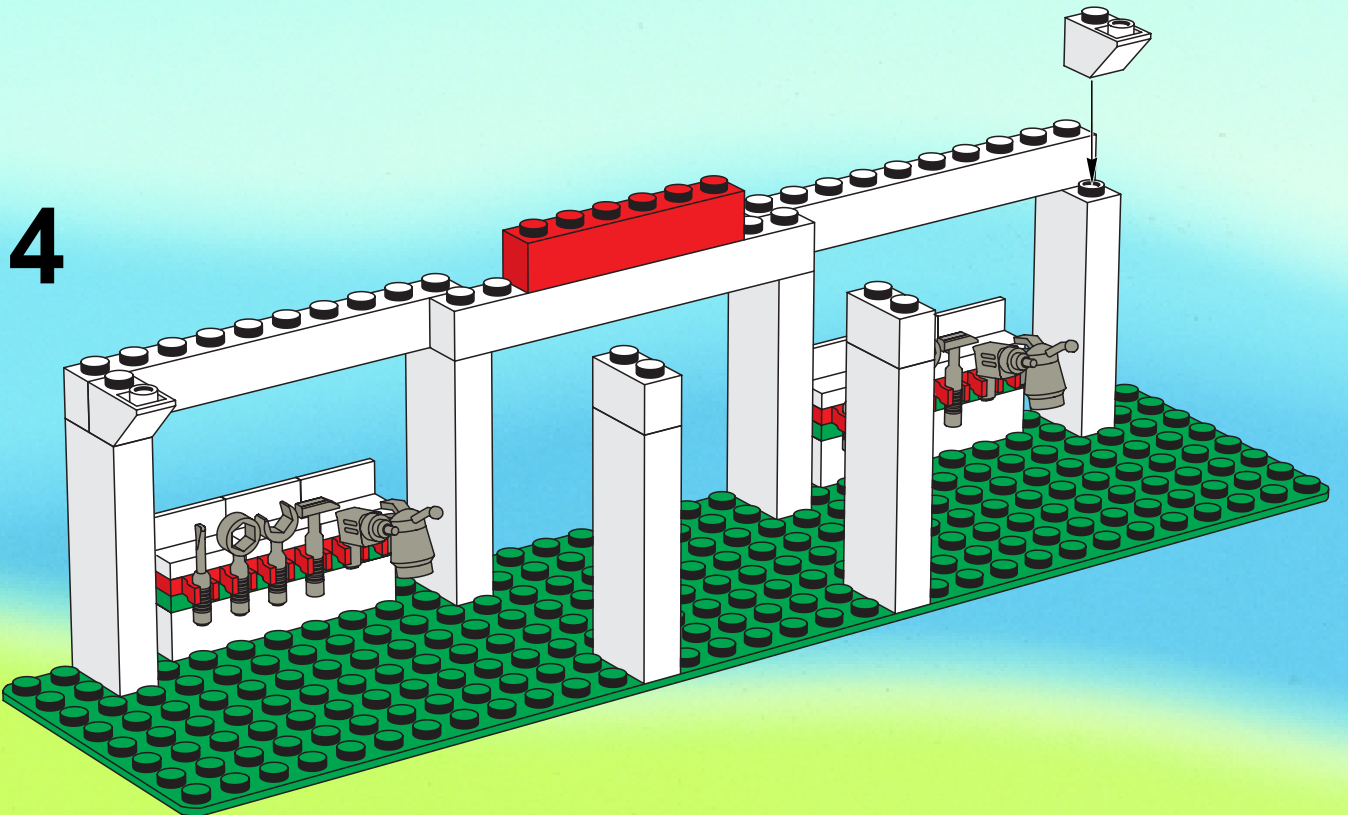

5

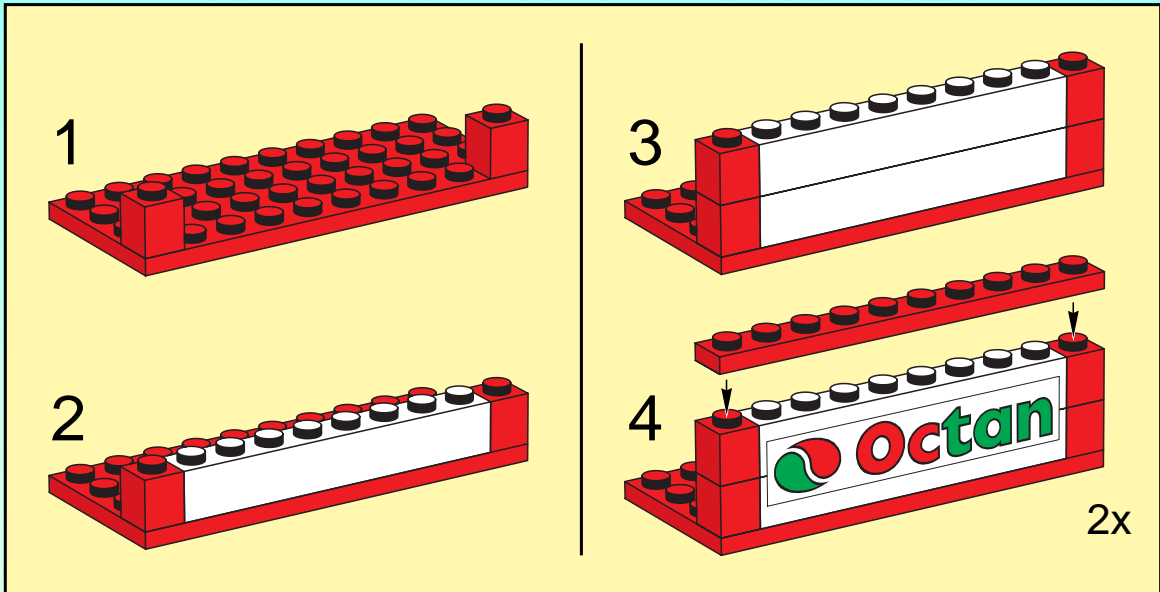
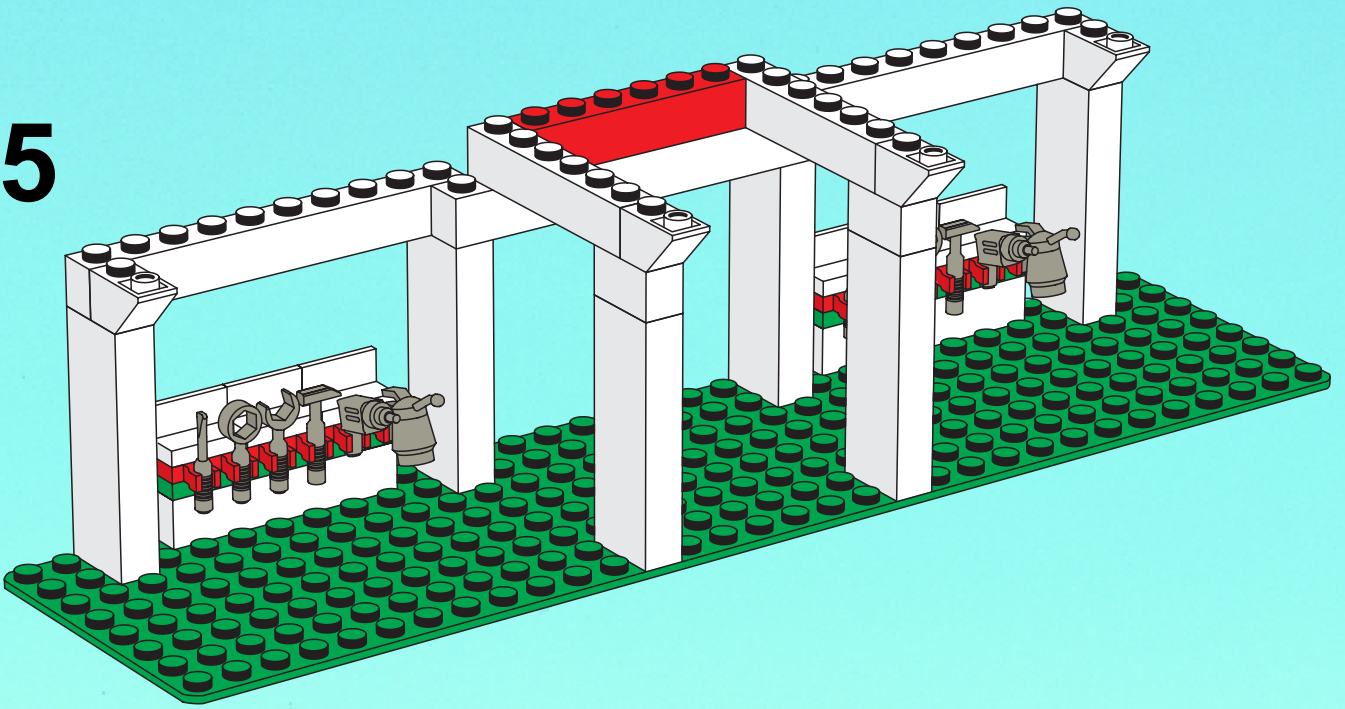

6

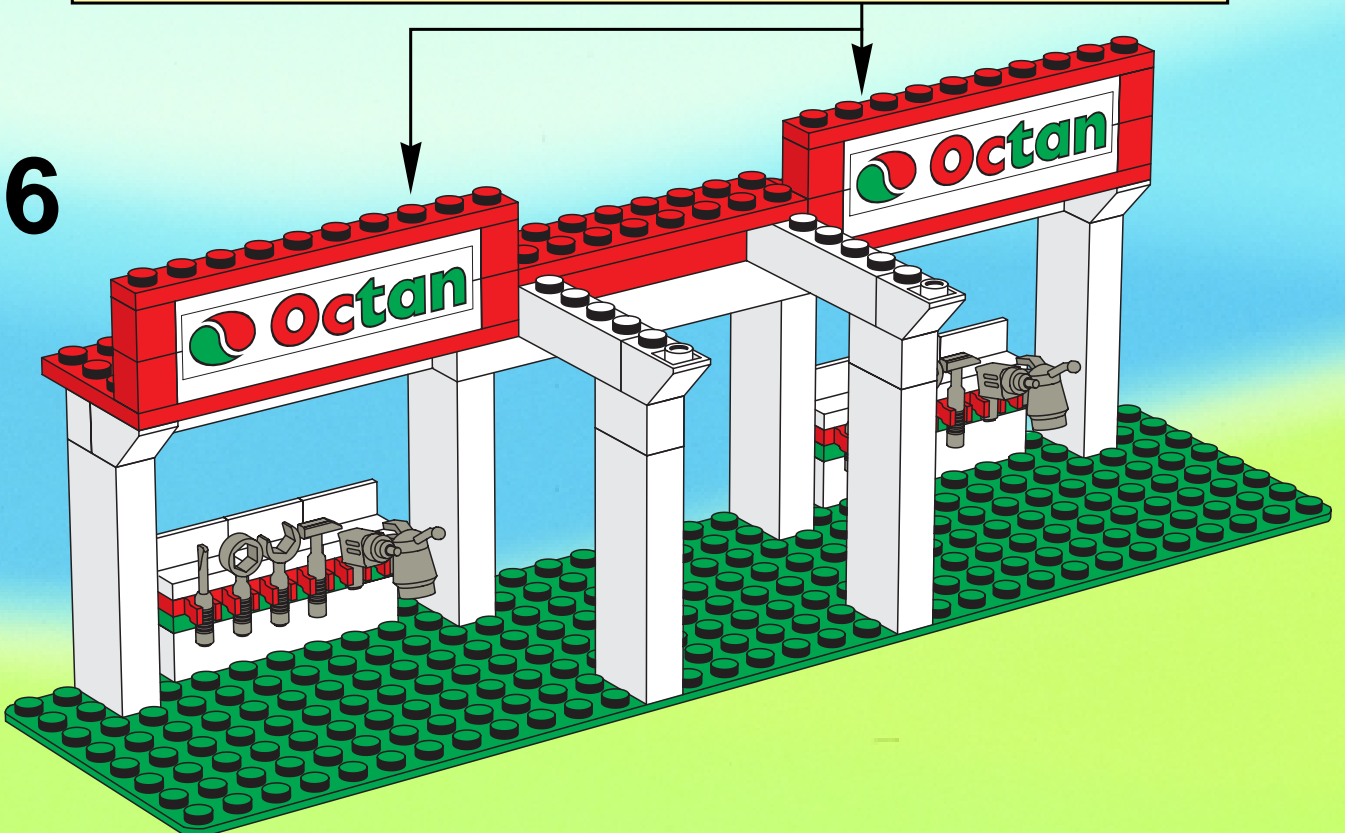

1

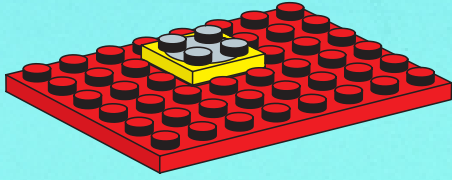

2

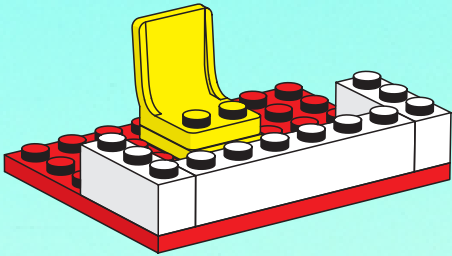

3

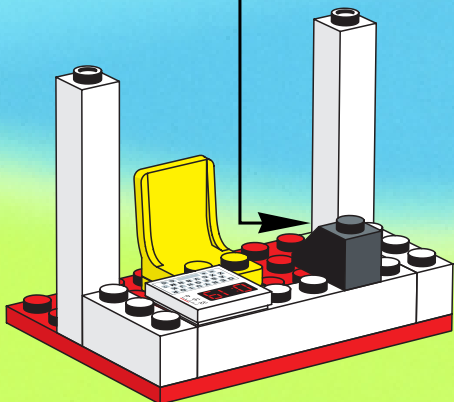
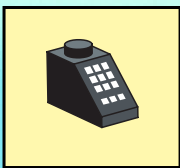

4

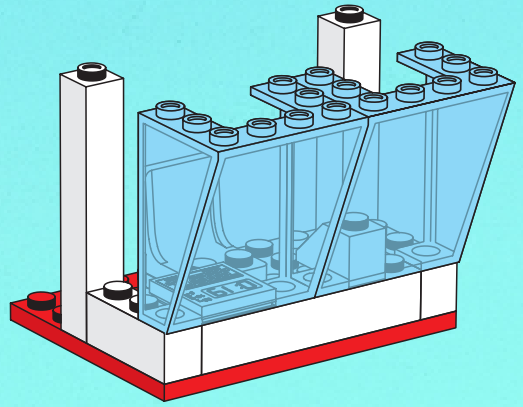

5

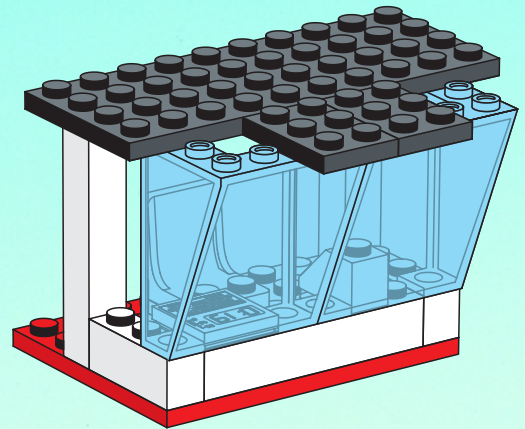

6

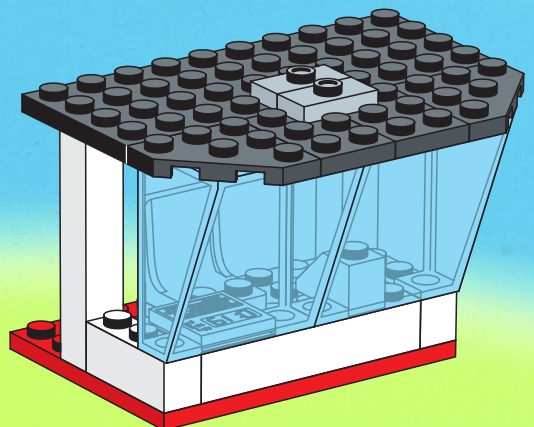

7

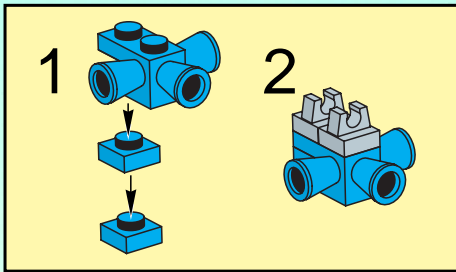
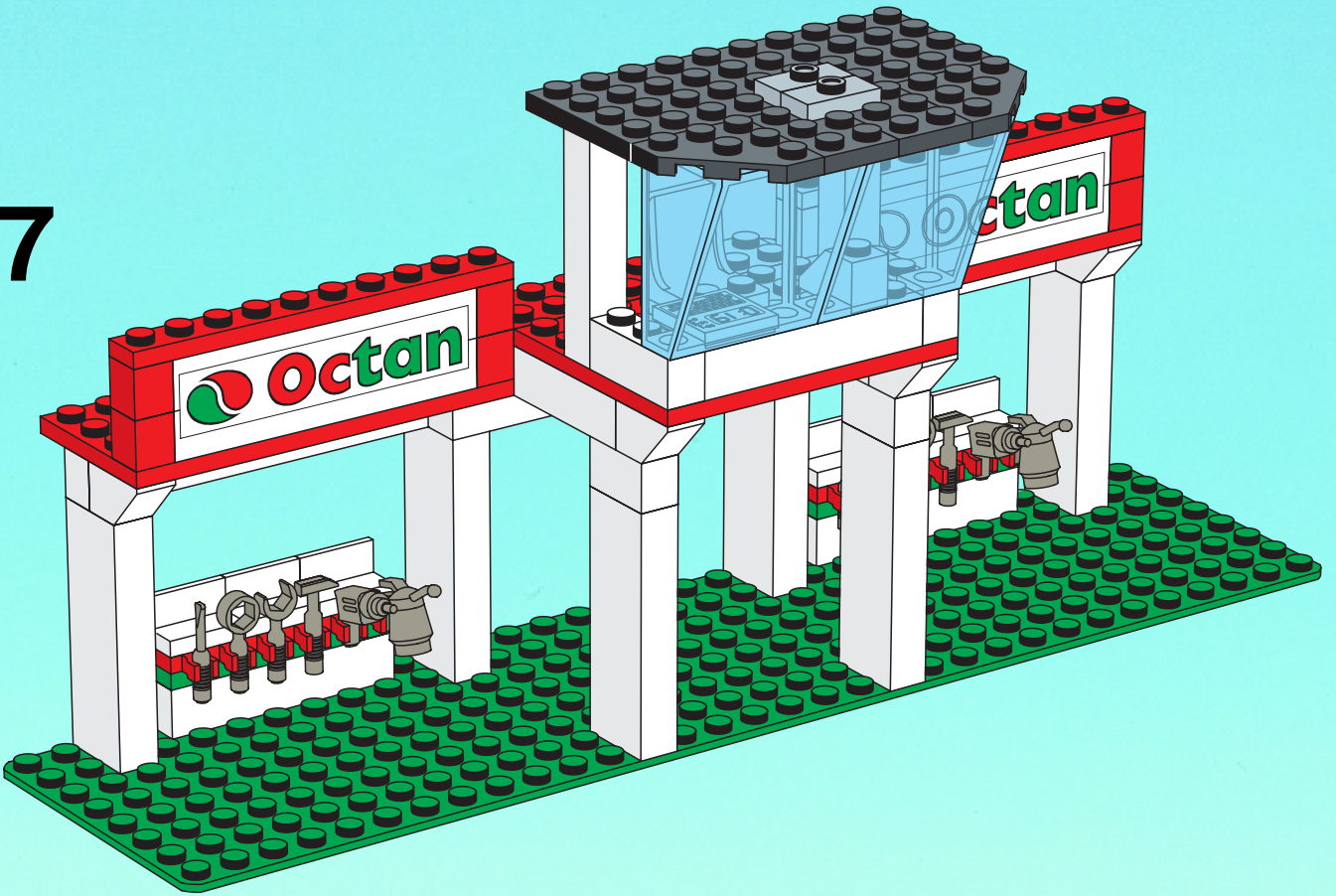

8

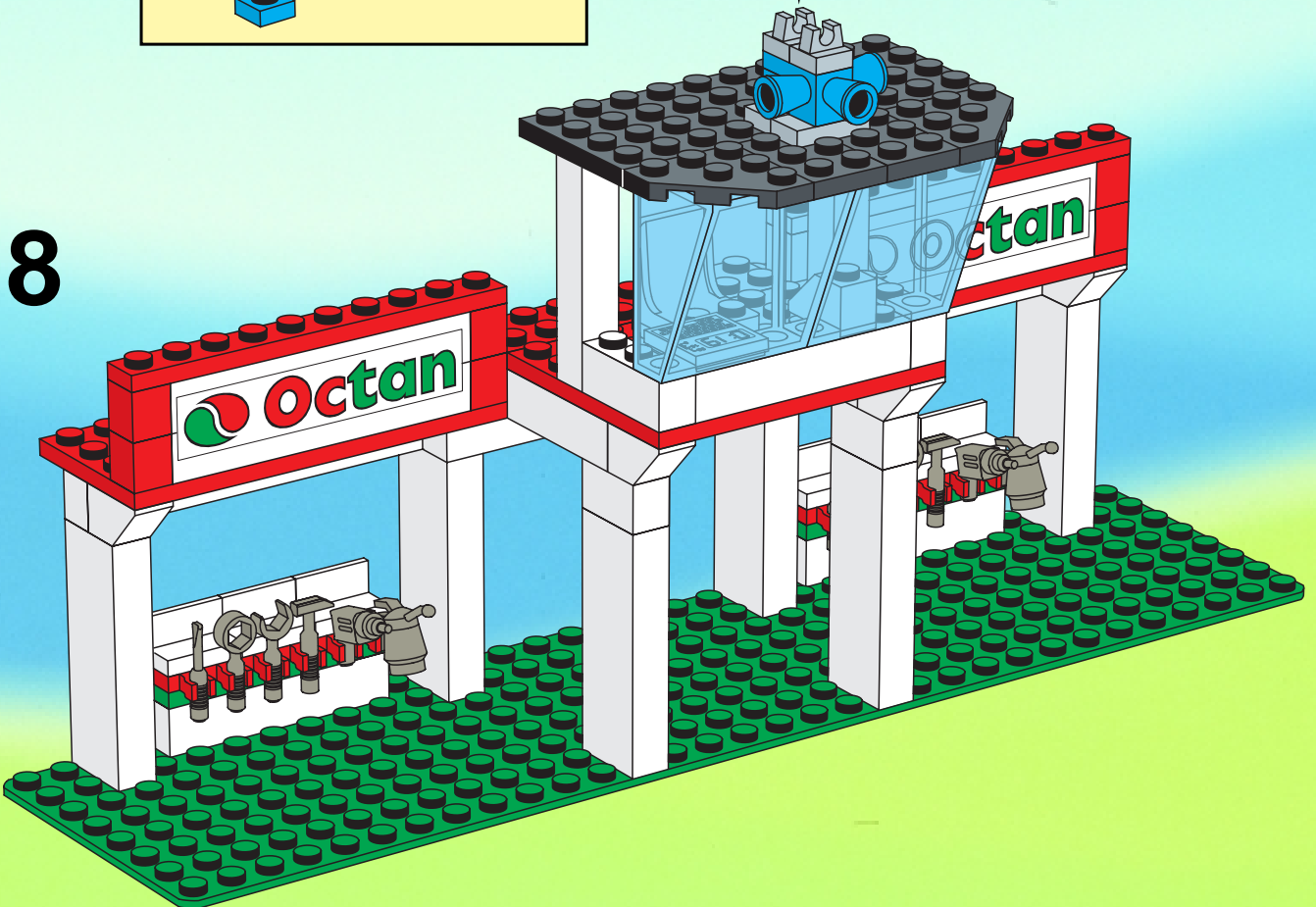

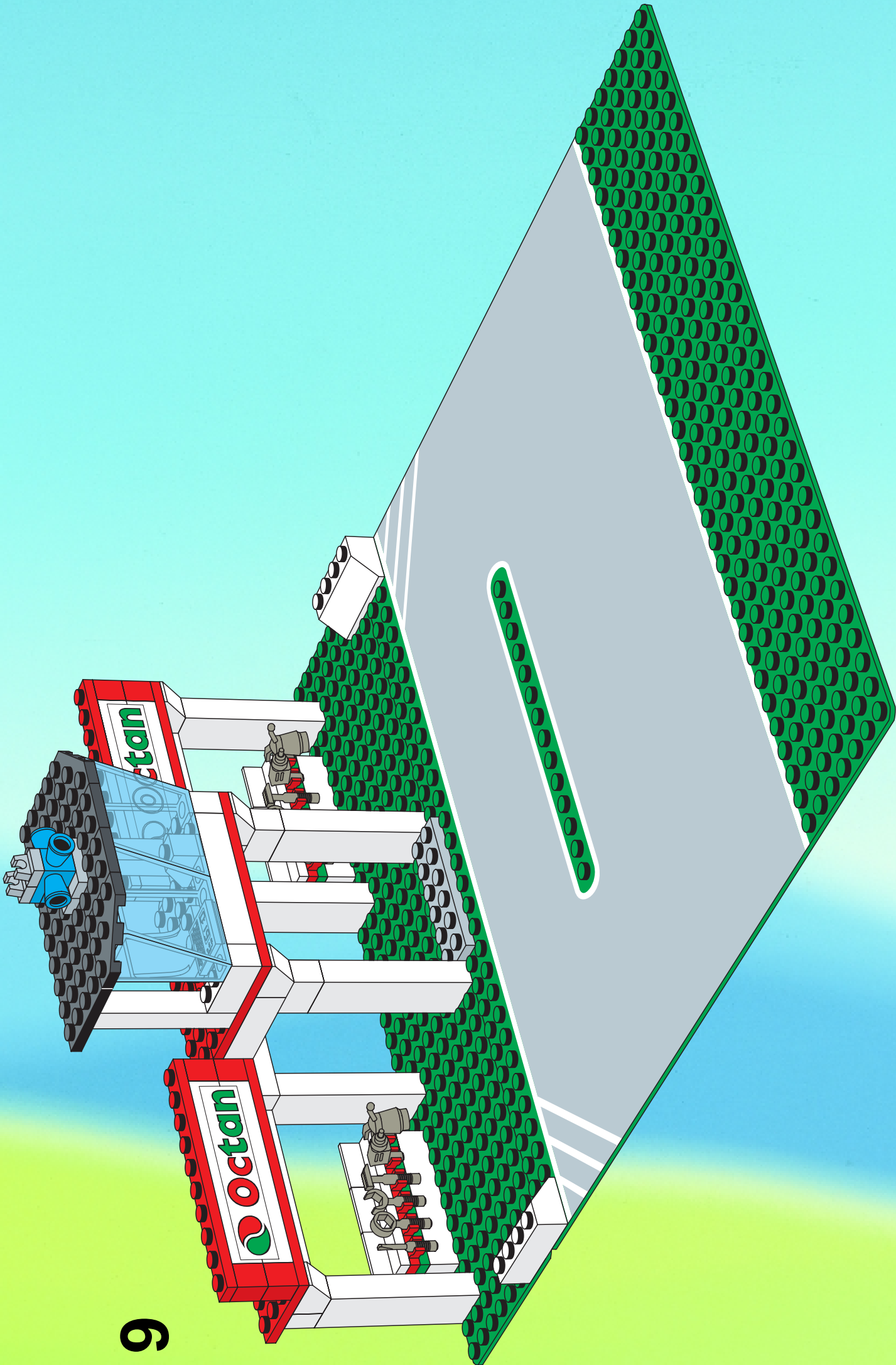

9

10

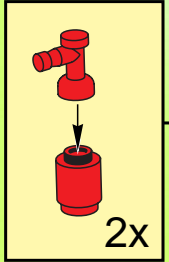
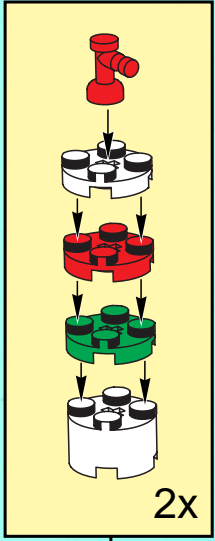
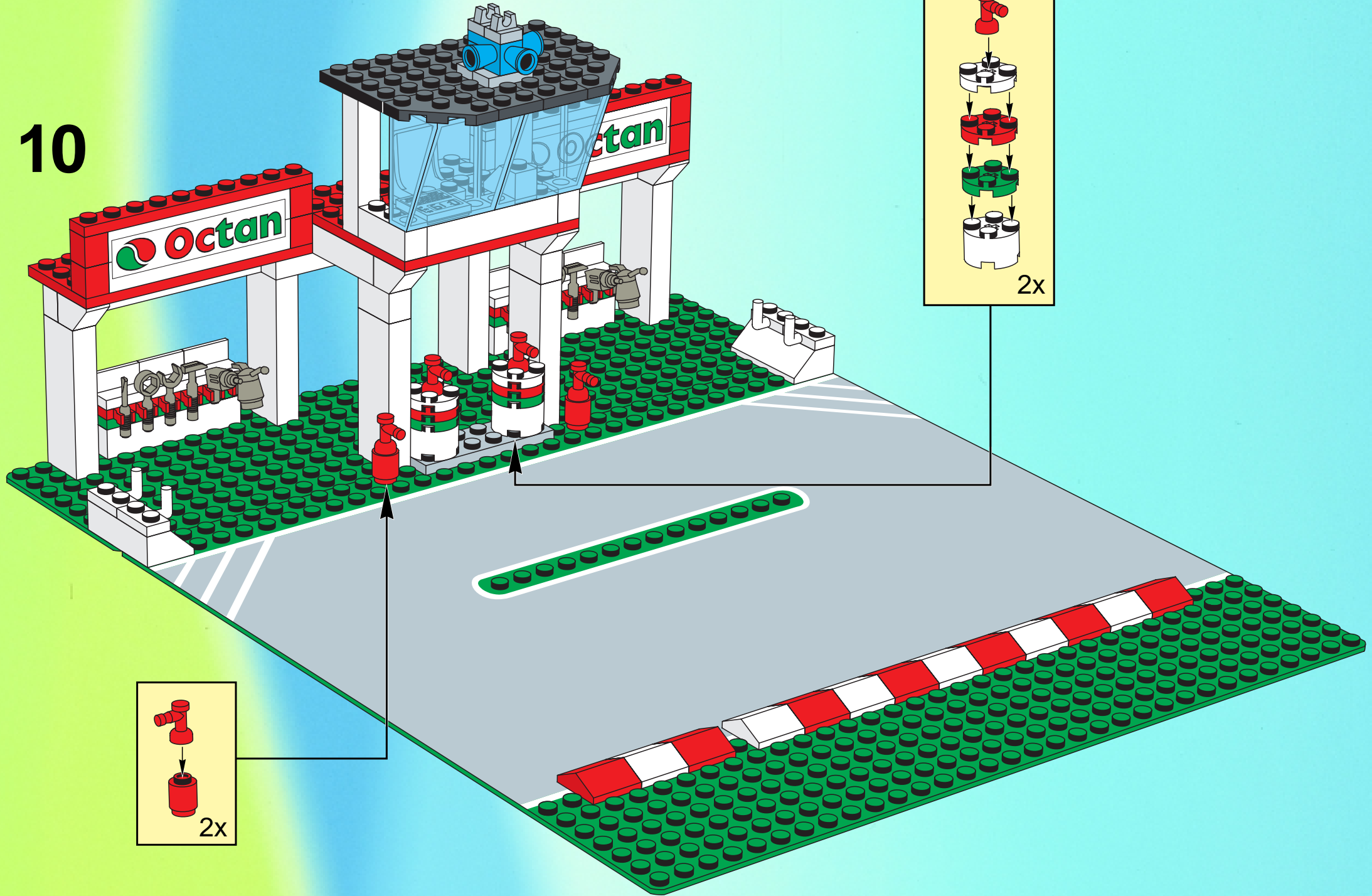

11

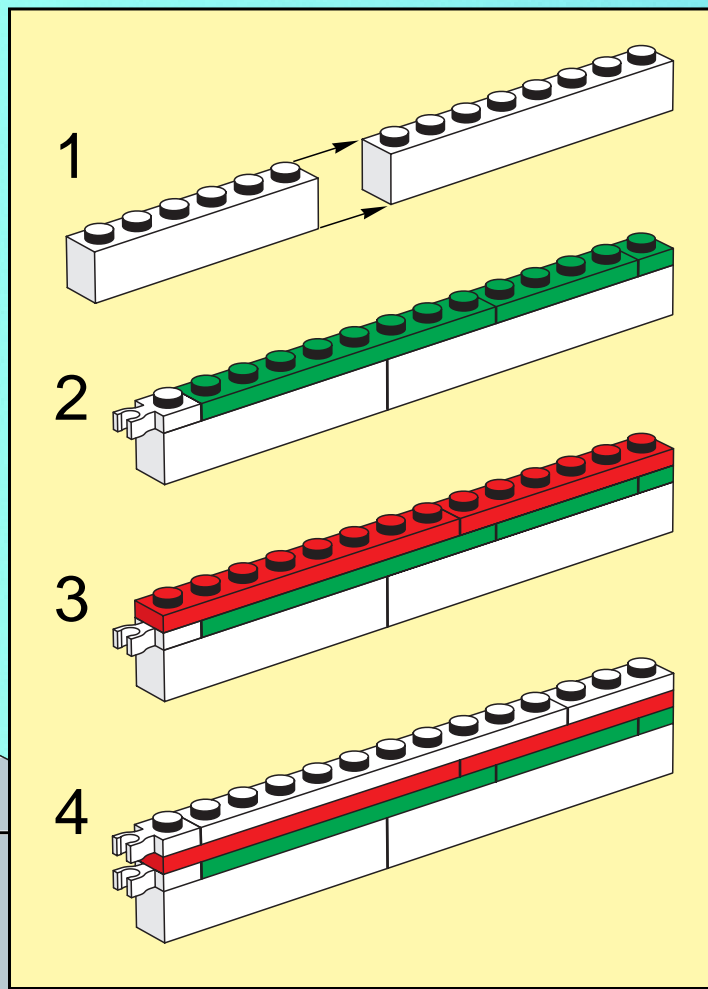
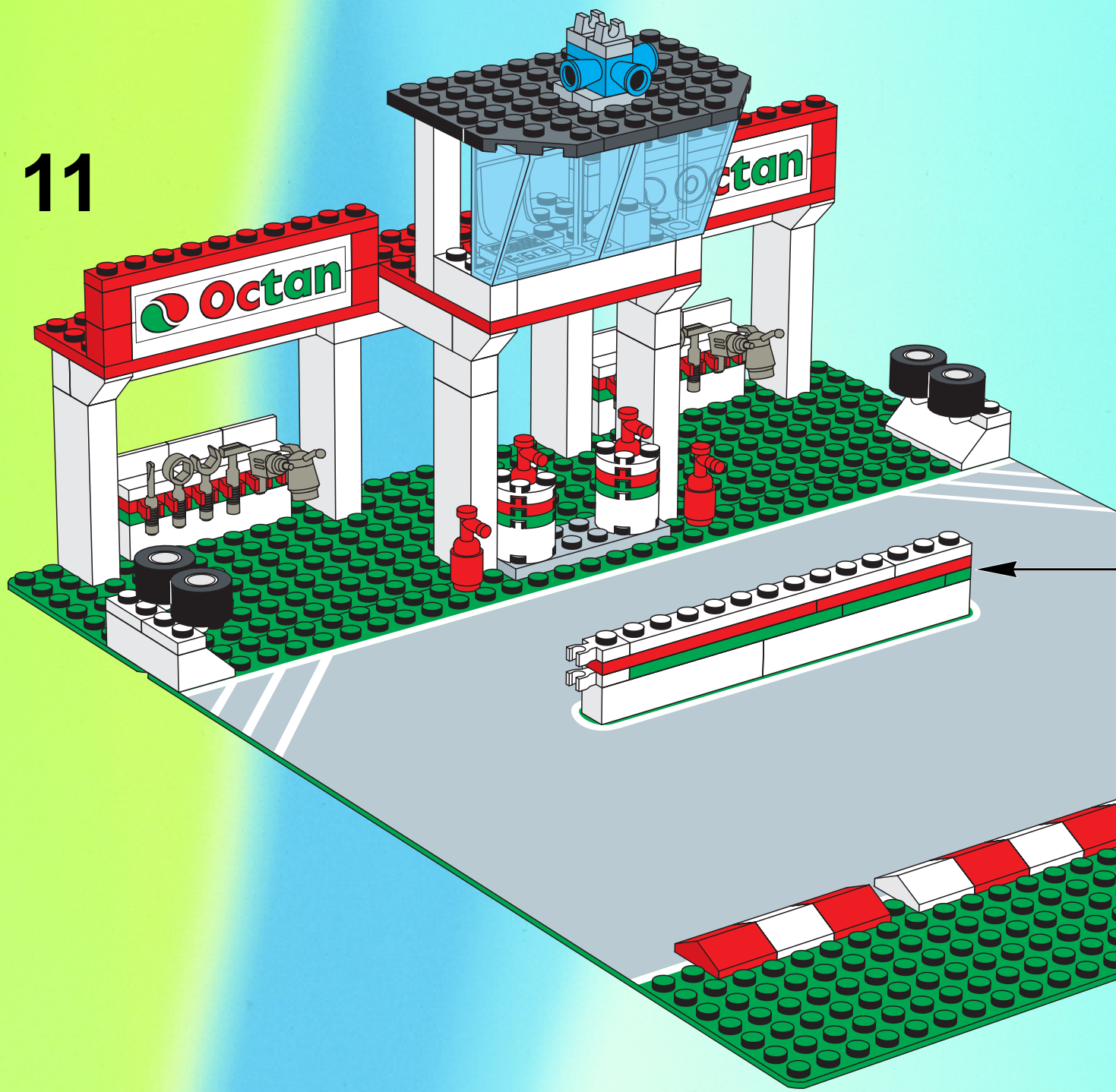

12

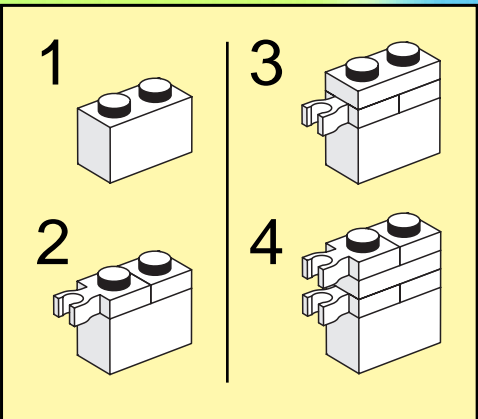
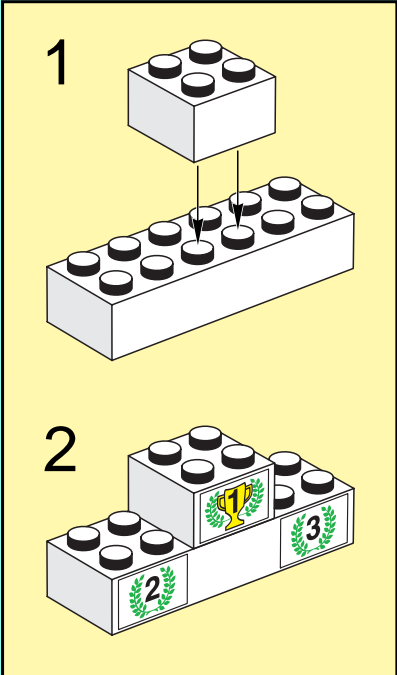
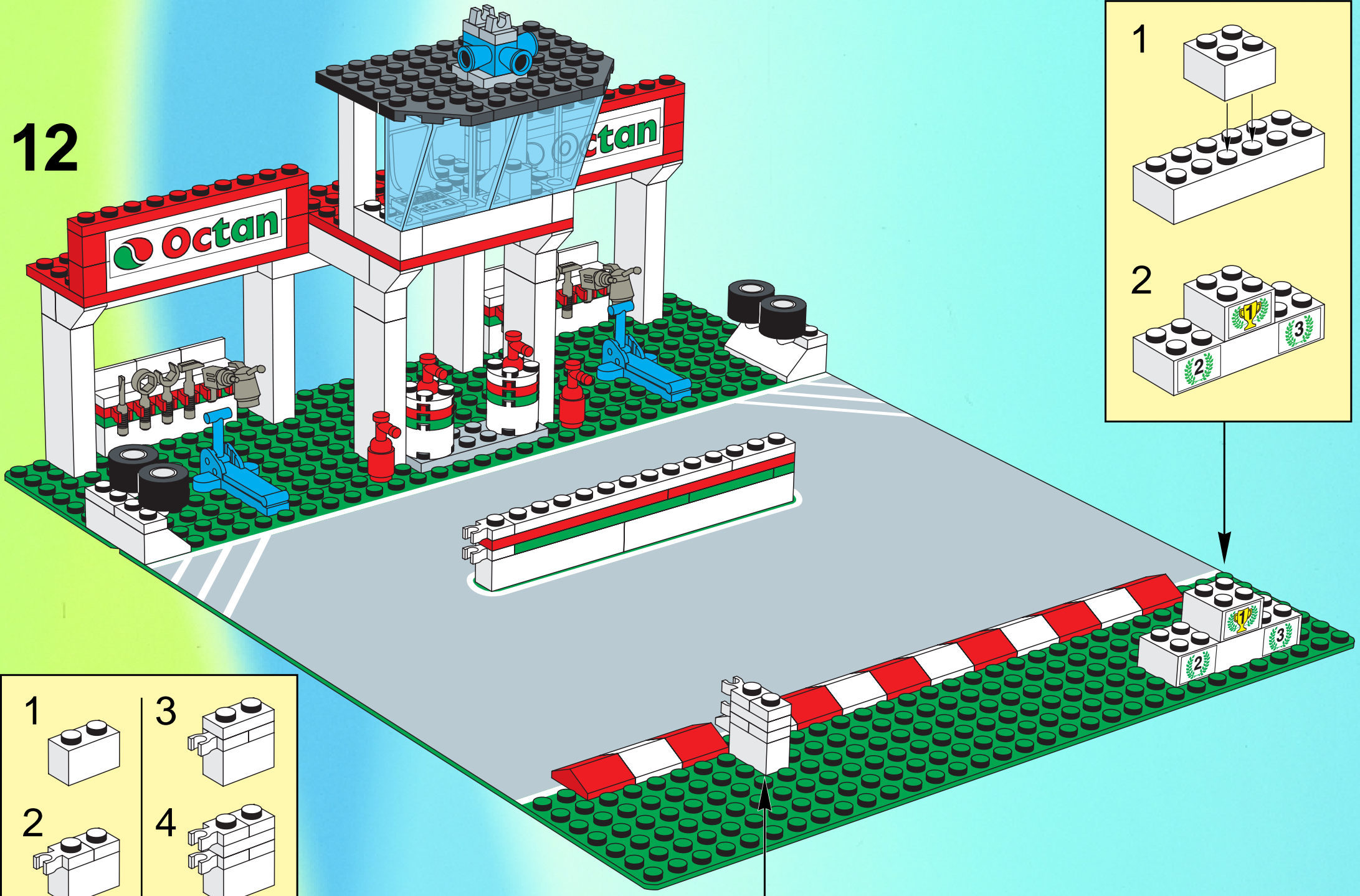

13

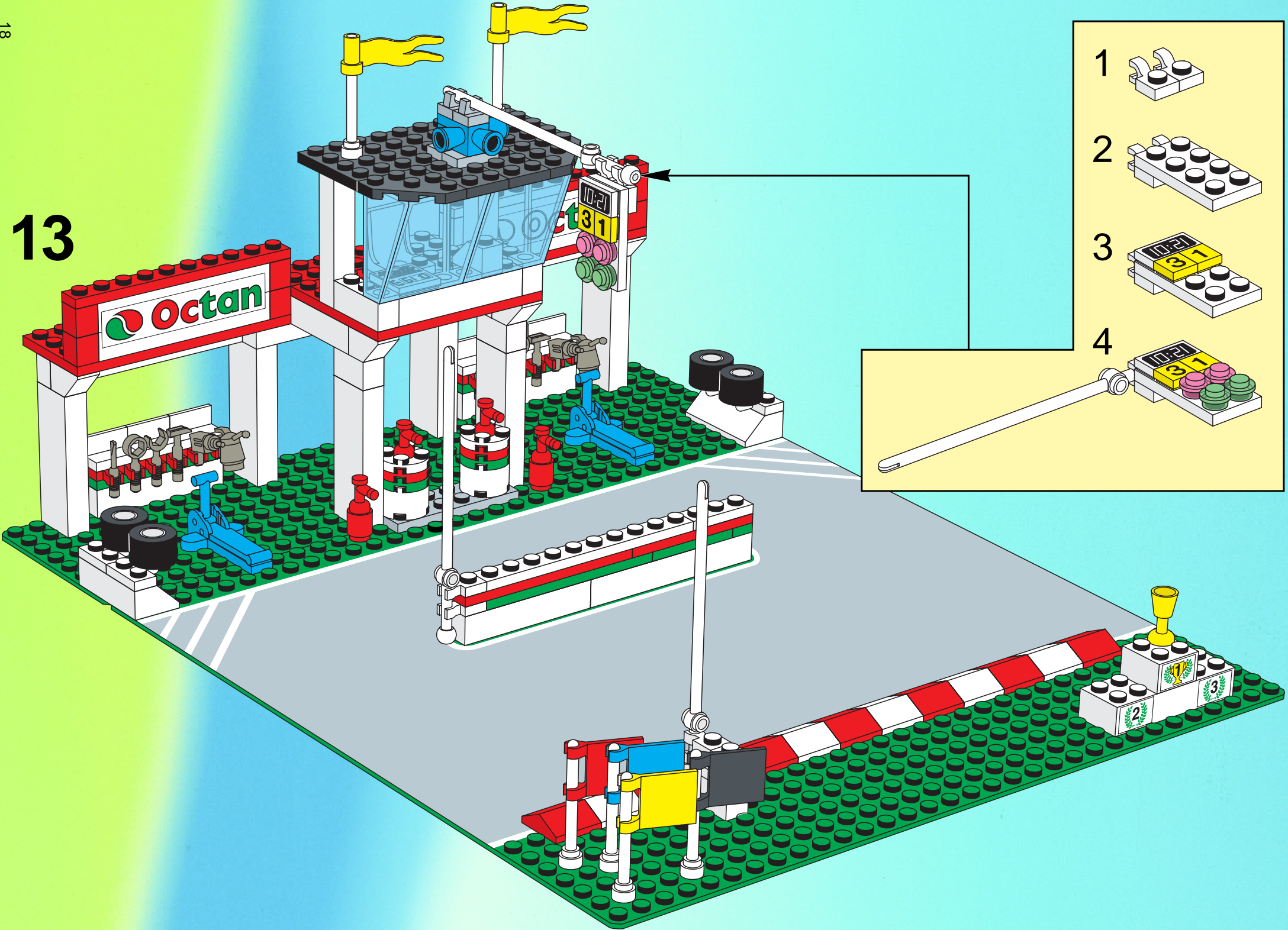

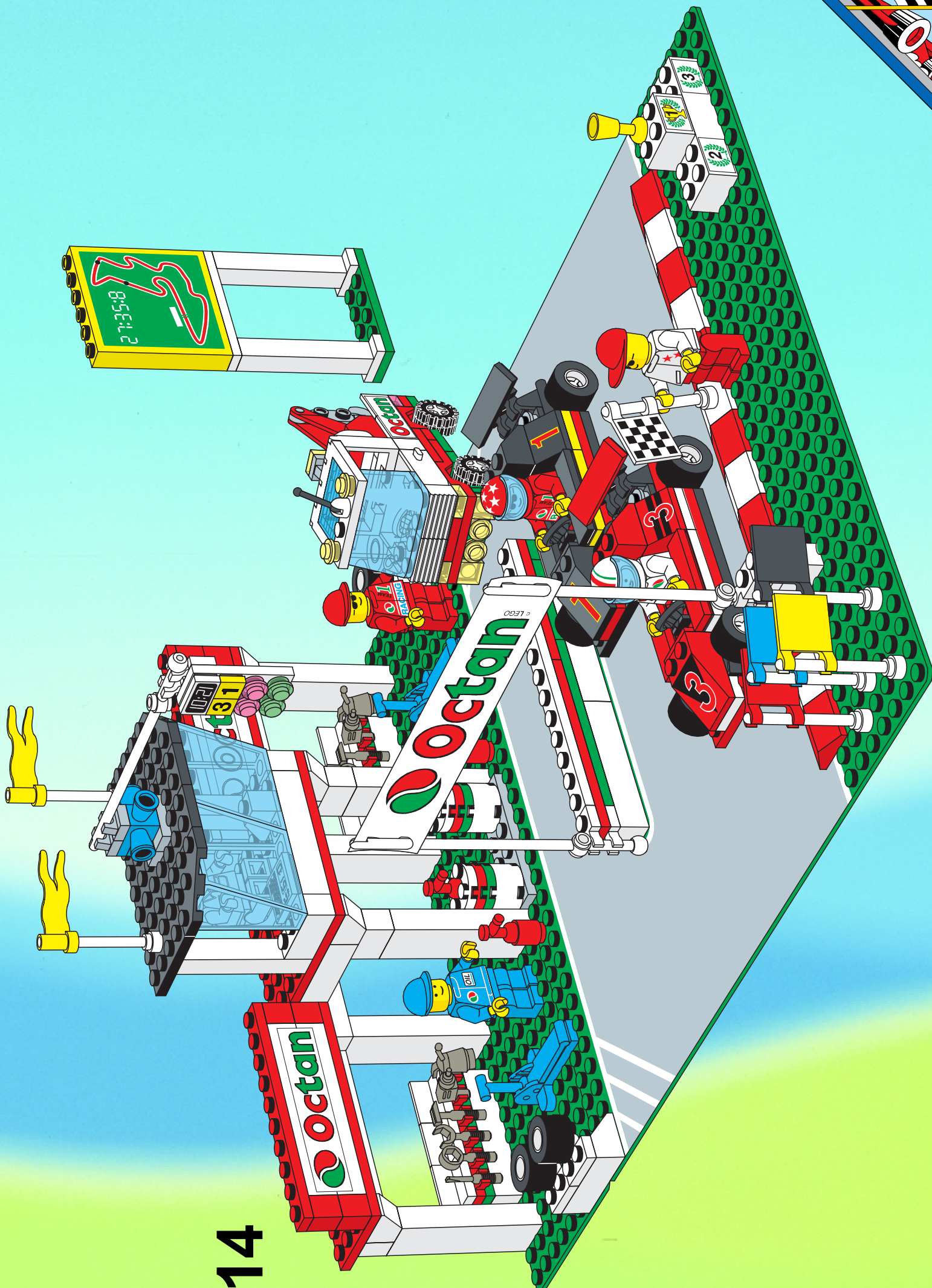

14

6337
1996

 **Octan**

