



**WARNING: CHOKING HAZARD.**  
Small parts. Not for children under 3 years.



BIONICLE

**TKA**  
TOA KONGU



**7-16**

8731



1



2

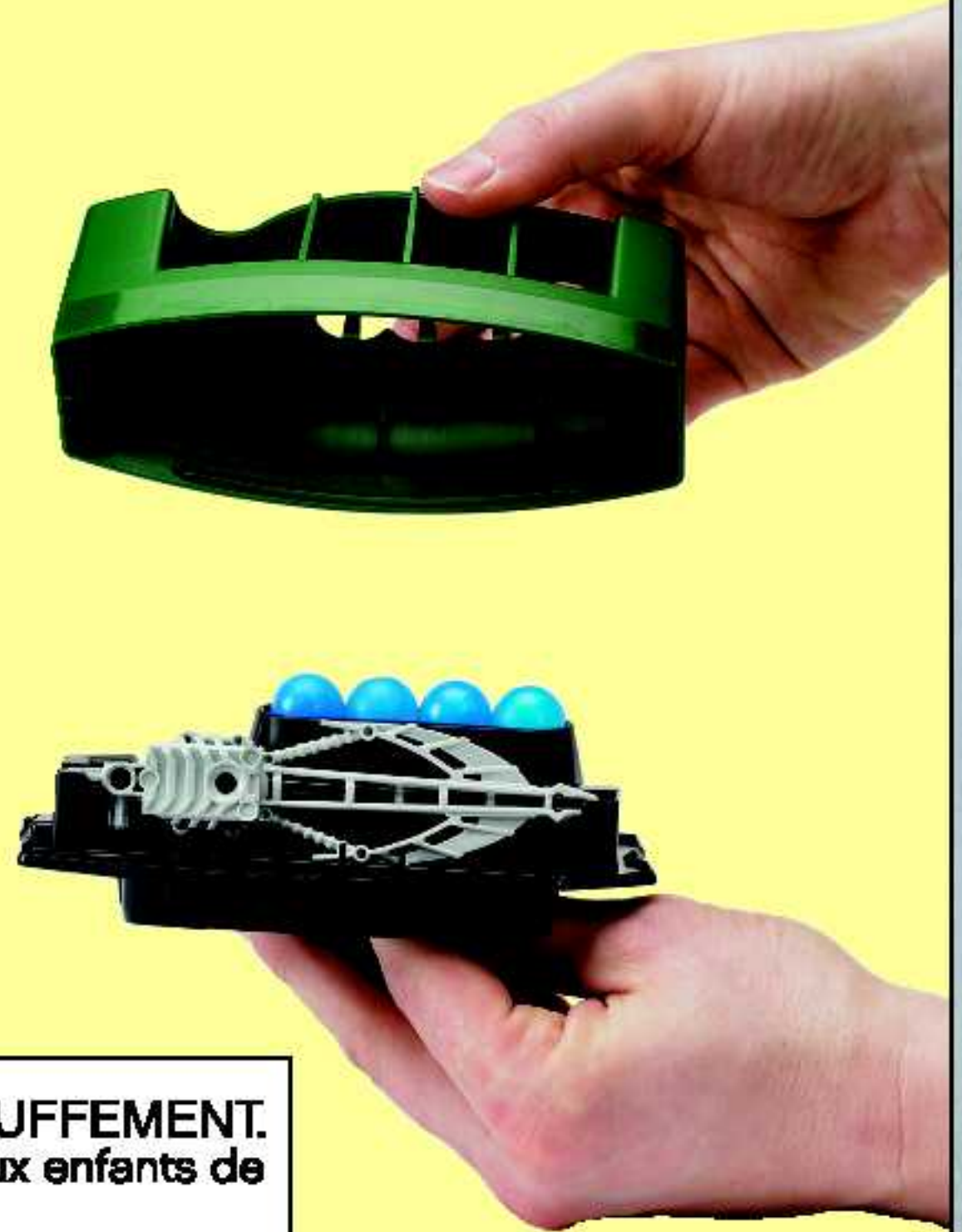

**AVERTISSEMENT : RISQUE D'ÉTOUFFEMENT.**  
Contient des petites pièces. Ne convient pas aux enfants de moins de 3 ans.



**ADVERTENCIA: PELIGRO DE ASFIXIA.**  
No recomendado para niños menores de 3 años. Contiene piezas pequeñas.

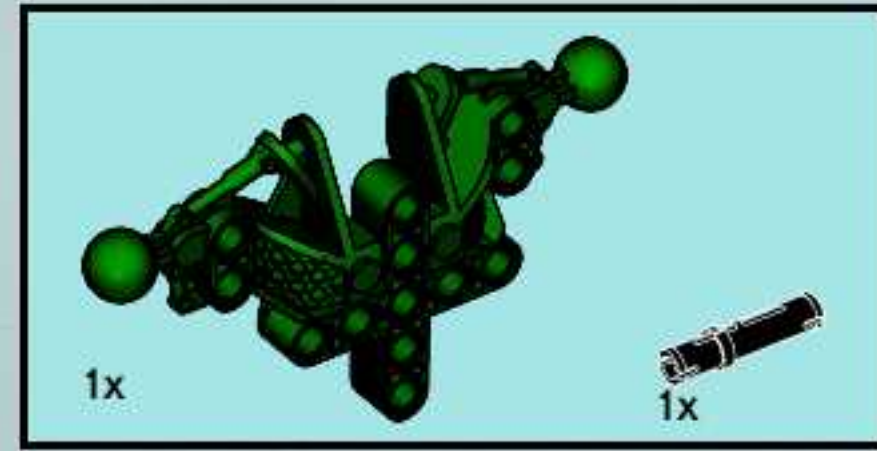
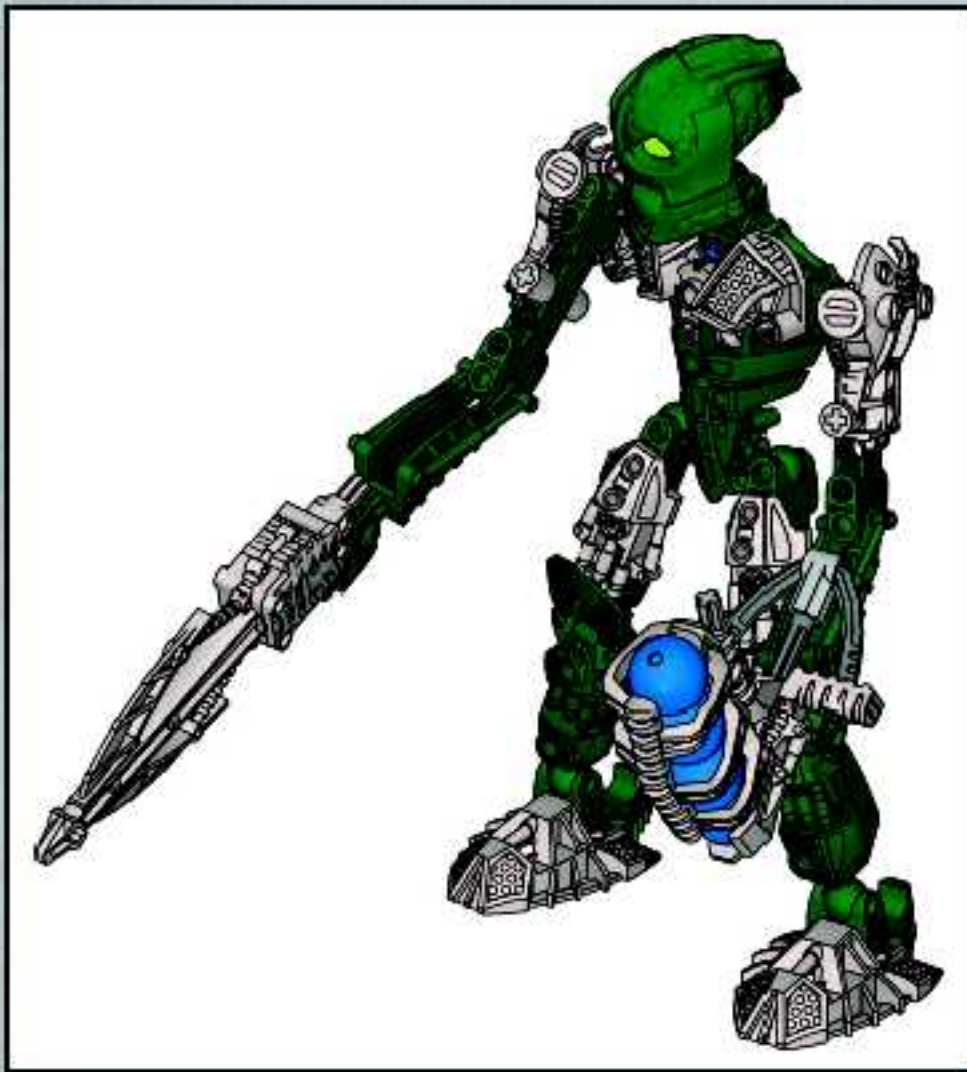

1

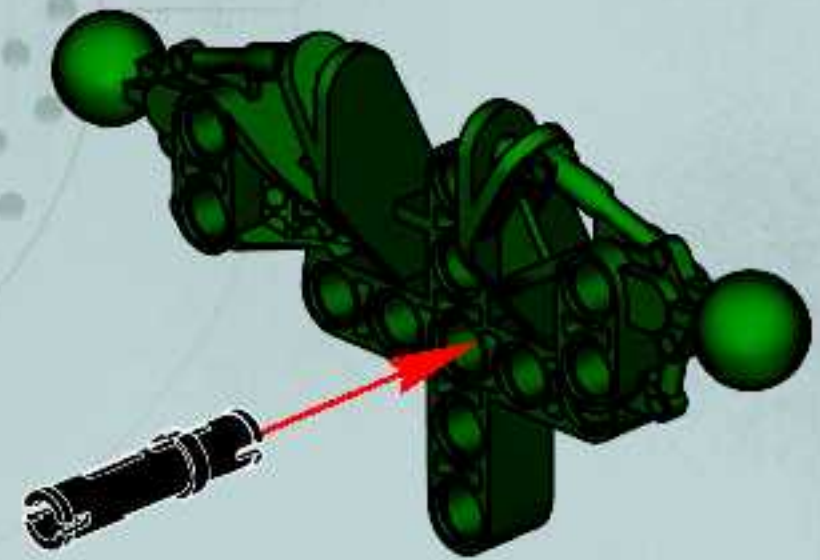



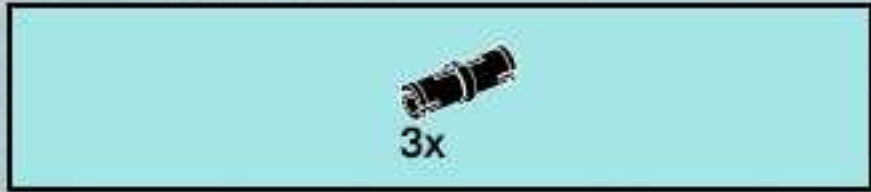

2

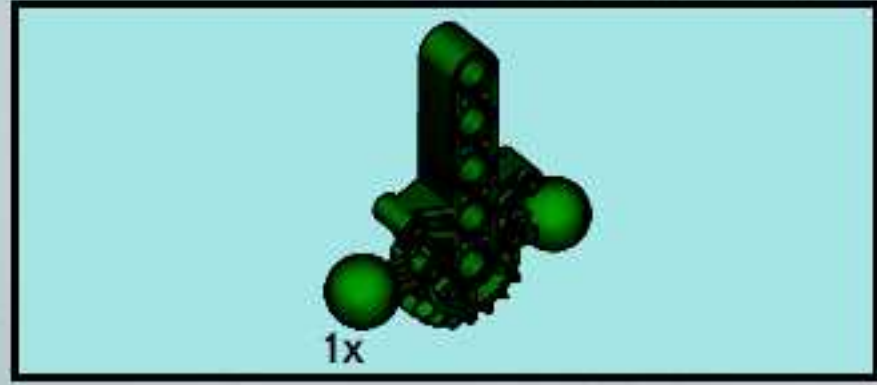

3

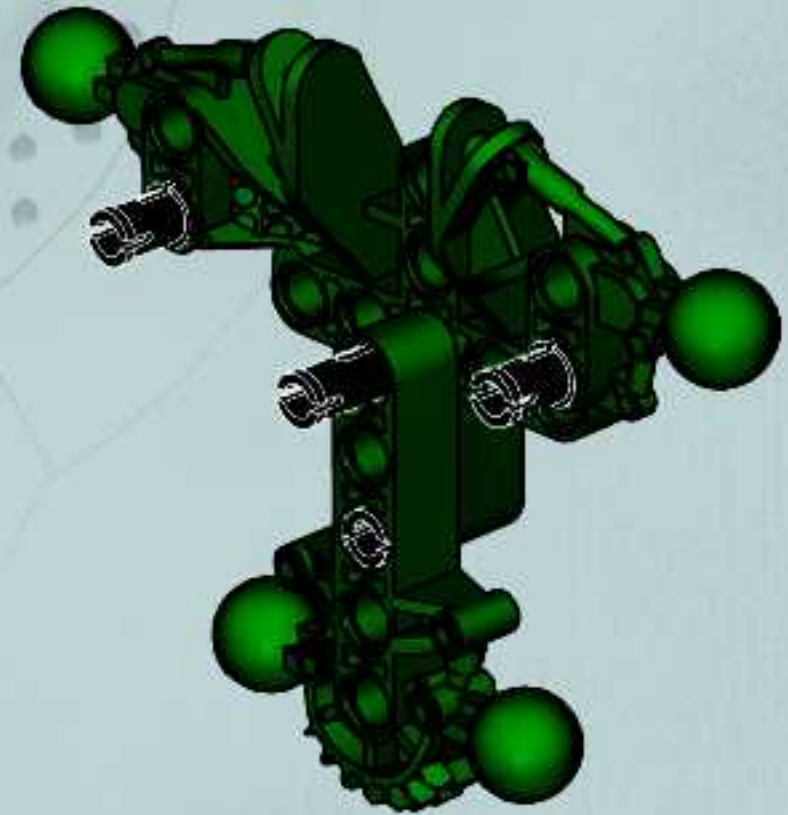
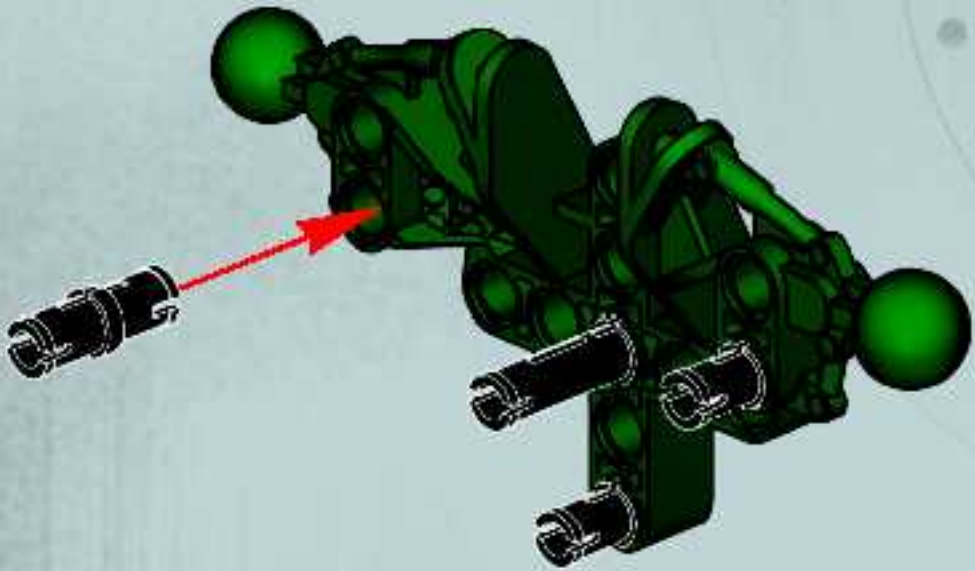

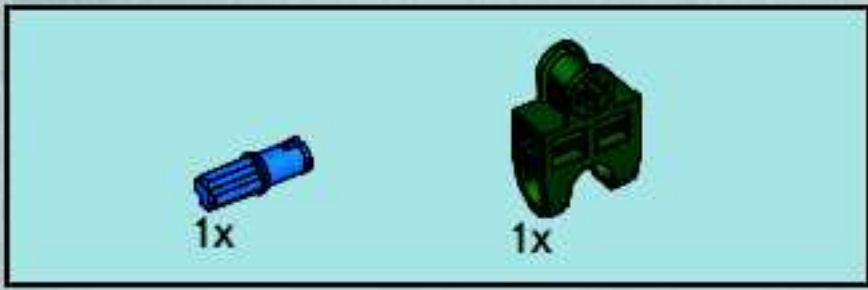

4

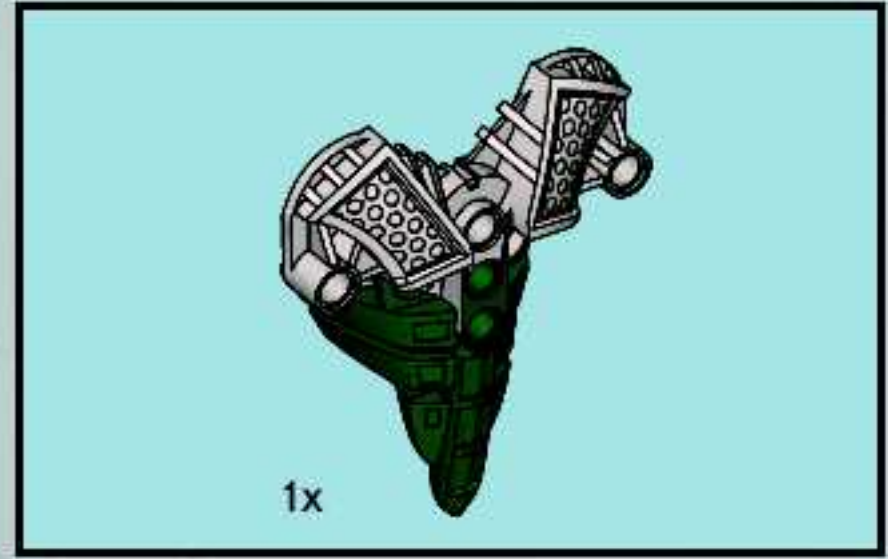
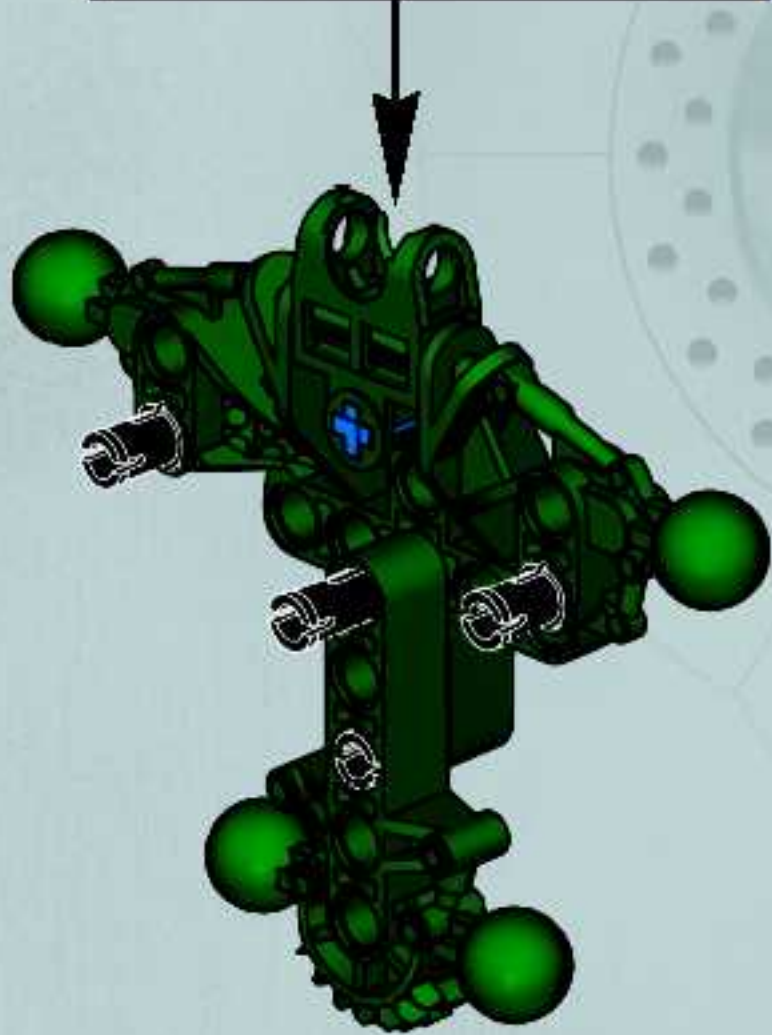
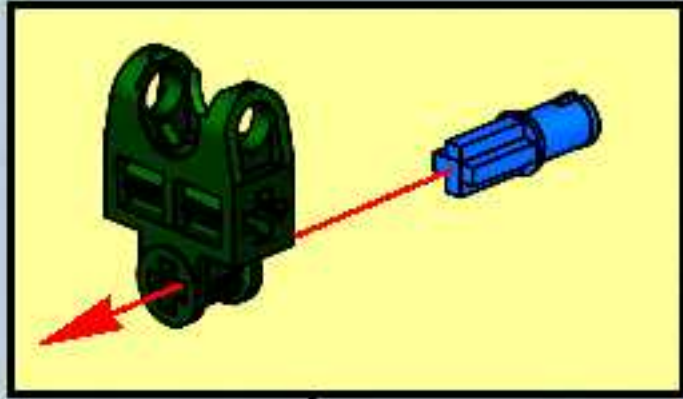

5

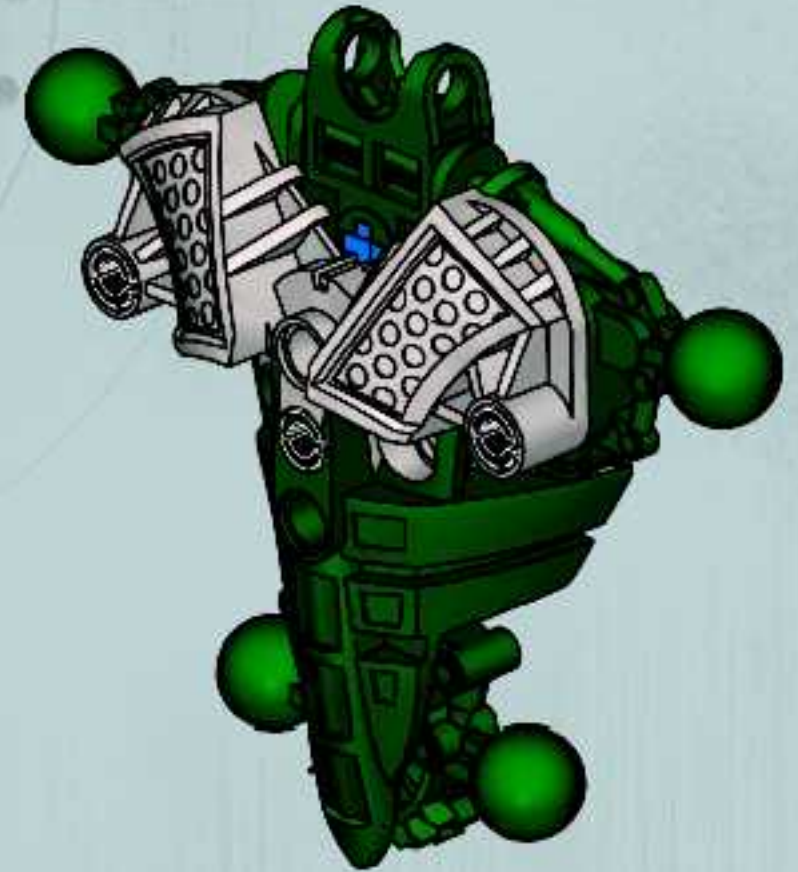



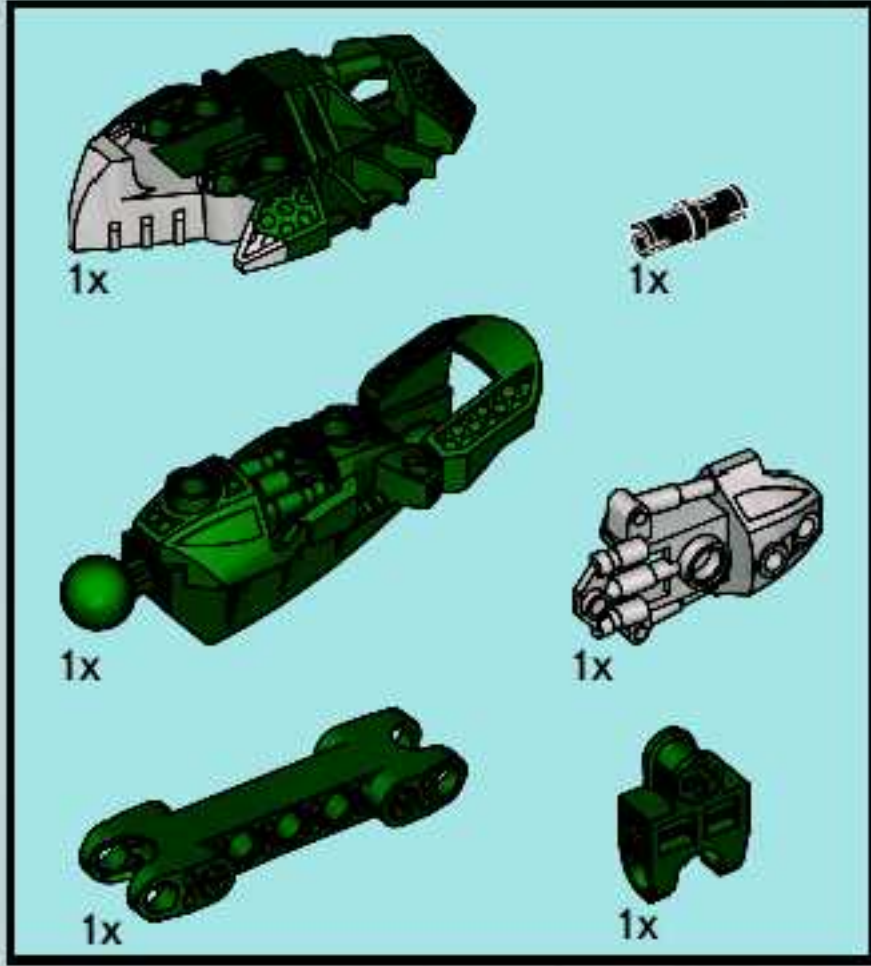

6

1

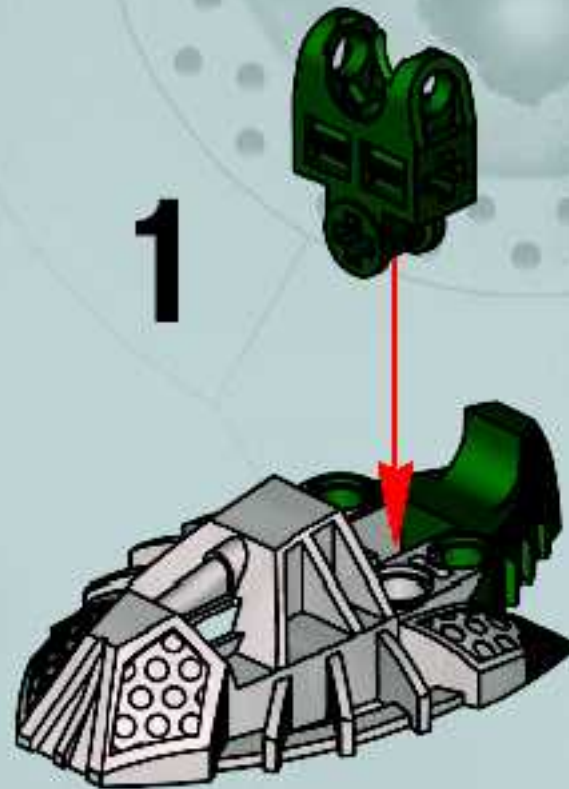

2

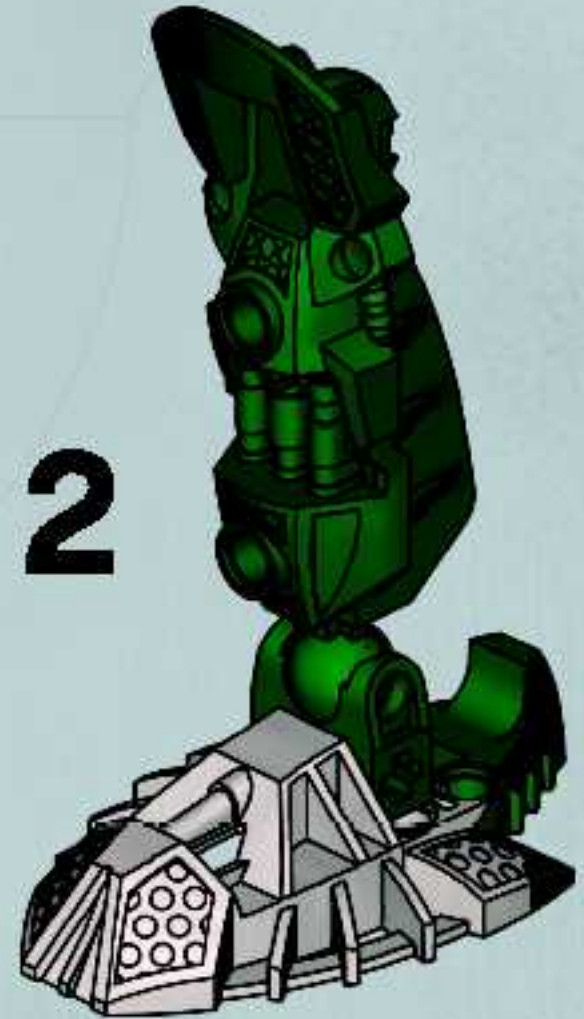

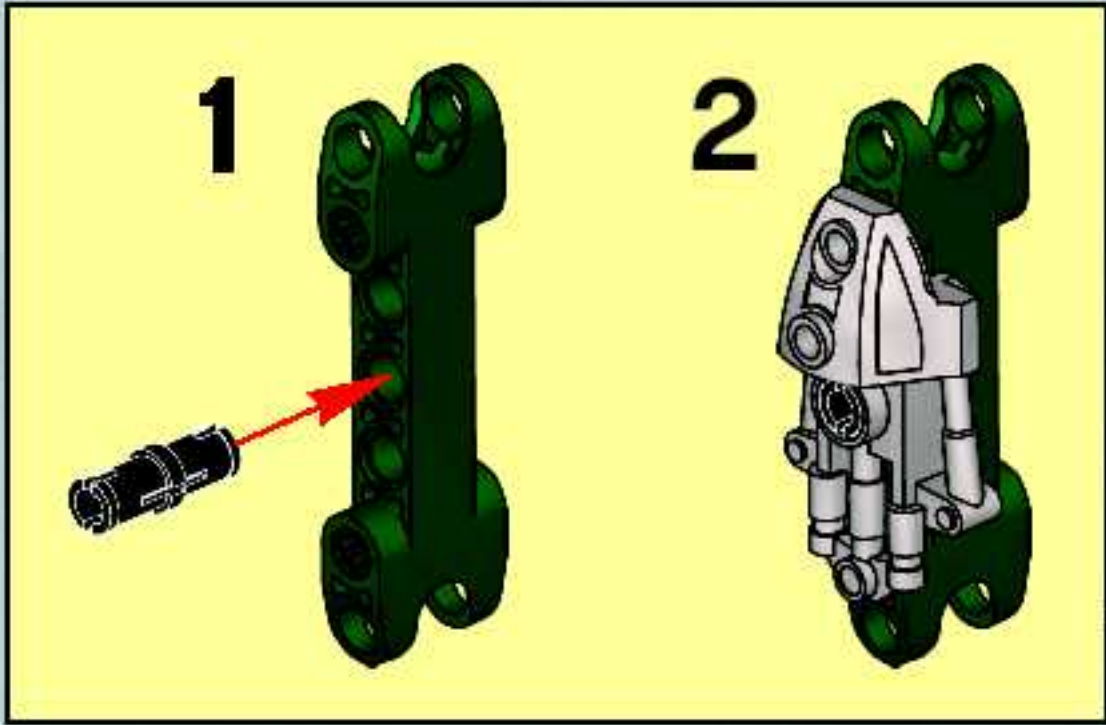

2x



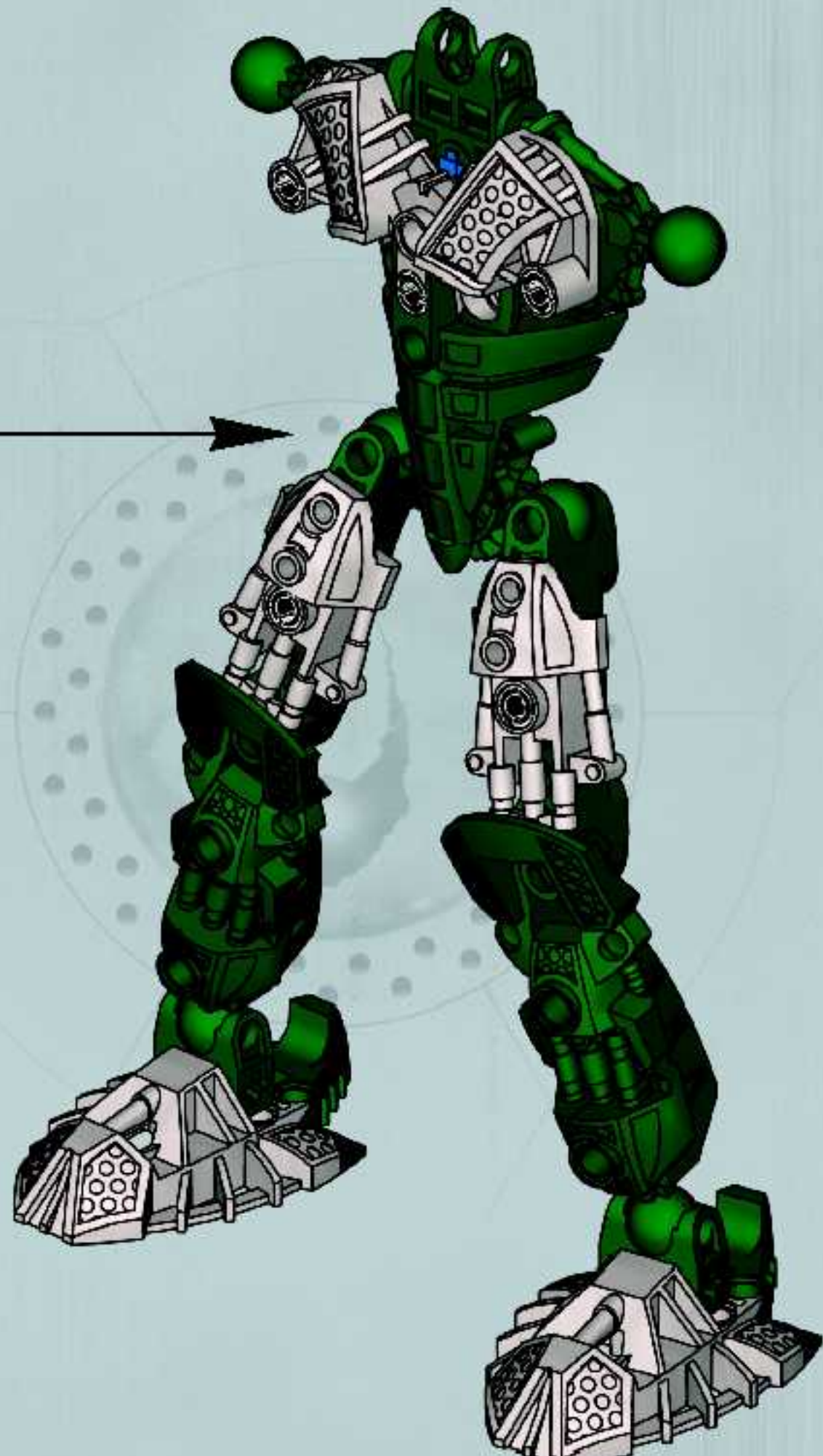



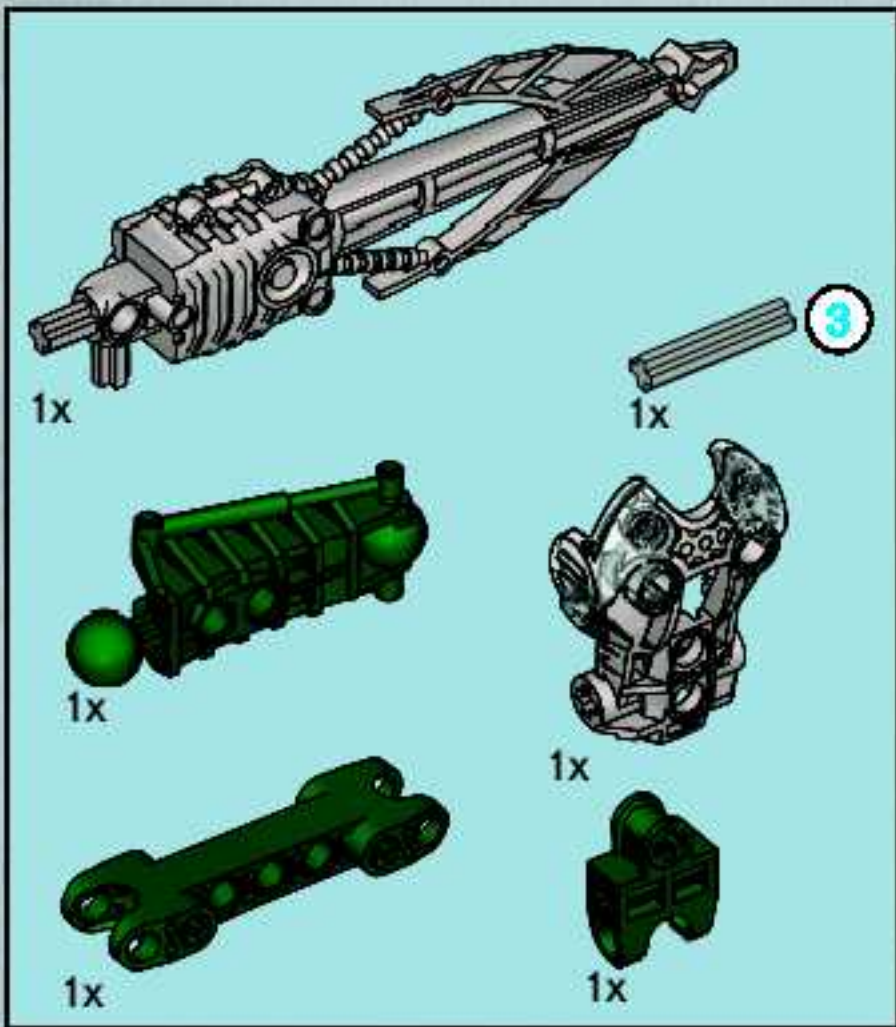

7



1

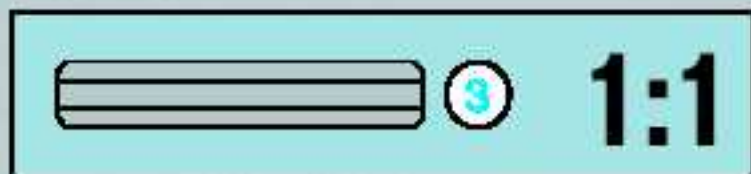
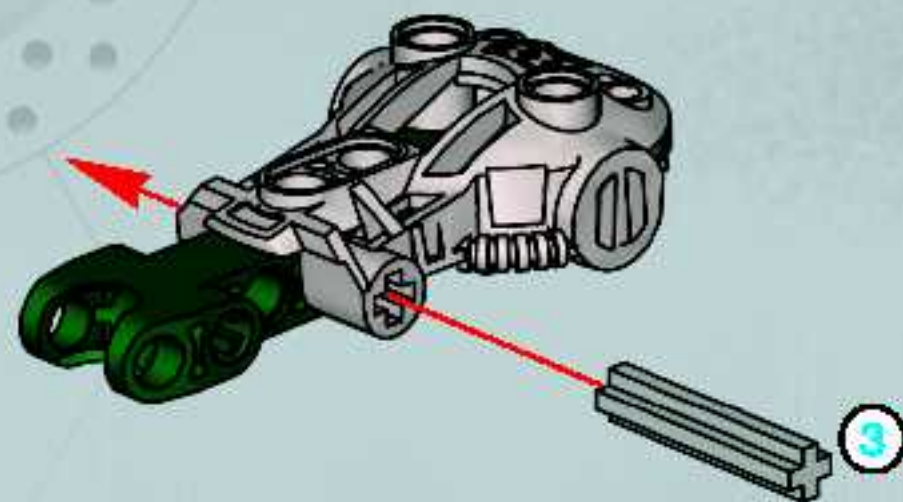
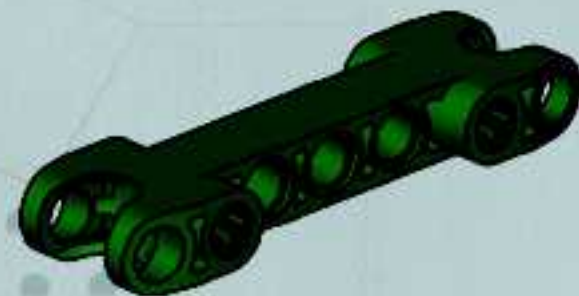



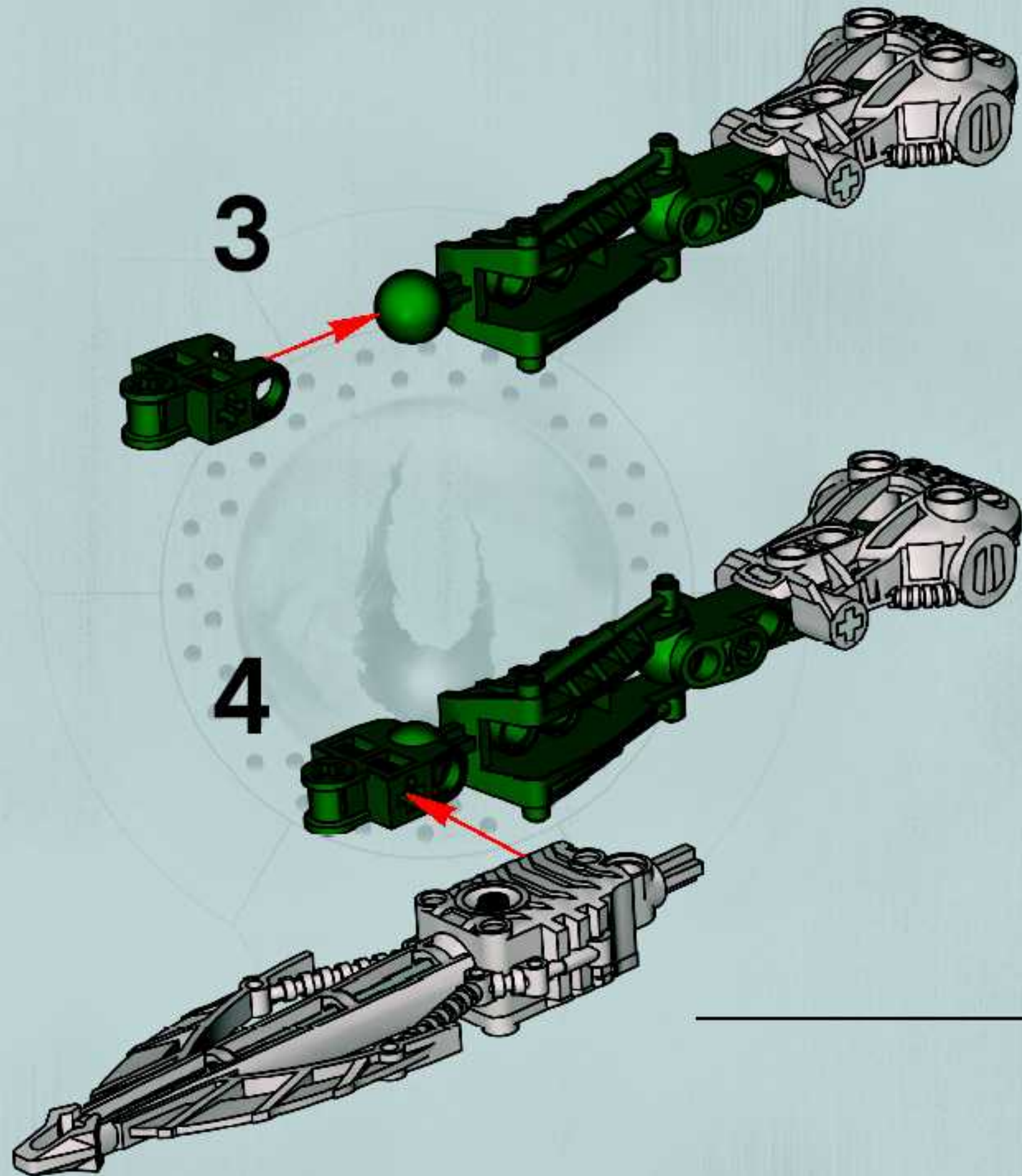



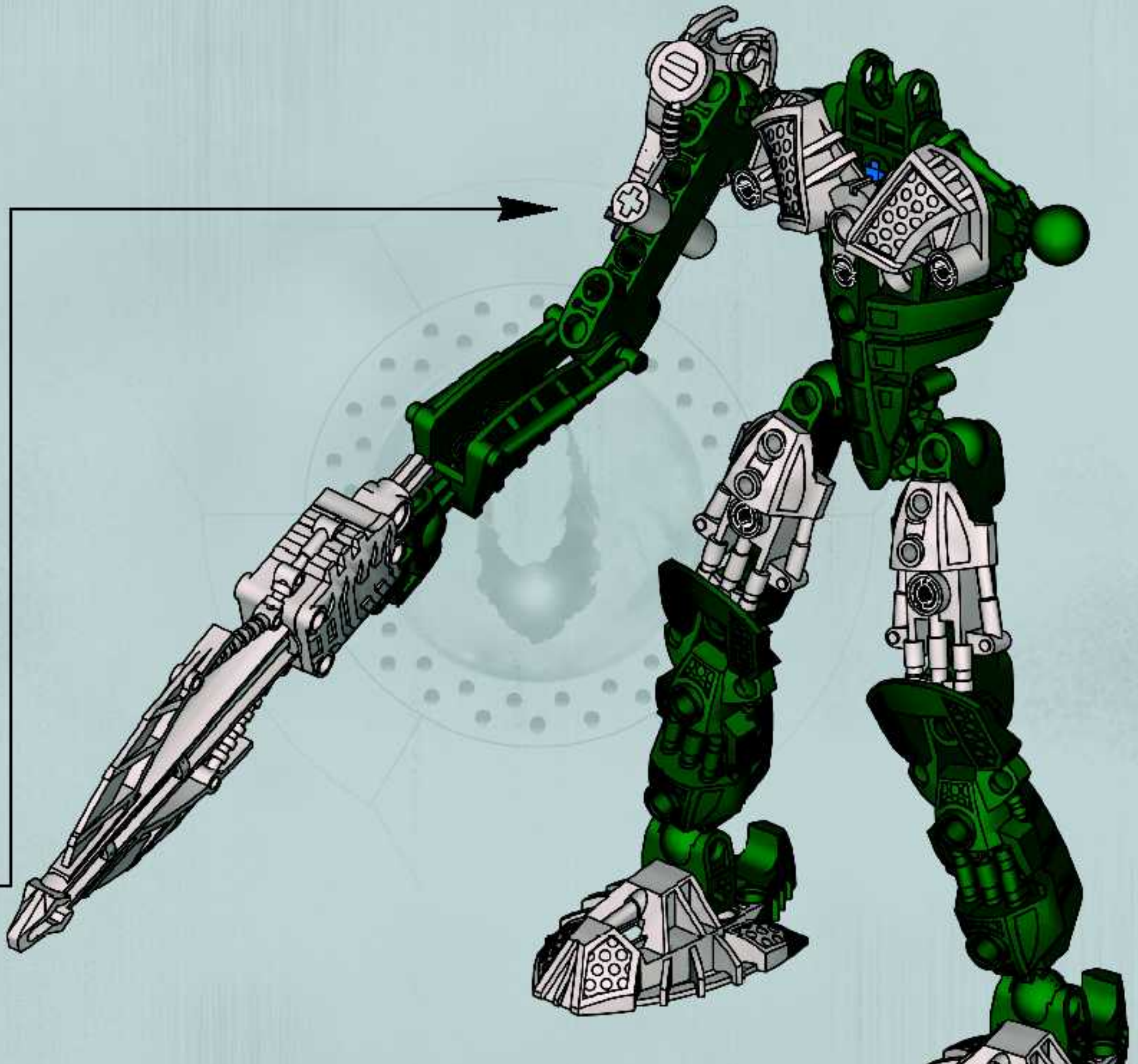





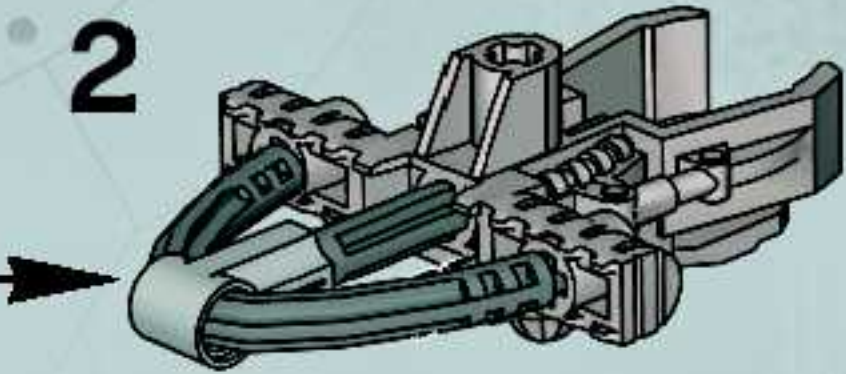
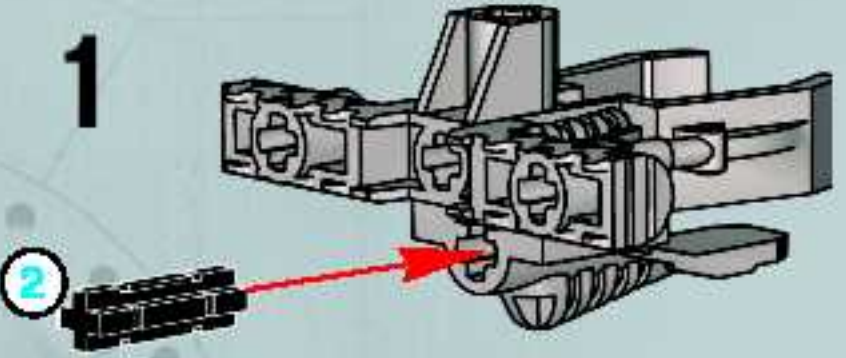
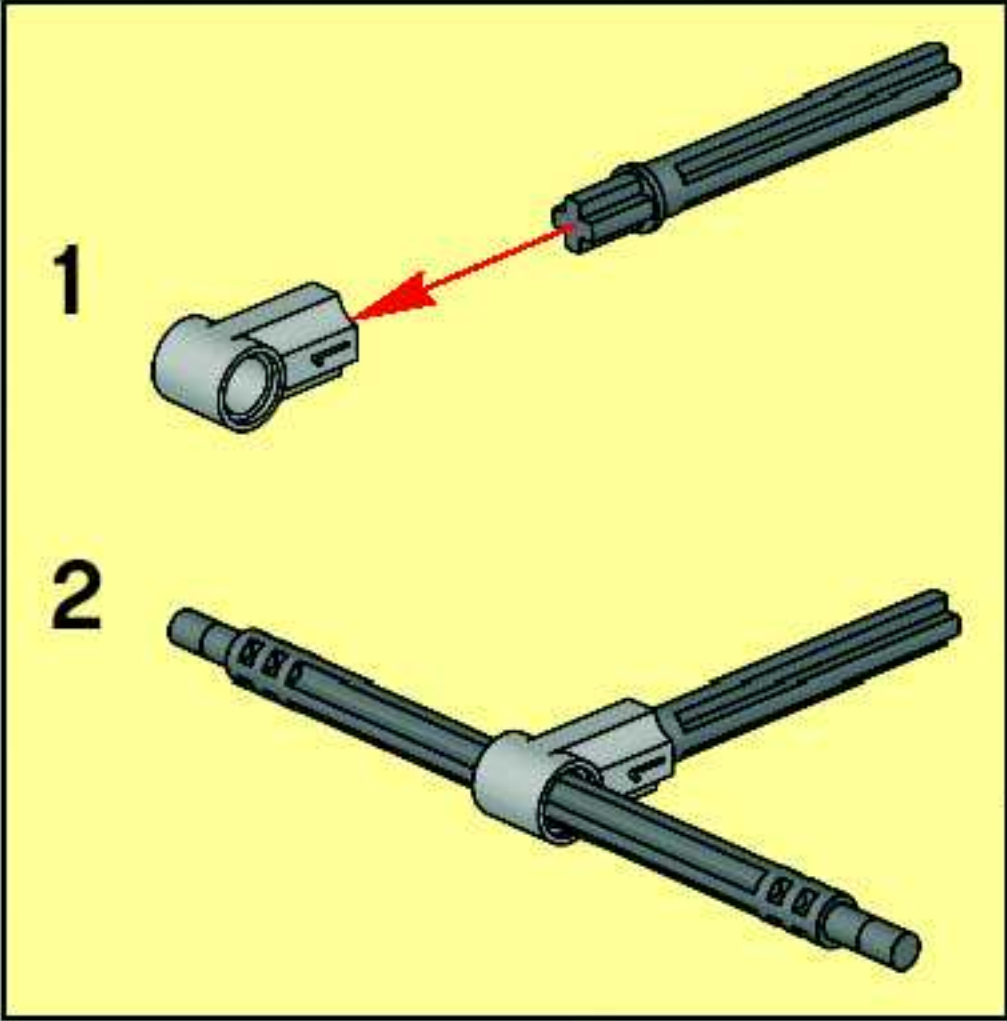
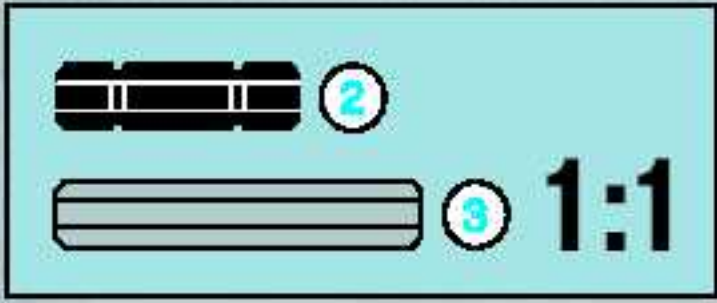



4

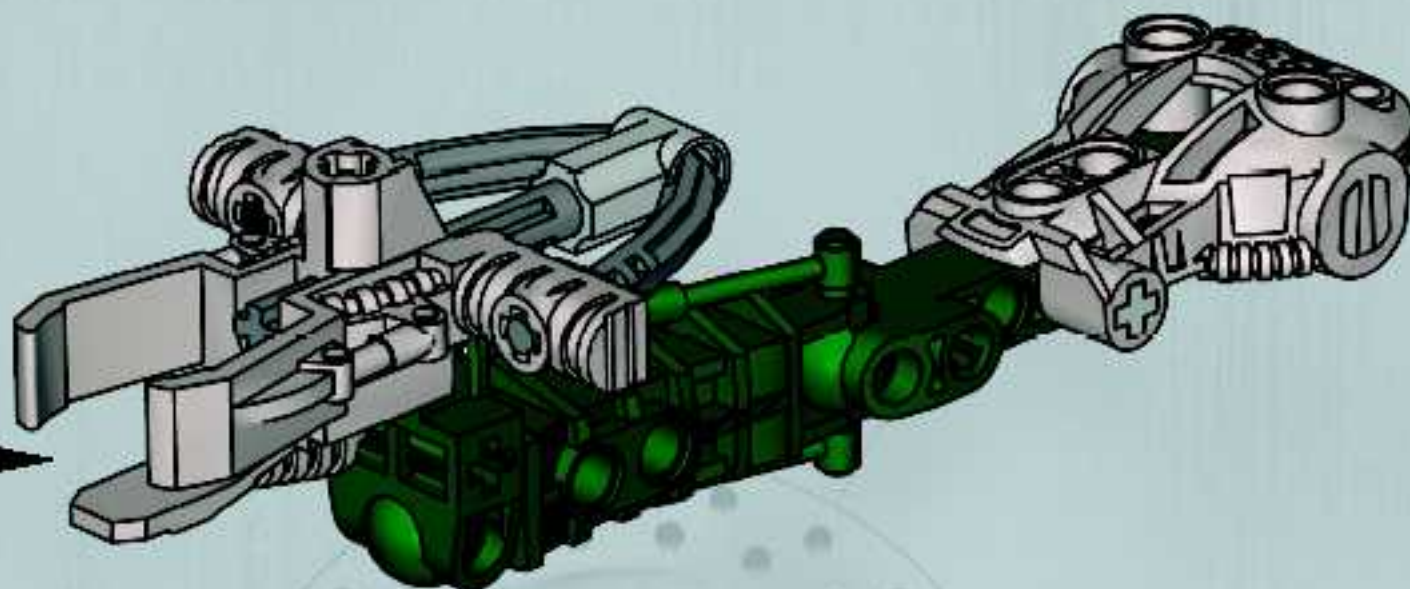

5

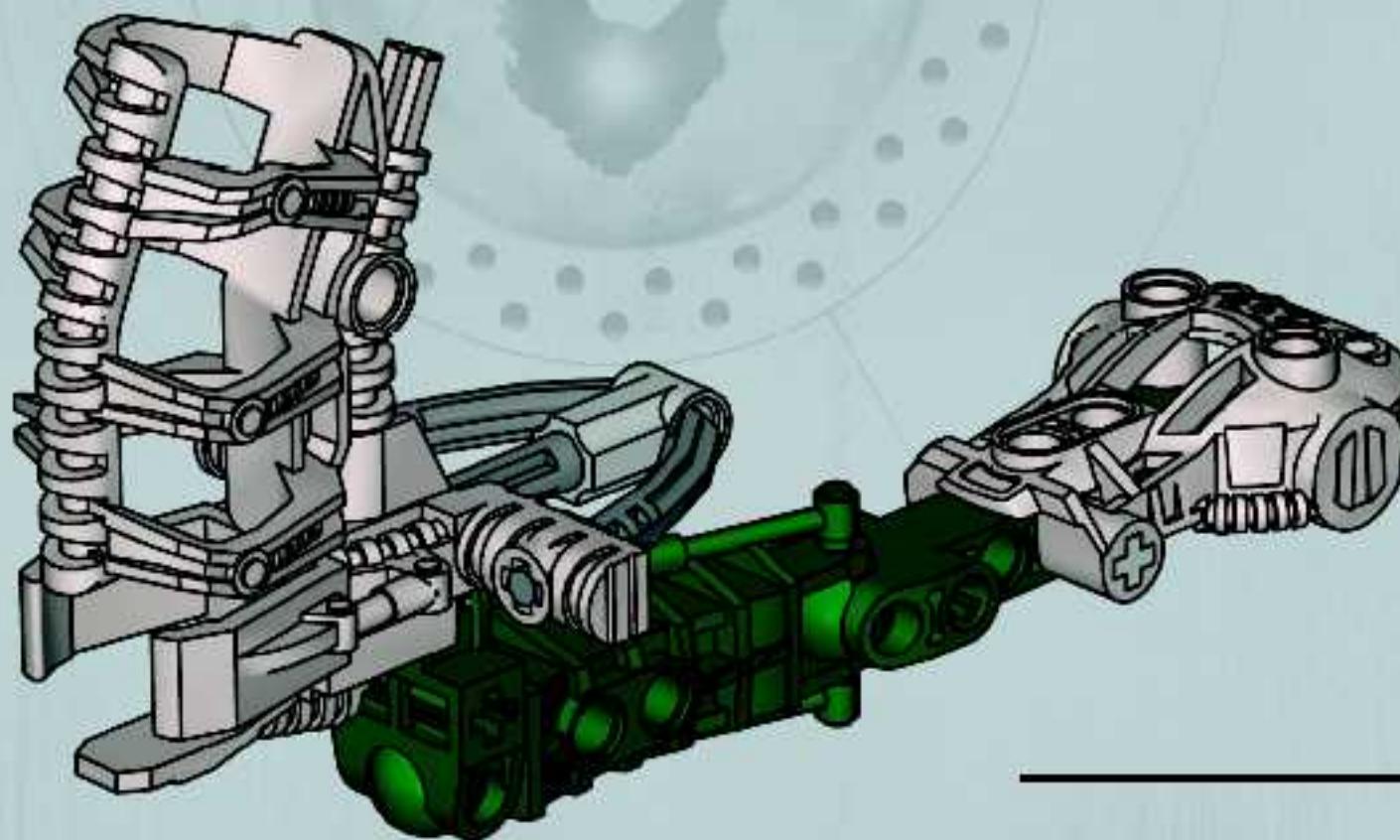



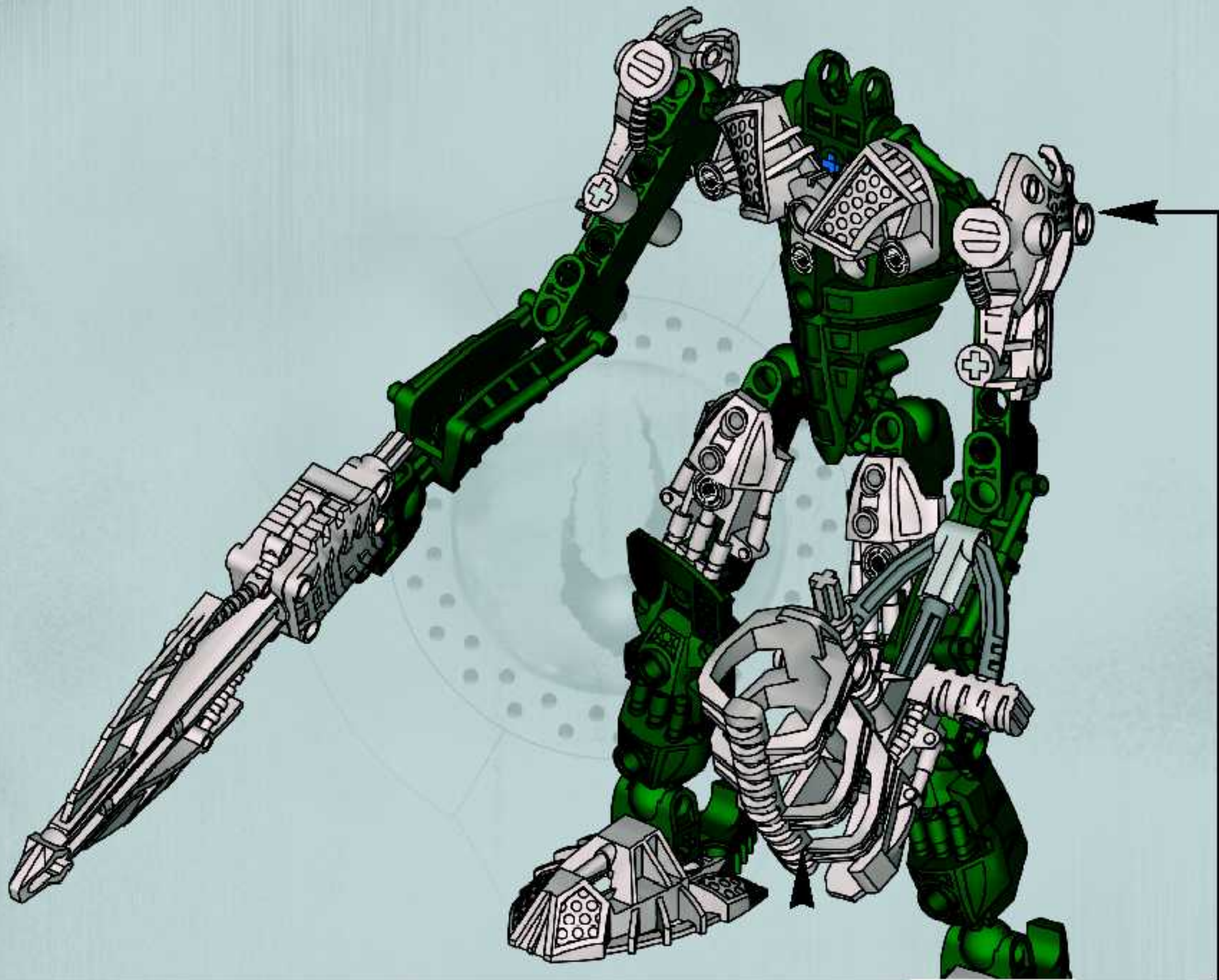



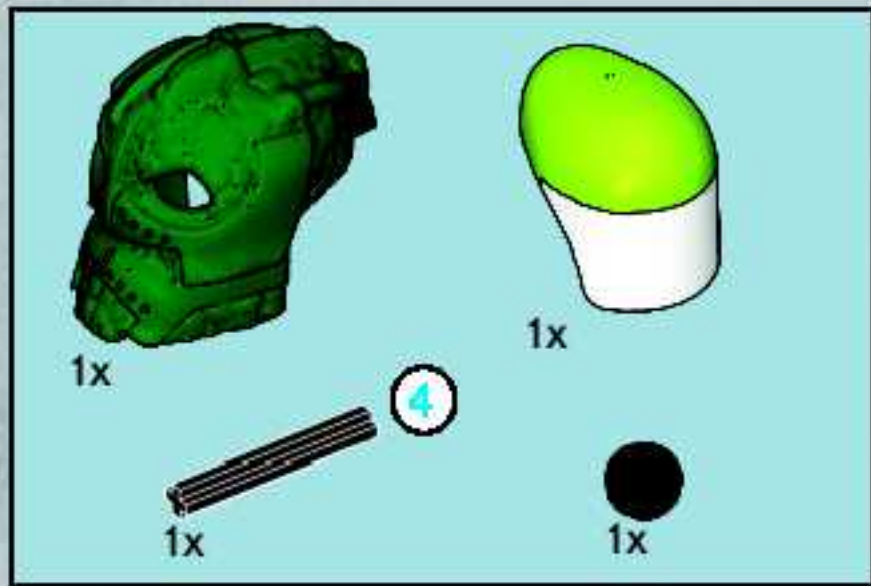

9

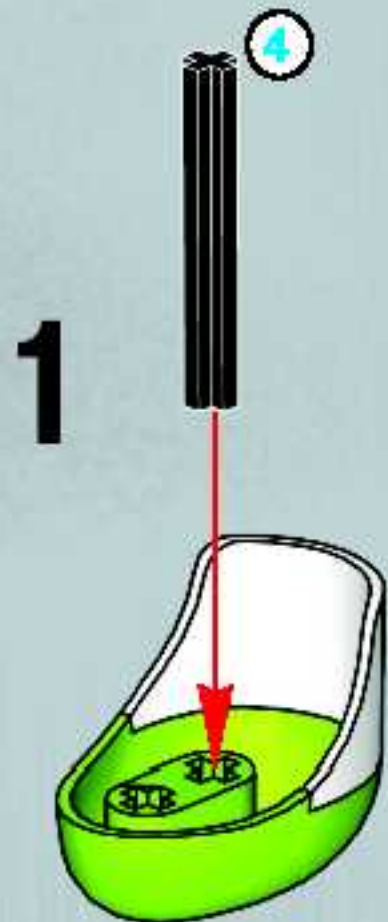

3

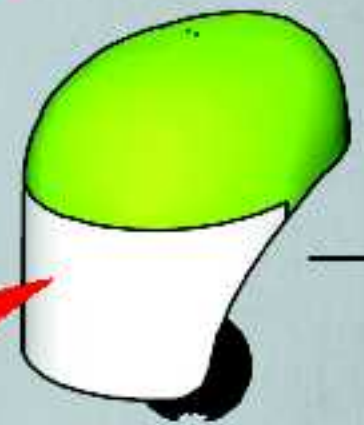
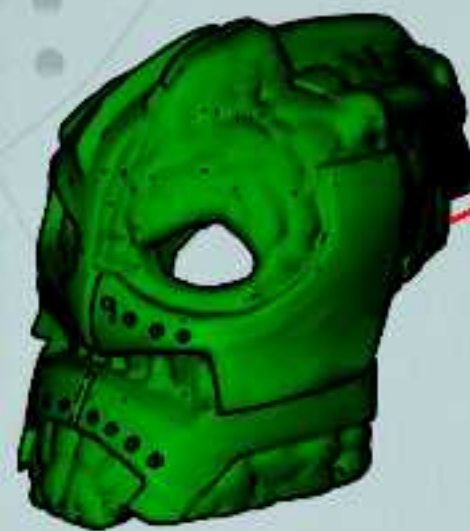



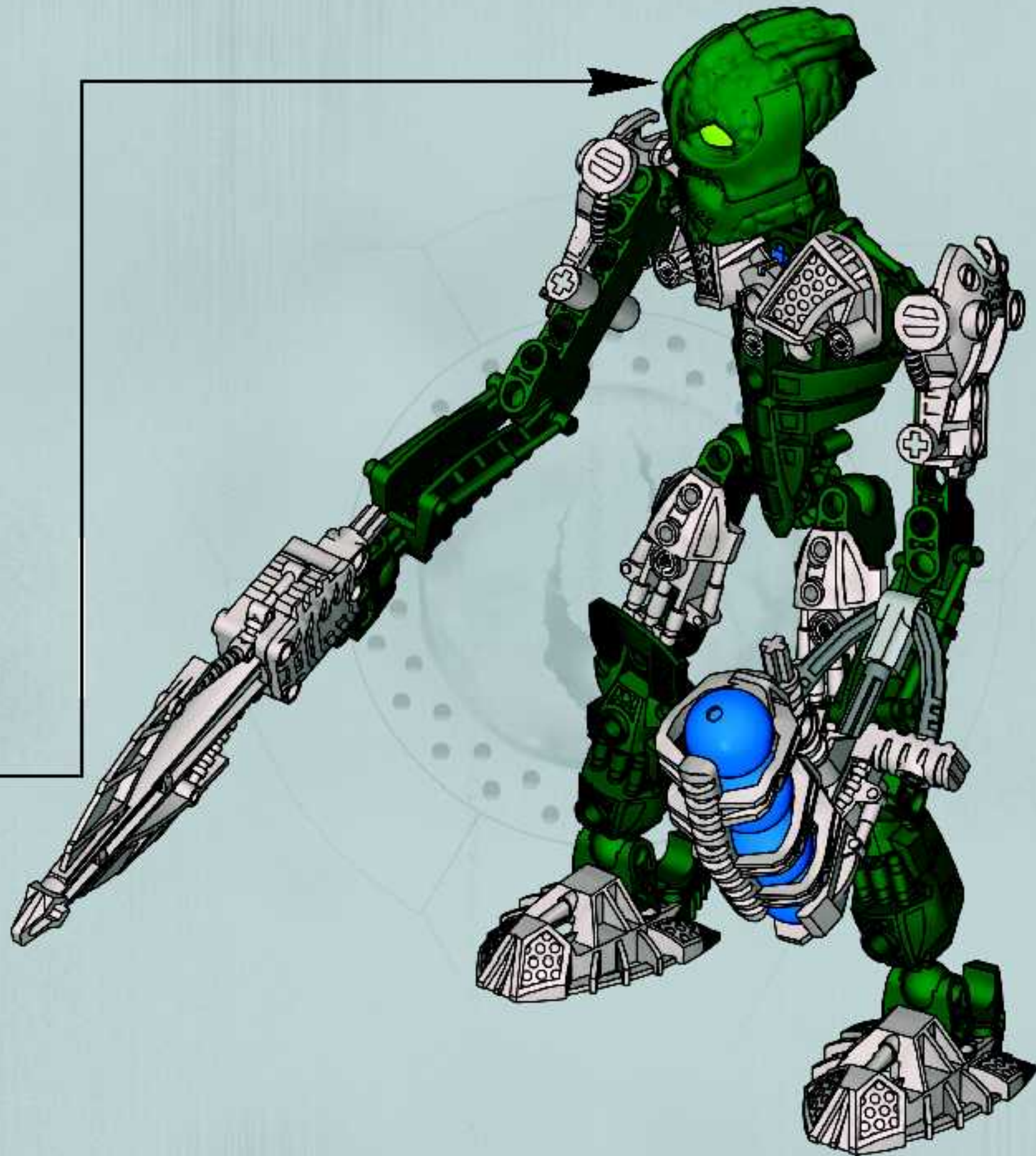





4x

# 10



**CAUTION:** Do not aim at eyes or face.  
**ATTENTION :** Ne pas viser les yeux ni le visage.  
**PRECAUCIÓN:** No lo dirija a los ojos o cara.

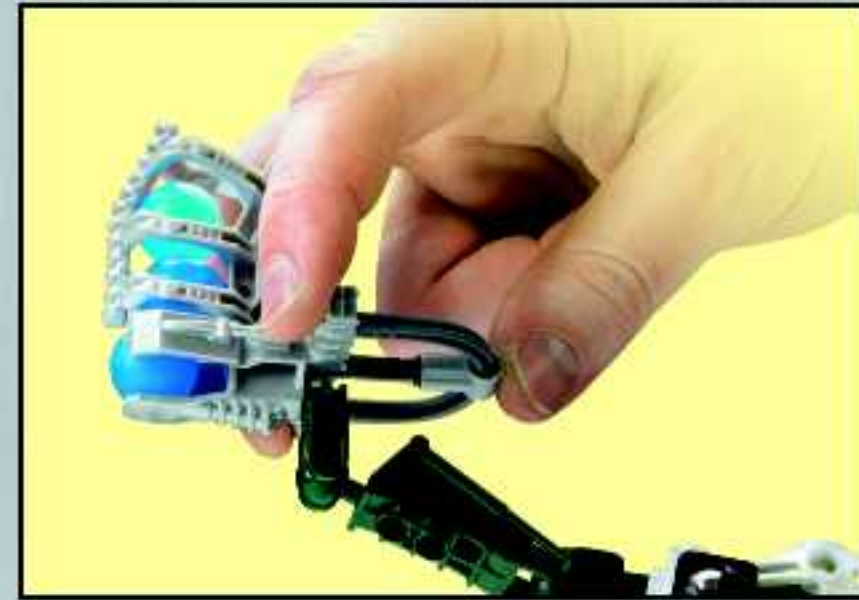





2x  
4494481



5x  
4121715



1x  
4492471



1x  
4211550



1x  
4494483



1x  
4278501



1x  
655826



4x  
4297031



2x  
4211815

3



2x  
4278476



1x  
4109810

2



1x  
4263624



1x  
4493394



1x  
4276539



1x  
370526

4



1x  
4292000



2x  
4494482



2x  
4493393



1x  
4294883



1x  
4286267



4x  
4276581

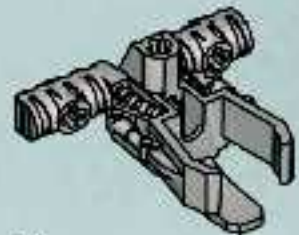

1x  
4494490



1x  
4206482



2x  
4294897



5x  
4227559

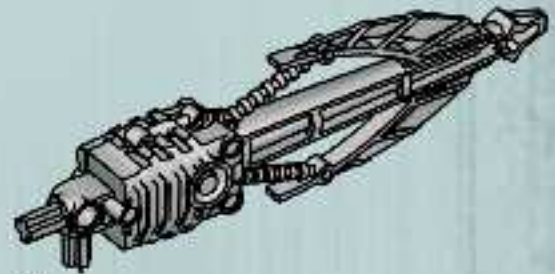

1x  
4493117



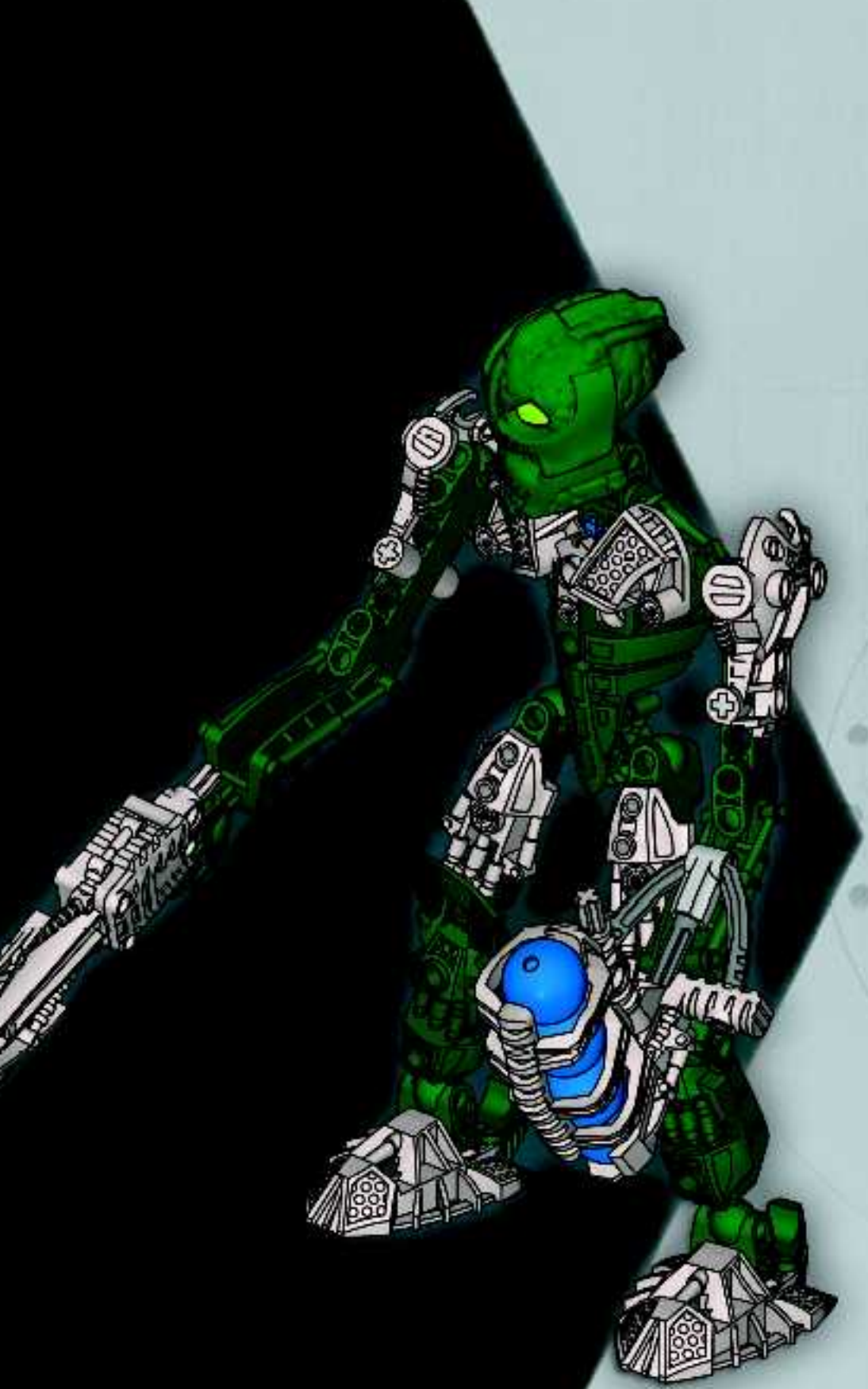

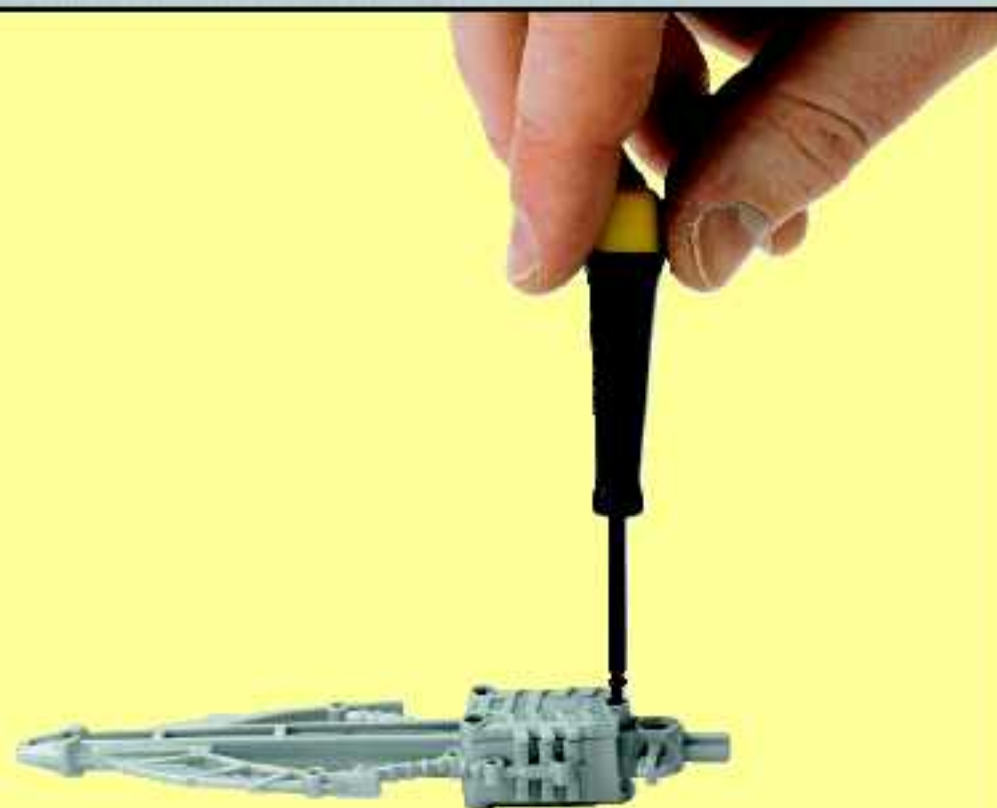
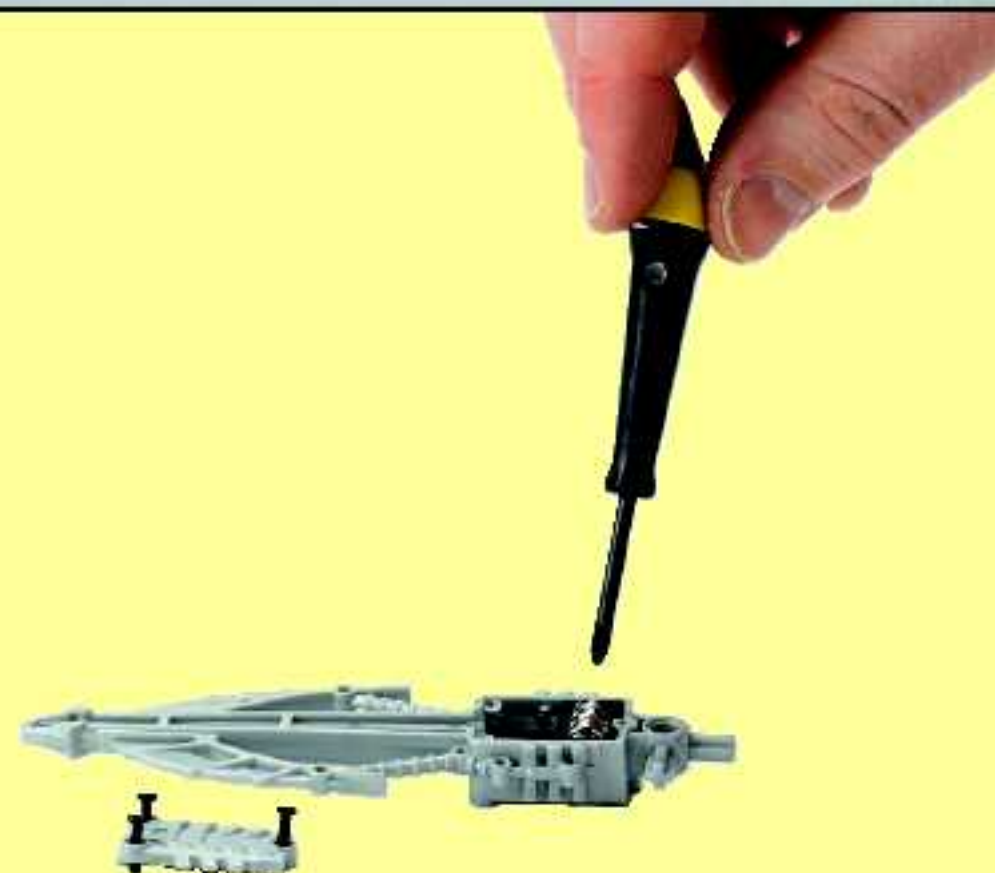

**1****2****3**

1:1  
 3X **LR 41** 1.5V

**GB****Important information about batteries**

Never use different types of batteries together, or a combination of old and new batteries. Always remove the batteries if the product is not to be used for a long time or if the batteries have run down. Never use damaged batteries. Only use batteries of the type recommended, or a corresponding type. Insert the batteries so that the poles are correctly positioned. Rechargeable batteries must be recharged using the correct battery charger under the supervision of an adult. You cannot recharge batteries while they are still in the product, and you must never try to do so. Never attempt to recharge non-rechargeable batteries. Never short-circuit the battery holder.

**ES****Importante información sobre las baterías**

No mezclar nunca diferentes tipos de baterías, ni utilizar baterías antiguas y nuevas a la vez. Sacar siempre las baterías, si el producto no se utiliza por un largo periodo de tiempo o si las baterías están descargadas. No utilizar nunca baterías dañadas. Utilizar solo el tipo de baterías recomendado o uno correspondiente. Colocar las baterías de manera que los polos estén en su posición correcta. Las baterías recargables deben cargarse con un cargador adecuado bajo la supervisión de un adulto. Las baterías no pueden, ni deben recargarse mientras permanecen en el producto. No intentar nunca recargar baterías no recargables. Asegurarse que no se produzca un cortocircuito en el porta-baterías.

**FR****Informations importantes concernant les piles**

Ne jamais utiliser un mélange de différents types de piles, ou de piles neuves et de piles anciennes ou déjà utilisées. Toujours retirer les piles si le produit n'est pas utilisé durant une période prolongée ou si les piles sont vides. Ne jamais utiliser de piles endommagées. Utiliser uniquement des piles du type recommandé ou d'un type équivalent. En insérant les piles, respecter scrupuleusement le sens d'orientation des piles (+/-). Les piles rechargeables doivent être rechargées en utilisant un chargeur de piles adéquat et sous la surveillance d'un adulte. Il est impossible de recharger les piles quand elles sont installées dans le produit. Ne jamais tenter de le faire. Ne jamais essayer de recharger des piles non-rechargeables. Ne jamais court-circuiter le compartiment des piles.





## VOYA NUI



**10 ZAMORS**

**8719**



# VOYAKU

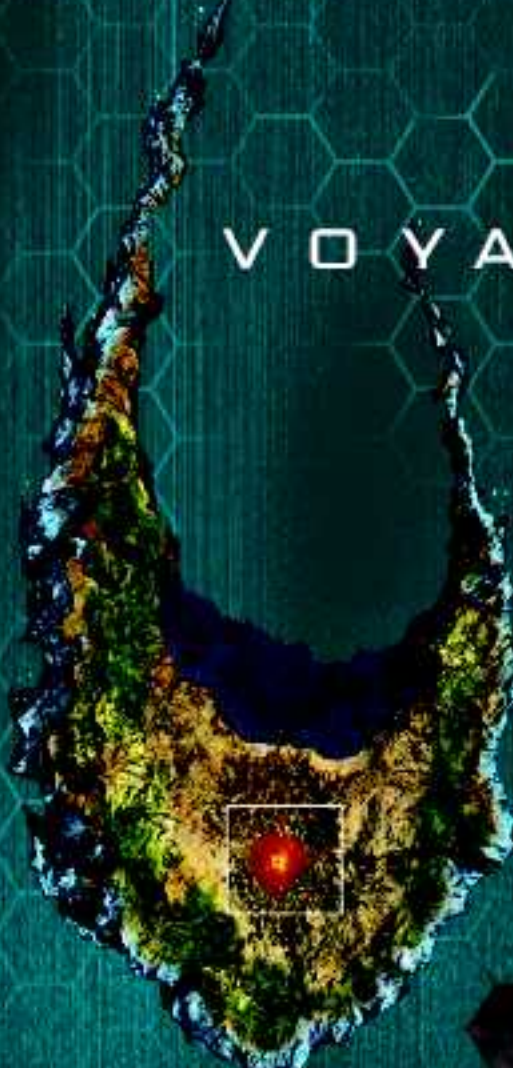

8892 PIRAKA OUTPOST



8893 LAVA CHAMBER GATE



8894 PIRAKA STRONGHOLD





AXONN  
8733





BRUTAKA  
8734





VEZON & FENBAKK  
8764



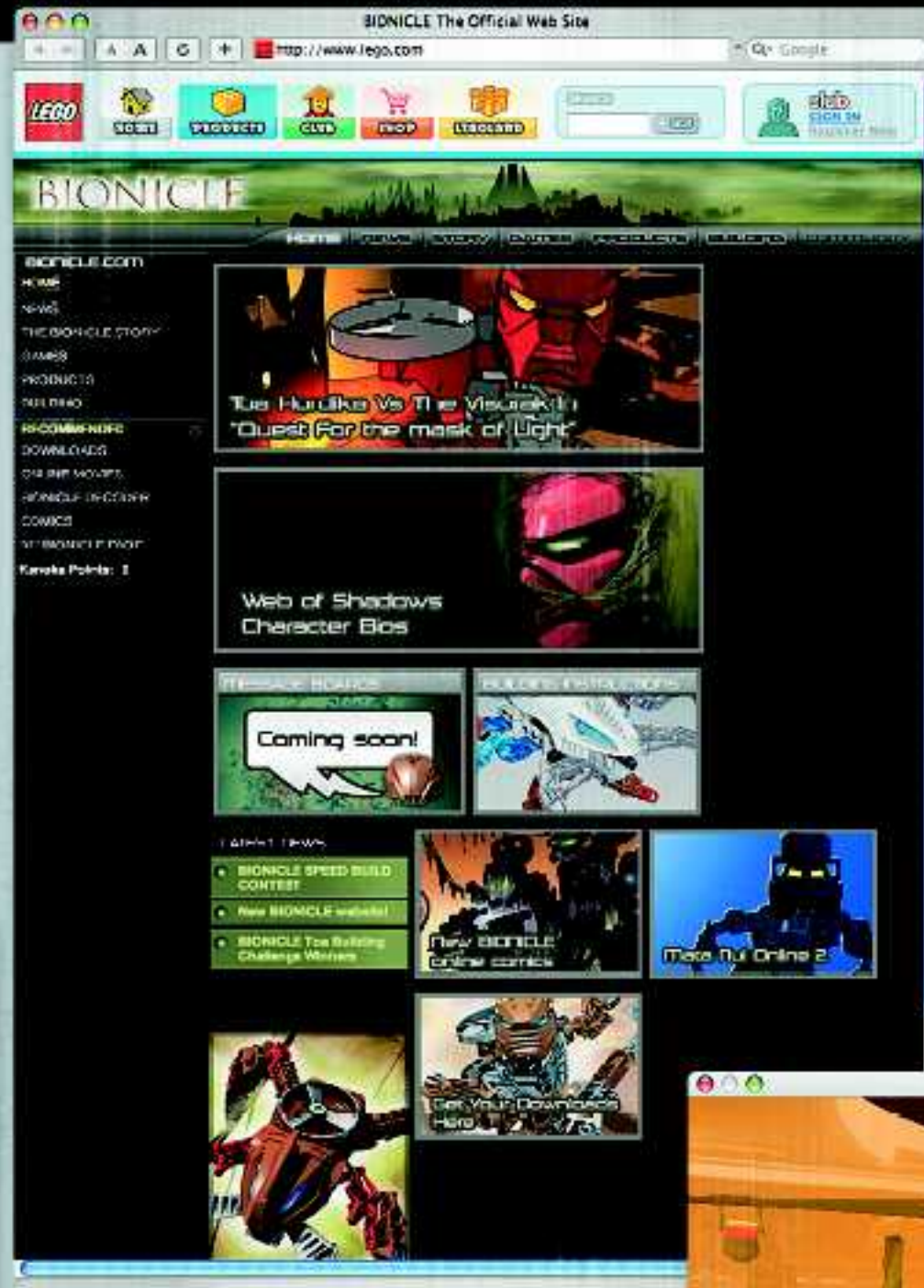
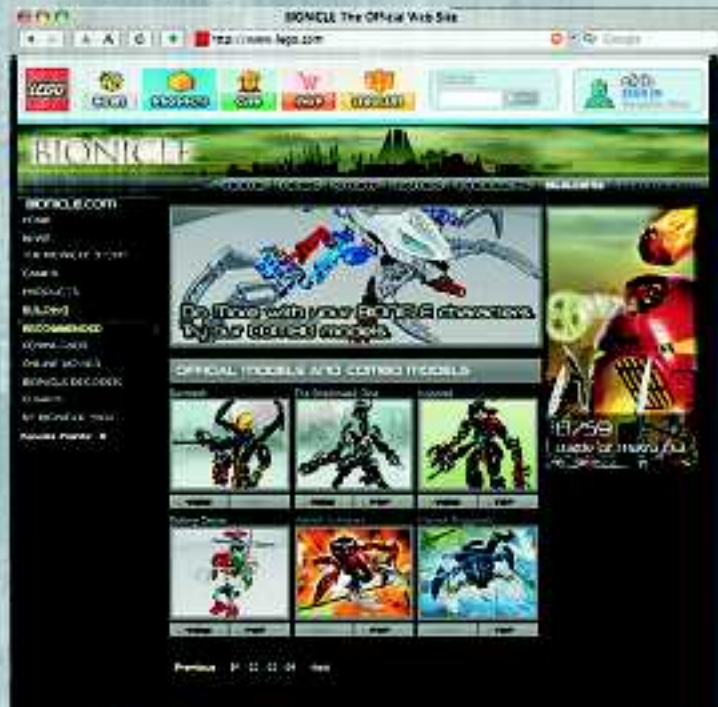

WWW.BIONICLE.COM









BIONICLE® Heroes  
The new official video game  
Coming Soon

BIONICLE® Heroes  
Das neue offizielle Videospiel  
Demnächst erhältlich.

BIONICLE® Heroes  
Le nouveau jeu vidéo officiel  
Prochainement?!

BIONICLE® Heroes  
El nuevo videojuego oficial  
Muy pronto

BIONICLE® Heroes  
O novo jogo de vídeo oficial  
A chegar brevemente

BIONICLE® Heroes  
Az új hivatalos videojáték  
hamarosan a boltokban

RATING PENDING  
**RP**  
CONTENT RATED BY  
ESRB

NINTENDO  
GAMECUBE

GAME BOY ADVANCE

PC  
DVD  
ROM

NINTENDO DS

PlayStation.2

eidos

T

BIONICLE® game software © TT Games Publishing Ltd 2006. Developed by Traveller's Tales Ltd. Published by Eidos and TT Games under license from the LEGO Group. LEGO, the LEGO logo and BIONICLE® are trademarks of the/ont des marques de commerce de/son marcas registradas de LEGO Group. ©2006 The LEGO Group. Eidos and the Eidos logo are trademarks of the SCI Entertainment Group. All rights reserved. \* \* and "PlayStation" are registered trademarks of Sony Computer Entertainment Inc. All Rights Reserved. Xbox, and the Xbox logos are either registered trademarks or trademarks of Microsoft Corporation in the United States and/or other countries and are used under license from Microsoft. All Rights Reserved. NINTENDO GAMECUBE, THE NINTENDO GAMECUBE LOGO, GAME BOY ADVANCE AND NINTENDO DS ARE TRADEMARKS OF NINTENDO.





**FREE!**

Each LEGO Magazine Features...

- Awesome creations by Kids like you!
- Cool Comics & Stories
- Building Tips & Ideas
- Special Offers & Contests to WIN Prizes!

**GRATUIT!**

Chaque Magazine LEGO offre...

- Des créations épatantes par des jeunes comme toi !
- Des bandes dessinées et des récits super cool
- Des idées de construction
- Des offres spéciales et des concours pour gagner des prix !

Join Today! Abonne-toi dès aujourd'hui !

**1-866-534-6258**

**www.LEGOclub.com**

**YES! I WANT TO JOIN THE LEGO® CLUB!**

This coupon is good for 1 **FREE** 2-year Club membership. Additional kids may sign up for \$7.95 in the US and in Canada 10.70 (including taxes).

**PLEASE PRINT IN ALL CAPITAL LETTERS**

**OUI! JOIGNEZ-MOI AU CLUB LEGO® !**

Ce coupon est valide pour 1 abonnement **GRATUIT** de 2 ans. Enfants additionnels peuvent s'inscrire pour 10,70 \$ (taxes incluses).

**S.V.P. IMPRIMER EN LETTRES MAJUSCULES.**

**BIC26**

Name/Nom \_\_\_\_\_ Age \_\_\_\_\_

Français  English

Address/Adresse \_\_\_\_\_

Girl/Fille  Boy/Garçon

City/Ville \_\_\_\_\_ State/Prov. \_\_\_\_\_ Postal Code \_\_\_\_\_

E-mail Address/Courriel \_\_\_\_\_ Date of Birth \_\_\_\_\_

Date de Naissance \_\_\_\_/\_\_\_\_/\_\_\_\_  
M D/J Y/A

Parent's Signature/Signature d'un parent \_\_\_\_\_

Mail to/Poster à:  
**LEGO Club**  
**P. O. Box 1157**  
**Enfield, CT 06083-1157**



Offer limited to residents of US and Canada. No photocopies will be accepted. Offer limited to two free memberships per family, group or organization. Please allow 4-6 weeks for delivery of your first mailing.

Offre limitée pour résidents du US et Canada. Photocopies ne seront pas acceptées. Offrir limitée à deux abonnements gratuits par famille, groupe, ou organisation. Allouez 4-6 semaines pour la première livraison.







# SHOP(at)HOME

## The World's Biggest LEGO® Shop!



Any questions regarding your new LEGO product, please contact:  
Customer Service |

Service Consommateurs | Servicio :



1-800-422-5346

or

[www.lego.com/service](http://www.lego.com/service)

For a Free Catalog in the U.S.  
and Canada, call toll-free:  
1-866-534-6737

Or go online:  
[www.LEGOshop.com/catalog](http://www.LEGOshop.com/catalog)

Pour obtenir un Catalogue GRATUIT  
aux États-Unis et au Canada,  
téléphonez sans frais au :  
1-866-534-6737

Ou venez en ligne sur :  
[www.LEGOshop.com/catalog](http://www.LEGOshop.com/catalog)

### FREE LEGO® Catalog!

Please print with a pen in capital letters.

First Name / Prénom \_\_\_\_\_

Last Name / Nom \_\_\_\_\_

Address / Adresse \_\_\_\_\_

City / Ville \_\_\_\_\_ State / Prov \_\_\_\_\_ Zip Code / Code Postal \_\_\_\_\_

Phone (optional) / No de téléphone (optionnel) \_\_\_\_\_

Email (optional) / Courriel (optionnel) \_\_\_\_\_

Check Below / Indiquer ci-bas

- I speak English     Je parle Français     Boy/Garçon     Girl/Fille

### Catalogue LEGO® Gratuit!

S.V.P. Écrire en lettres majuscules avec un stylo à bille noir.

Mail to/Poster à: **CRBP26**



P. O. Box 1221  
Enfield, CT 06083-1221



Please allow 2-4 weeks for delivery.  
Veuillez s.v.p. allouer 2 à 4 semaines pour l'expédition.

U.S. and Canada only  
É.-U. et Canada seulement



BIONICLE

# INOKA

TGA MOPARU  
8728

TGA JALLER  
8727

TGA HARLI  
8729

TGA KONGU  
8731

TGA MATARO  
8732

TGA HEWKII  
8730

©2006 The LEGO Group - 4493608

LEGO