



CITY

60050



 [LEGO.com/city](https://www.lego.com/city)

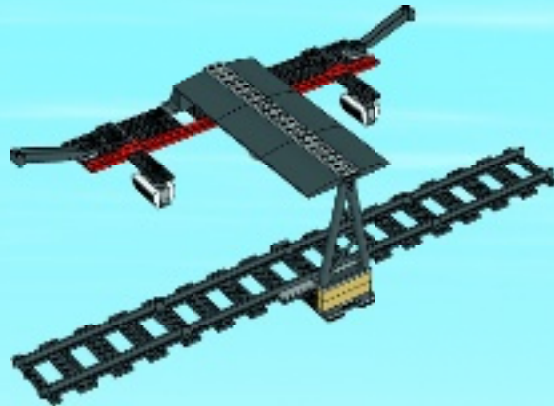
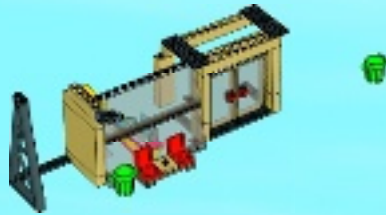
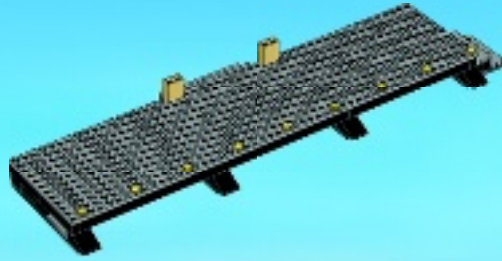

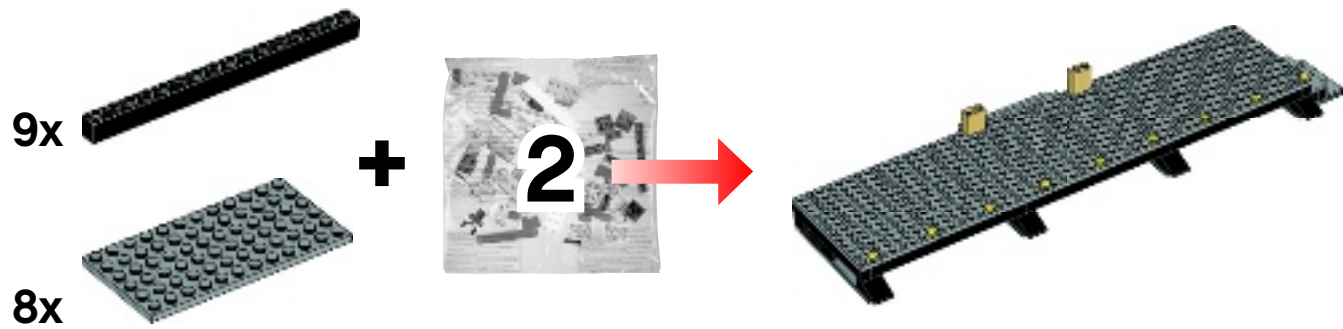

1

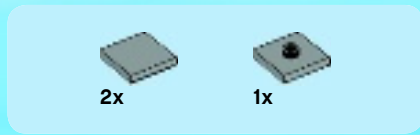

2

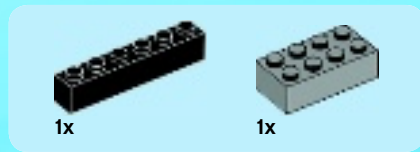

3

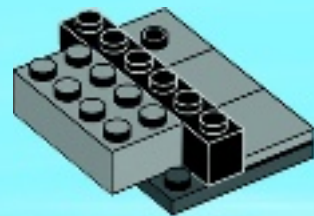



2x

4

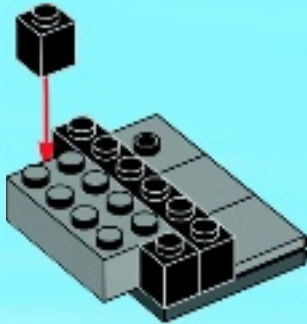

2x



1x

5

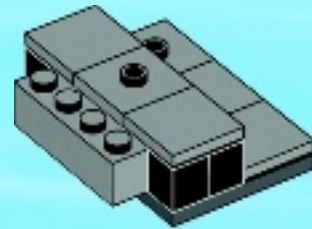

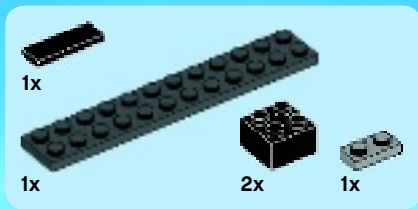

6

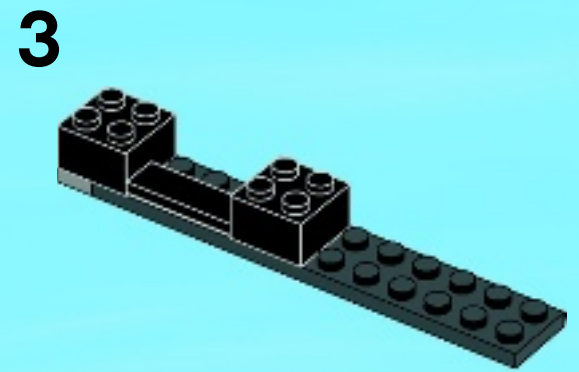
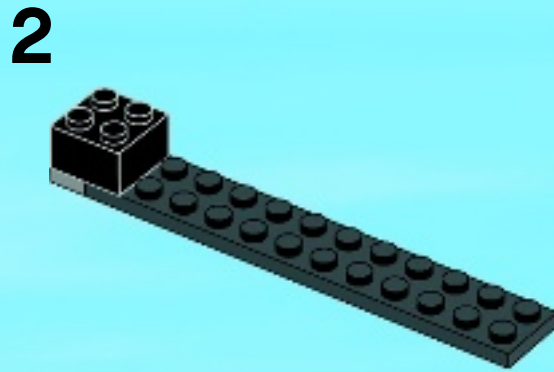
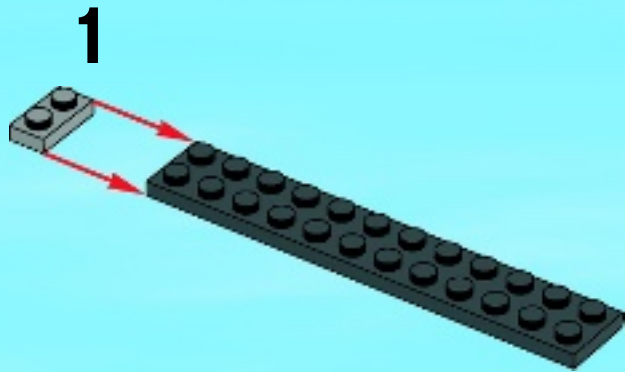



1x

7

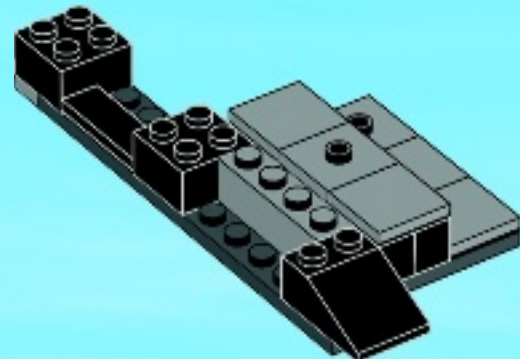
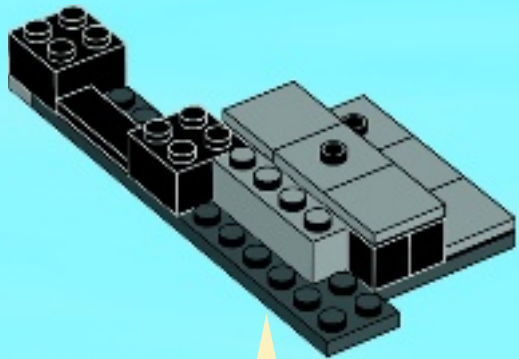

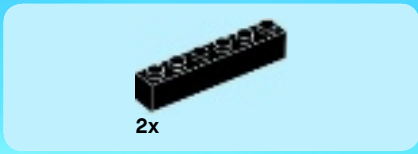

8

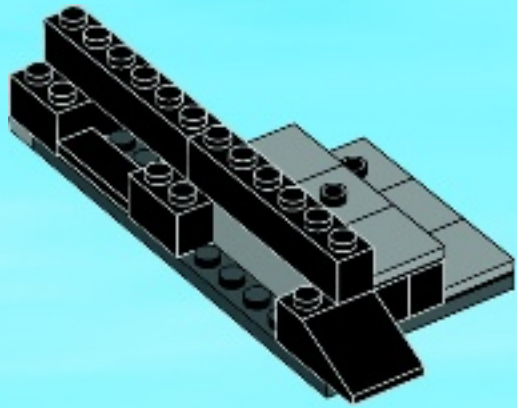

9

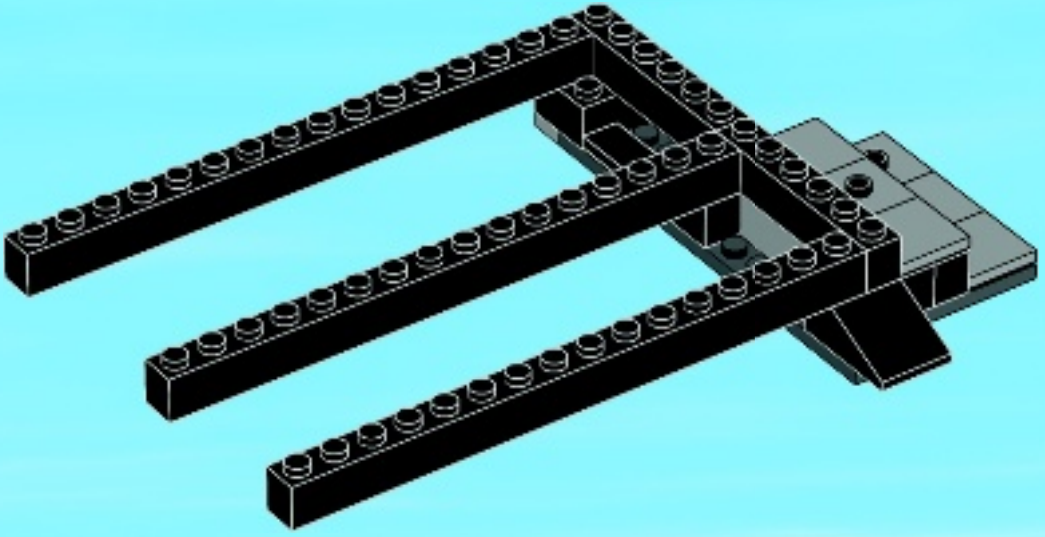

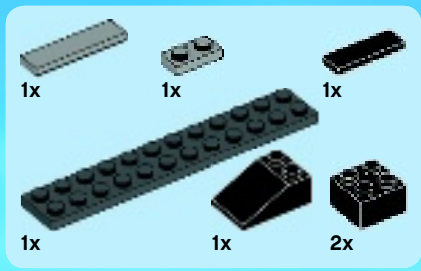

10

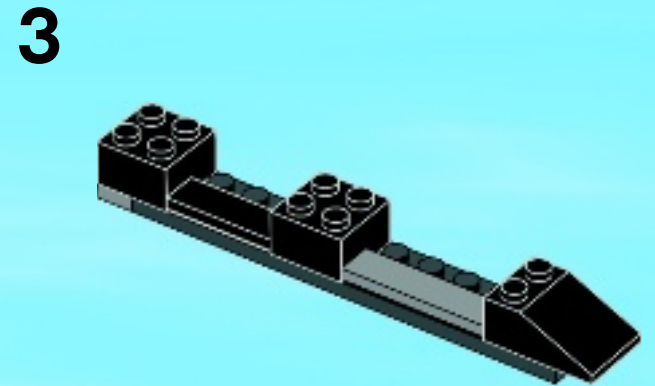
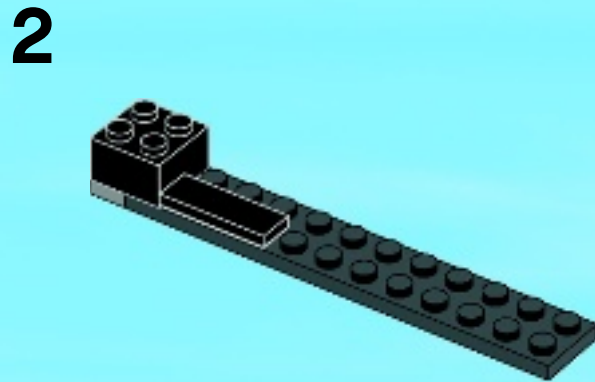
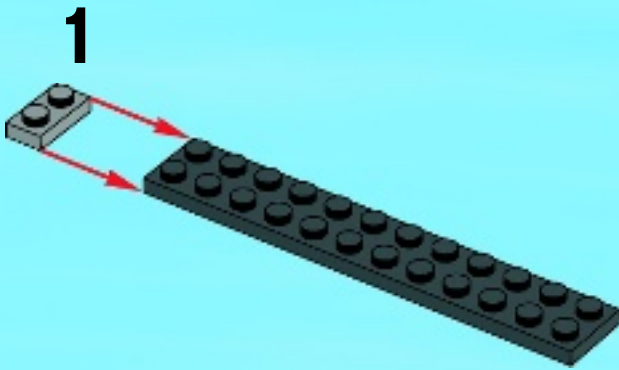

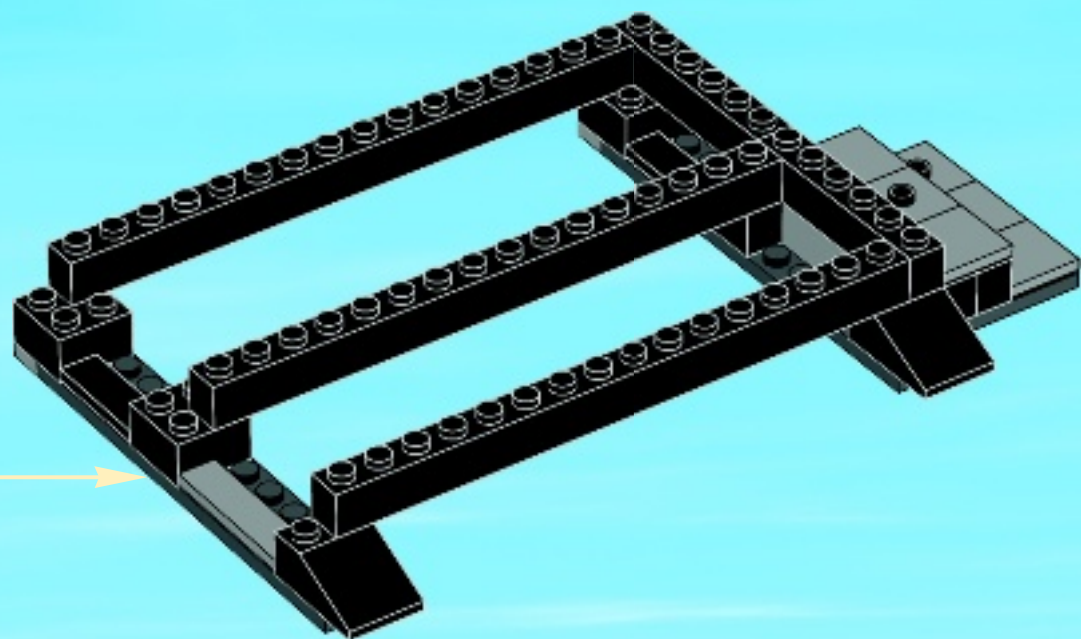



11

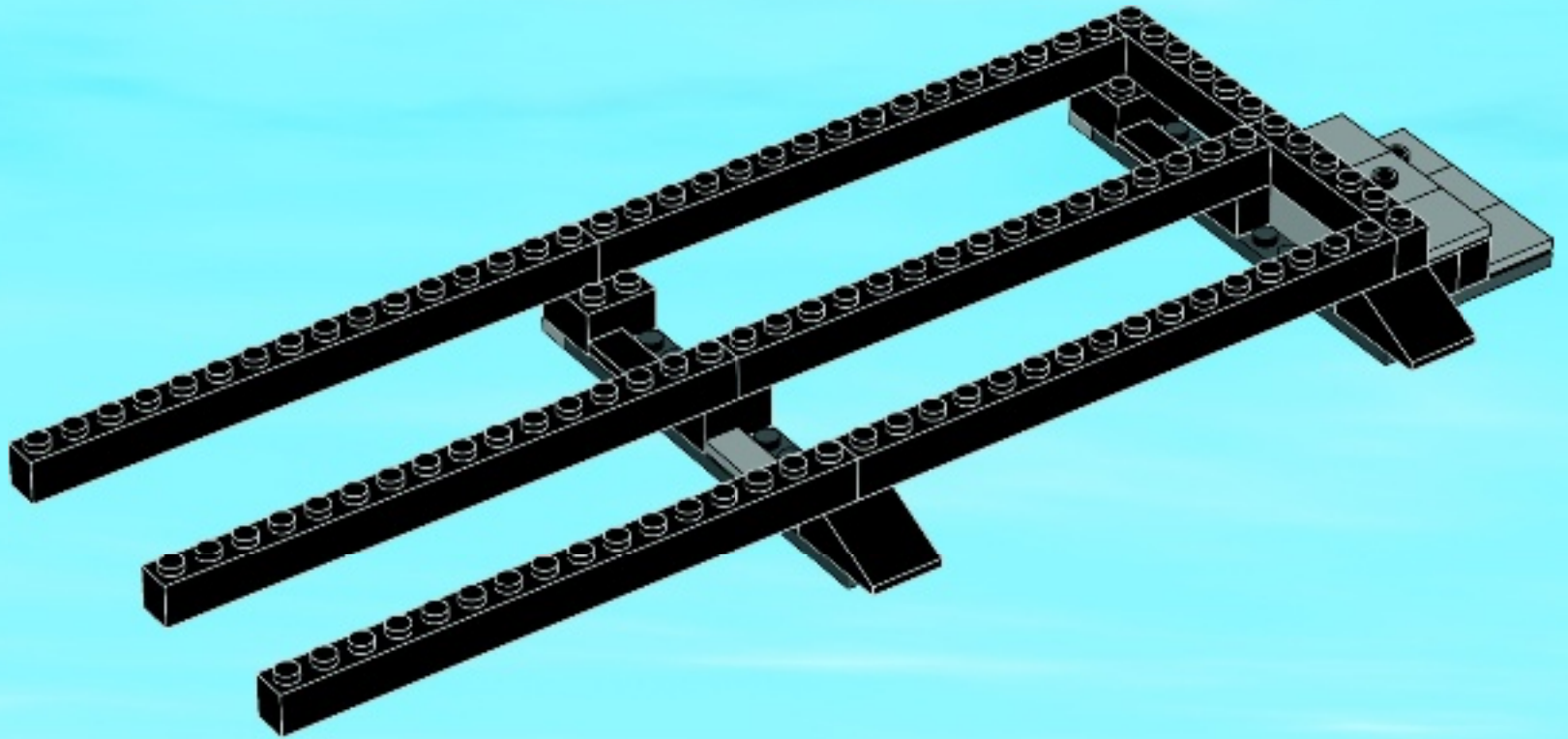

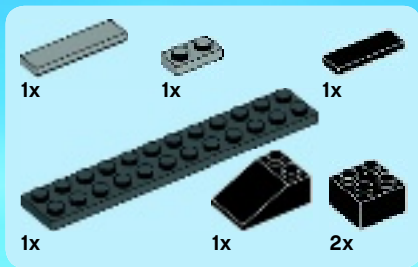

12

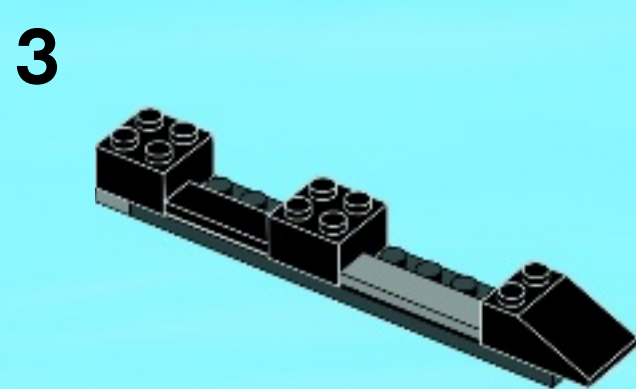
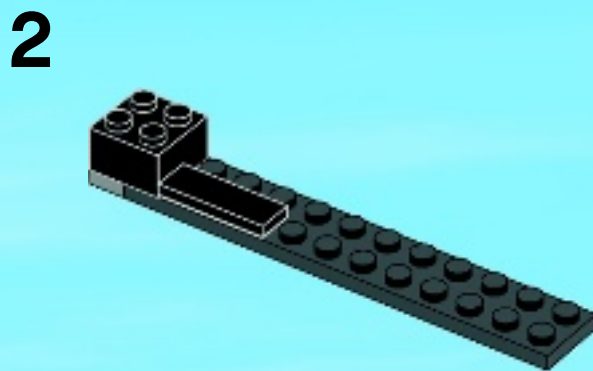
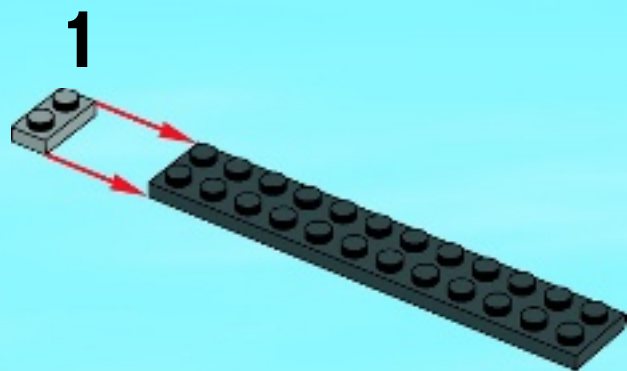

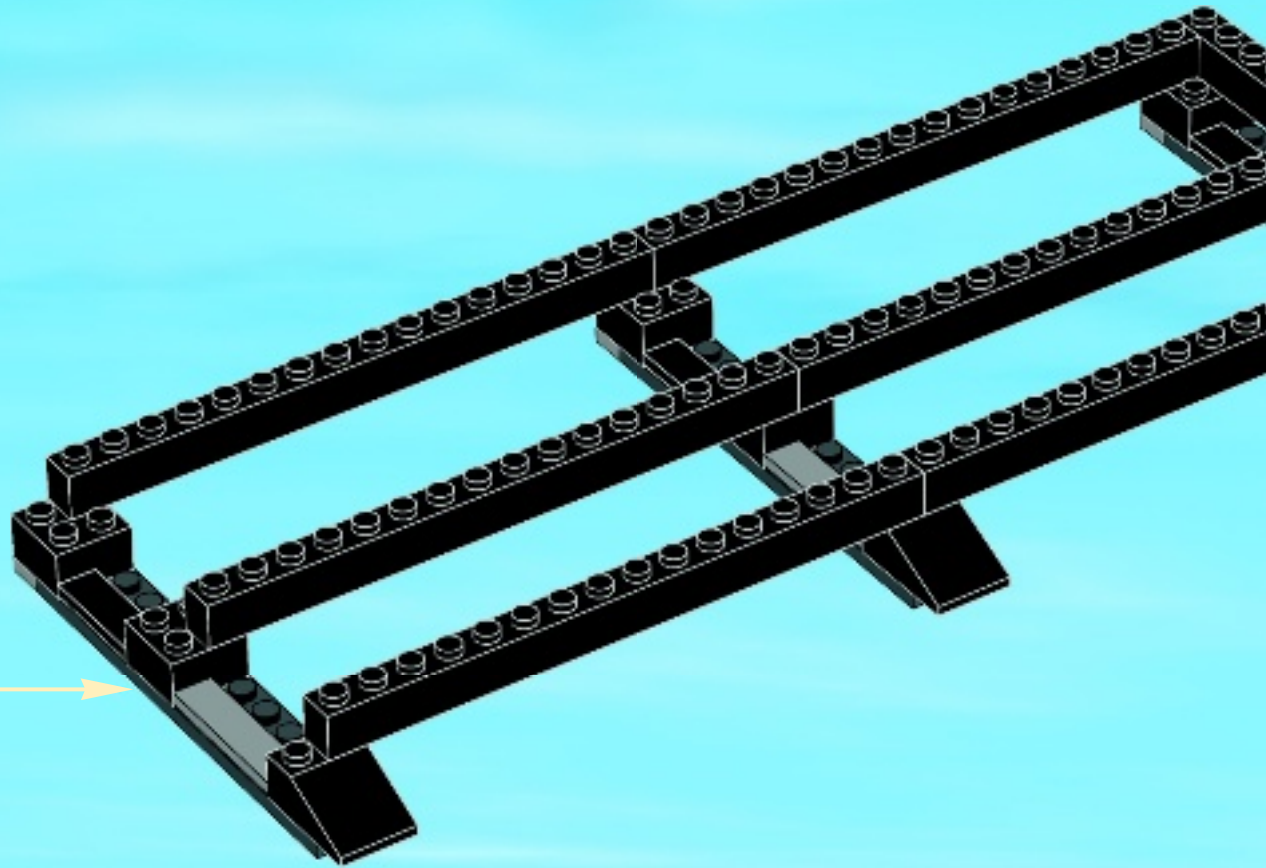



13

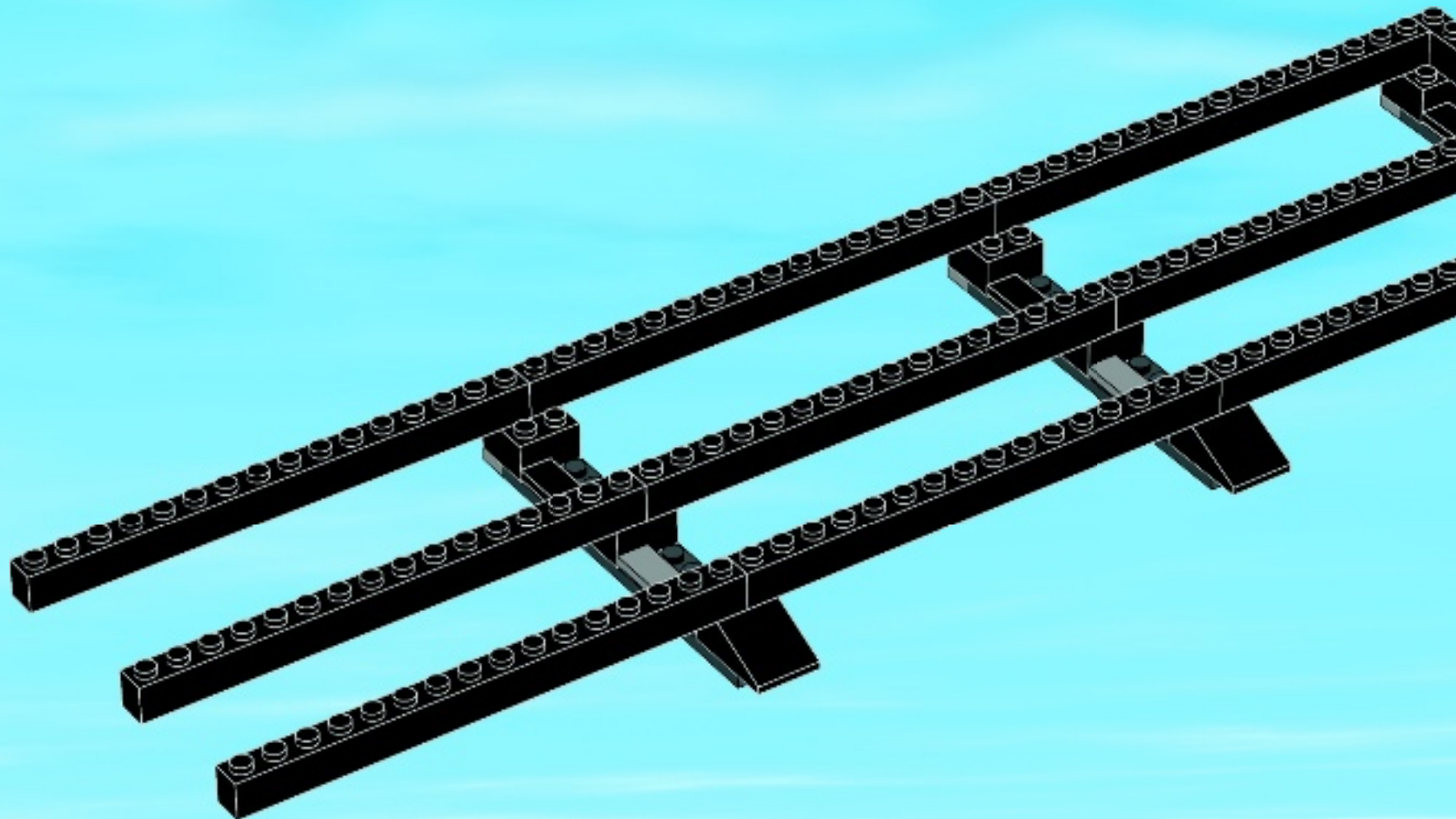

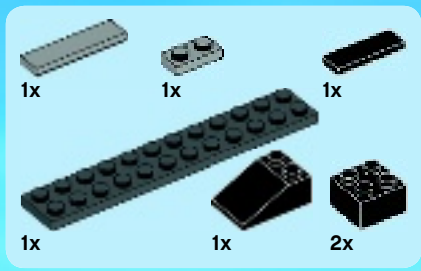

14

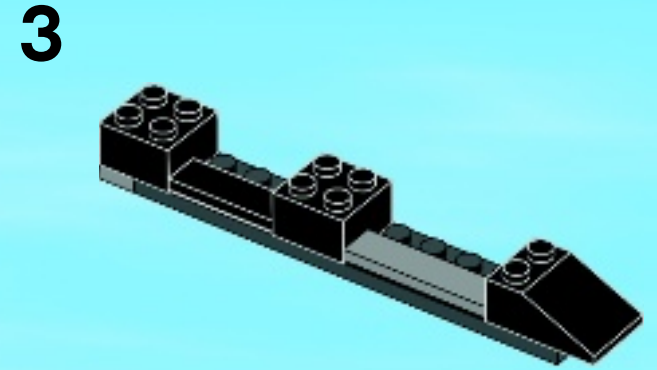
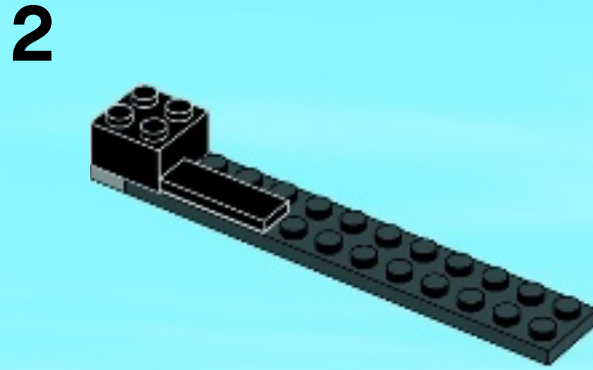
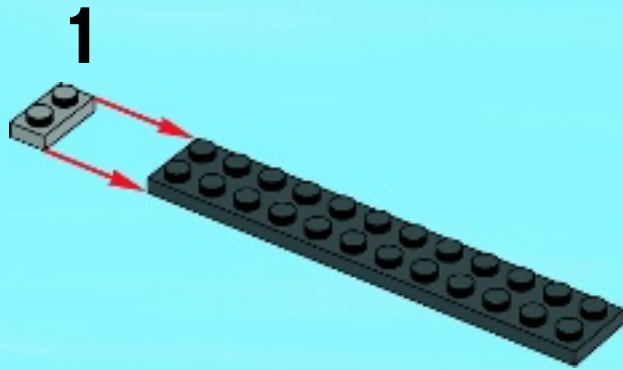

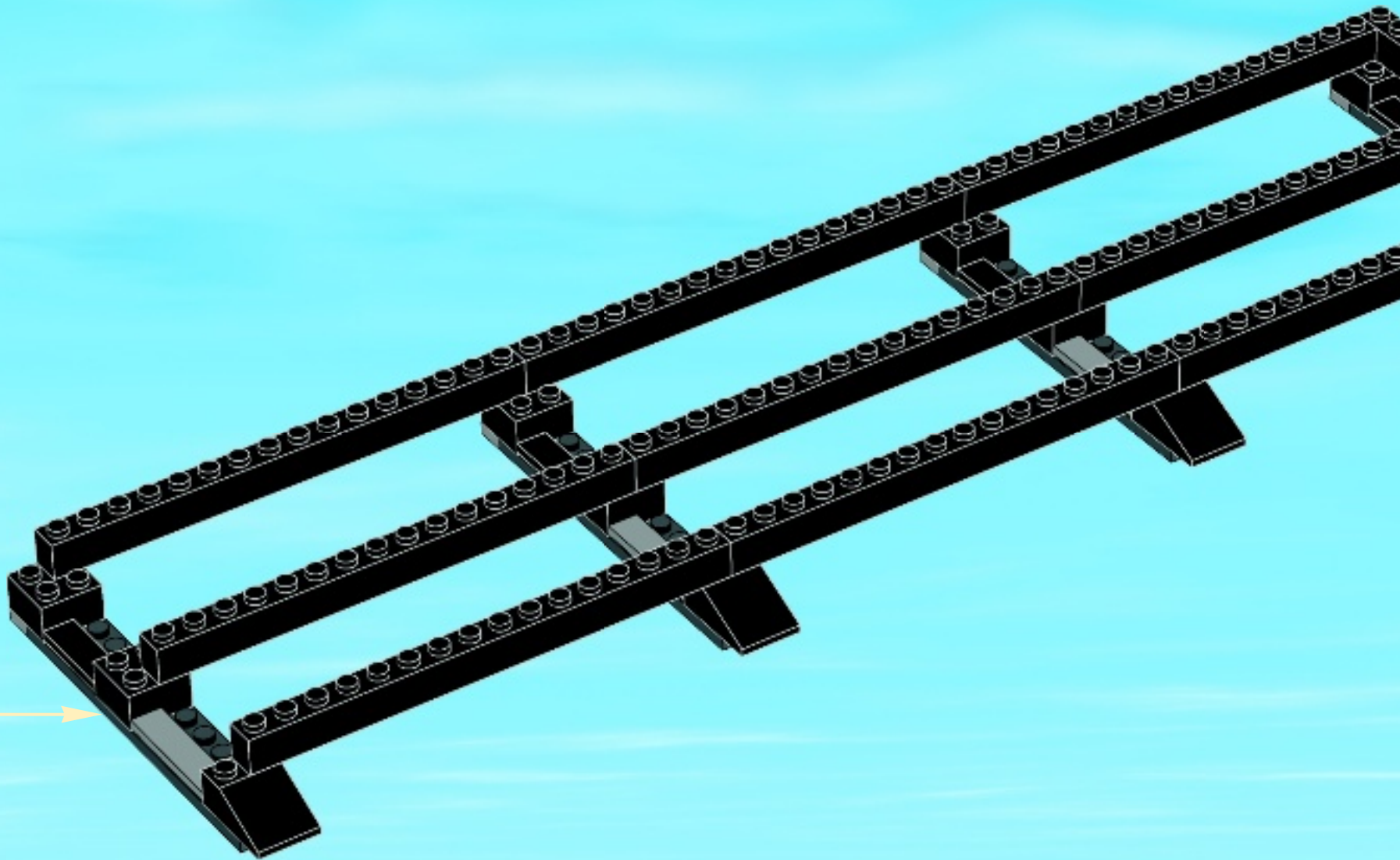



15

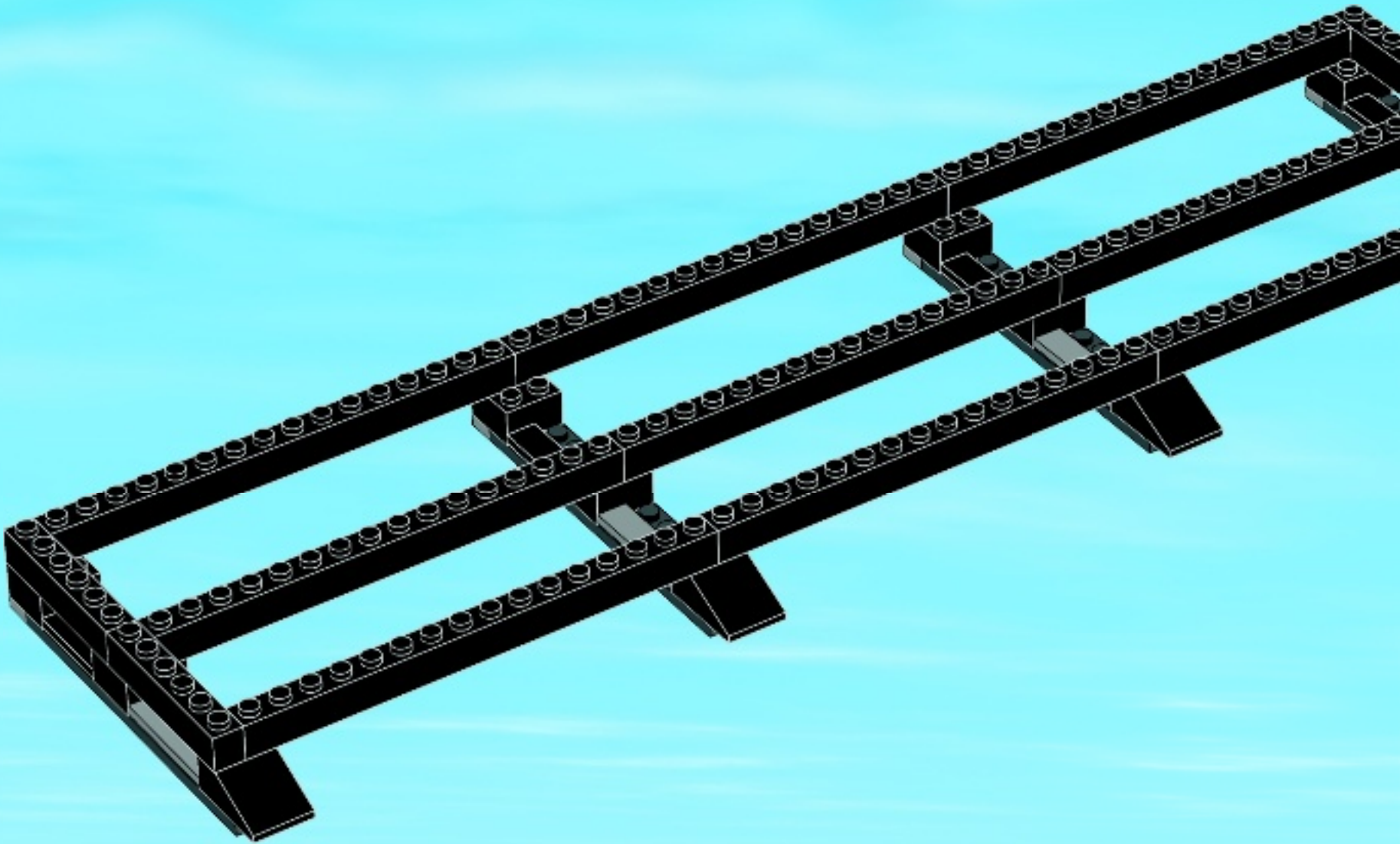

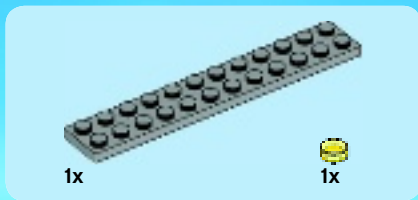

16

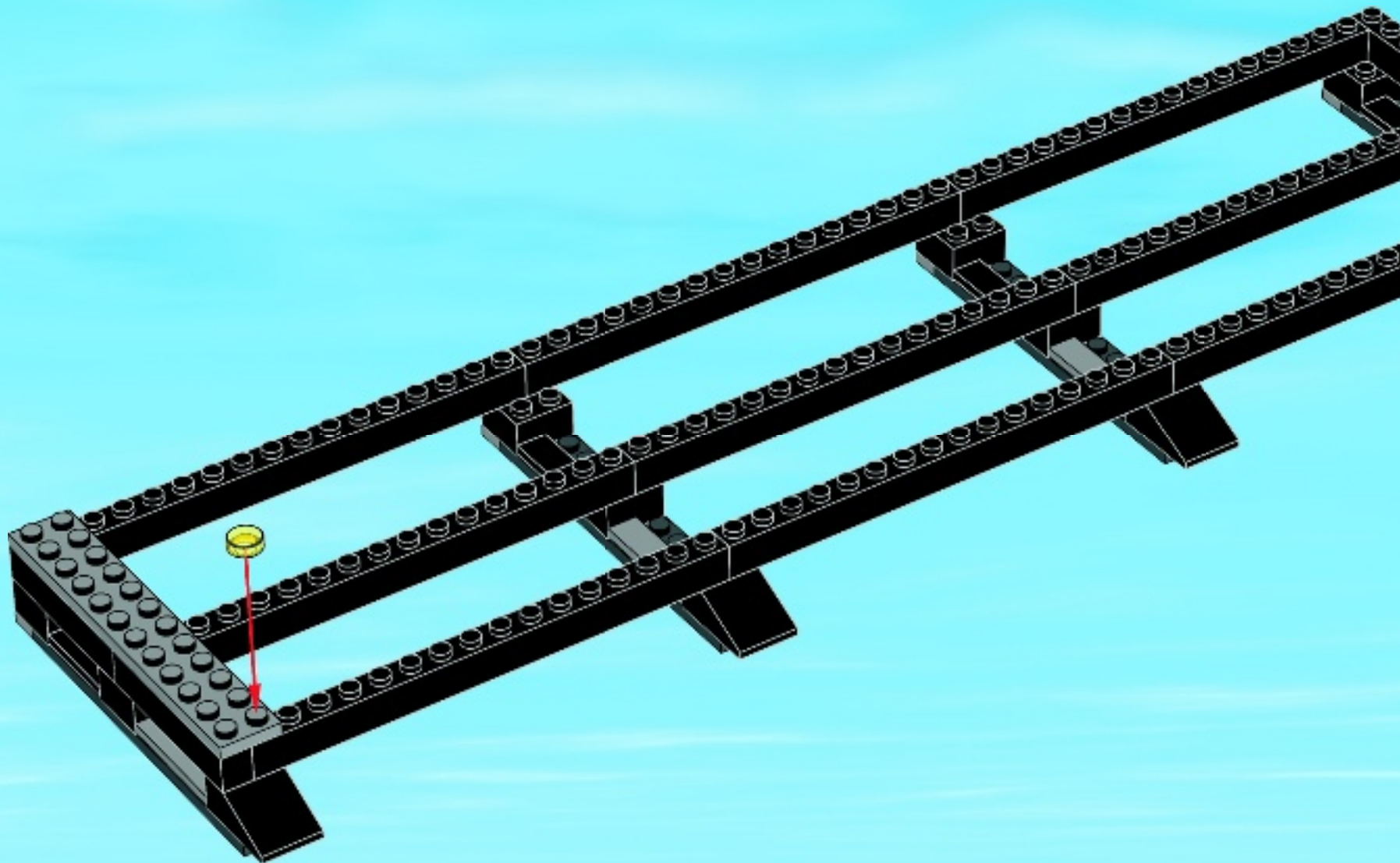

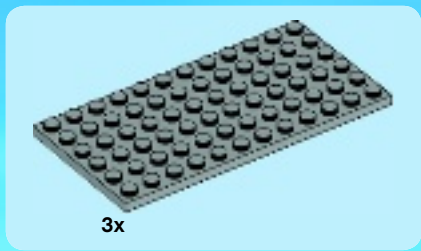

17

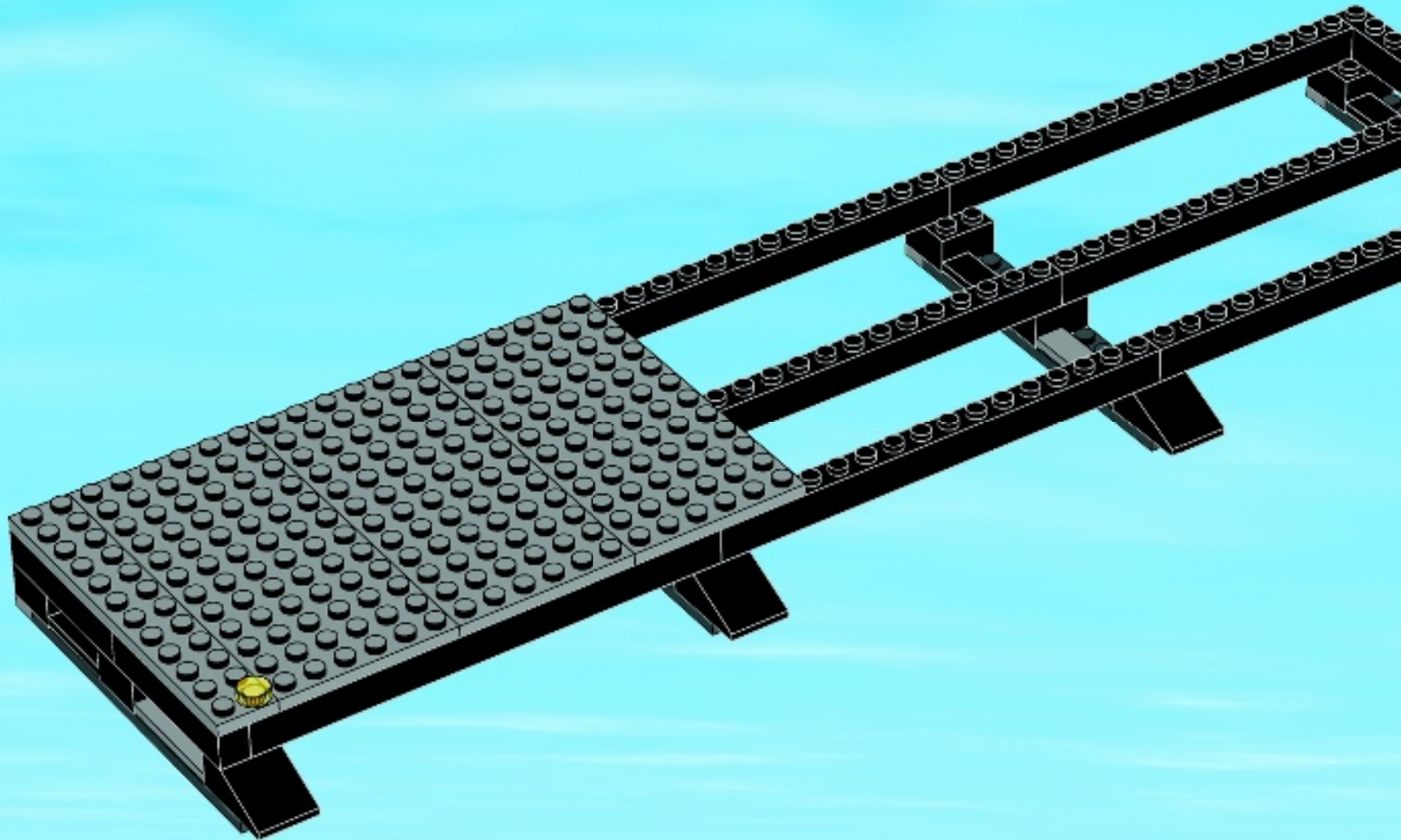



1x



3x

18

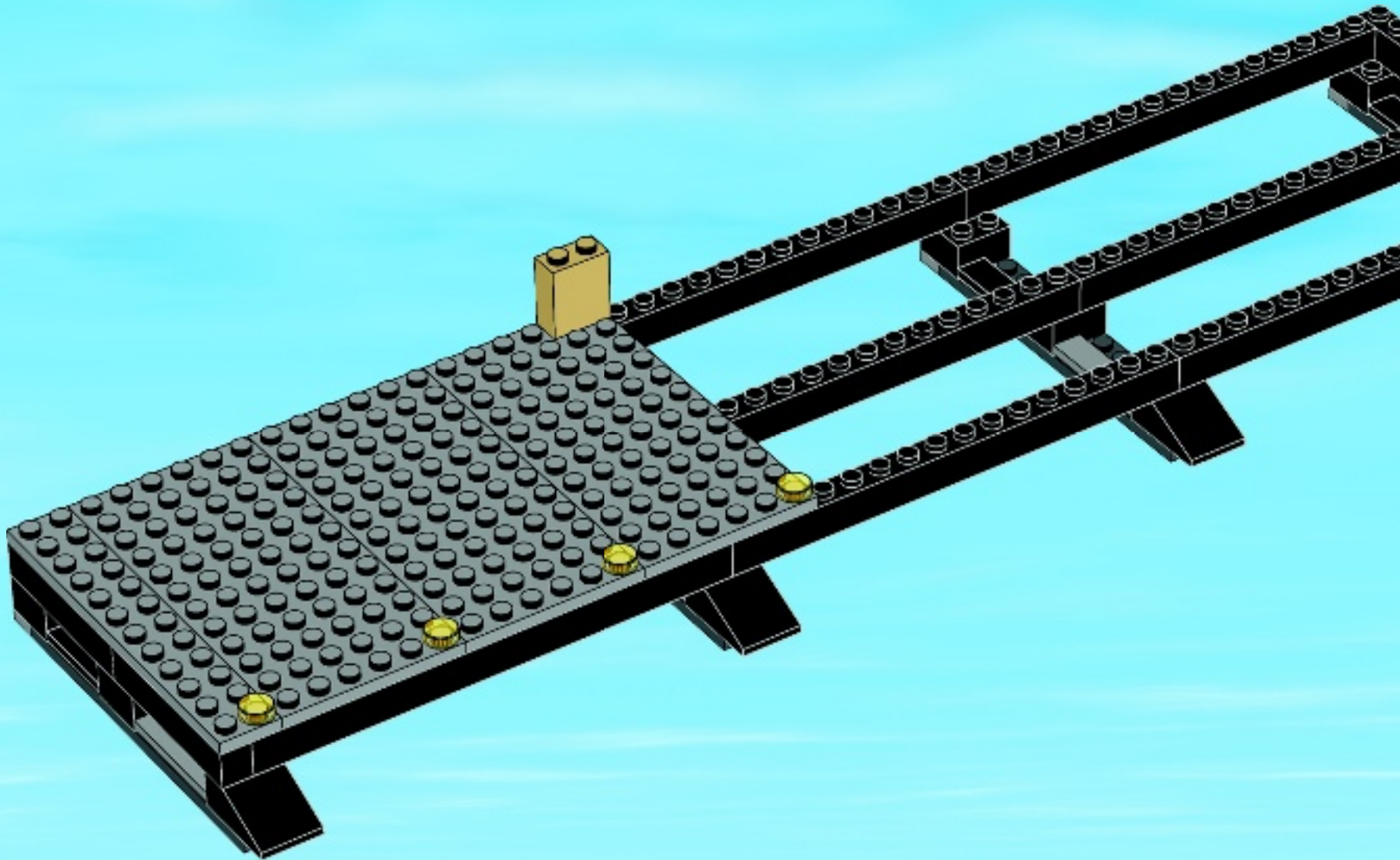

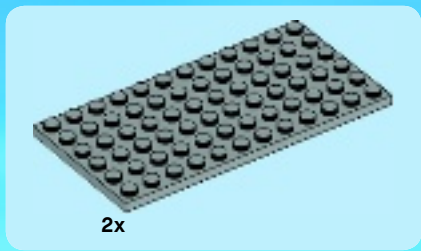

19

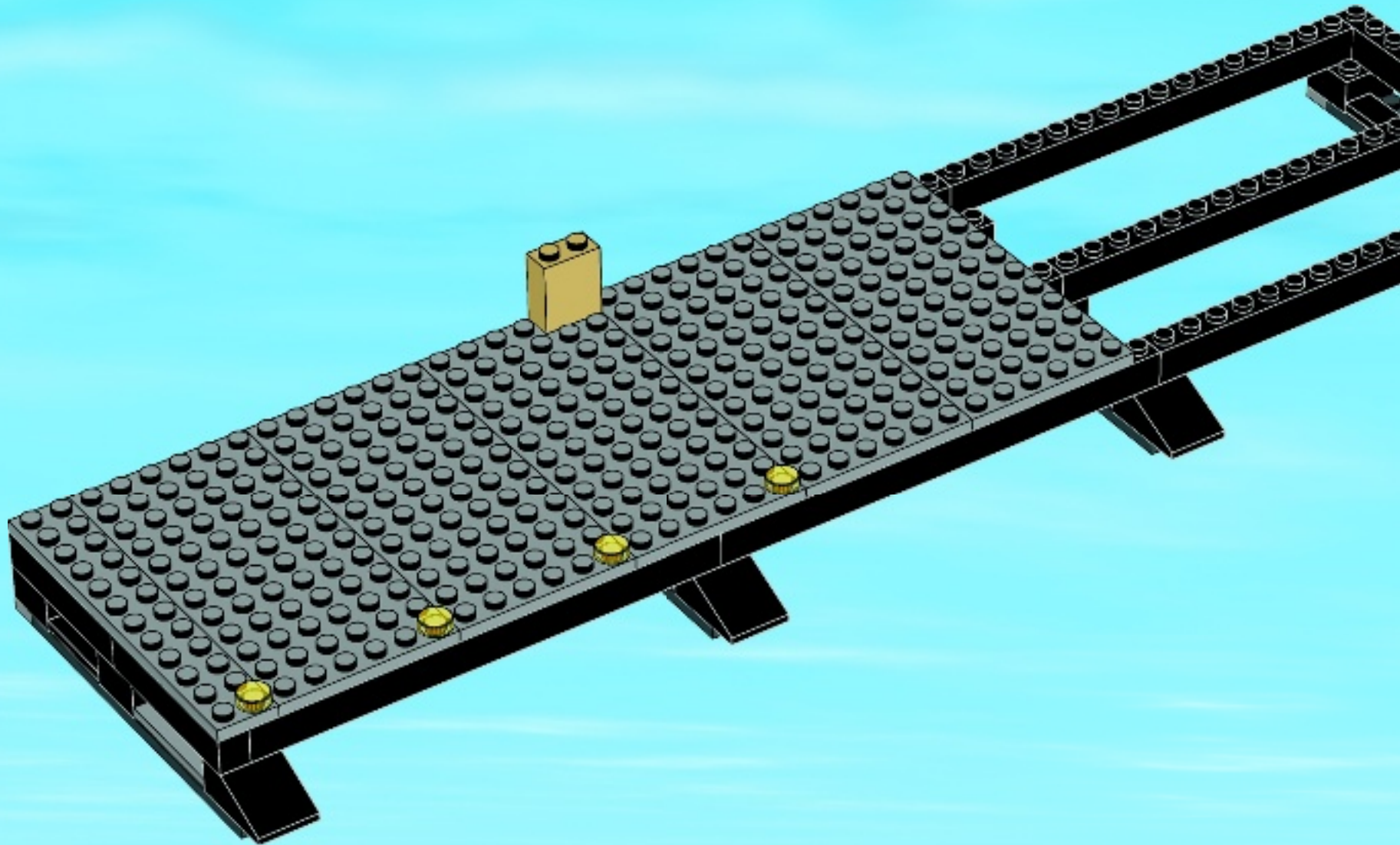



1x



2x

20

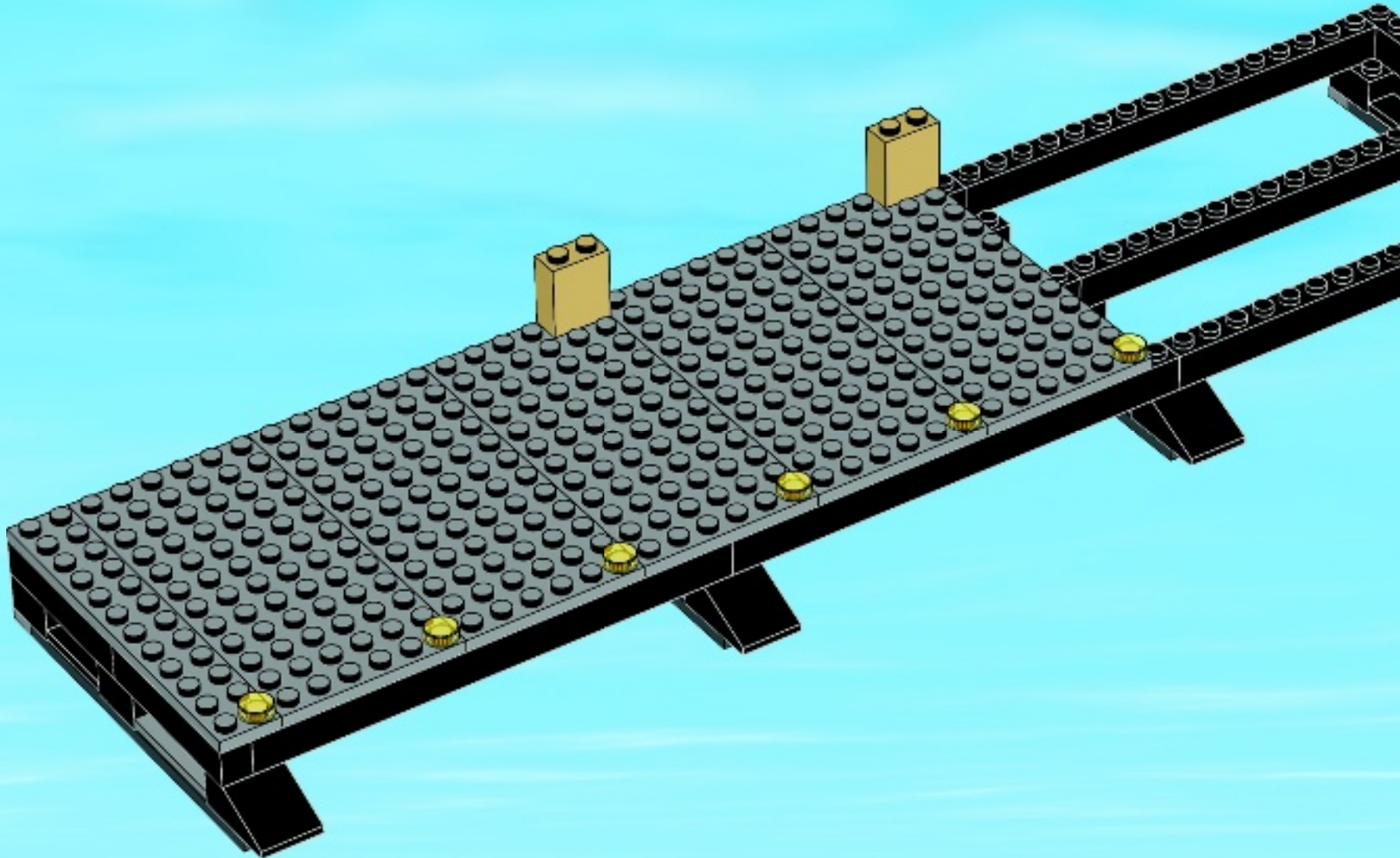

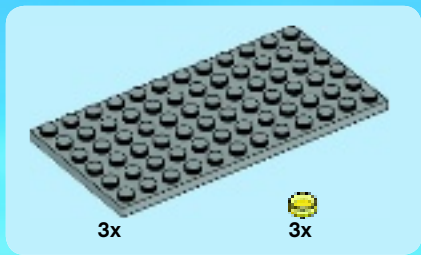

21

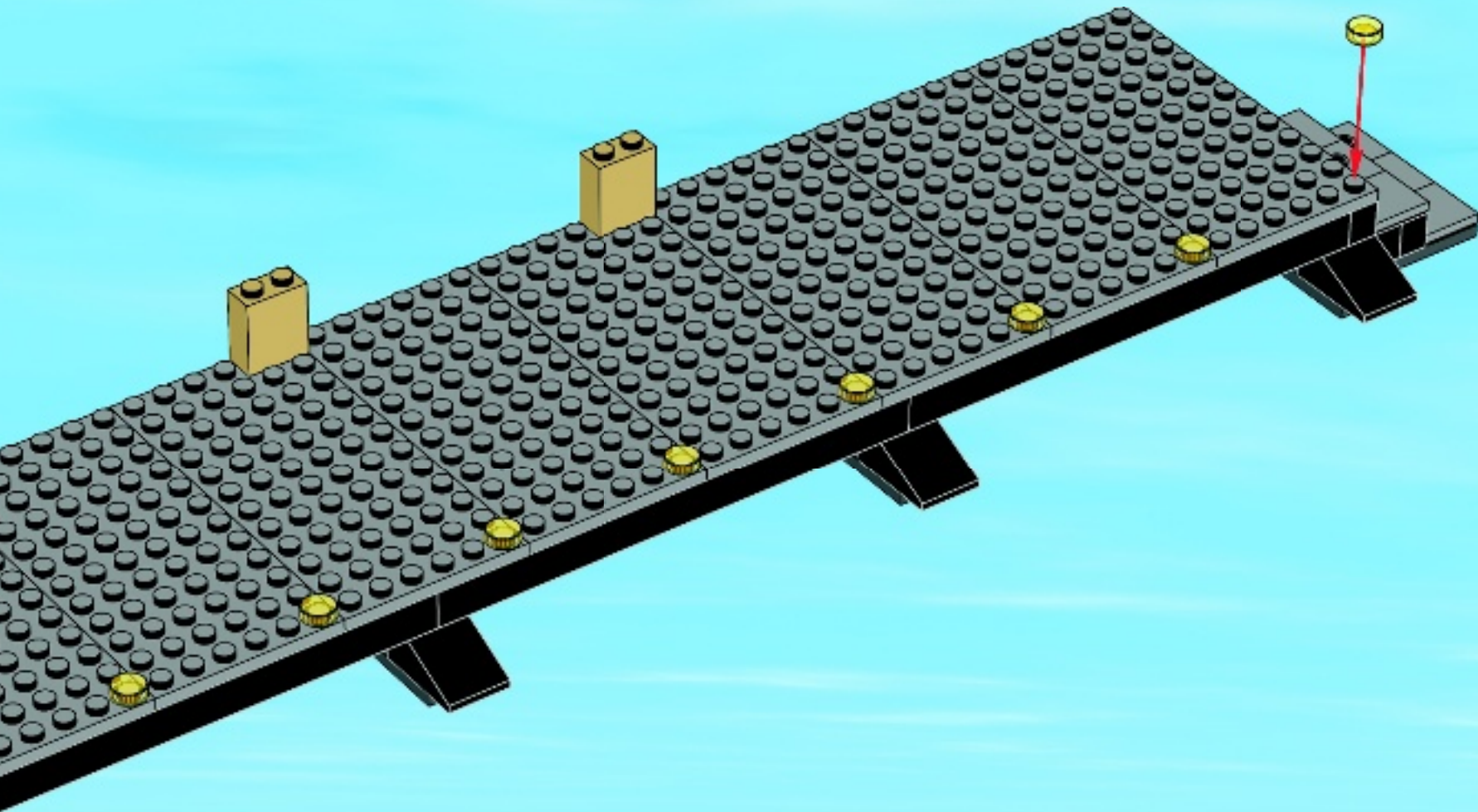

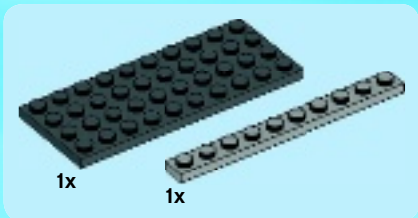

1

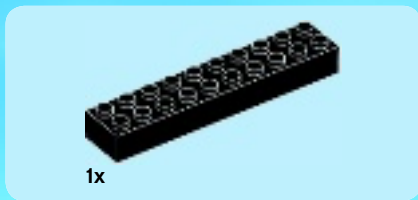
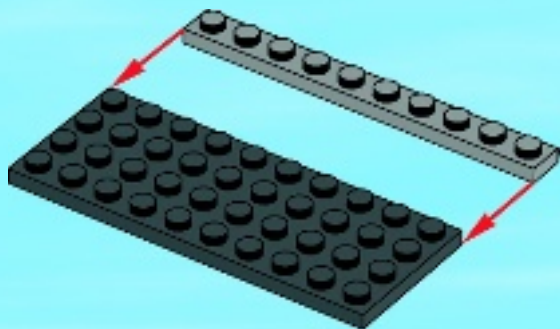

2

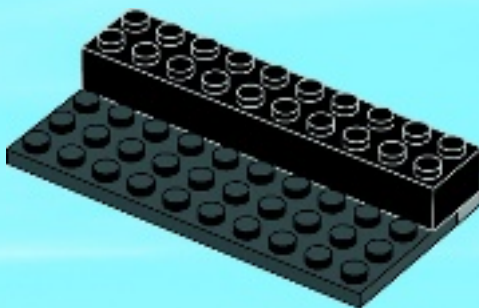

3

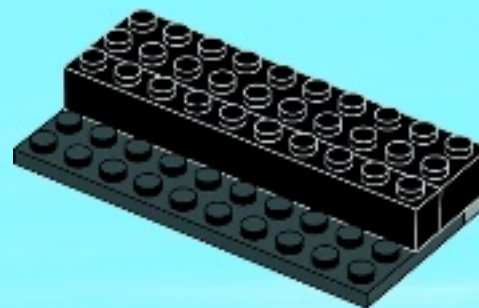



4x



1x

4

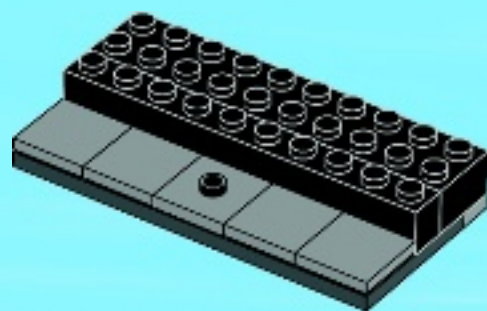

3x



2x

5

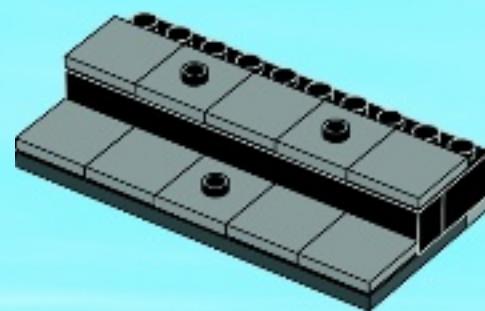

22

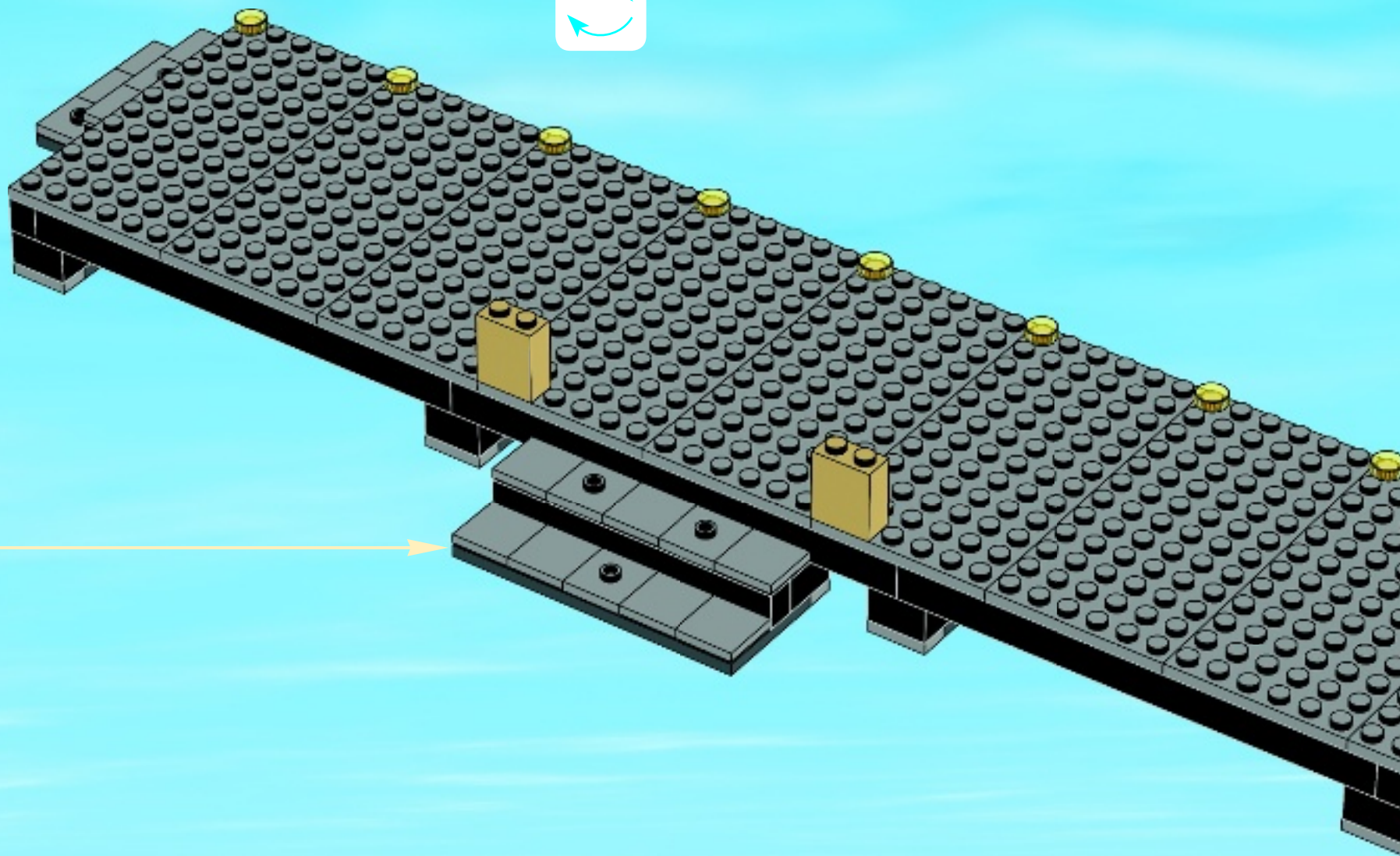

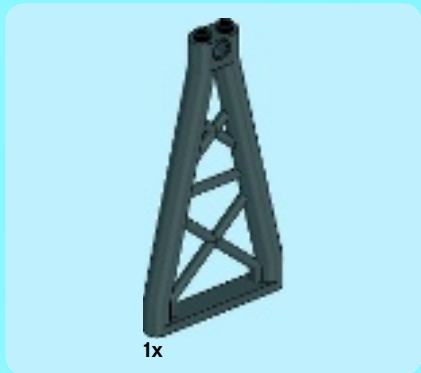
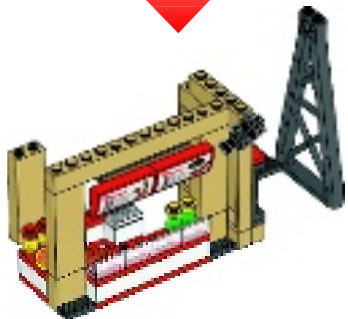

23

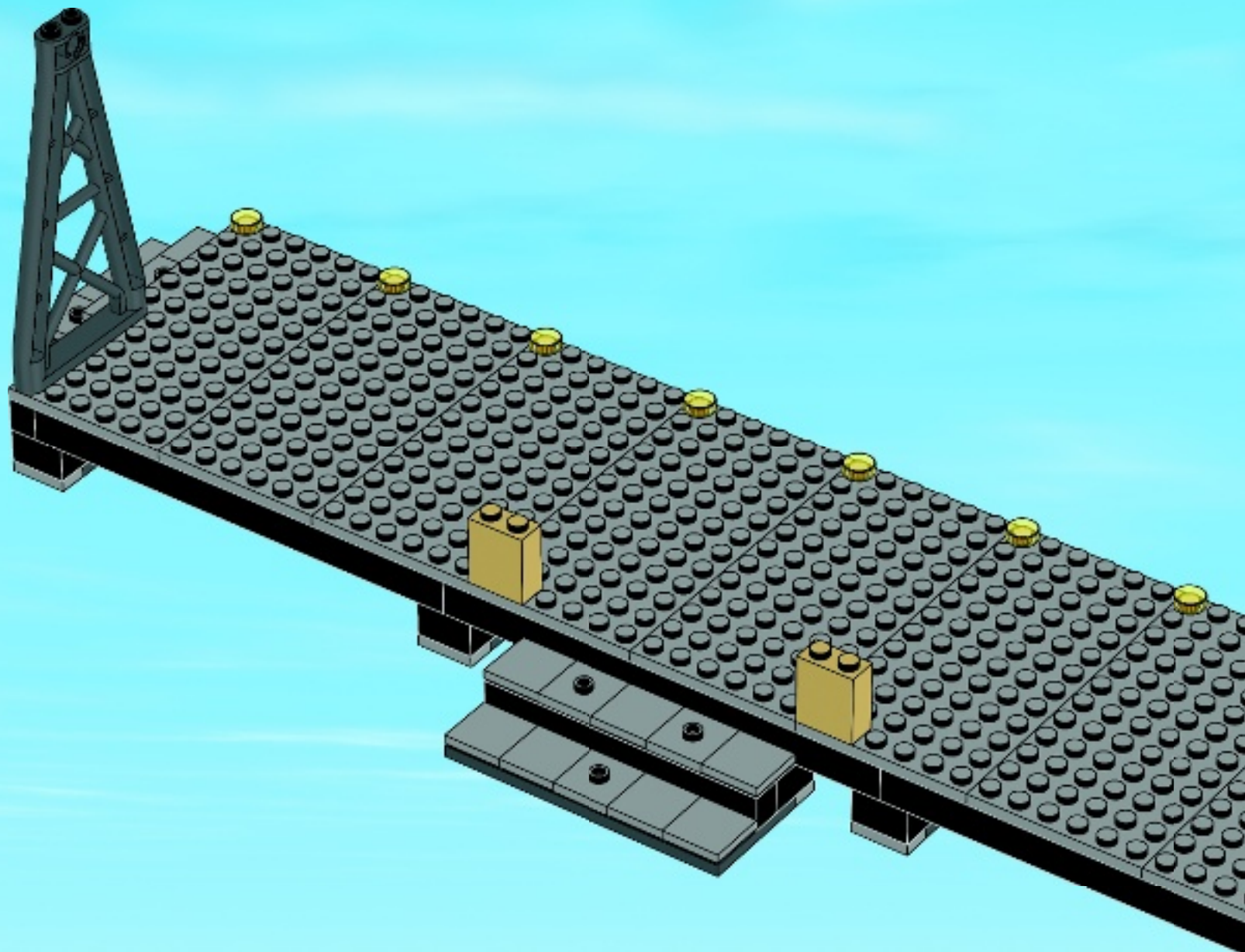



2x

24

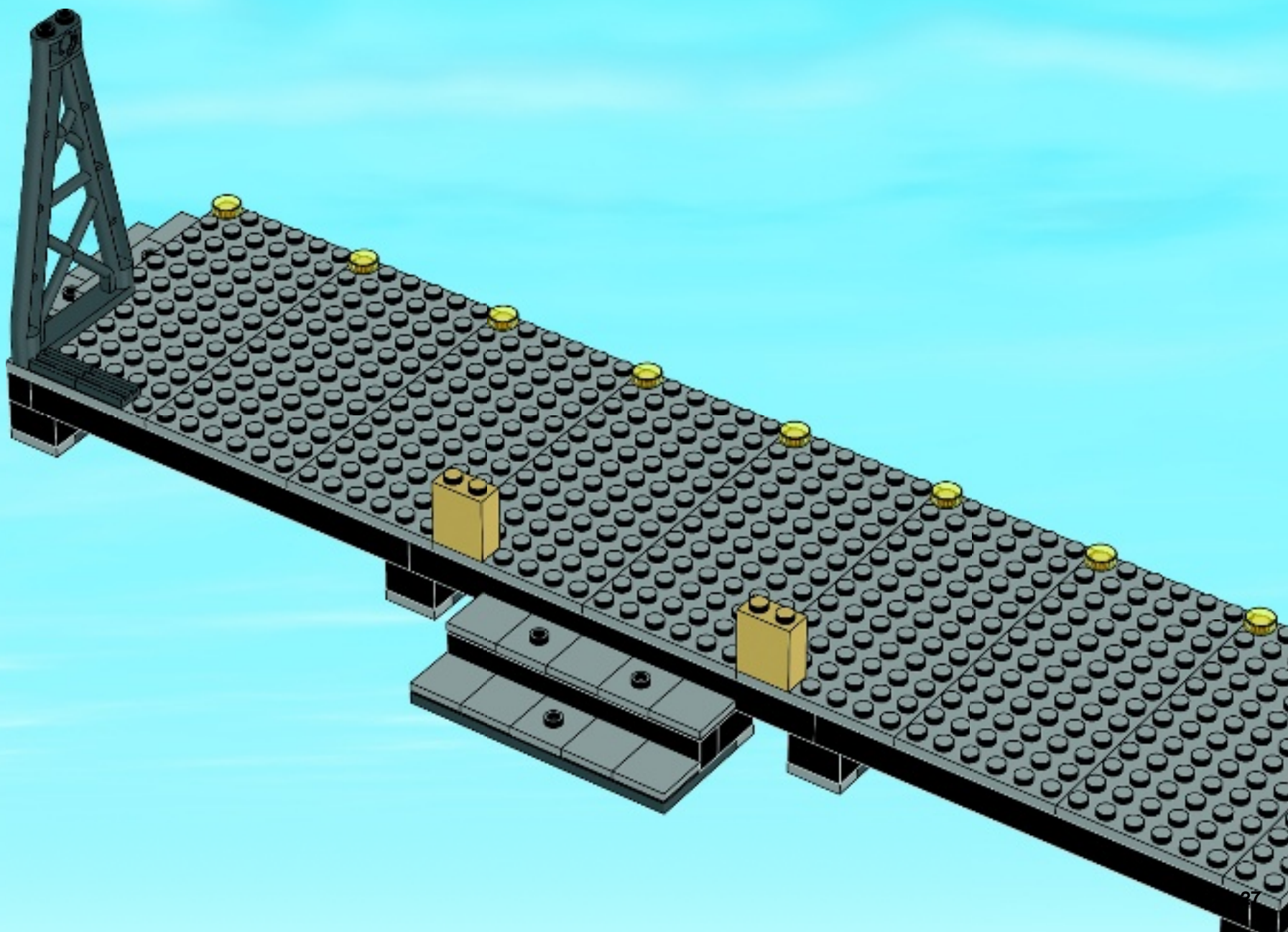

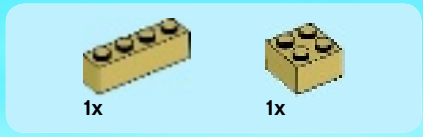

1

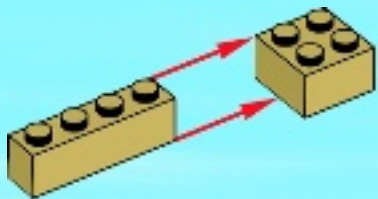

2

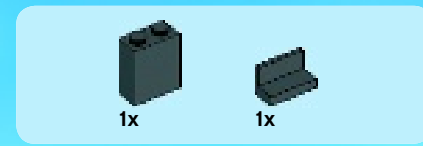
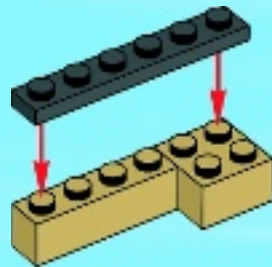

3

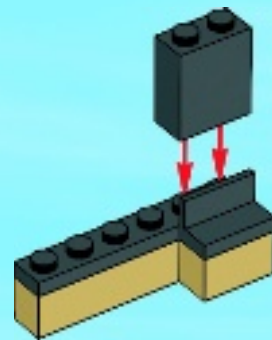

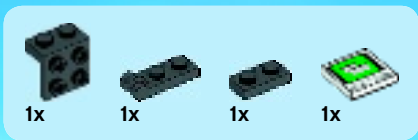

4

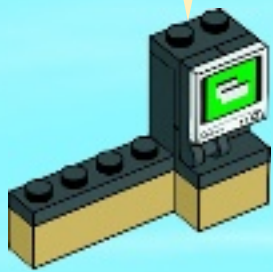
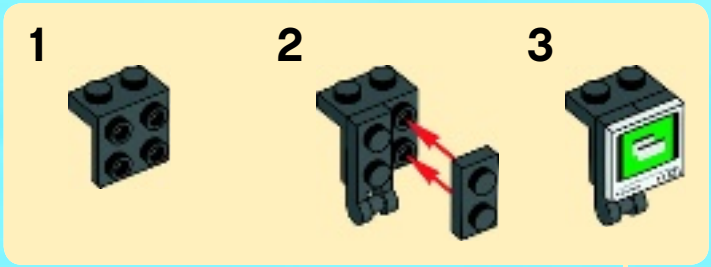

5

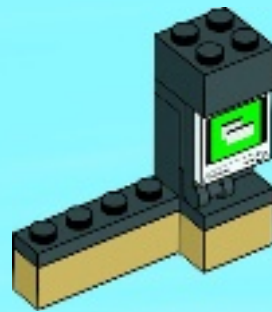

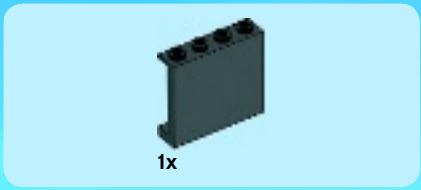

6

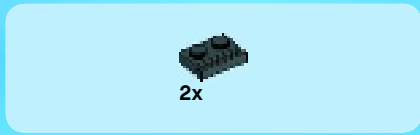
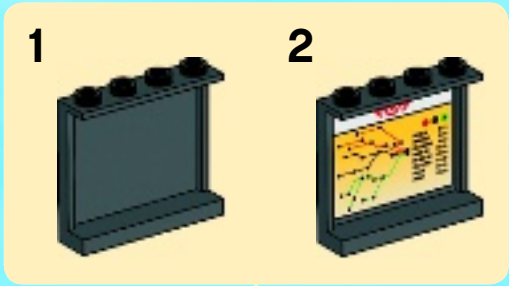

7

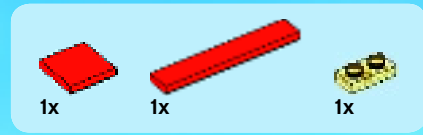

8

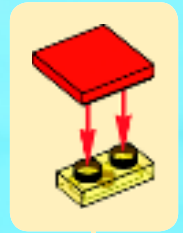

25

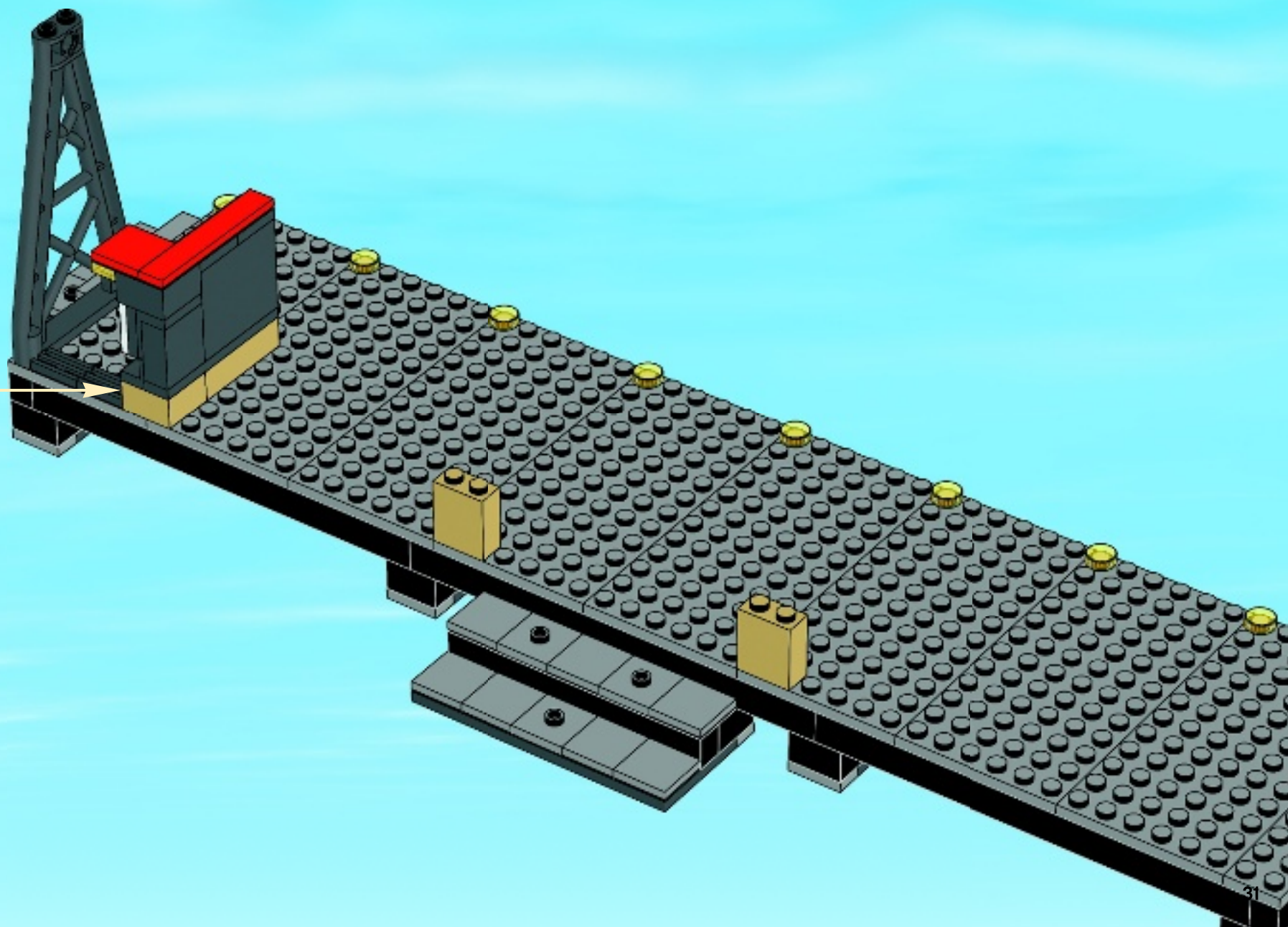



26

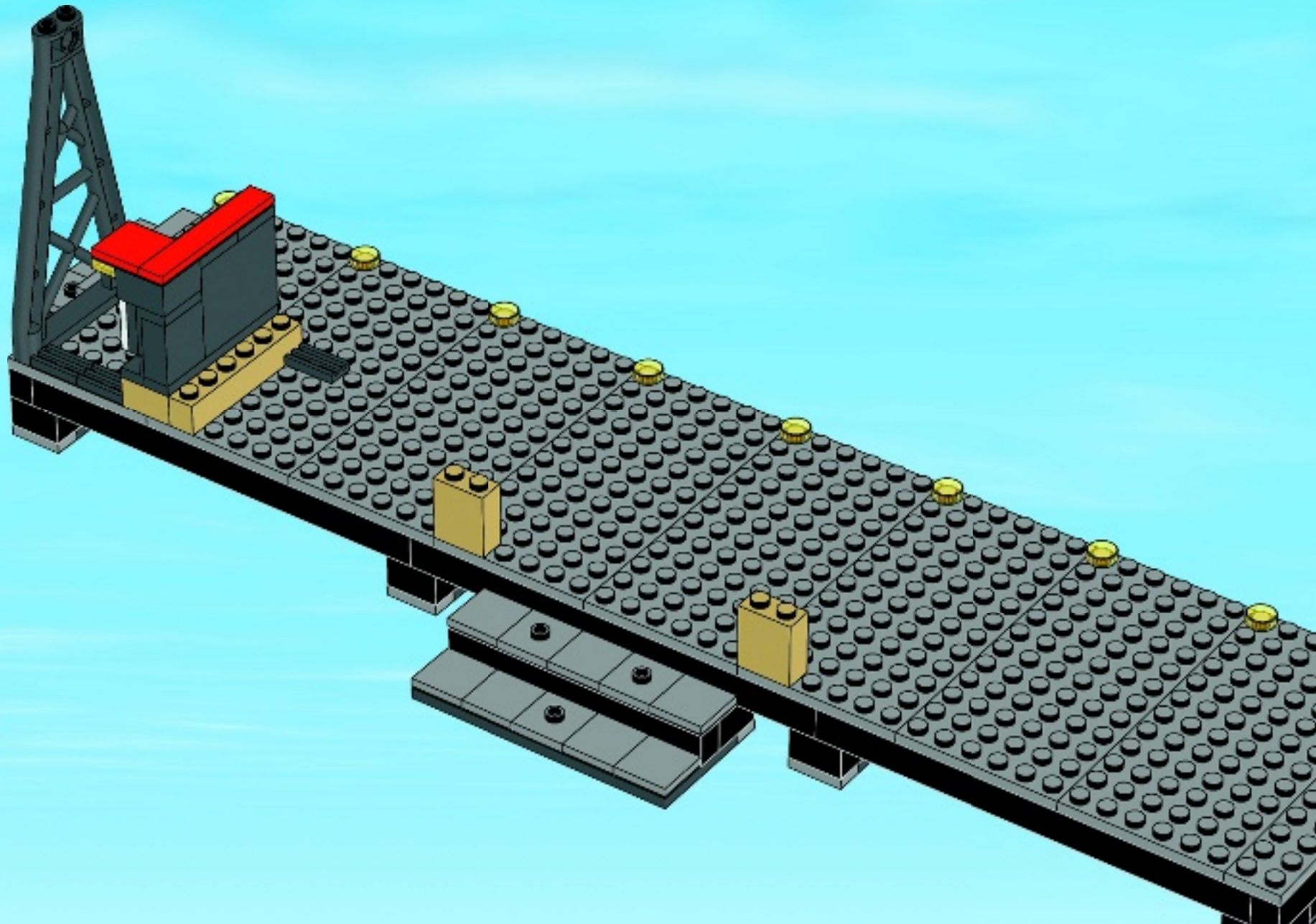

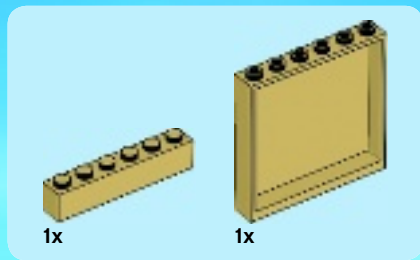

27

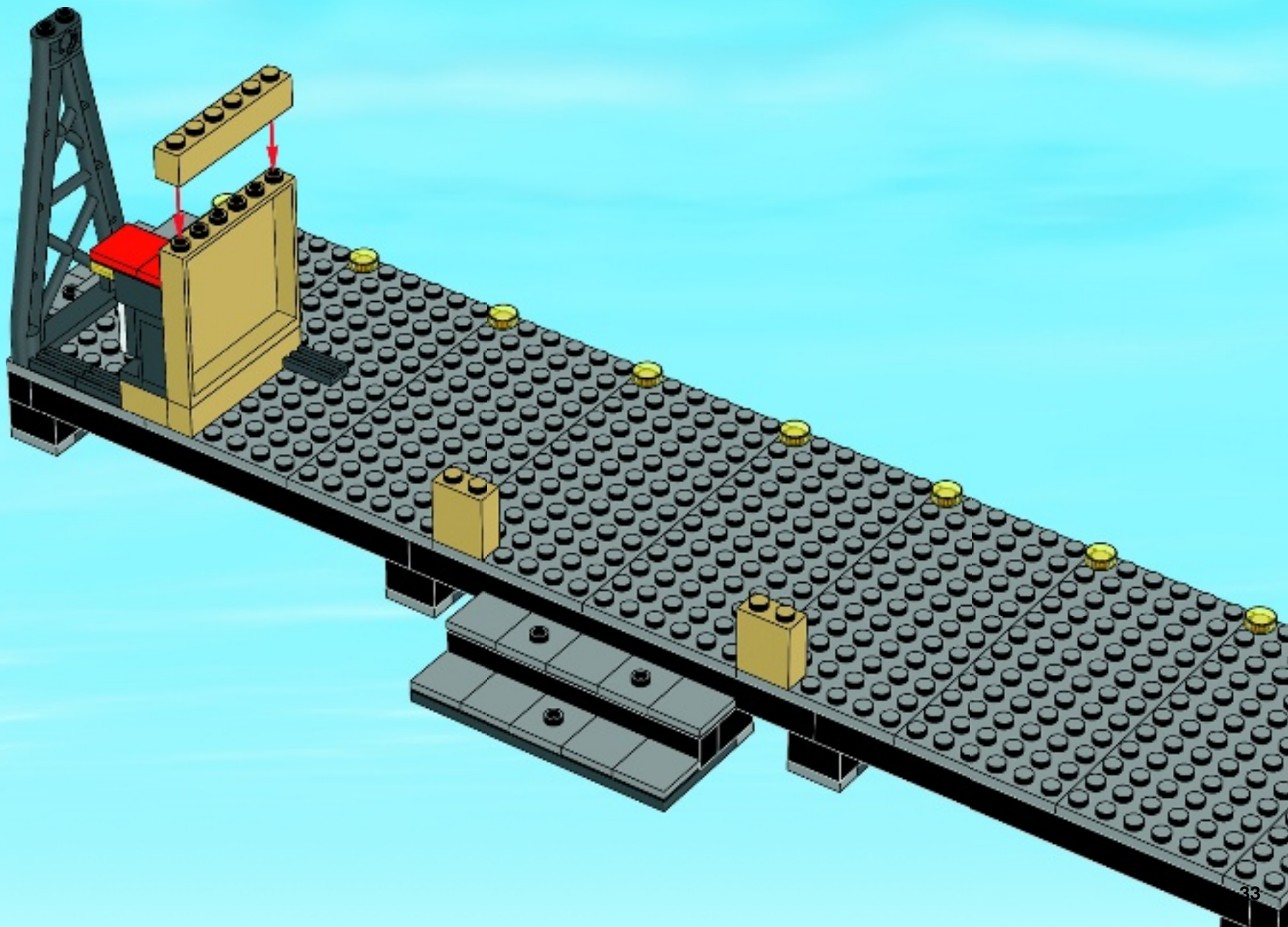



28

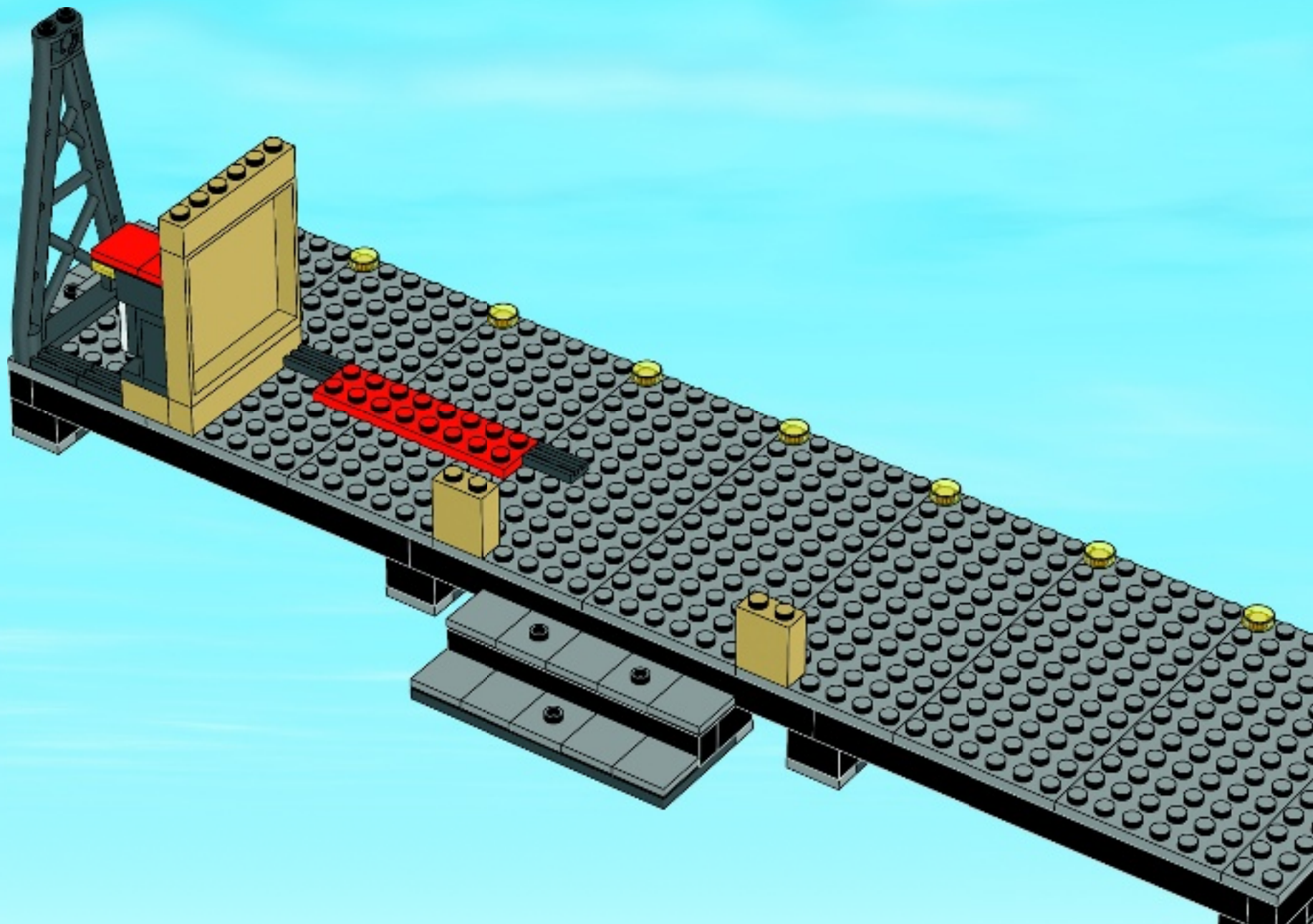



1x



1x



1x

30

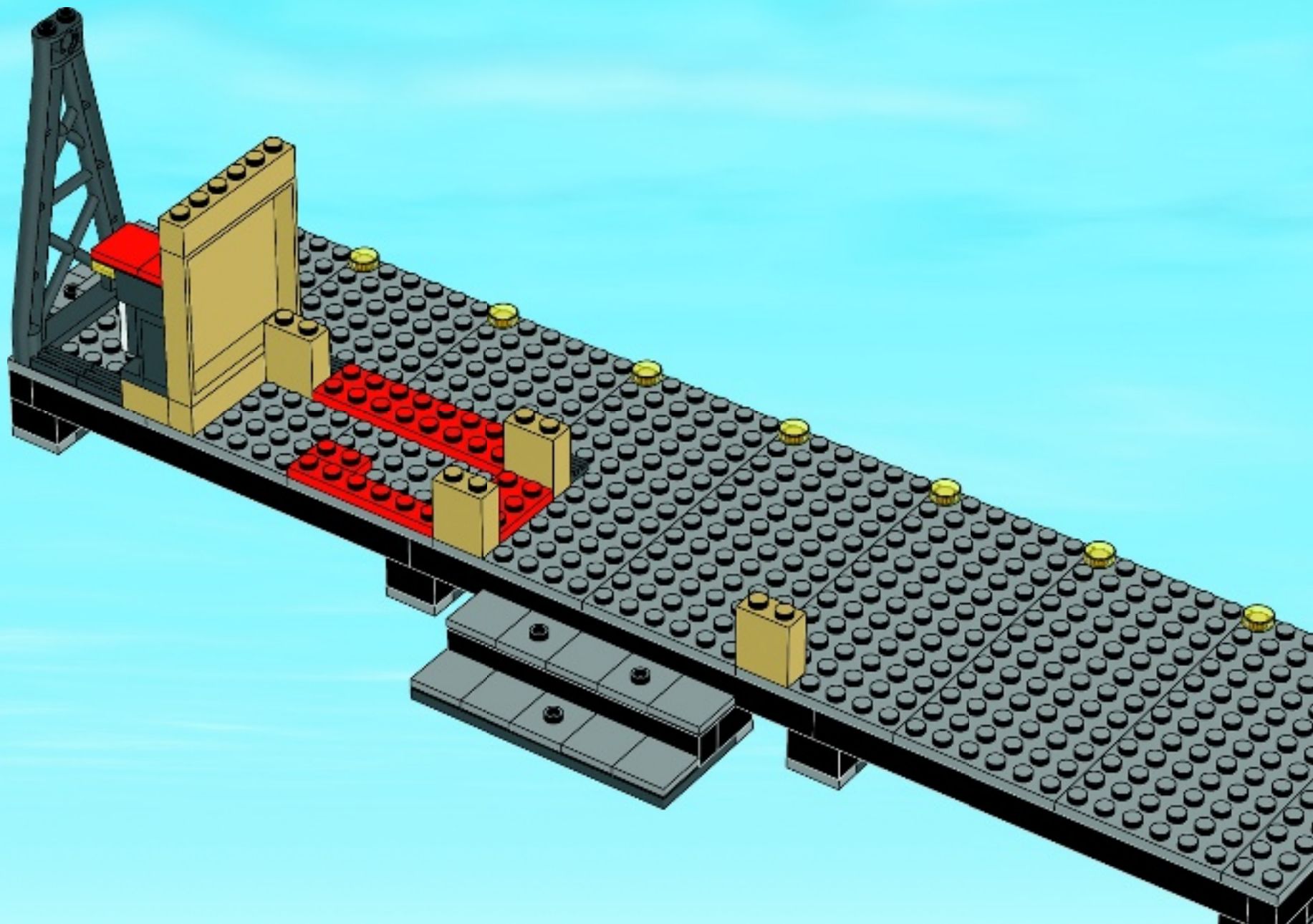

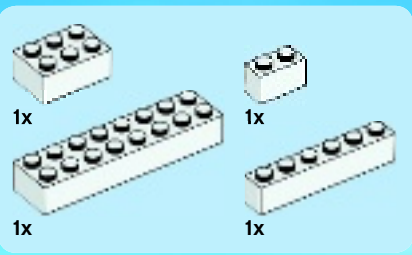

31

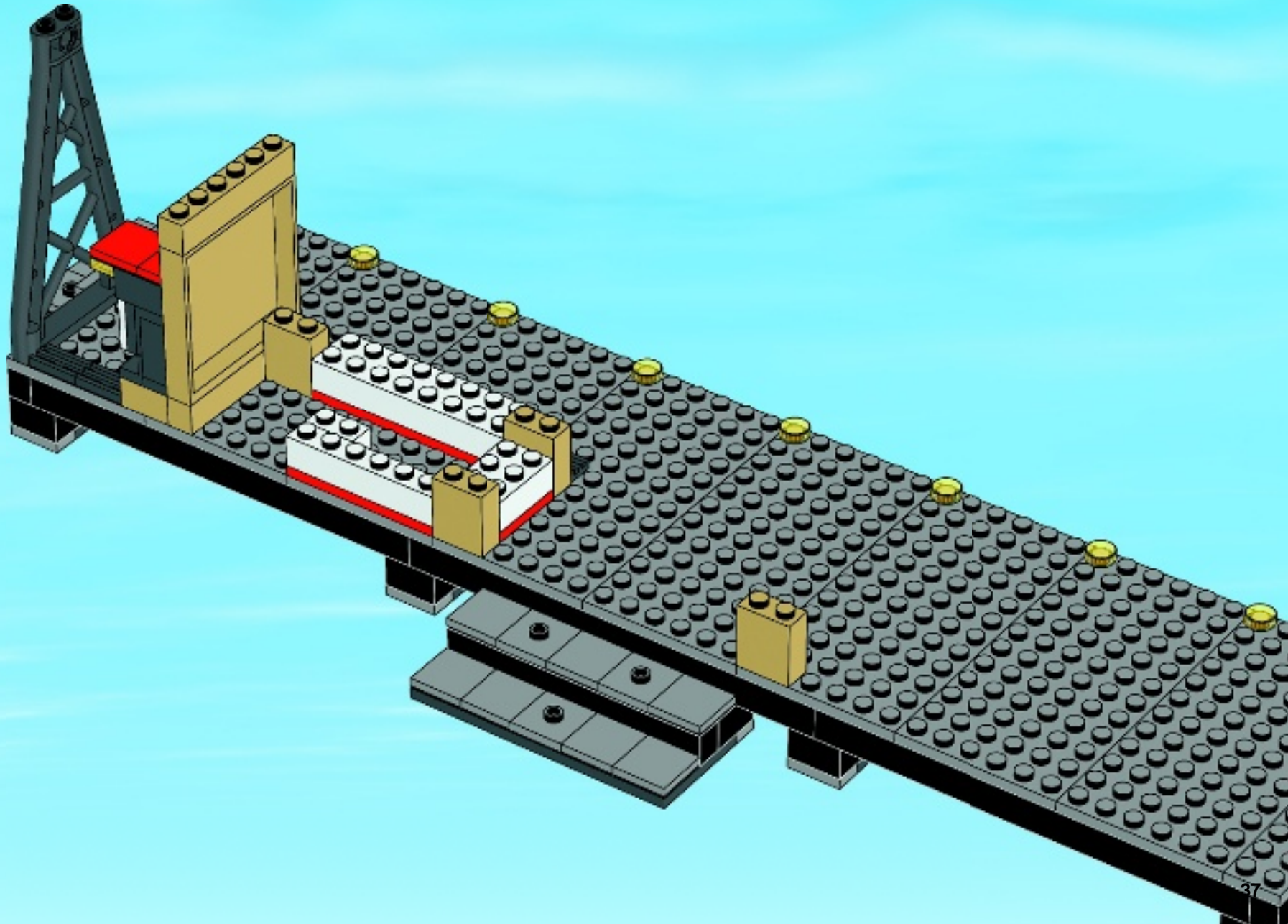

2x



3x



32

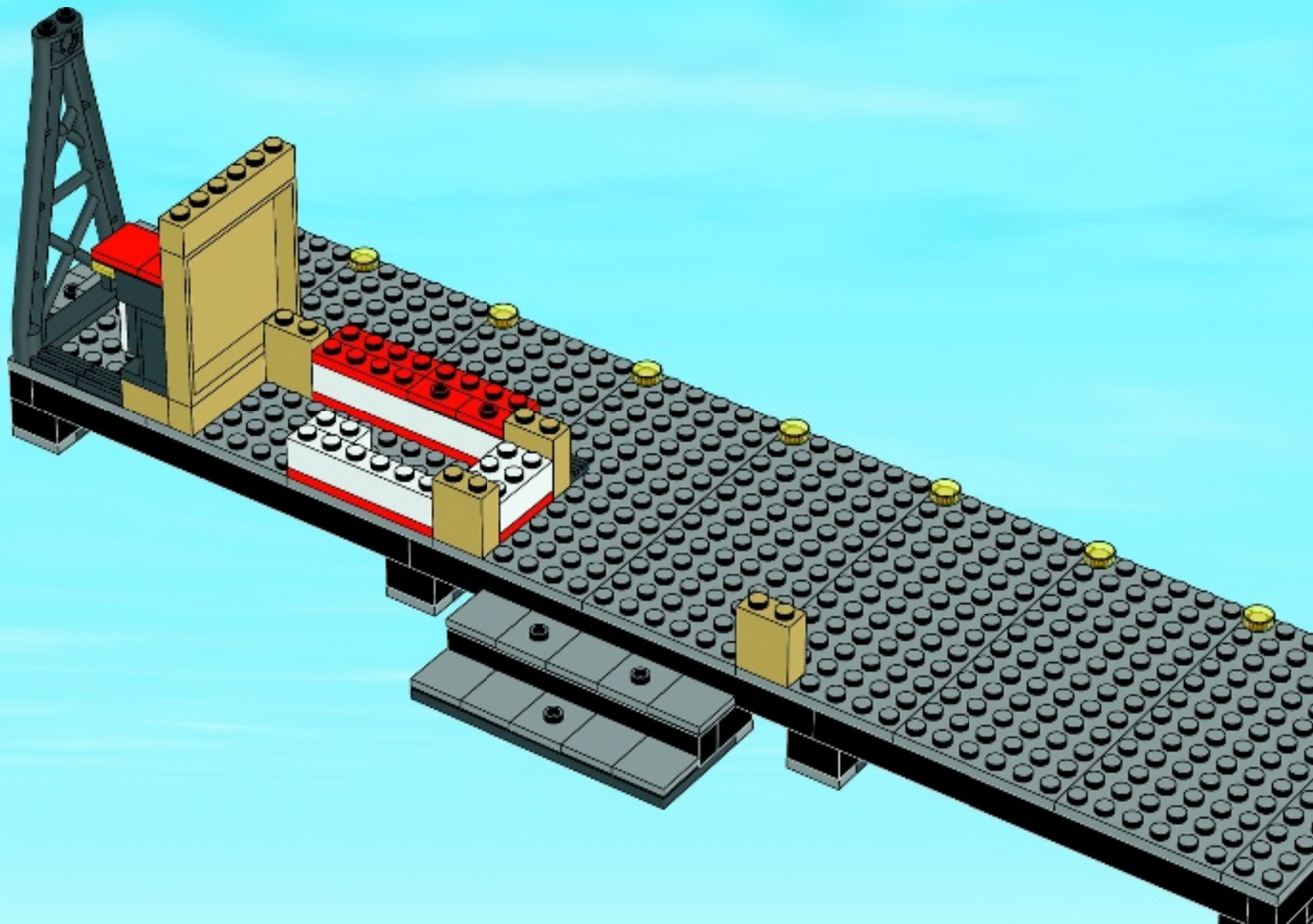

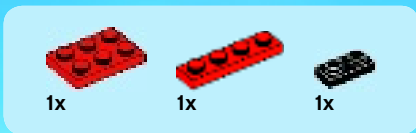

33

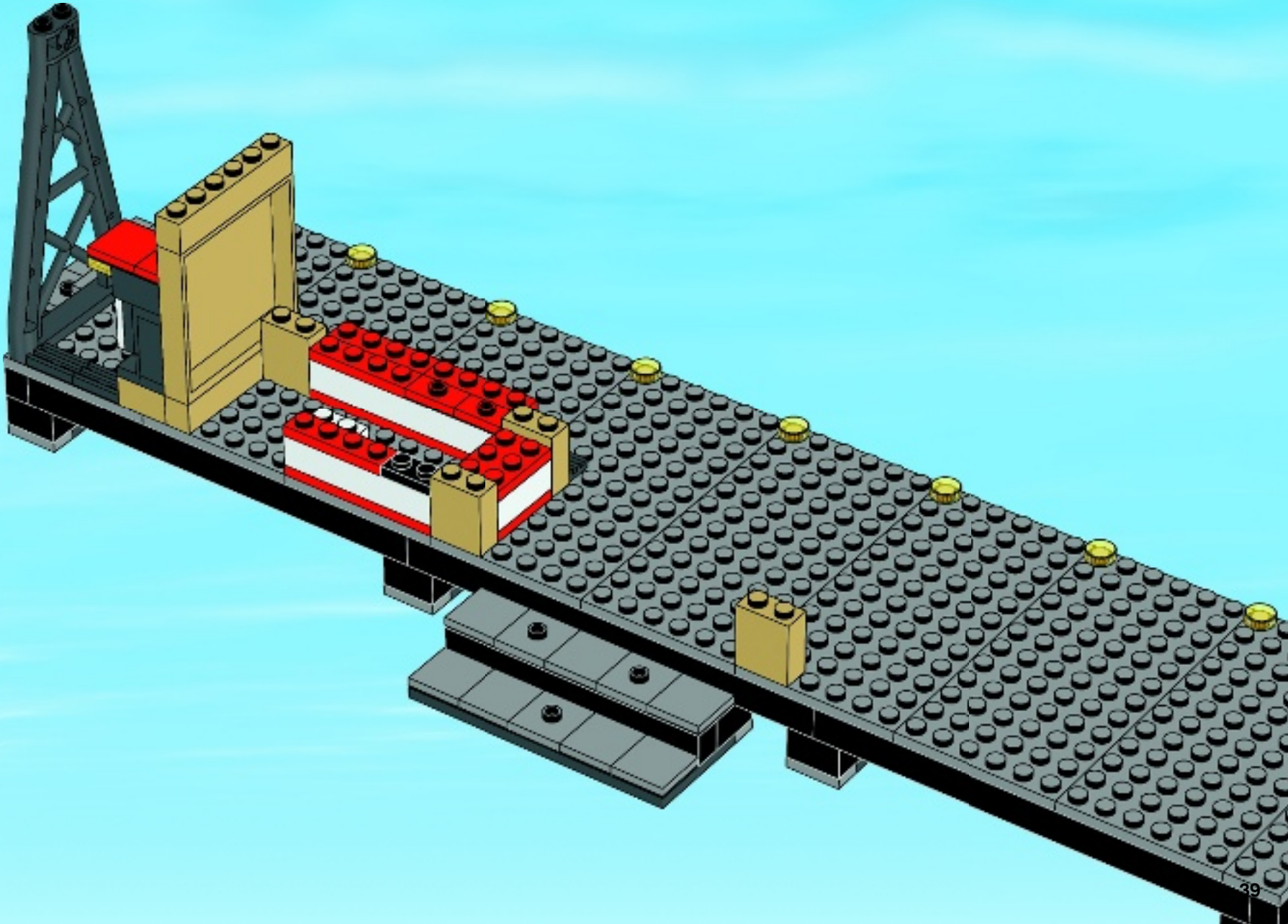



4x

34

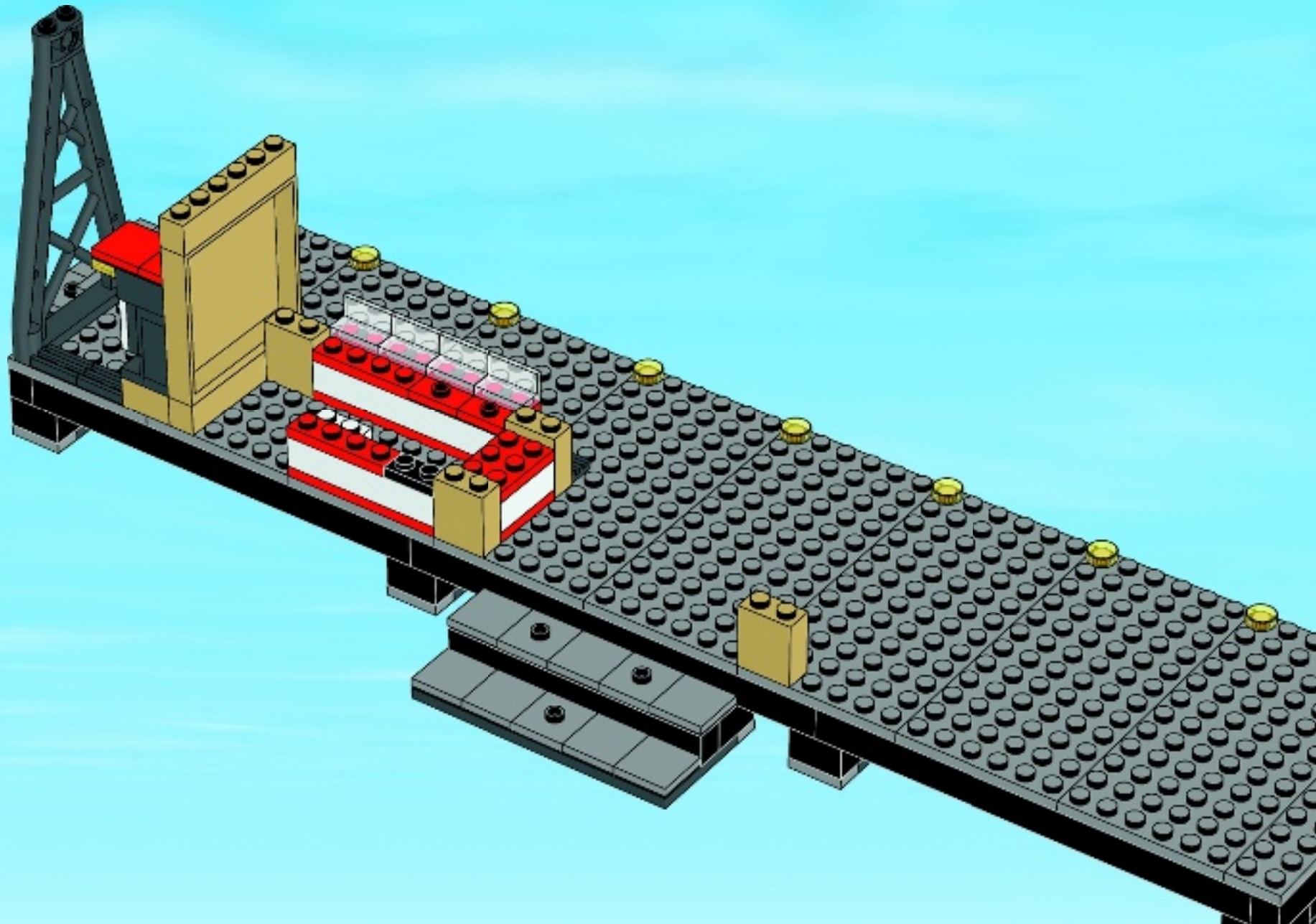



1x



1x



1x



1x

35

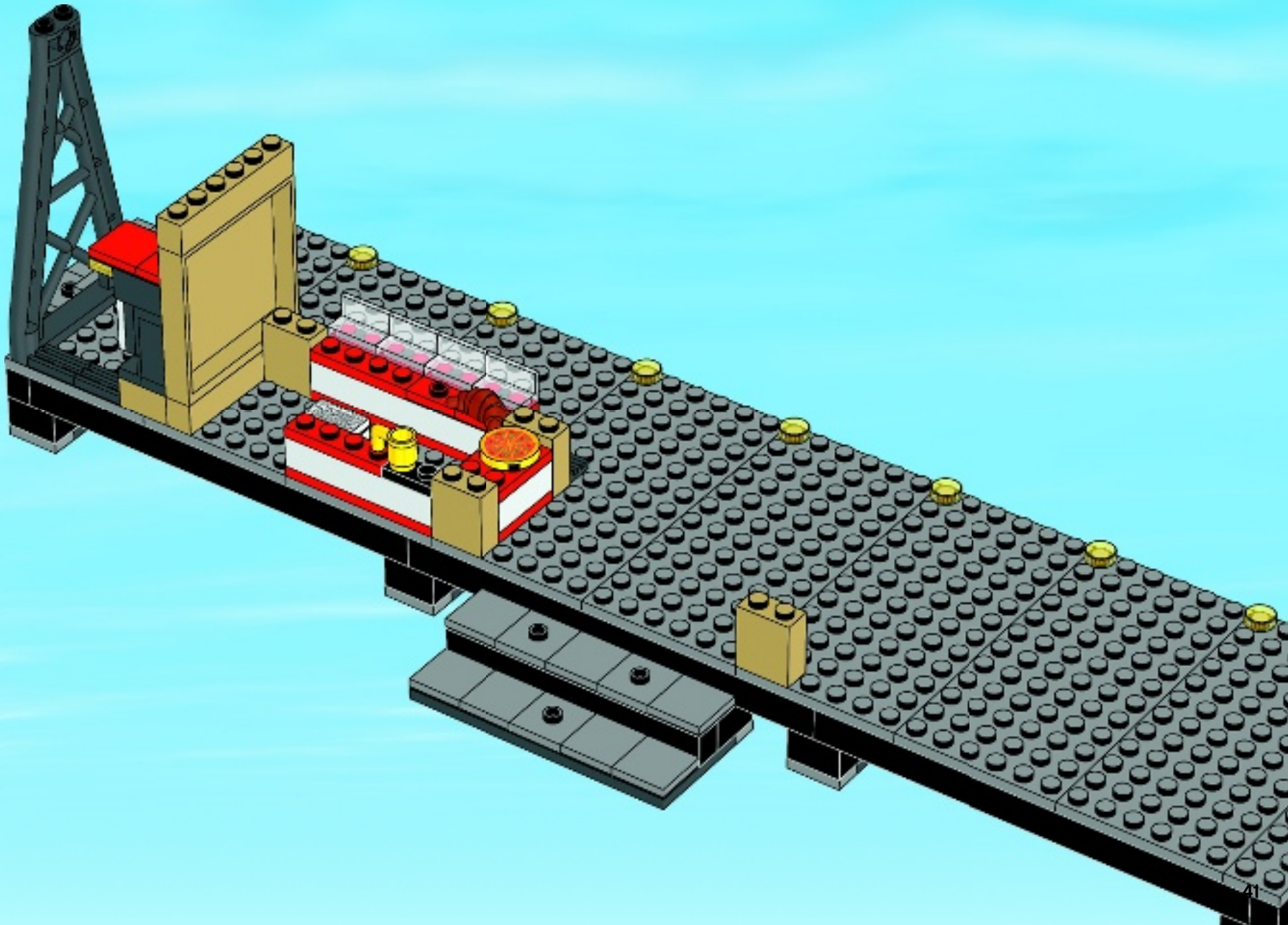



1x



1x



2x

36

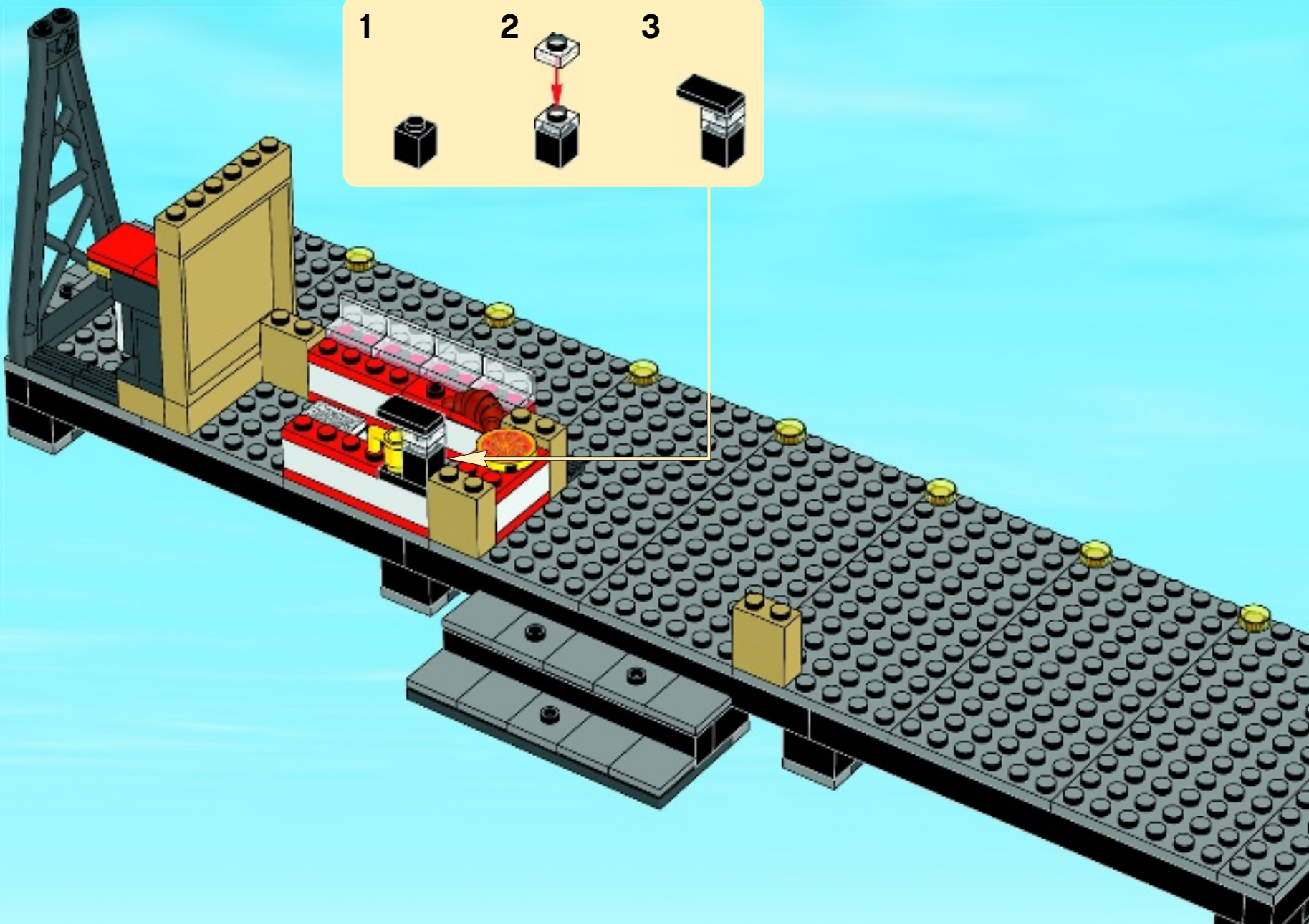

1 2 3

- 2x 
- 2x 
- 2x 
- 2x 

37

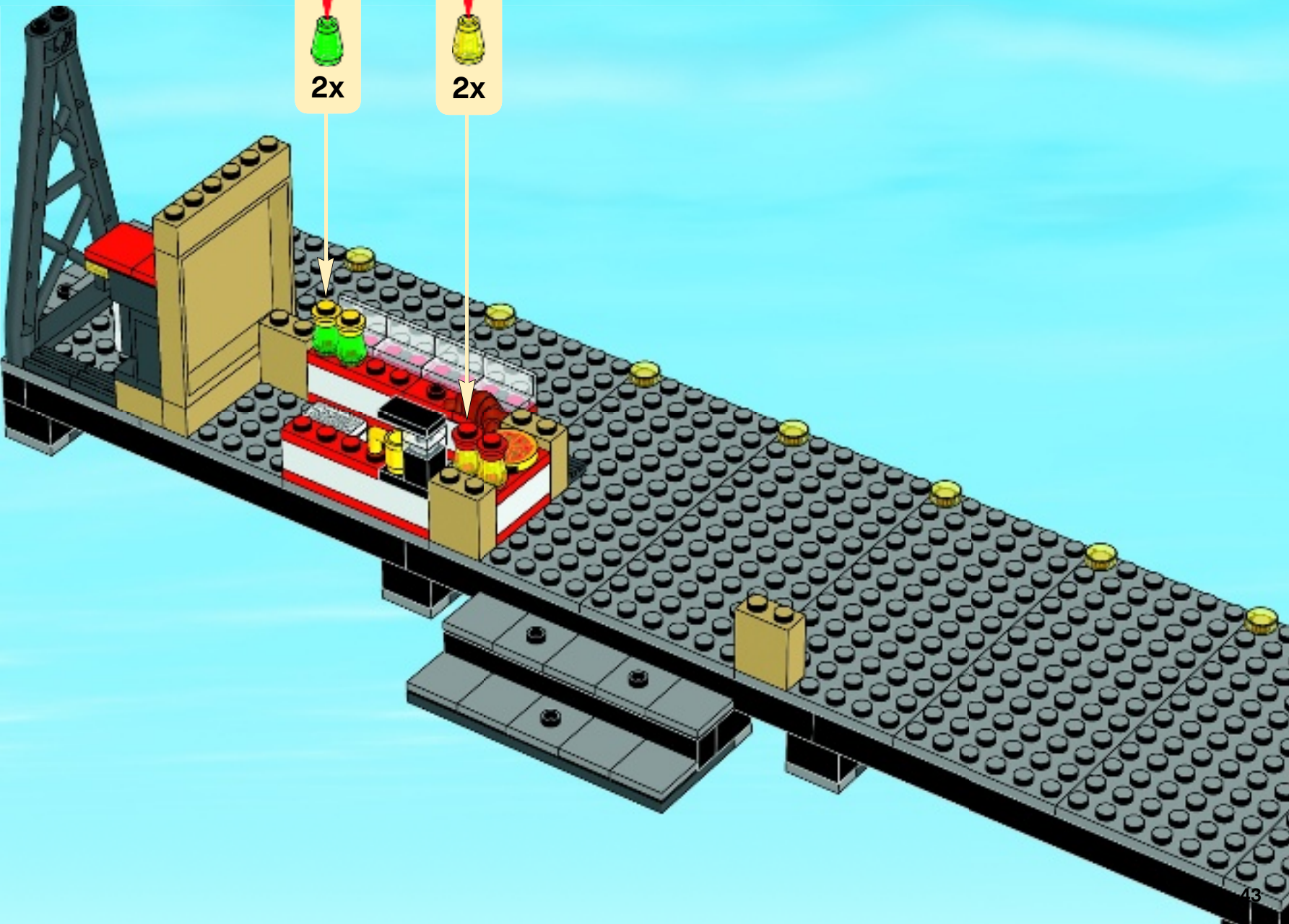



1x



1x

38





3x

39

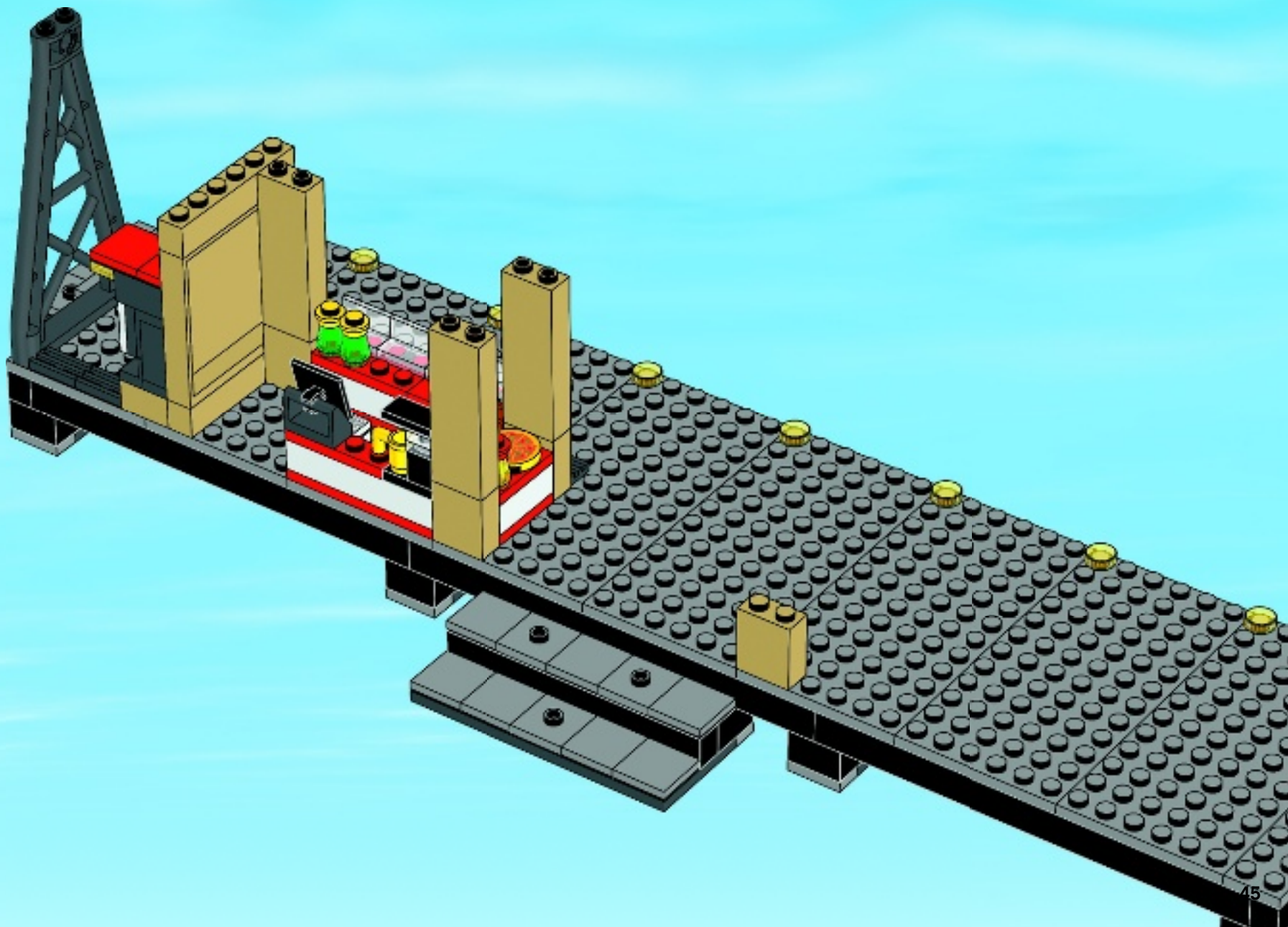

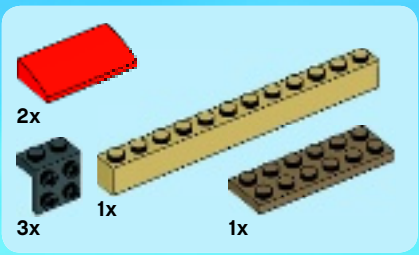

40

1

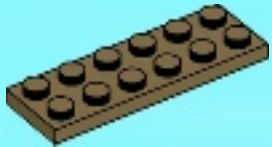

2

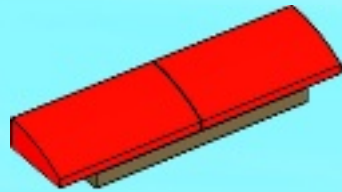

3

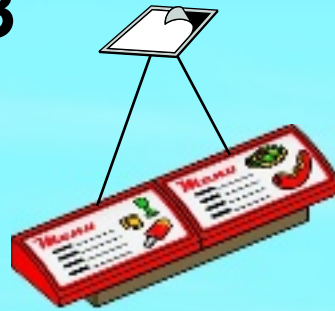

4

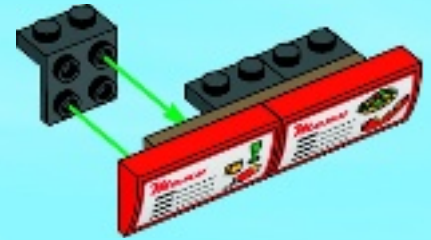

5

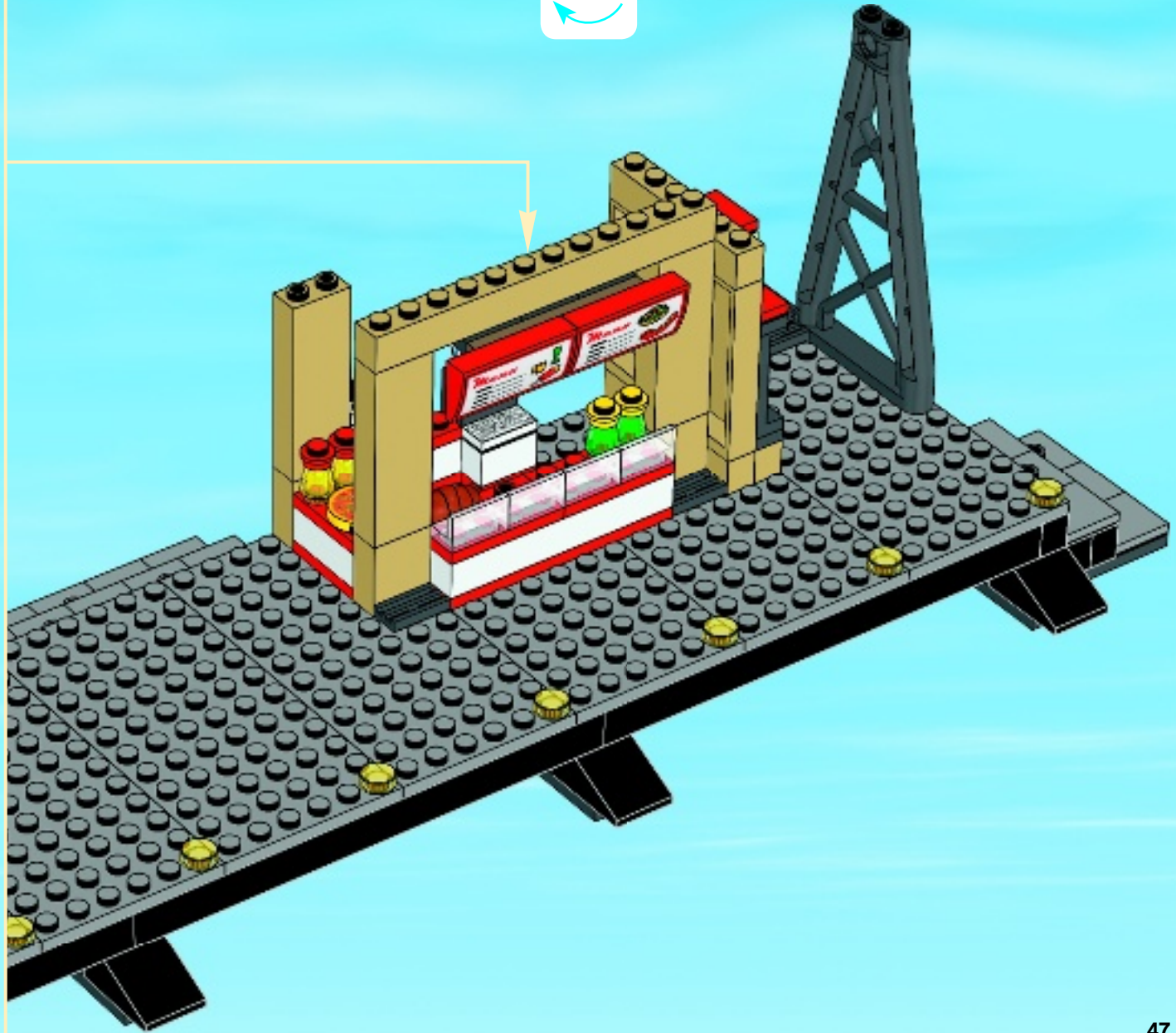



41

