

**LEGO**

DC UNIVERSE™

# SUPERHEROES



6860



TM

1

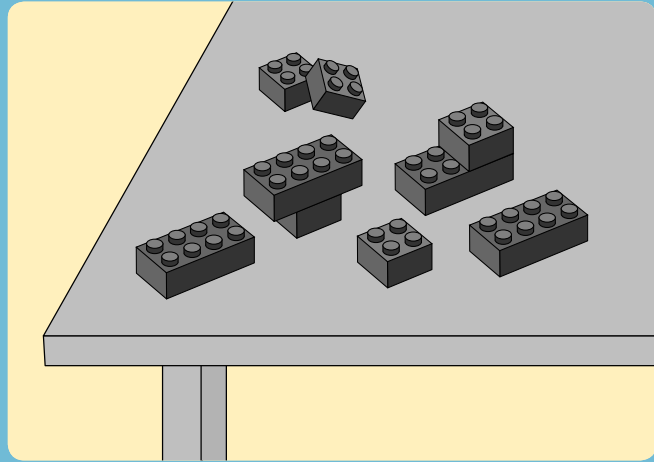
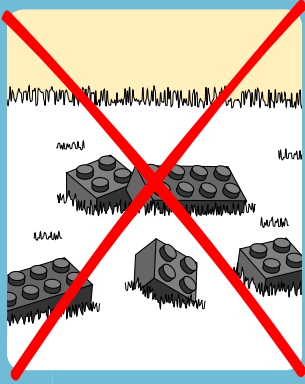

2



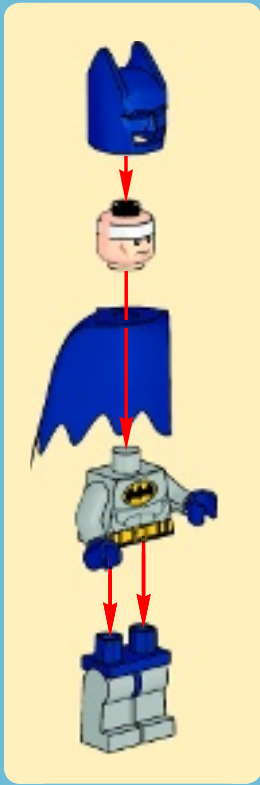



1x

1

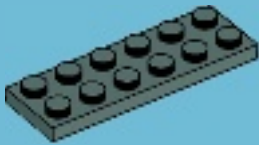

2x

2

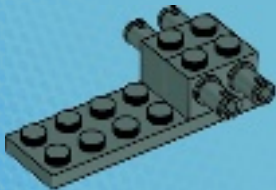

4



2x

3



2x

4





1x

5



1x



2x

6

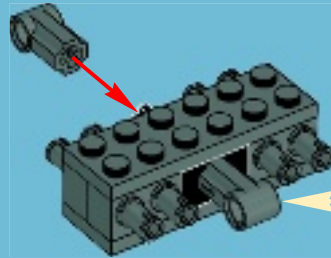
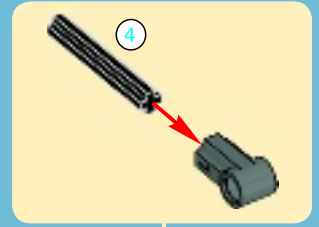

1:1



2x

7

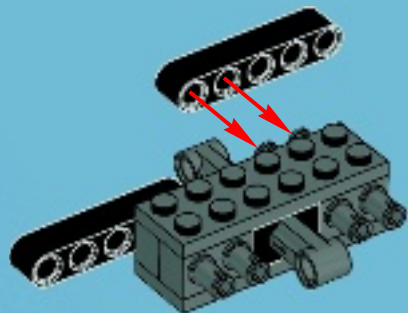

2x

8

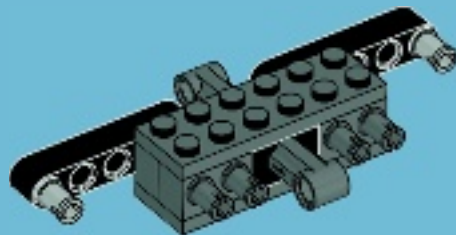



2x



1x



1x

# 9

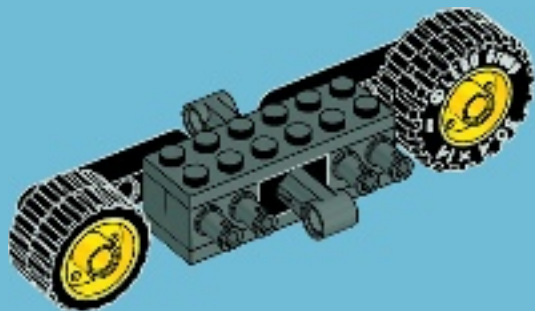

2x

# 10

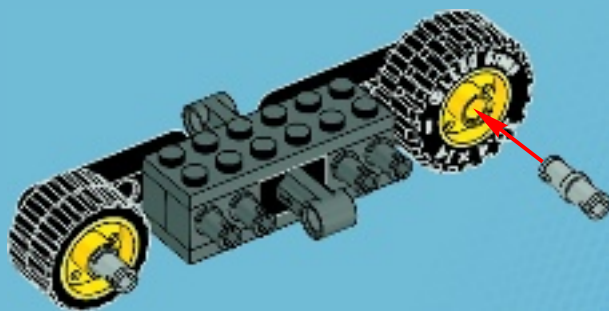



2x

# 11

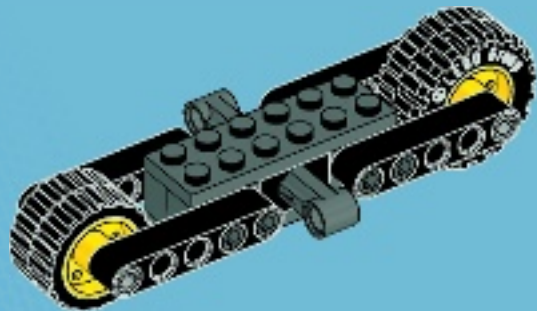

1x



1x

# 12

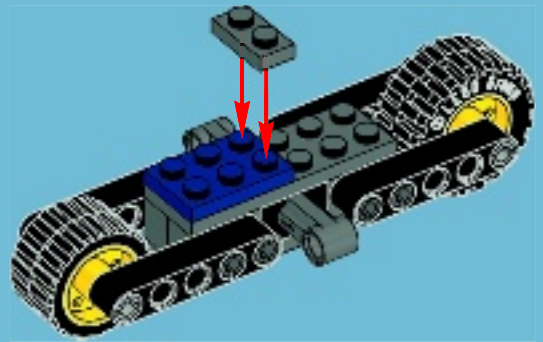





# 13

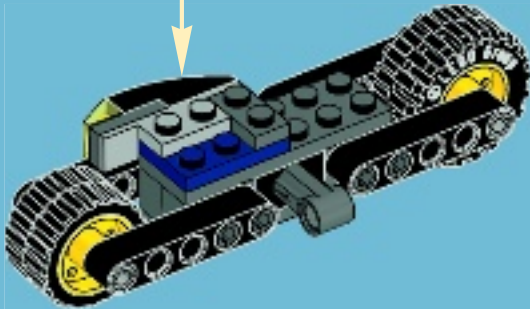
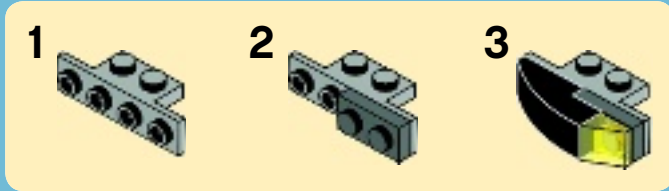

# 14

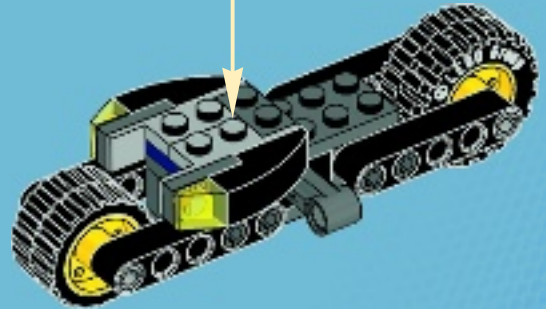
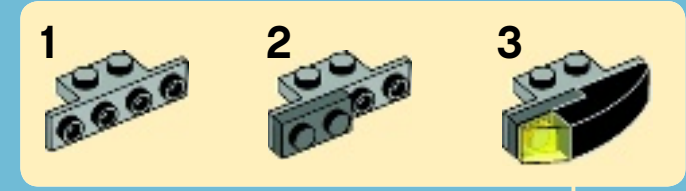



1x

# 15

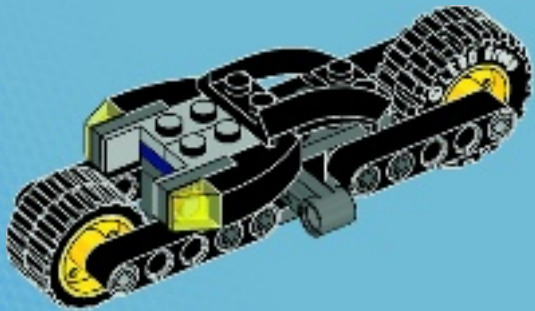

1x



1x

# 16

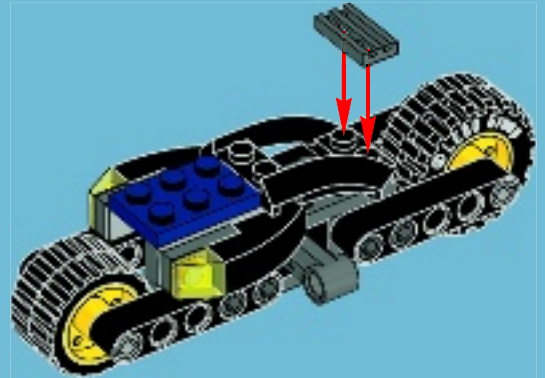



1x



1x

# 17

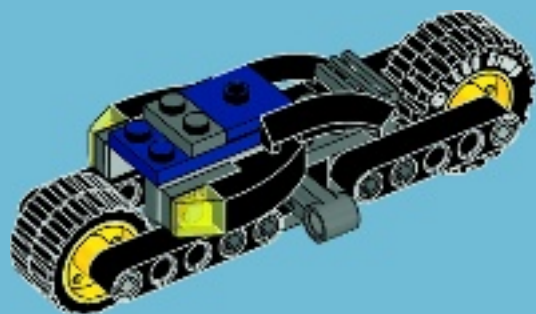

1x



1x

# 18

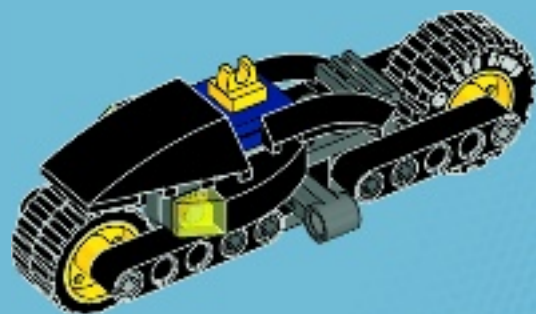



1x

# 19

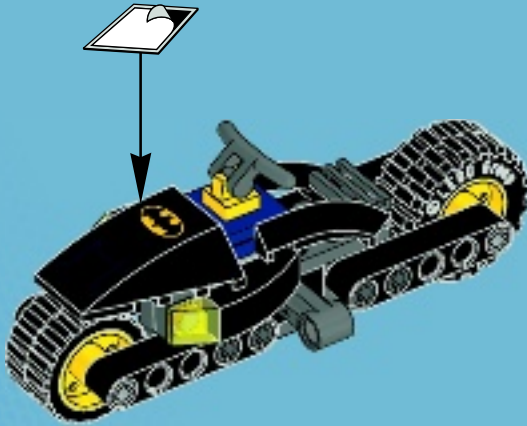

2x



2x

# 20

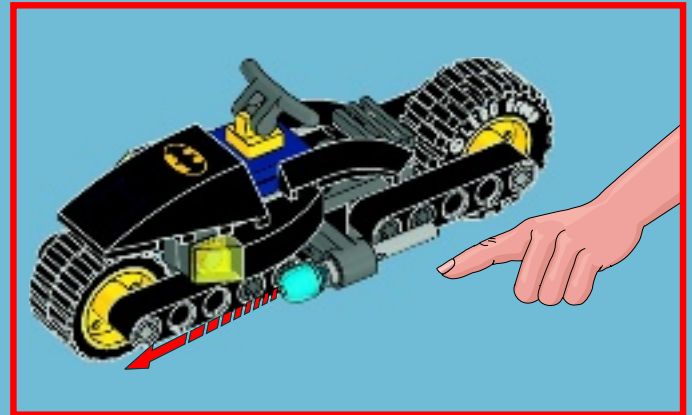
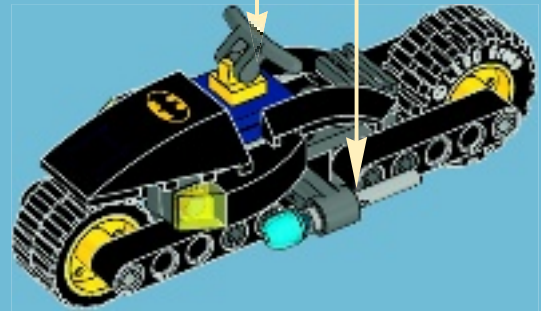
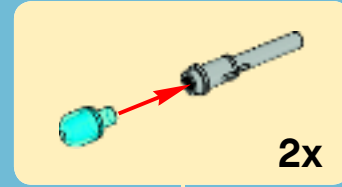

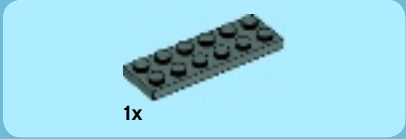

1x

**1**

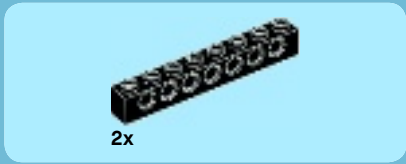

2x

**2**

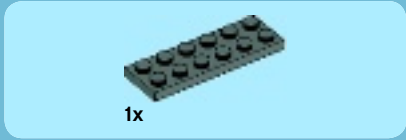
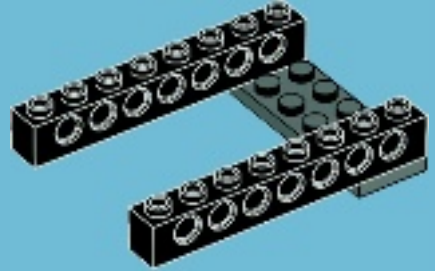

1x

**3**

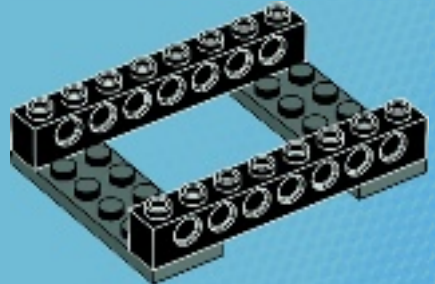



4x



2x

# 4

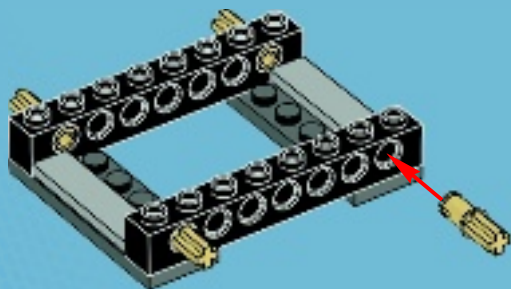

4x

# 5

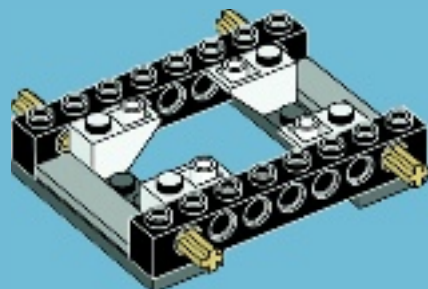



1x

6

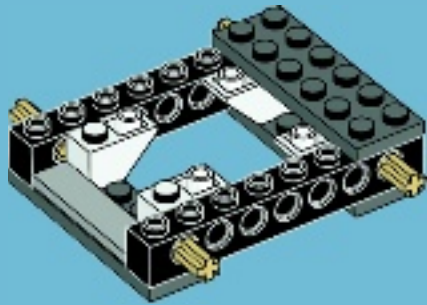

2x



2x

7

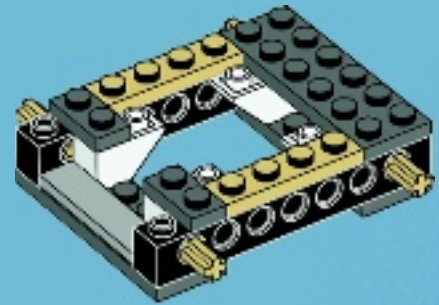



1x

8

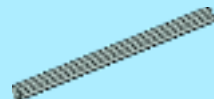
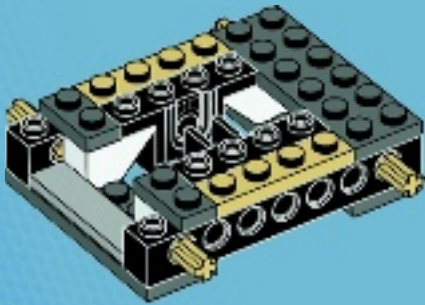

1x

9



1x

9

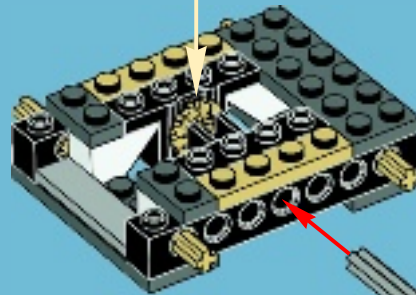

9

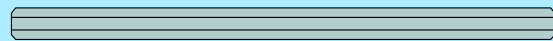

9

1:1





2x



2x

# 10

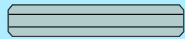
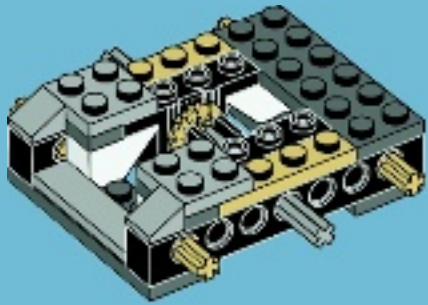

3

# 1:1



1x



1x

3



1x

# 11

1

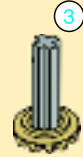

2

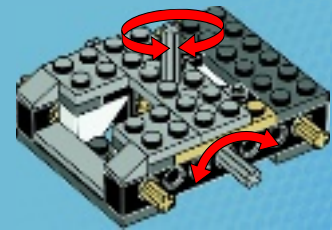
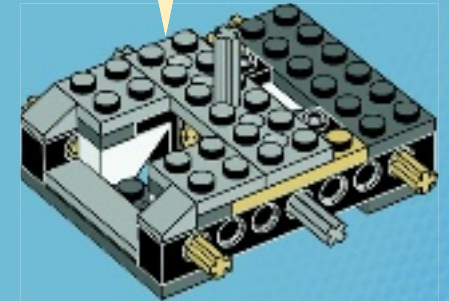
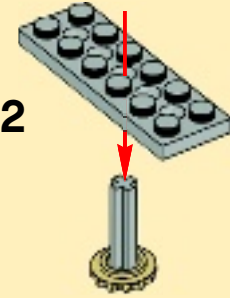

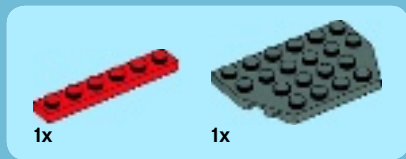

# 12

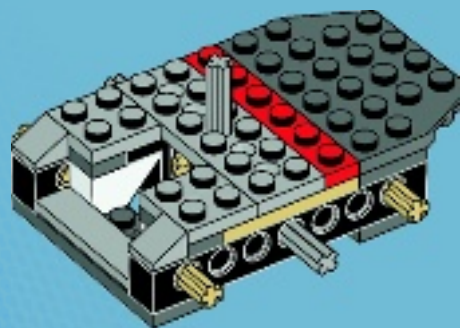

# 13

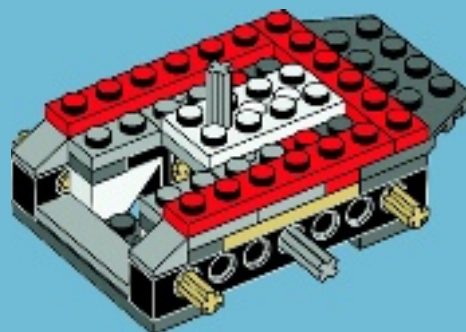



2x



1x



2x

# 14

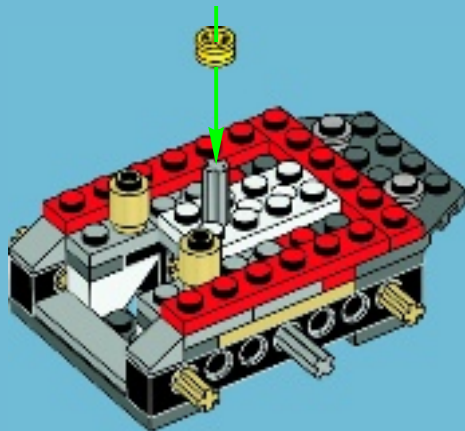

1x



1x



2x

# 15



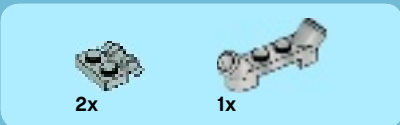

# 16

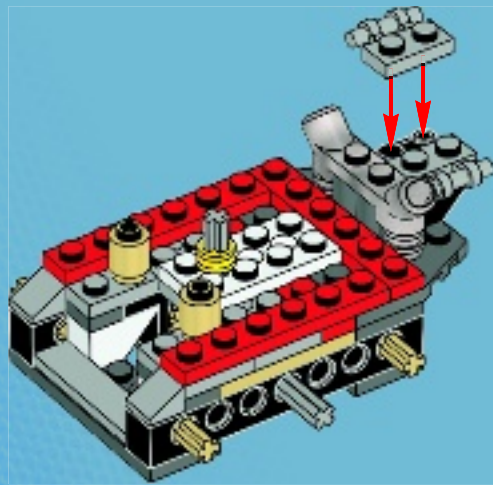

# 17

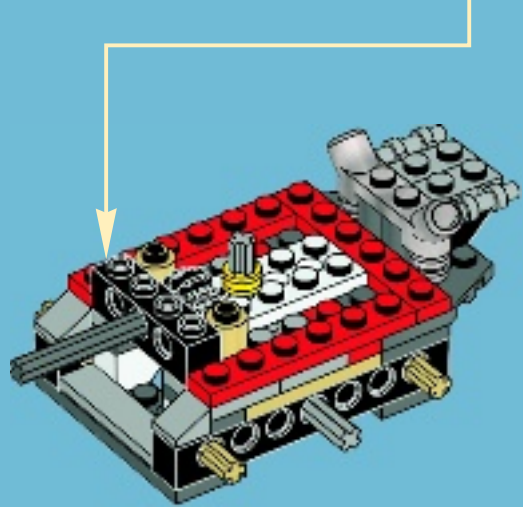
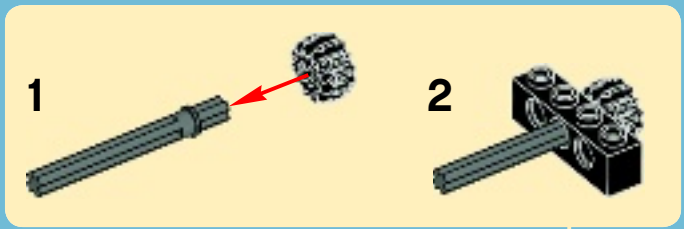



1x



1x

# 18

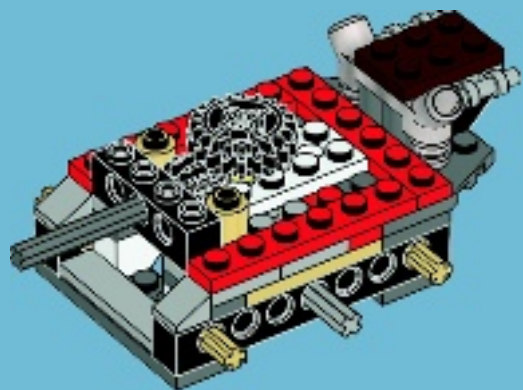

1x

# 19

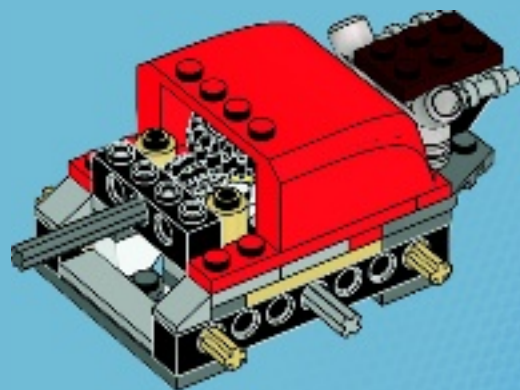

# 20

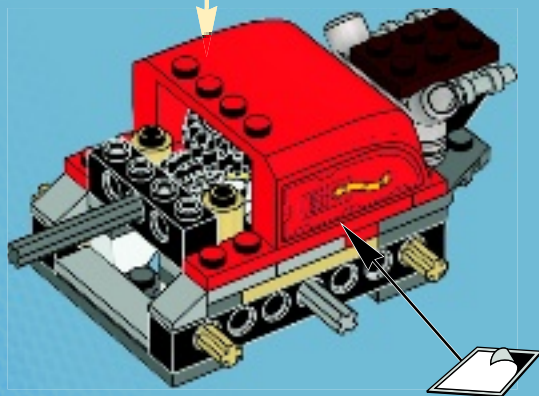

# 21

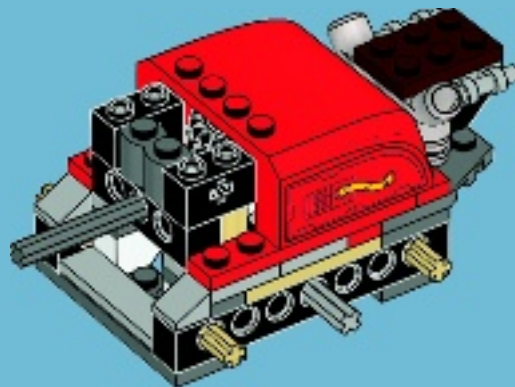



1x



1x

# 22

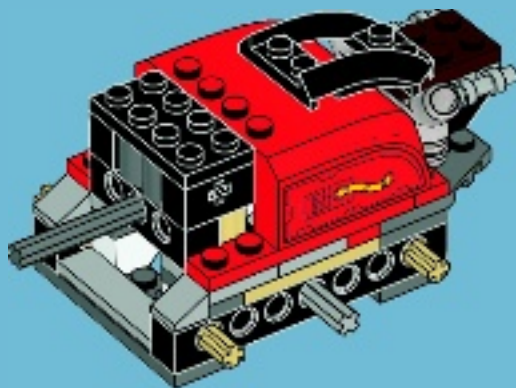

1x



1x

# 23

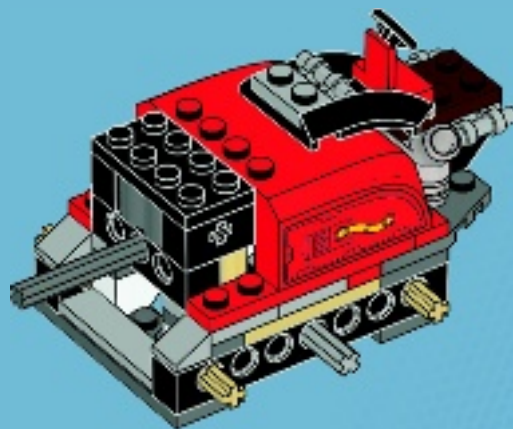



1x



1x

# 24

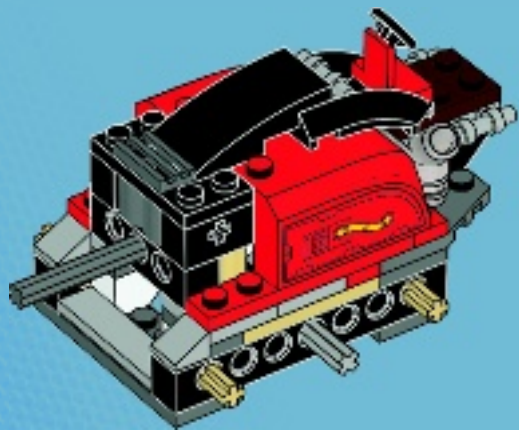

2x



2x

# 25

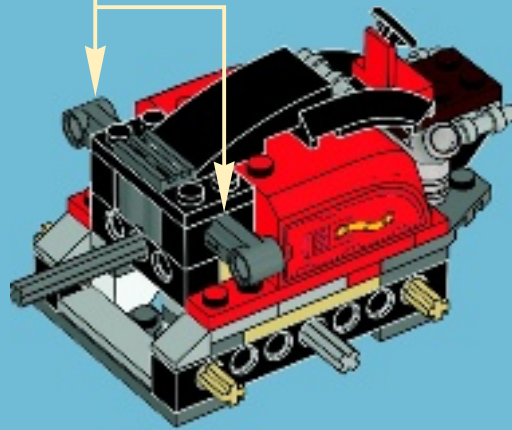
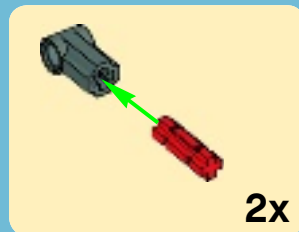





1x



1x

# 26

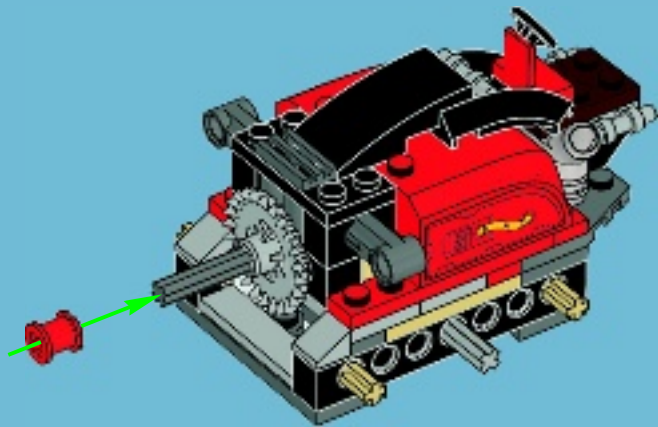

1x

# 27

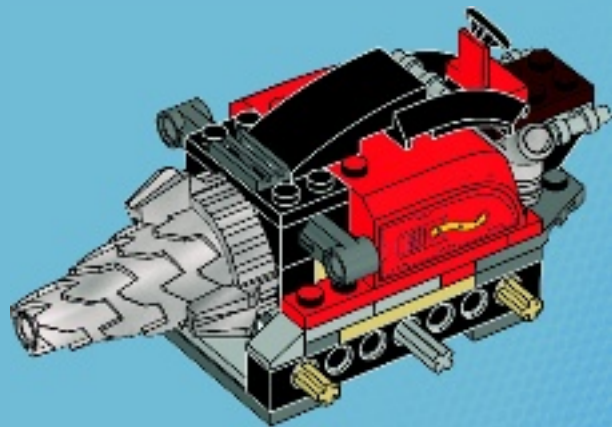



1x



1x



1x

# 28

1



2



3

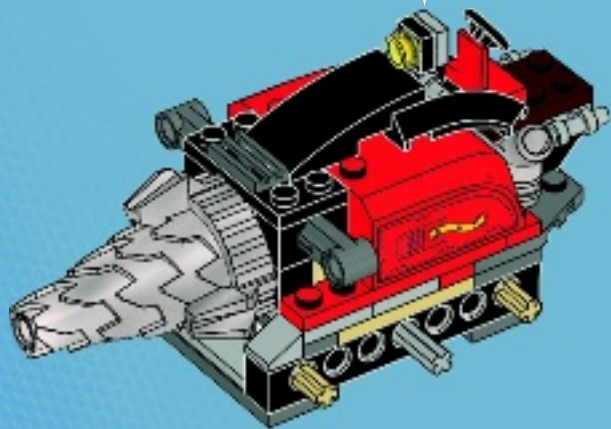

6x

# 29

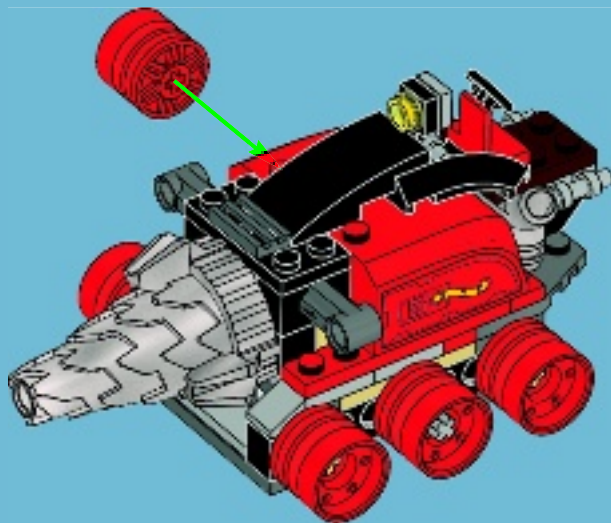



2x

# 30

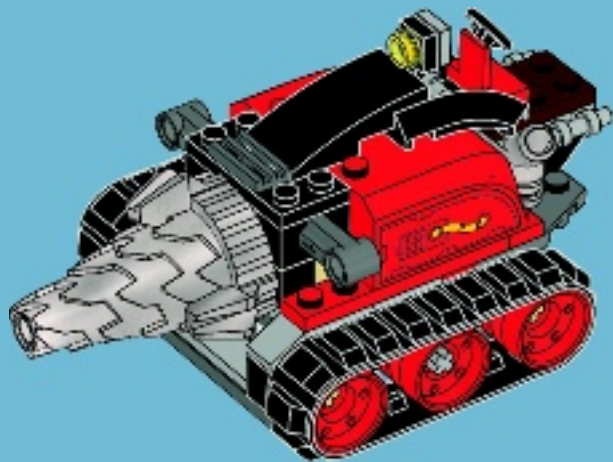

2x



2x

# 31

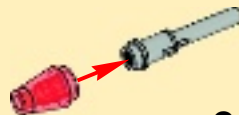

2x

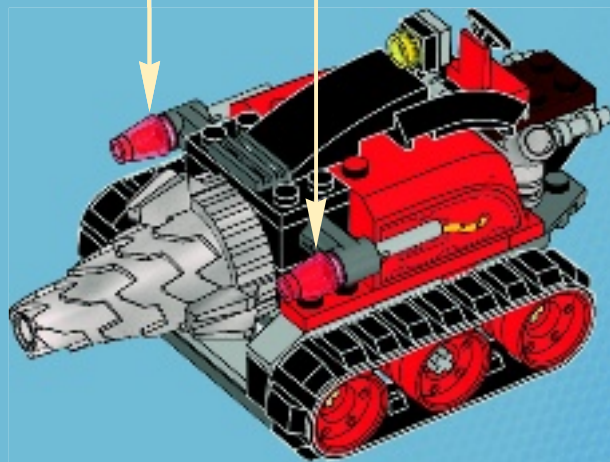

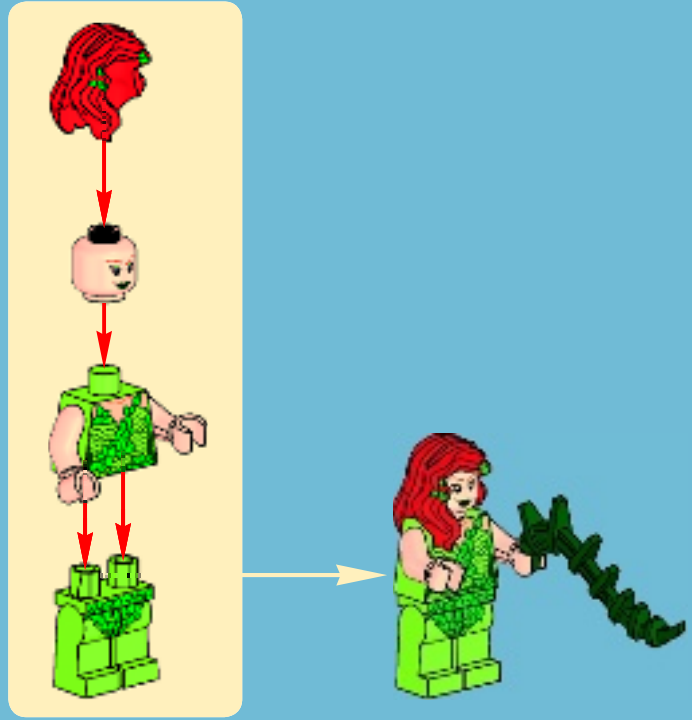
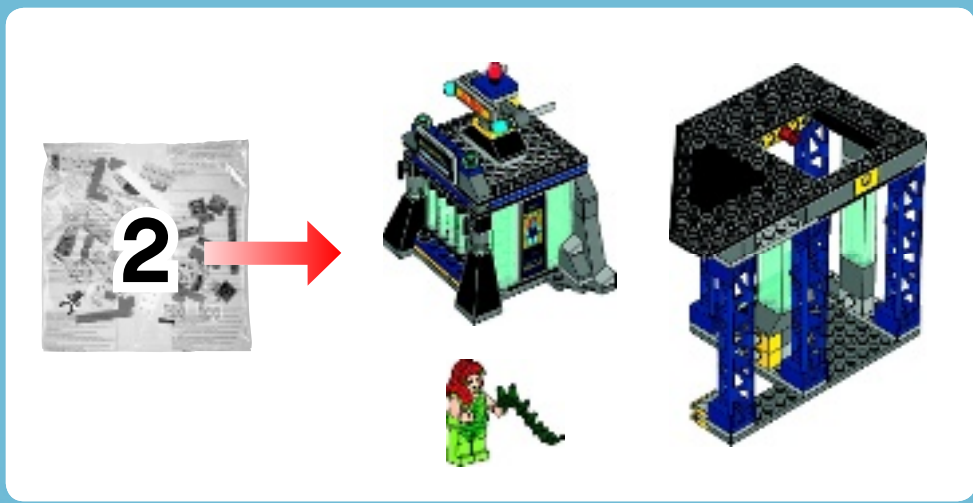



**1**

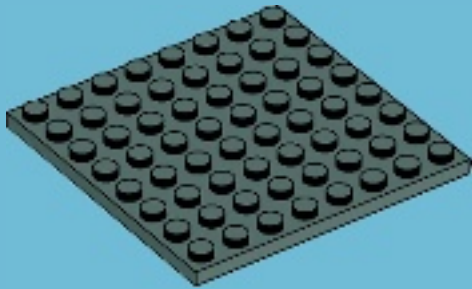

**2**

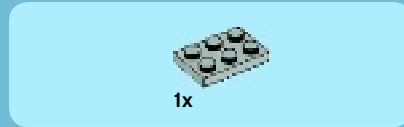
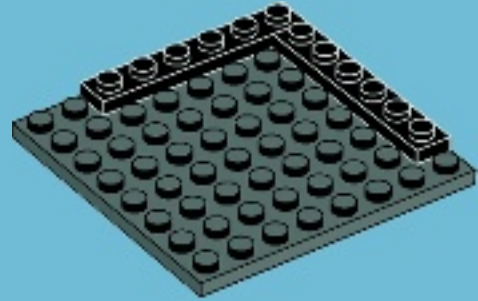

**3**





1x

4

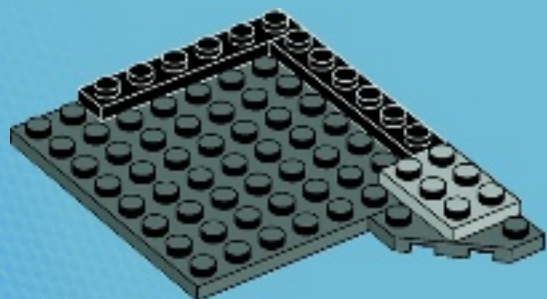

3x



2x



1x

5

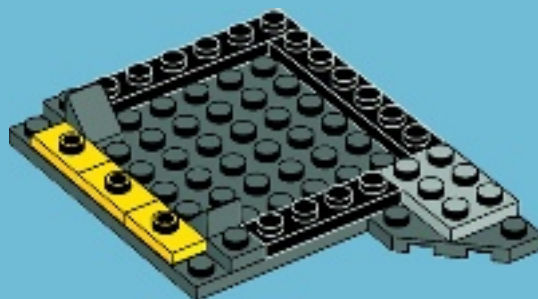



1x



2x



2x

# 6

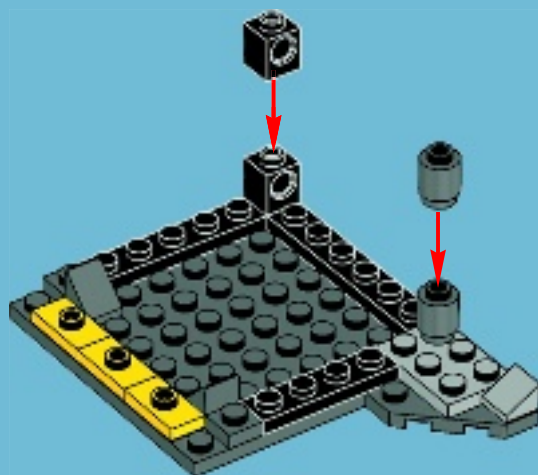

2x



1x

# 7

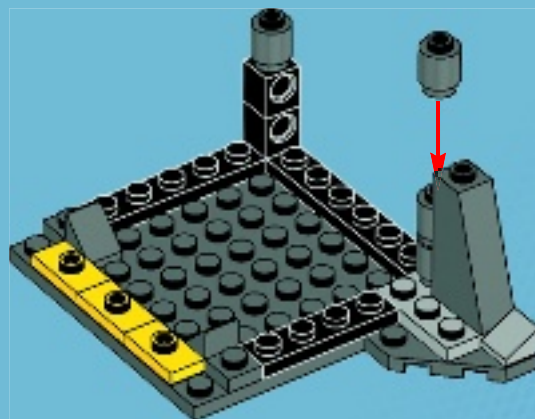



1x



1x



1x

8

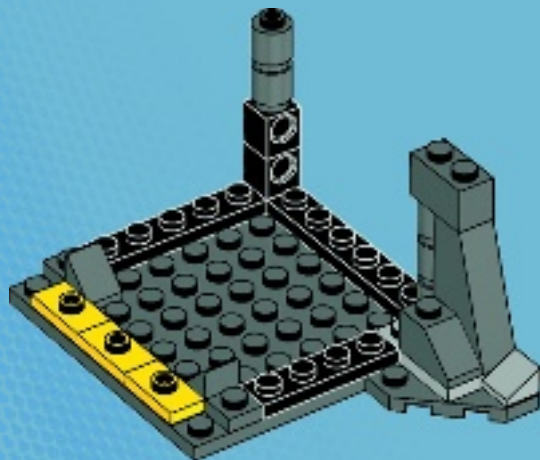

1x



1x



1x

9

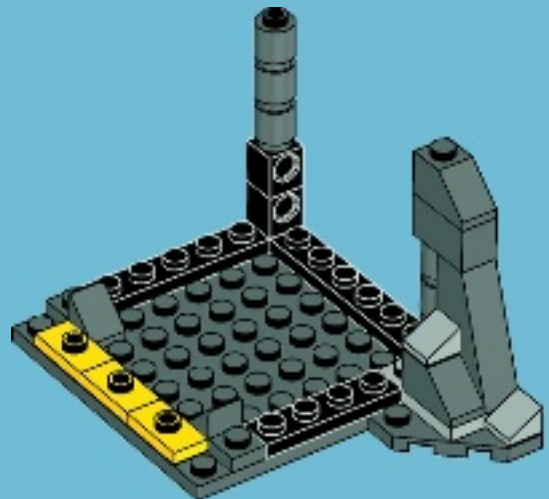



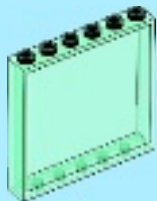

1x

# 10

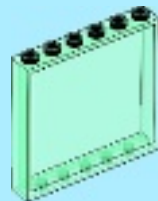
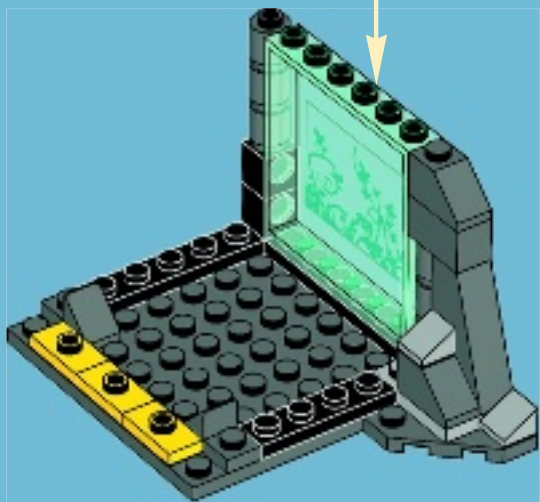
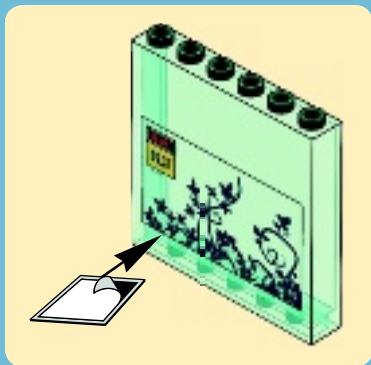

1x

# 11

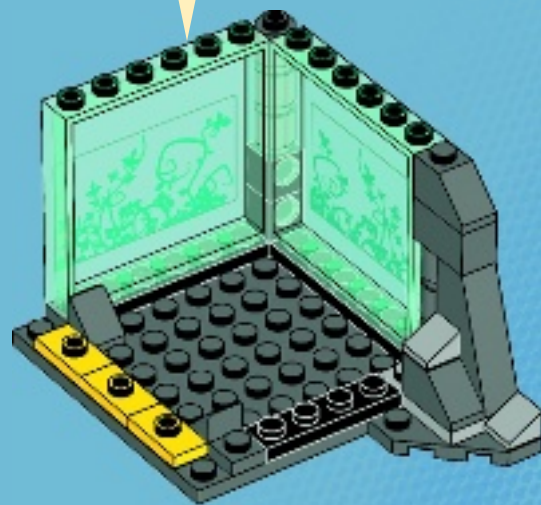
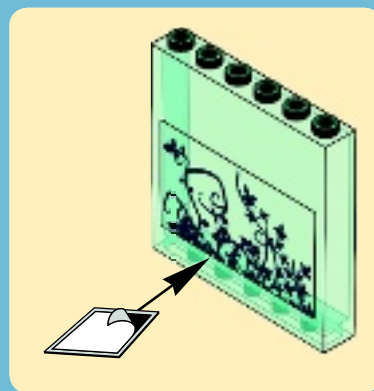



1x



2x

# 12

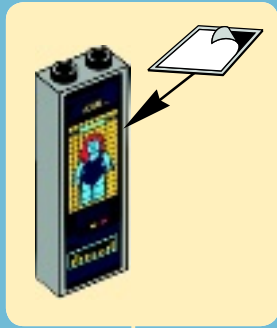

2x

# 13

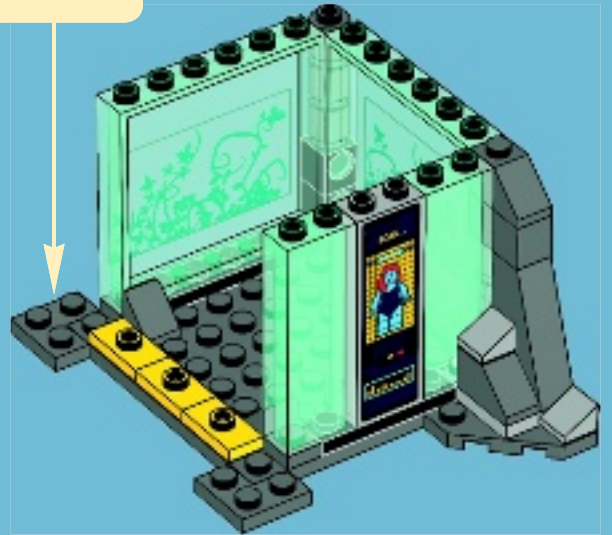



2x

# 14

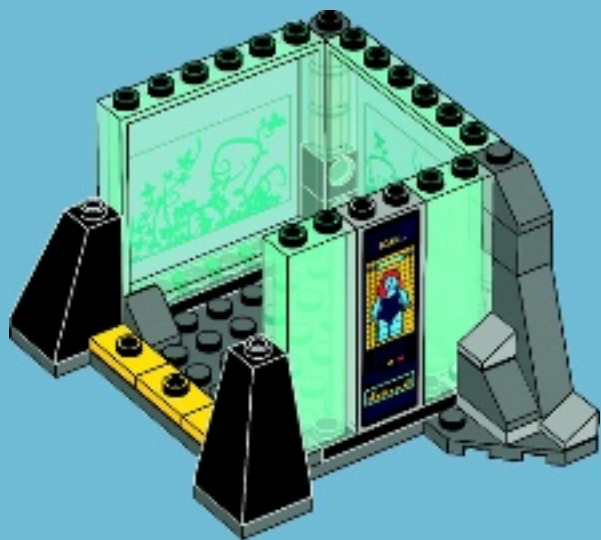

2x



2x



2x

# 15

1



2



2x

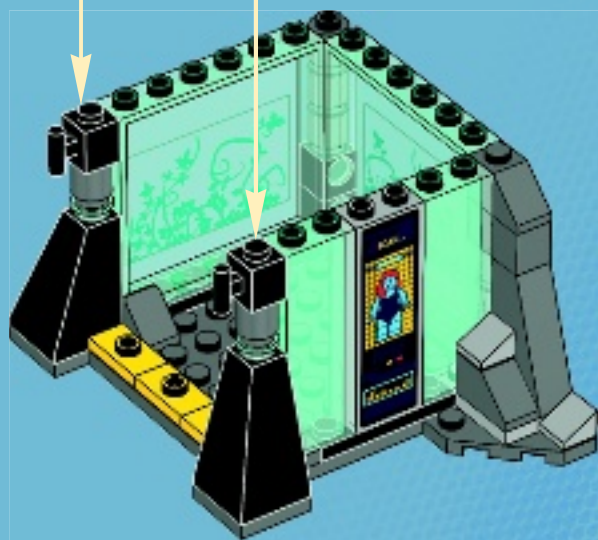



2x

# 16

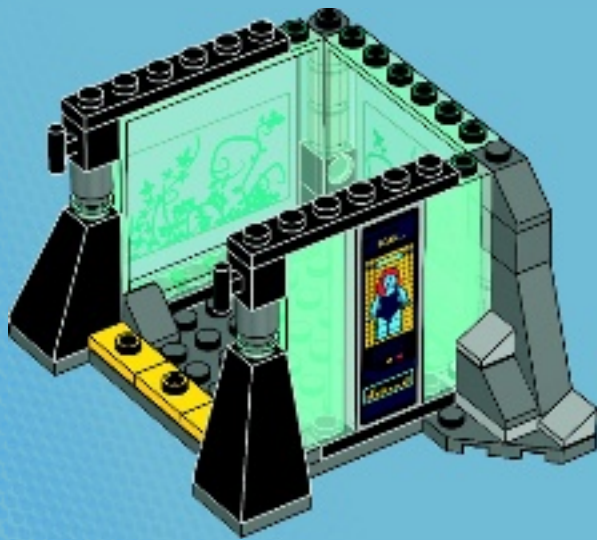

2x



1x

# 17





3x

# 18



2x



2x

# 19



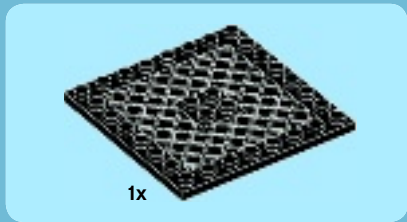

20



21





1x



1x

# 22



1x



2x

# 23





2x



1x



1x

# 24

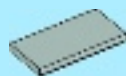
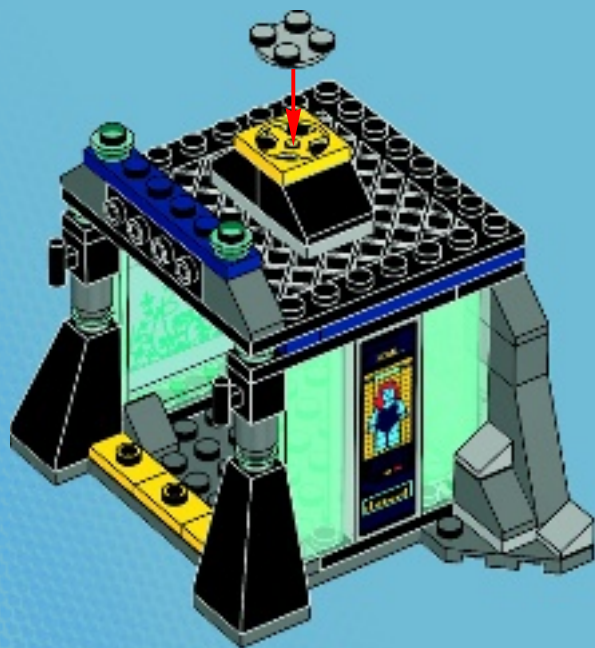

1x

# 25

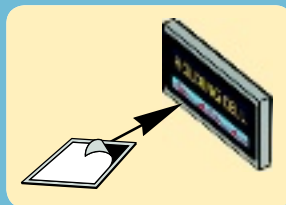





2x

1

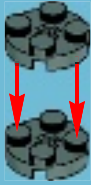

2x

2

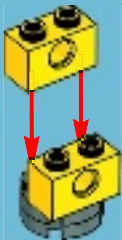

1x



1x

3

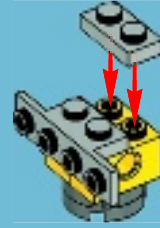

1x



1x

4

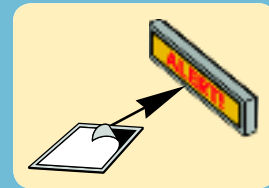



2x



2x



1x

5

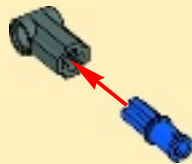

2x

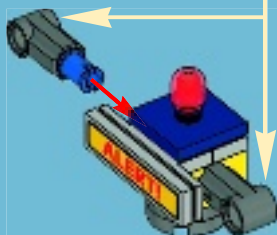

2x



2x

6

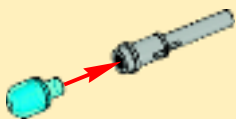

2x

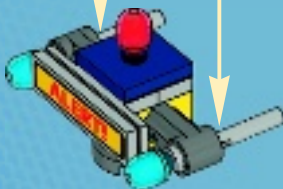

26





27

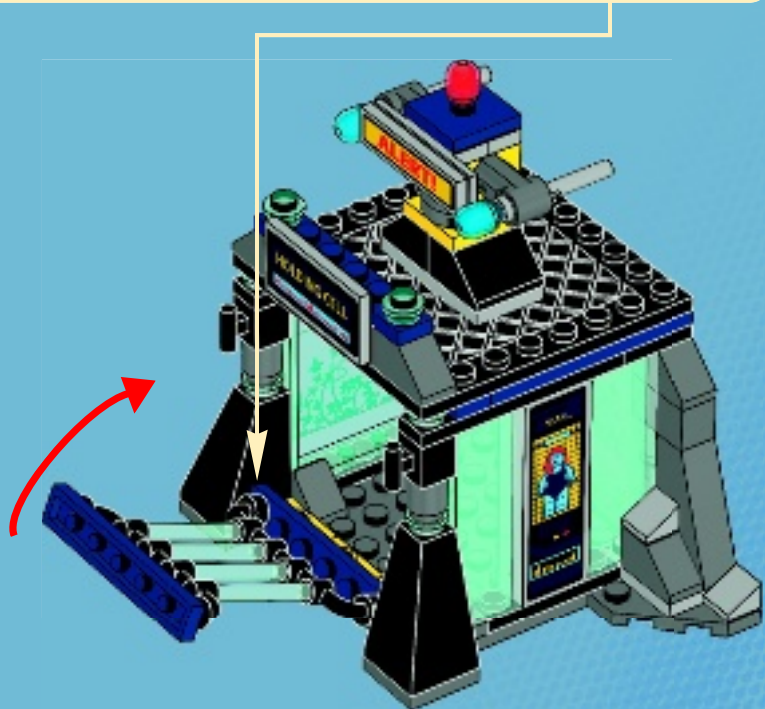
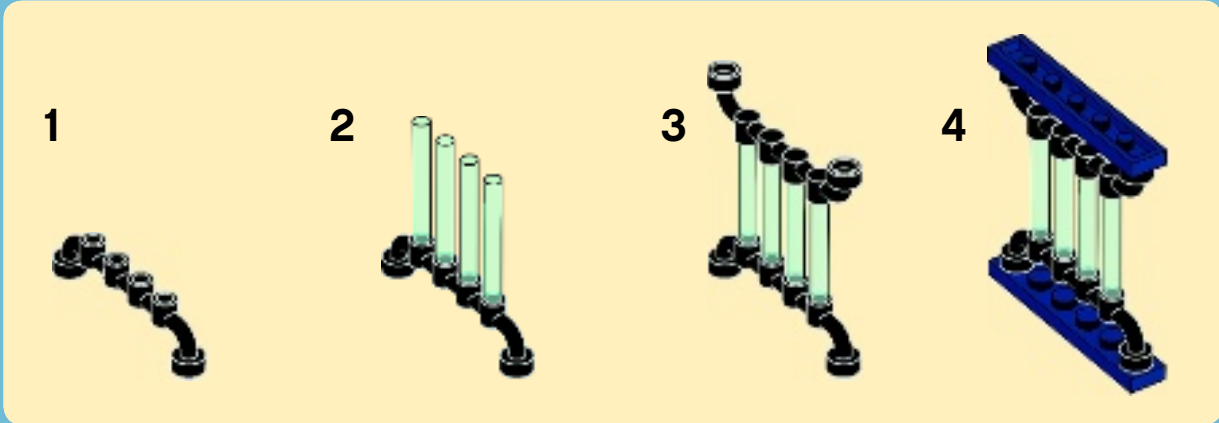

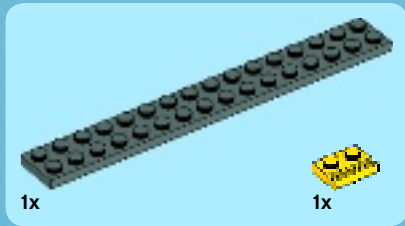
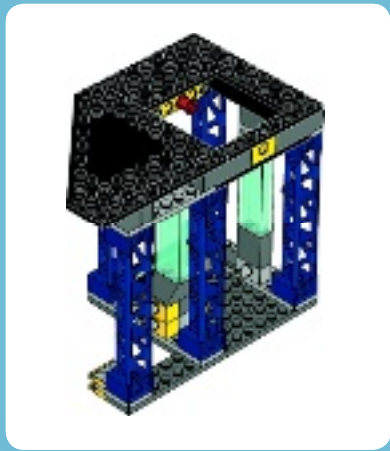

1

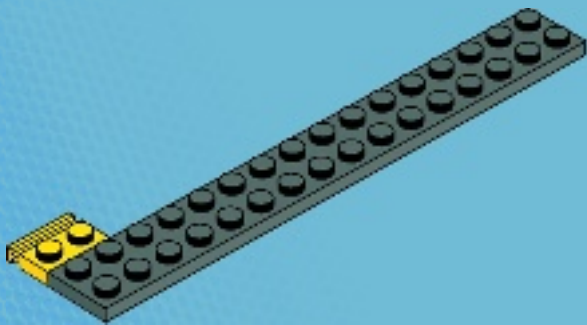

2

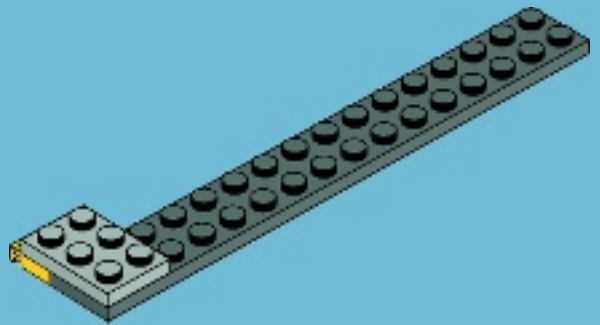



1x

3

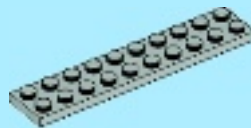
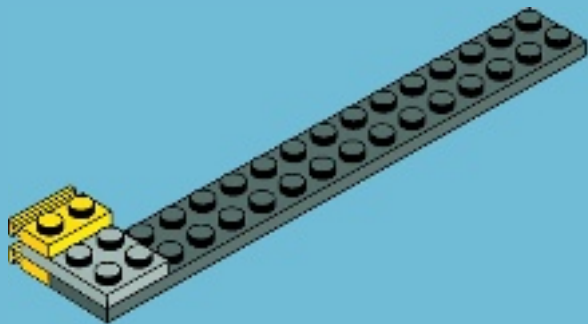

1x



2x

4

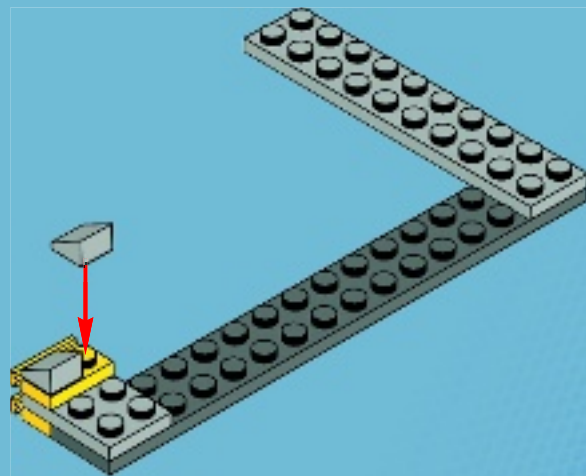



5

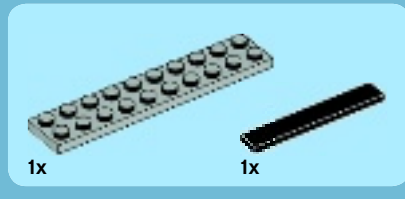
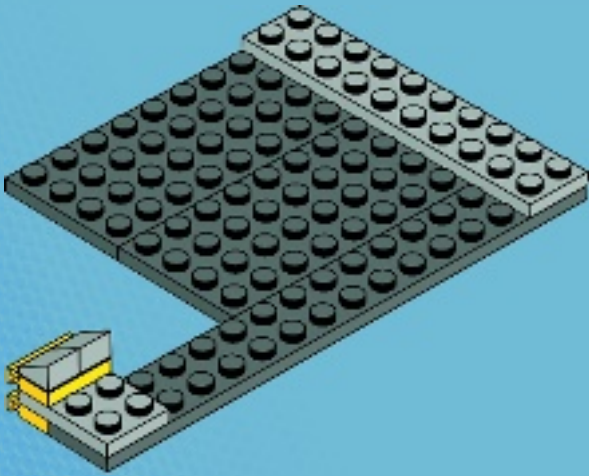

6

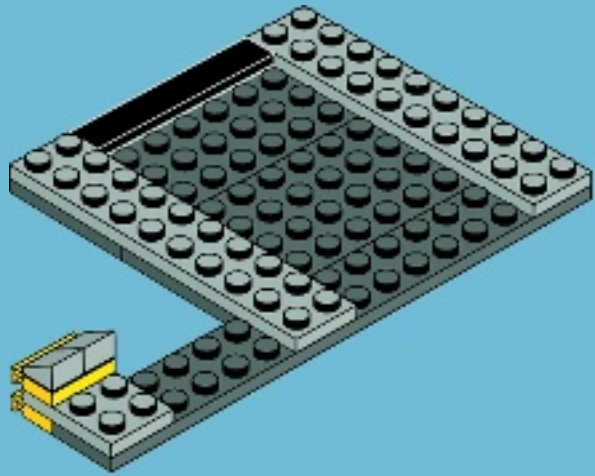



1x



2x

# 7

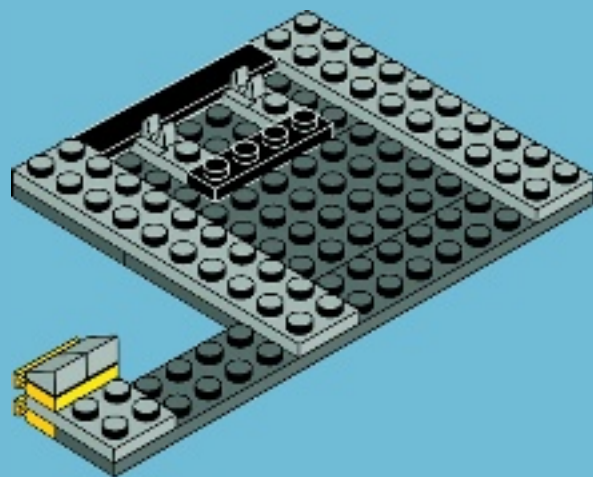

1x



2x

# 8

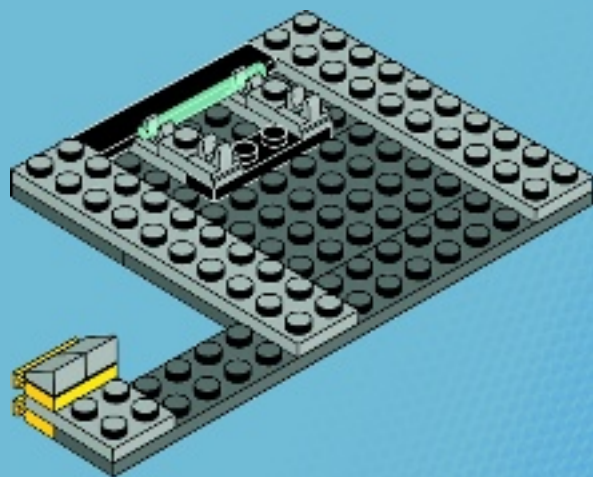



9

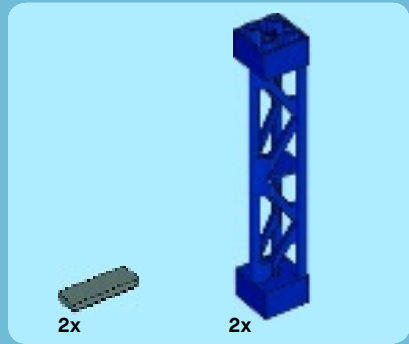

10

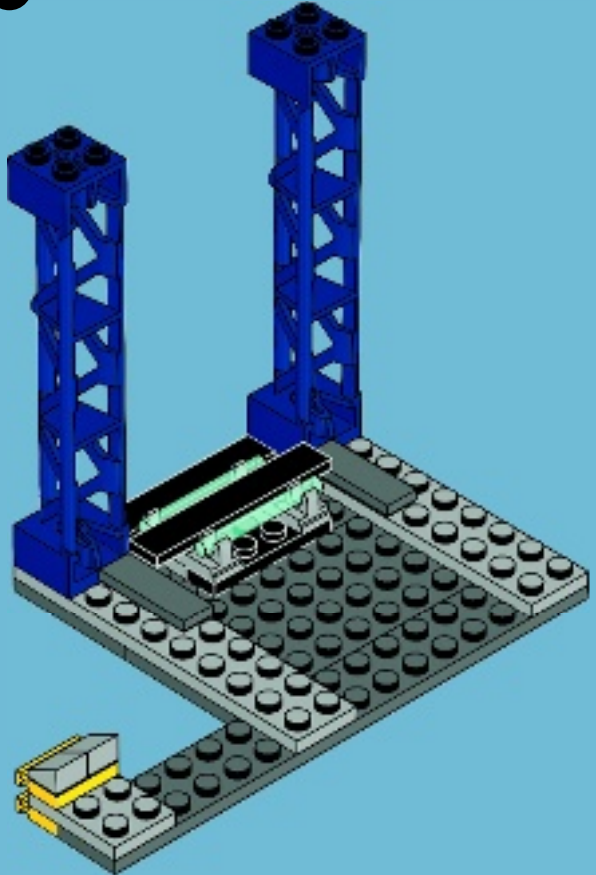
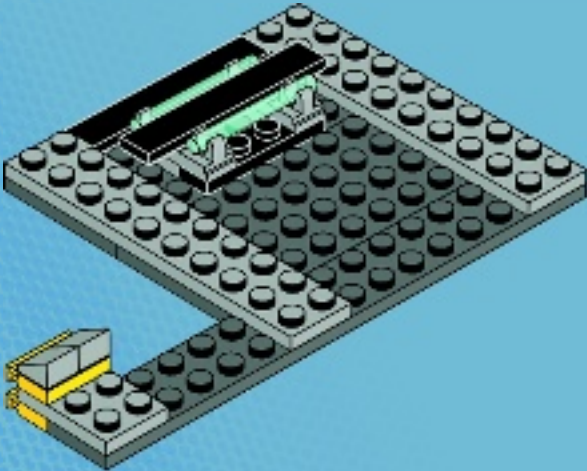





1x



2x

# 11

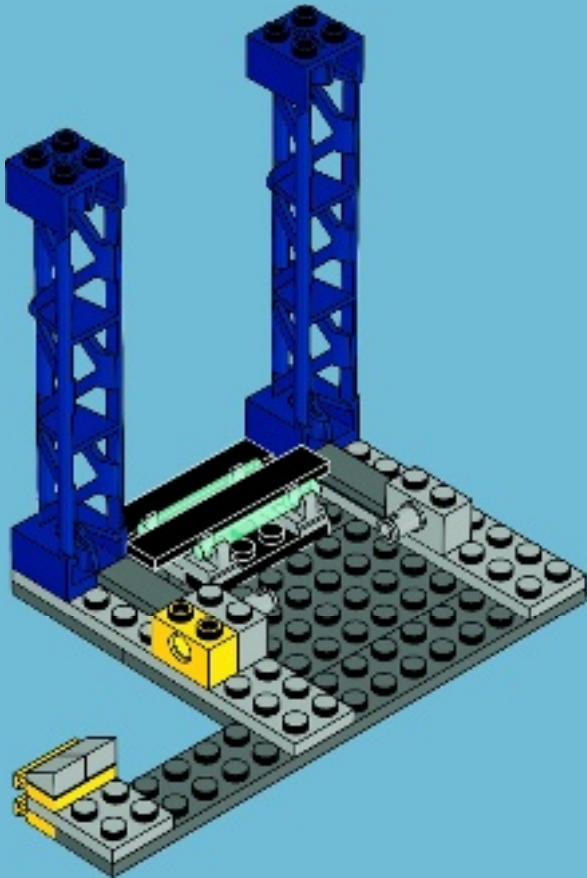

1x



1x



1x

# 12

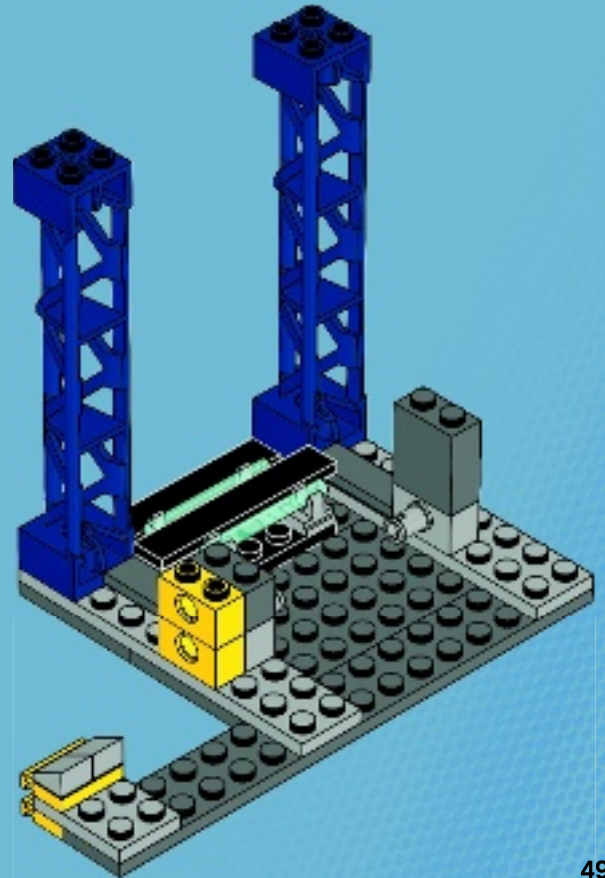



1x



2x

# 13

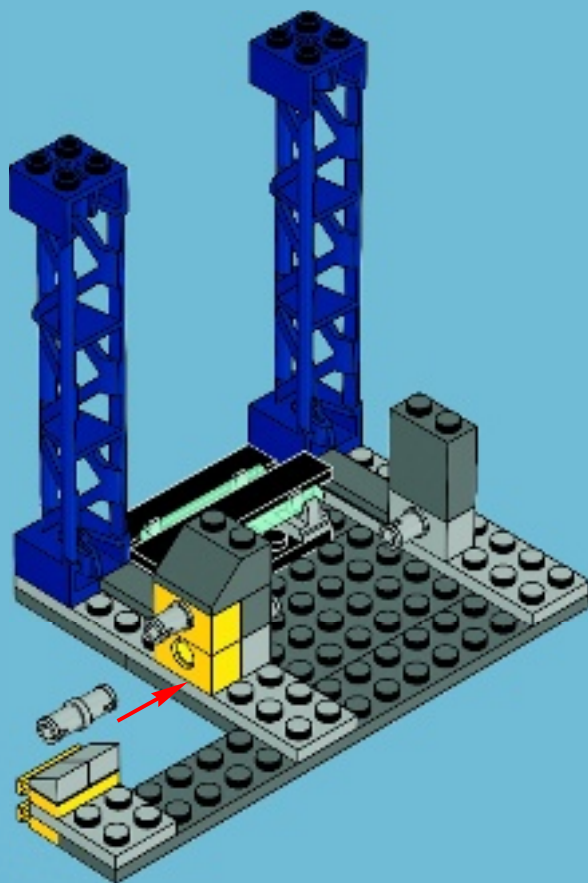

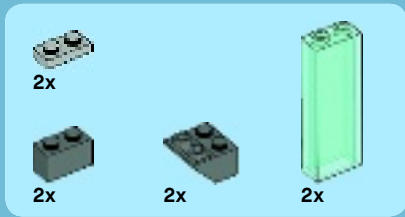

14

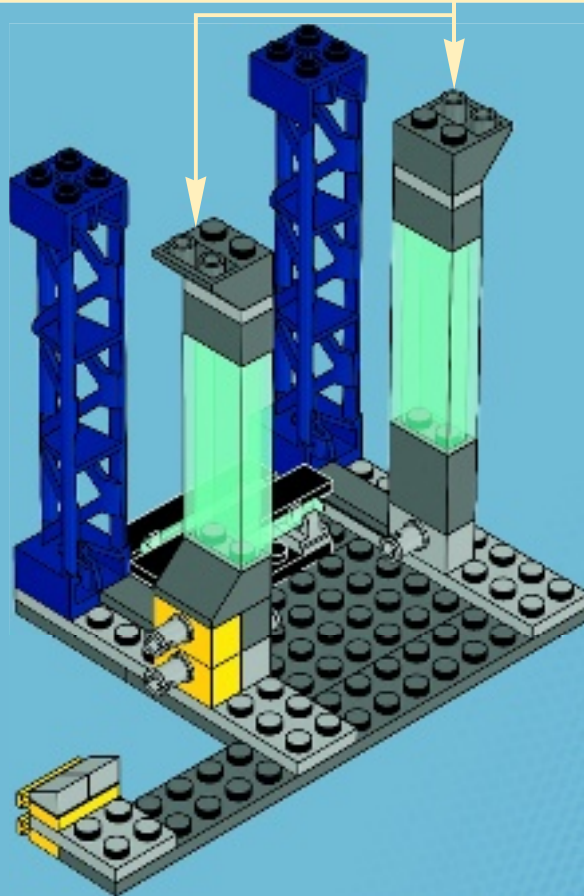
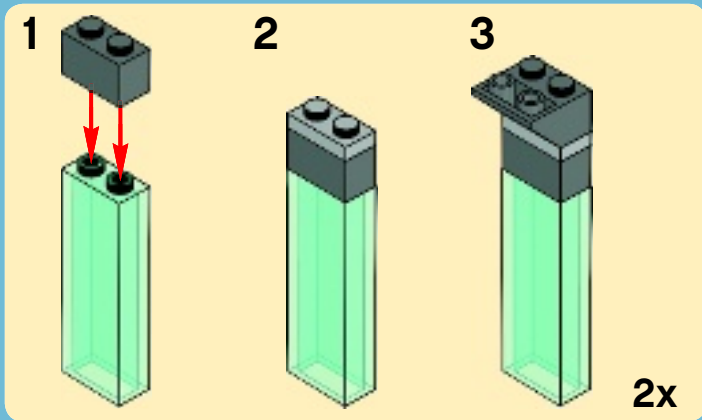



3x

15

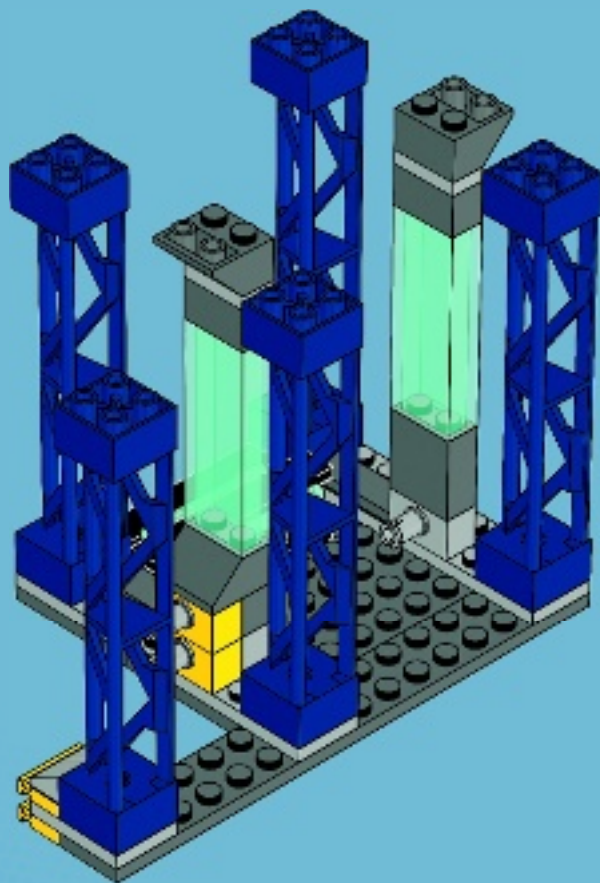

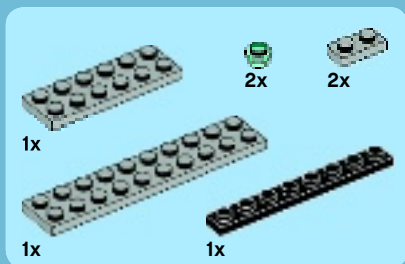

16

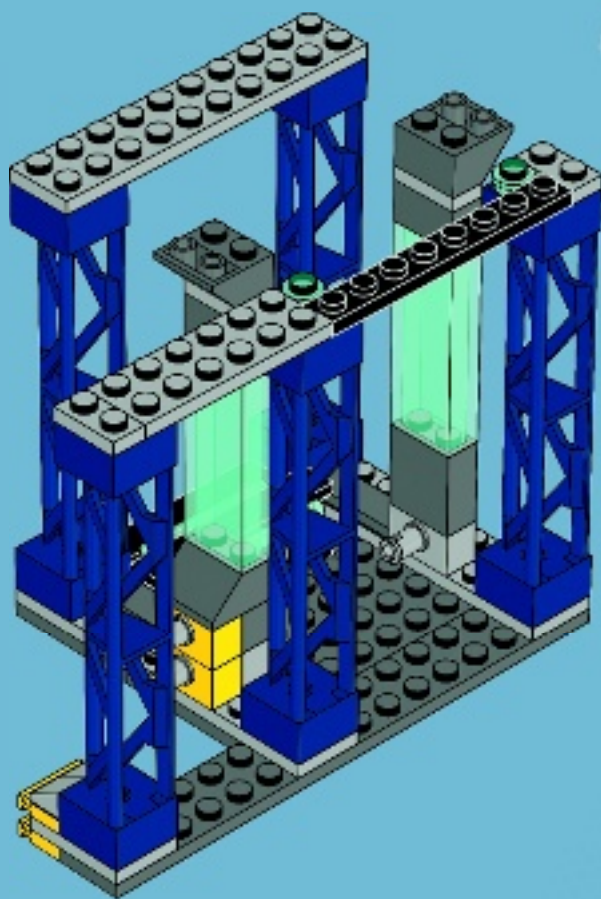



1x



1x

# 17

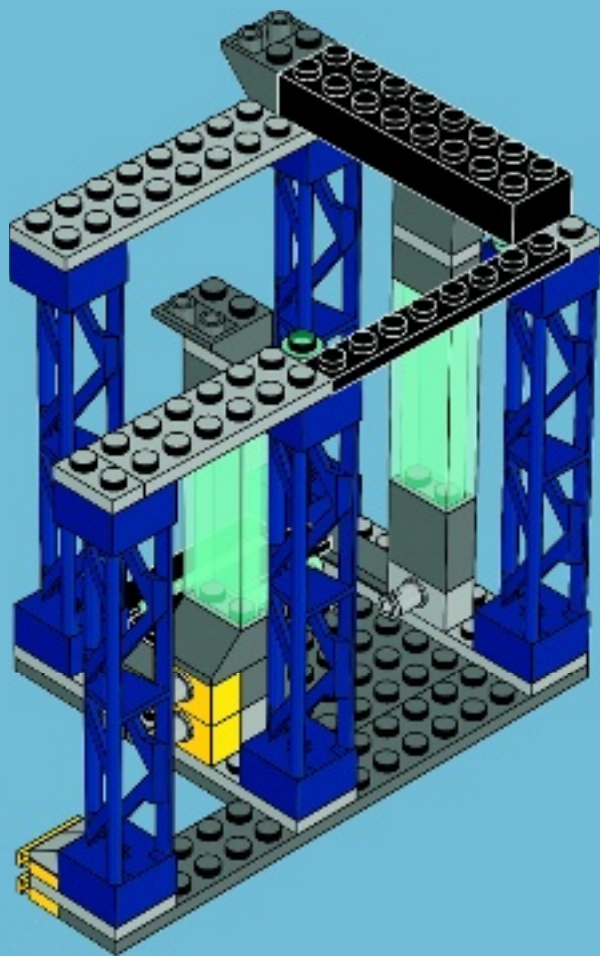



1x



2x

# 18

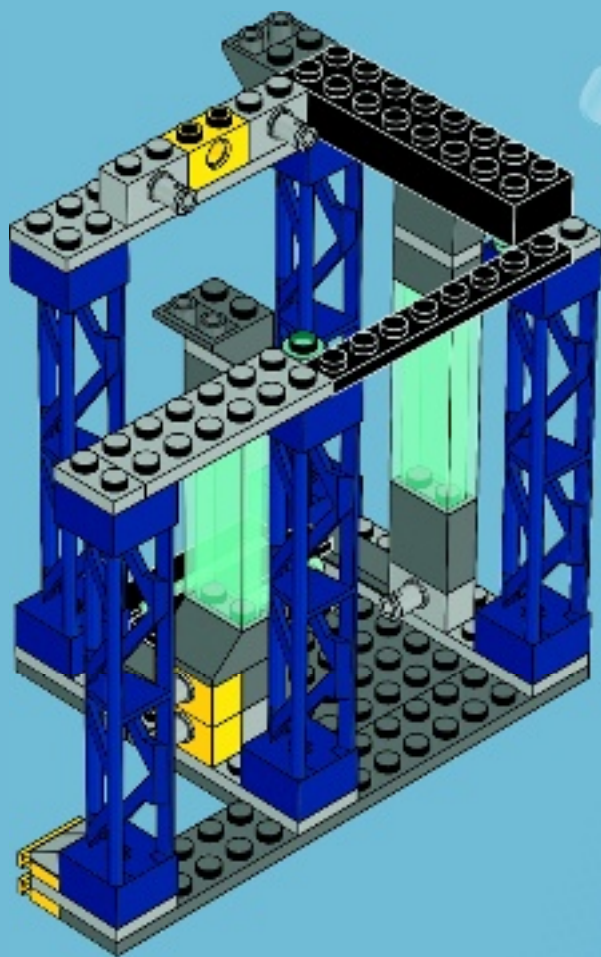



1x

# 19

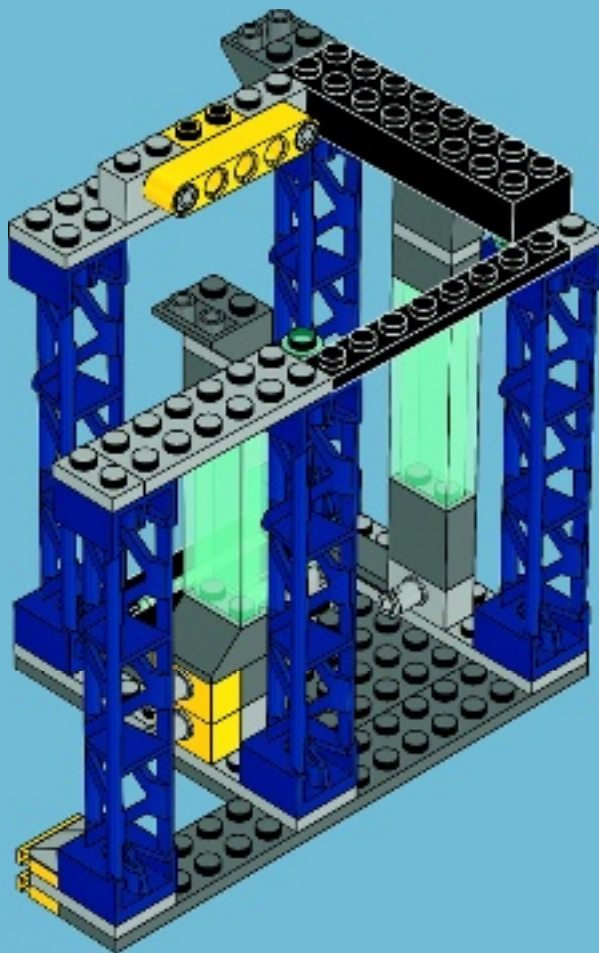



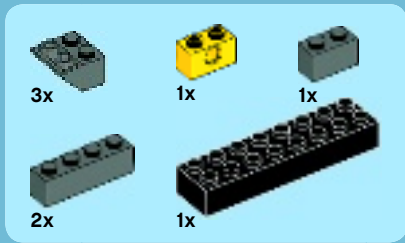

20

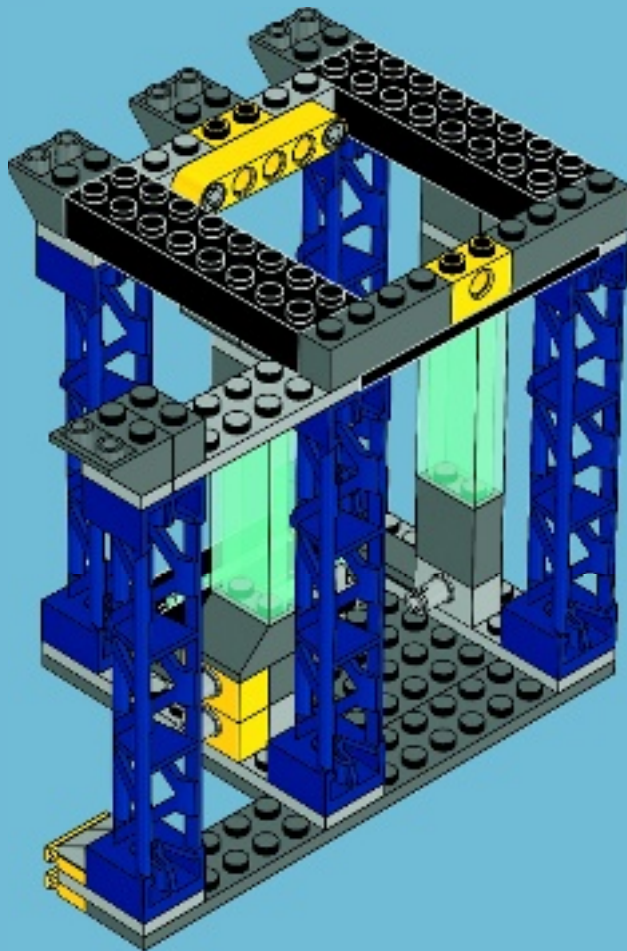

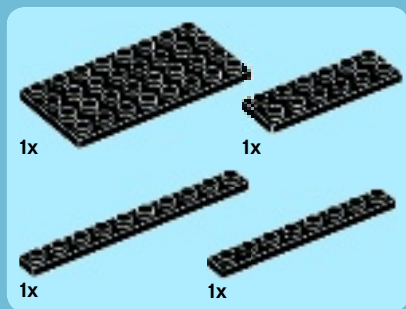

# 21

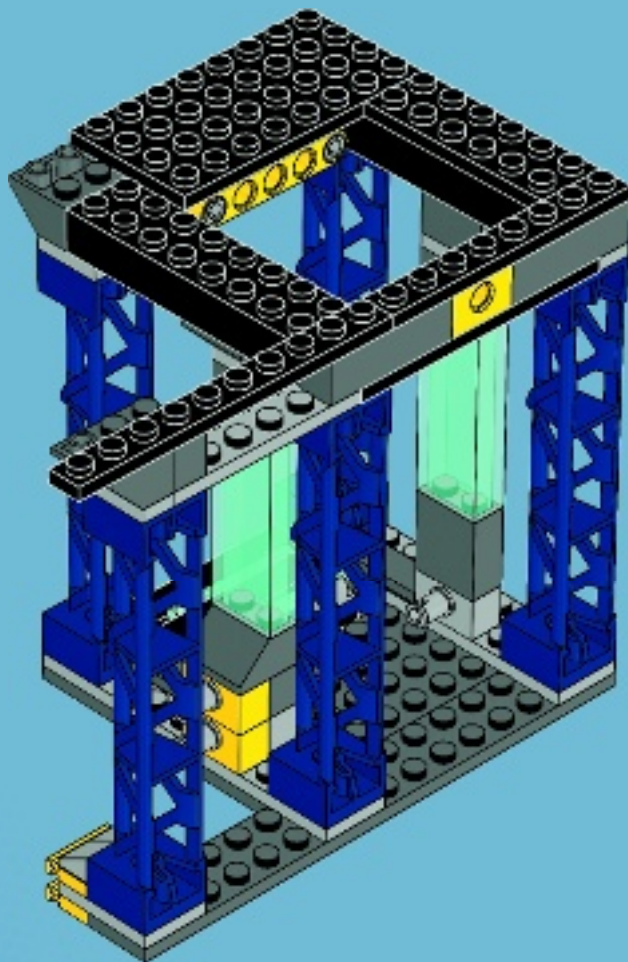

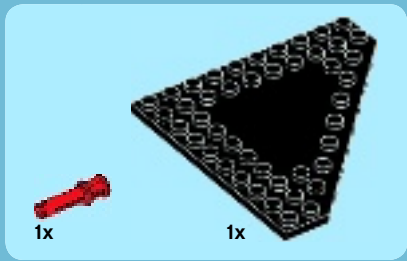

22

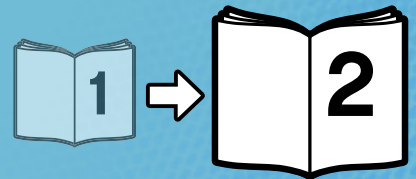
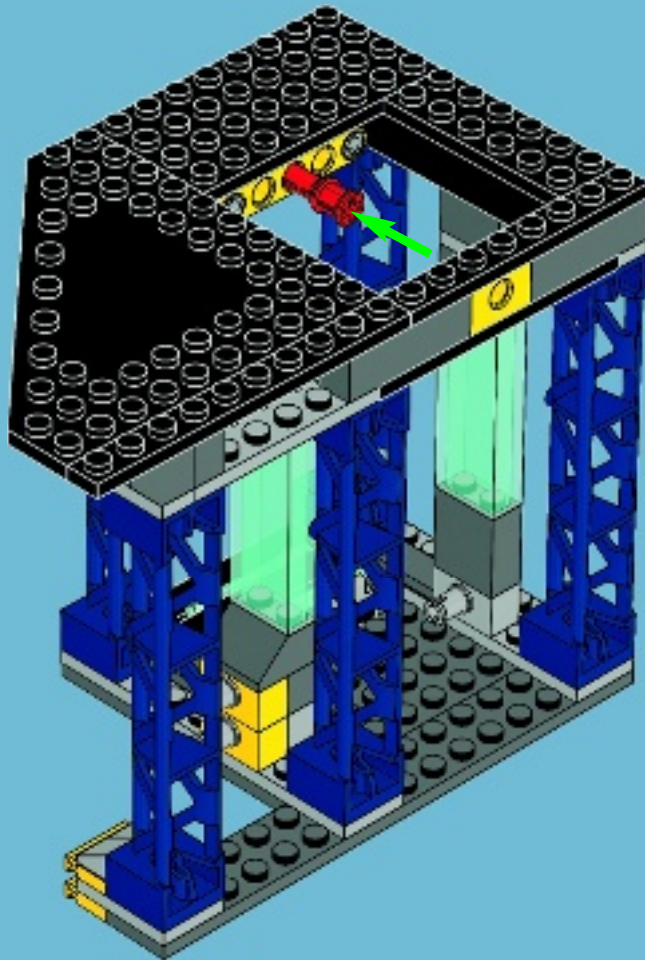



# WIN!

Go to [www.LEGOsurvey.com/product](http://www.LEGOsurvey.com/product) to fill out a survey for a chance to win a cool LEGO® Product.

No purchase necessary.

Open to all residents where not prohibited.



LEGO.com

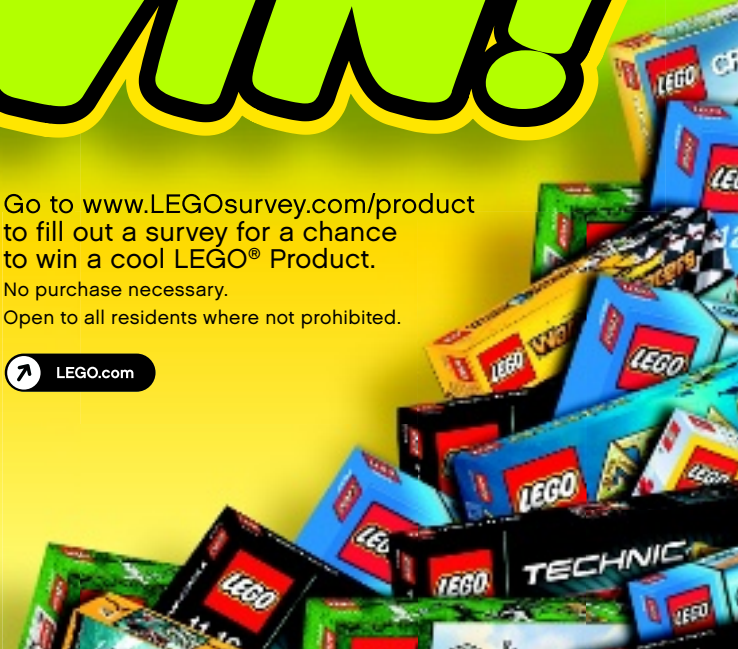

## [www.LEGOsurvey.com/product](http://www.LEGOsurvey.com/product)

### GEWINNE! WIN!

Nimm an der Umfrage auf [www.LEGOsurvey.com/product](http://www.LEGOsurvey.com/product) teil und hab die Chance ein cooles LEGO® Produkt zu gewinnen!

Die Teilnahme am Gewinnspiel führt zu keinerlei Kaufverpflichtungen. Teilnahme in allen nicht ausgeschlossenen Ländern möglich.

Ga naar [www.LEGOsurvey.com/product](http://www.LEGOsurvey.com/product), vul een enquêteformulier in en maak kans op een cool LEGO® product.

Geen aankoopverplichting. Iedereen mag deelnemen, uitgezonderd ingezetenden van landen waar een enquêteverbod geldt.

### GAGNE! 当てよう!

Visite [www.LEGOsurvey.com/product](http://www.LEGOsurvey.com/product) pour répondre à un questionnaire et avoir une chance de gagner un produit LEGO® très cool!

Aucune obligation d'achat. Ouvert à tous les résidents des pays autorisés.

[www.LEGOsurvey.com/product](http://www.LEGOsurvey.com/product) にアクセスしアンケートにご記入ください。当選者には1製品を差し上げます。

お買い上げの必要はありません。

禁止されていない限り、すべての皆様にご利用いただけます。