



2x  
6057414



1x  
6081298



1x  
6081972



1x  
4107106



1x  
6030742



2x  
4164037



1x  
6081300



2x  
4567338



4x  
4523159



1x  
6028026



1x  
6020145



1x  
6020146



1x  
6028037



2x  
4653052



2x  
4520320



1x  
4289542



1x  
4528323



4x  
4210660



1x  
6020189



1x  
6081302



2x  
4636410



1x  
4556158



1x  
614126



1x  
6103643



2x  
4158848



2x  
4143372



2x  
4159335

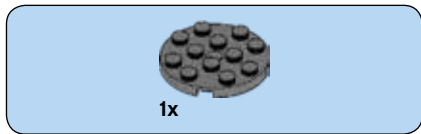
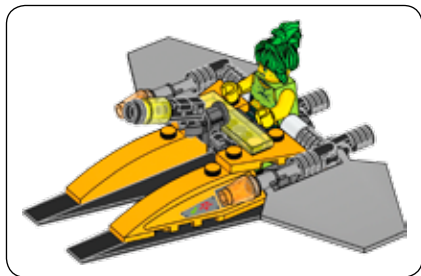

1





4x

2

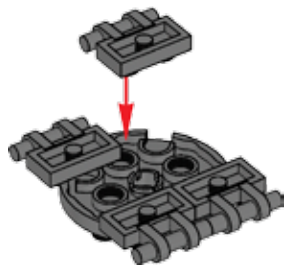

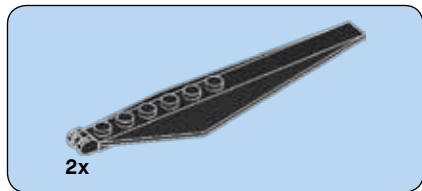

3

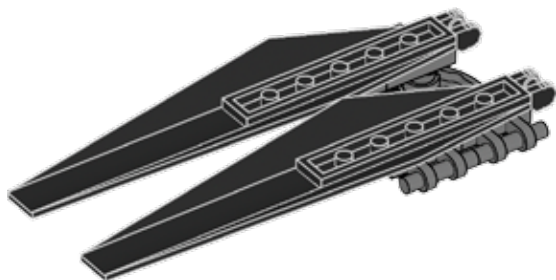



2x



4x

4

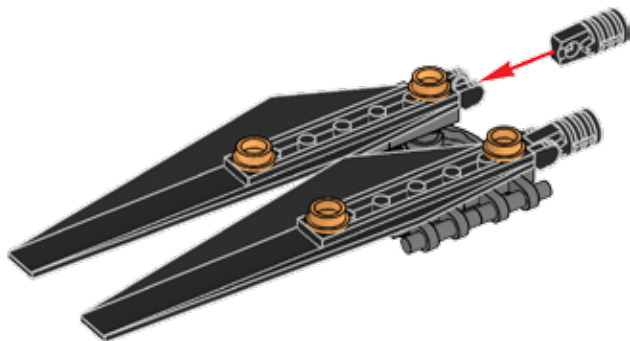

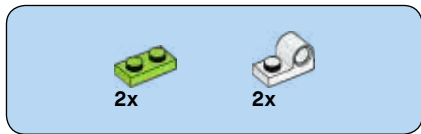

5

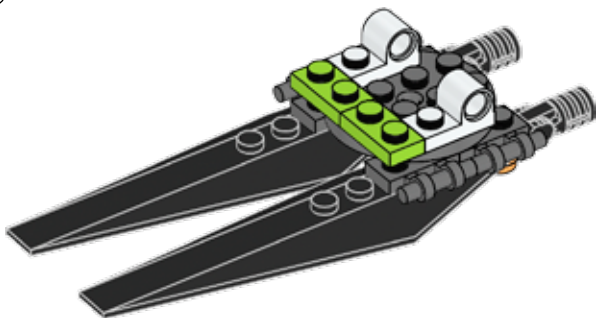
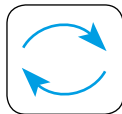

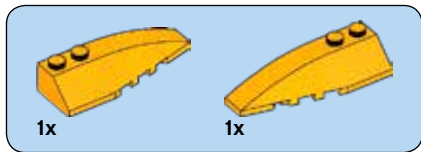

6

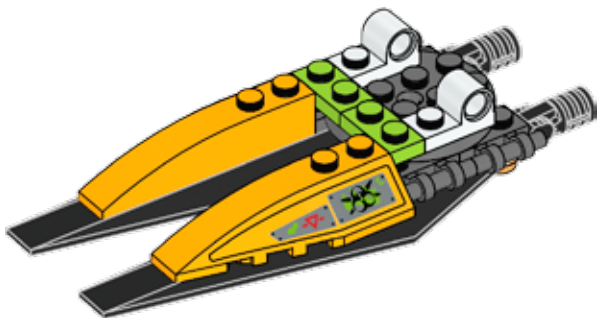

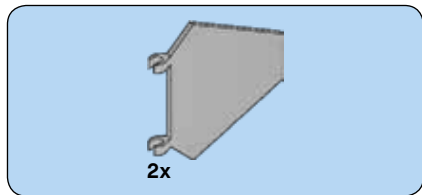

7

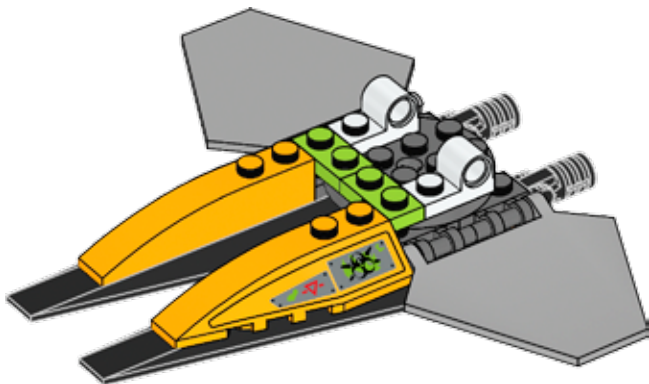





8

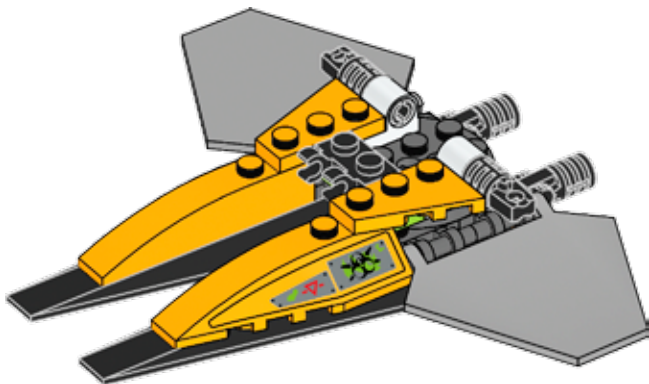

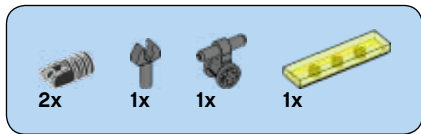

9

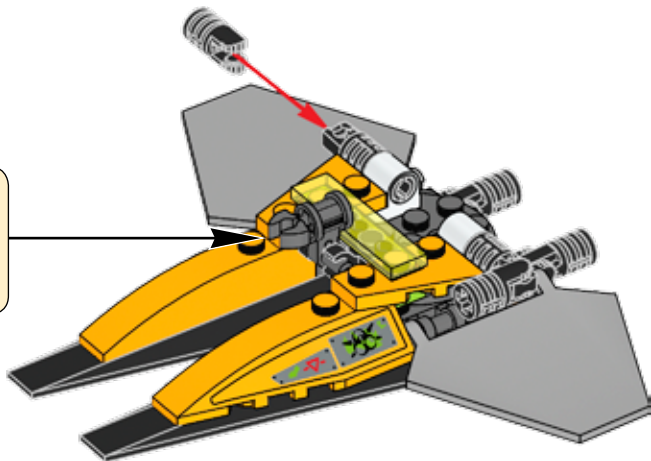
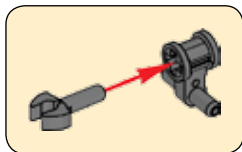

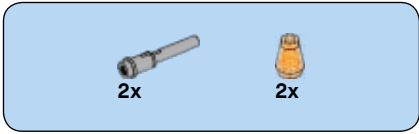

10

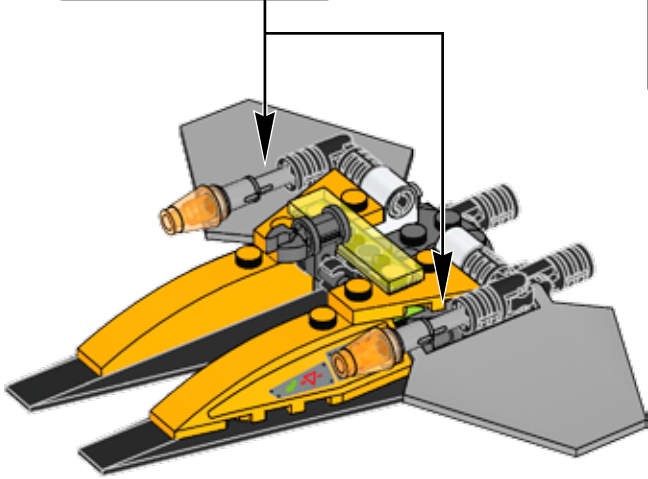
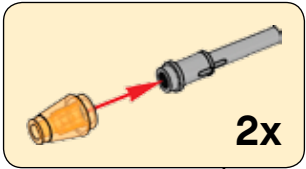

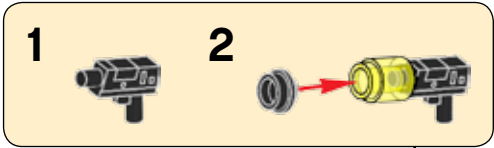

11

