



# ULTRA AGENTS

70173



 [LEGO.com/ultraagents](https://www.LEGO.com/ultraagents)

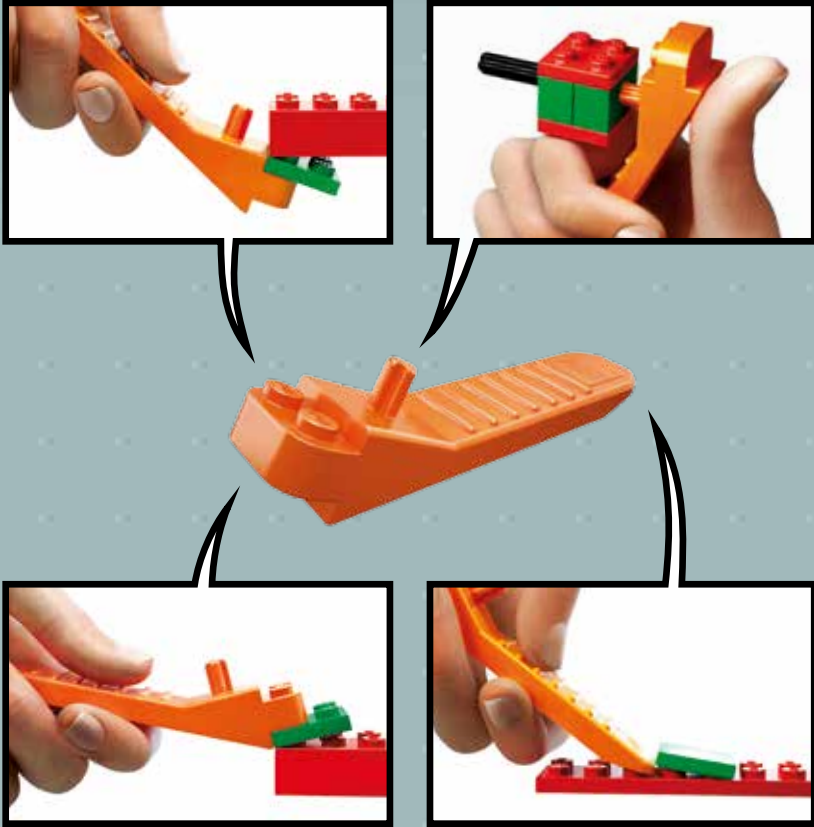

[LEGO.com/brickseparator](https://LEGO.com/brickseparator)

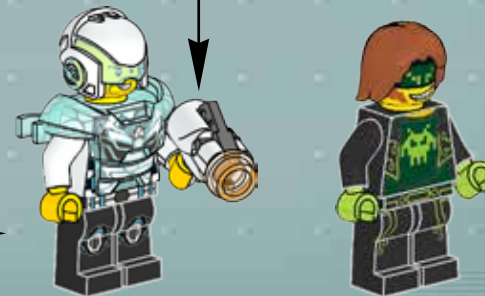
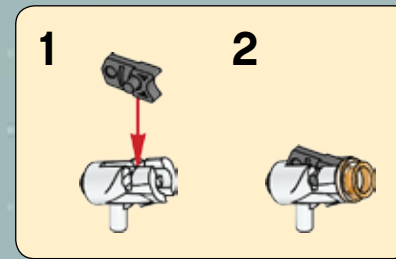
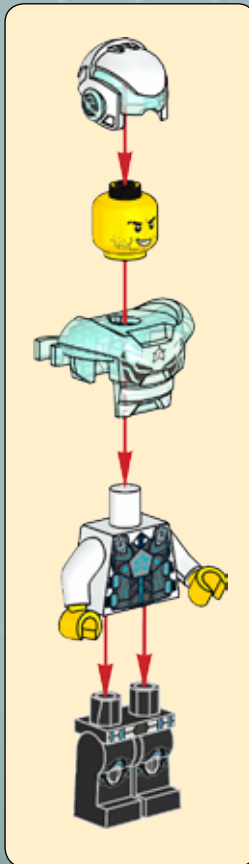

EN IMPORTANT: Never modify the elements or use other projectiles than provided with this toy.  
DE WICHTIG: Die Elemente dürfen nicht verändert werden. Es dürfen ausschließlich die mit dem Spielzeug mitgelieferten Geschosse verwendet werden.  
FR IMPORTANT : Ne jamais modifier les éléments ni utiliser d'autres projectiles que ceux fournis avec ce jouet.  
IT IMPORTANTE: non modificare gli elementi o utilizzare proiettili non forniti con questo prodotto.  
NL BELANGRIJK! Verander niets aan de elementen en gebruik geen andere projectielen dan de bij het speelgoed geleverde.  
ES IMPORTANTE: No modifique los elementos ni utilice otros proyectiles diferentes a los suministrados junto con este juguete.  
DA VIGTIGT: Elementerne må ikke ændres, og der må ikke bruges andre projektiler end dem, der følger med legetøjet.  
FI TÄRKEÄÄ: Älä koskaan tee osiin muutoksia tai käytä lelussa muita kuin sen sisältämiä ammuksia.  
SV VIKTIGT: Modifiera aldrig delarna och använd aldrig andra projektiler än de som medföljer denna leksak.  
PT IMPORTANTE: Nunca modifique os elementos nem utilize projécteis que não tenham sido fornecidos com este brinquedo.  
EL ΣΗΜΑΝΤΙΚΟ: Ποτέ μην τροποποιείτε τα στοιχεία του παιχνιδιού και μην χρησιμοποιείτε άλλα βλήματα εκτός από αυτά που συνοδεύουν αυτό το παιχνίδι.  
JA 重要：部品を改造したり、本製品に付属の発射体以外のものを使用しないようにしてください。  
ZH 重要提示：切勿更改组件或使用并非由本玩具附带的弹丸。  
KO 중요함: 이들 부품을 수정하거나 이 완구의 함께 제공된 것이 아닌 발사체는 결코 사용하지 마십시오.  
RU ВАЖНО: запрещается вносить изменения в элементы или использовать другие снаряды, отличные от тех, которые поставляются с данной игрушкой.  
PL WAŻNE: Nigdy nie modyfikować elementów zabawki ani nie używać pocisków innych niż dostarczone z zabawką.  
CZ UPOZORNĚNÍ: Nikdy neupravujte součástky a nepoužívejte jiné projektily než ty, které jsou dodávány s touto hračkou.  
SK UPOZORNENIE: Nikdy neupravujte súčiastky a nepoužívajte iné projektily než tie, ktoré sú dodávané s touto hračkou.  
HU FONTOS: Az elemeket nem szabad módosítani, és a játékhoz adott lövedékek helyett sem szabad mást használni.  
UA ВАЖЛИВО: забороняється вносити зміни до елементів або використовувати інші снаряди на відміну від тих, що поставляються з цією іграшкою.  
HR VAŽNO: Nemojte nikad mijenjati elemente ili koristiti druge projekte osim onih koji su bili priloženi uz ovu igračku prilikom kupnje.  
SR Важно: Немојте да модификујете елементе и не користите друге пројектиле осим оних који долазе уз ову играчку.  
SL POMEMBNO: Nikoli ne spreminjajte elementov in uporabljajte le izstrelke, ki so bili priloženi tej igrači.  
RO IMPORTANT: Nu modificați niciodată elementele și nu utilizați alte proiectile decât cele furnizate cu această jucărie.  
BG ВАЖНО: Не видоизменяйте елементите и не използвайте други снаряди освен приложените към тази играчка.  
LV SVARĪGI! Nekad nepārveidojiet rotālietas elementus, vienmēr izmantojiet tikai tās komplektā iekļautās lodītes.  
ET OLULINE: Mänguasja osi ei tohi teistega asendada, kasutada võib ainult kaasasolevat heitkeha.  
LT DĖMESIO! Niekuomet nekeiskite elementų ir naudokite tik tuos šovinius, kurie yra pridėti prie šio žaislo.  
TR ÖNEMLİ: Hiçbir zaman parçalarda değişiklik yapmayın veya bu oyuncakla sağlananlar dışında mermiler kullanmayın.



1

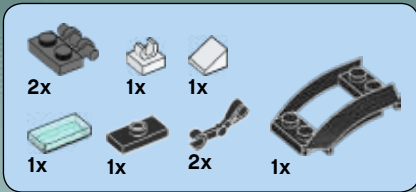

2

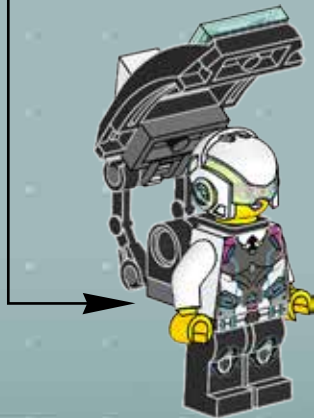
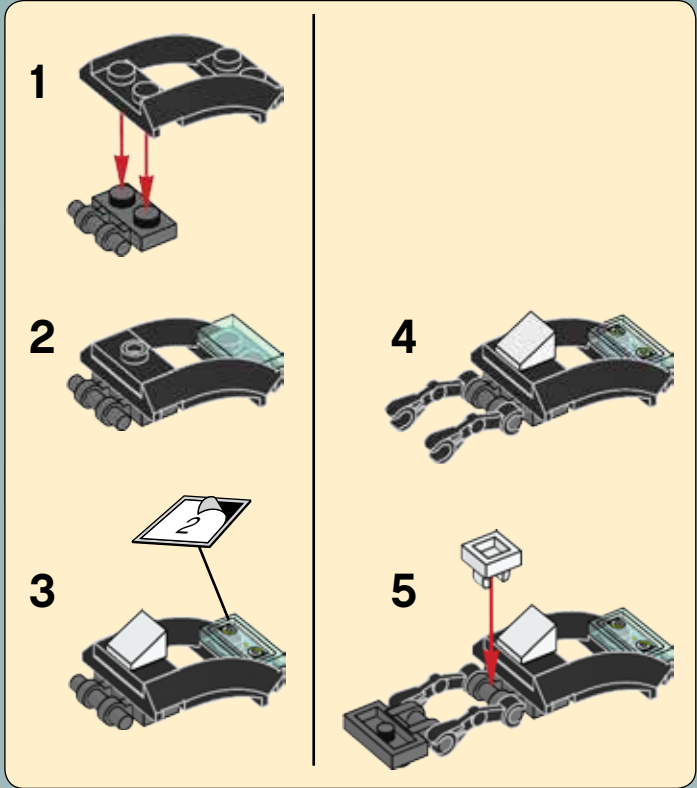

# 3

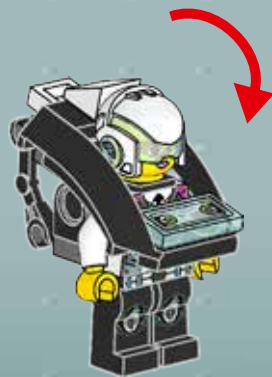

# 4

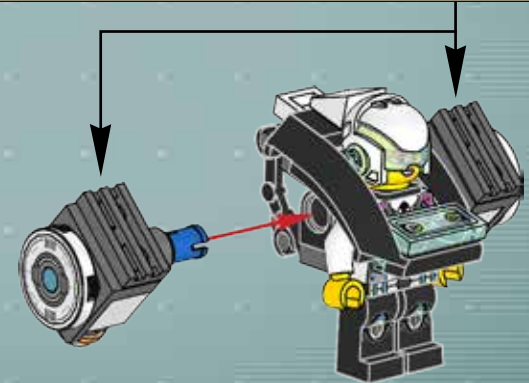
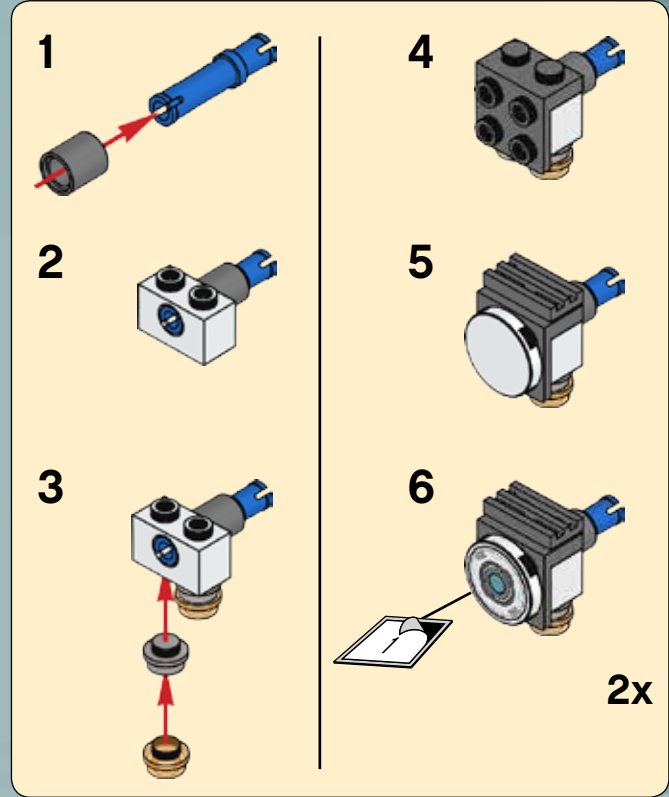
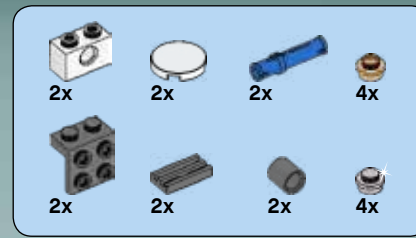



1

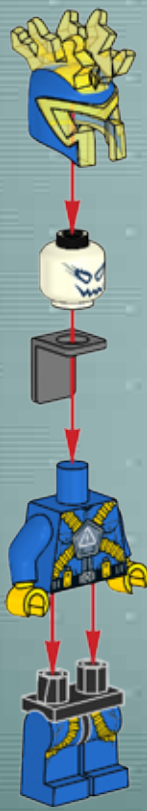

2

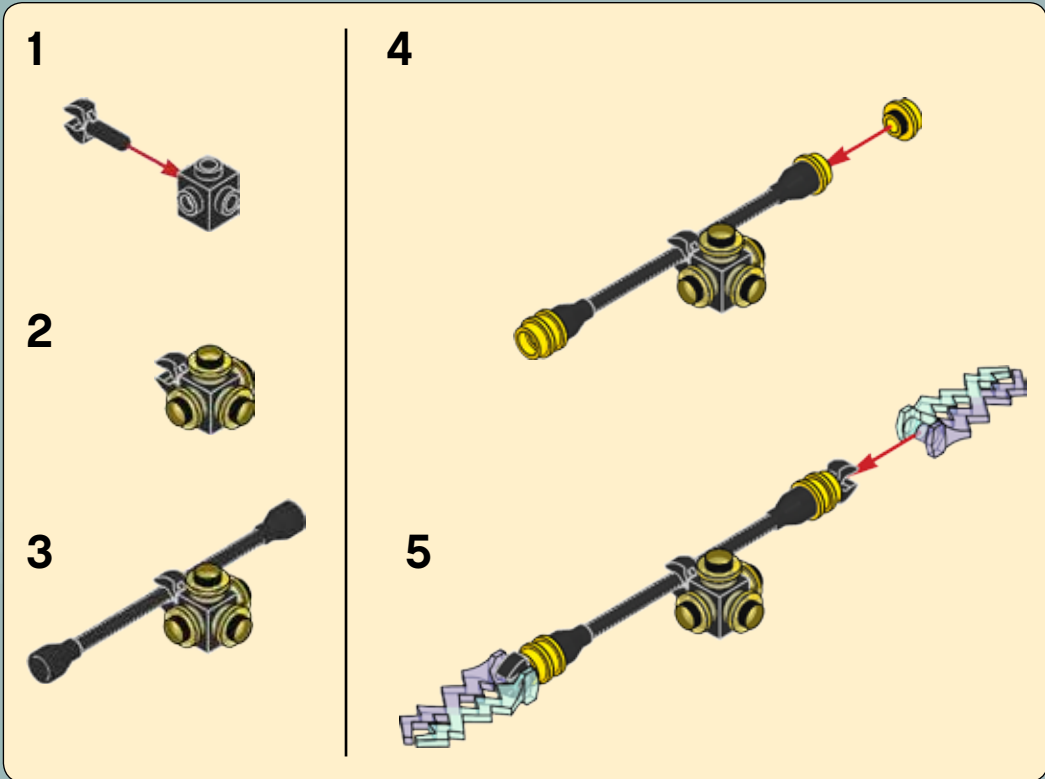

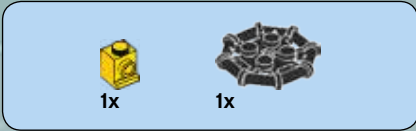
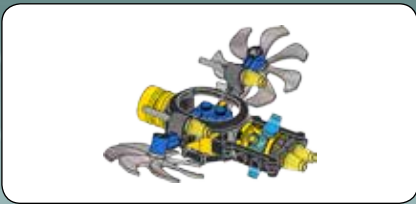

1



2



3

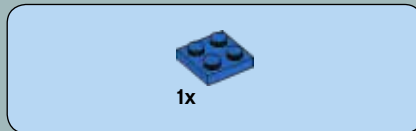
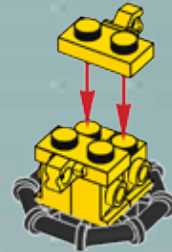

4





5

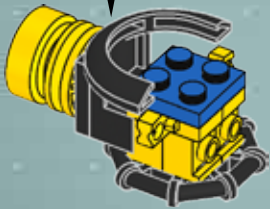
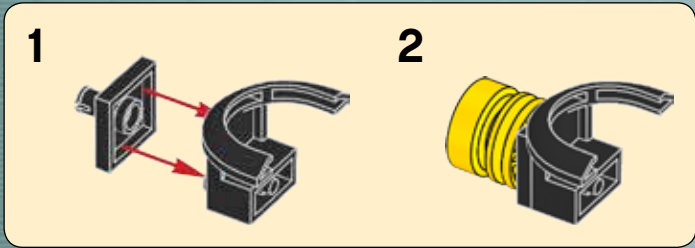

6

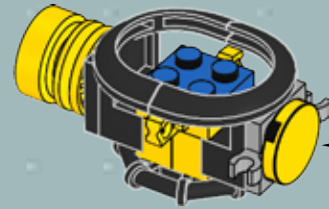
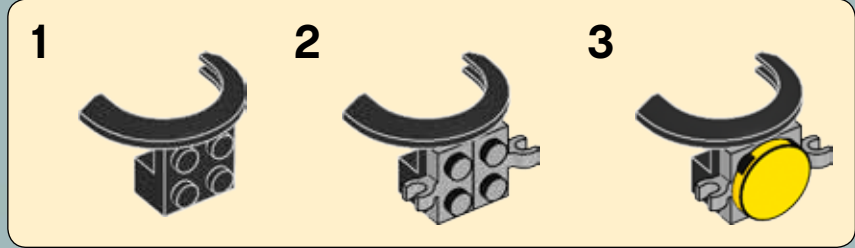



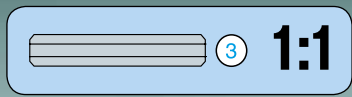

7

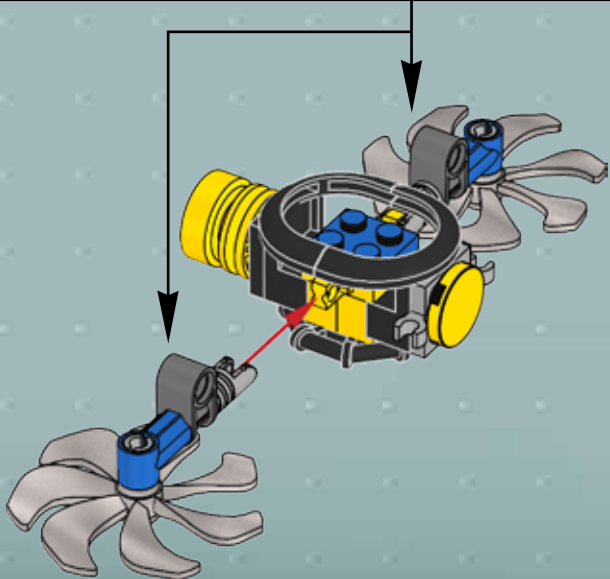
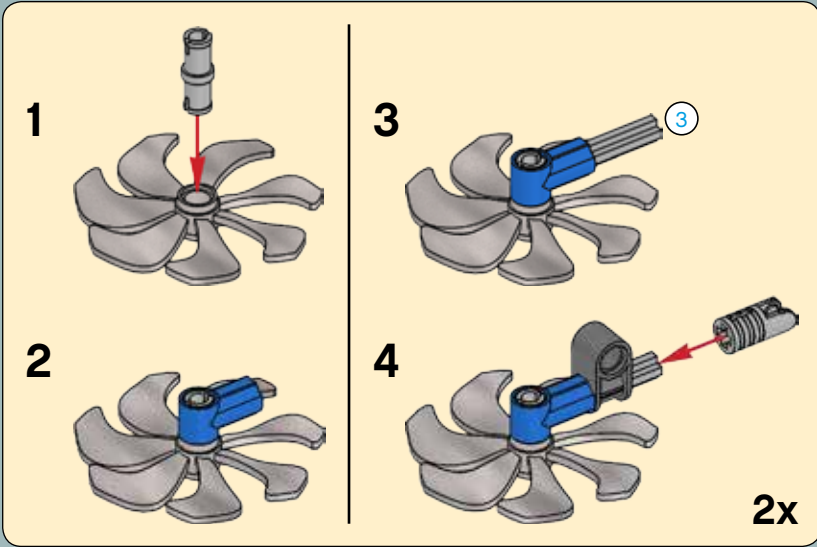

8

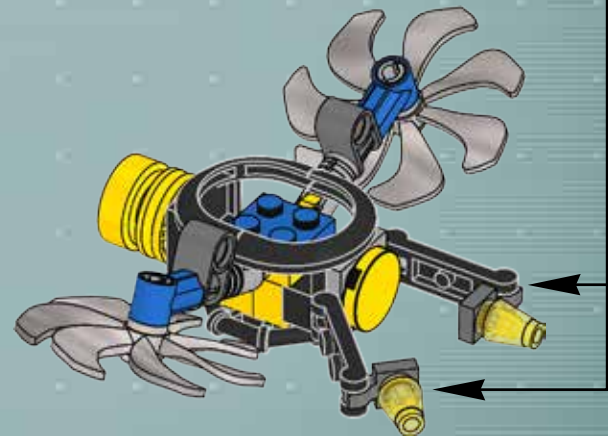
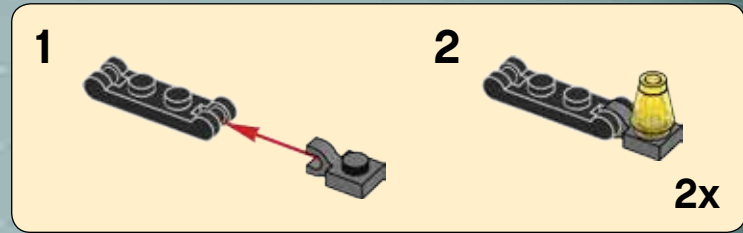

- 1x 
- 2x 
- 1x 
- 4x 

9

1



2



3



4



- 1 
- 2  2x

5

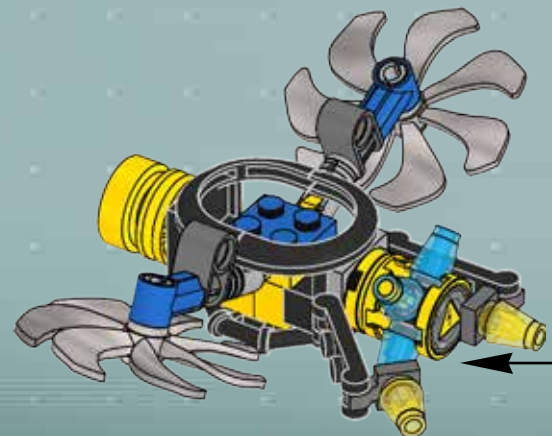



10

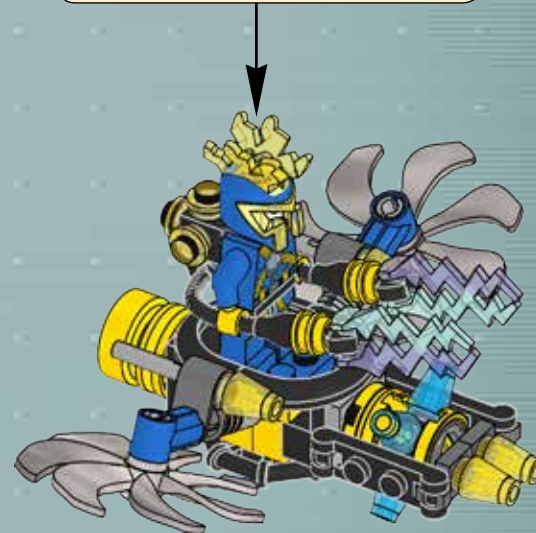
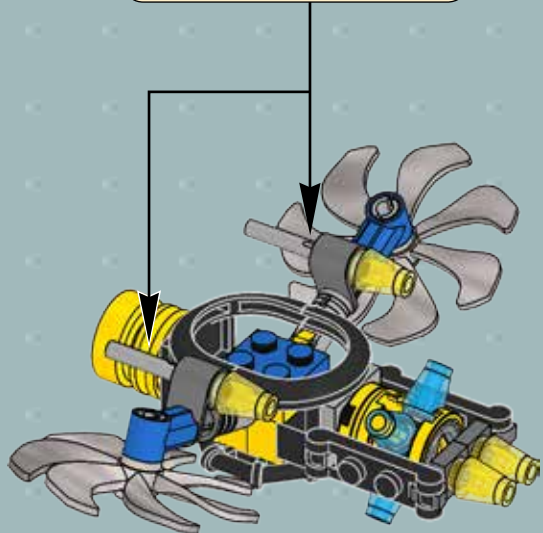
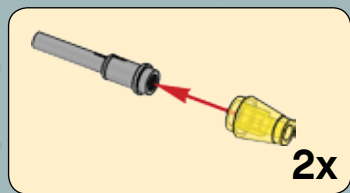



1x

1x

1

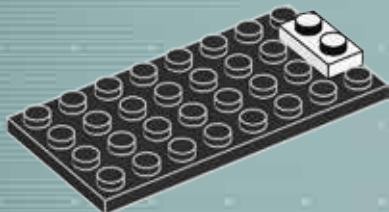

1x

4x

2

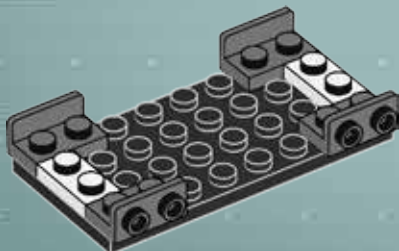

2x

2x

3

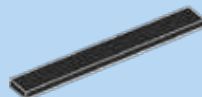
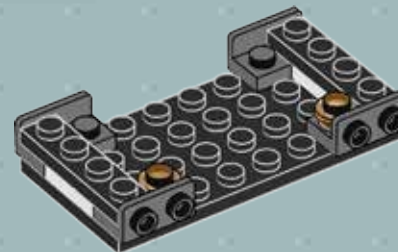

2x

4



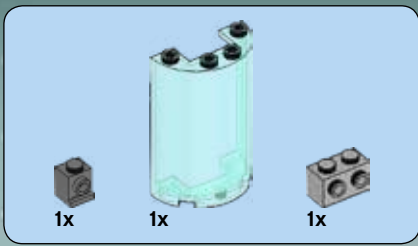

5

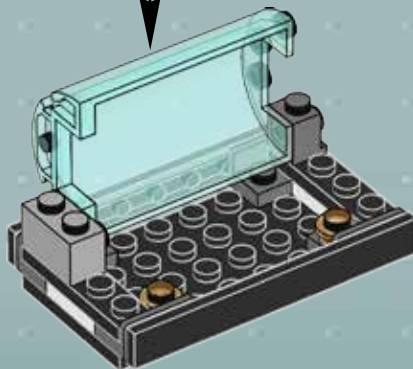
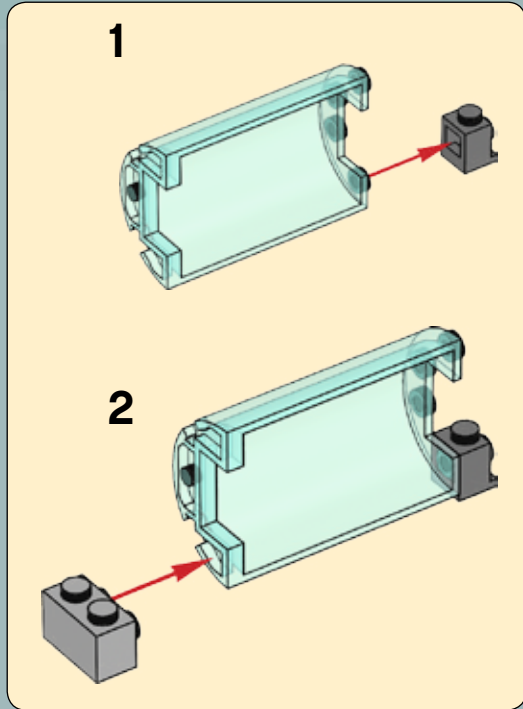

6

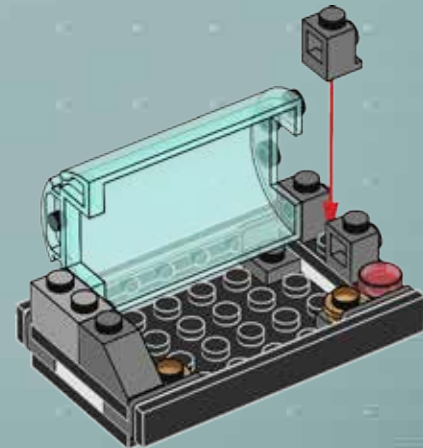

7

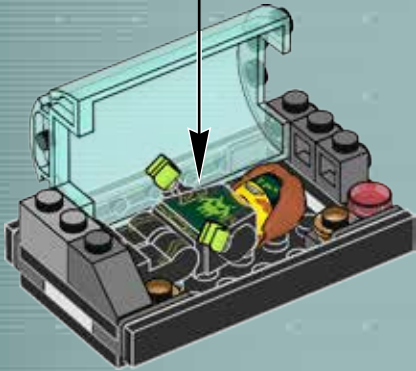

2x

8

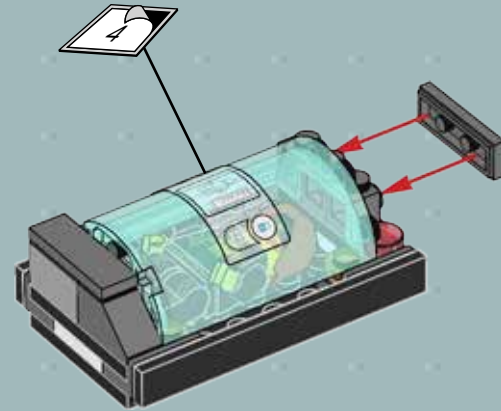

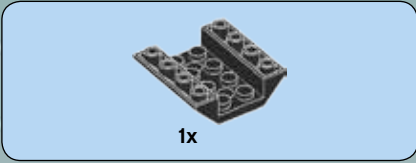

1

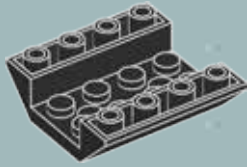

2

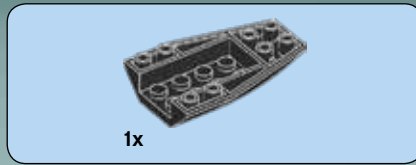
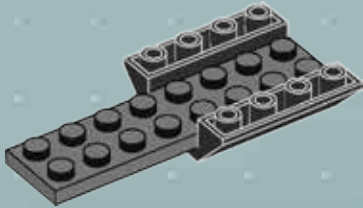

3

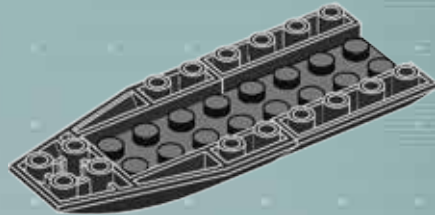

4





2x



1x

# 5

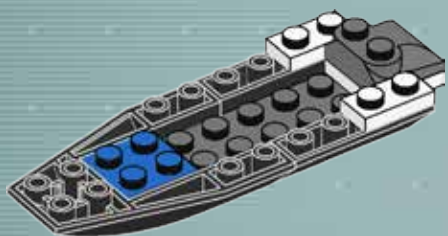

4x

# 6

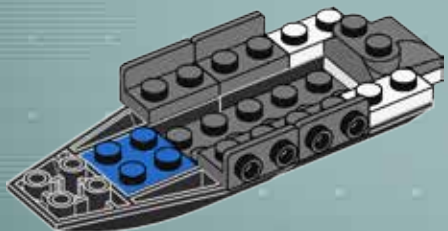

1x



4x

# 7

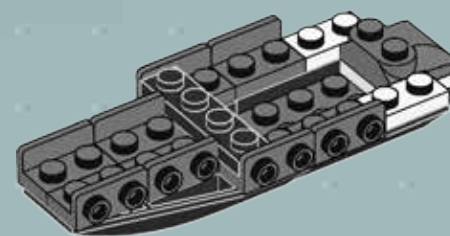

2x



1x

# 8

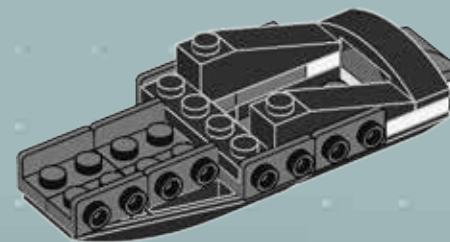





9

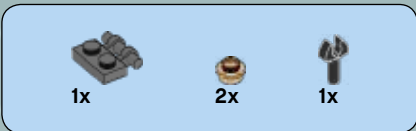
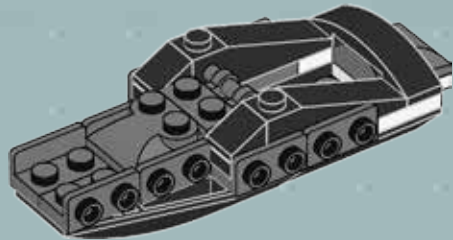

10

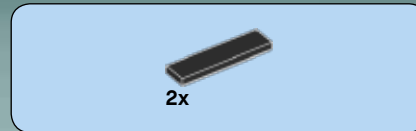
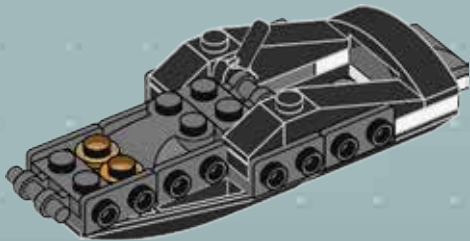

11

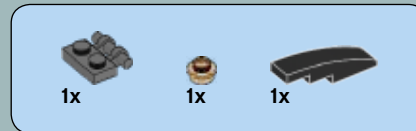
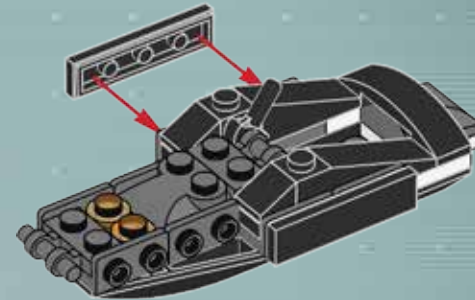

12

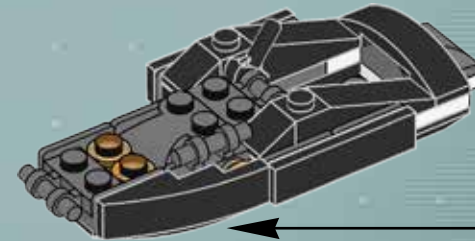
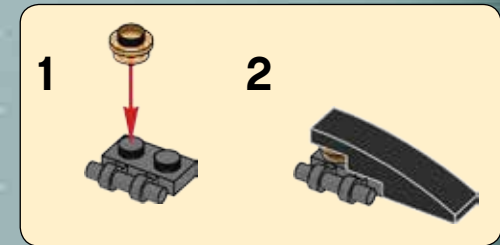

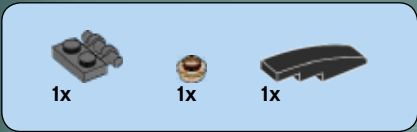

# 13

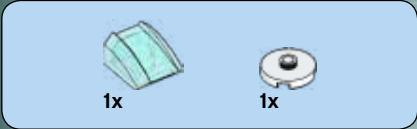
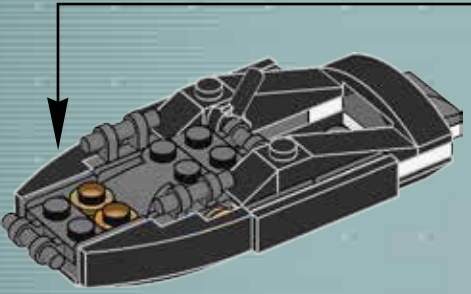
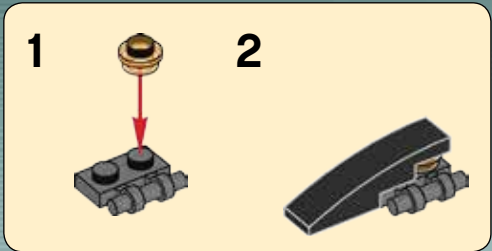

# 14

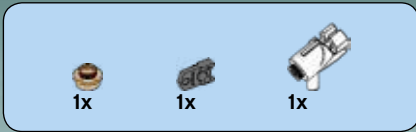
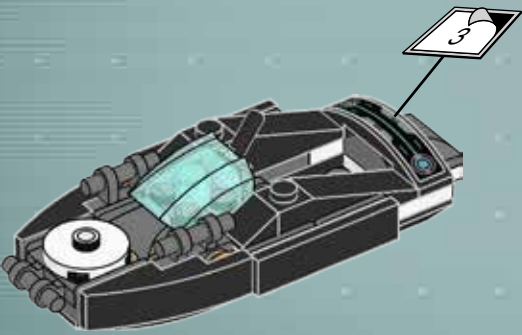

# 15

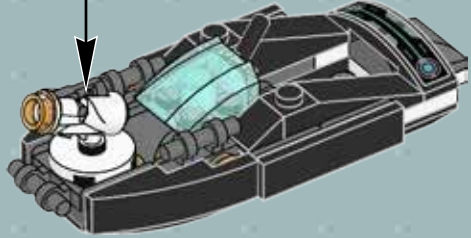
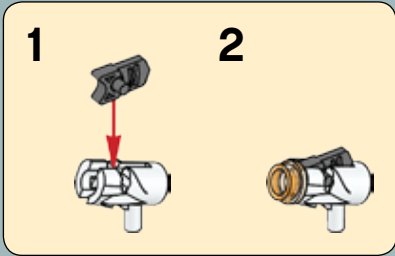

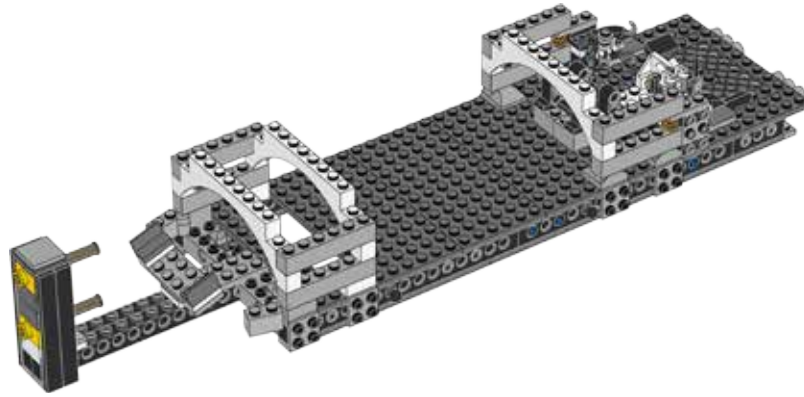

1x

1

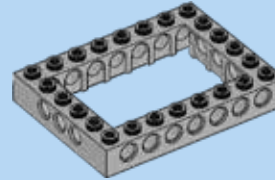
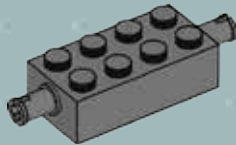

2x

2

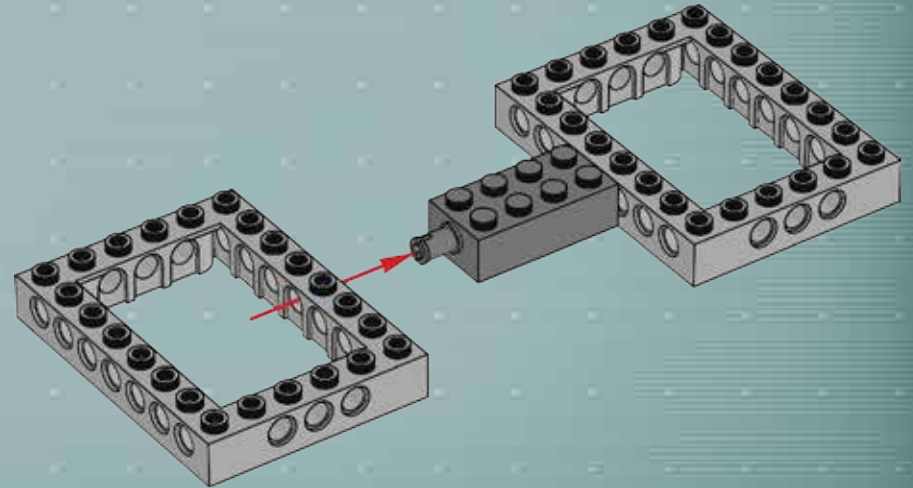

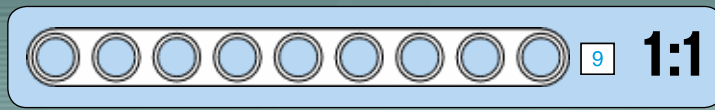
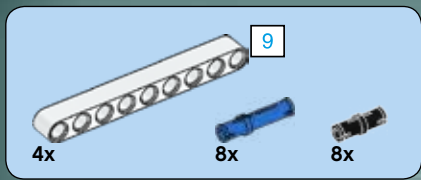

3

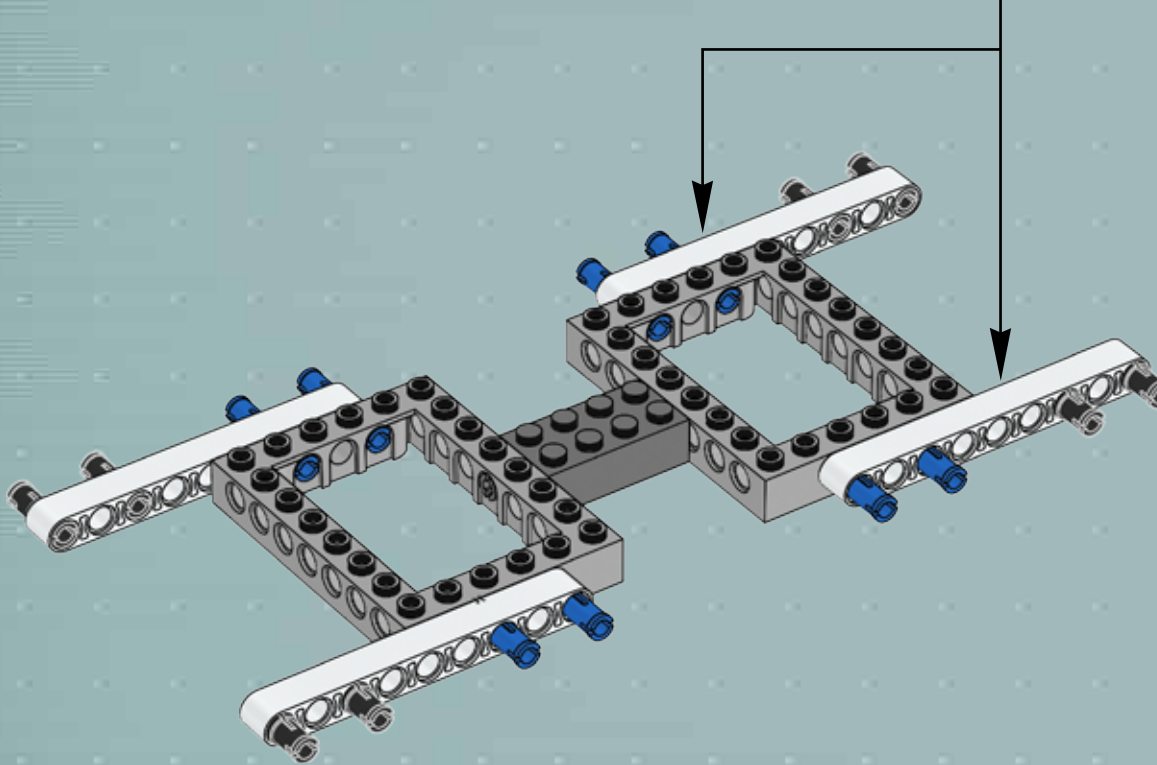
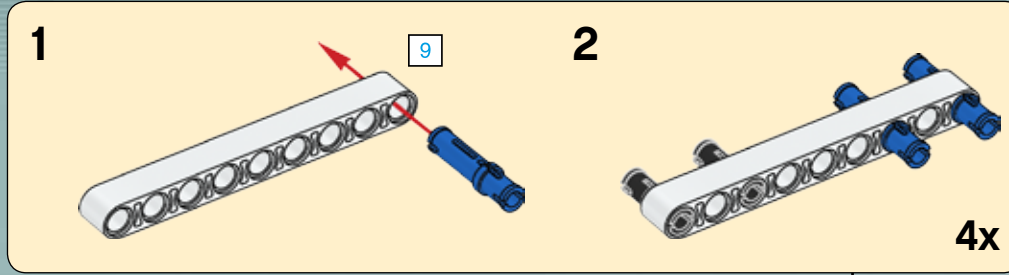

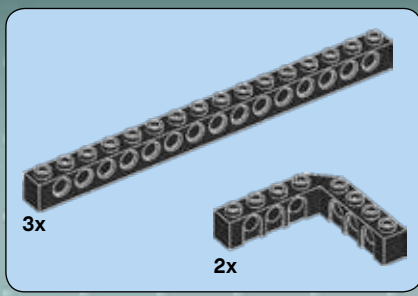

# 4

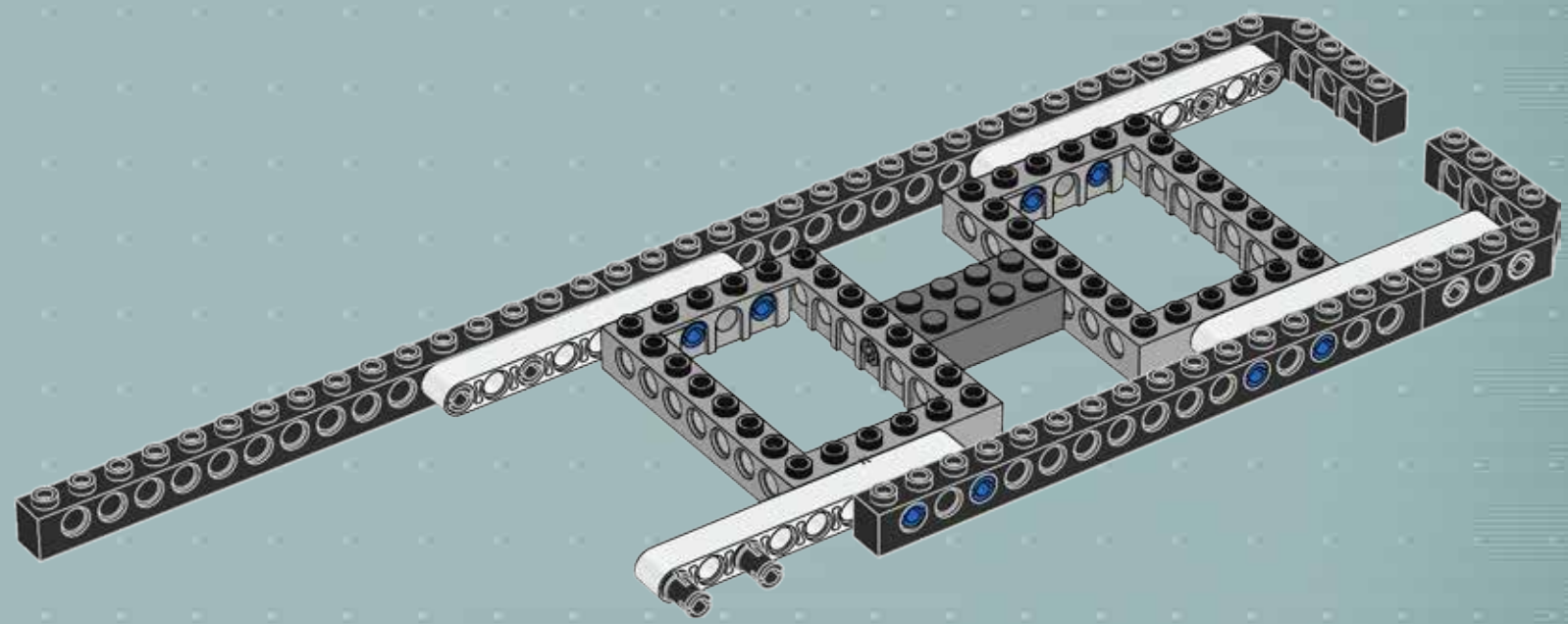

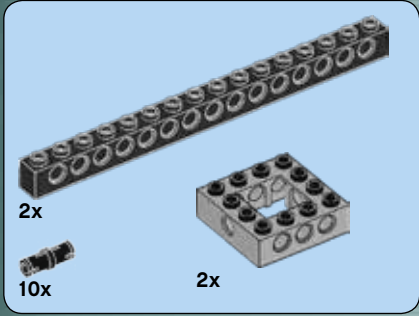
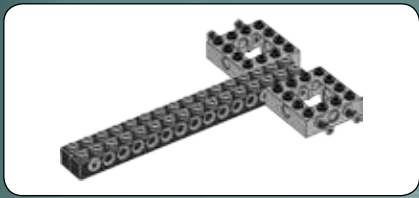

5

1

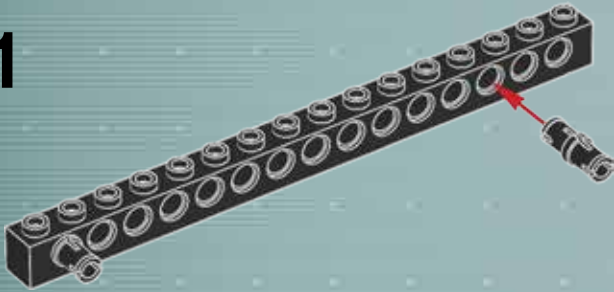

2

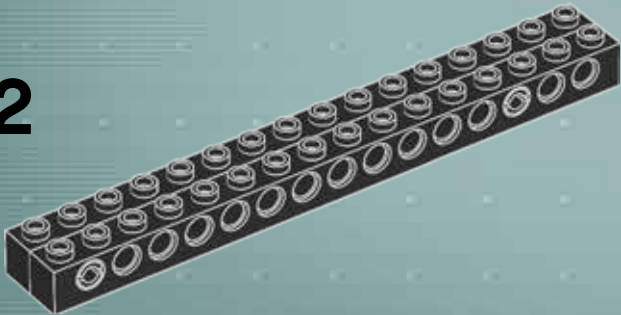

3

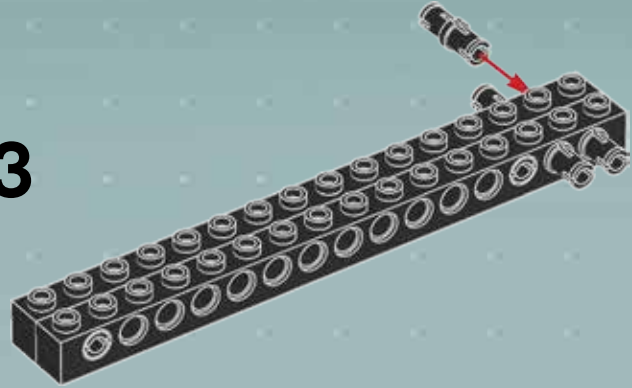

4

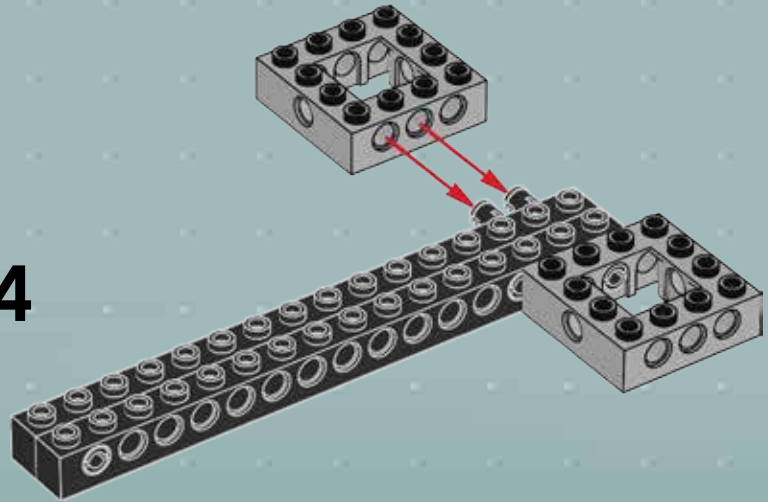

5

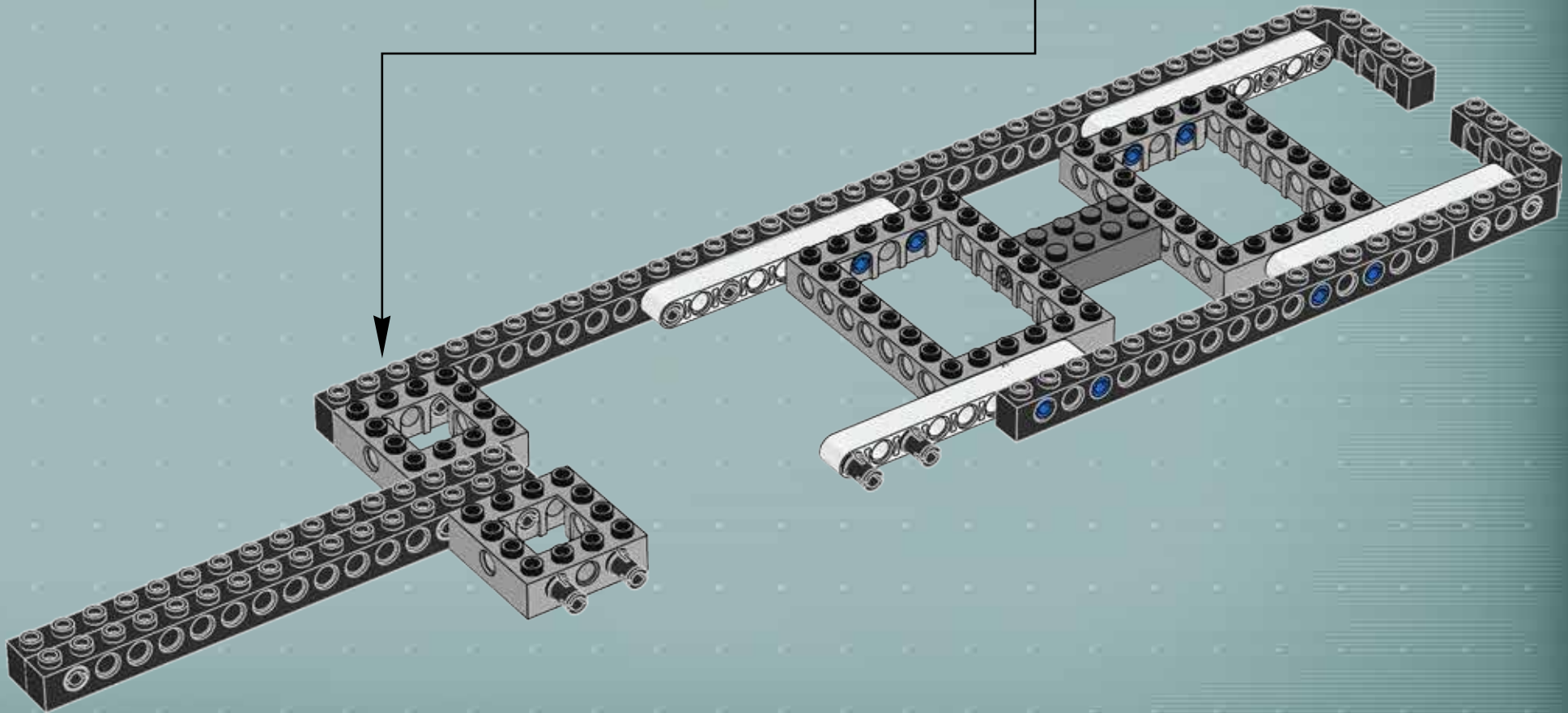
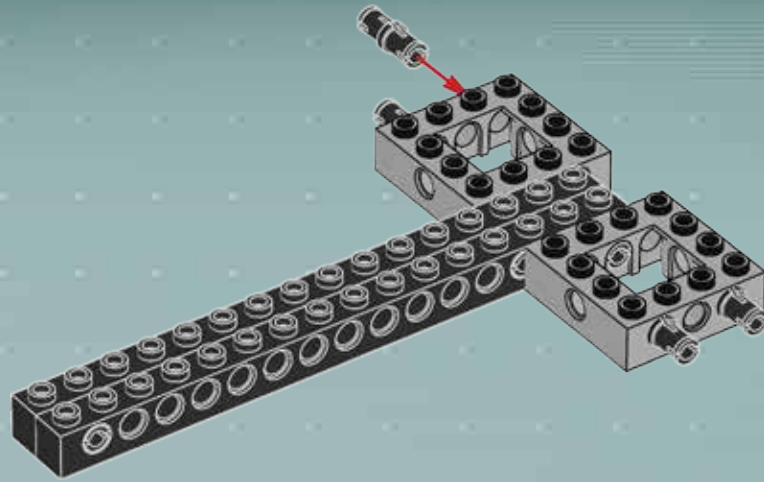

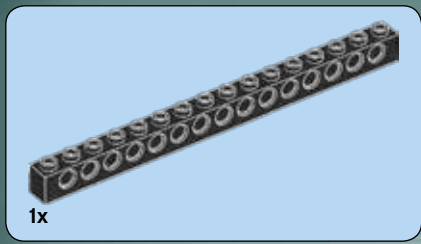

6

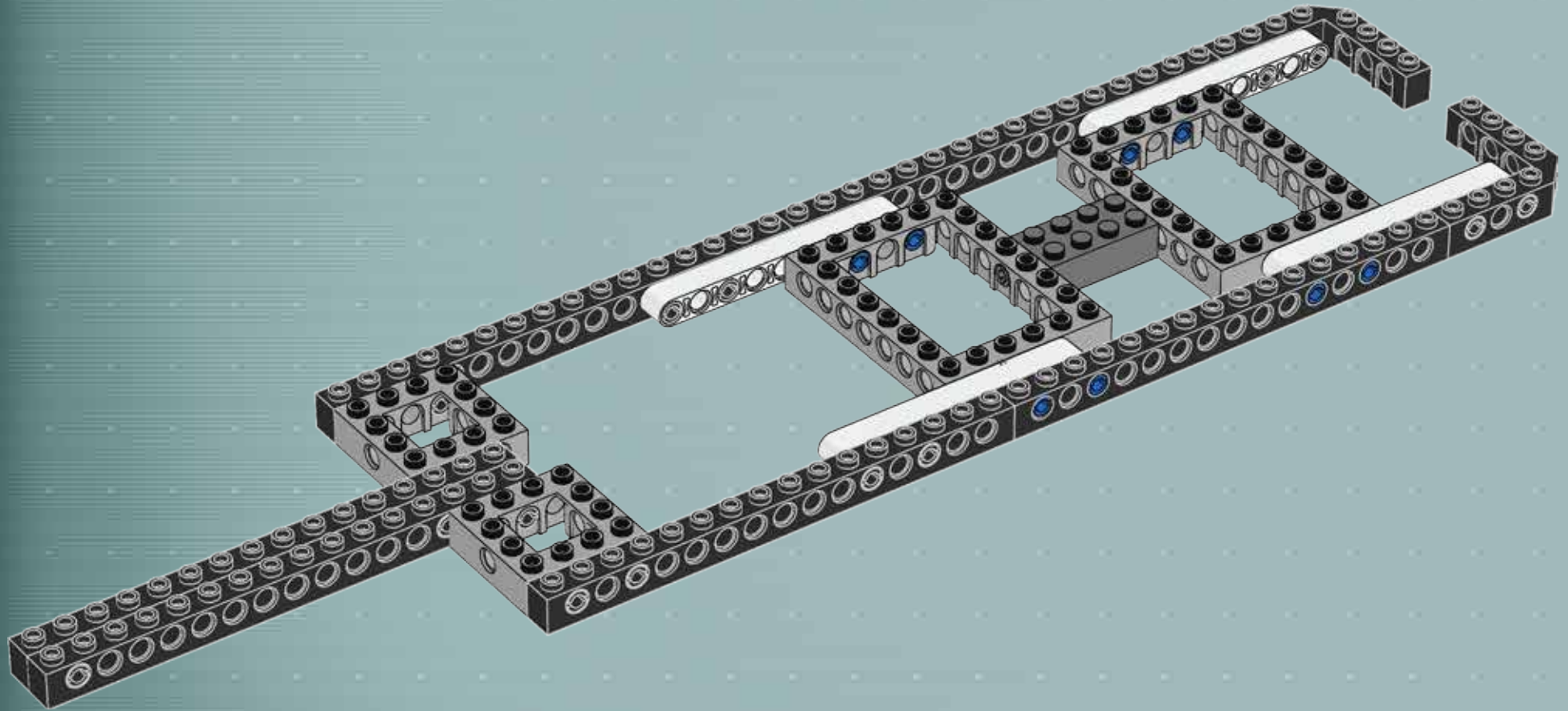





7

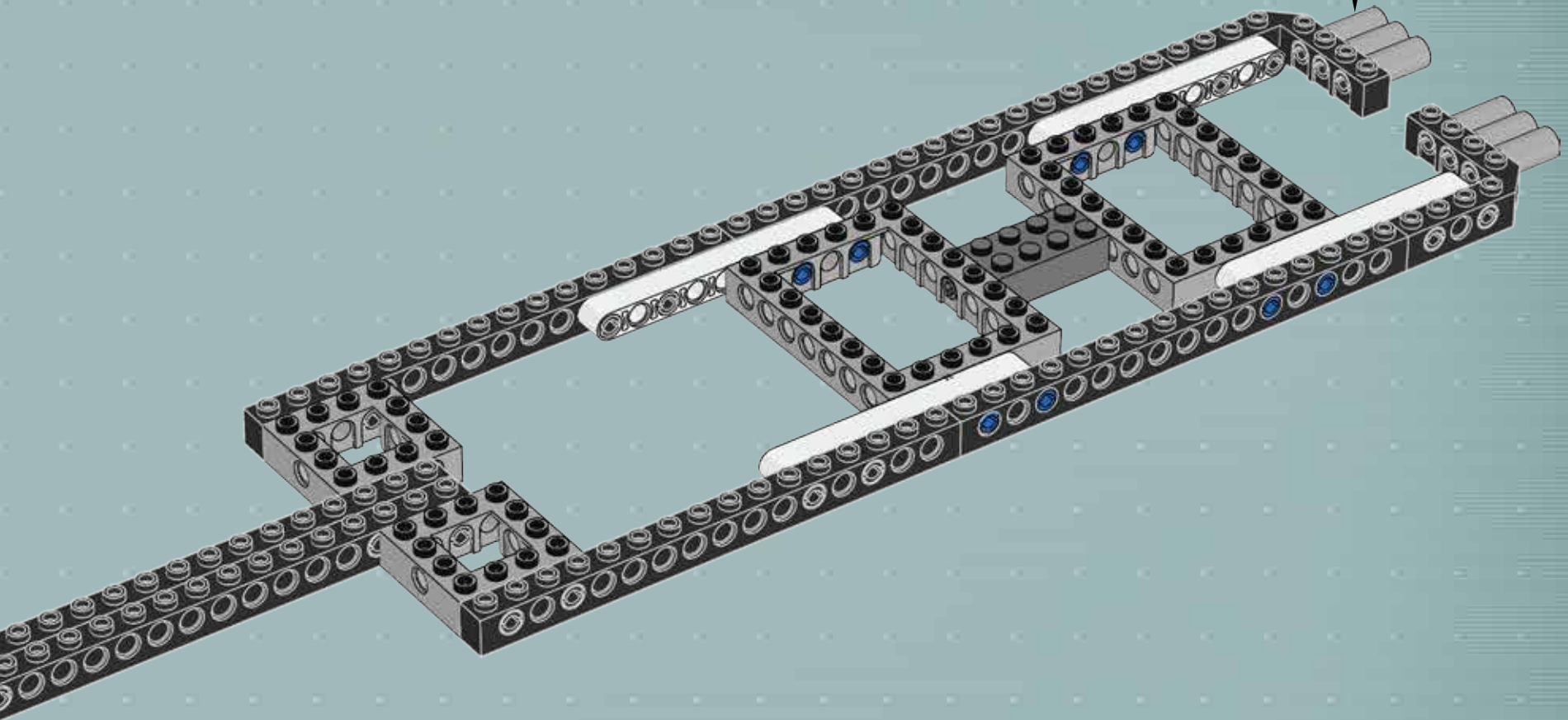
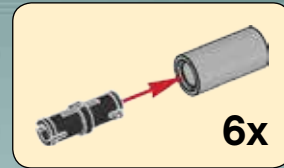

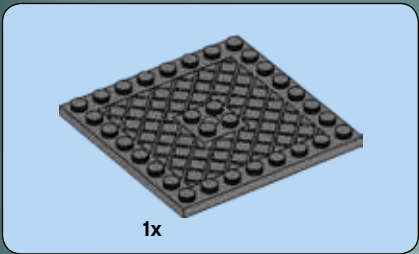

8

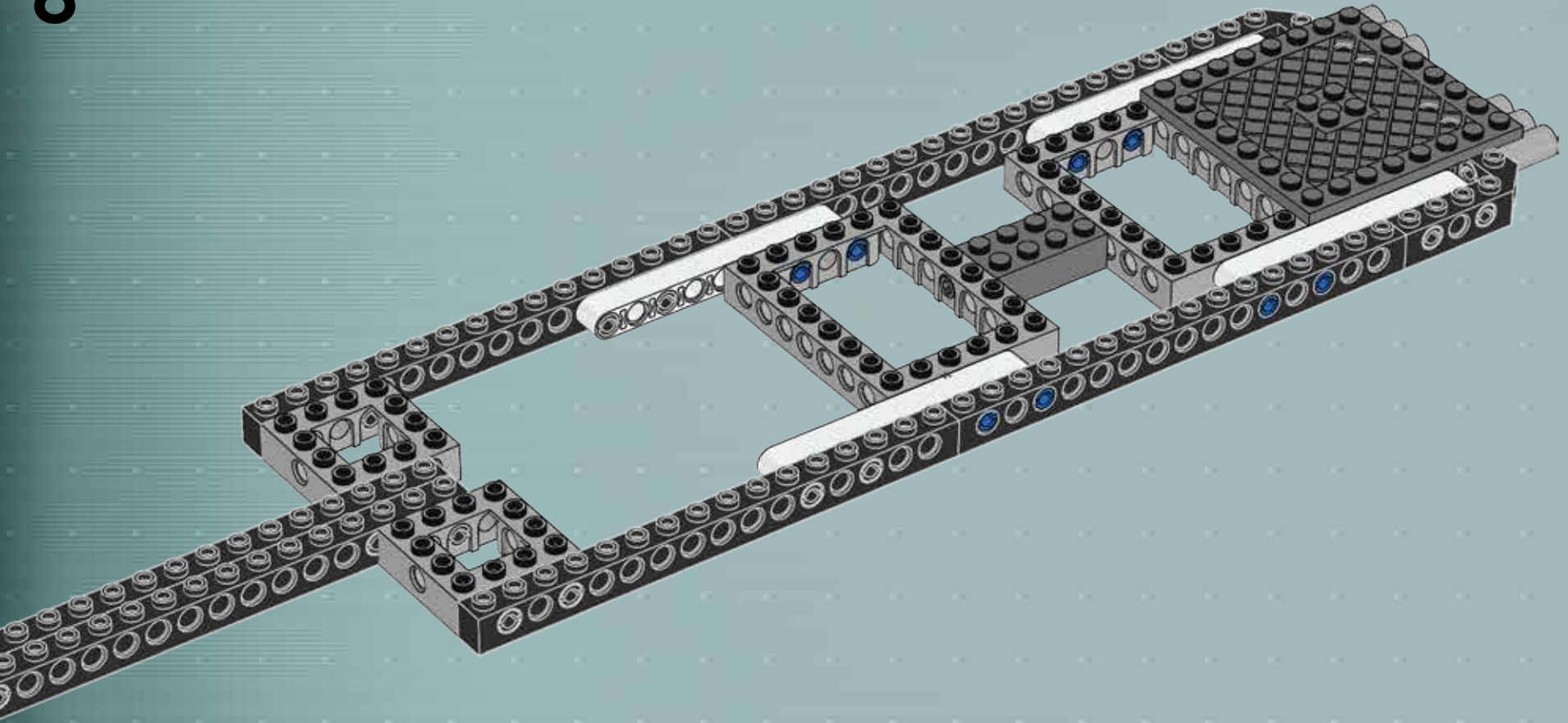

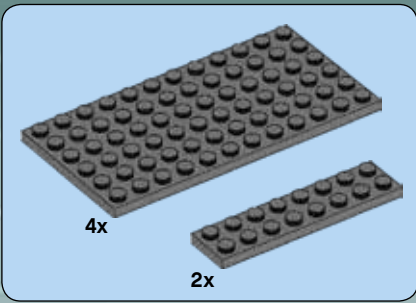

# 9

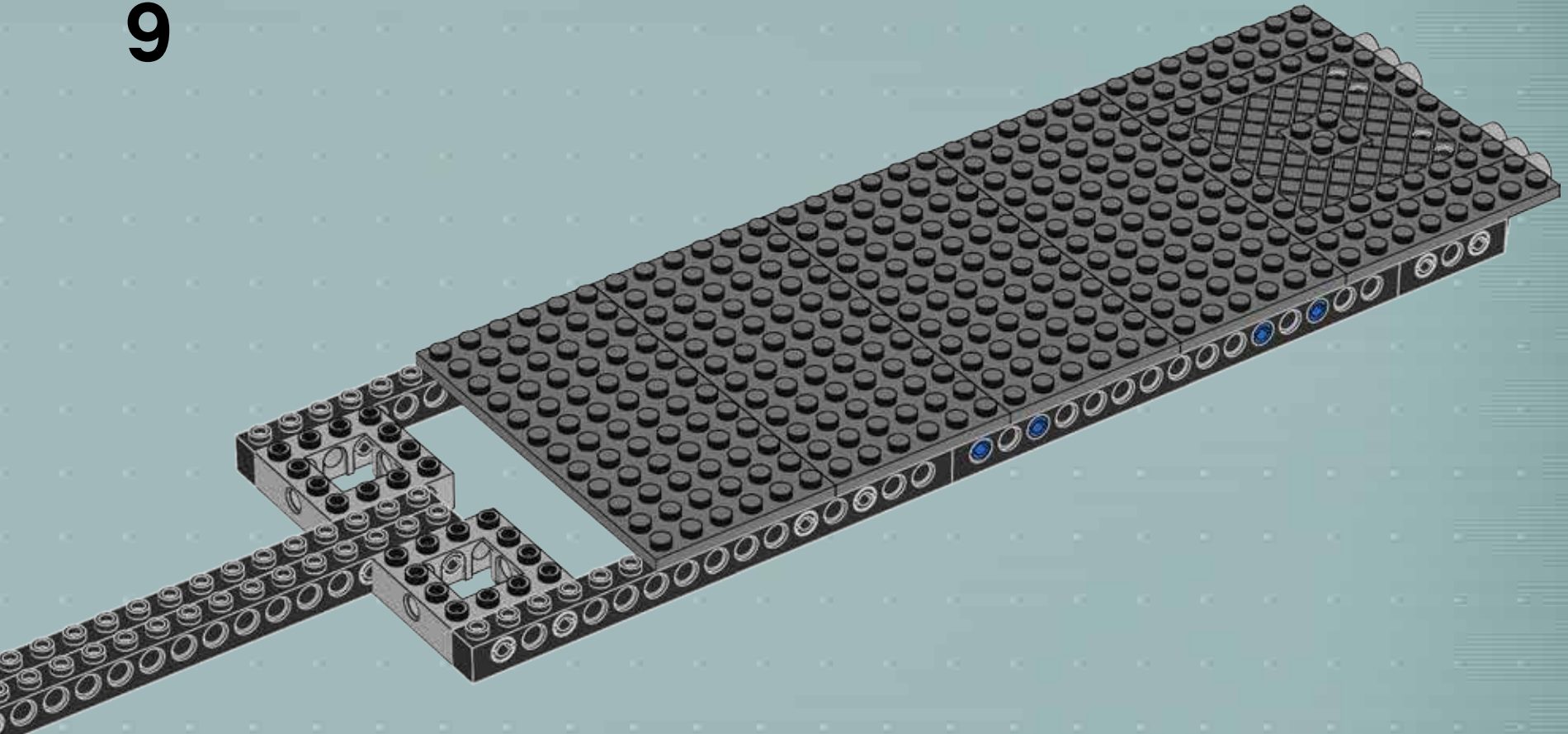

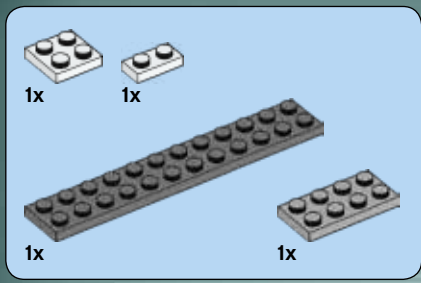

10

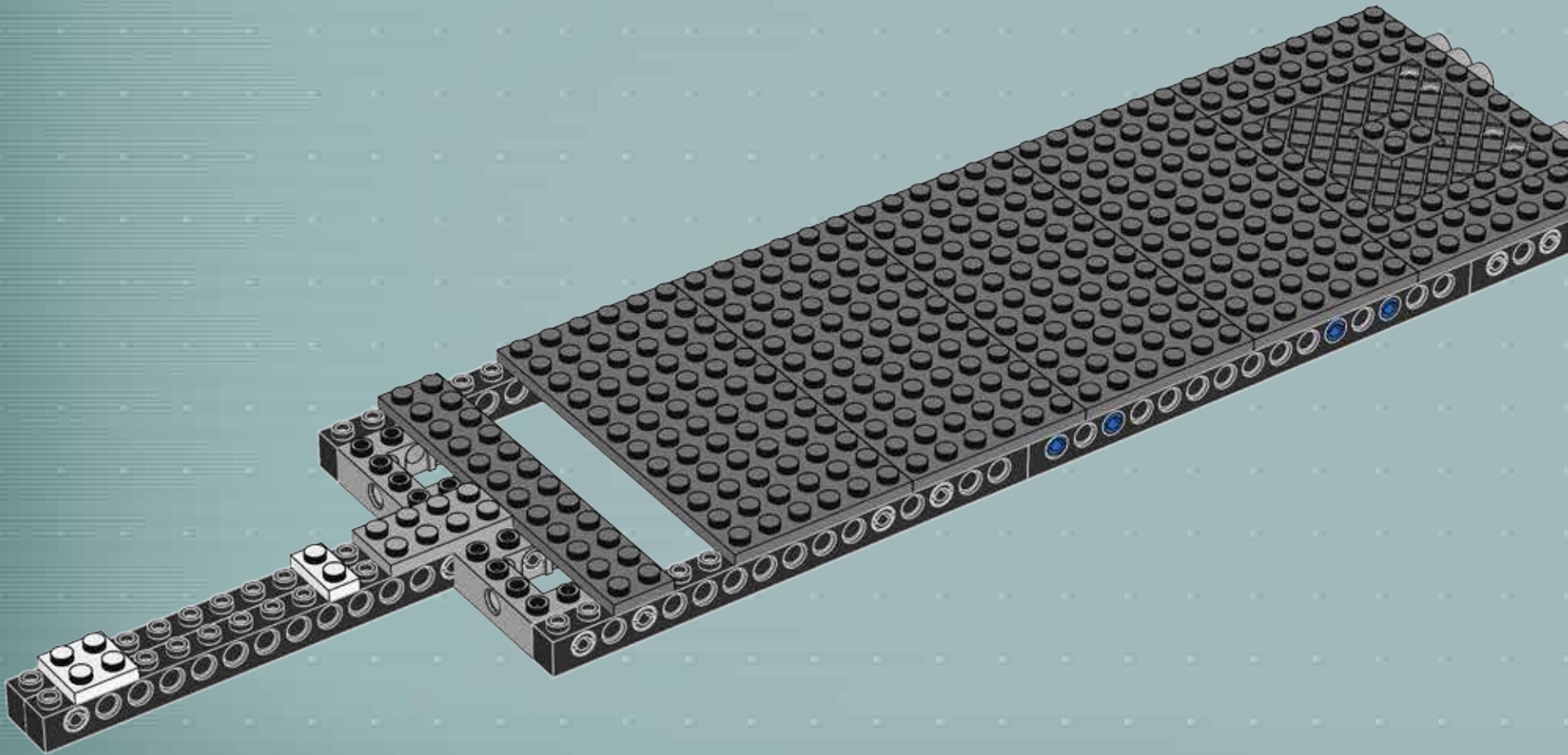

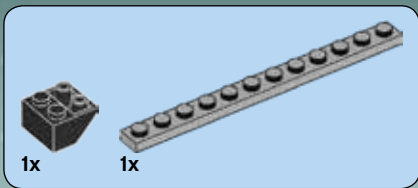

11

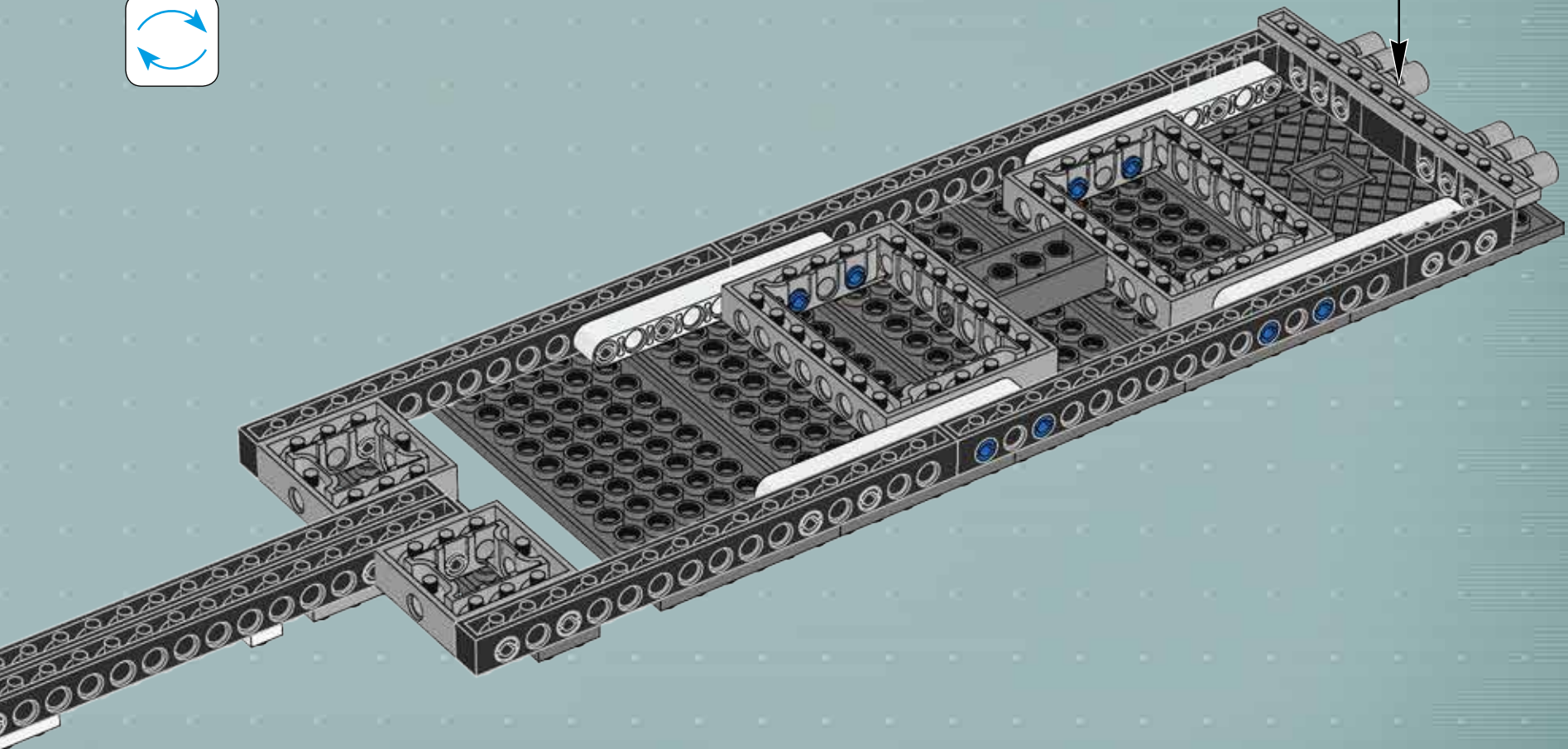
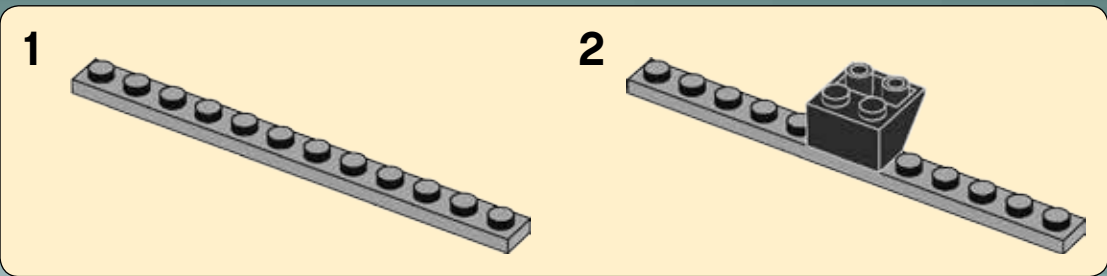

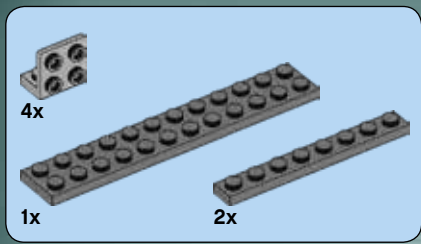

12

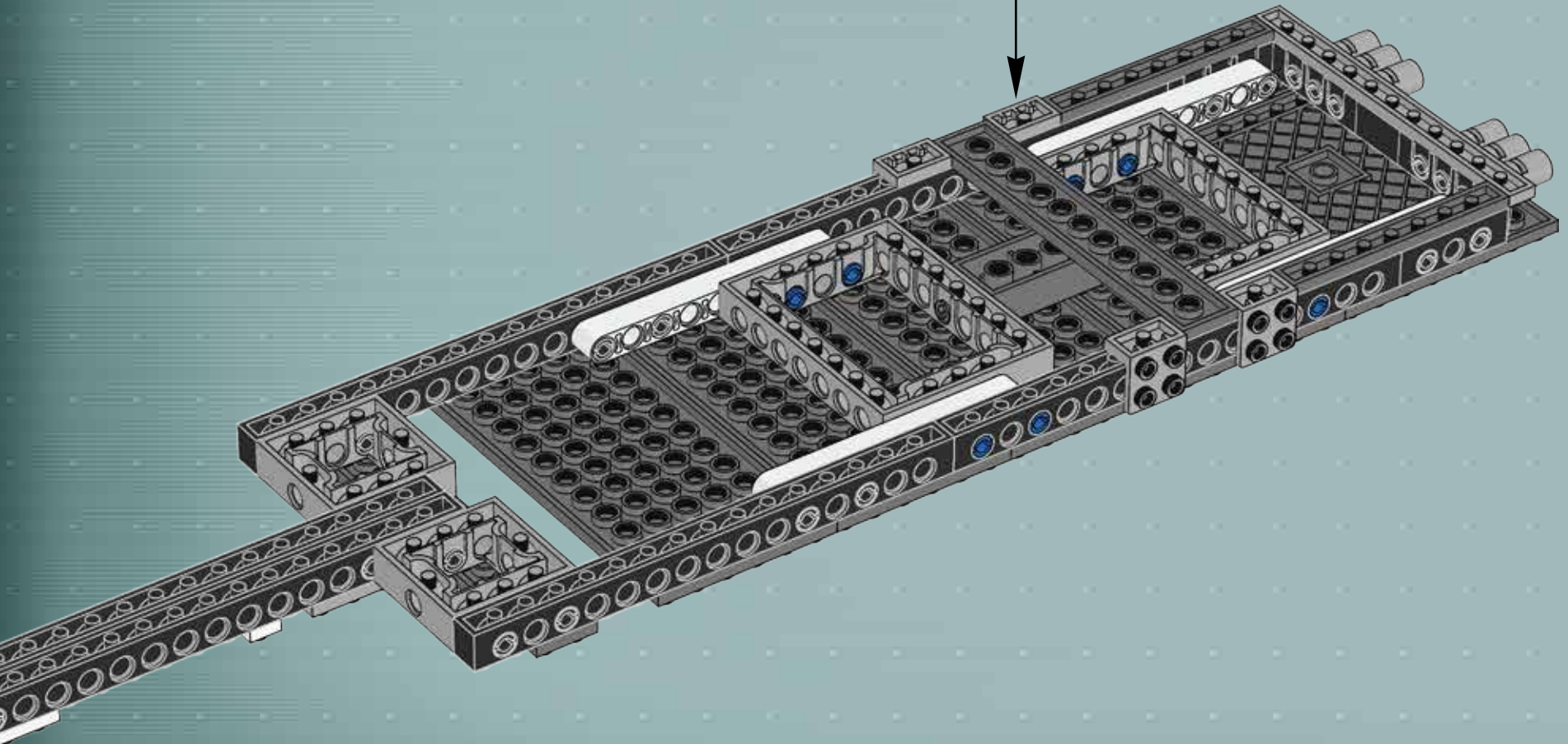
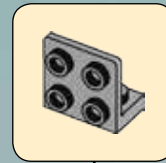

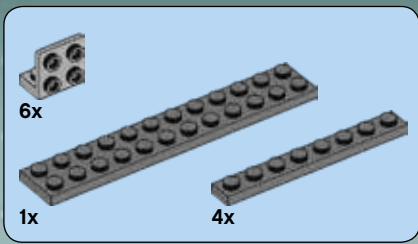

# 13

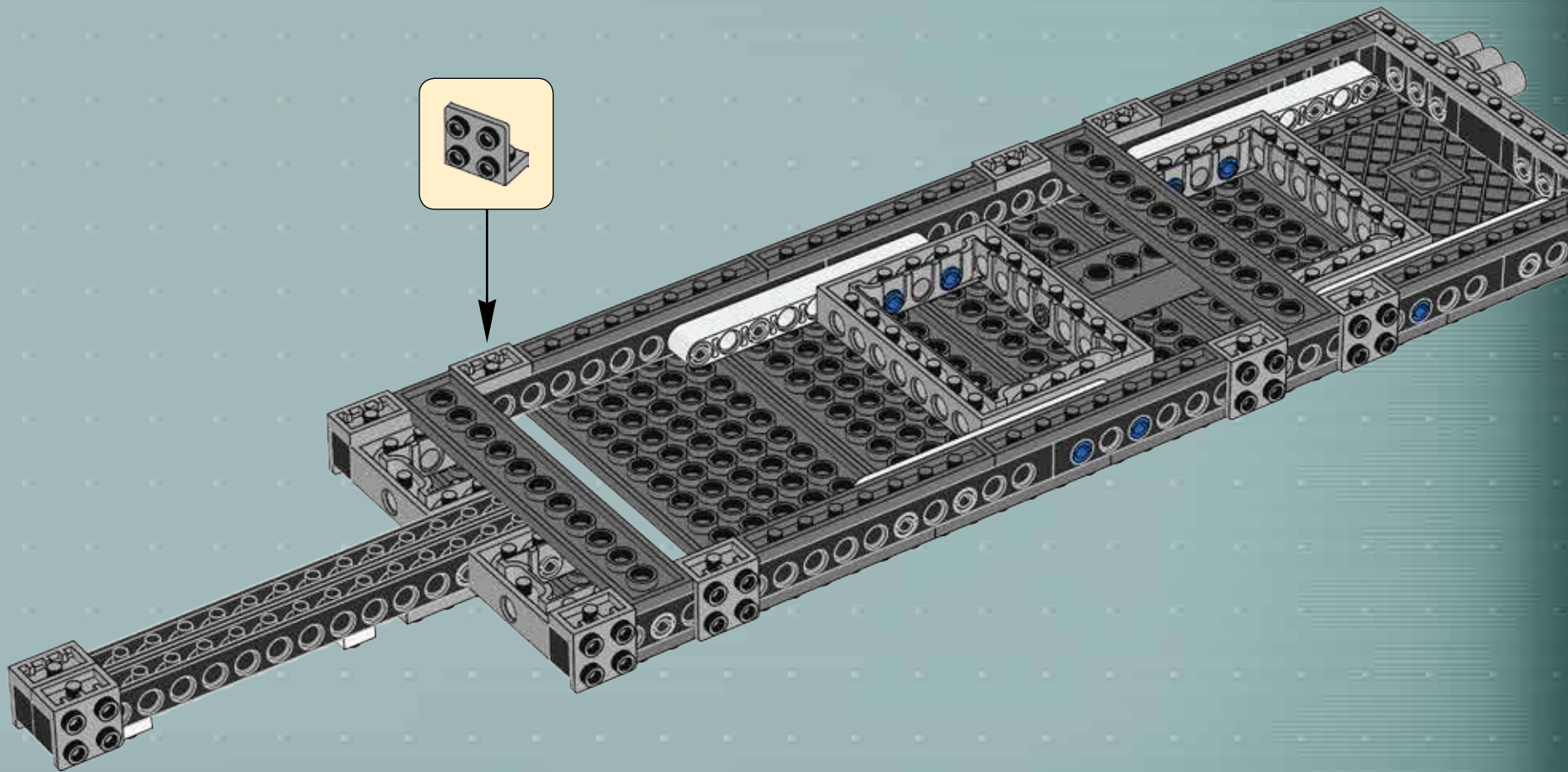



4x

14

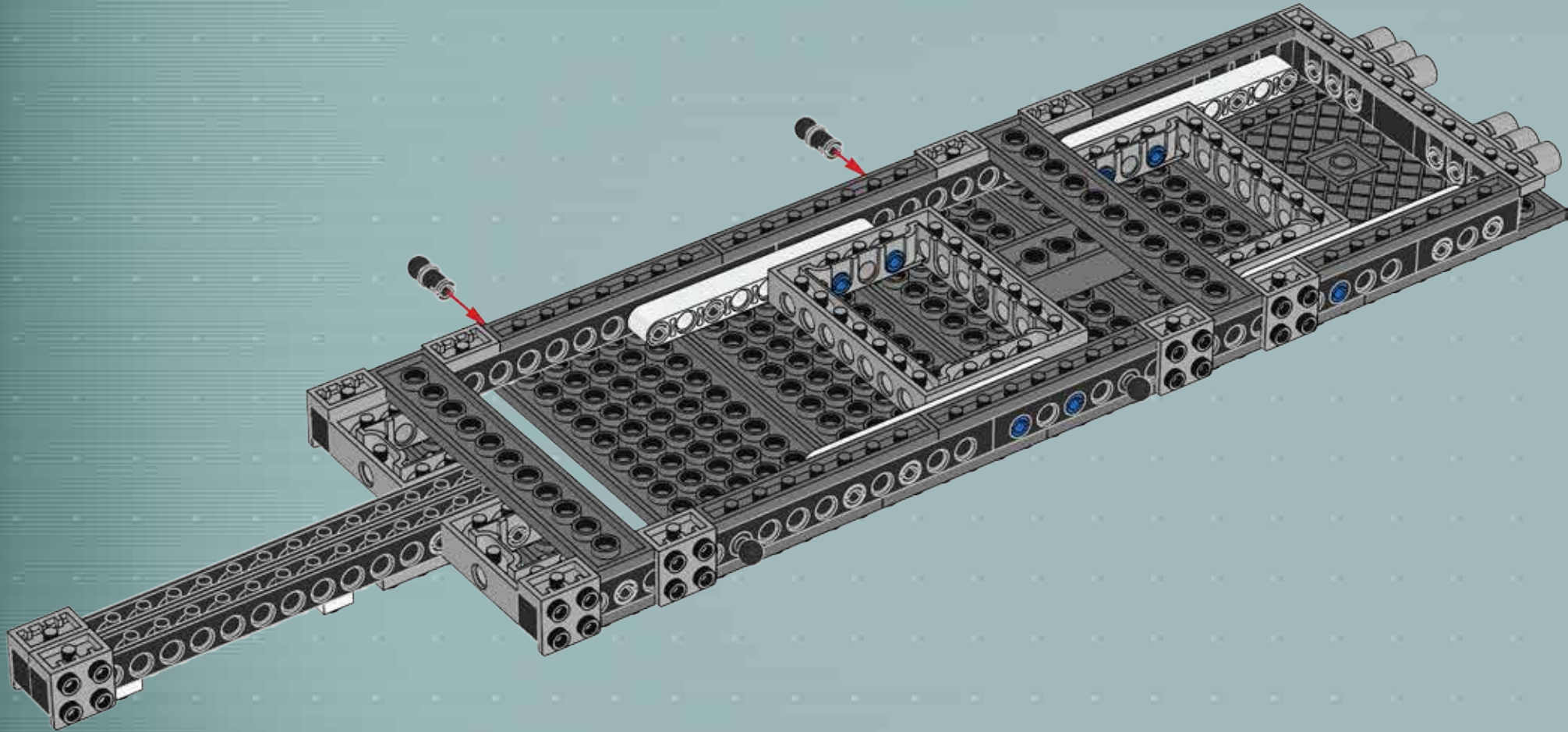





# 15

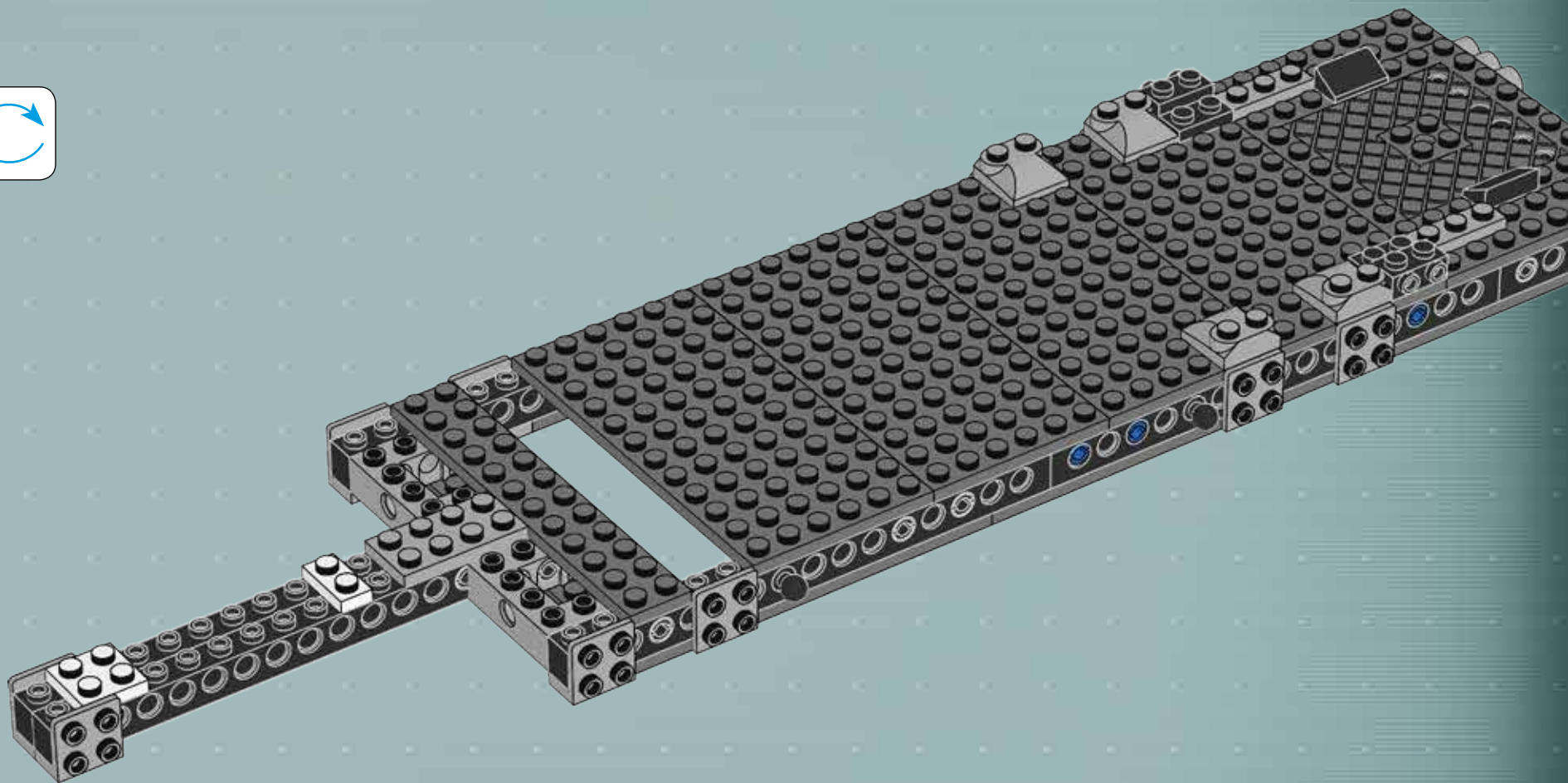

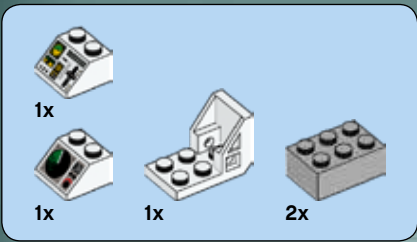

# 16

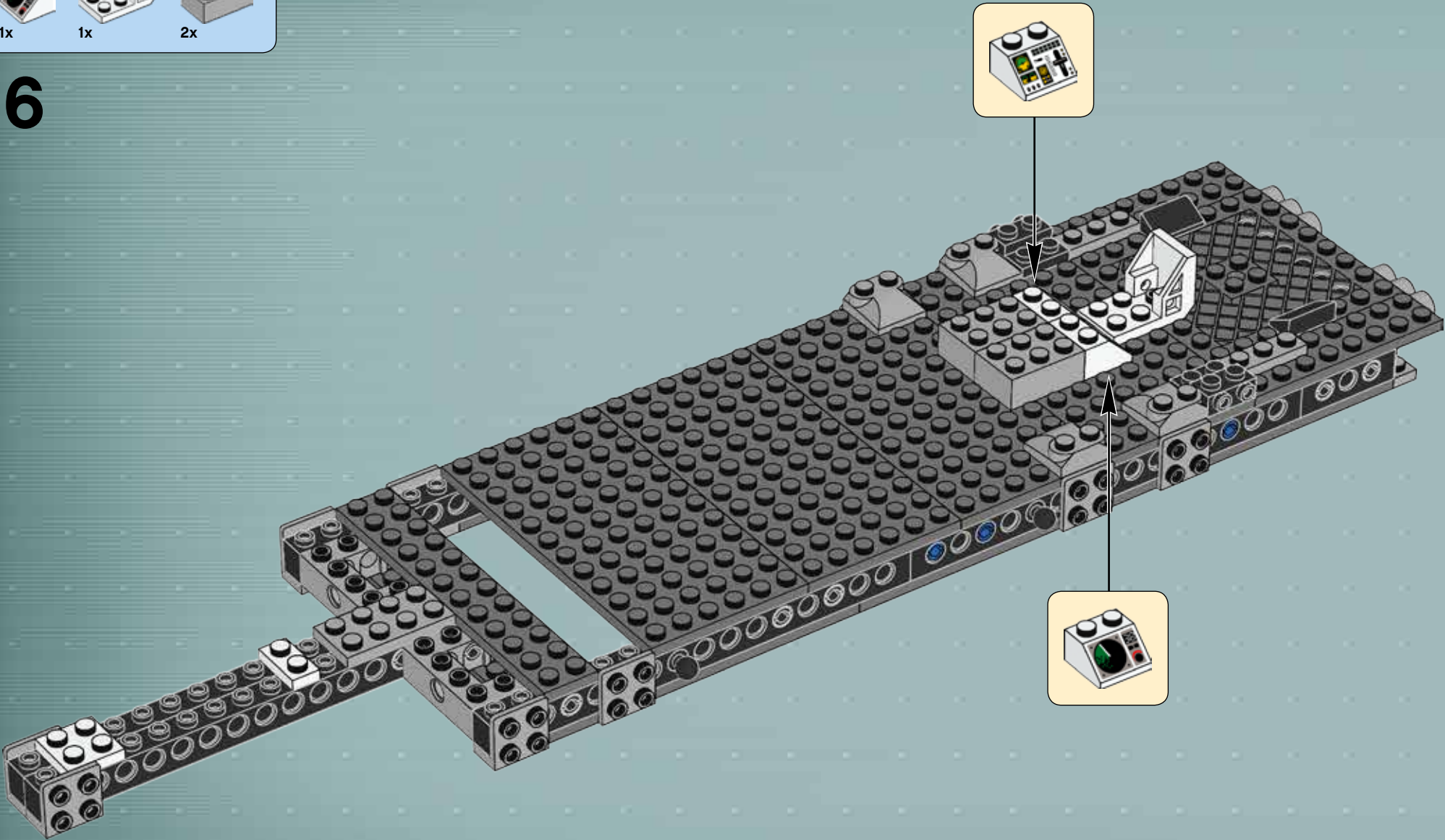

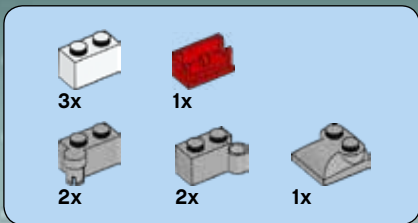

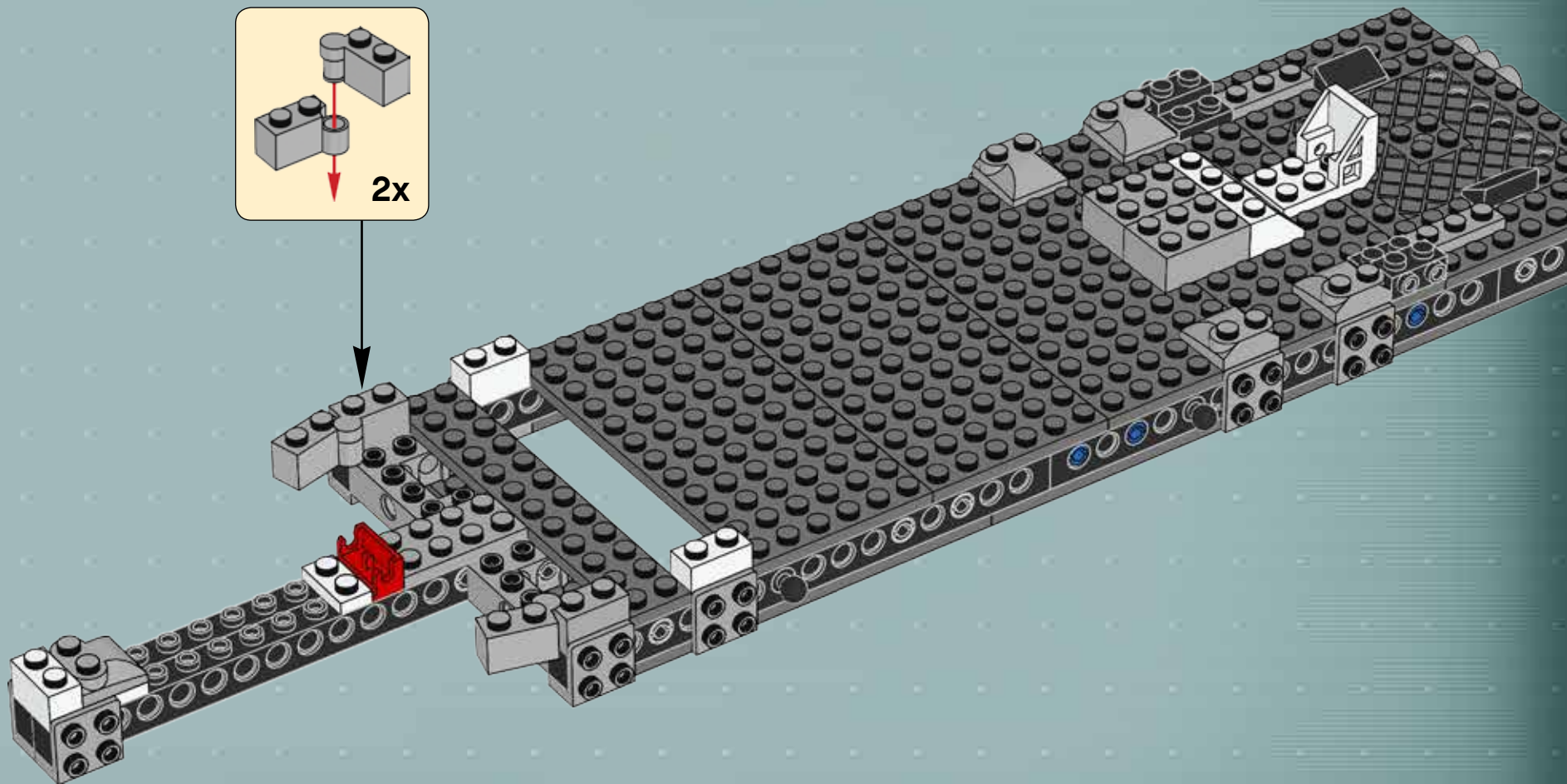
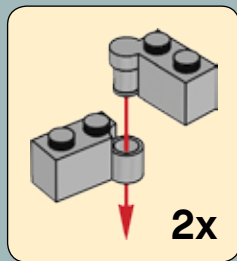

17

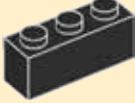

2x  2x  6x 

18



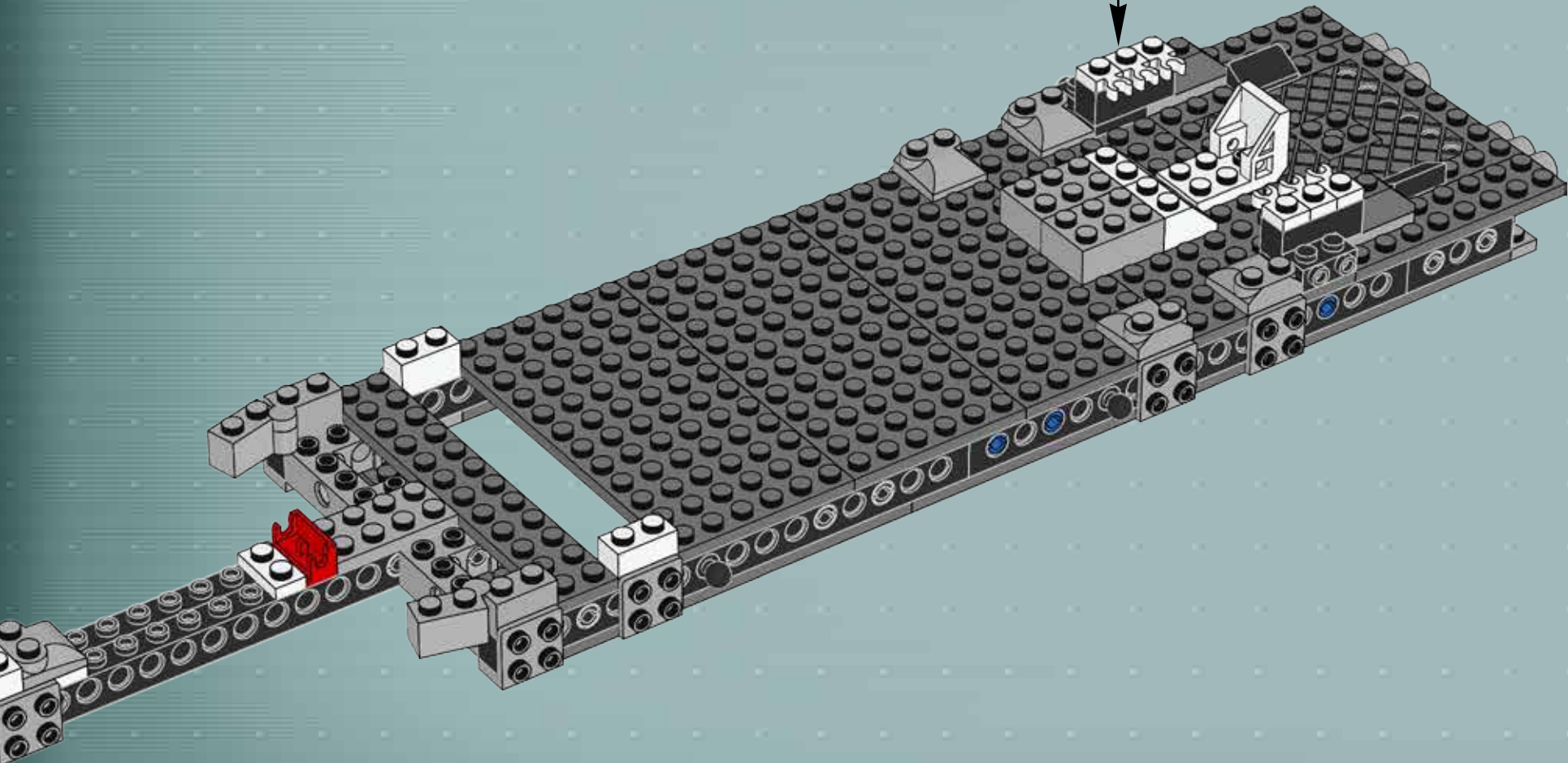

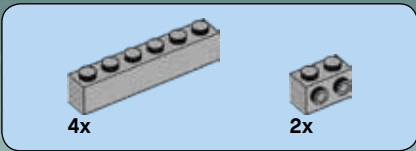
1  2  2x



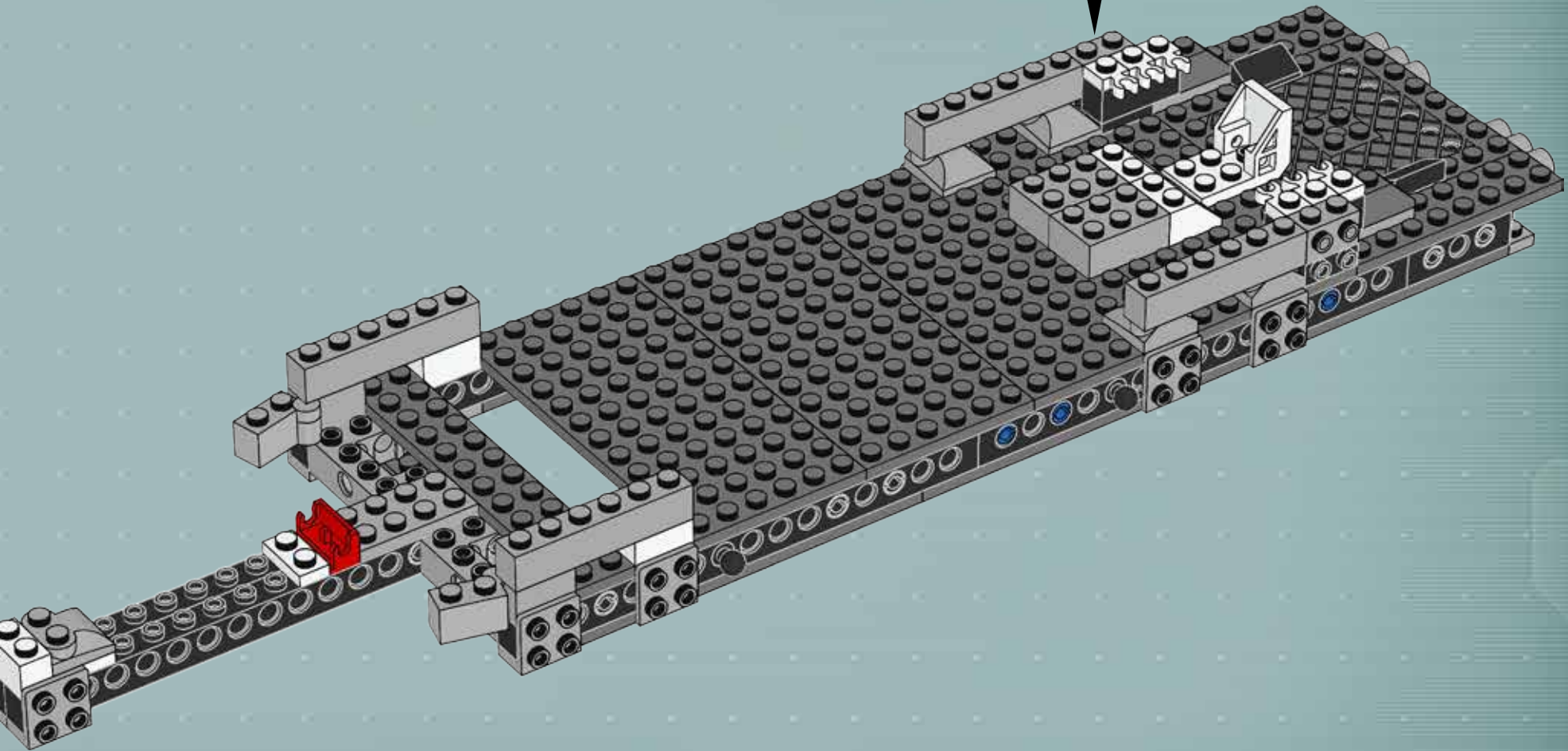
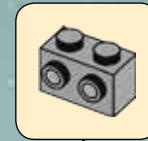

# 19



 1x	 4x	
 2x	 1x	 2x

20

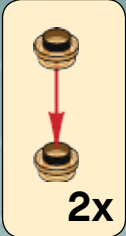

2x

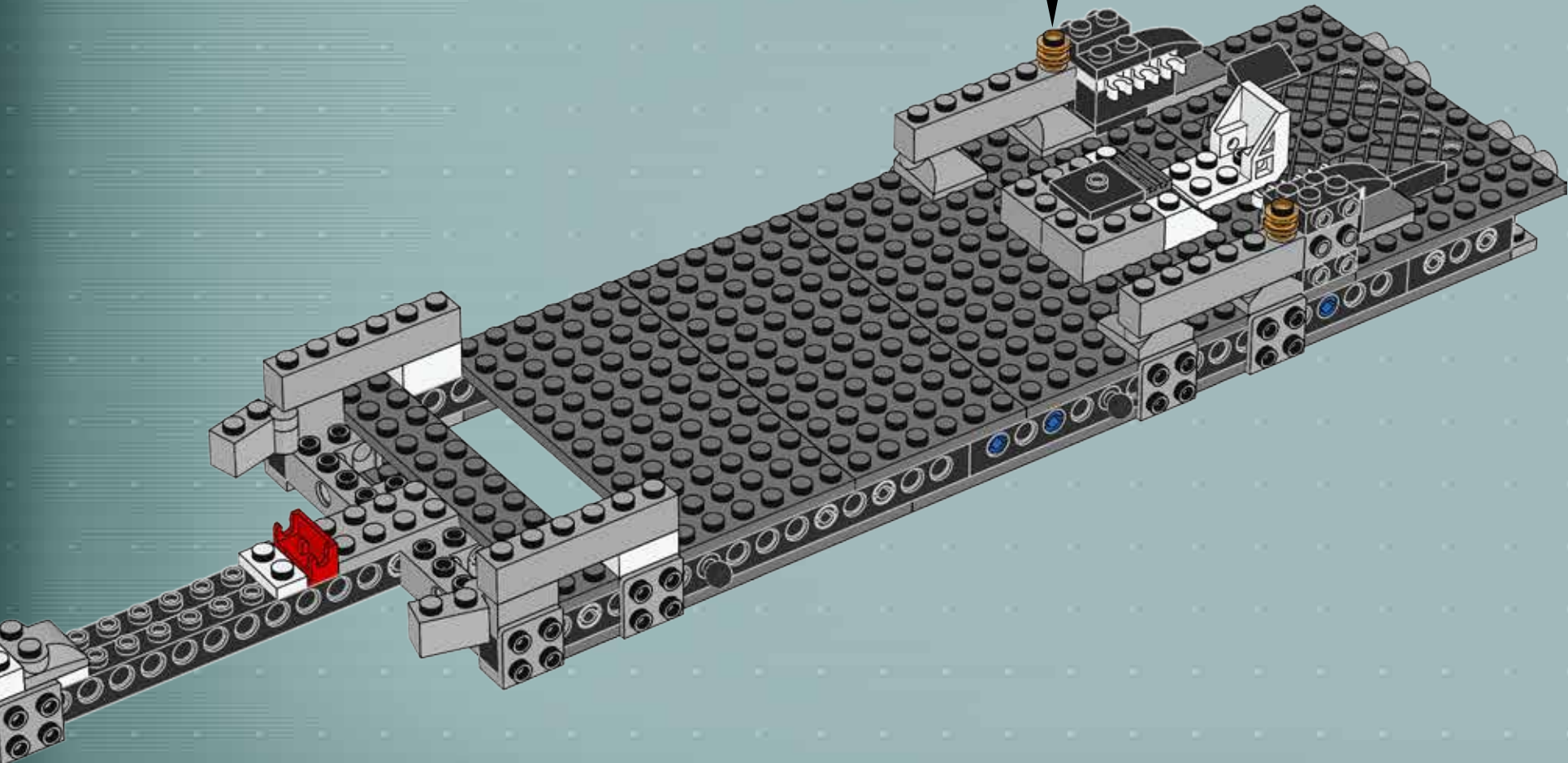

- 1x [Part]
- 2x [Part]
- 2x [Part]
- 1x [Part]
- 1x [Part]
- 1x [Part]
- 2x [Part]
- 2x [Part]
- 1x [Part]

# 21

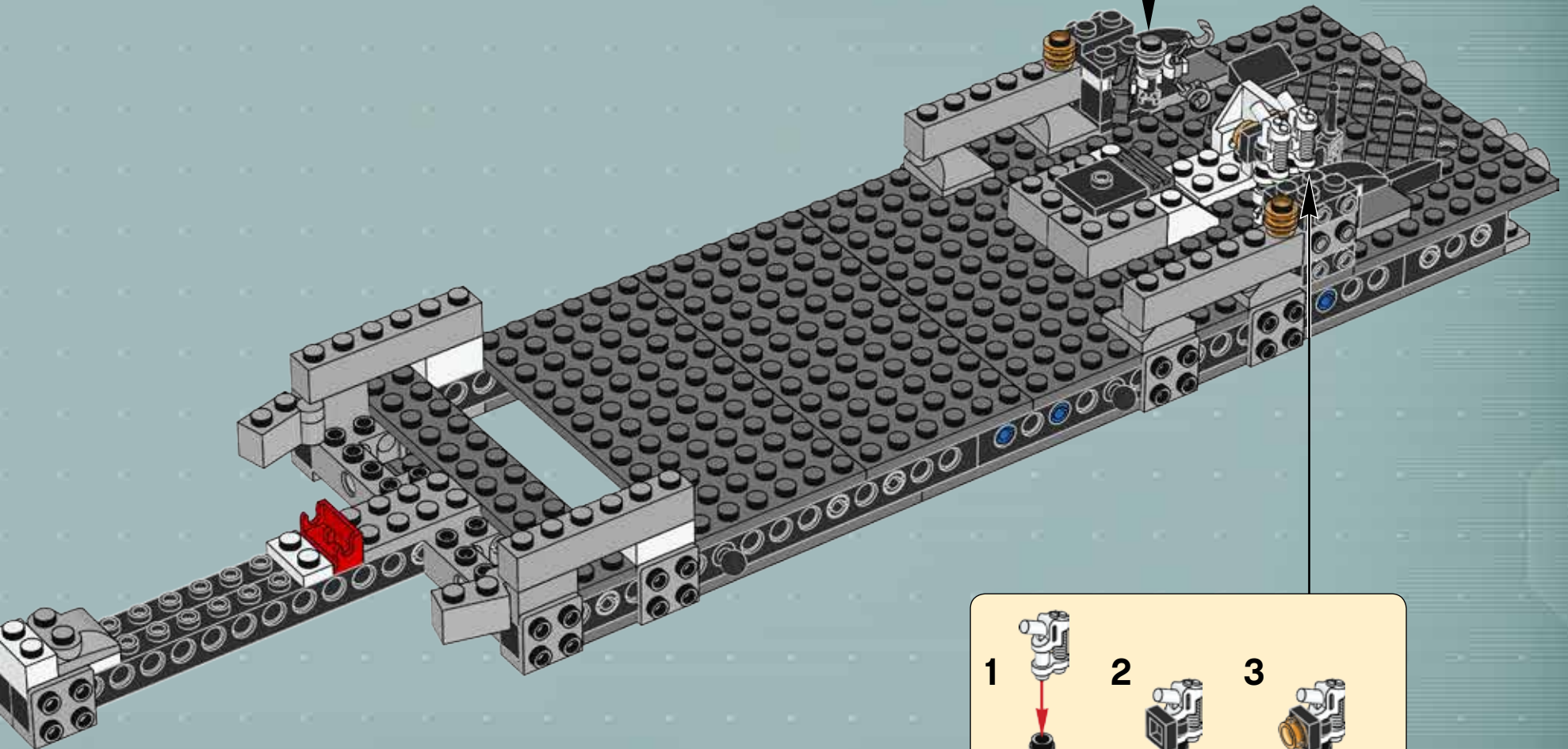
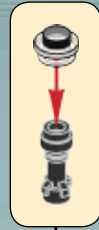

- 1 [Part]
  - 2 [Part]
  - 3 [Part]
- 2x



4x



2x

# 22

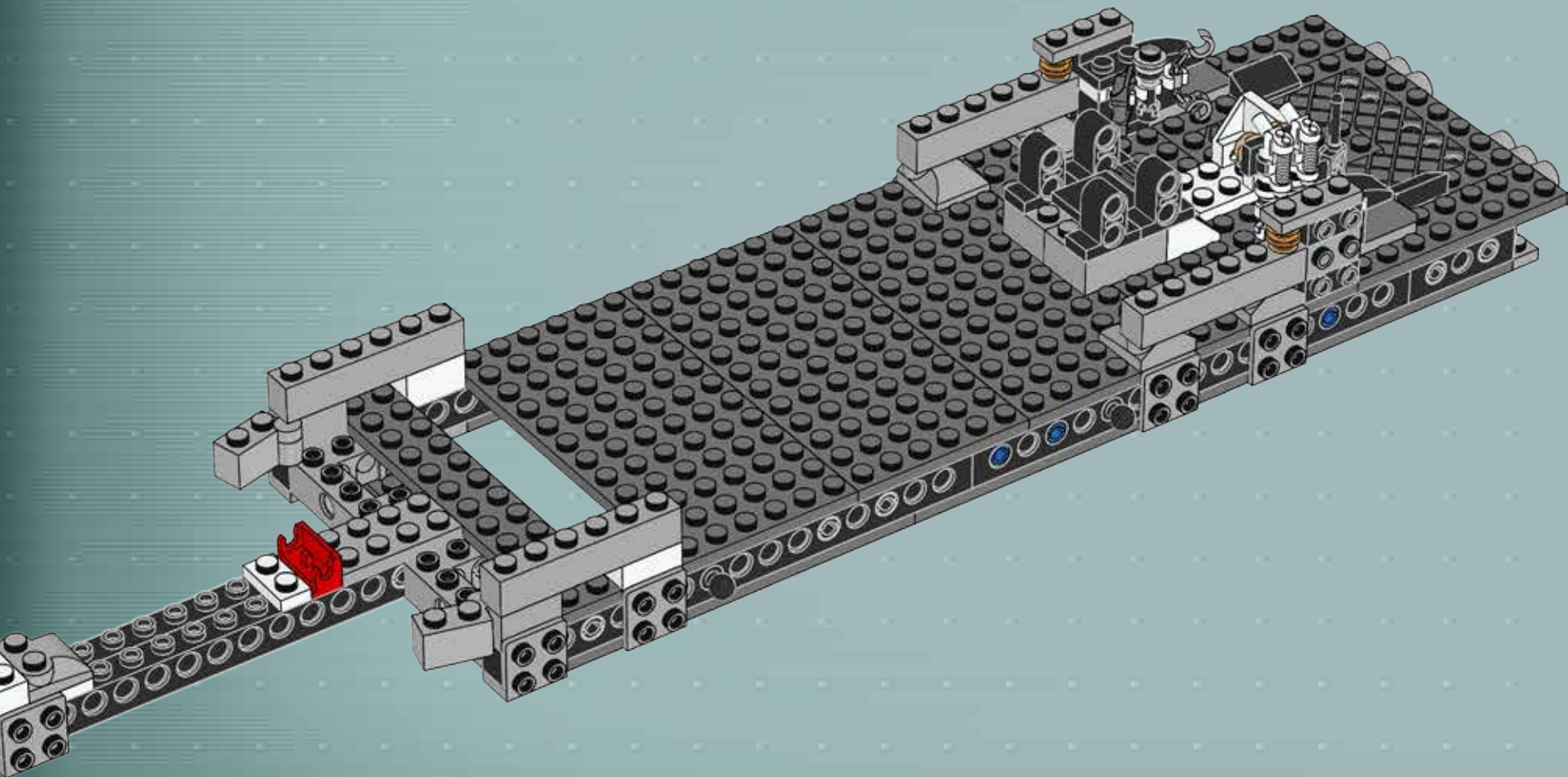



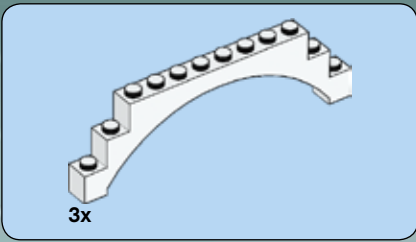

# 23

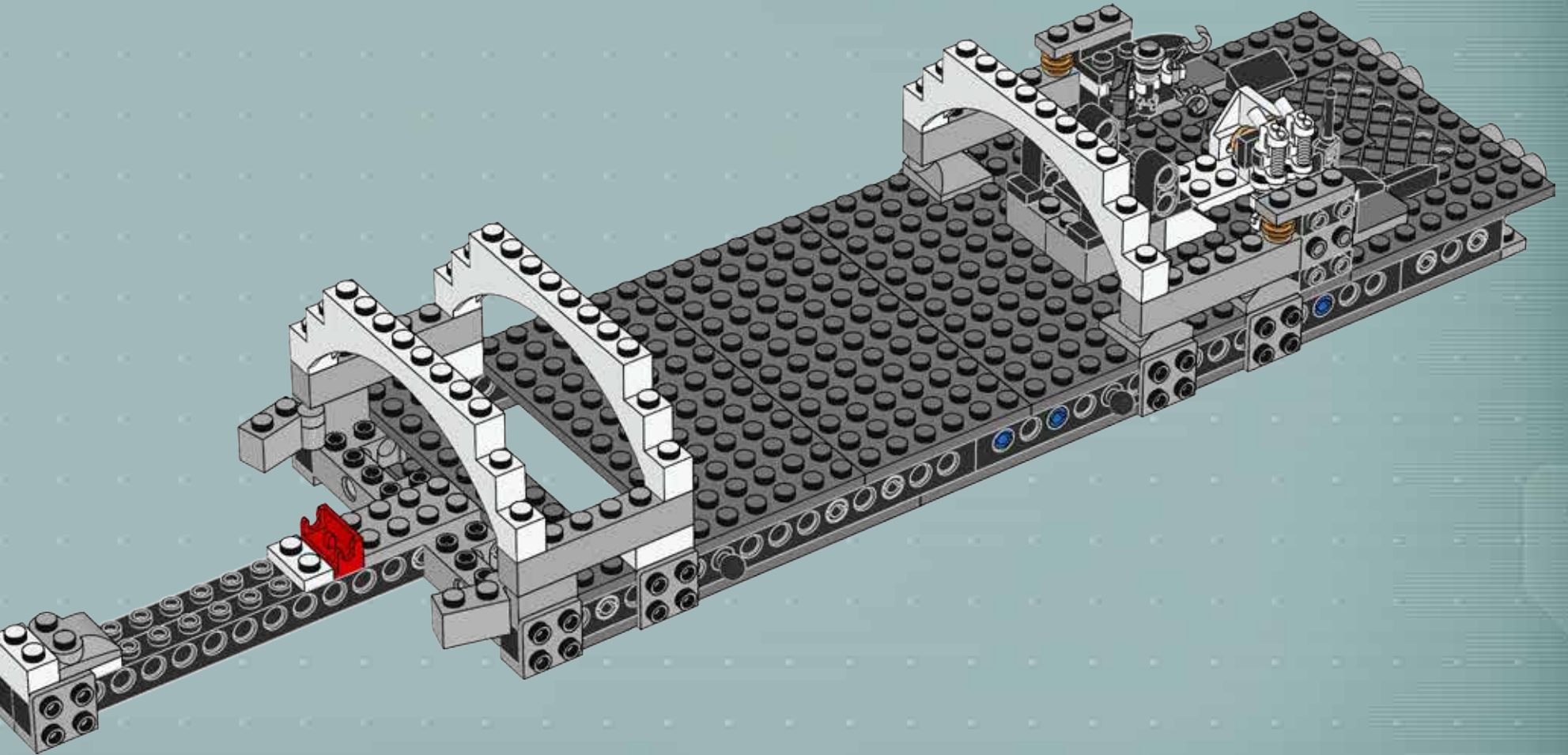

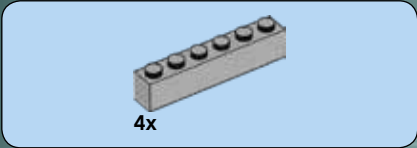

24

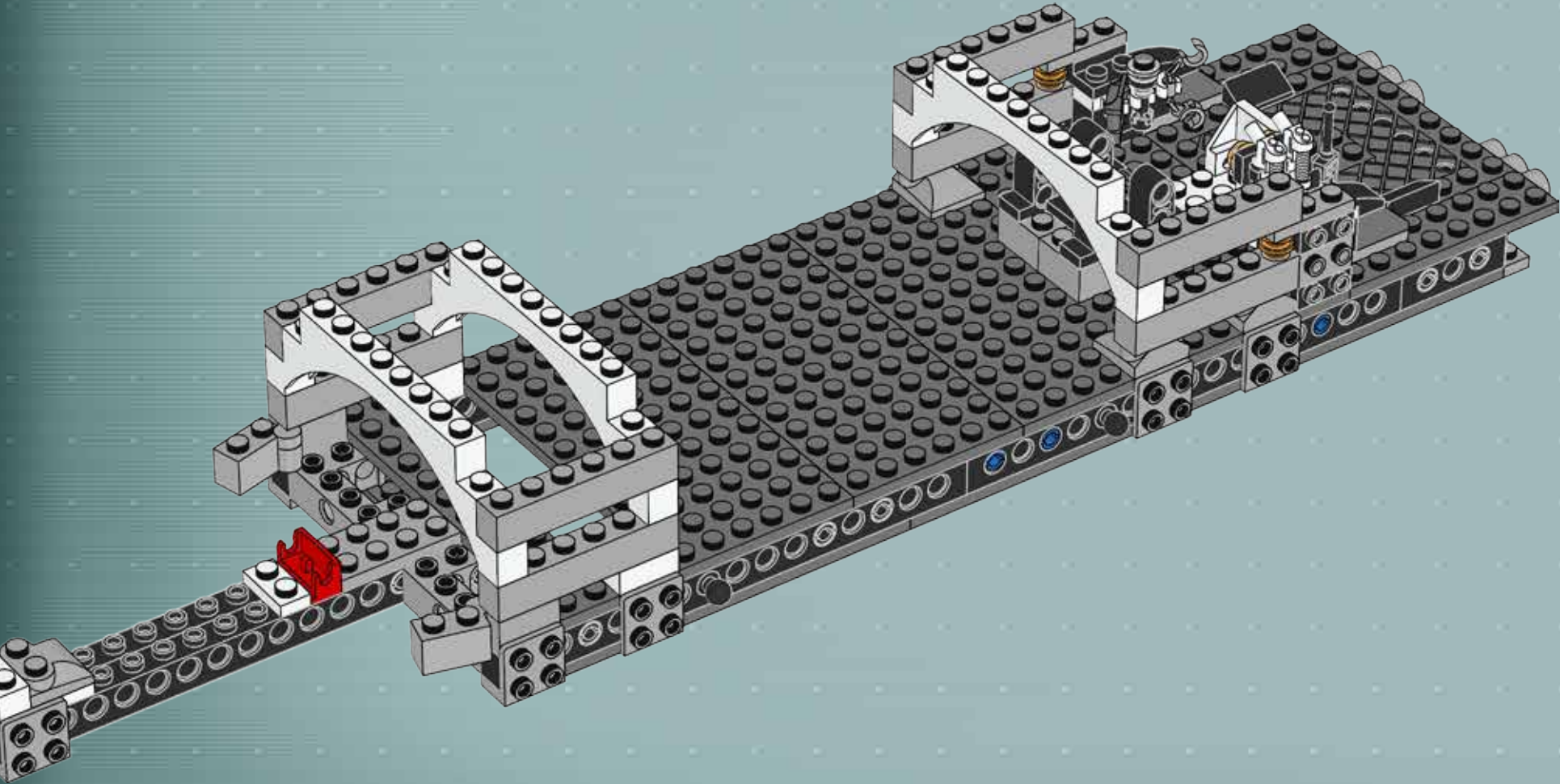

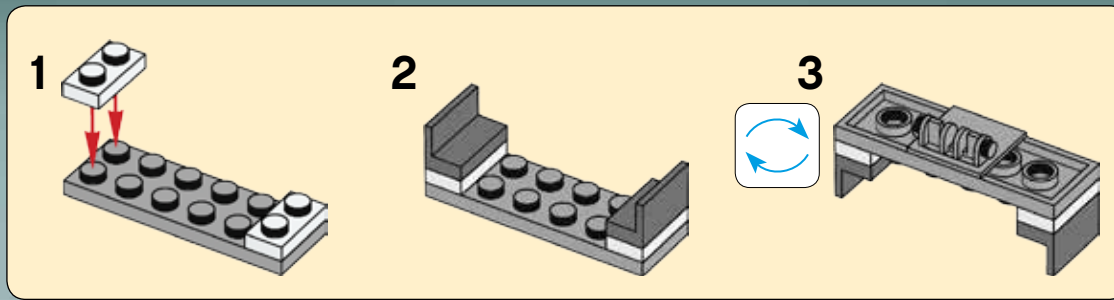
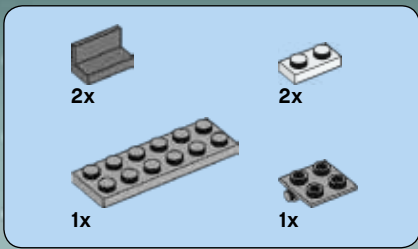

25

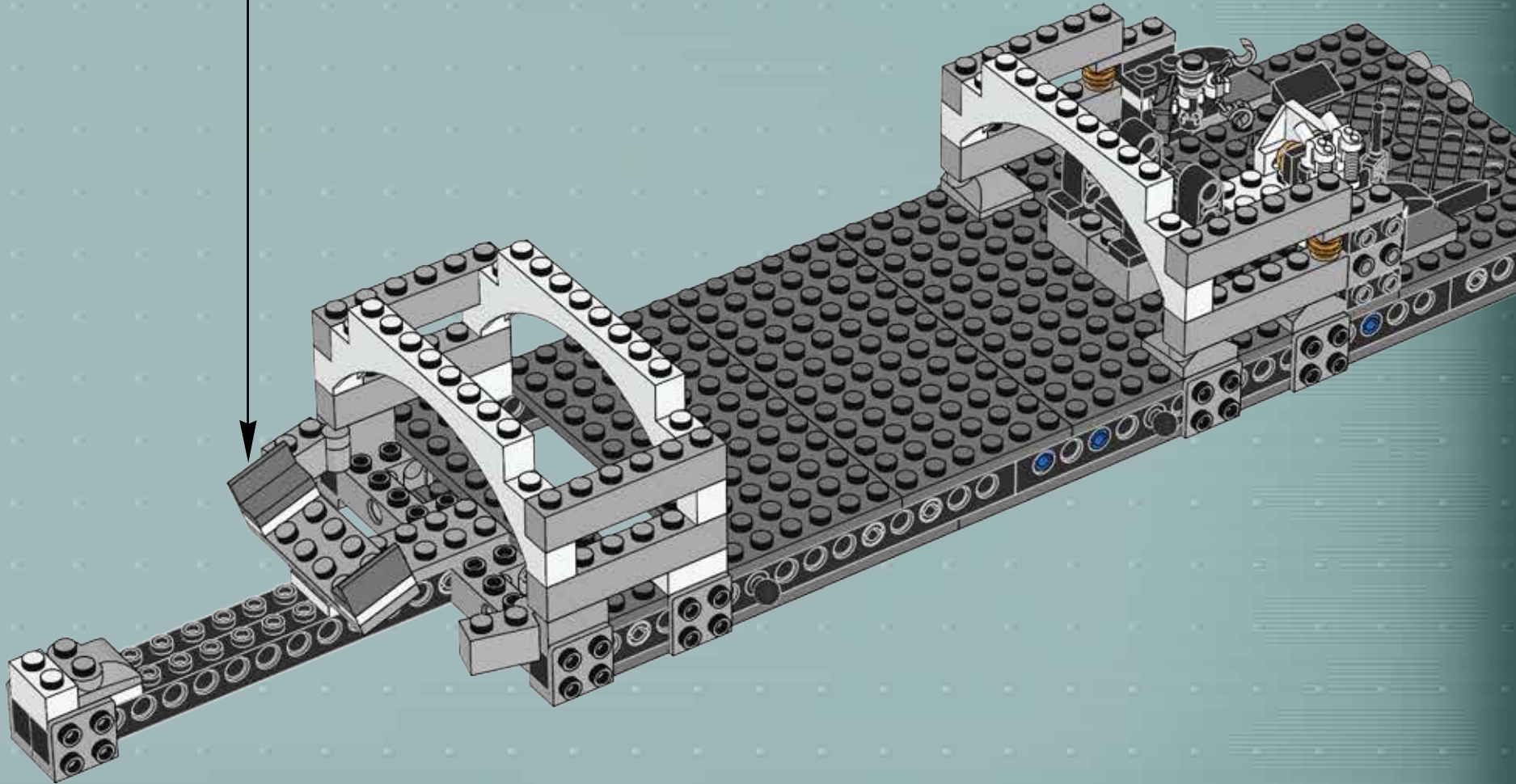

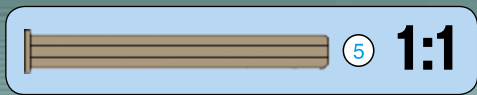
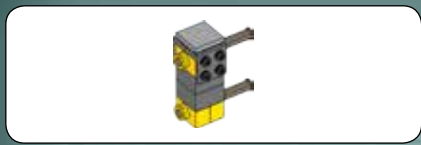

1

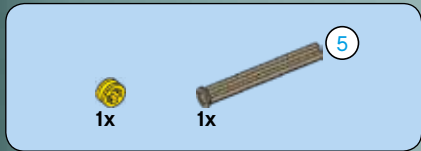
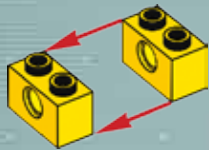

2

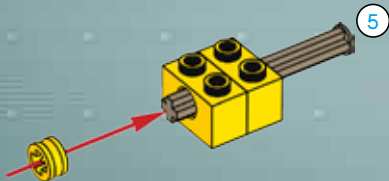

3

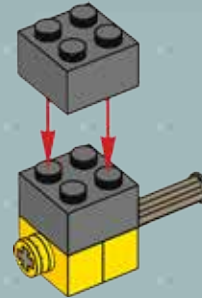

4

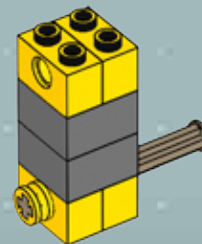

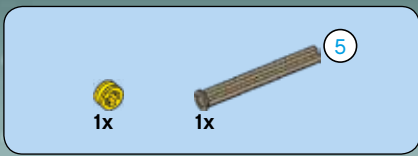

5

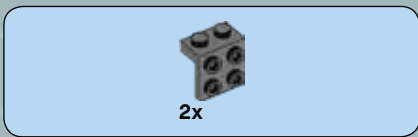
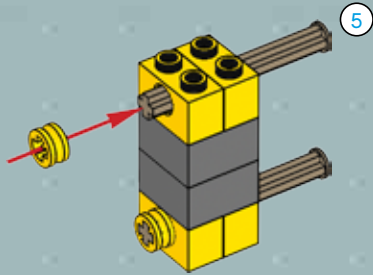

6

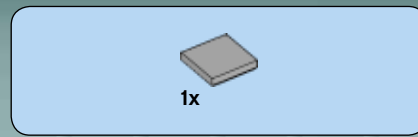
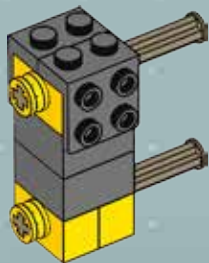

7

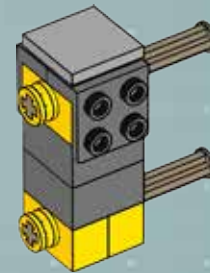

26

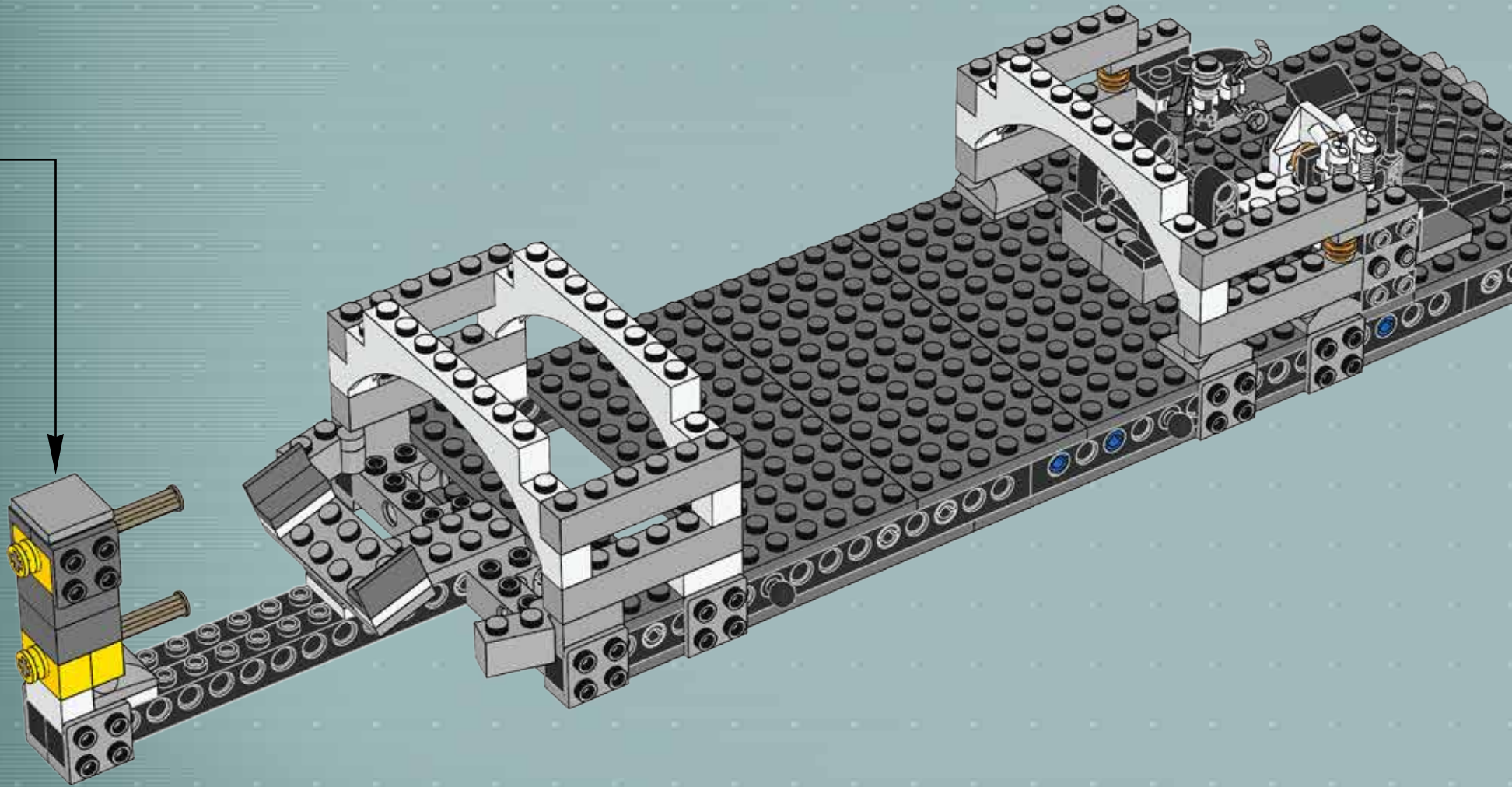



27

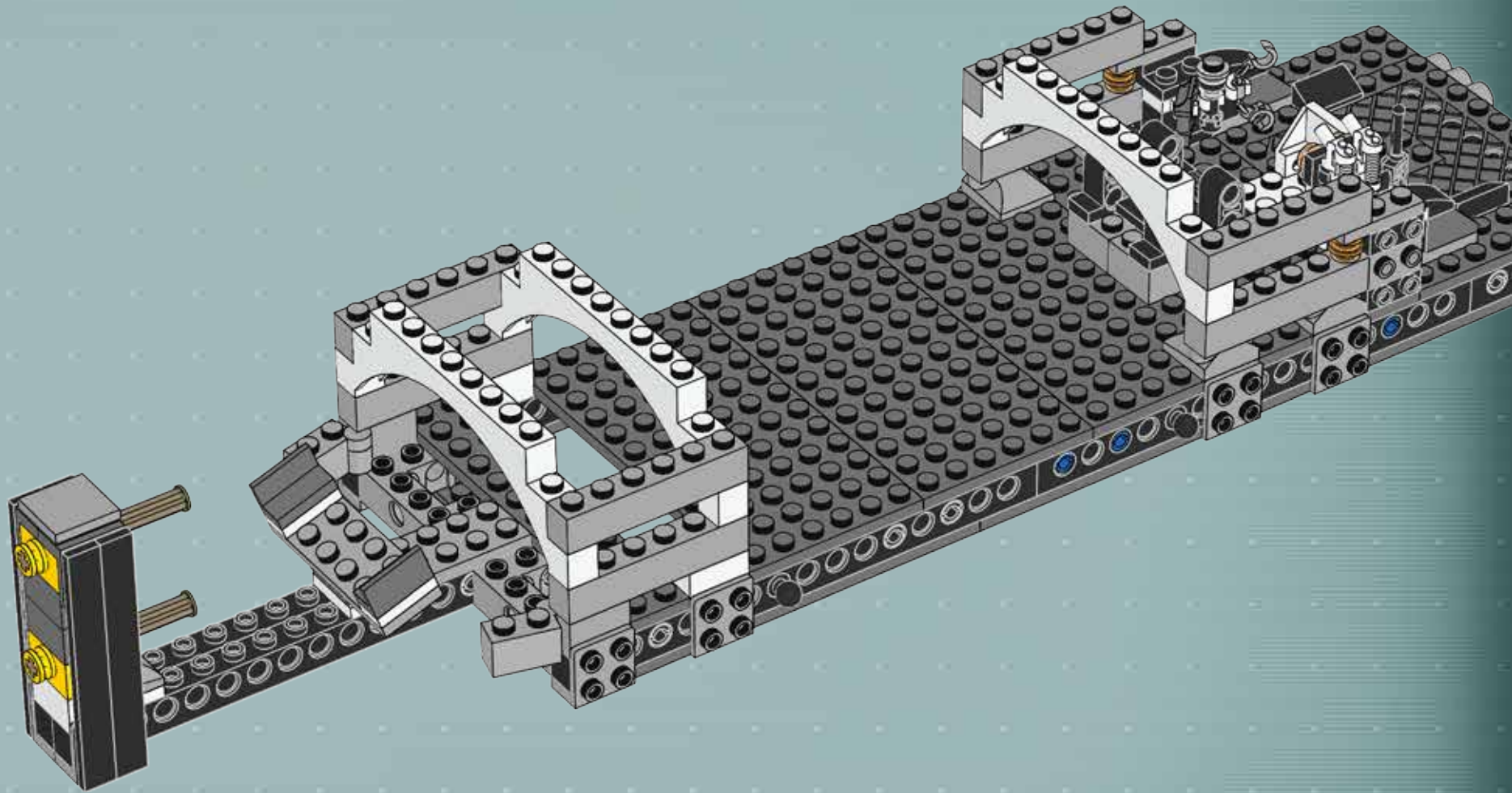

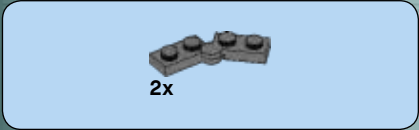
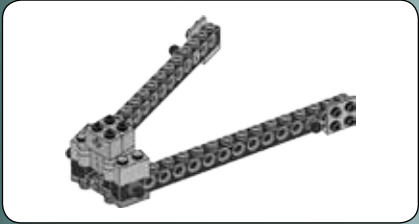
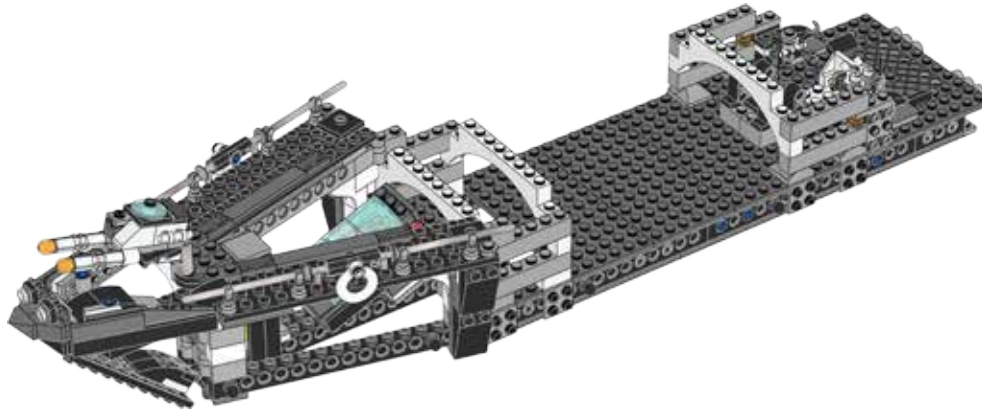
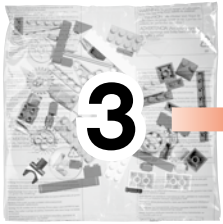

1

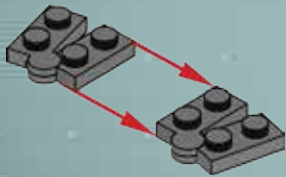

2

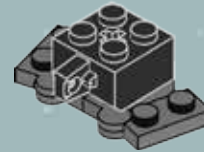



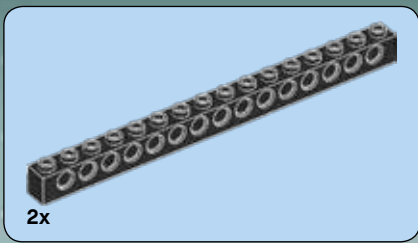

3

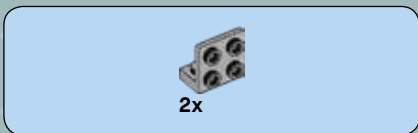
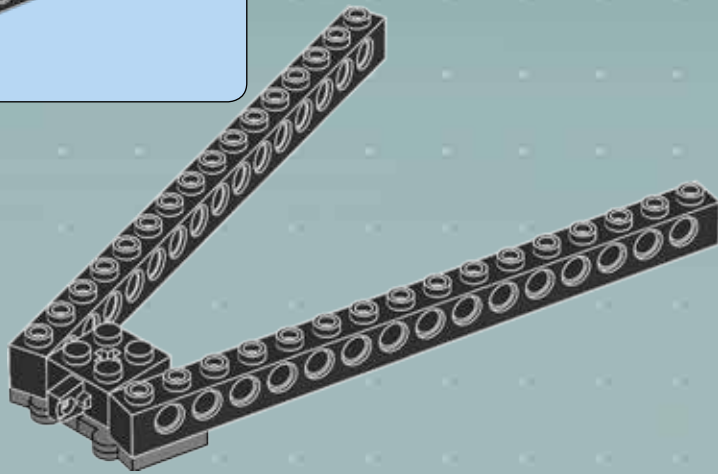

4

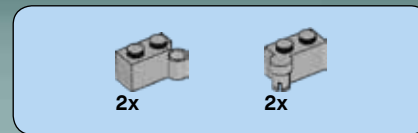
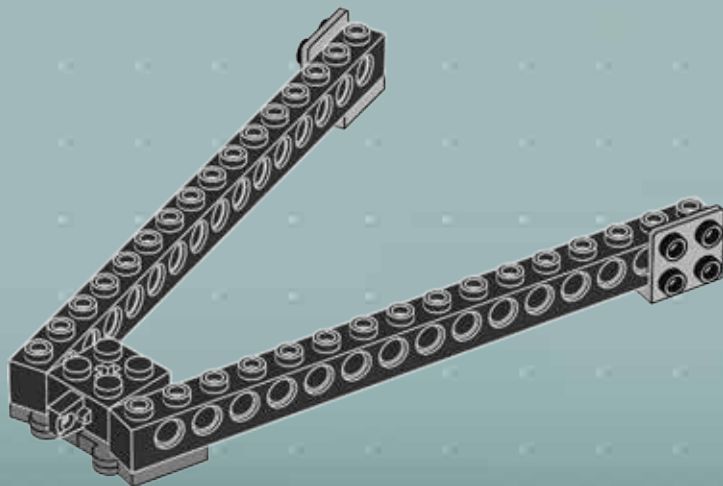

5

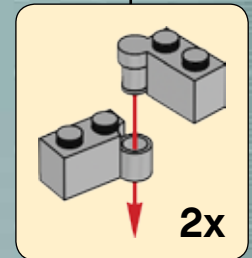
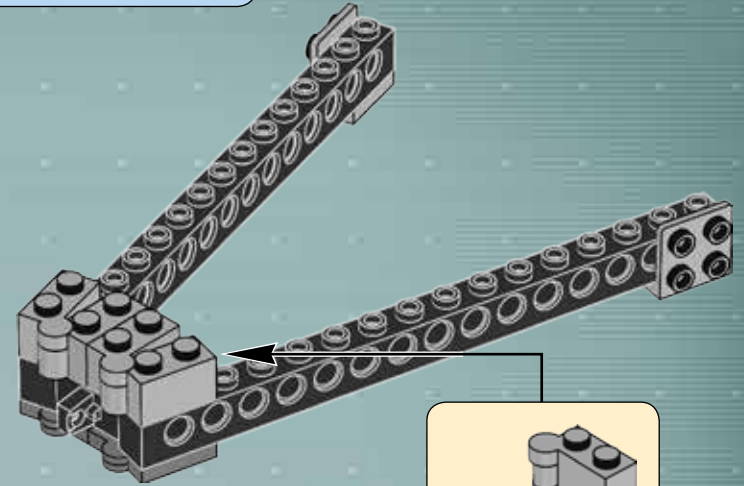

6

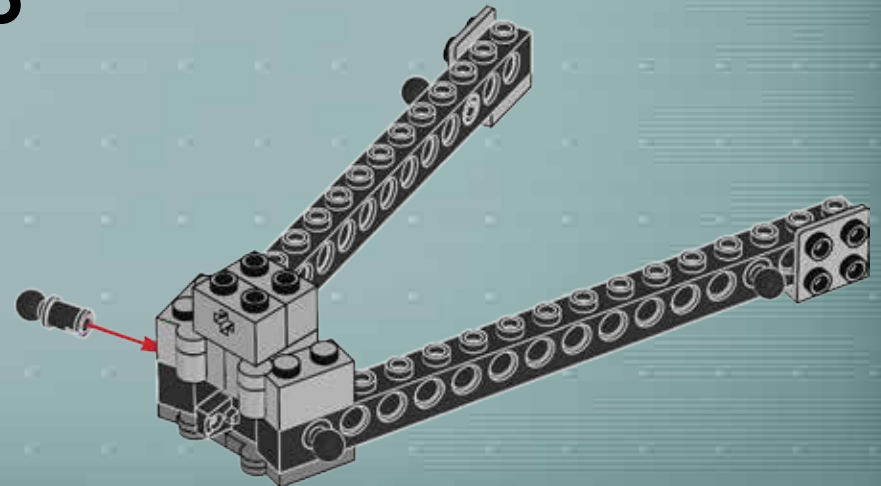

28

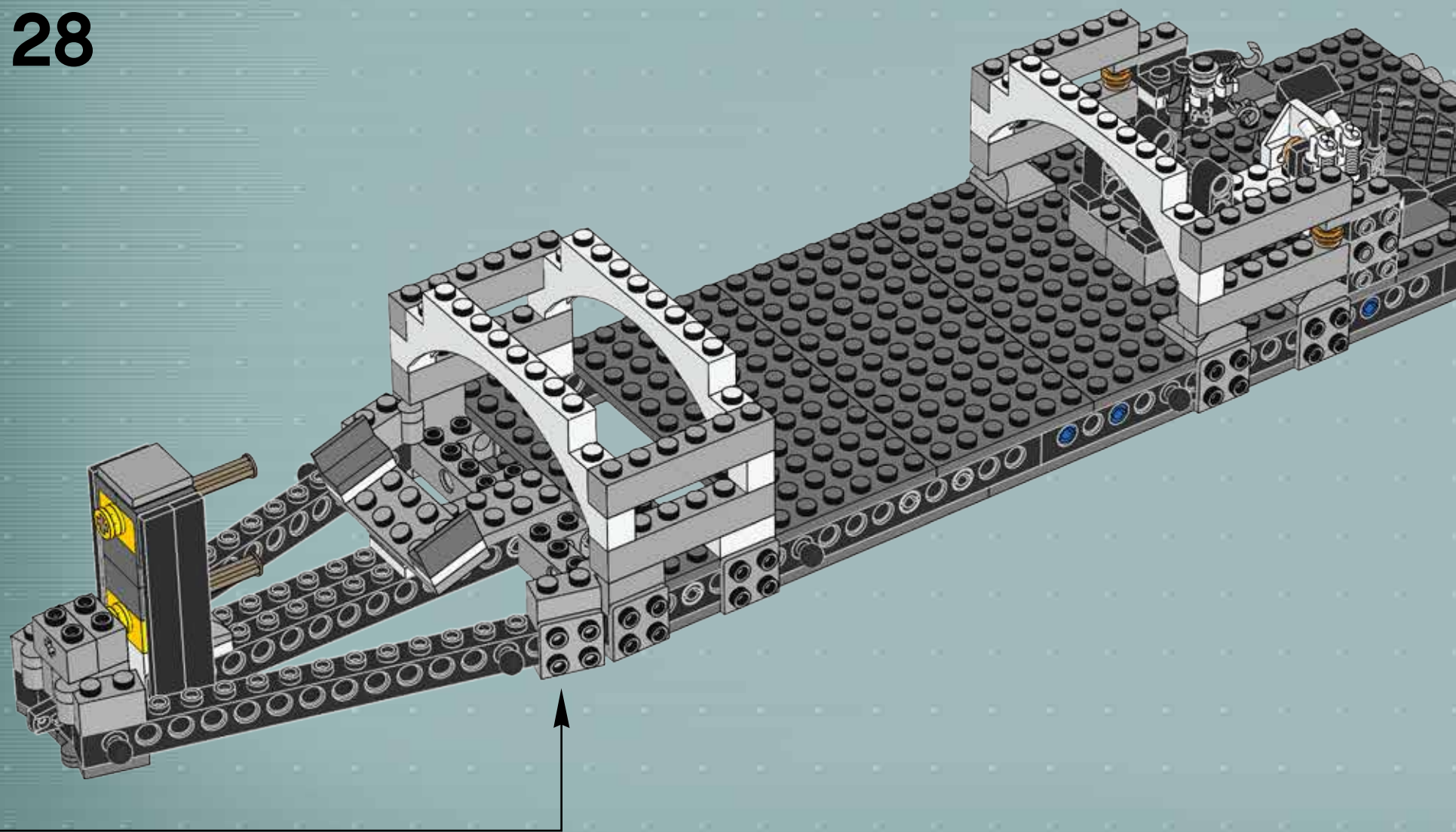

29

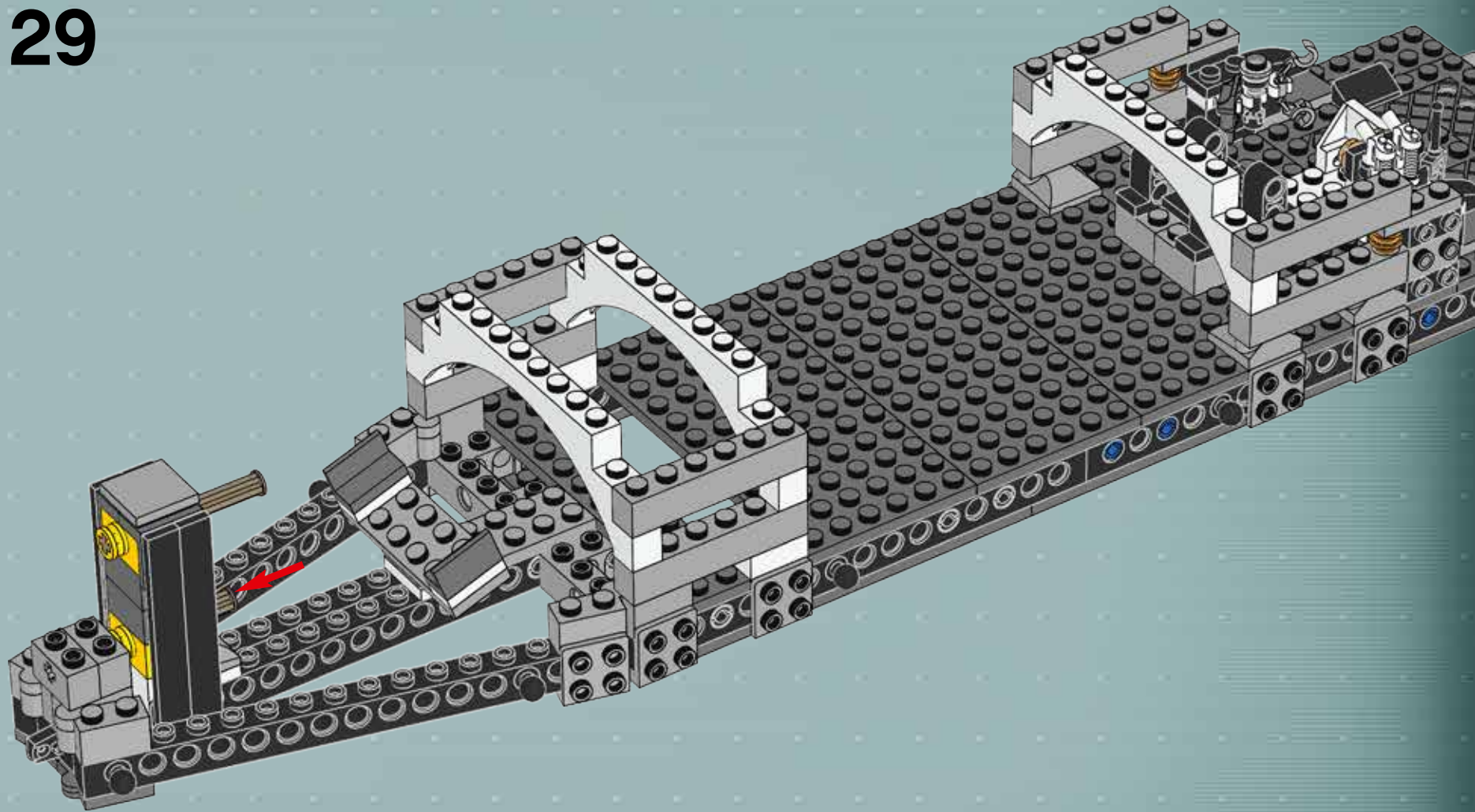

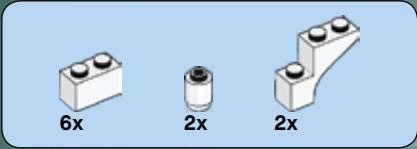

30

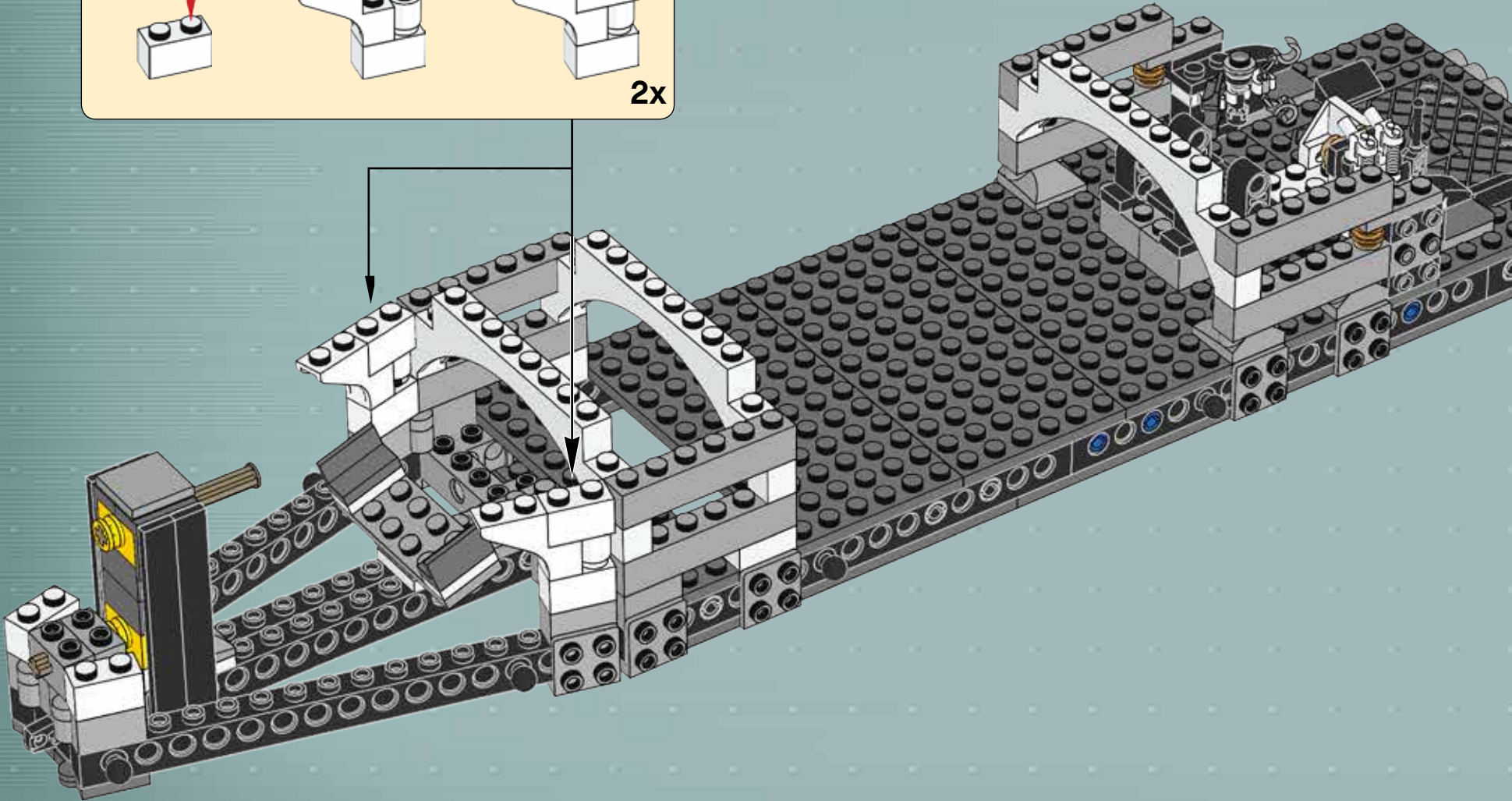
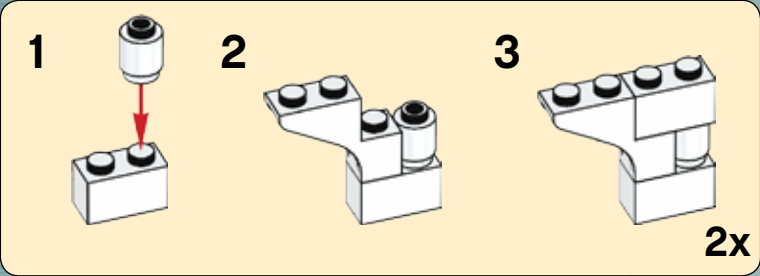



2x



2x

# 31

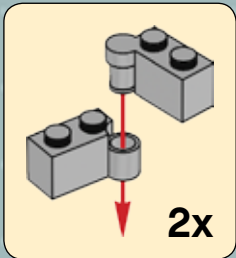

2x

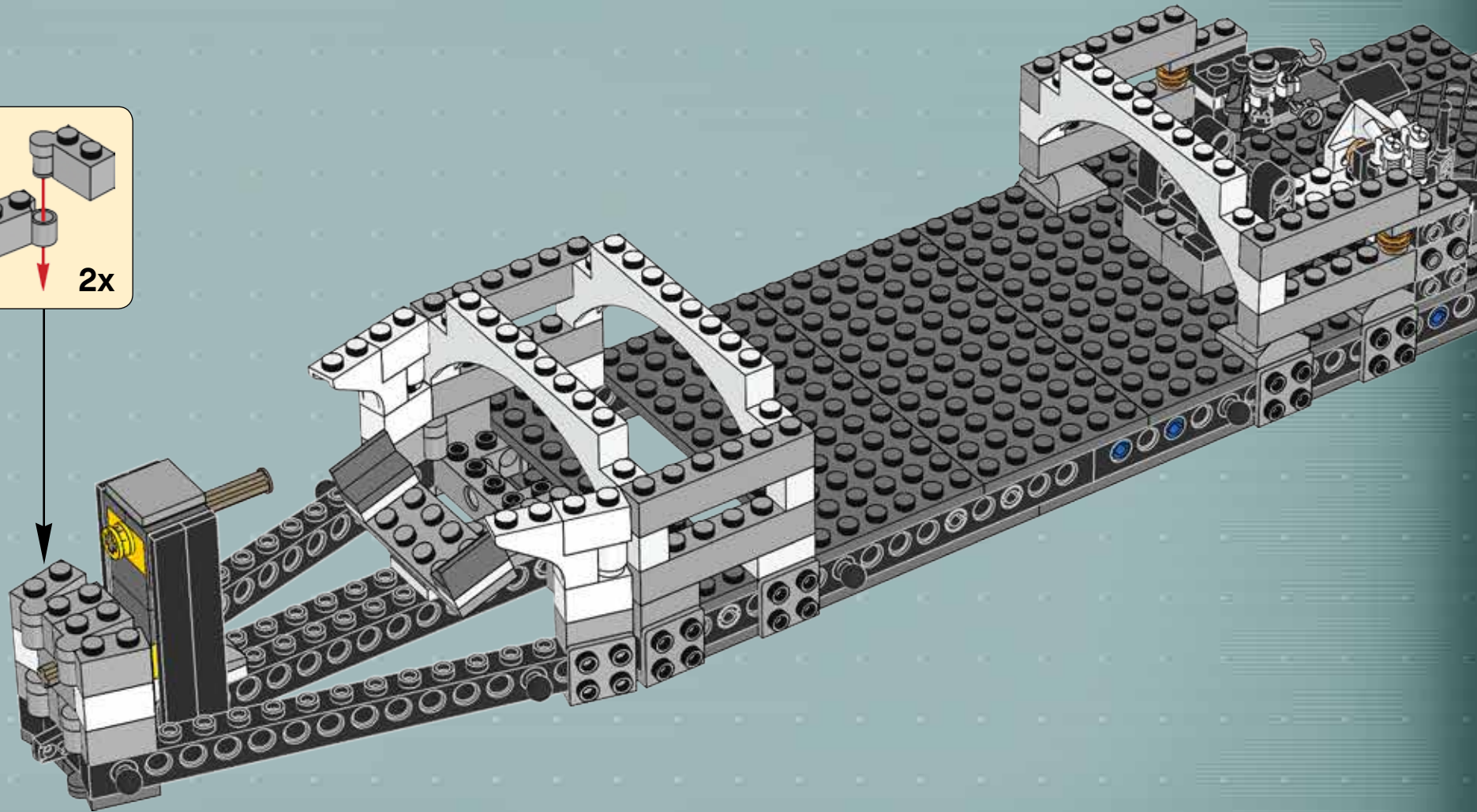

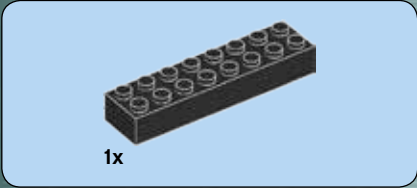
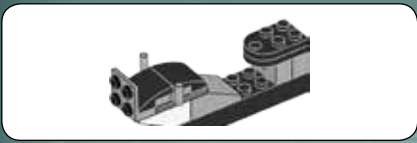

1x

1

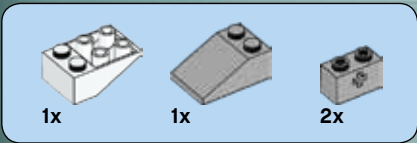
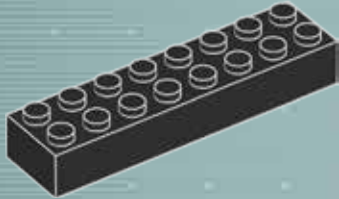

1x

1x

2x

2

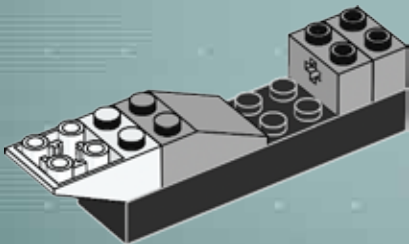

1x

2x

3

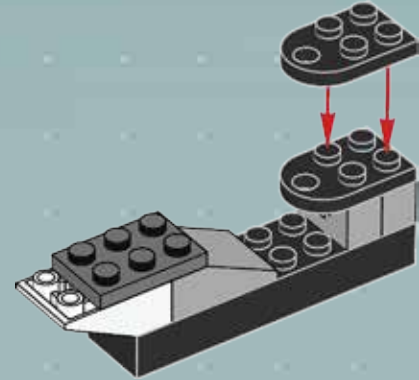

2x

4

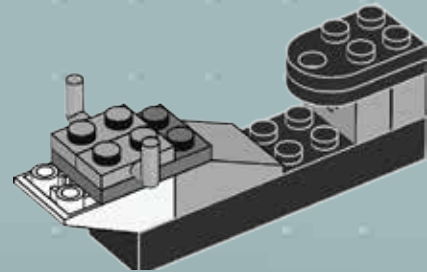



5

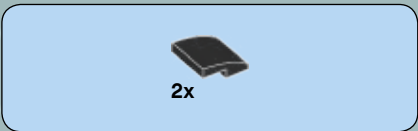
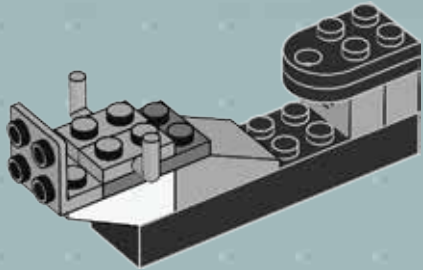

6

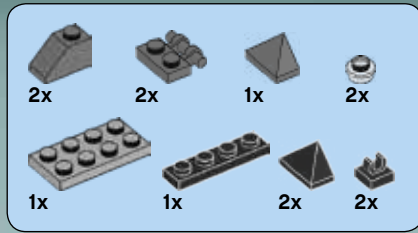
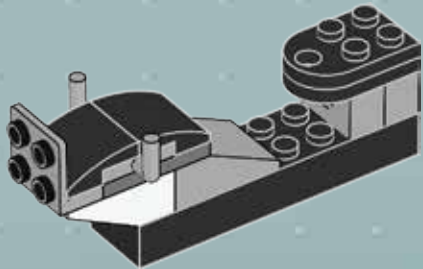

7

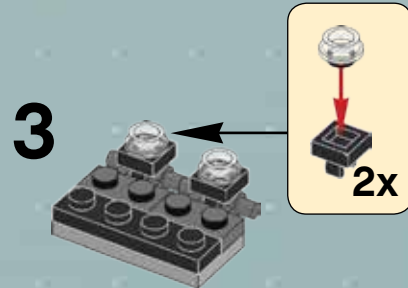
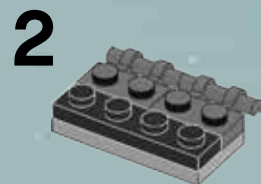

4



5

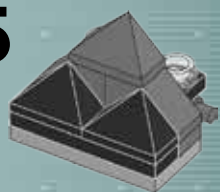

32

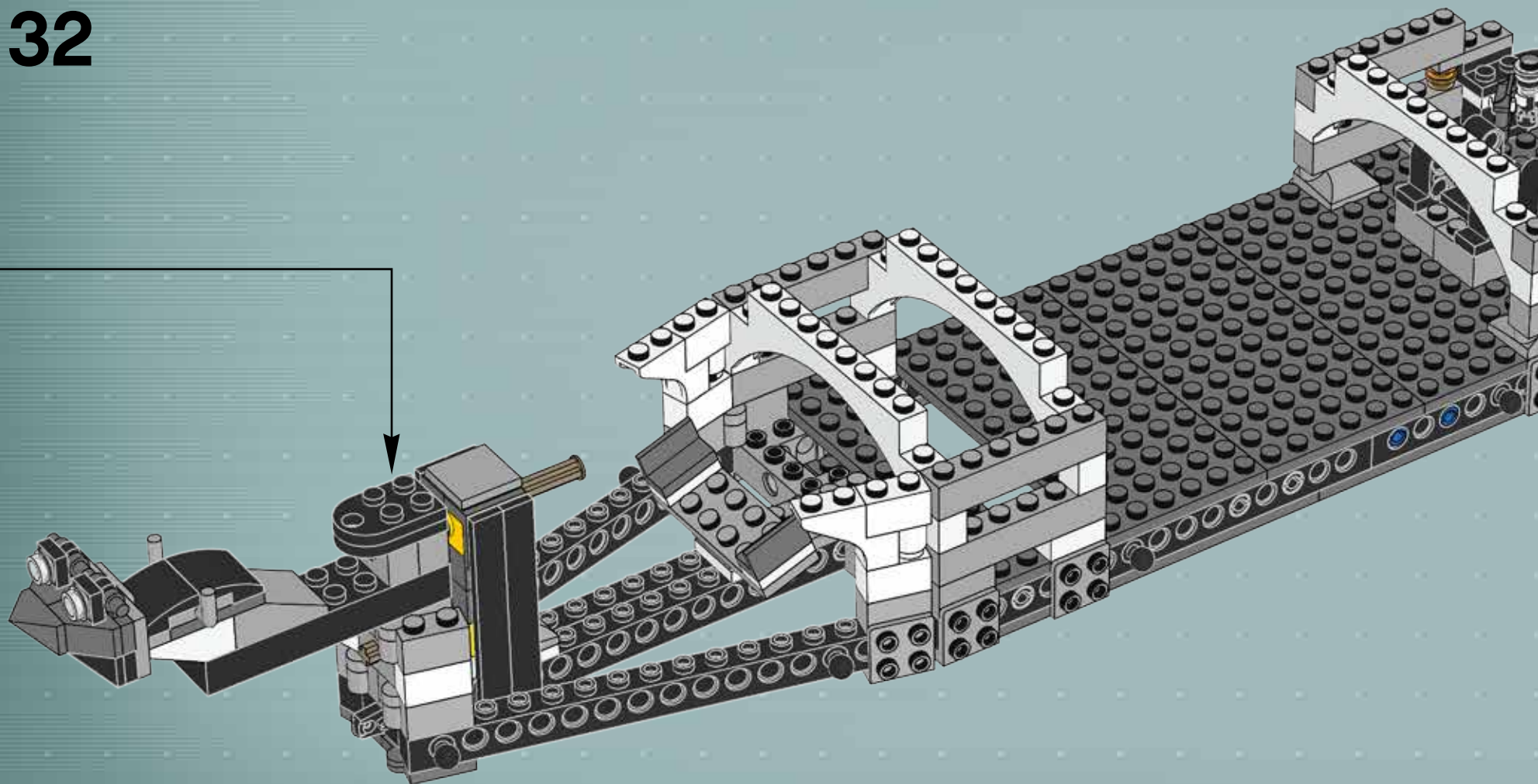



33

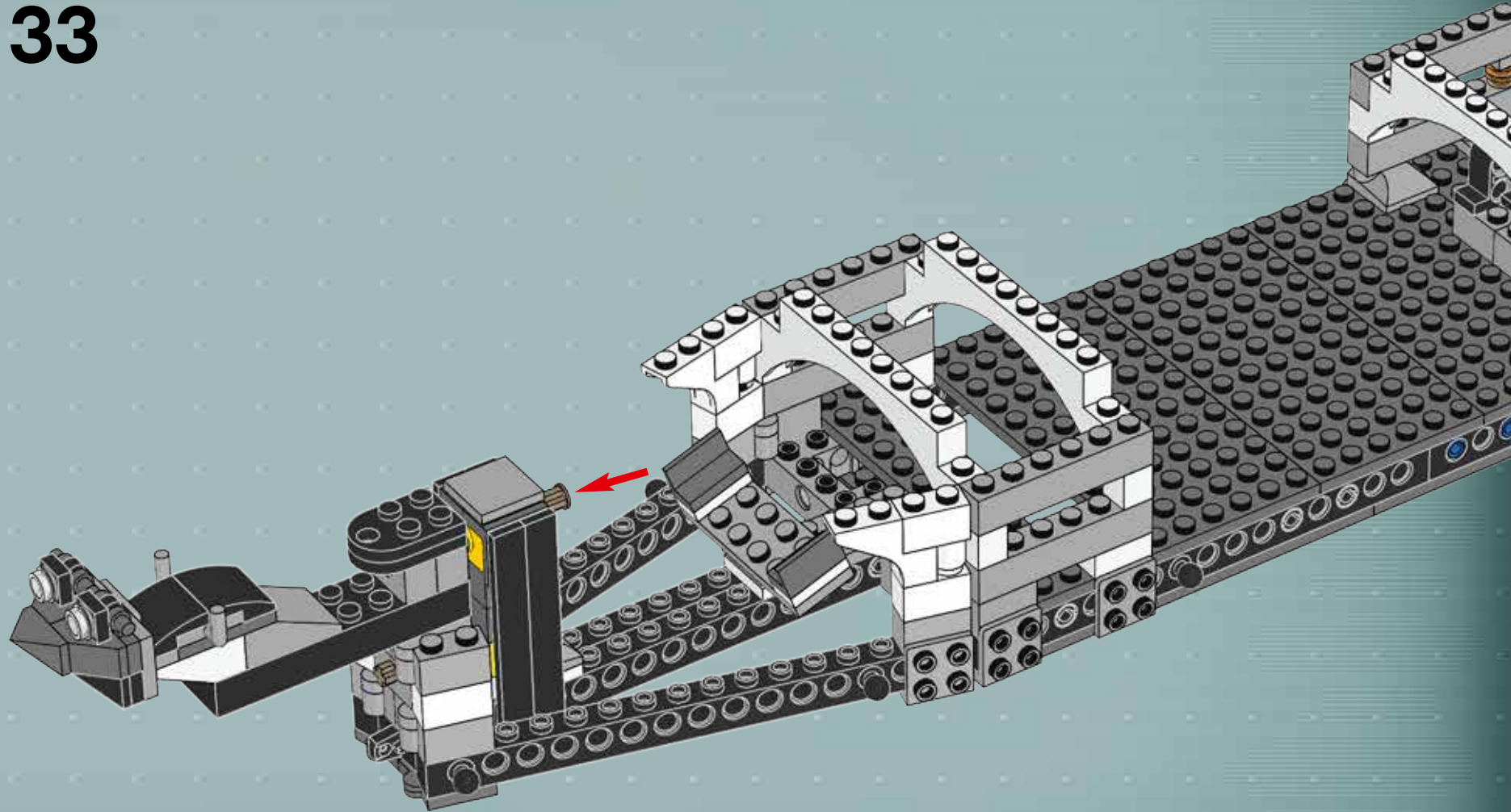

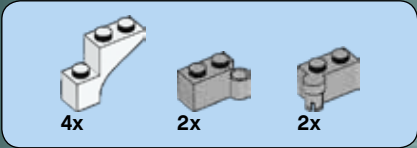

# 34

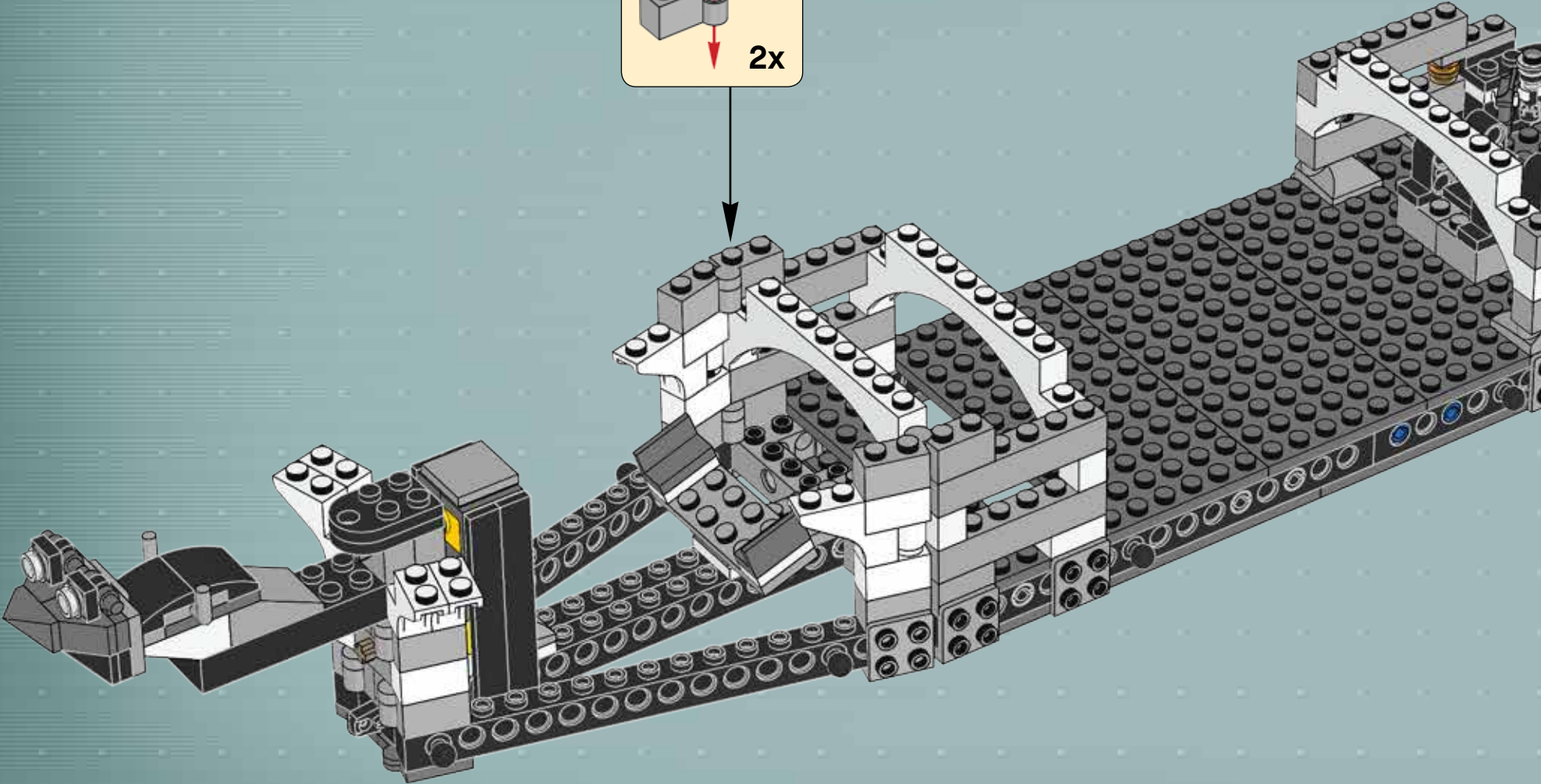
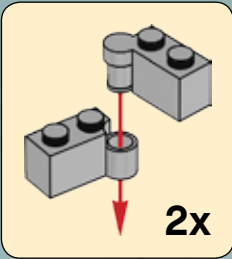

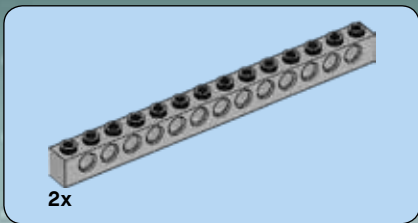

35

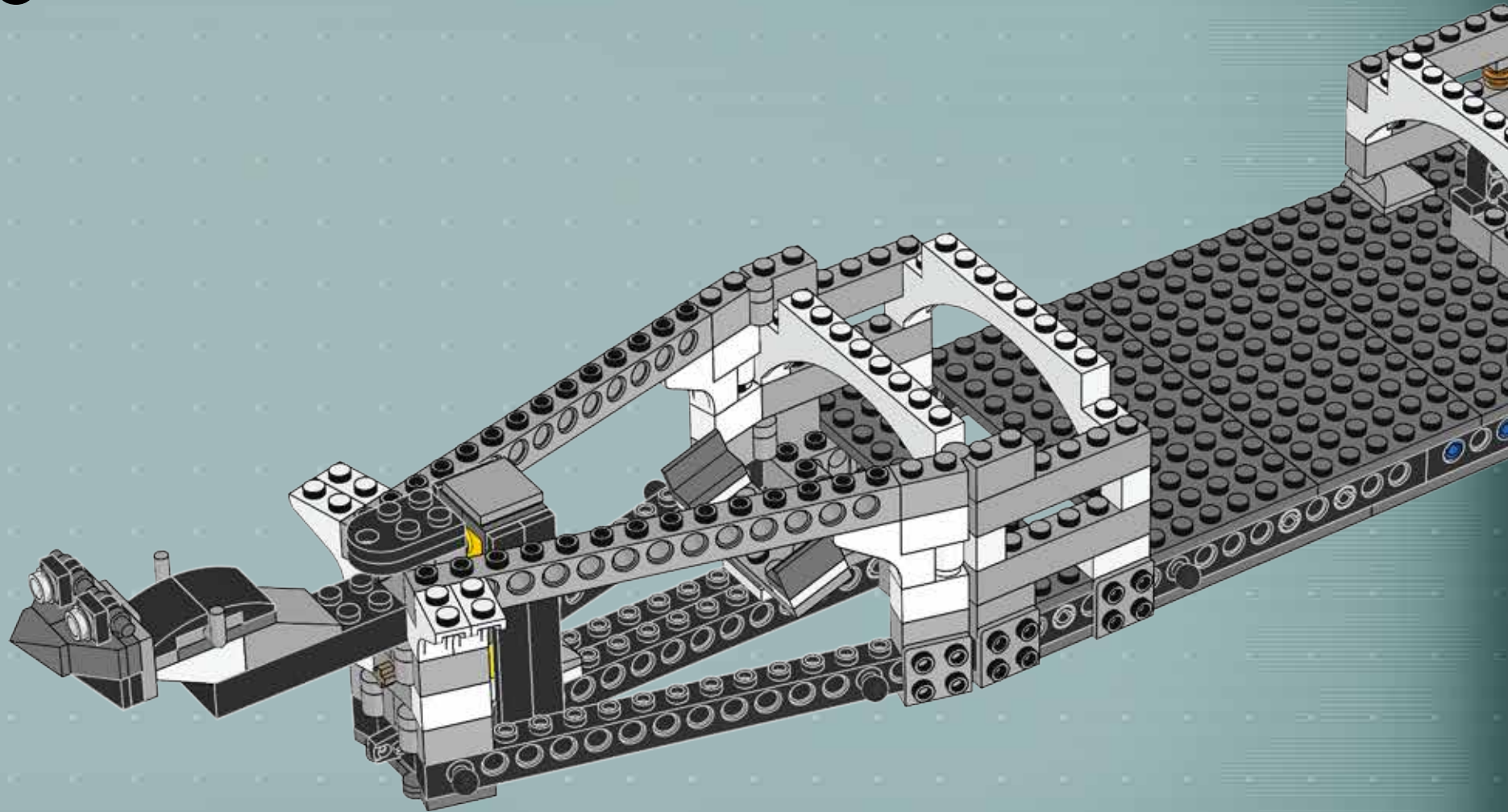

36

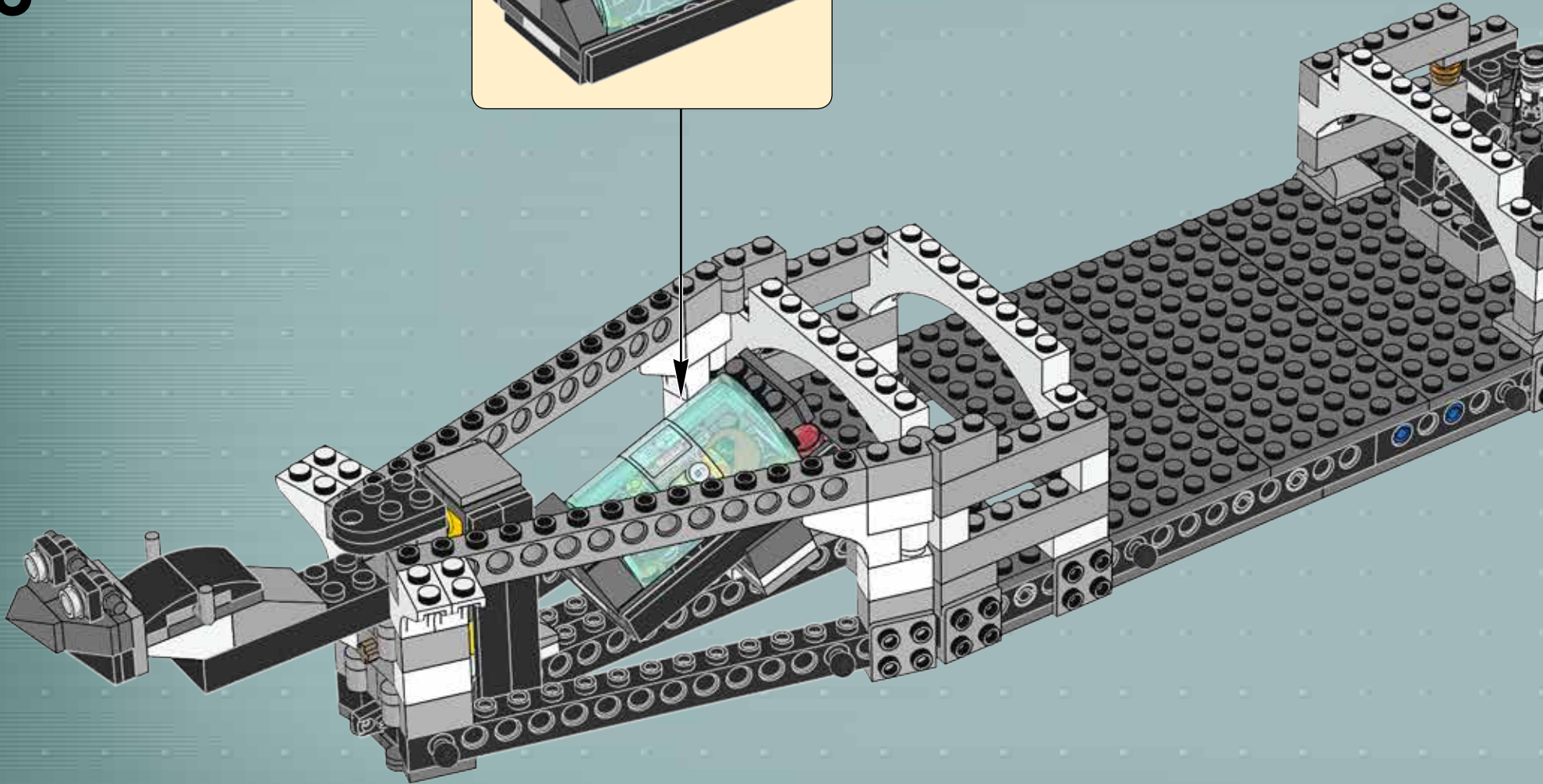
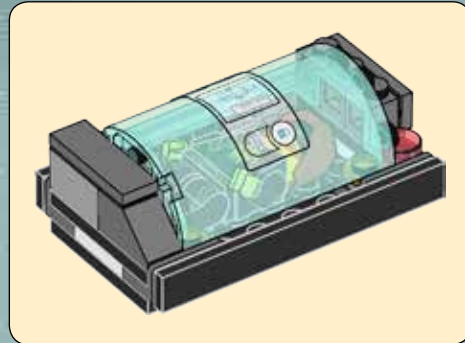

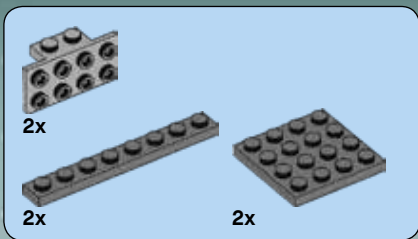

37

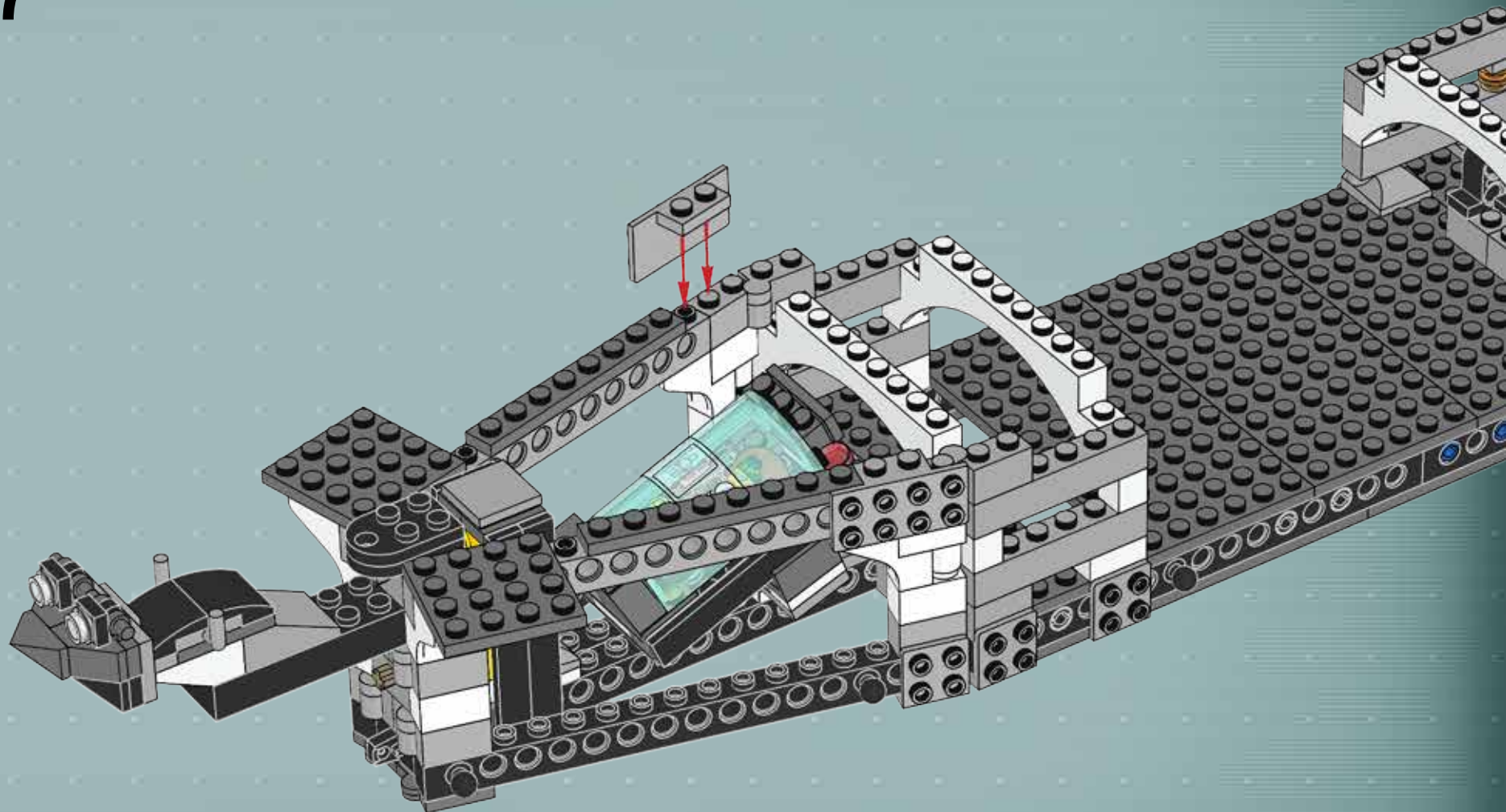

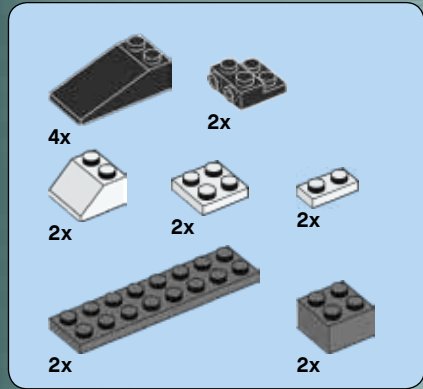

38

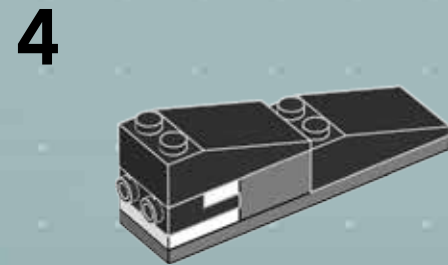
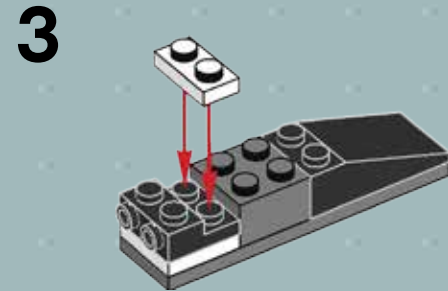
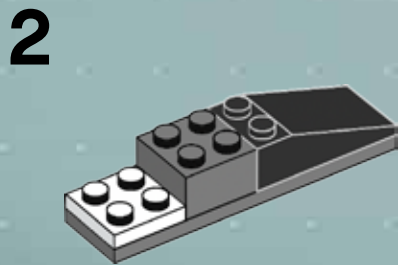
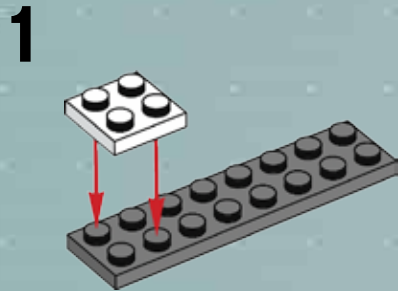

2x

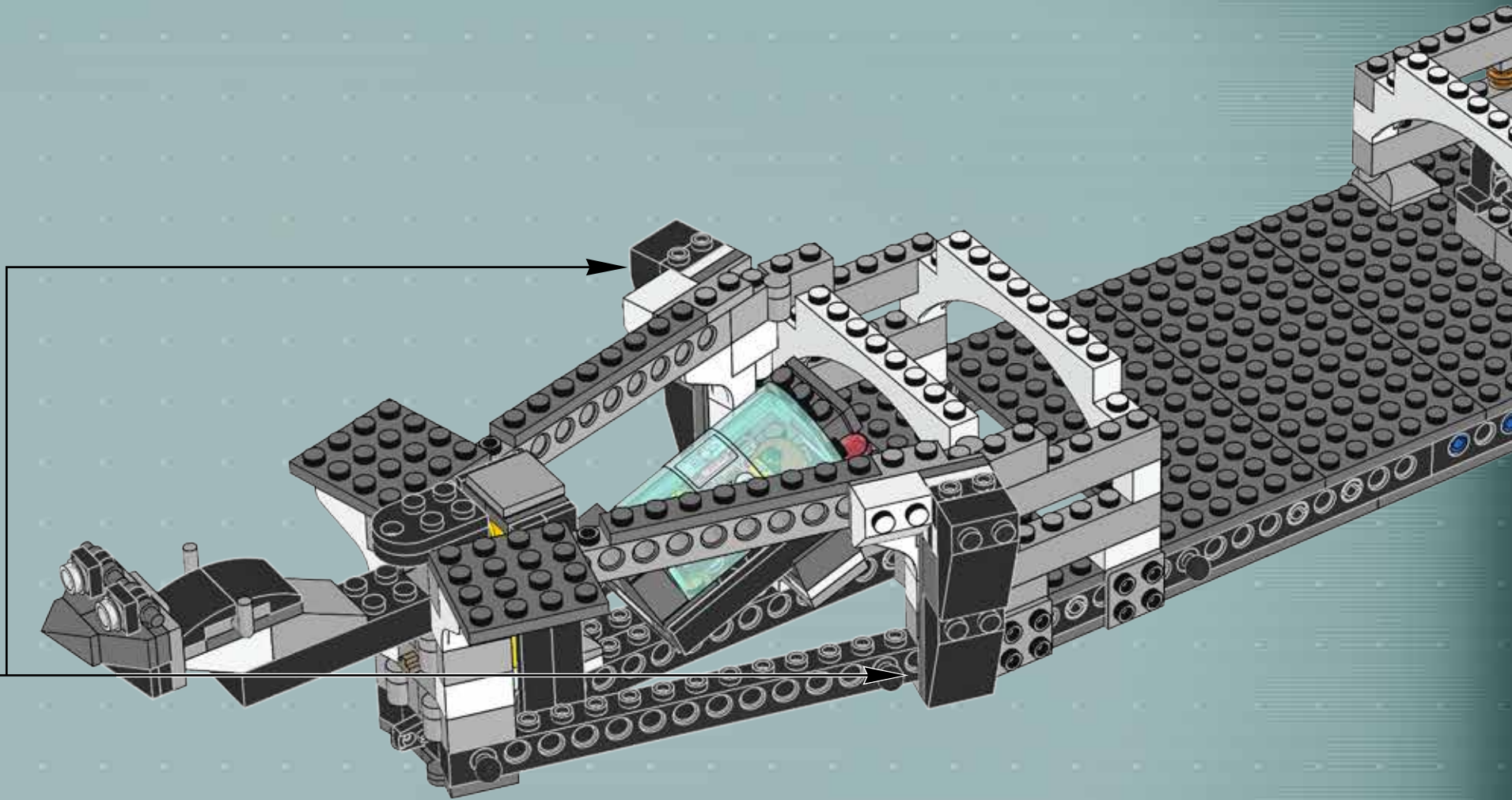

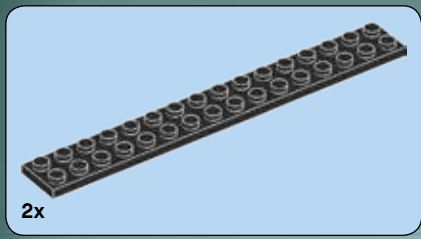

39

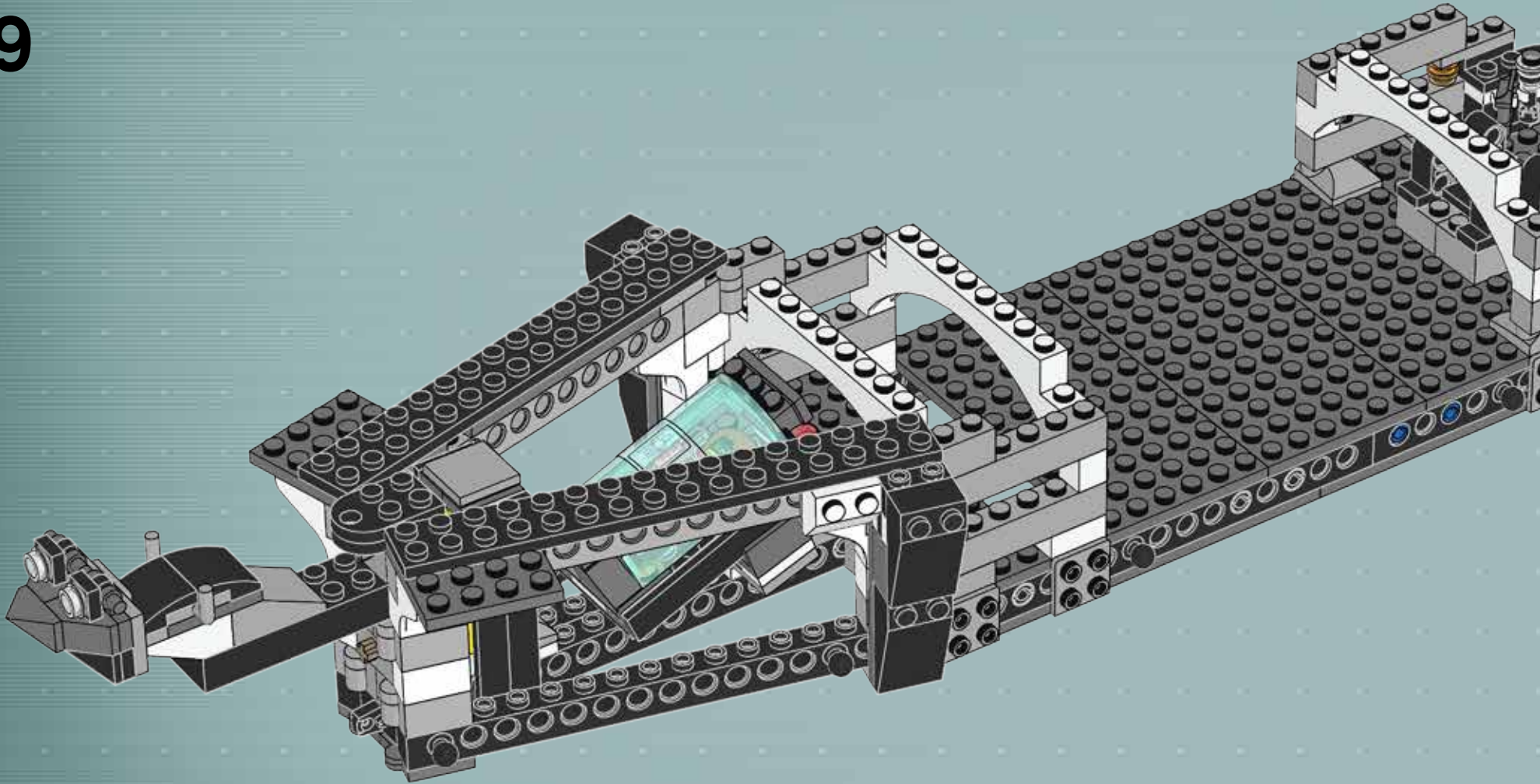



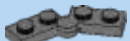

2x

# 40

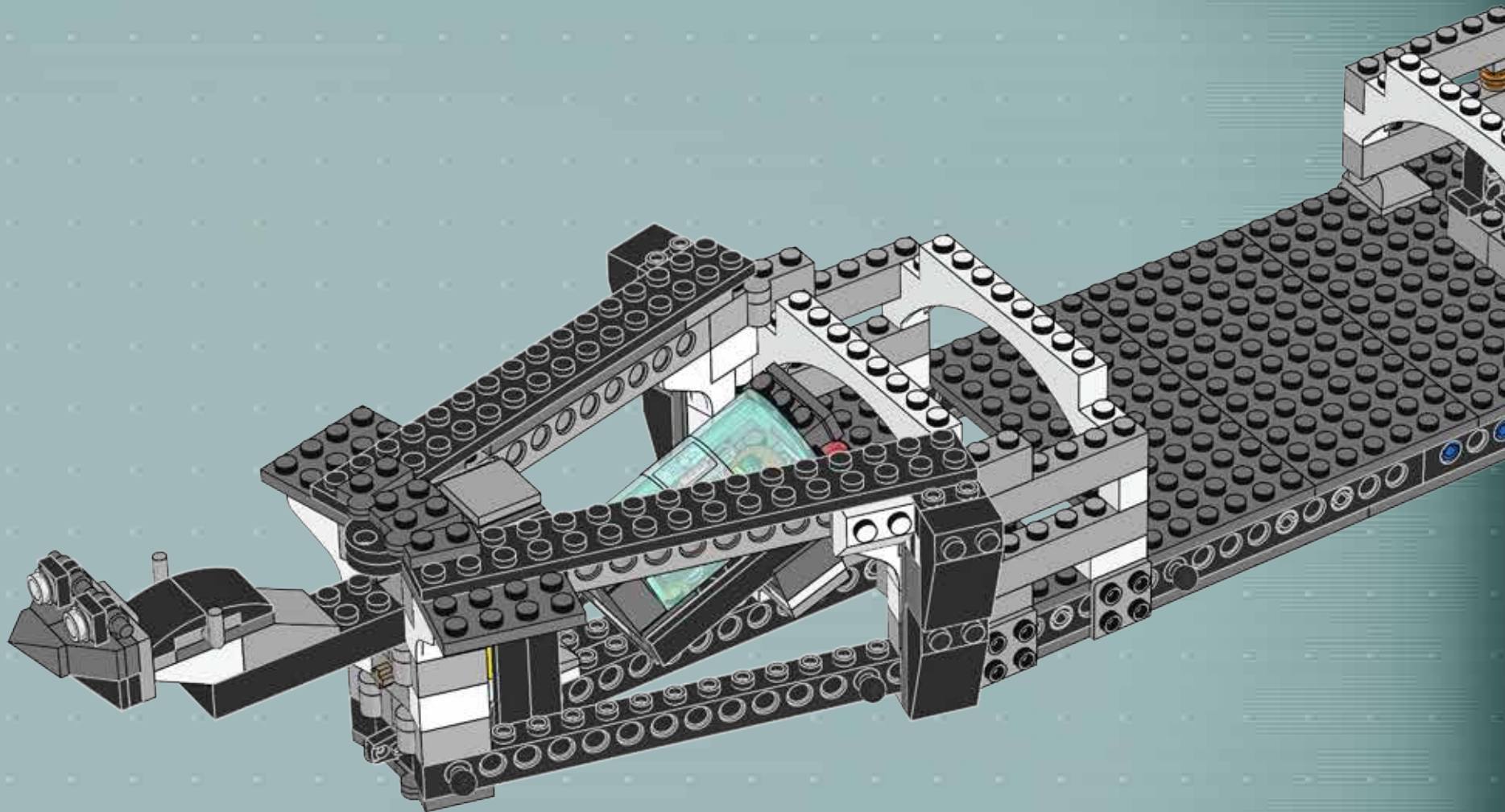

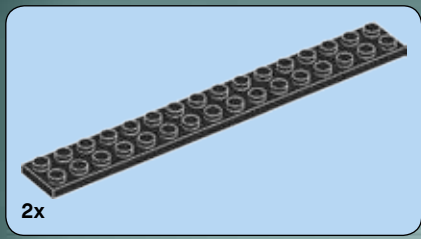

41

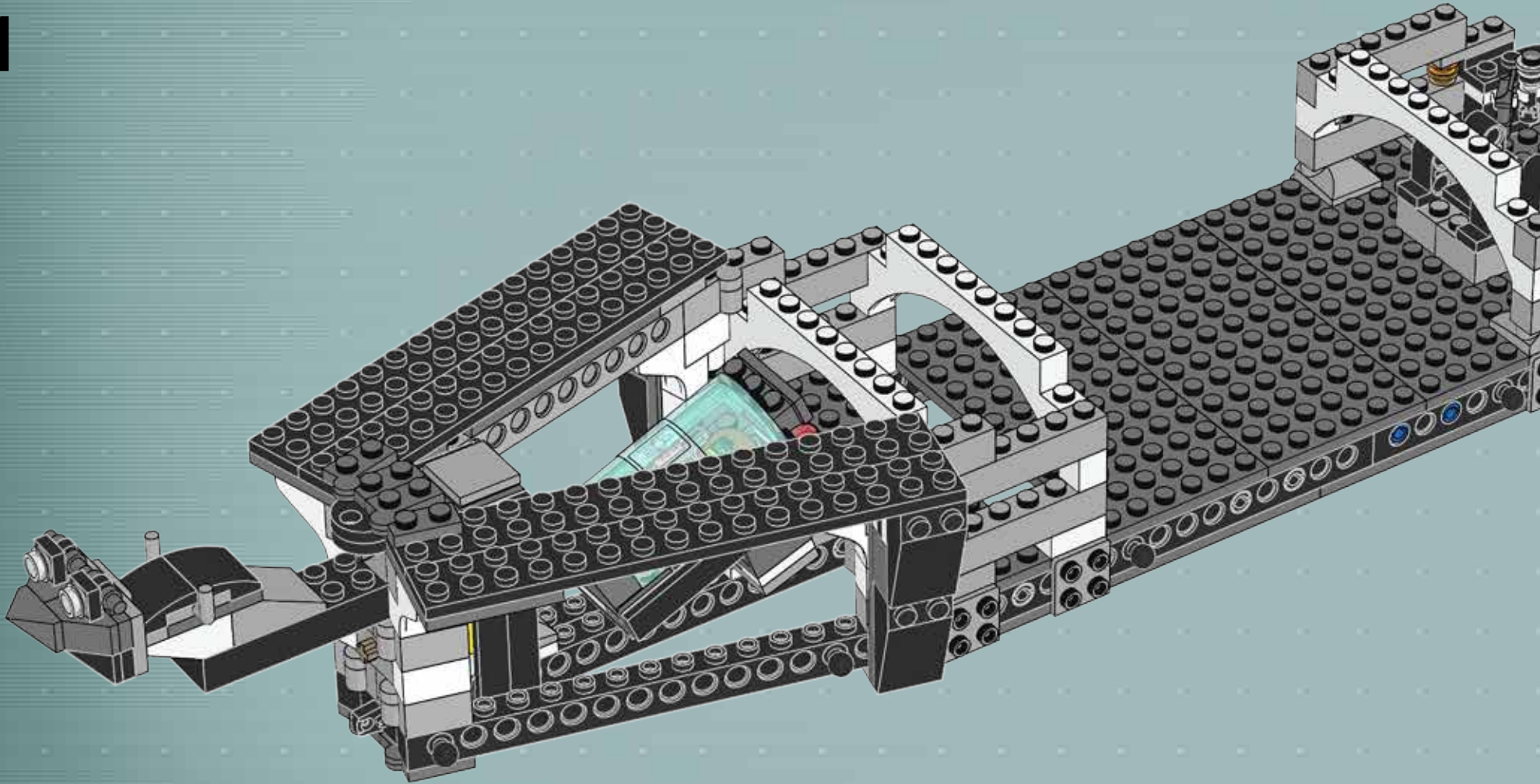

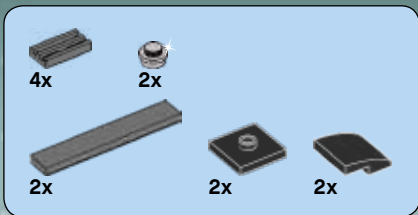

42

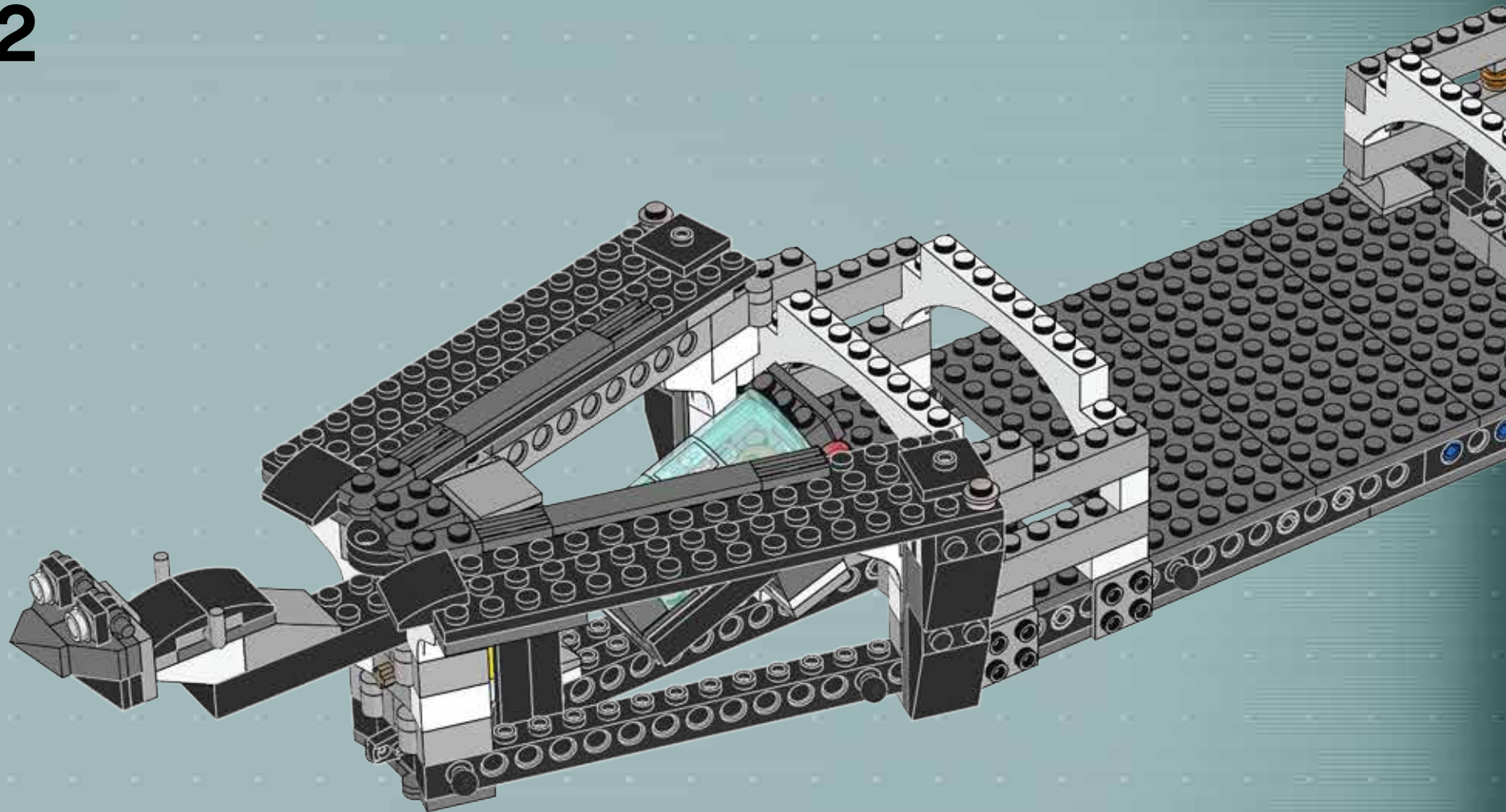

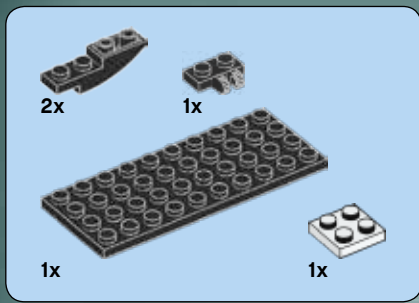

43

1

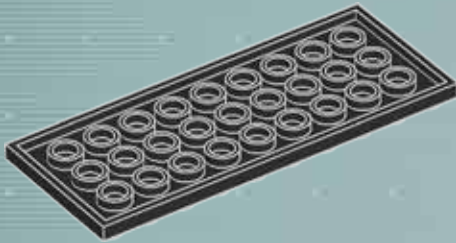

2

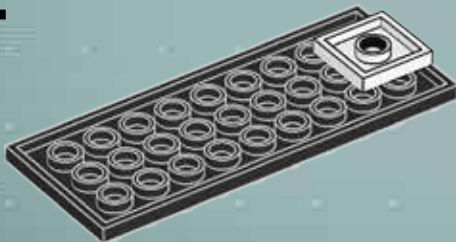

3

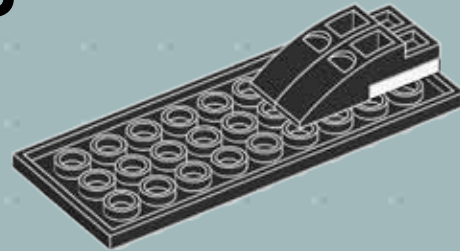

4

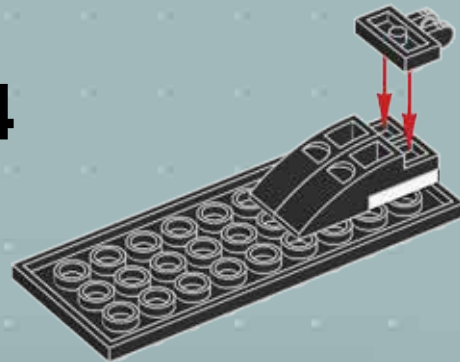

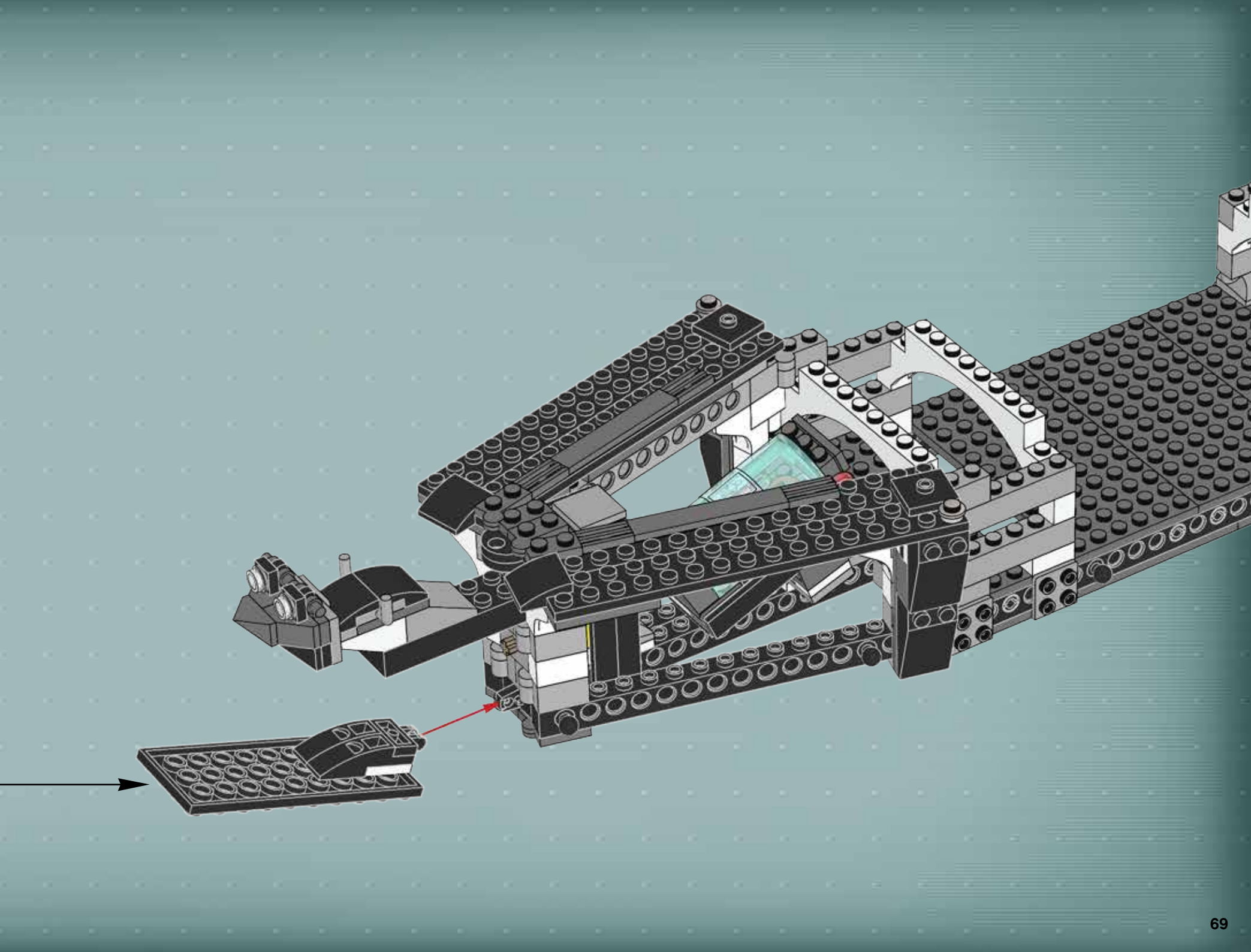



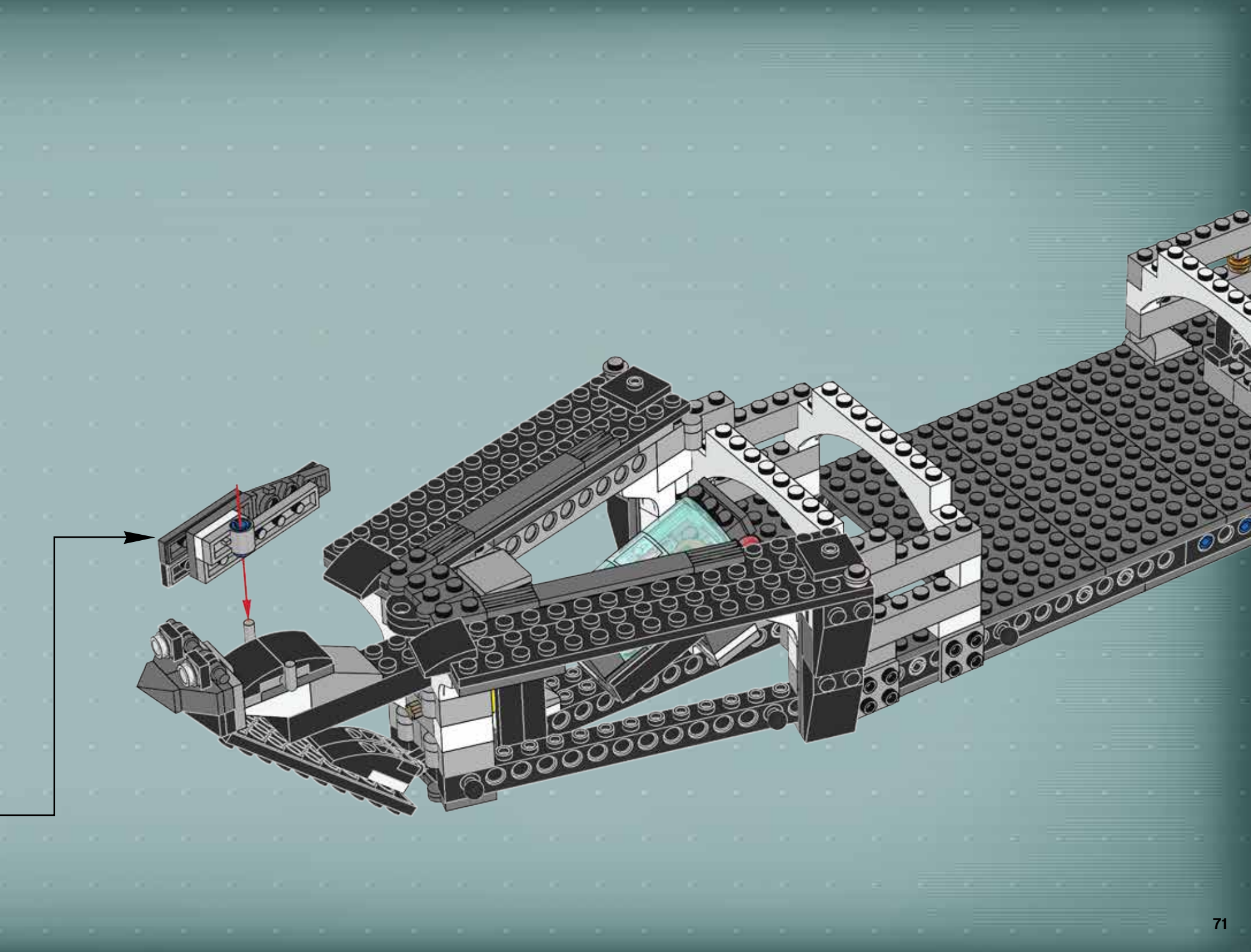

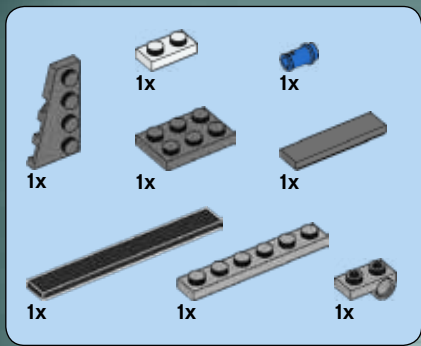

45

1

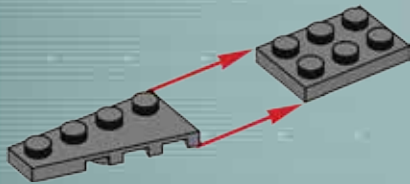

2



3

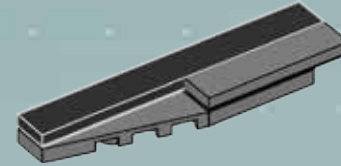

4

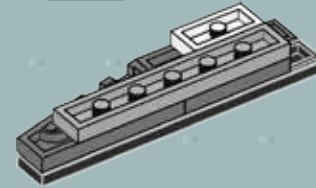
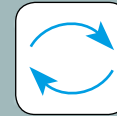

5

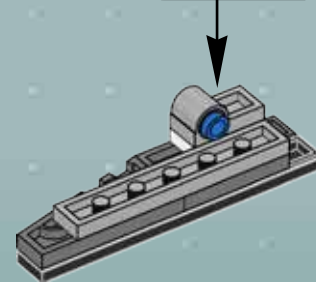
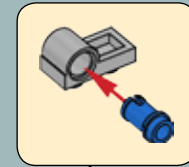



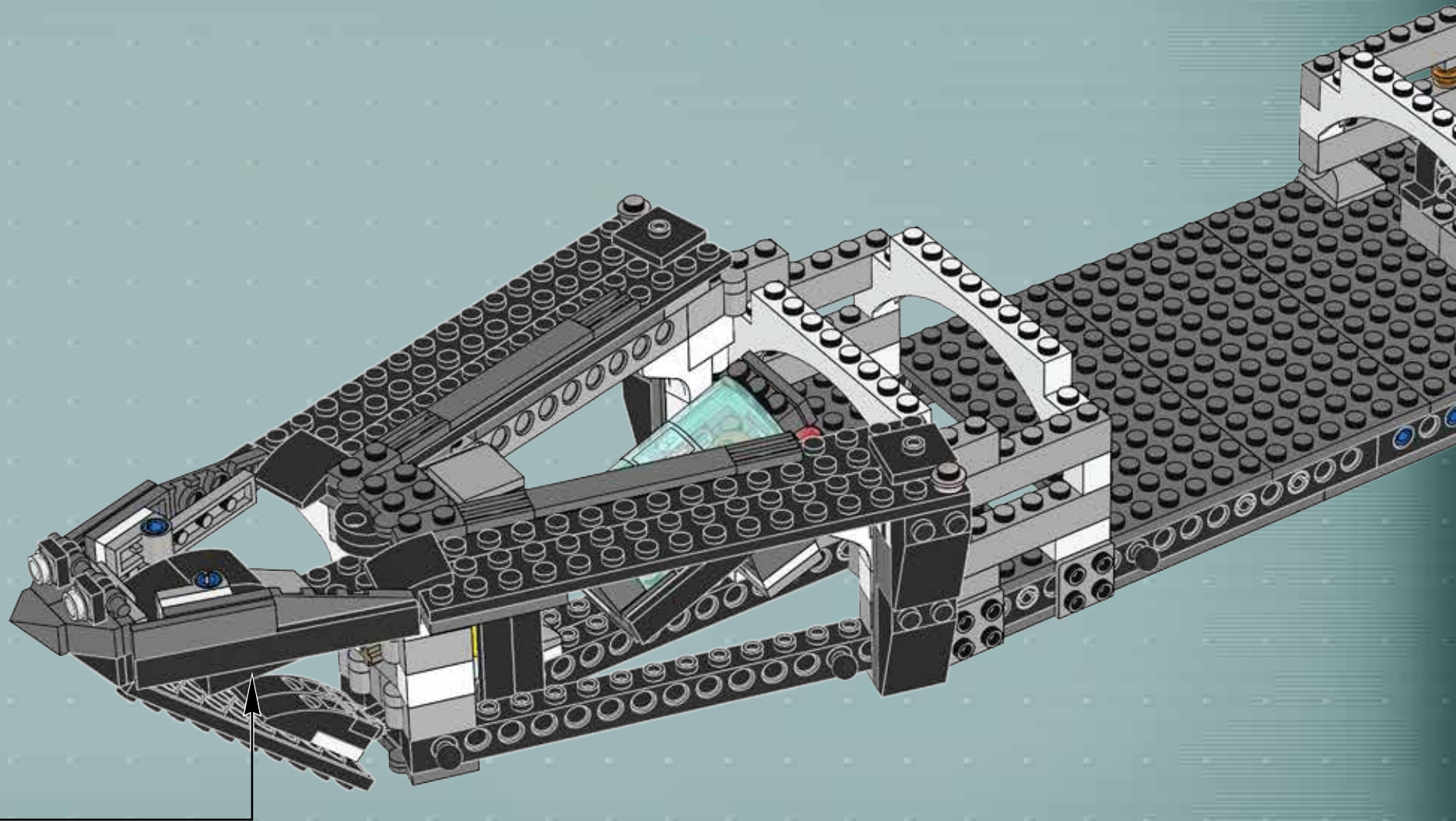

1x

1x

1x

8x

# 46

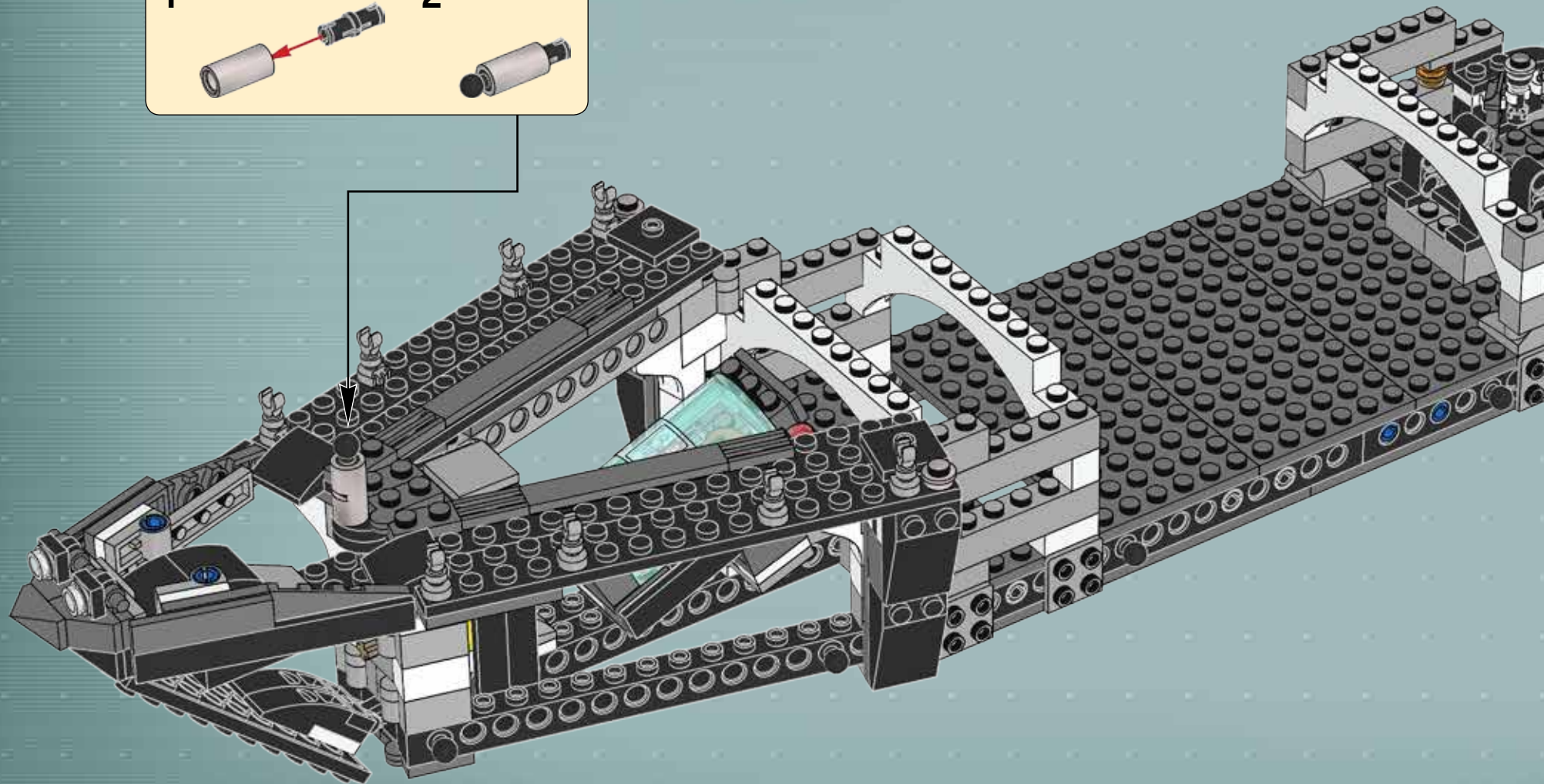
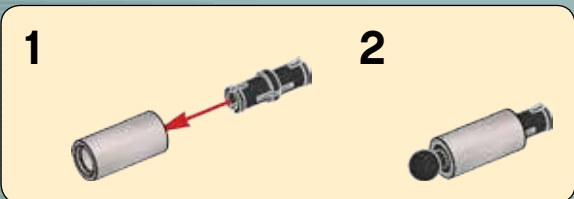

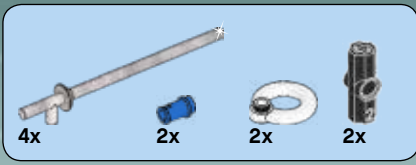

47

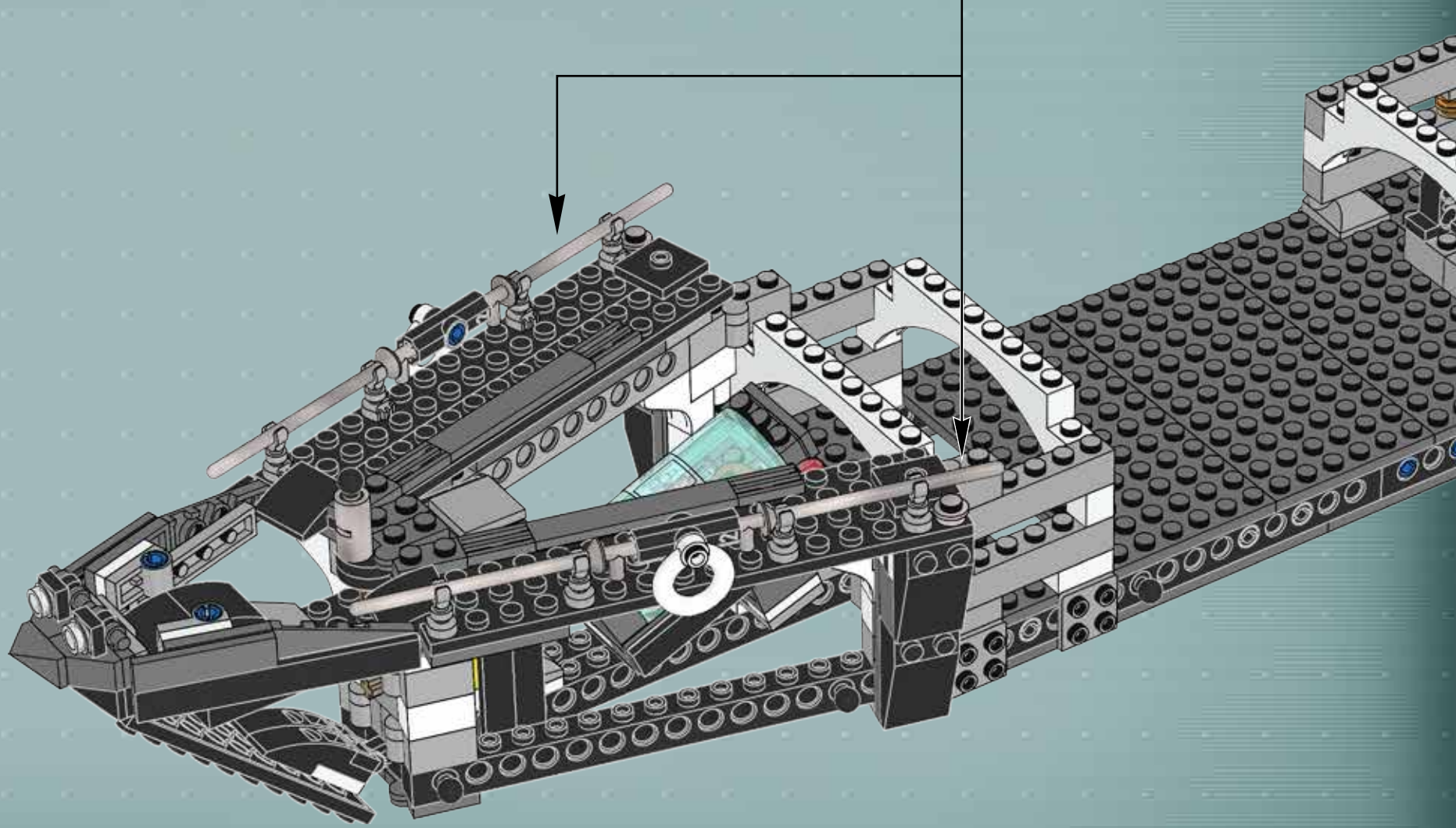
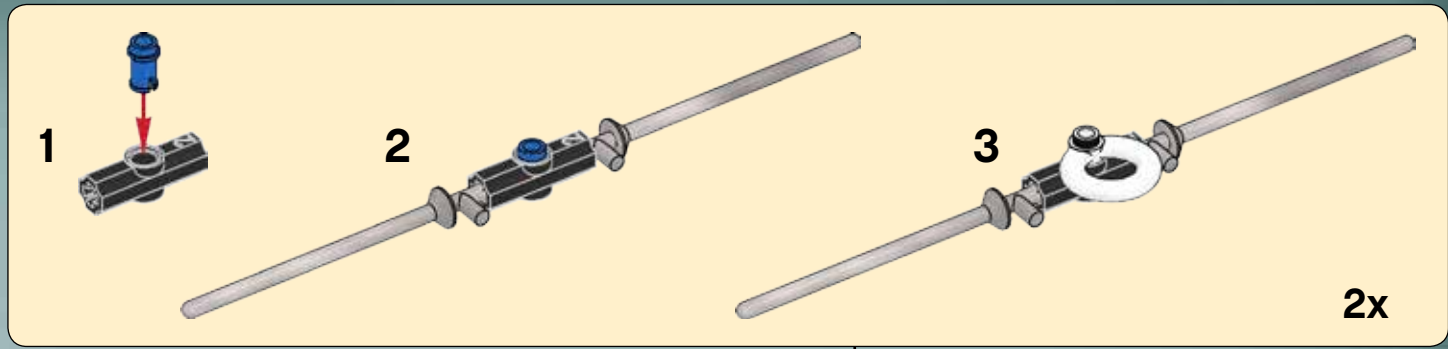

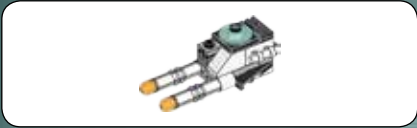

1

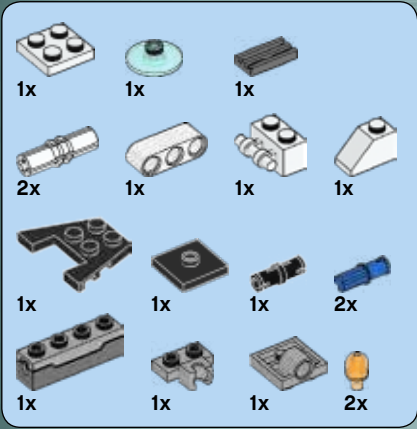
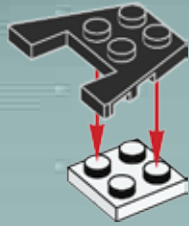

2



3

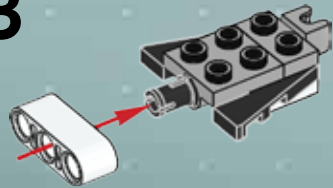

4

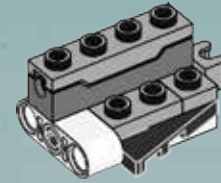

5

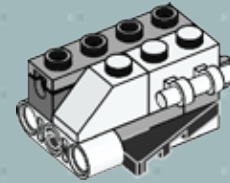

6

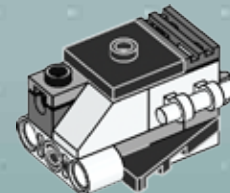

48

7

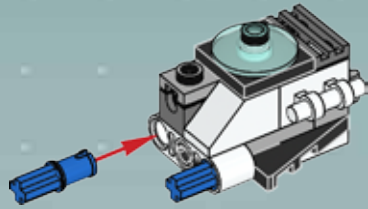

8

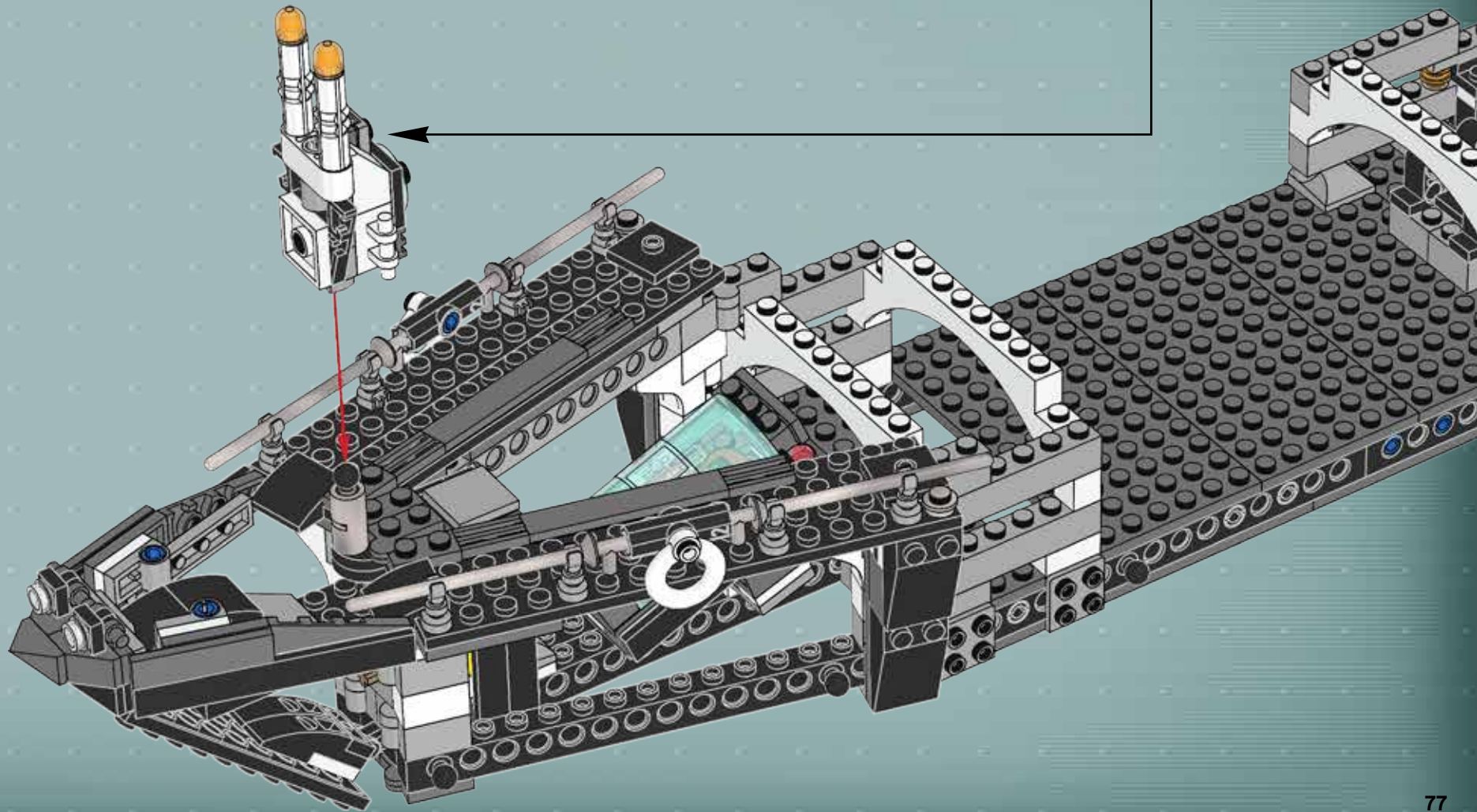
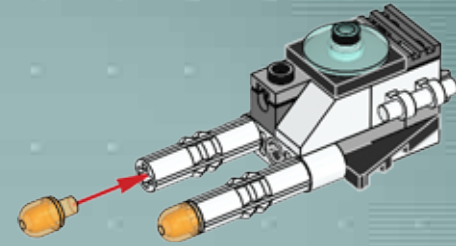

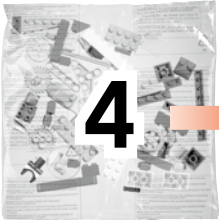

4

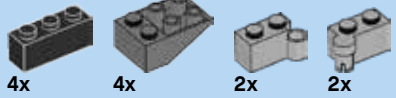
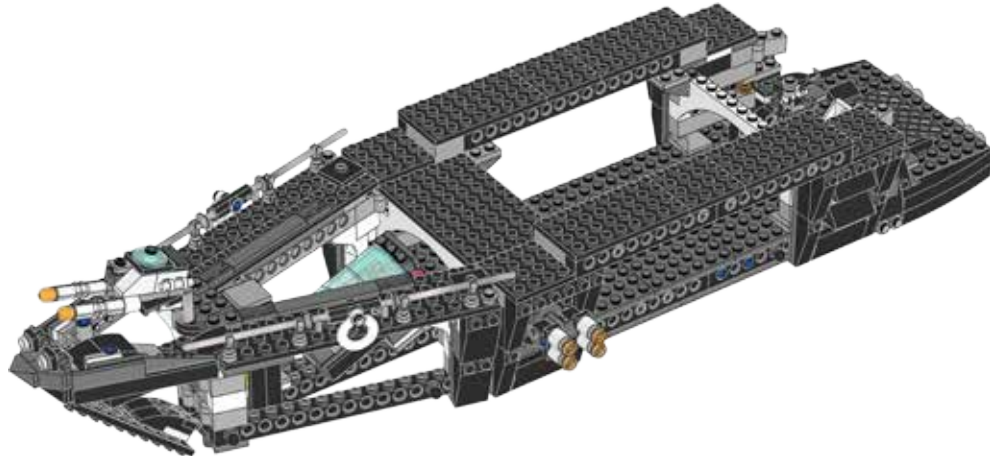

4x

4x

2x

2x

49

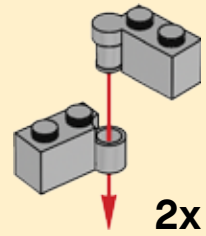

2x

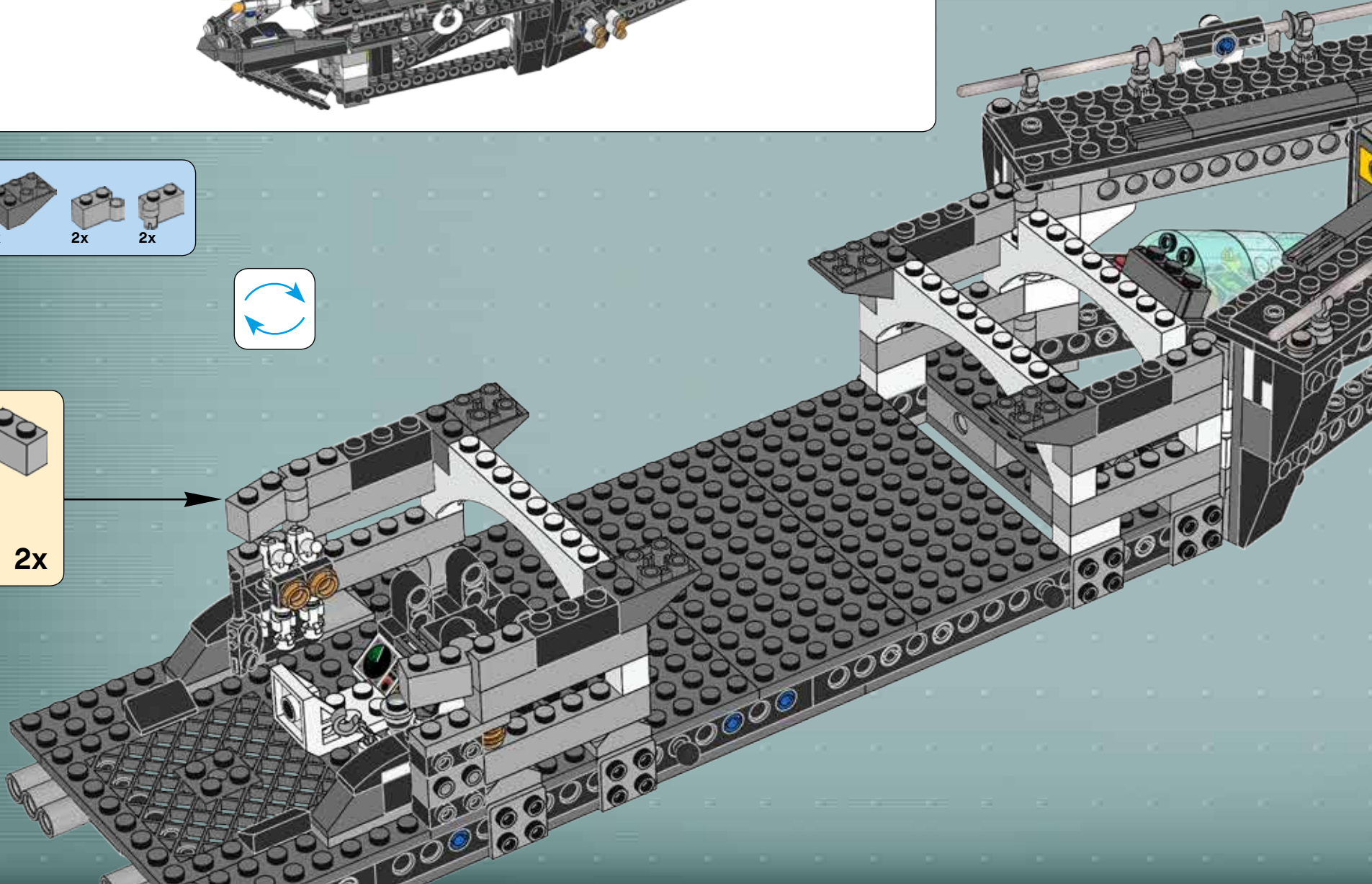



4x



8x

# 50

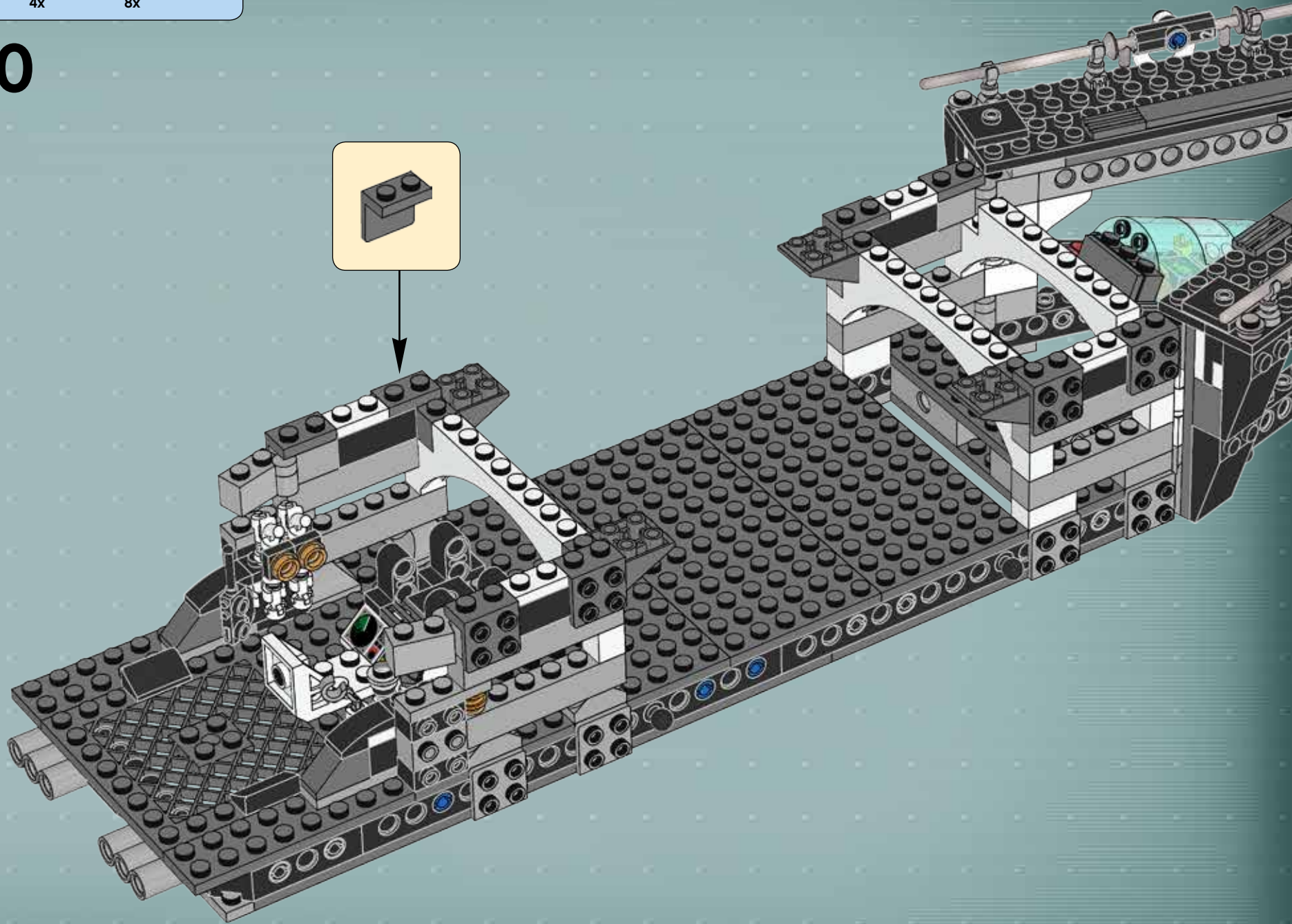
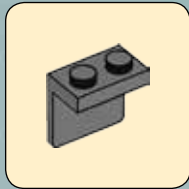



2x

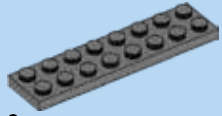

2x

1

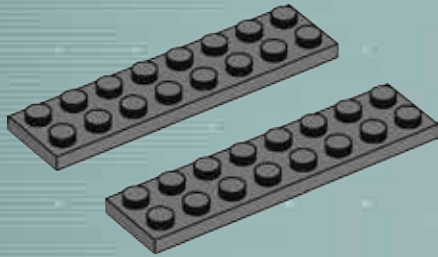

1x

2

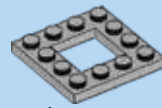
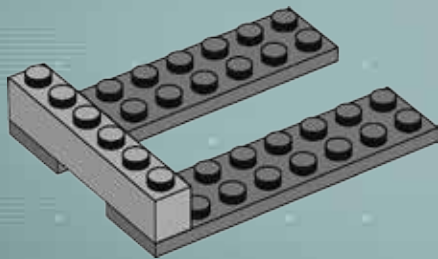

1x

3

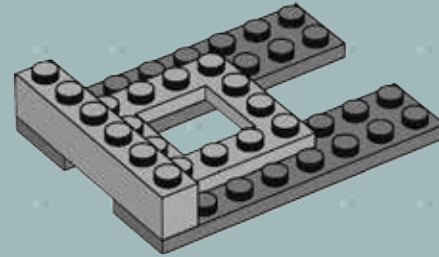

1x

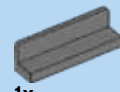

1x

4

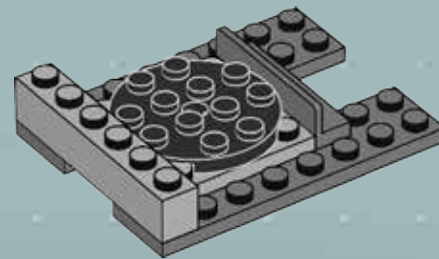





5

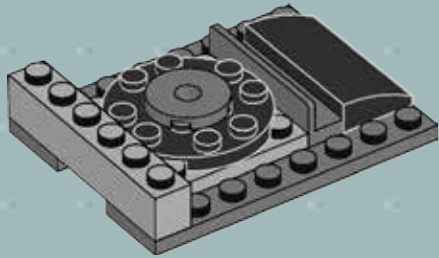

6

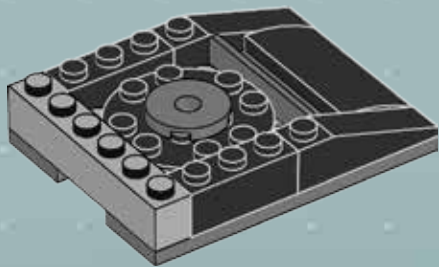

7

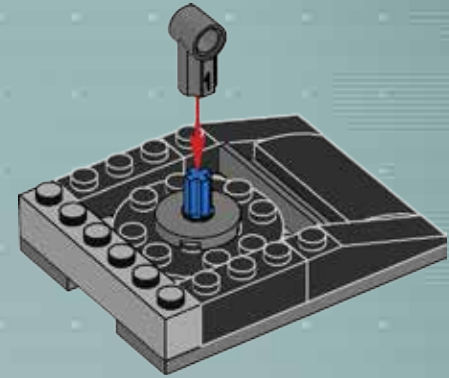

8

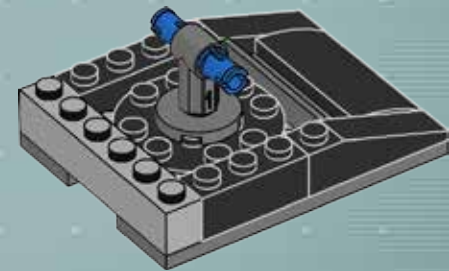

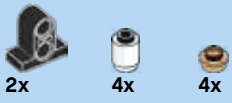

9

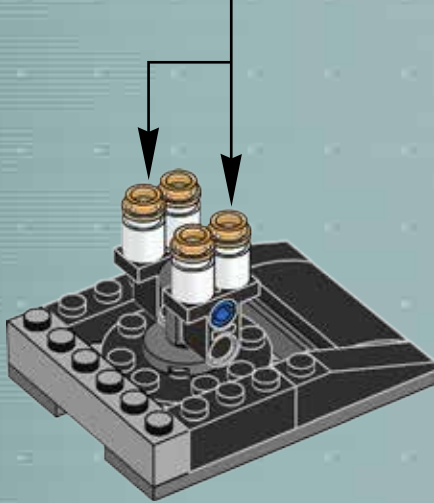
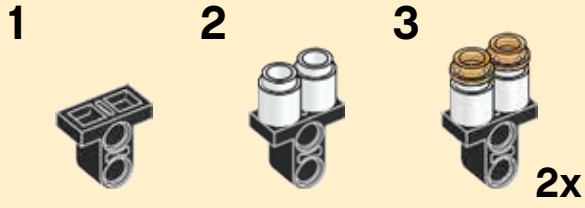

10

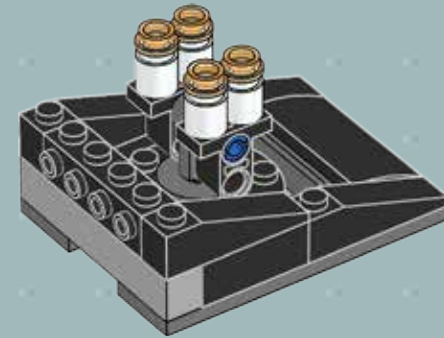

2x

51

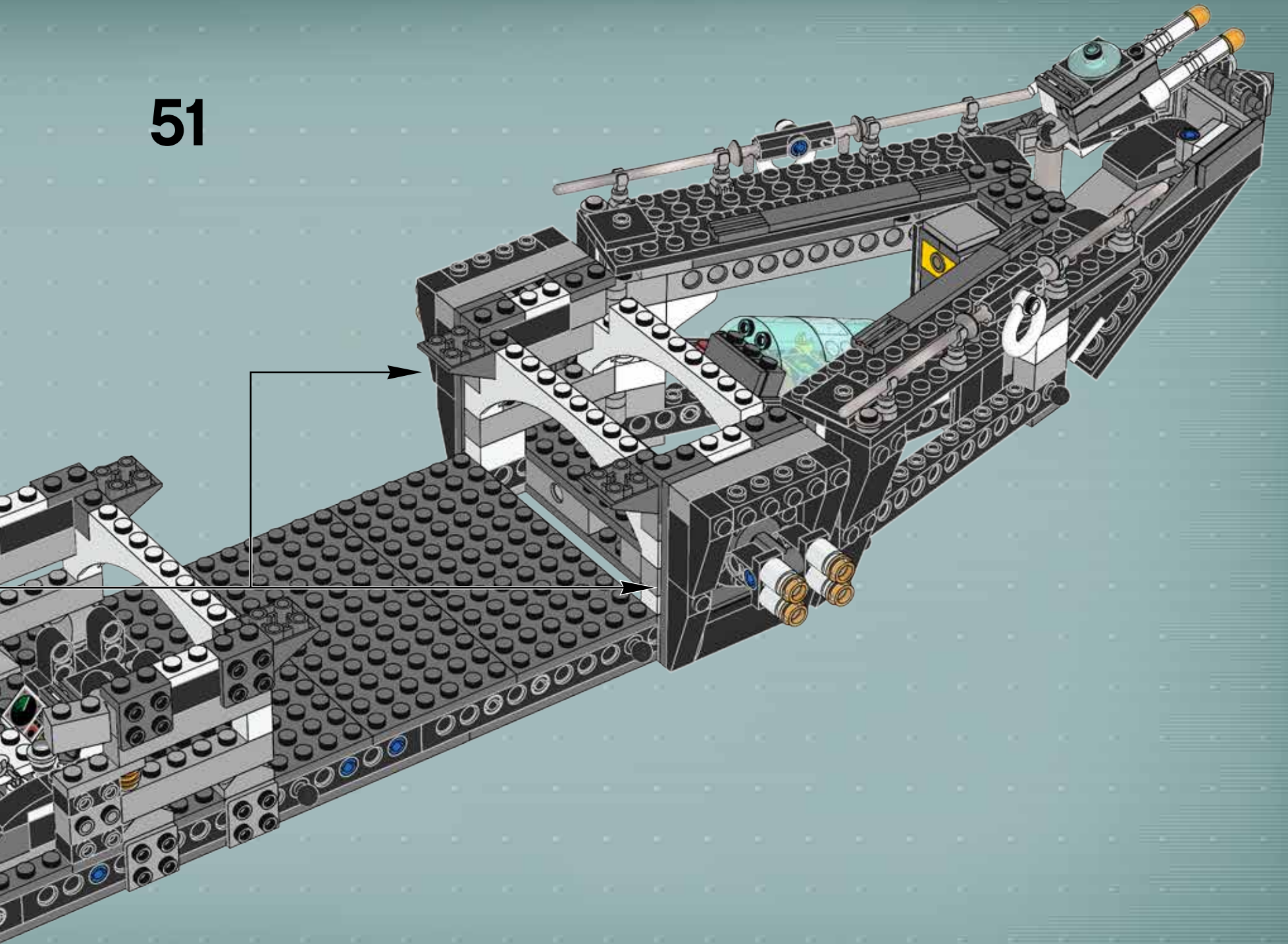

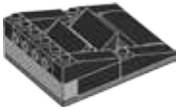

2x



1x



1



1x



2



4x

3

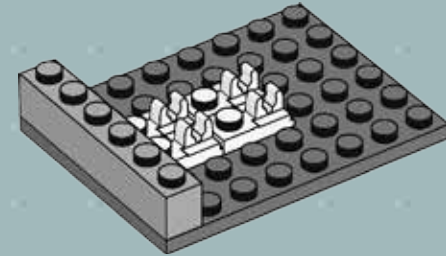

2x

4

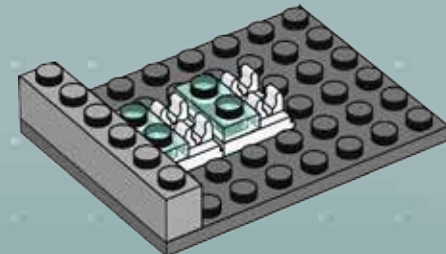

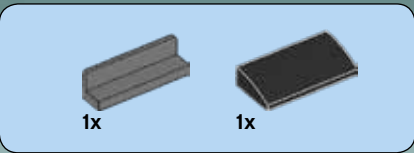

5

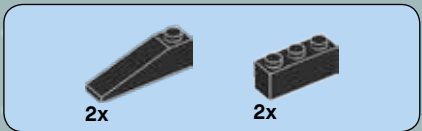
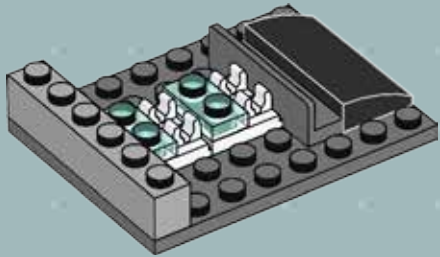

6

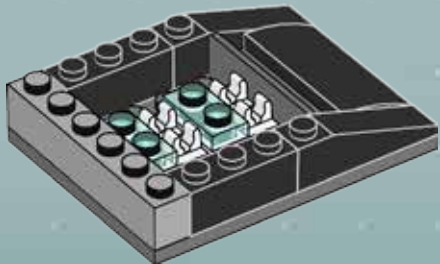

7

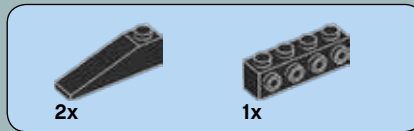
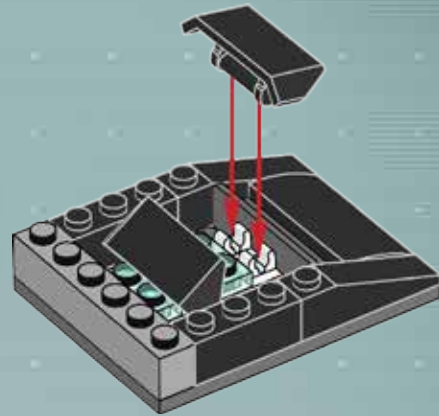

8

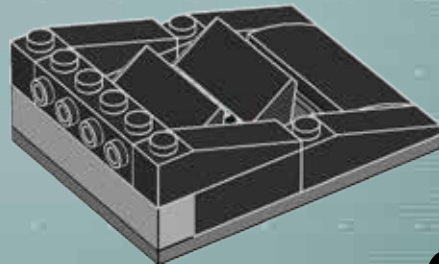

2x

52

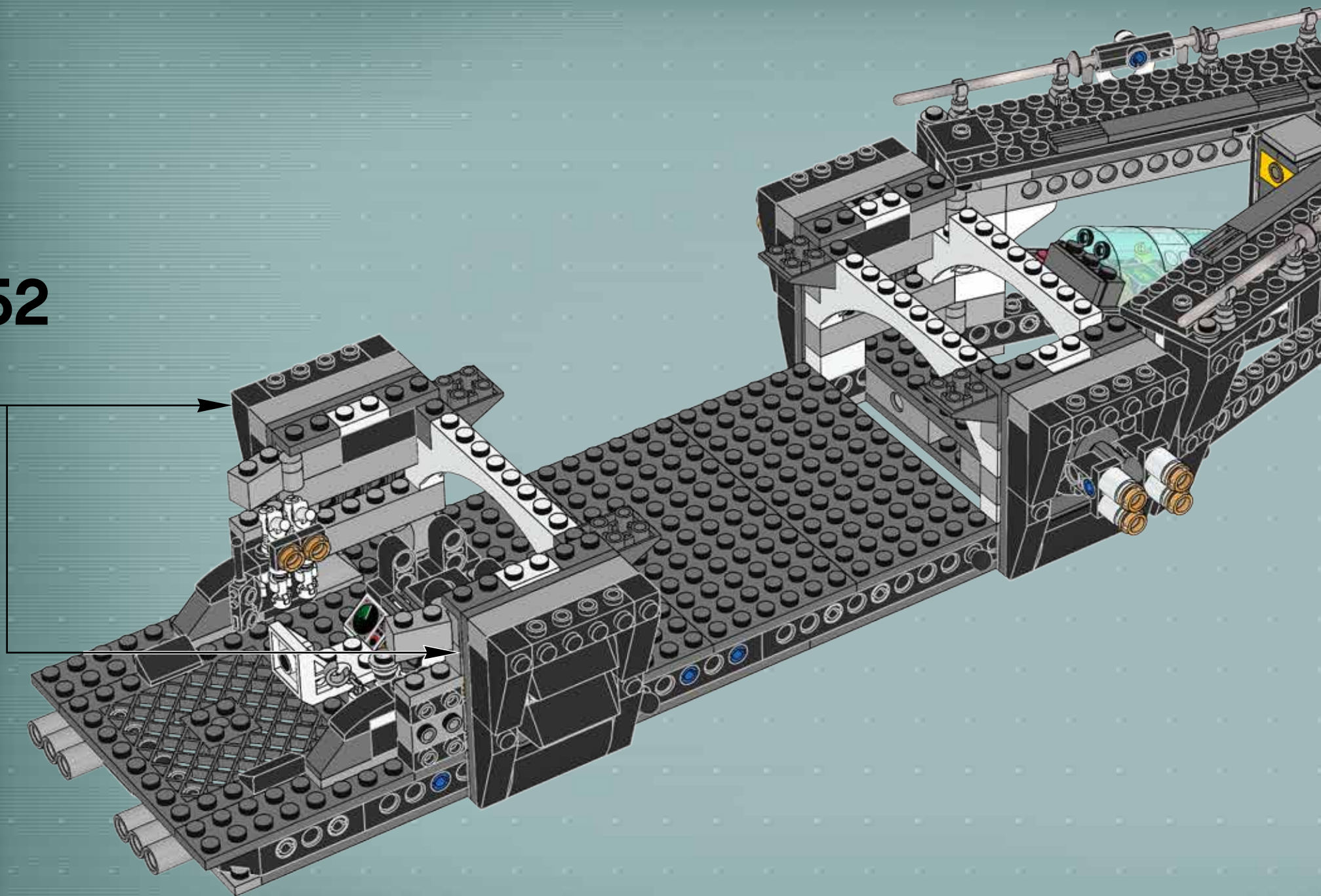

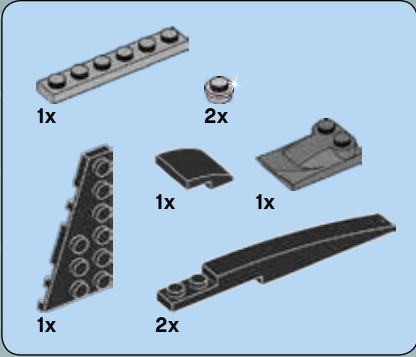

**53**

**1**



**2**

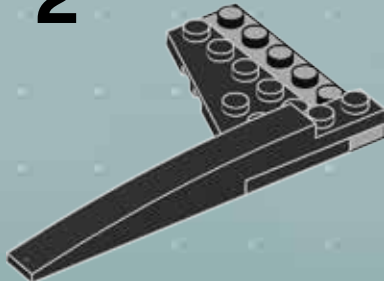

**3**

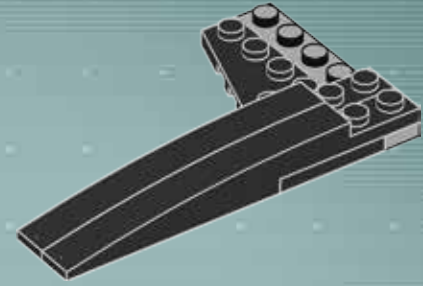

**4**

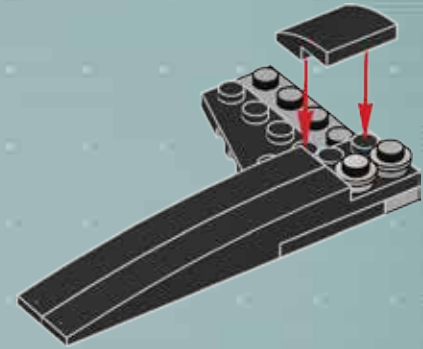

**5**

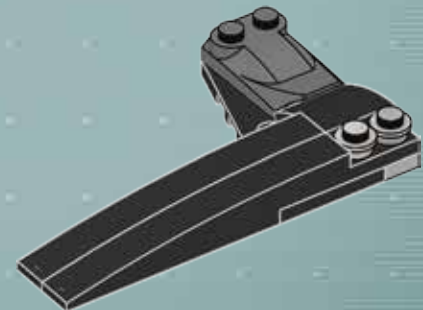

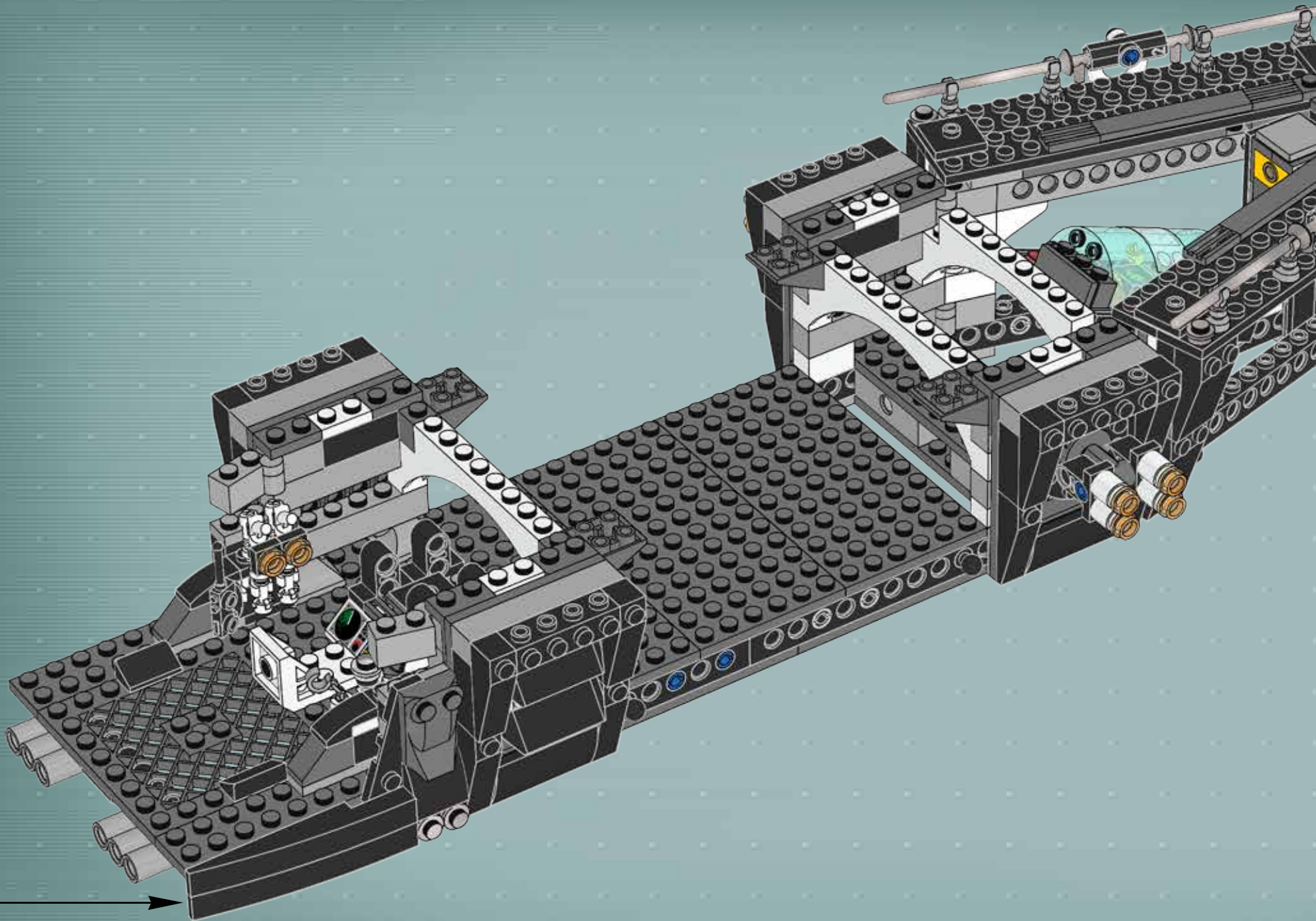



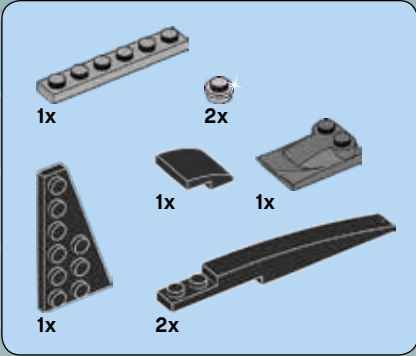

54

1

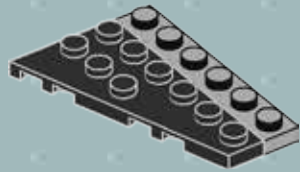

2

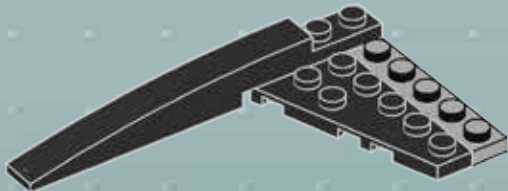

3

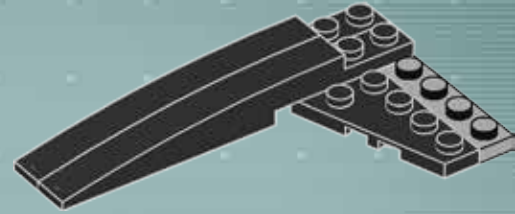

4

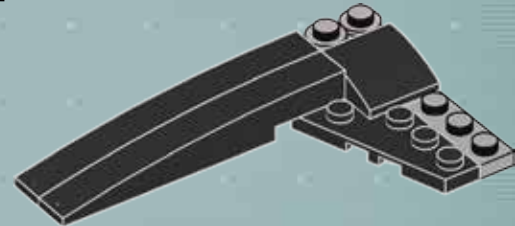

5

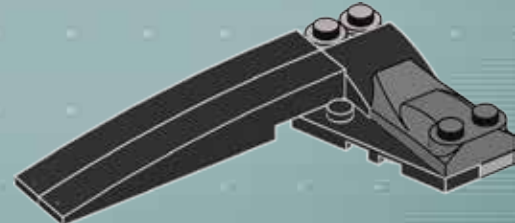

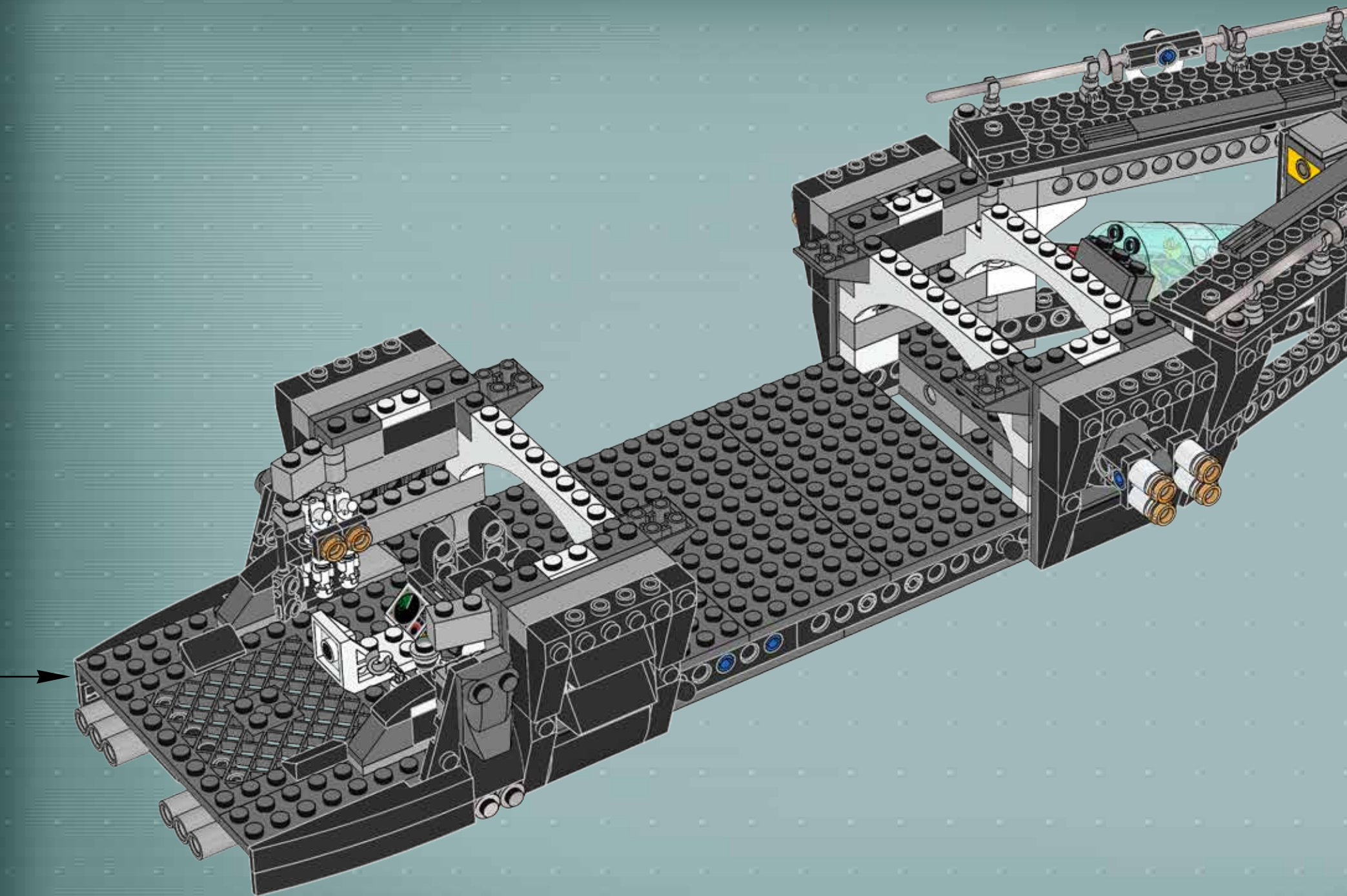

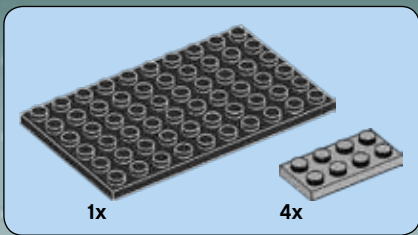

55

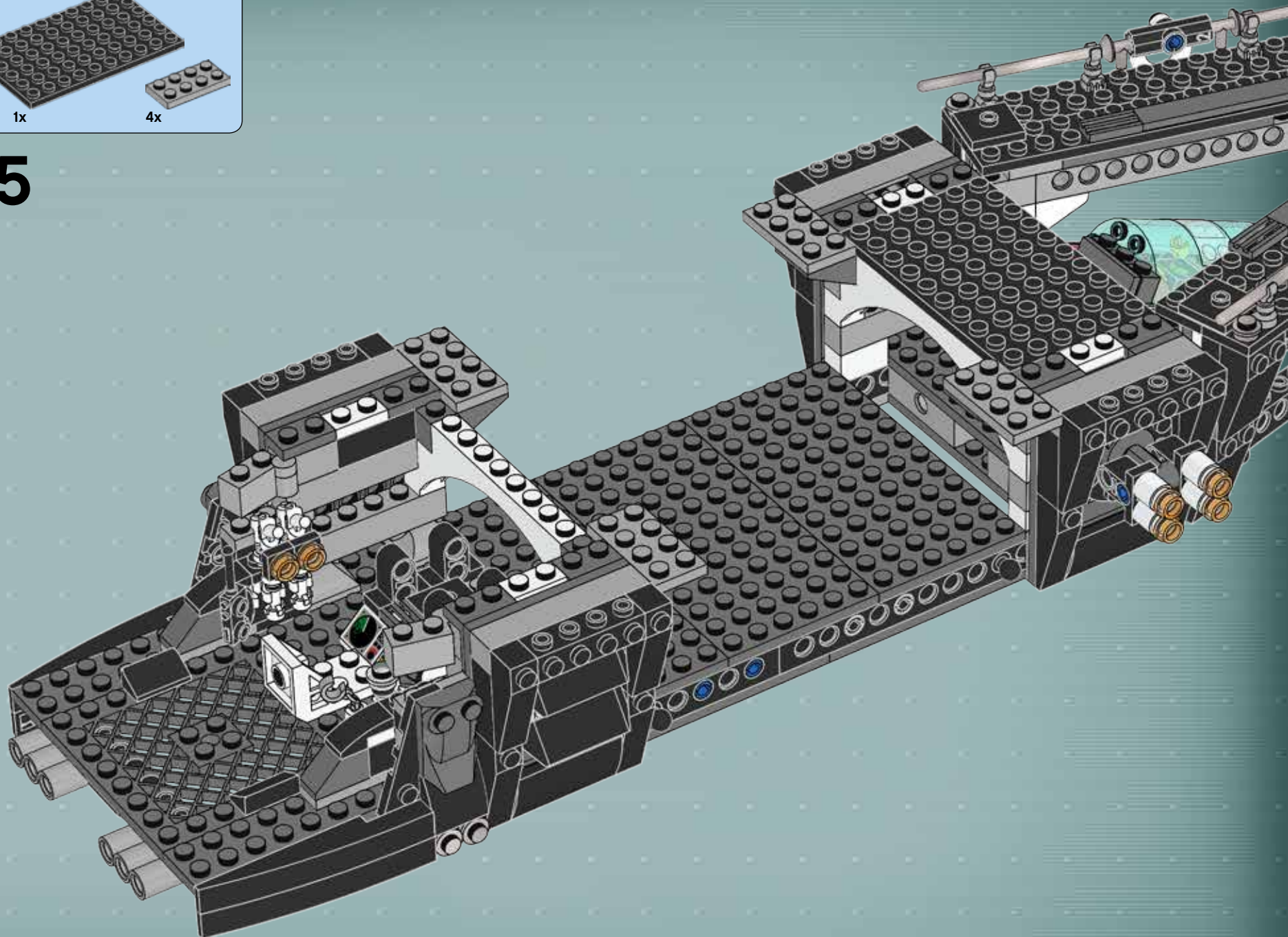

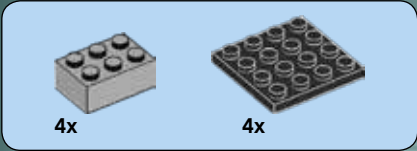

56

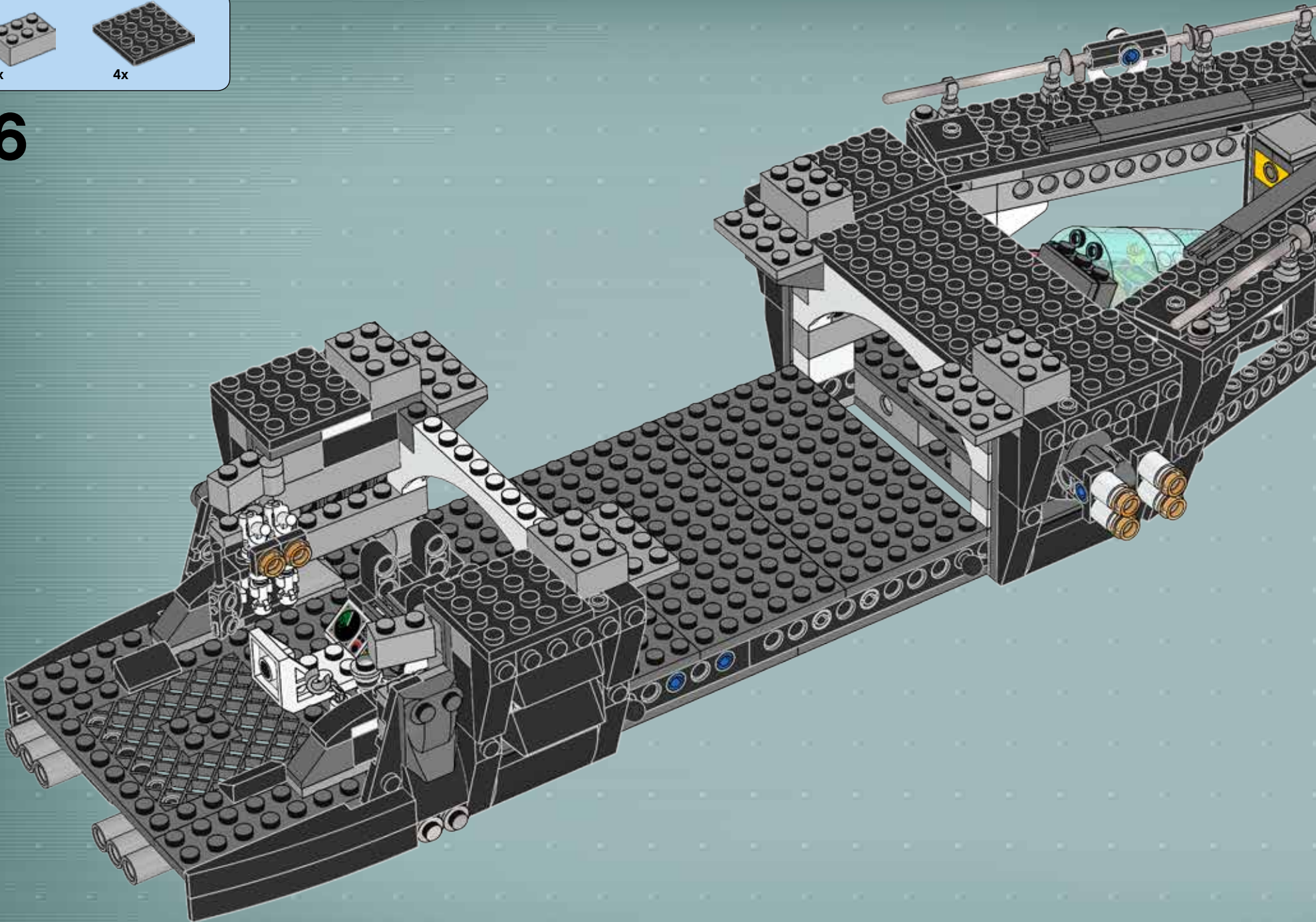

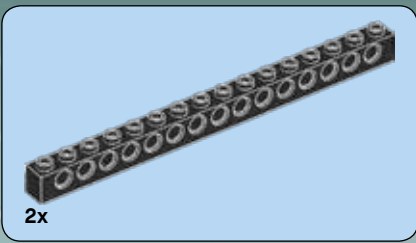

57

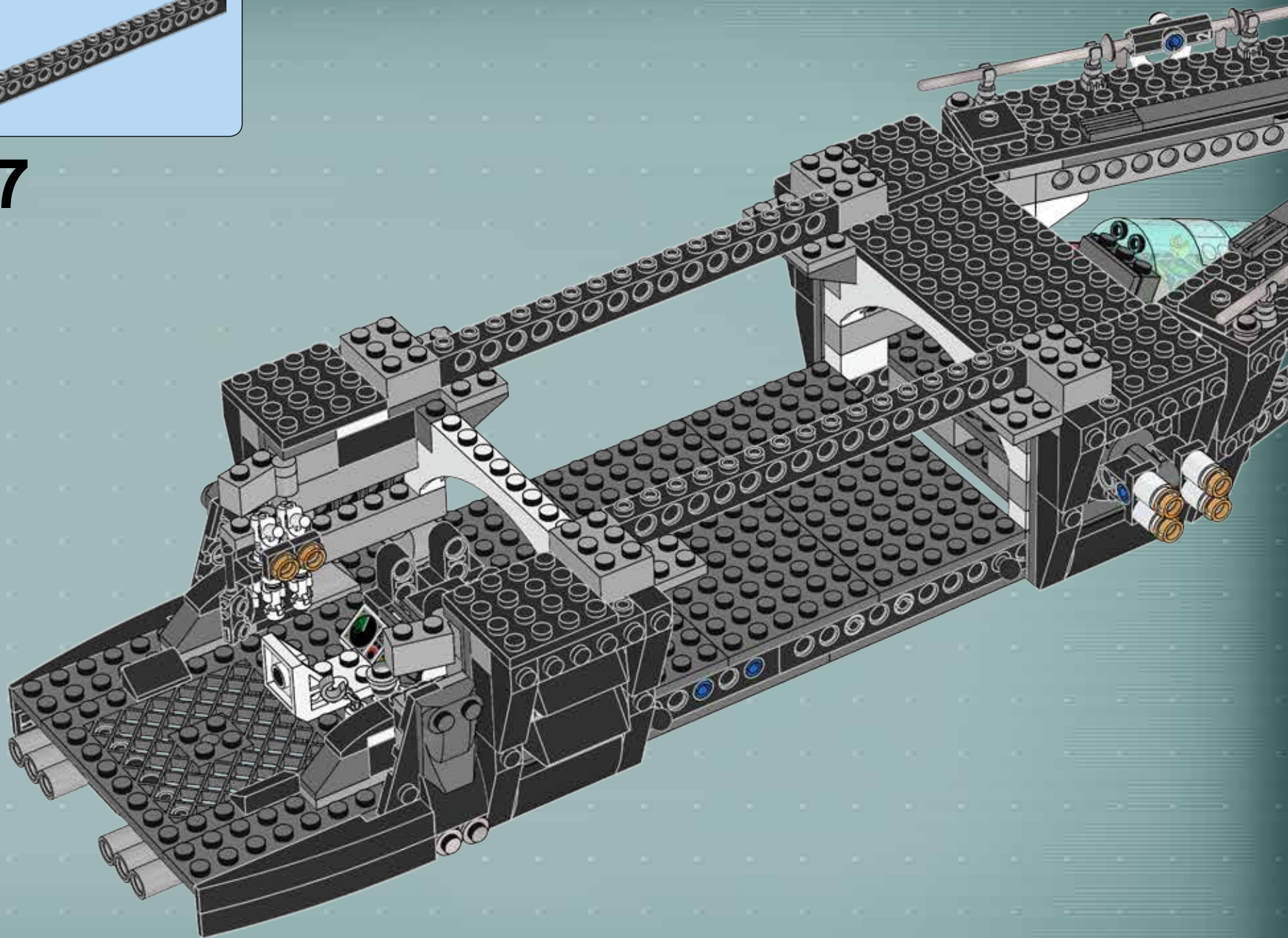

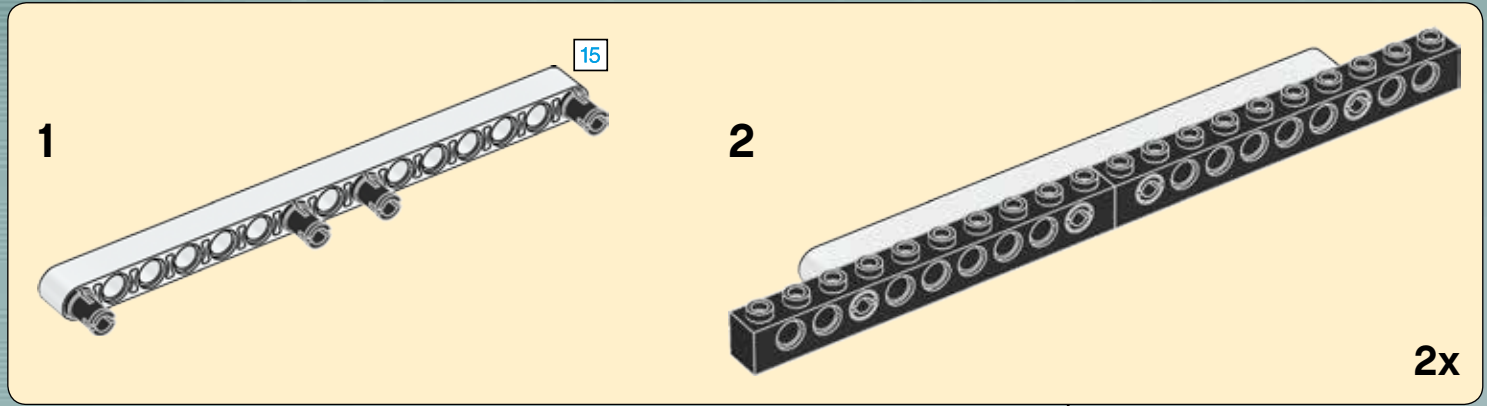
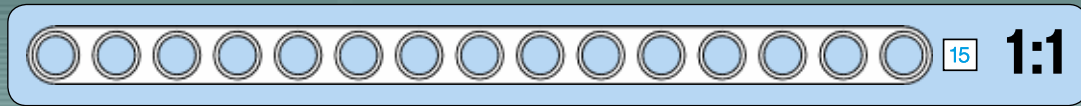
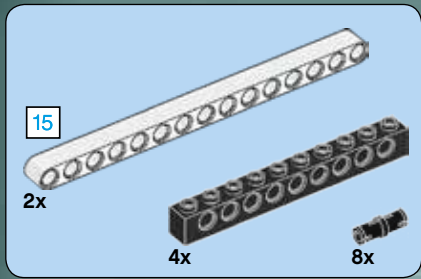

58

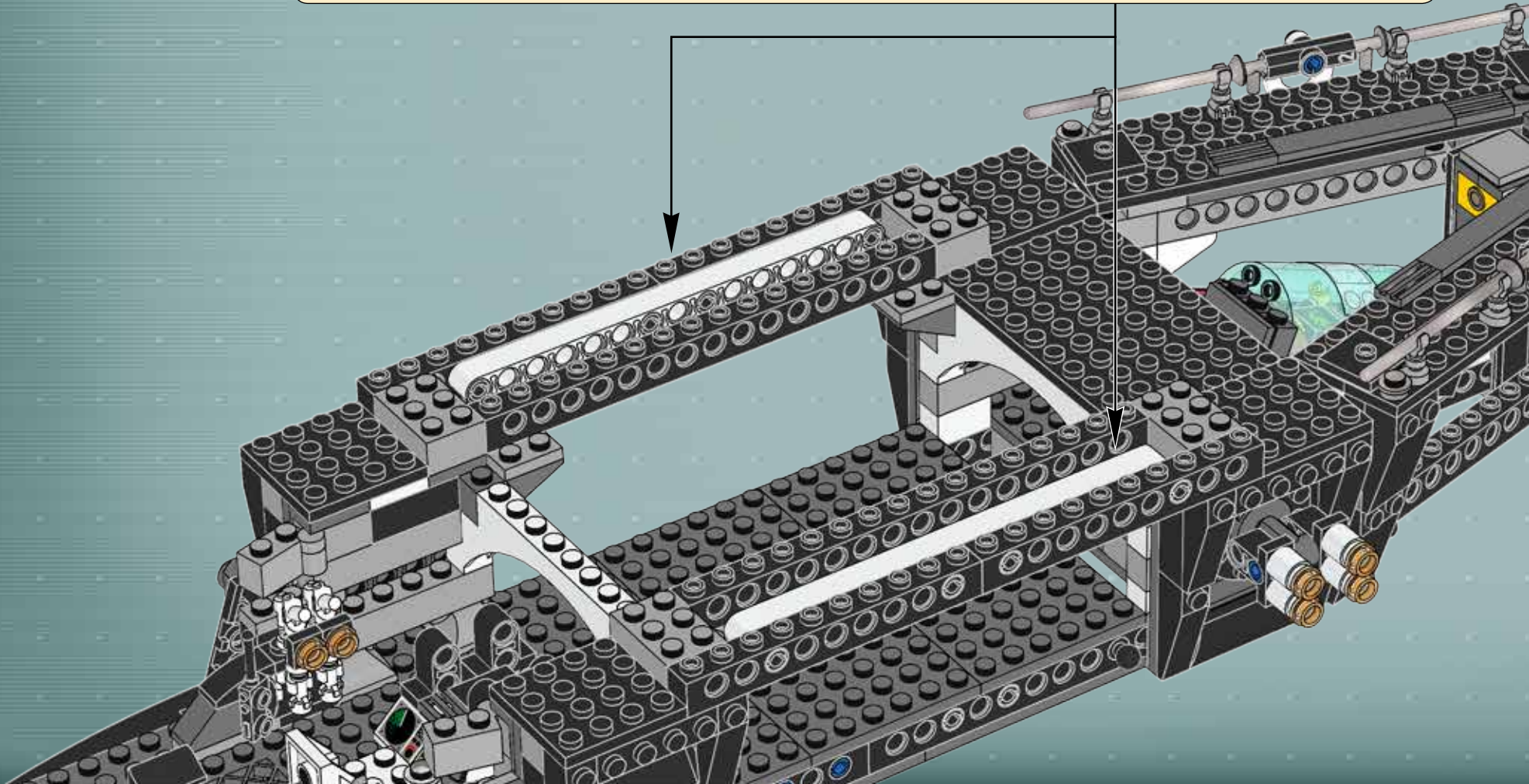

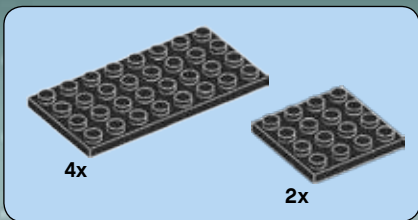

59

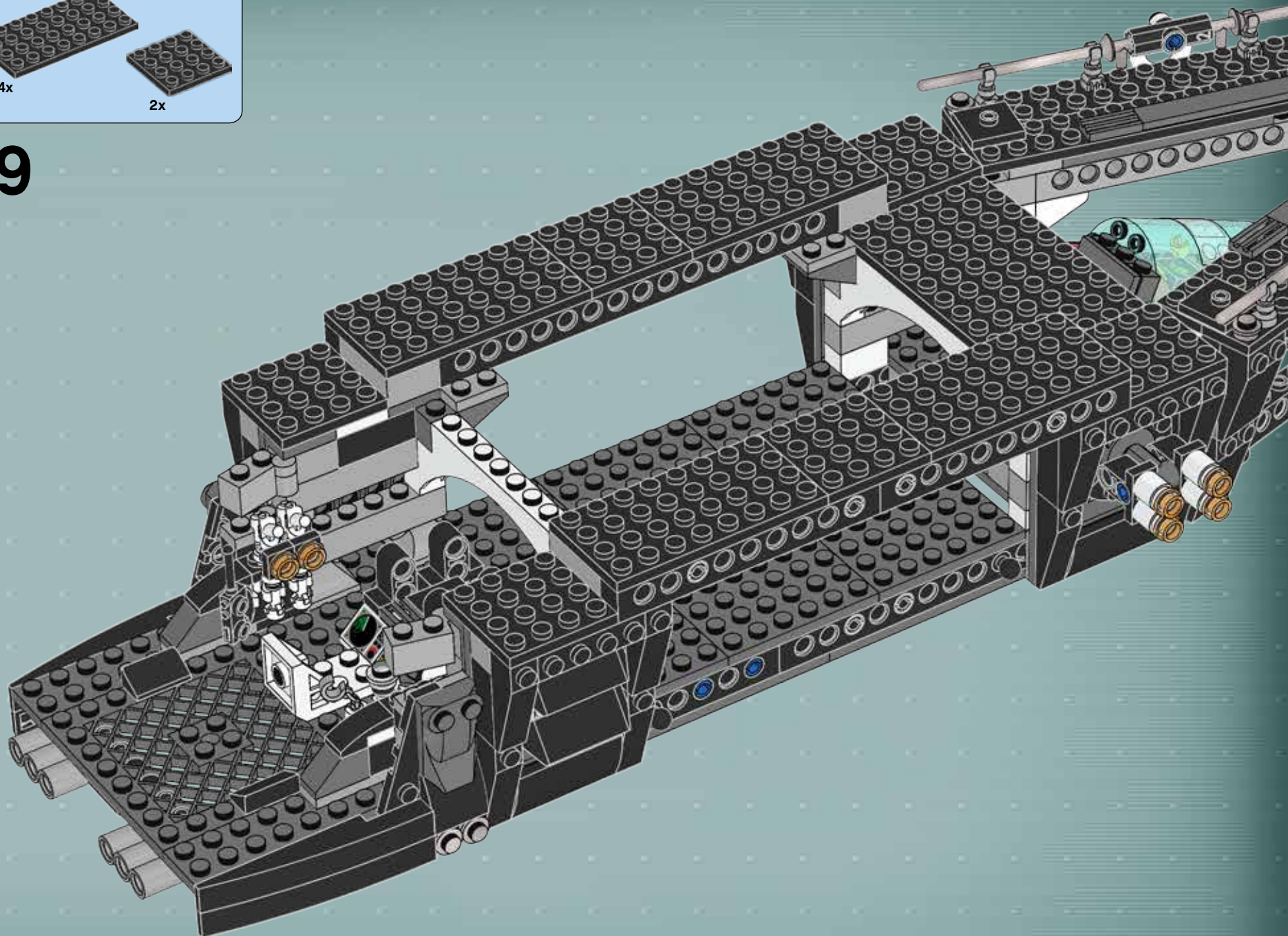

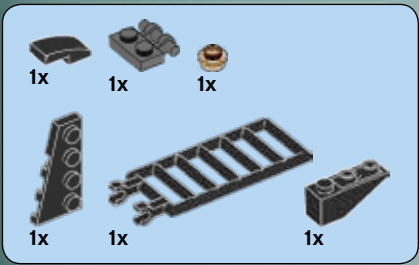
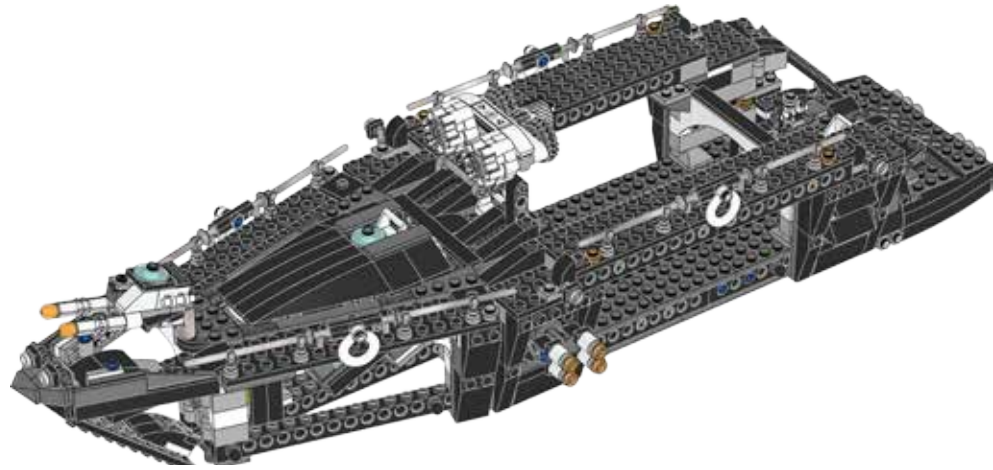

60

1

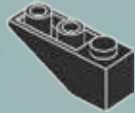

2



3

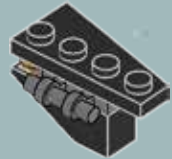

4

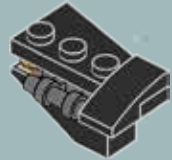

5

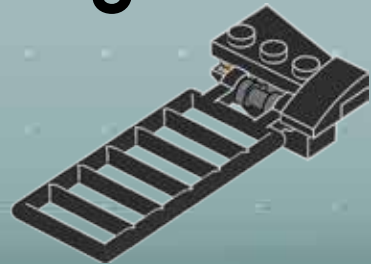



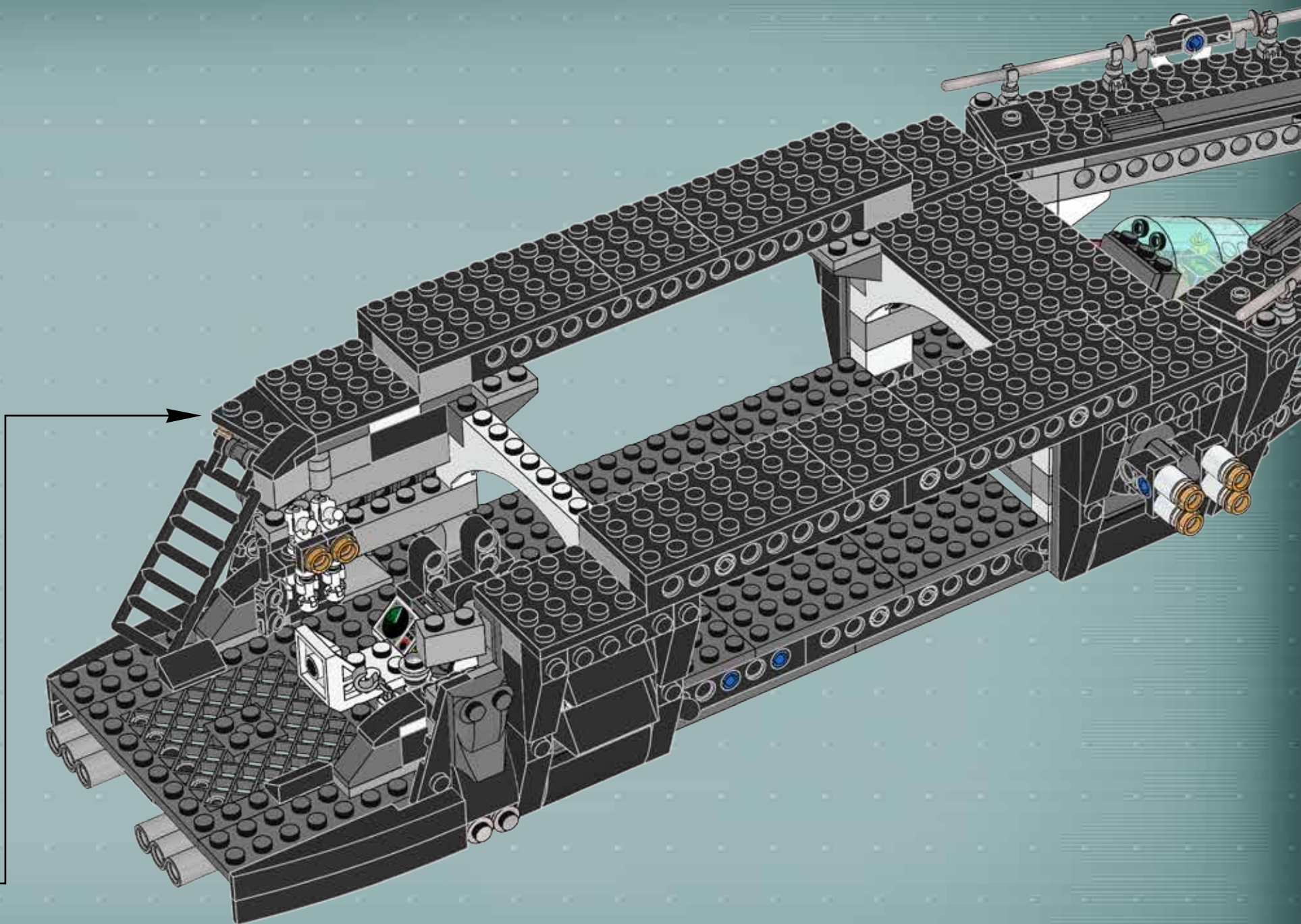

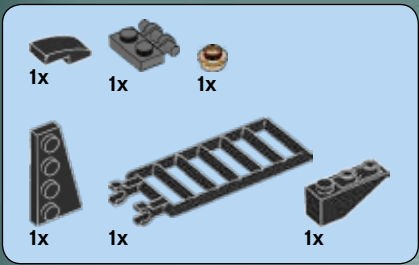

# 61

1



2



3



4



5

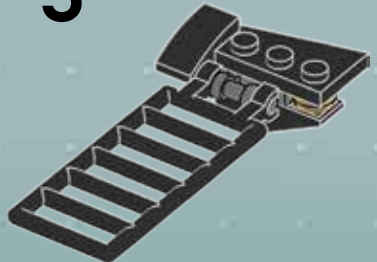

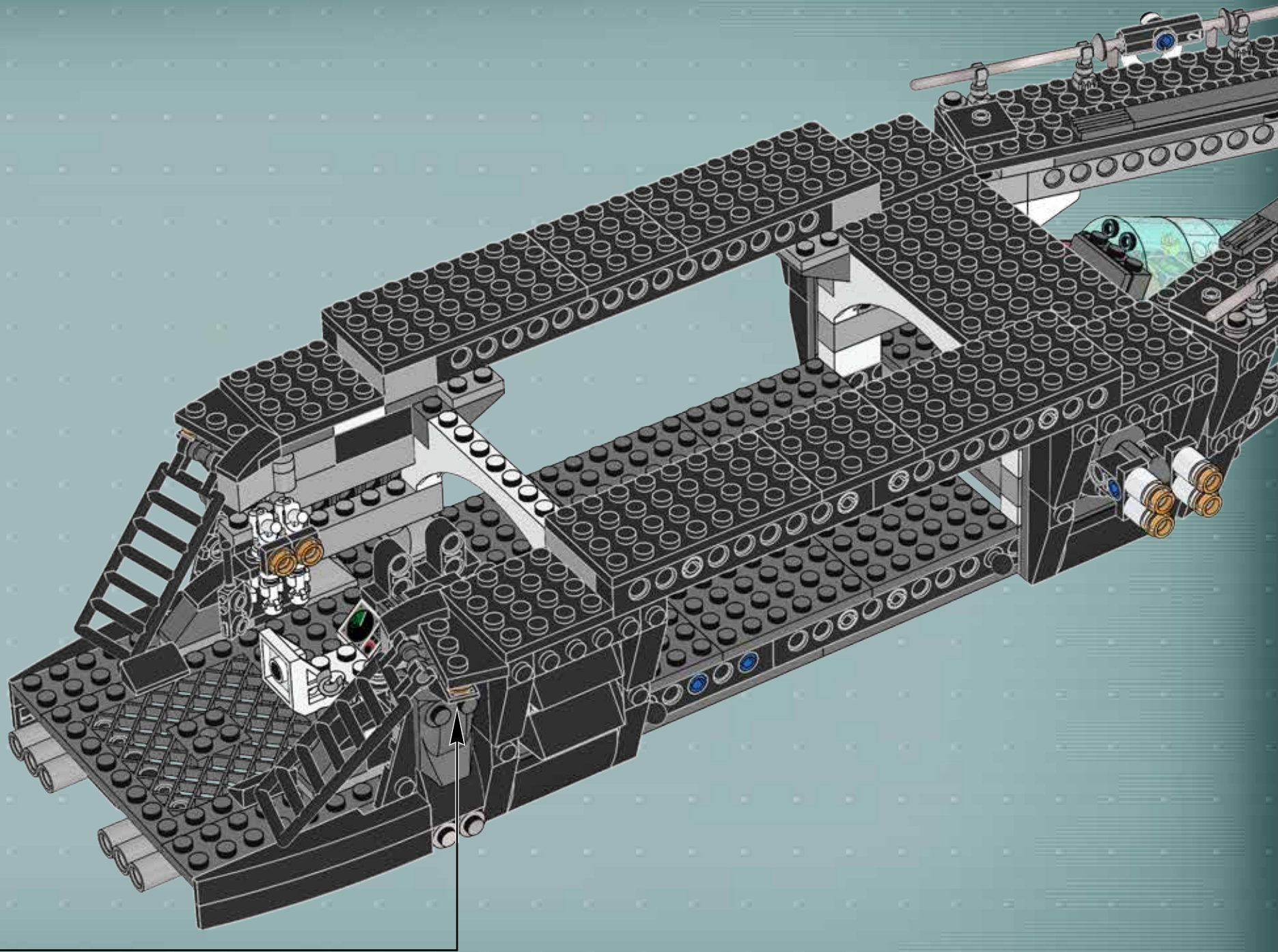



# 62

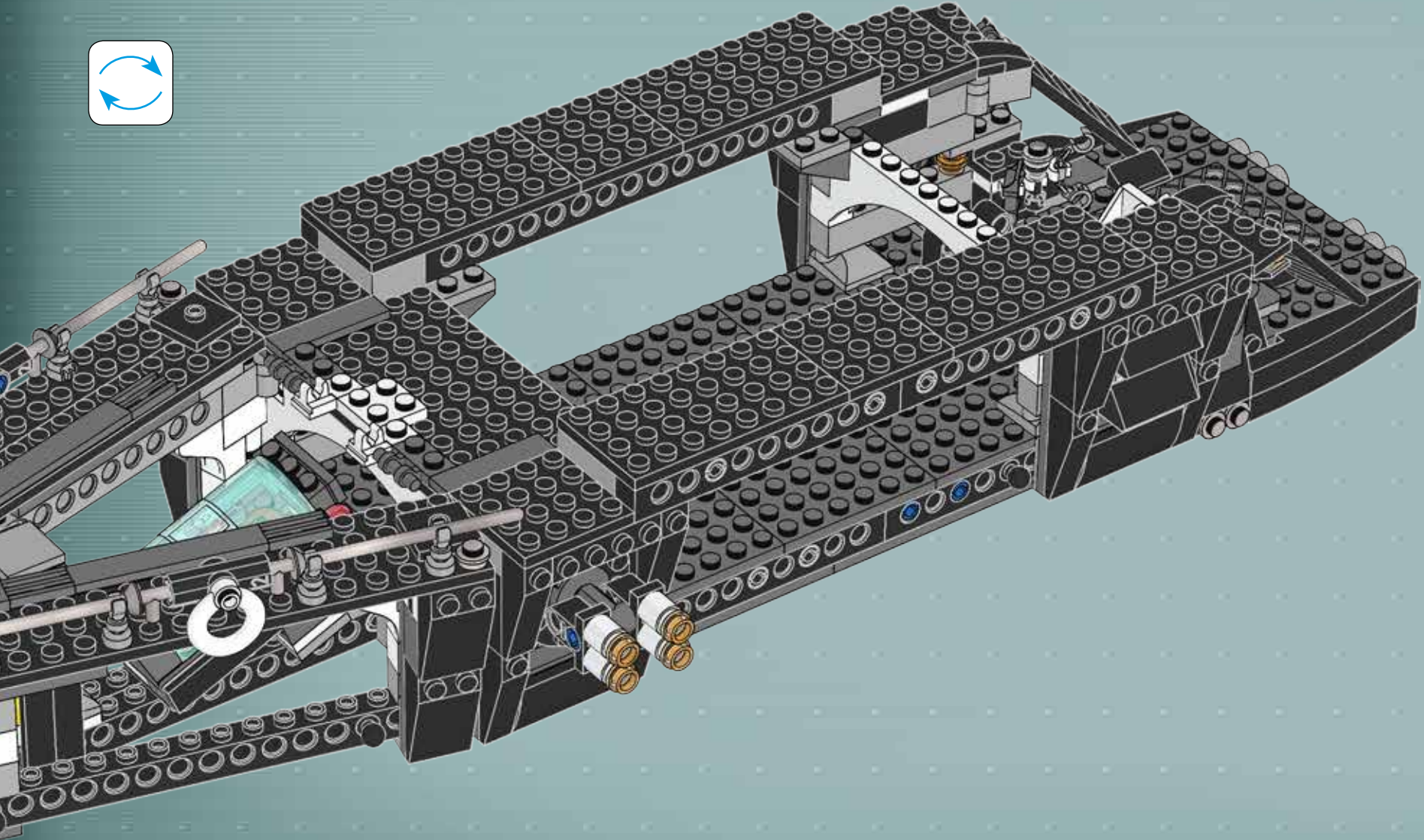

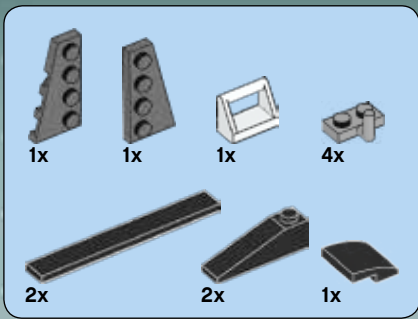

63

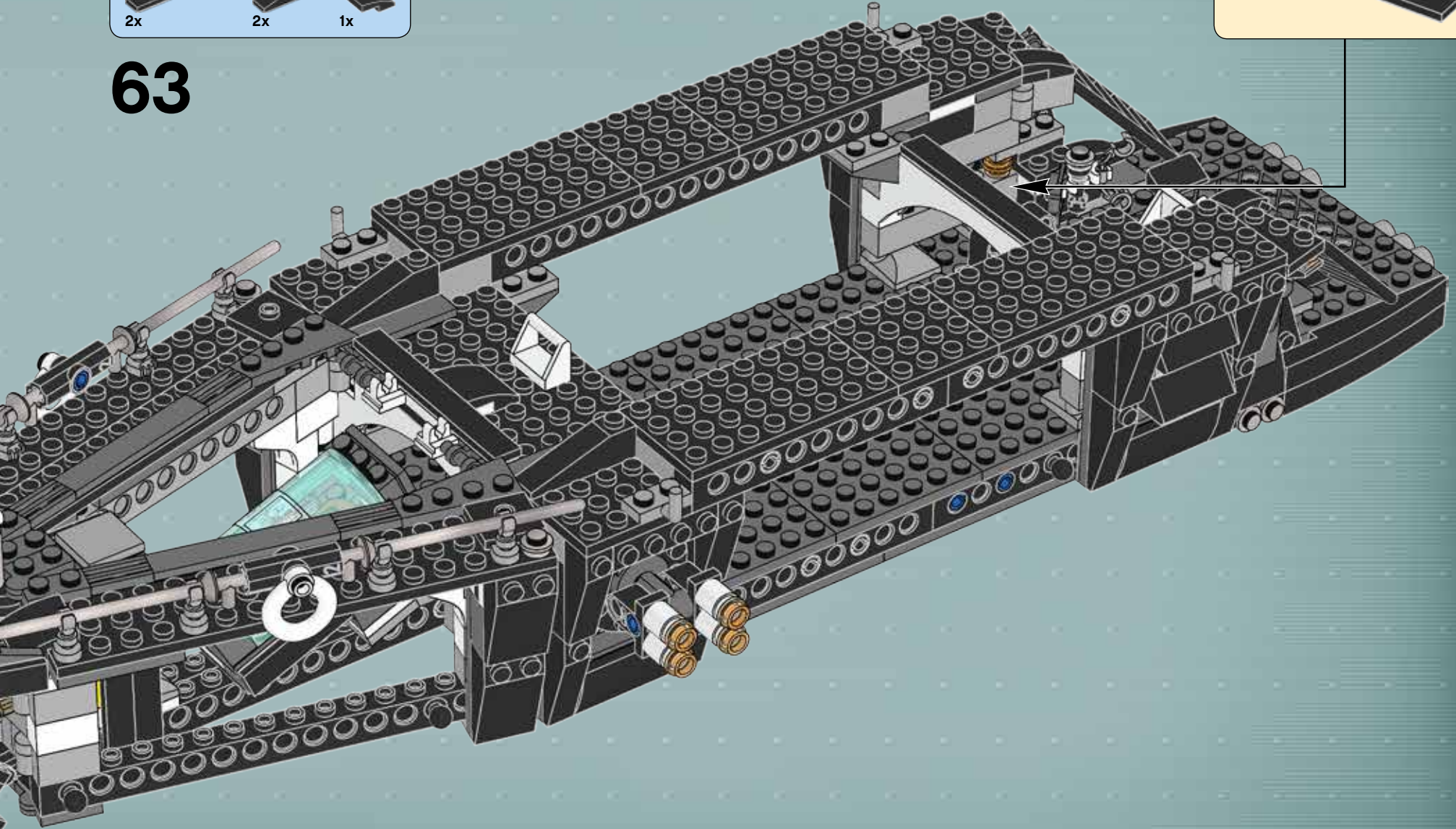

4x 4x 8x 4x 4x

64

4x

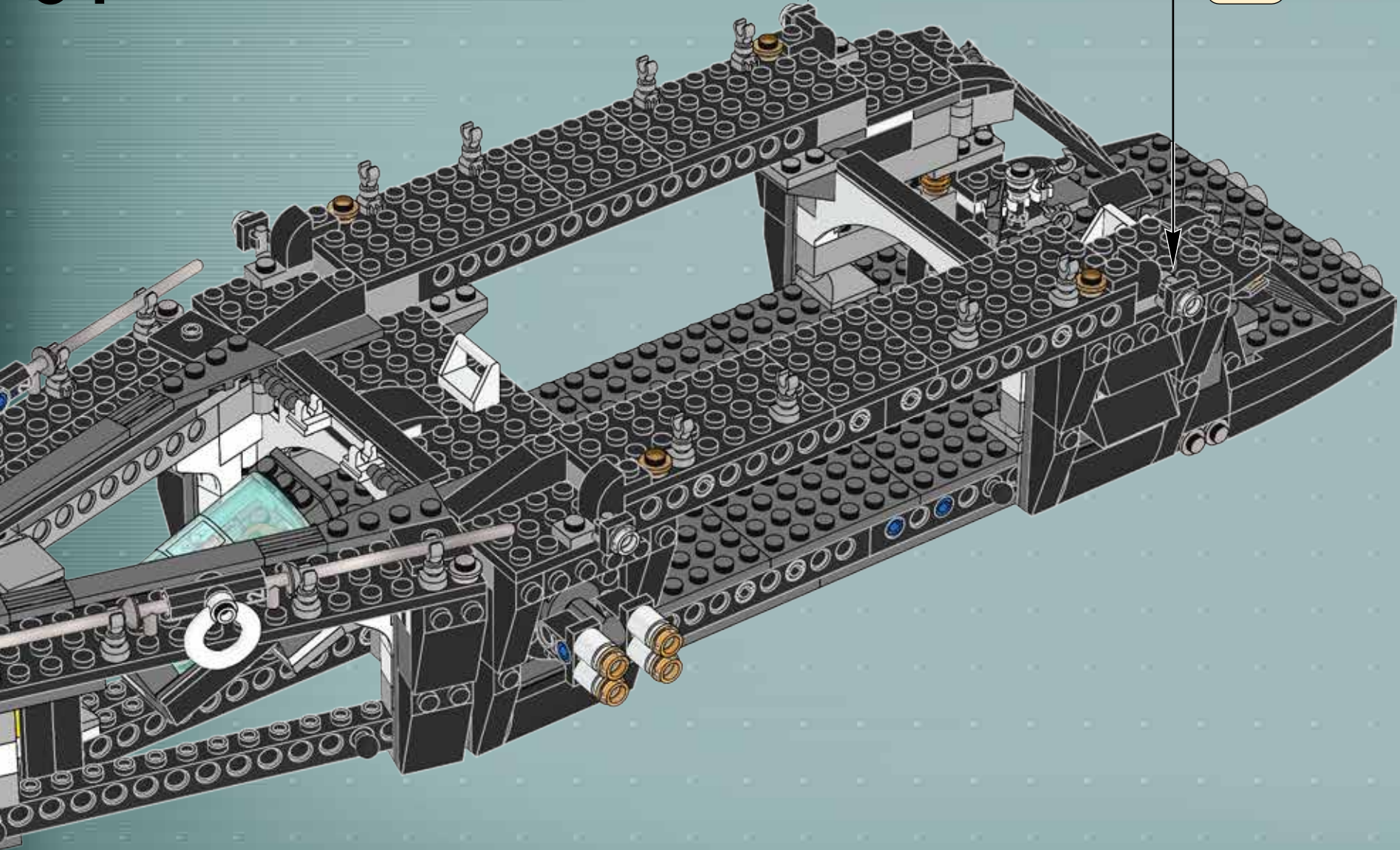

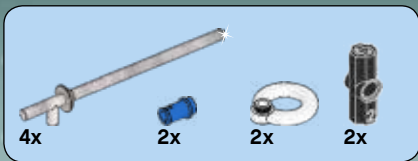

65

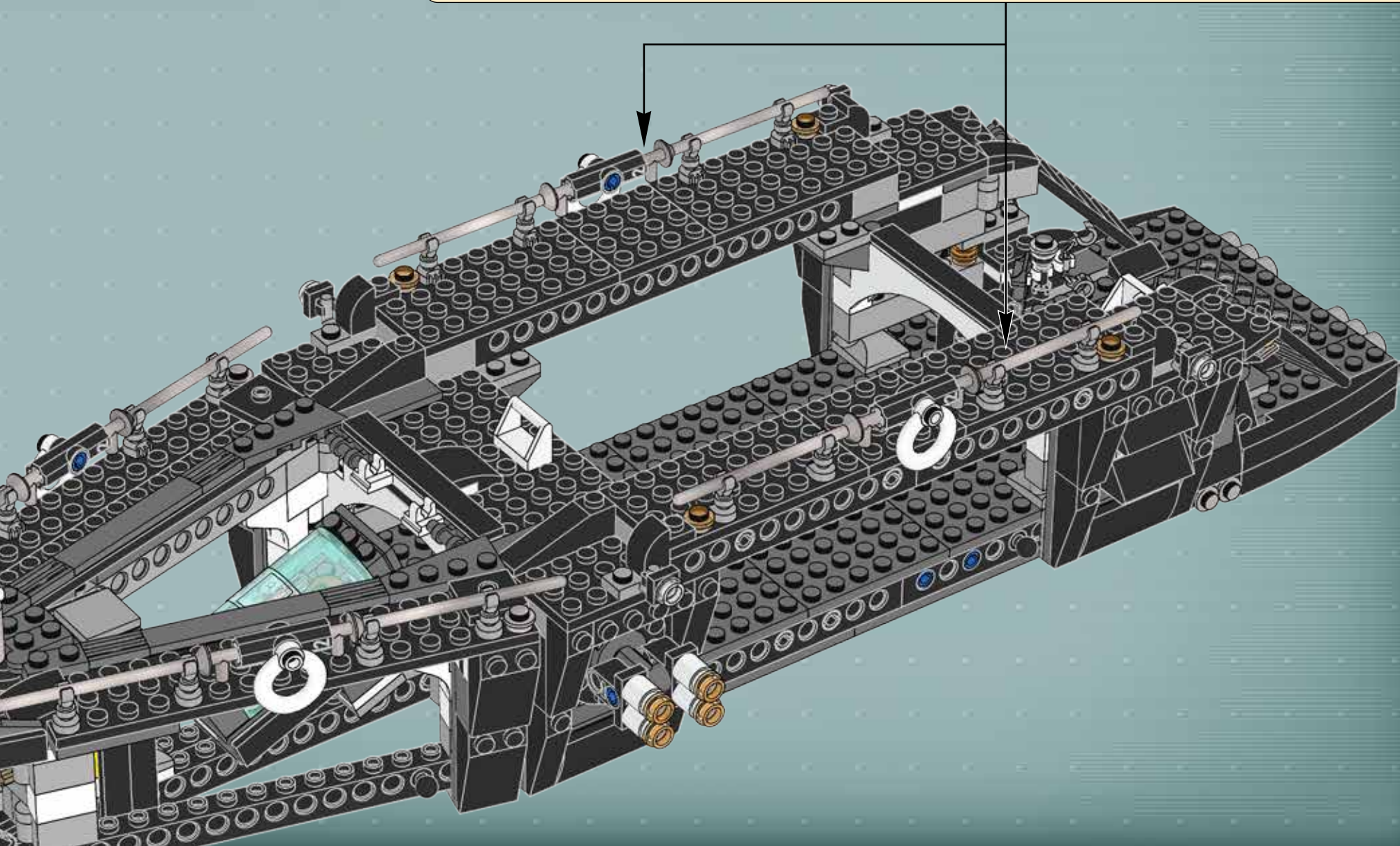
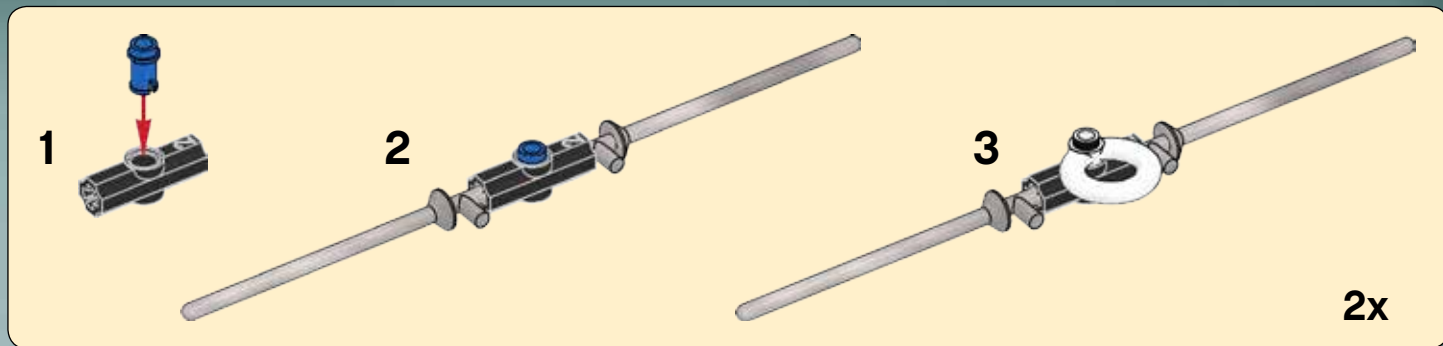

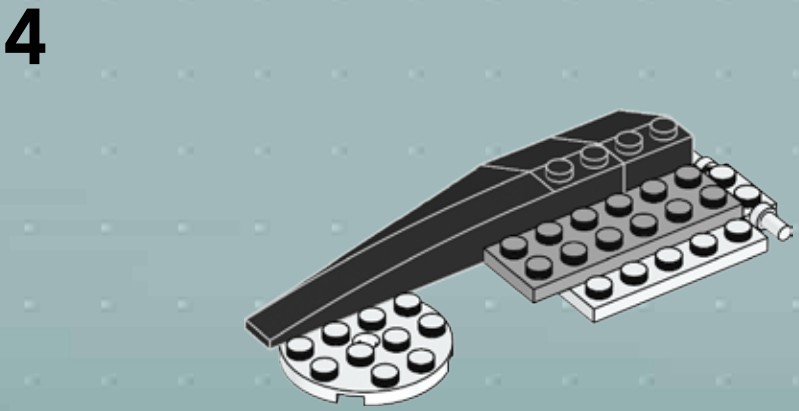
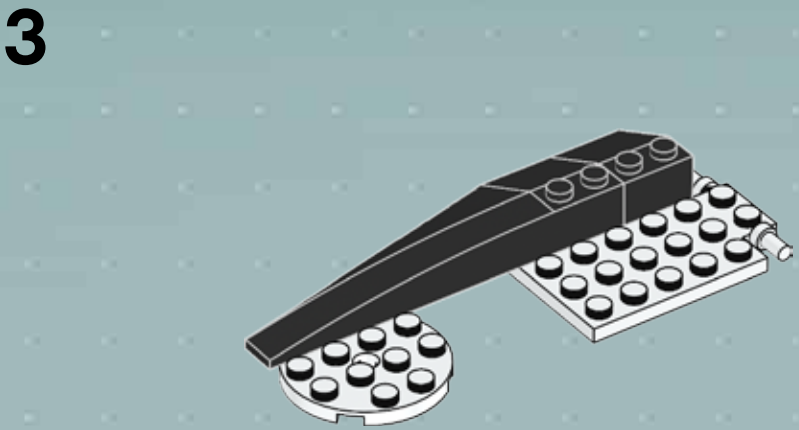
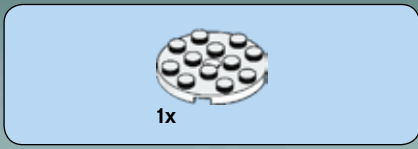
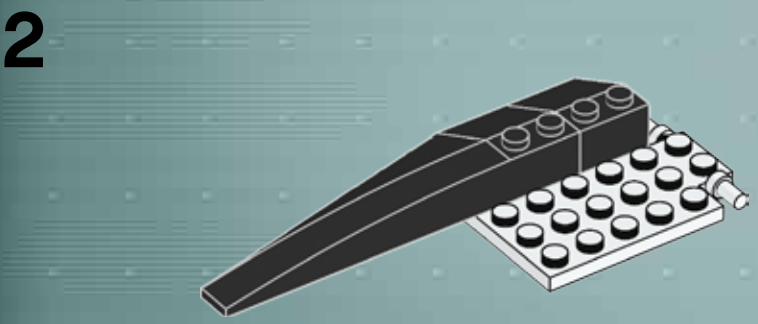
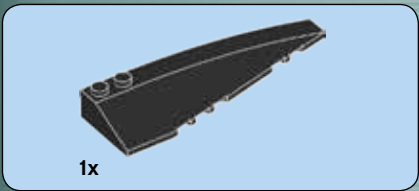
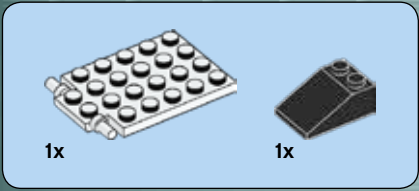



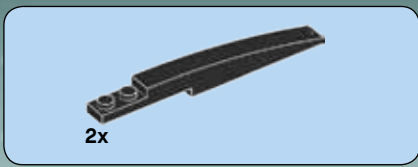

5

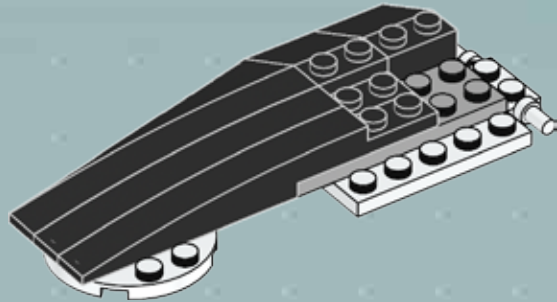

6

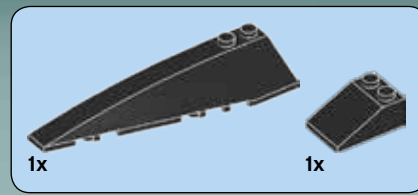
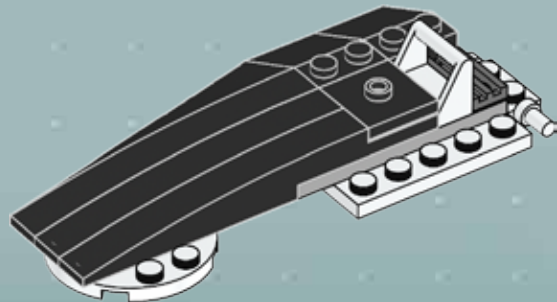

7

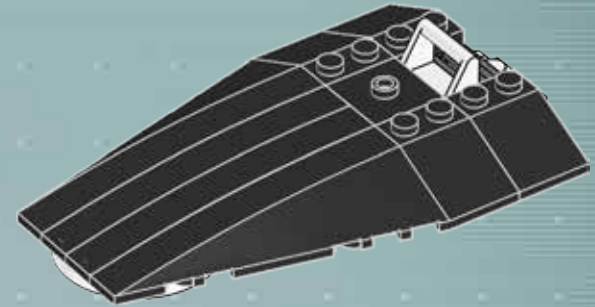

8

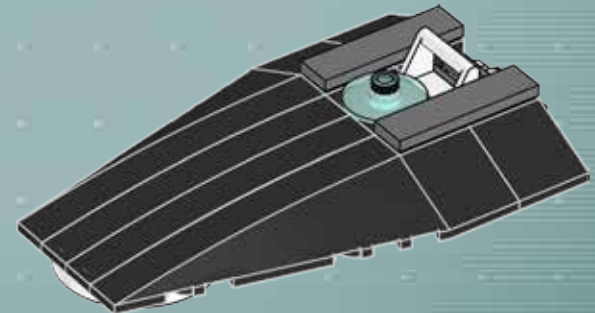

66

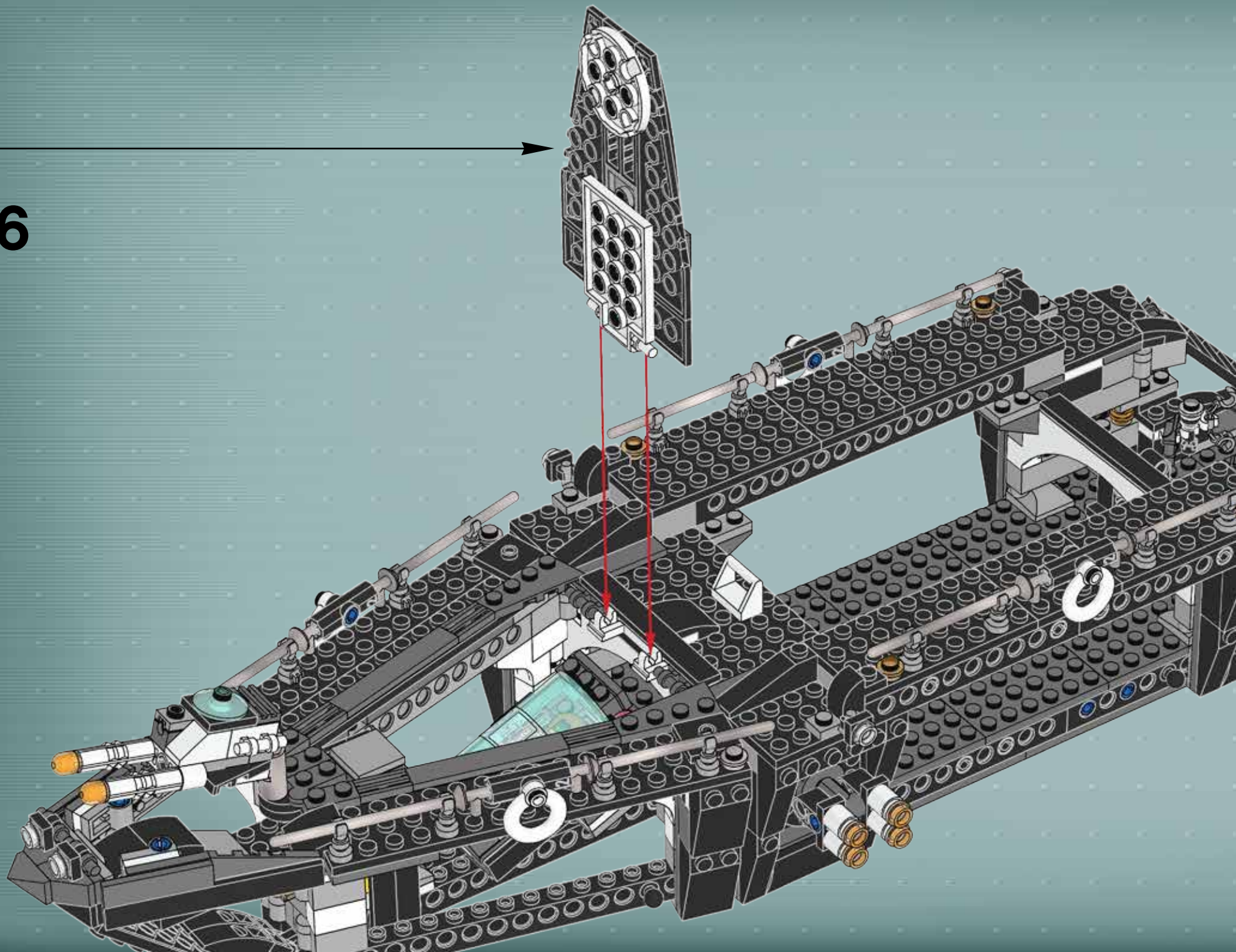

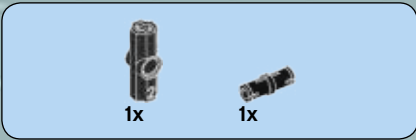

1

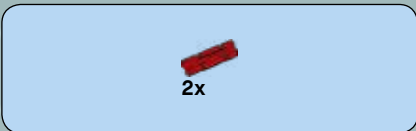

2

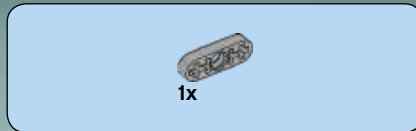

3

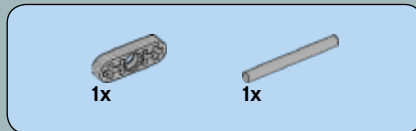
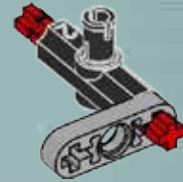

4

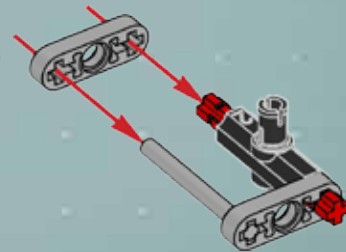

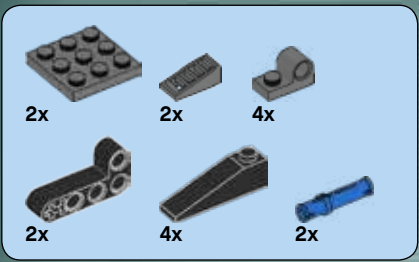

# 5

**1**

**2**

**3**

**4**

**5**

**2x**

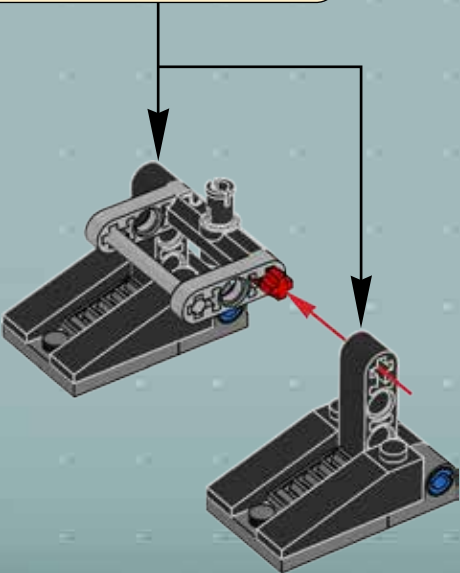

67

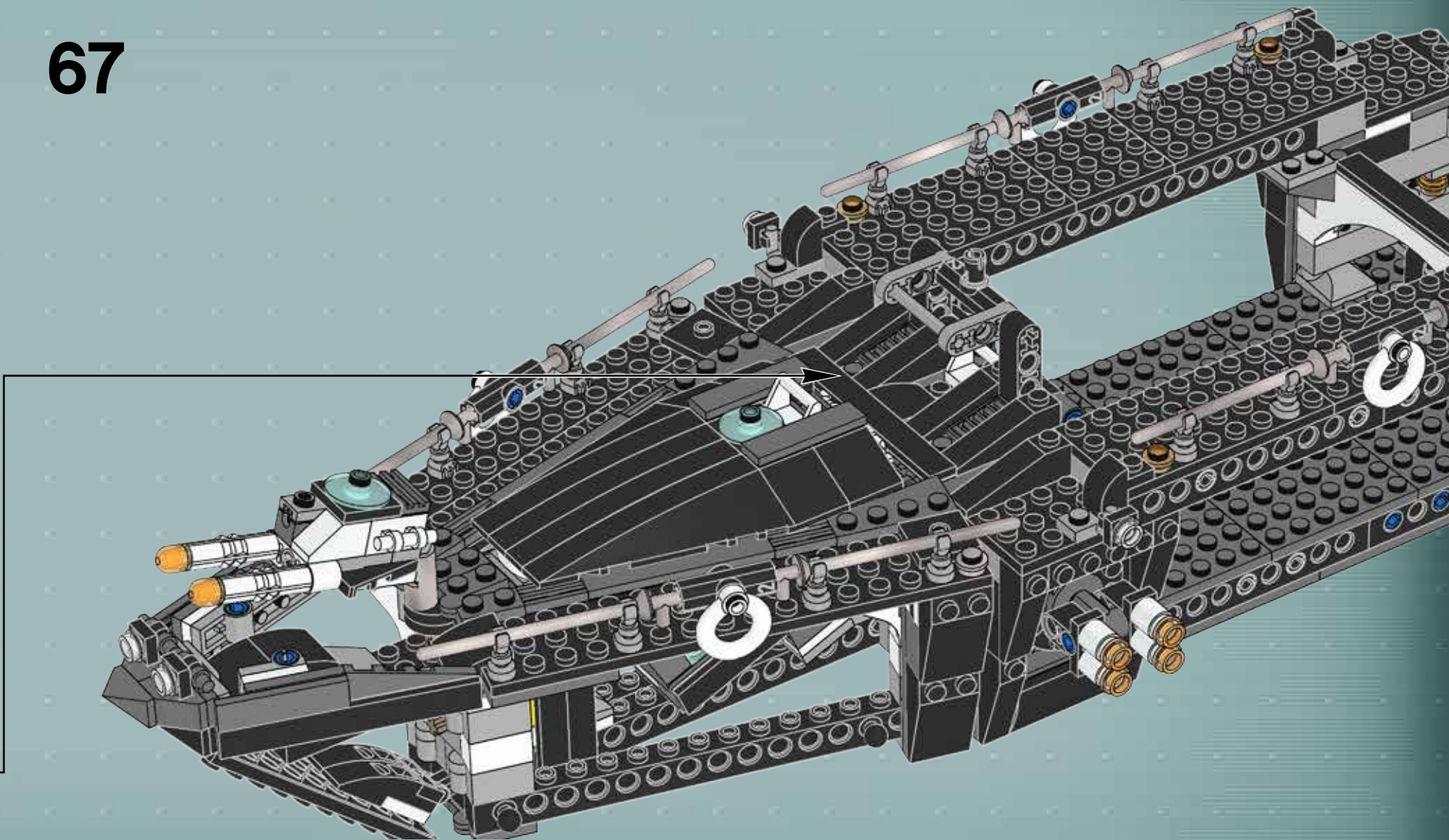

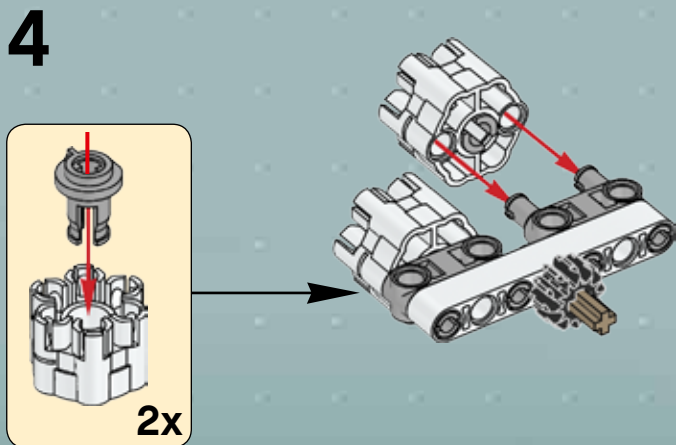
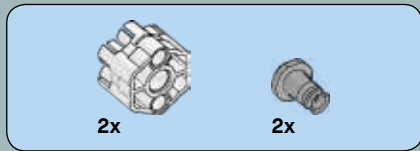
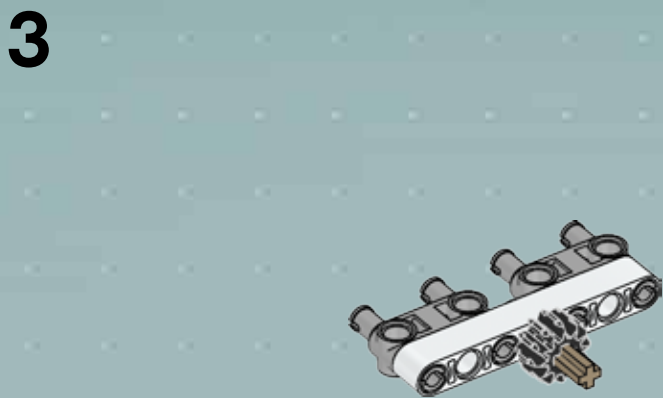
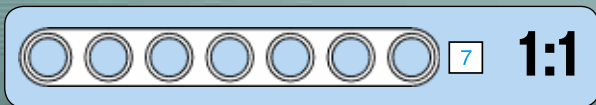
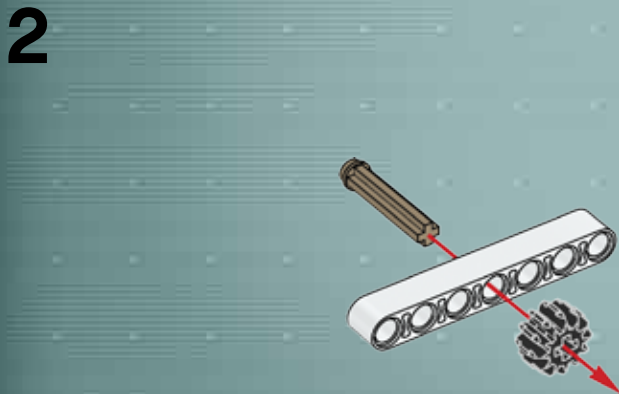
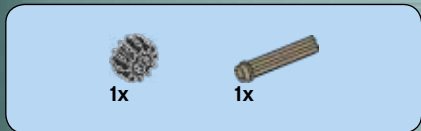
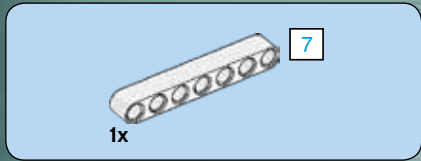
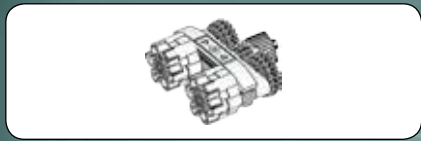

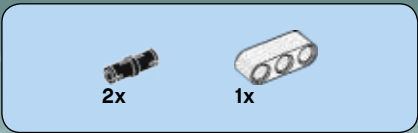

5

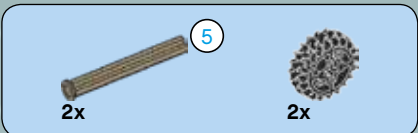
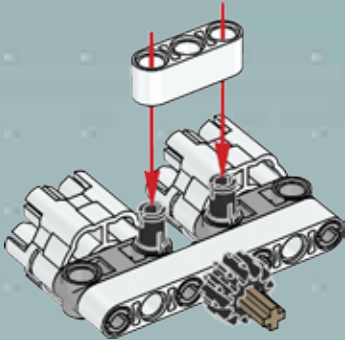

6

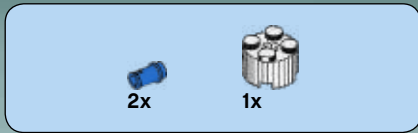
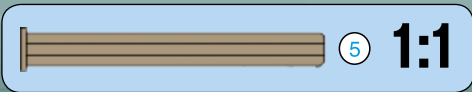
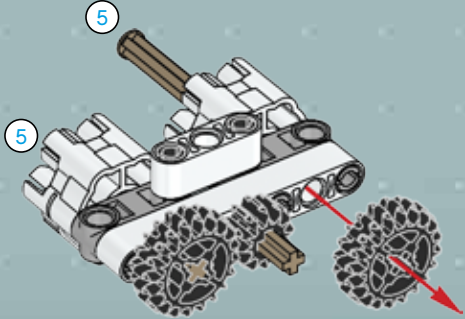

7

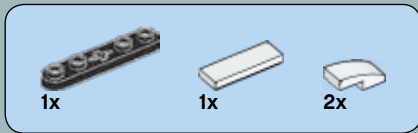
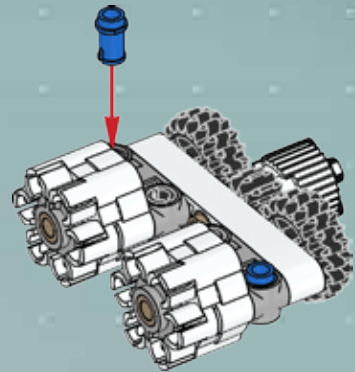

8

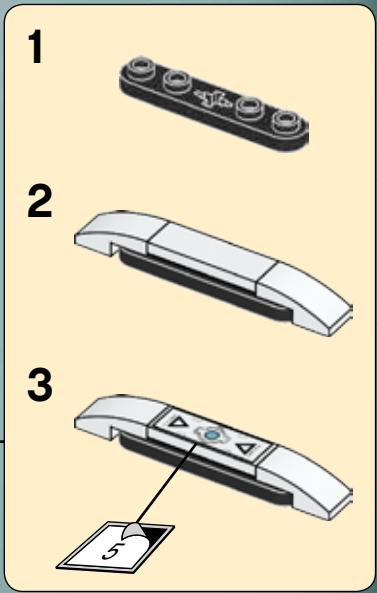
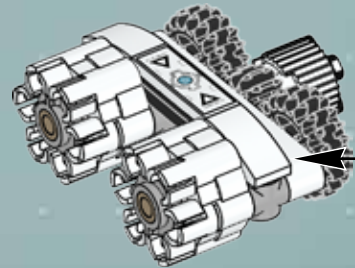

68

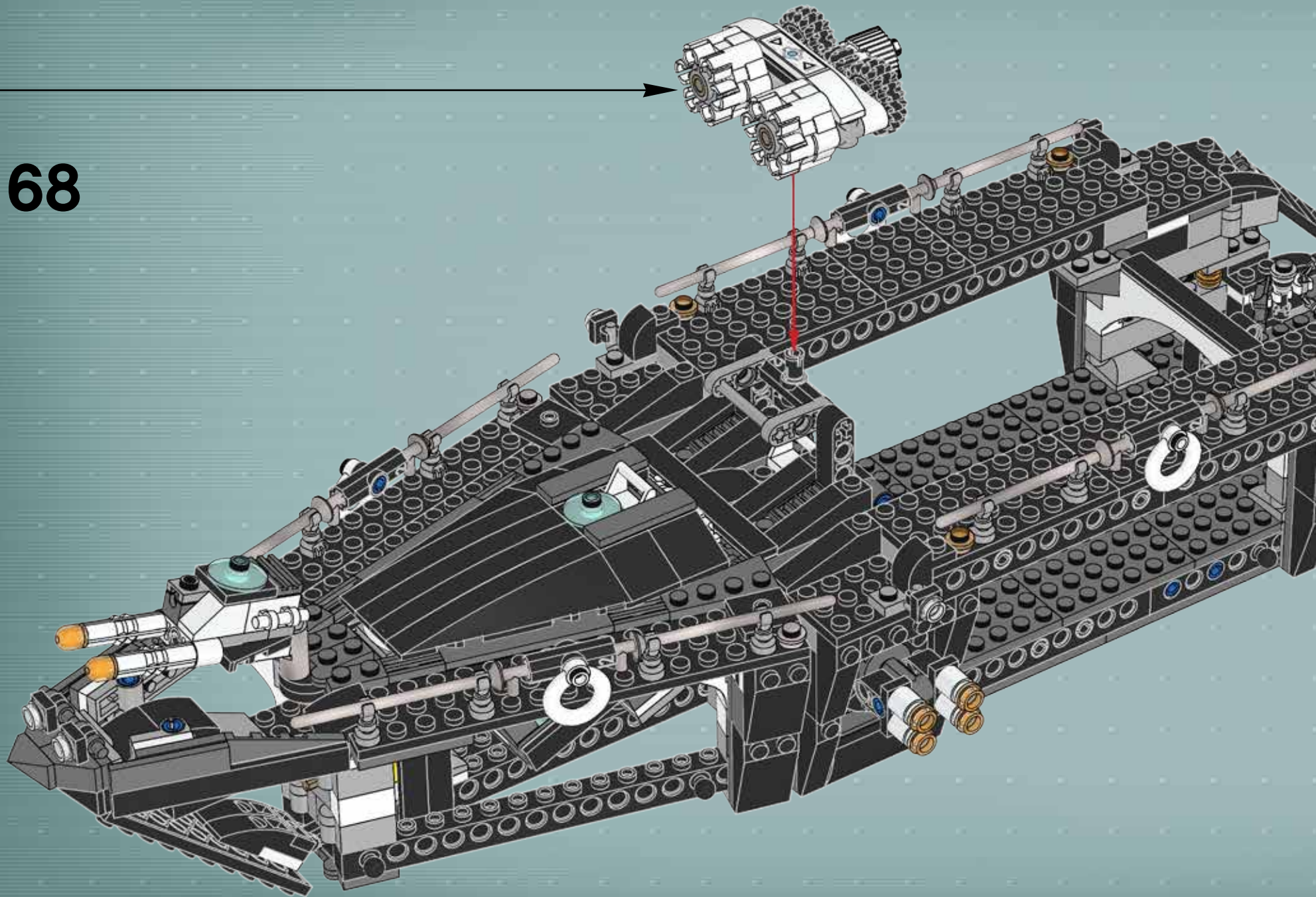



69

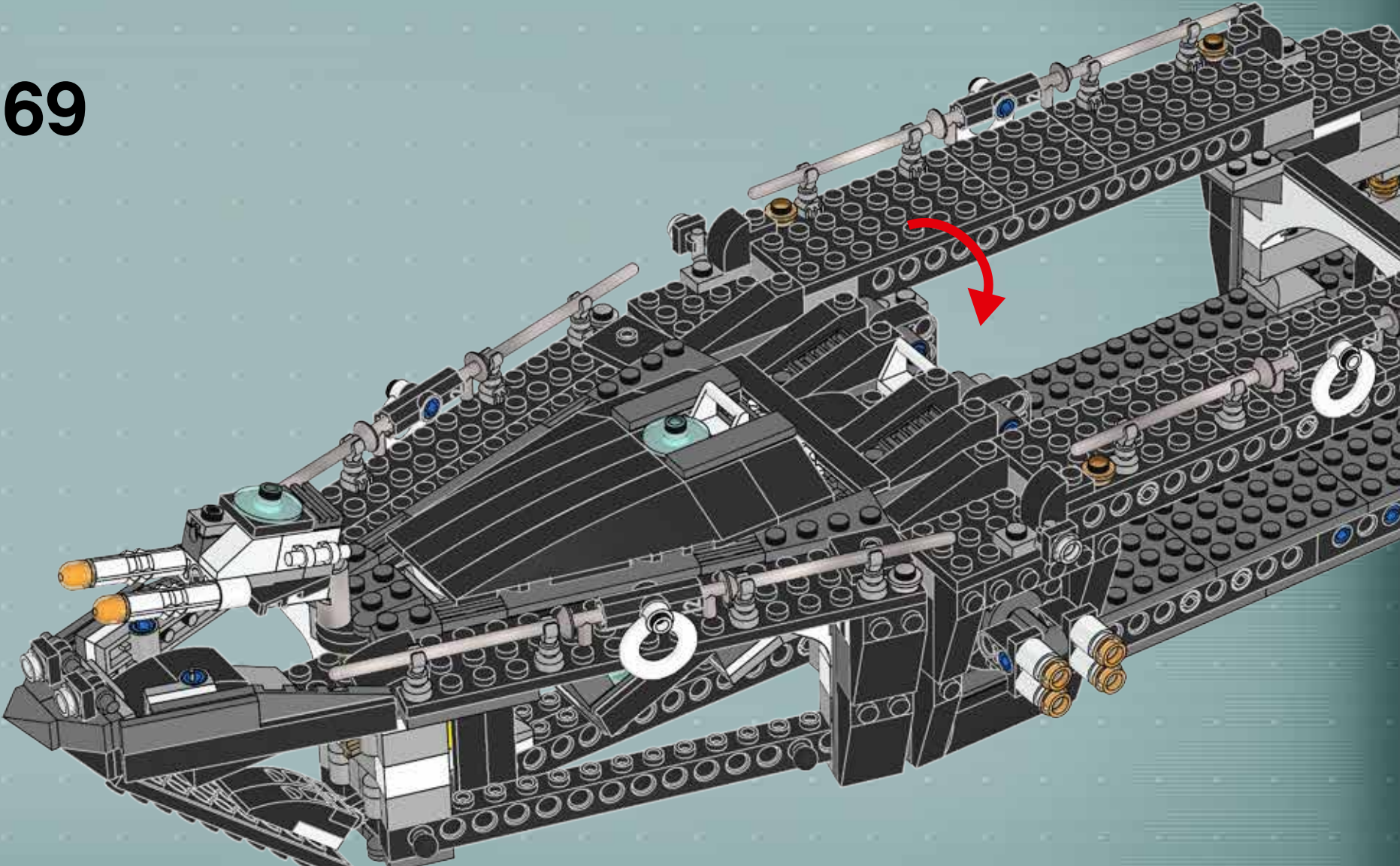

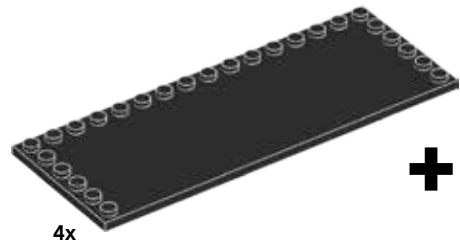

+

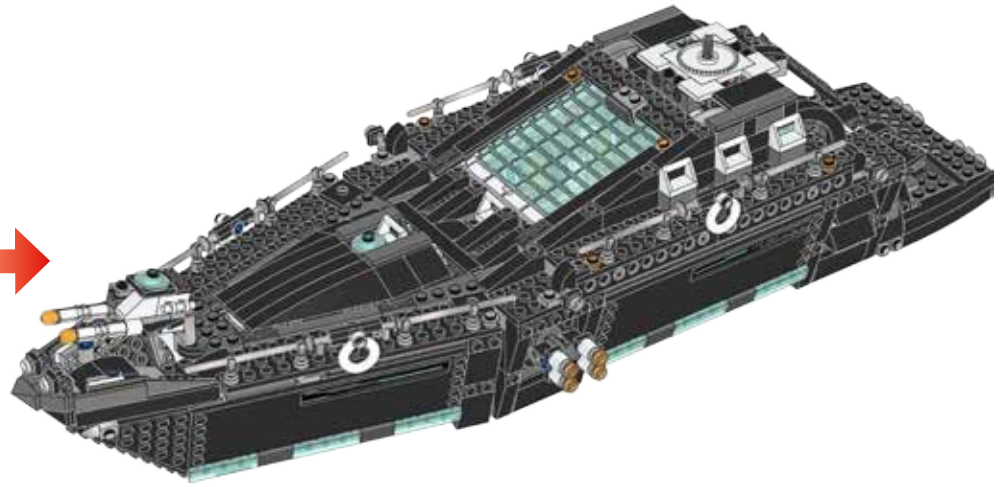

4x

6

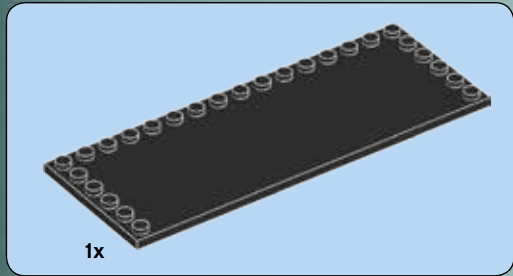
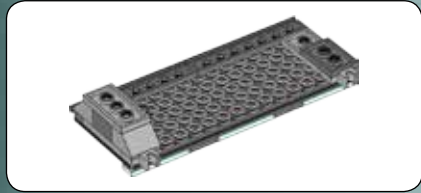

1x

1

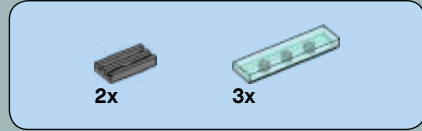
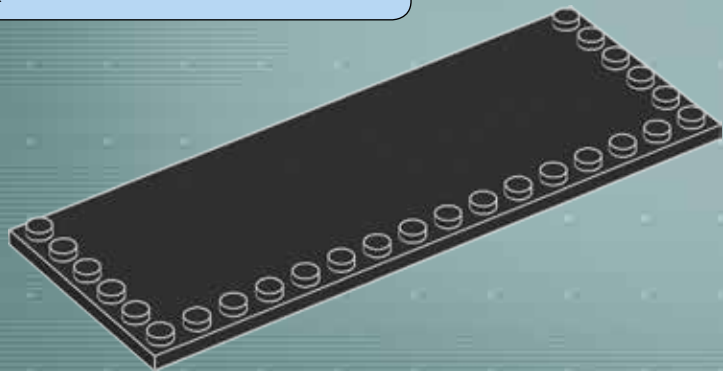

2x

3x

2

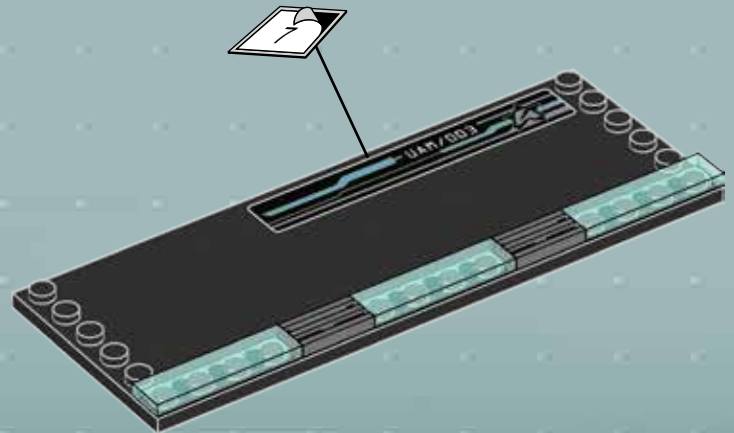



3

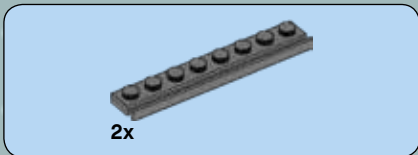
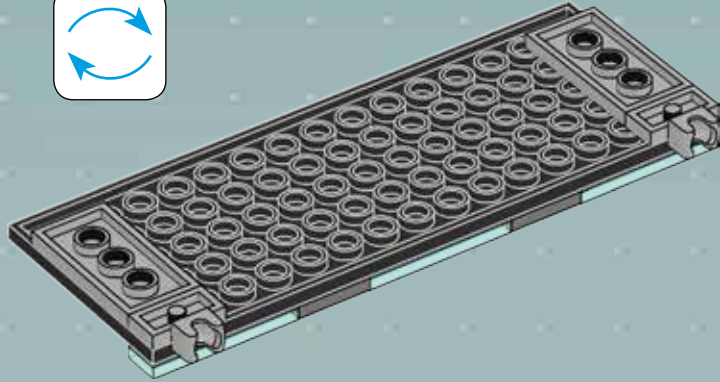

4

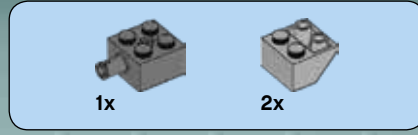
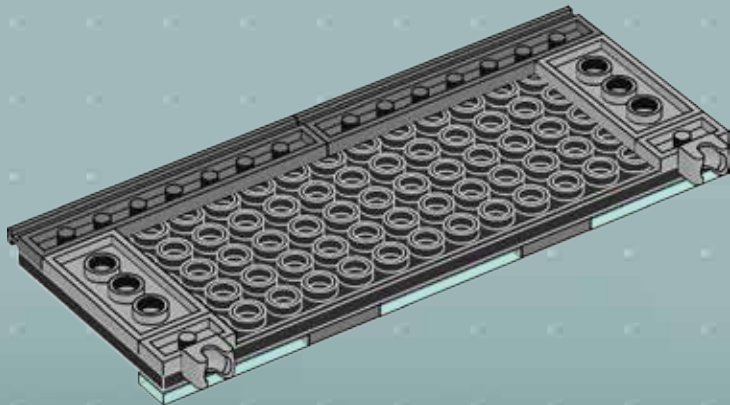

5

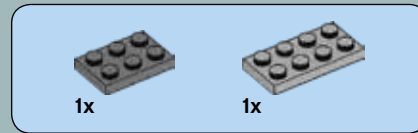
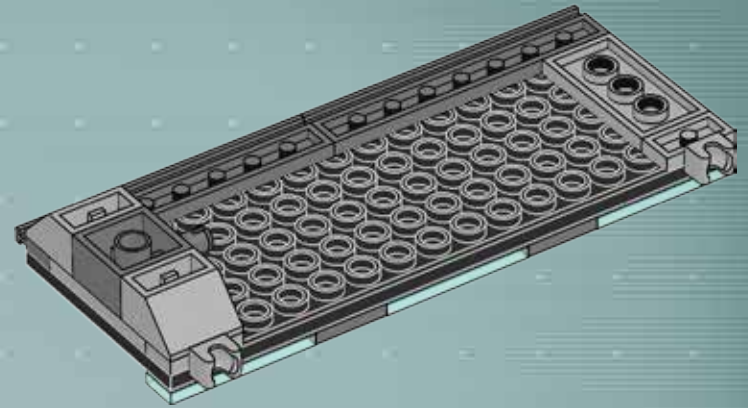

6

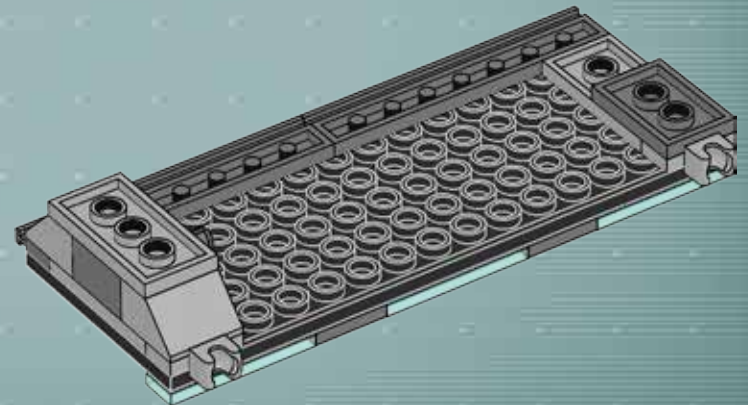

70

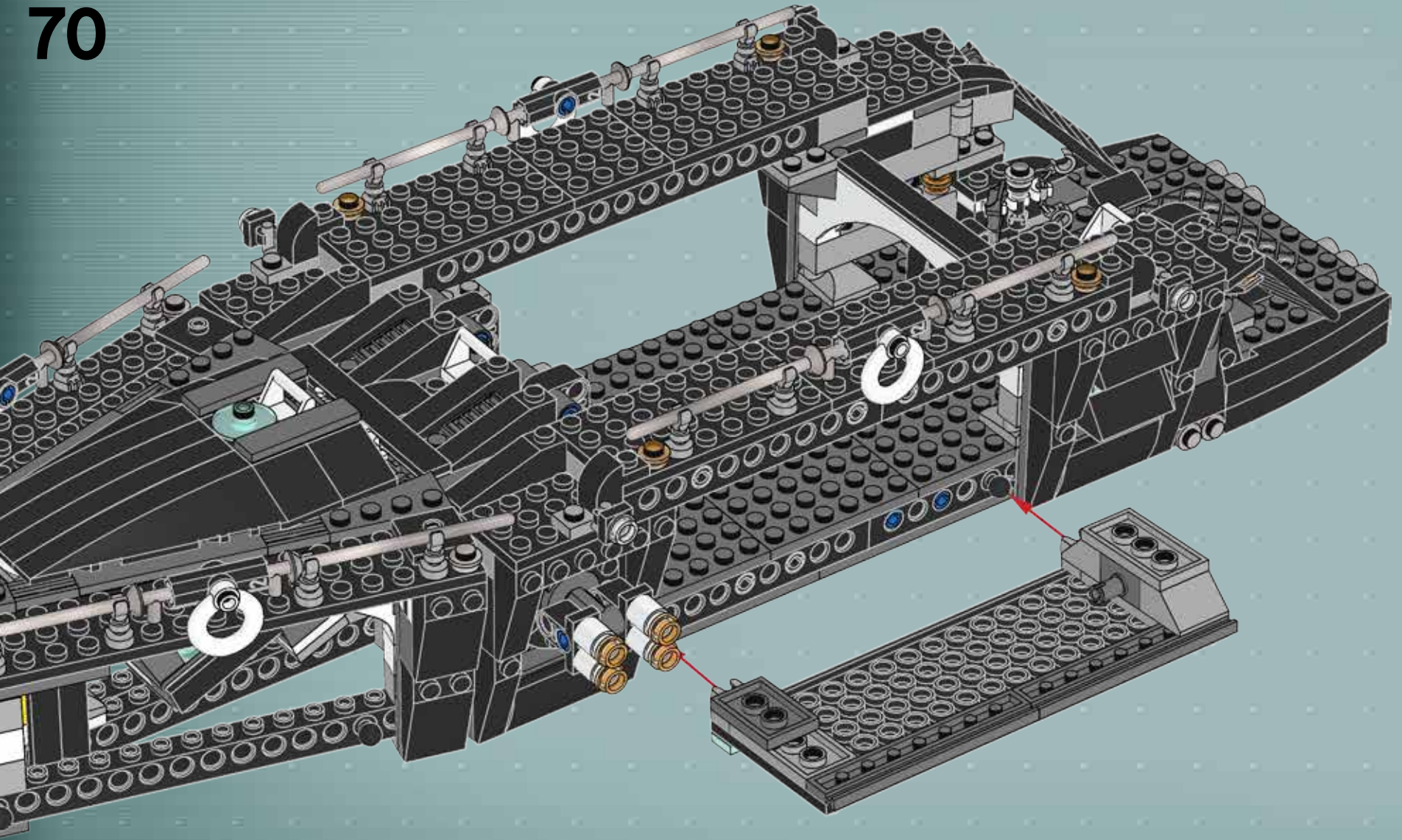

71

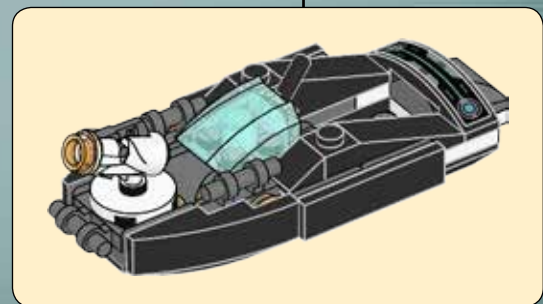
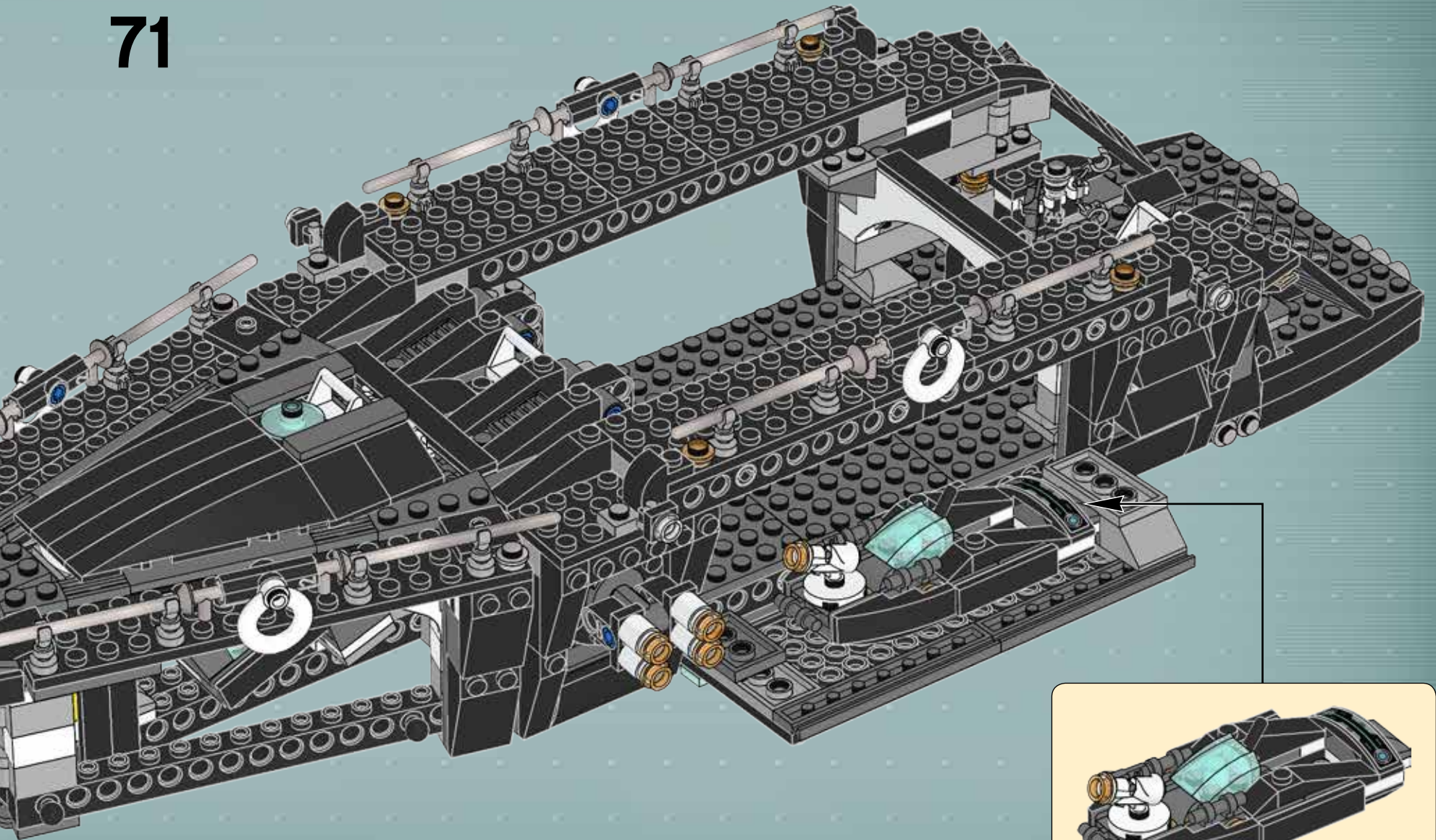

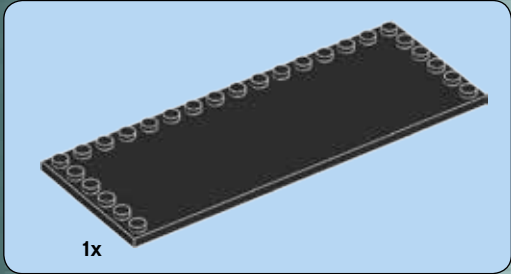
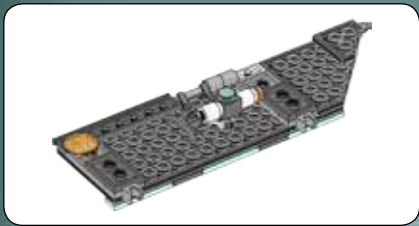

1

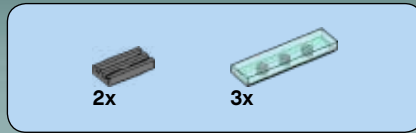
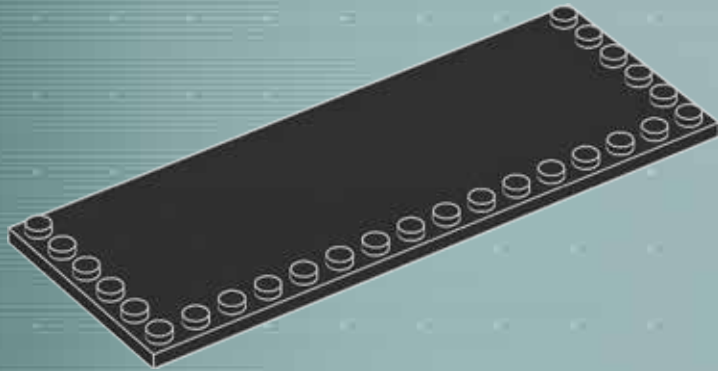

2

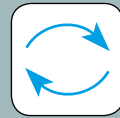
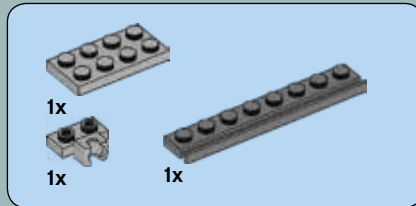
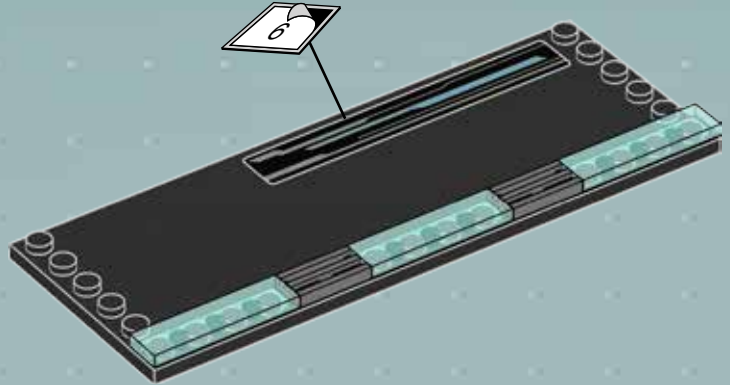

3

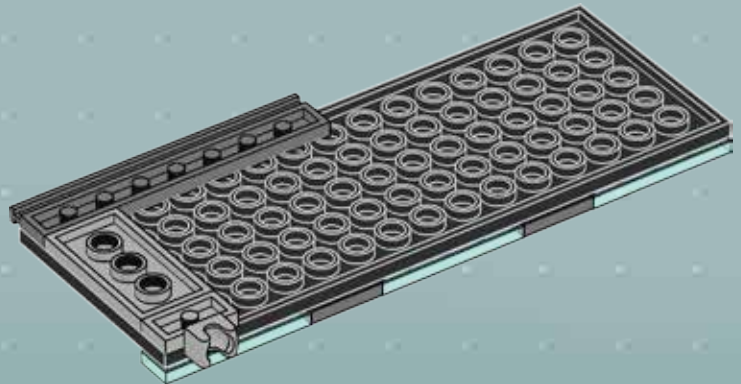

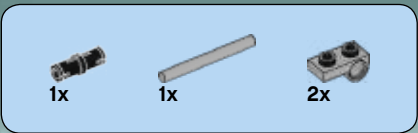

4

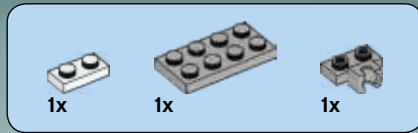
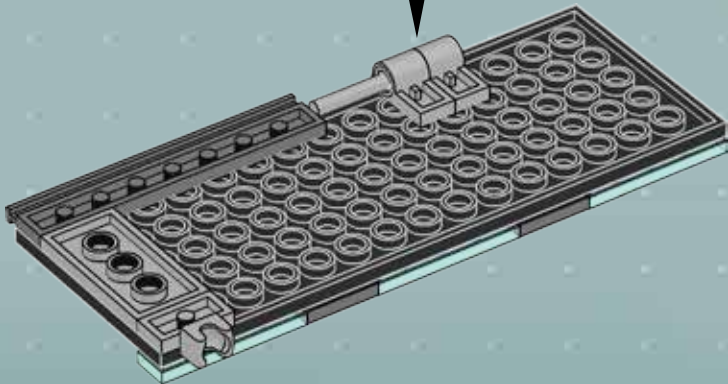
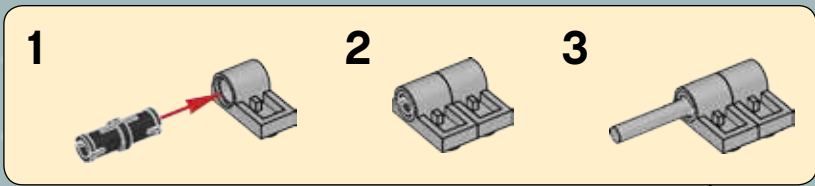

5

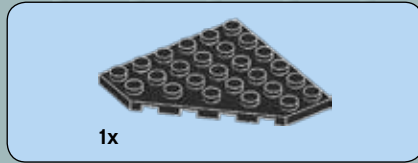
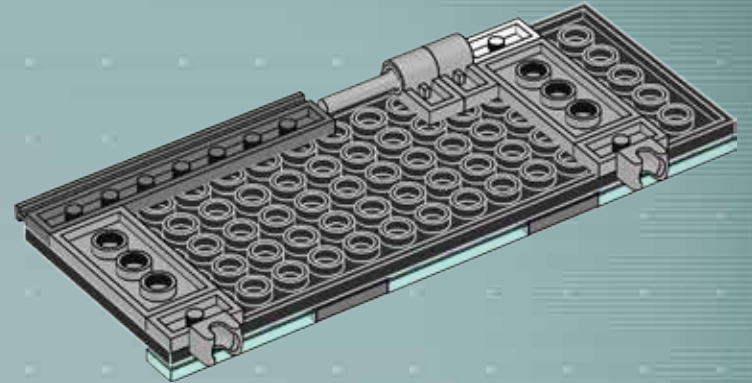

6

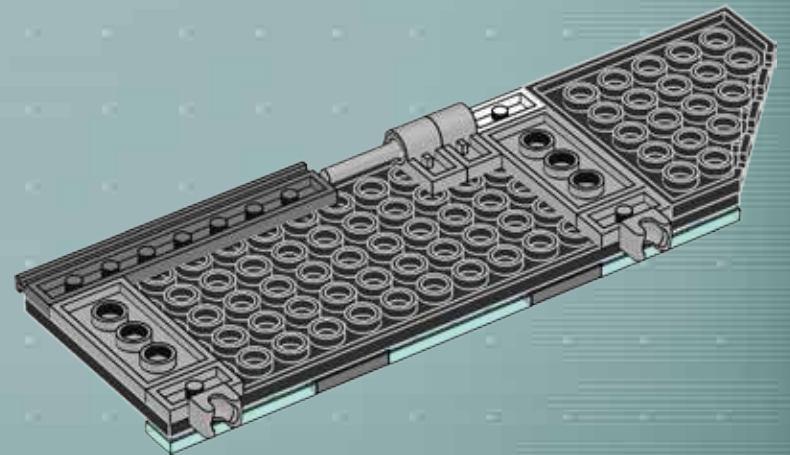



1x



1x

7

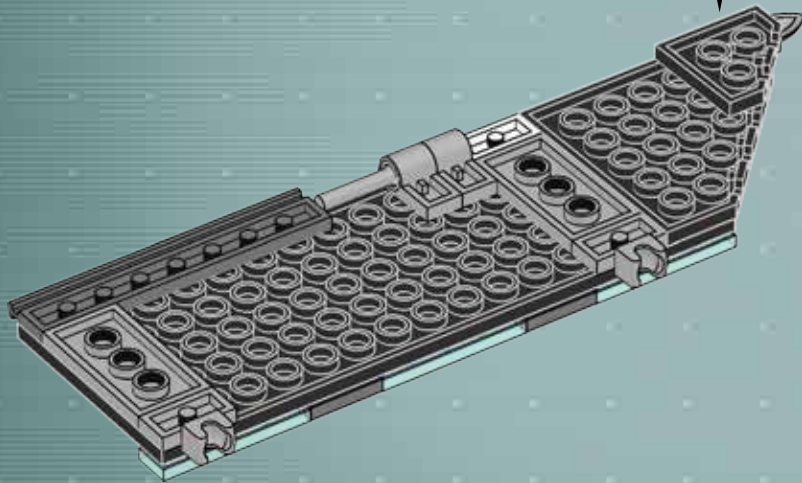
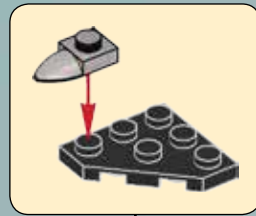

2x



1x

8

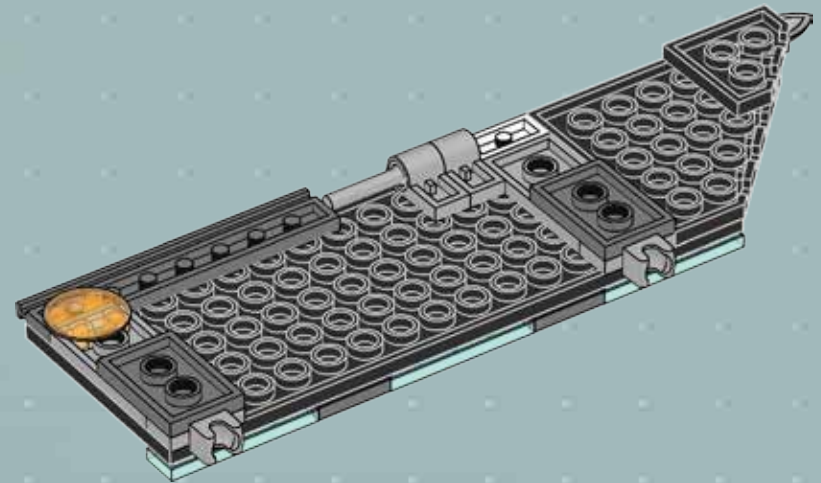





9

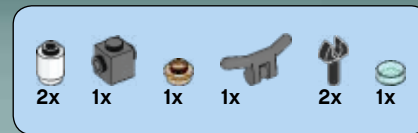
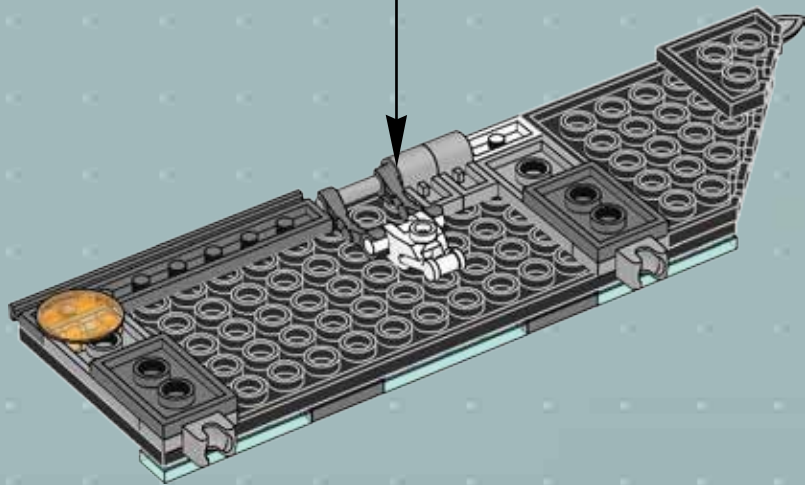
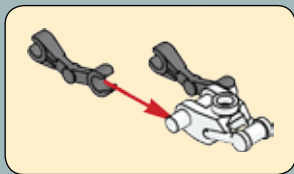

10

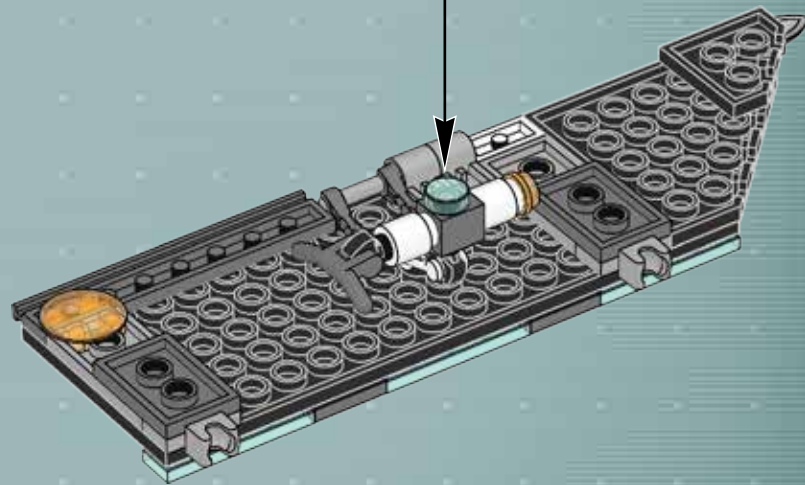
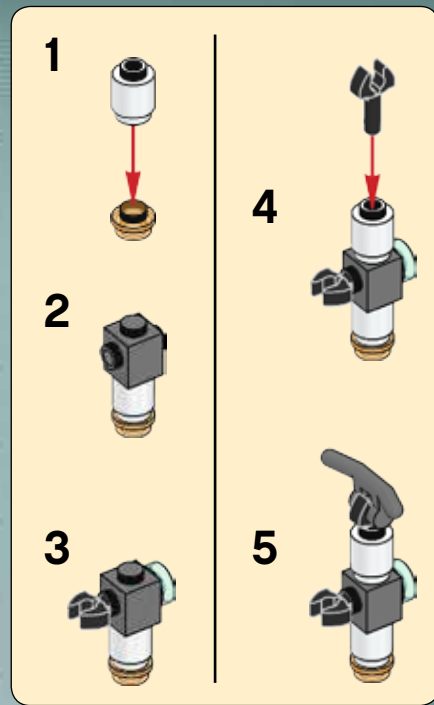

72

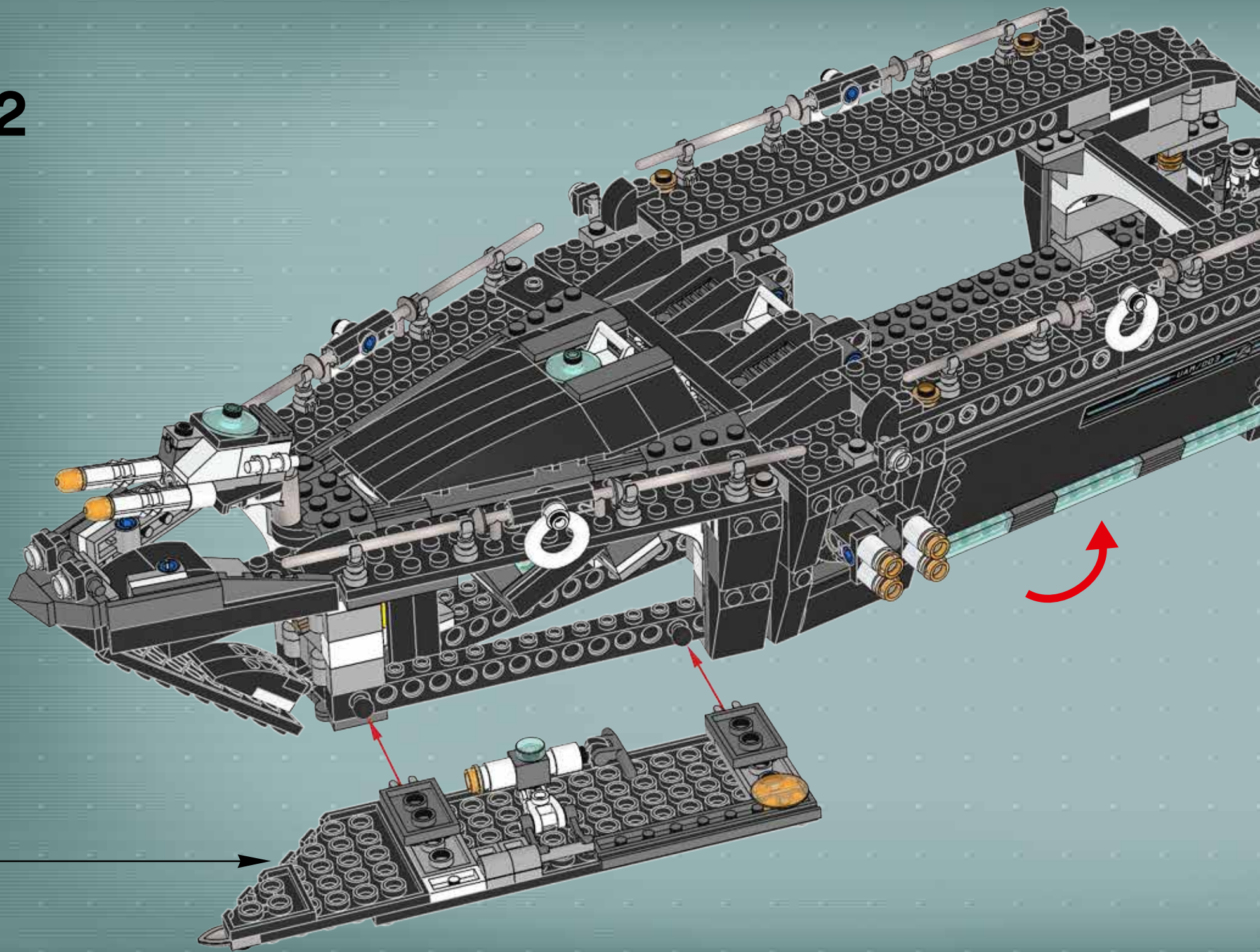

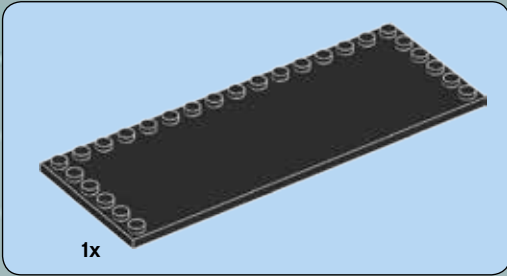
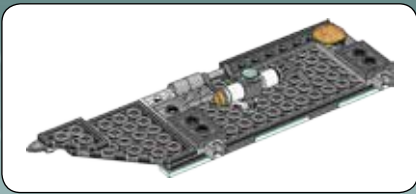

1

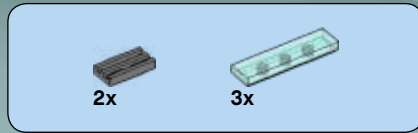
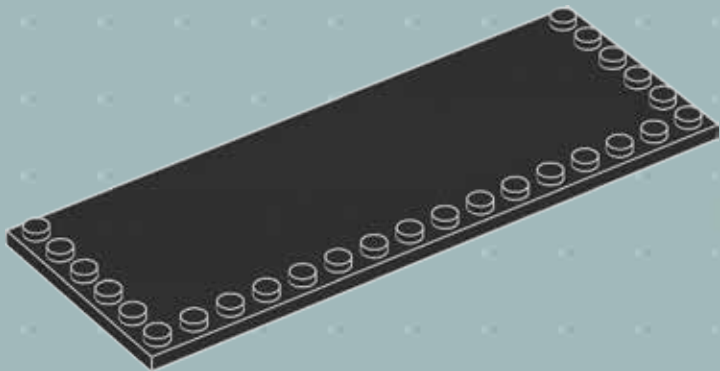

2

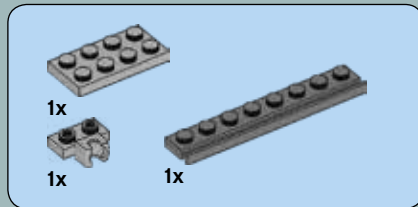
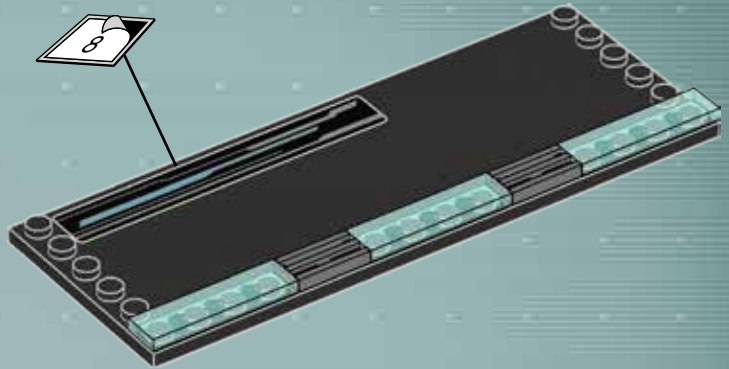

3

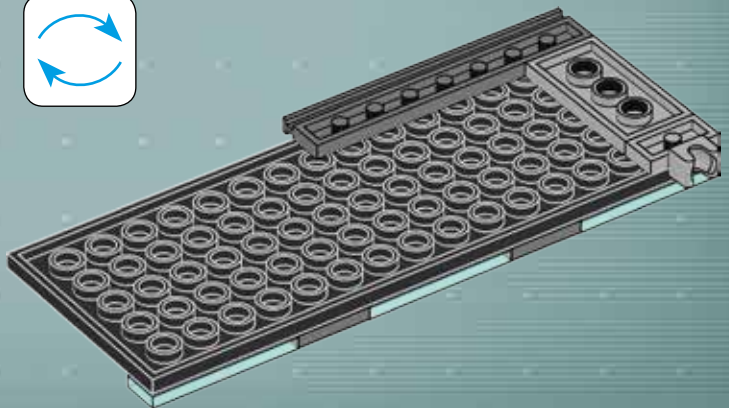
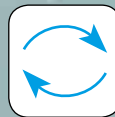

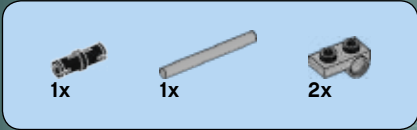

4

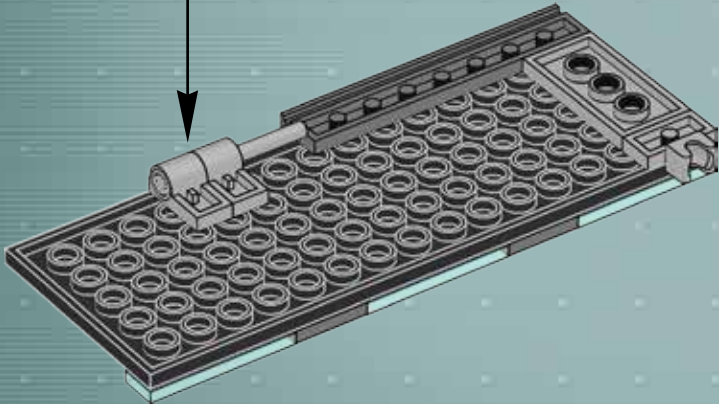
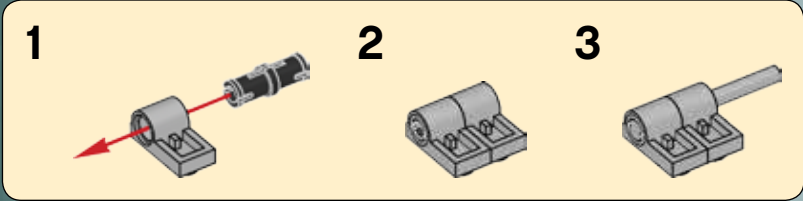

5

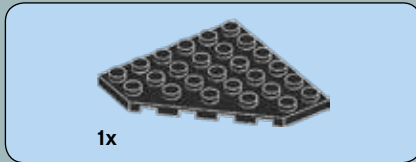
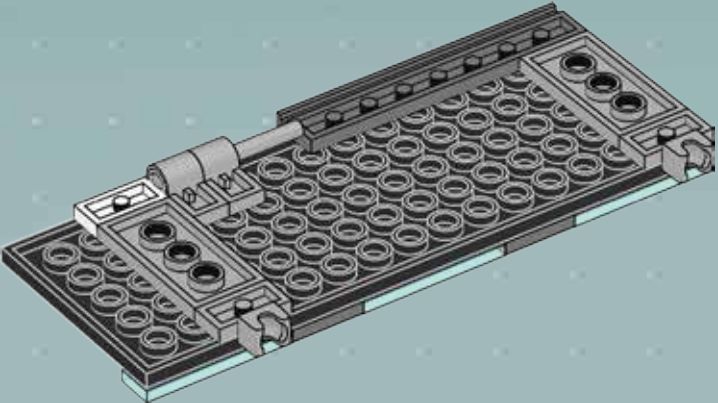

6

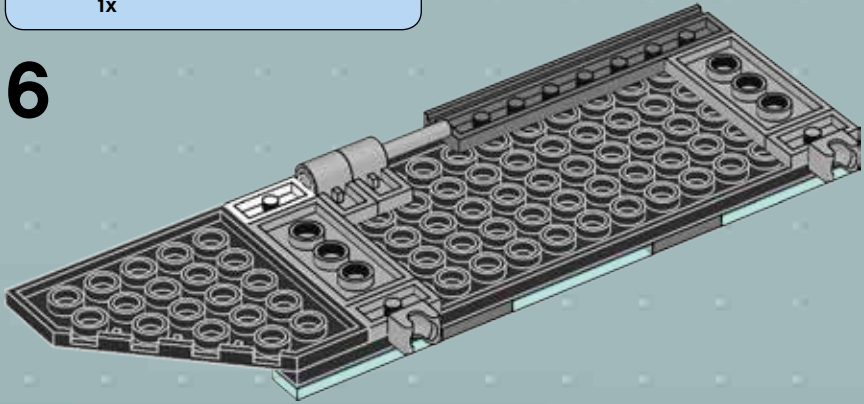





9

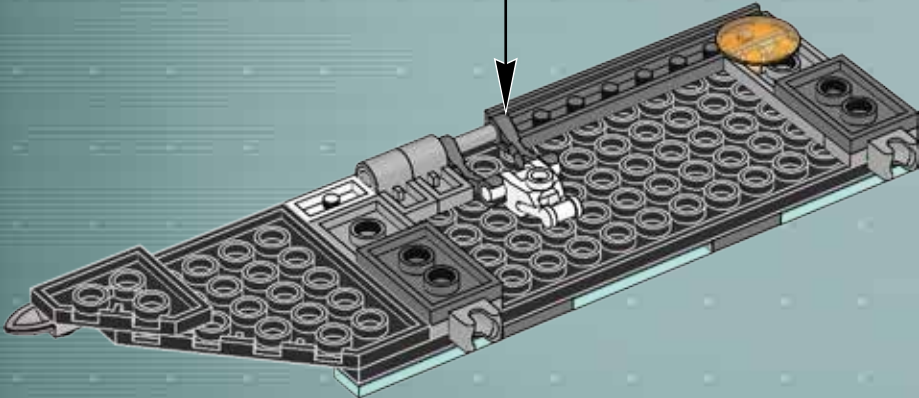
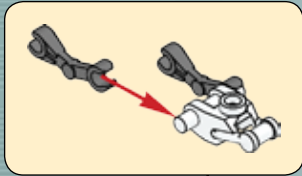

10

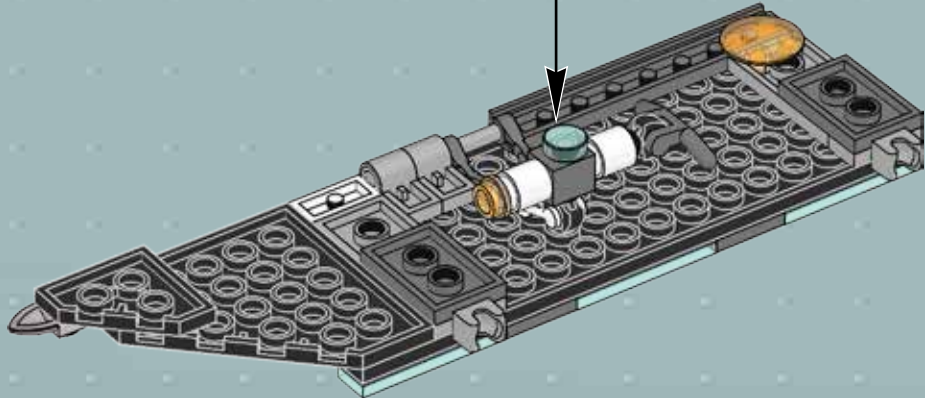
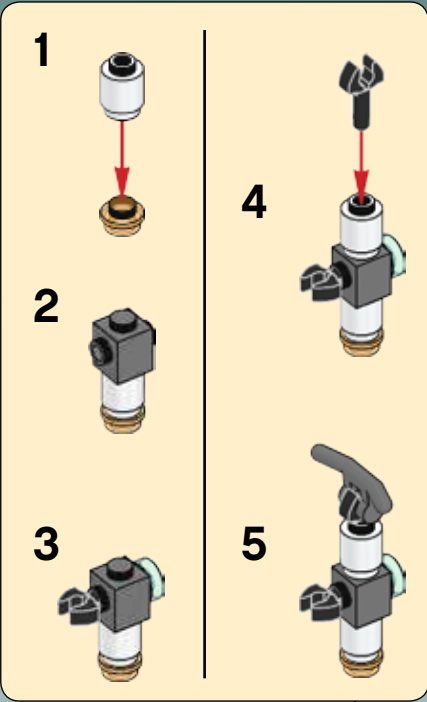

# 73

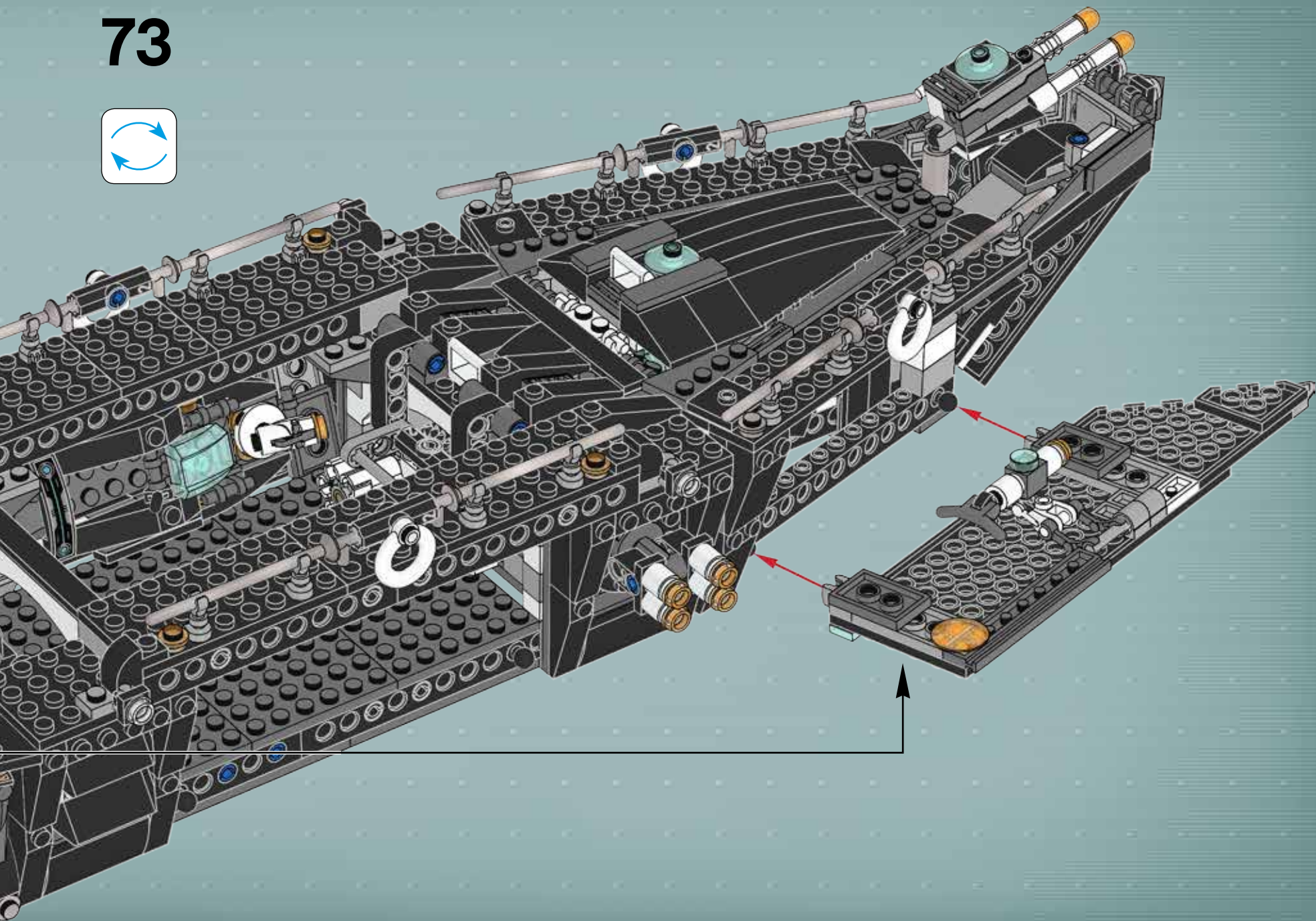

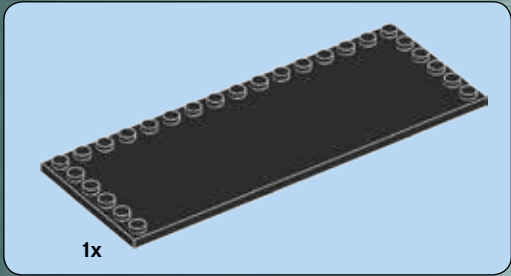

1

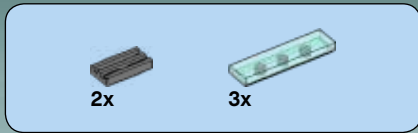
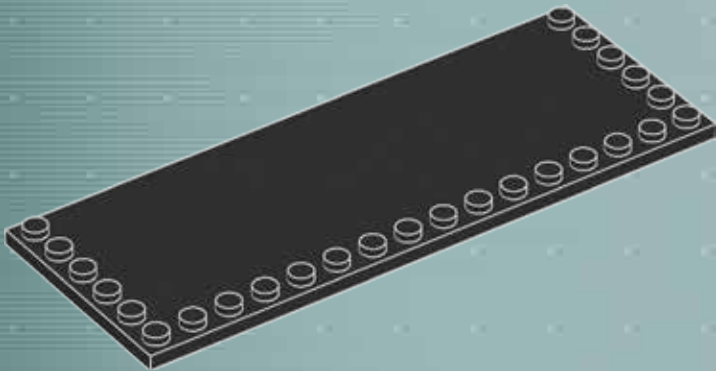

2

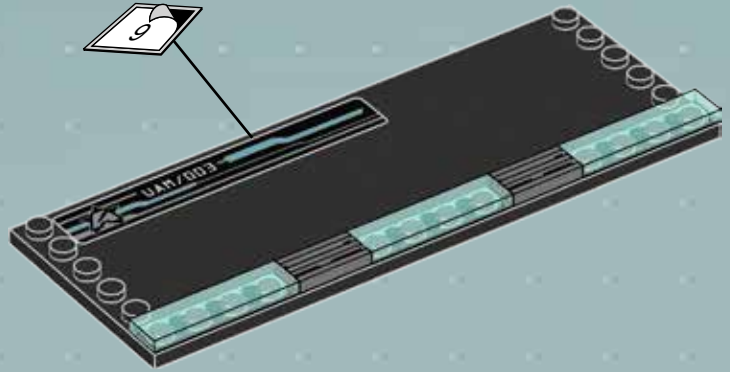

3

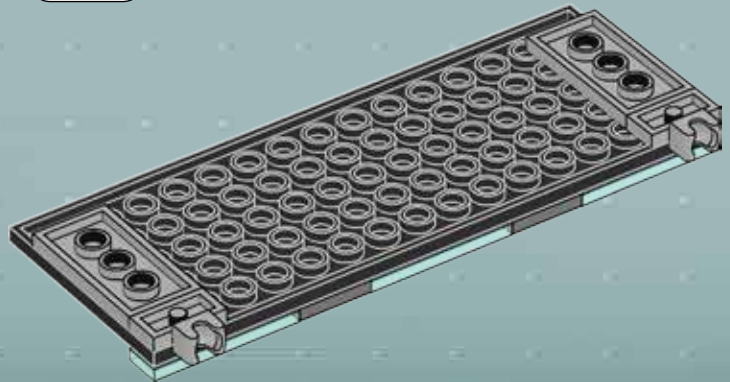
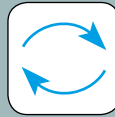



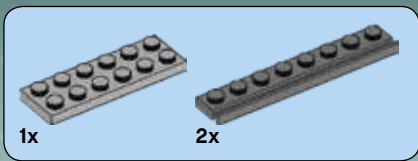

4

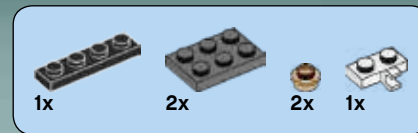
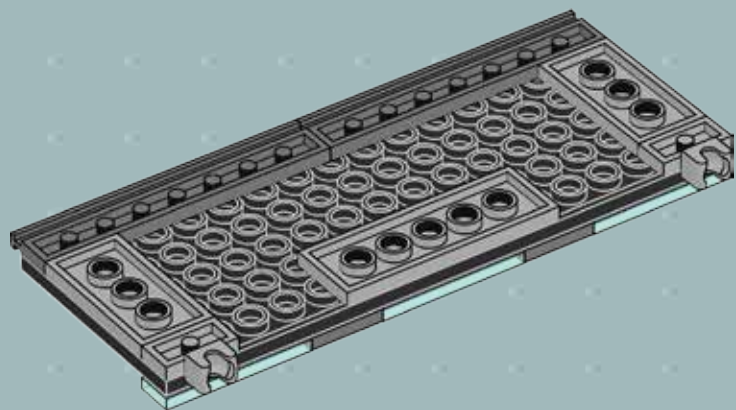

5

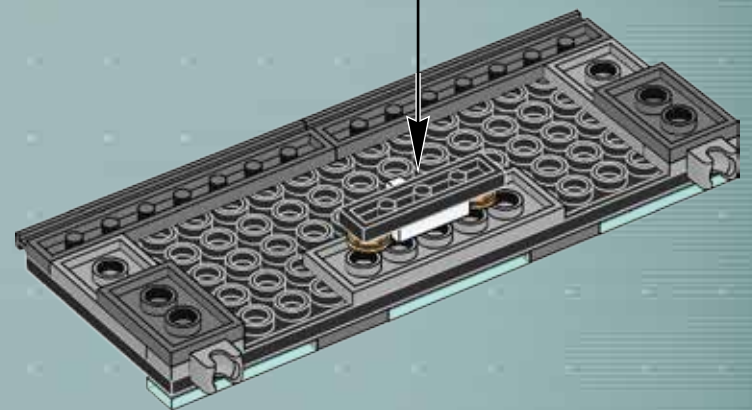
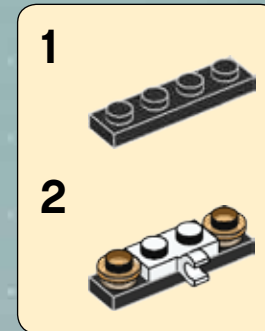

74

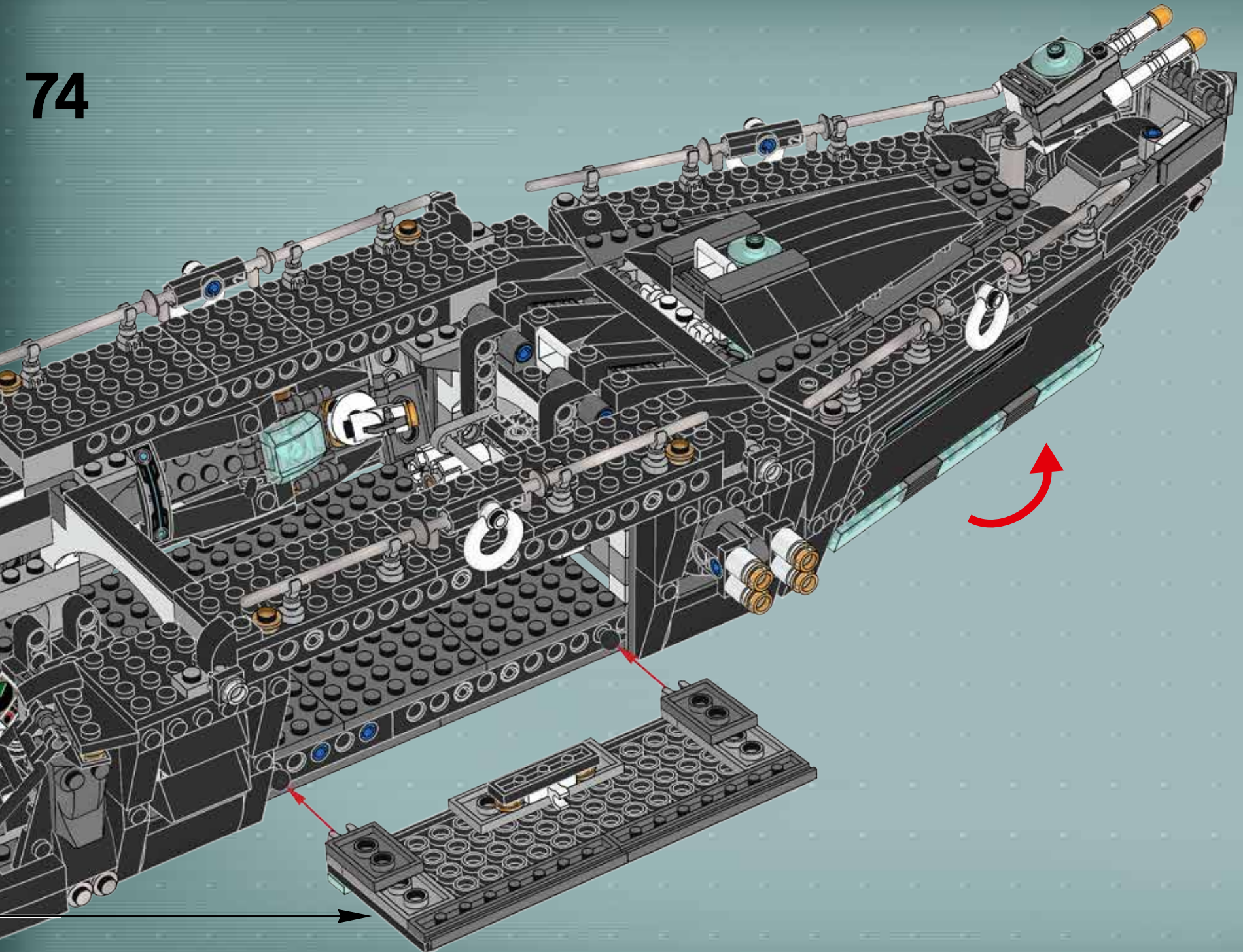

75

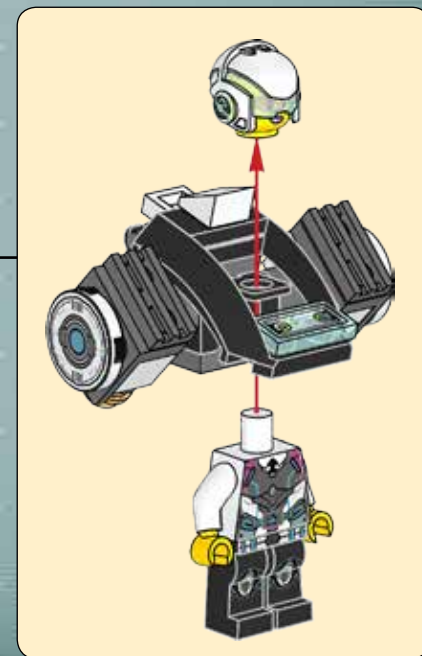
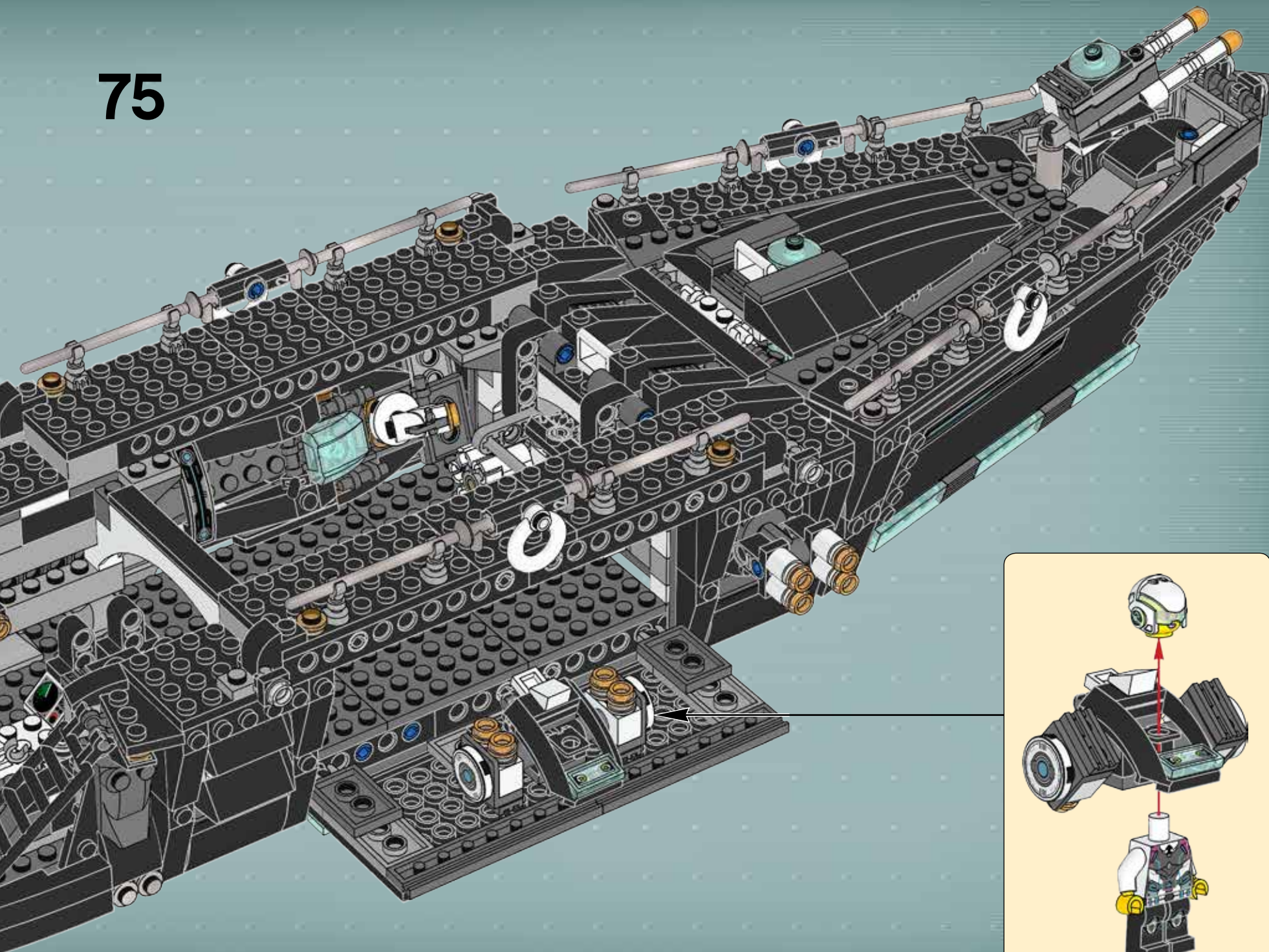

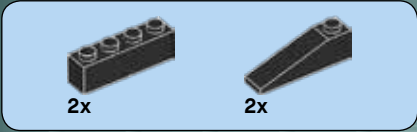

76

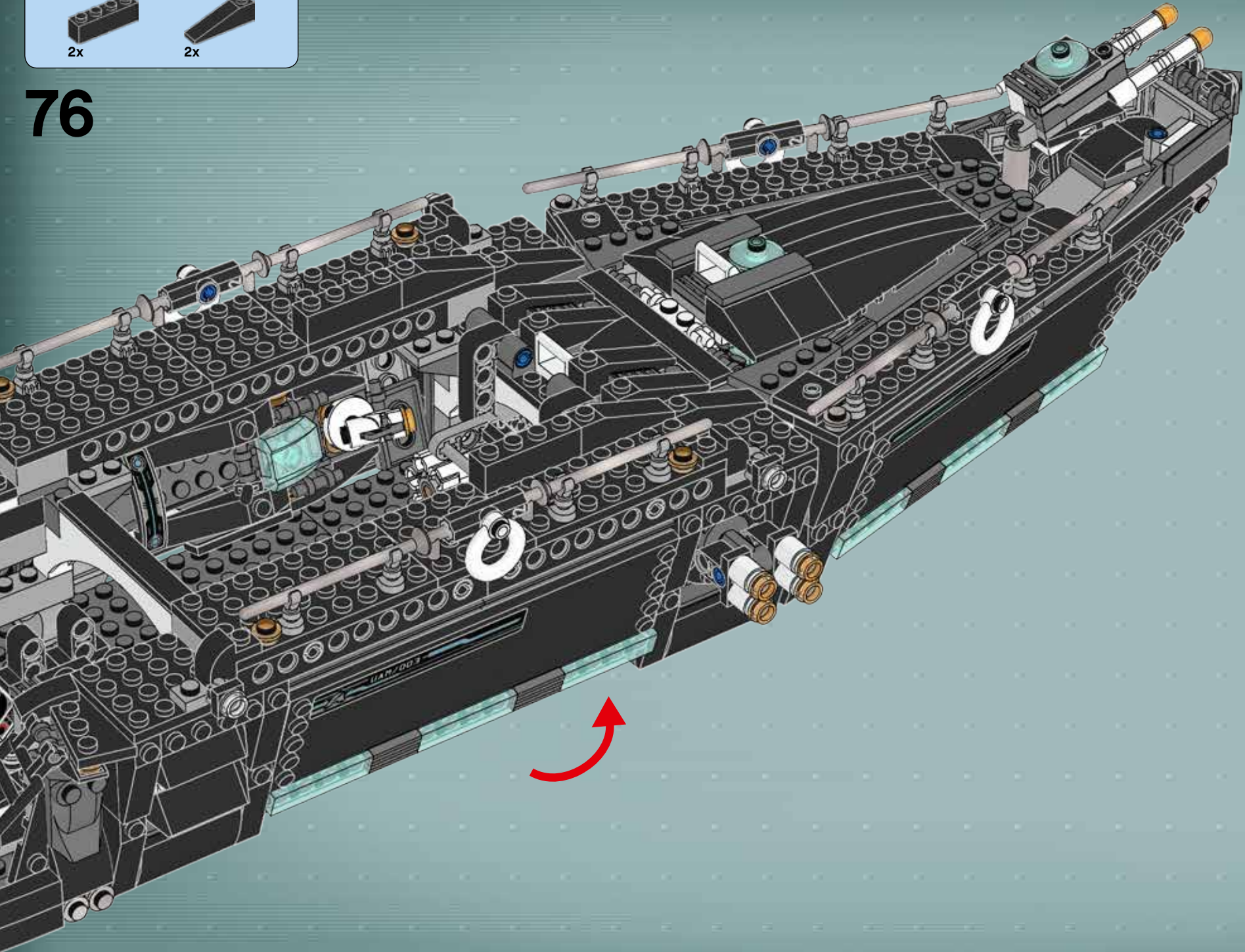

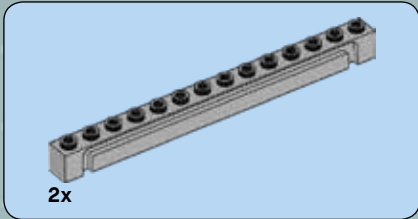
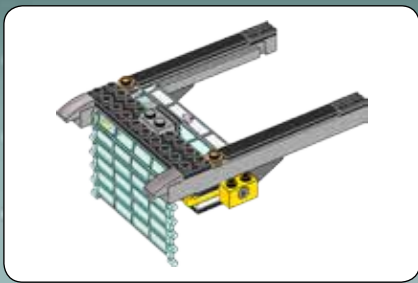

1

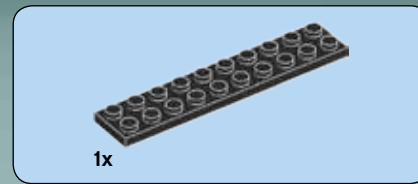
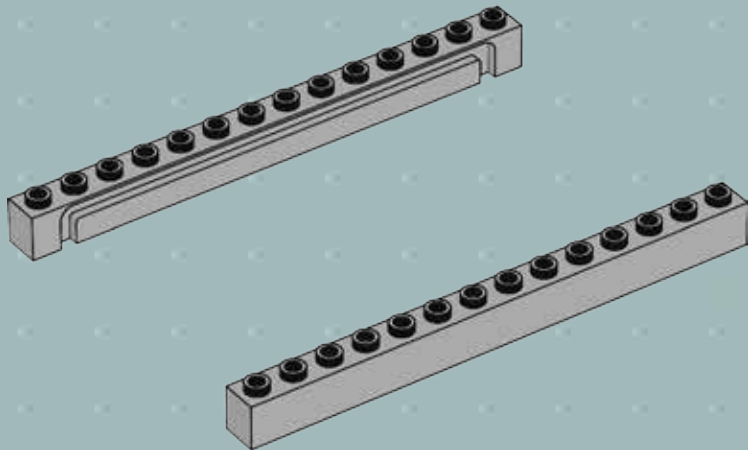

2

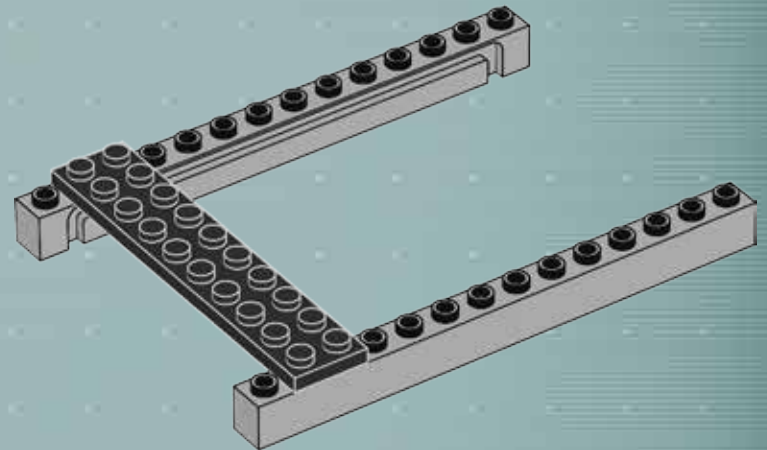

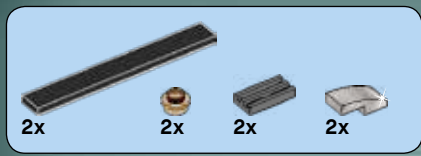

3

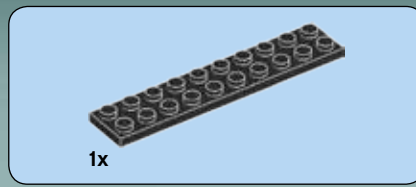
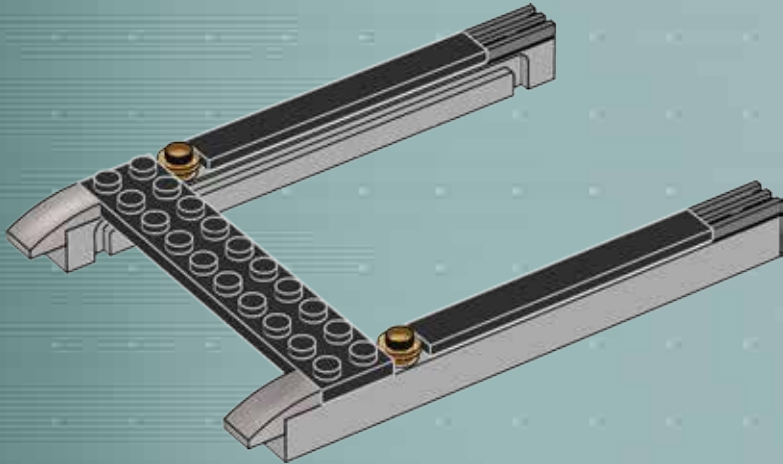

4

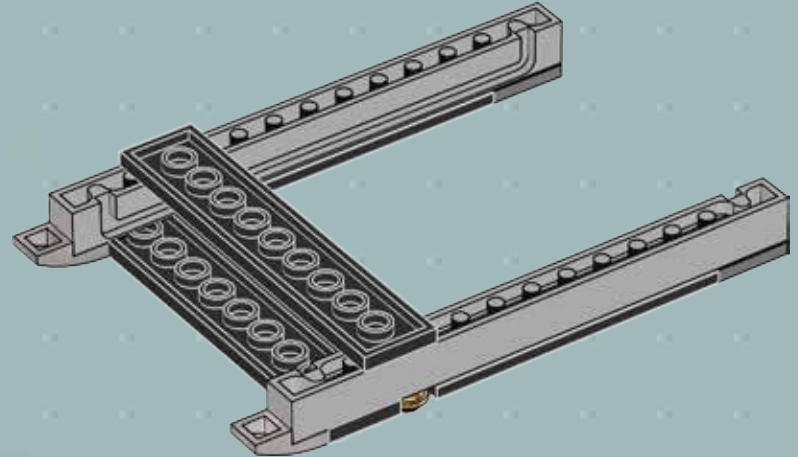



5

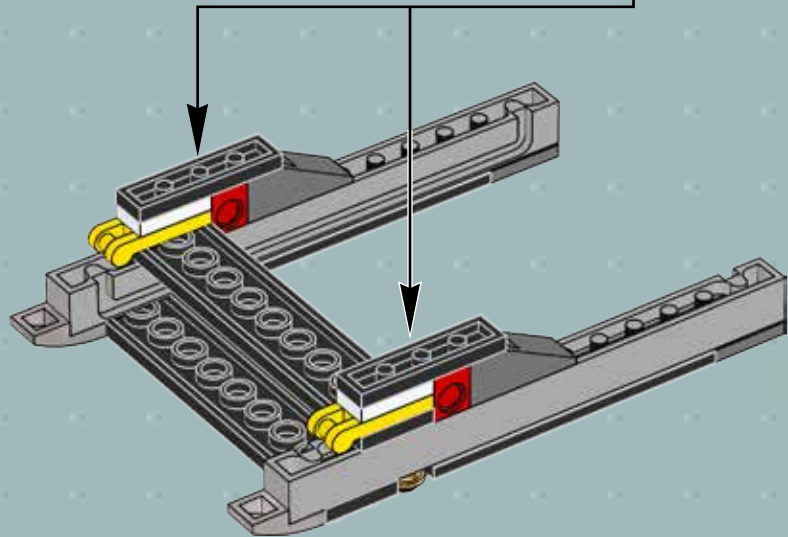
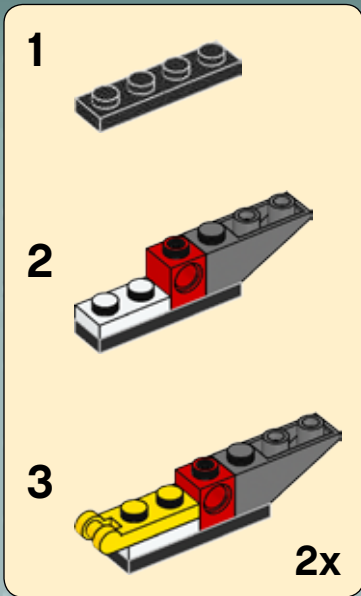

6

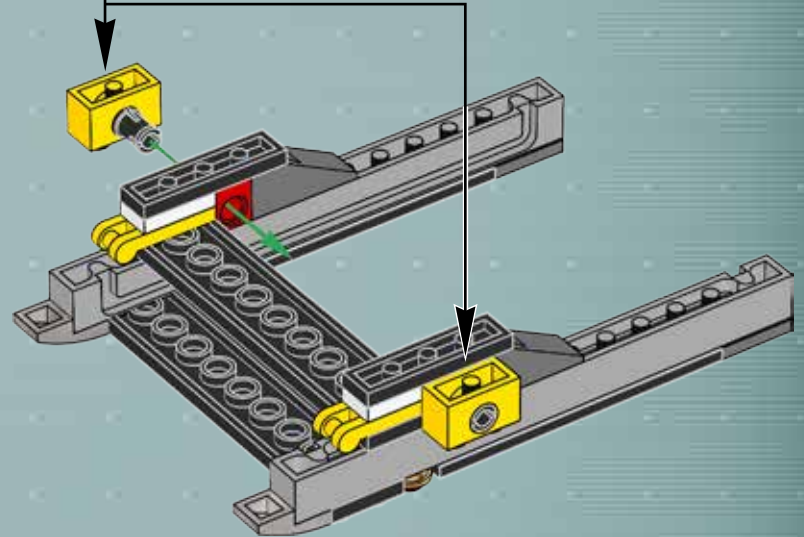
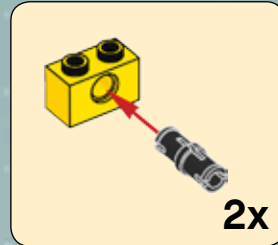

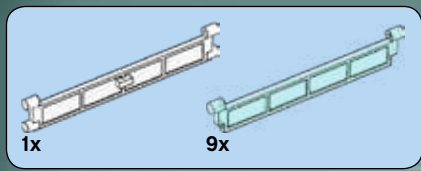

7

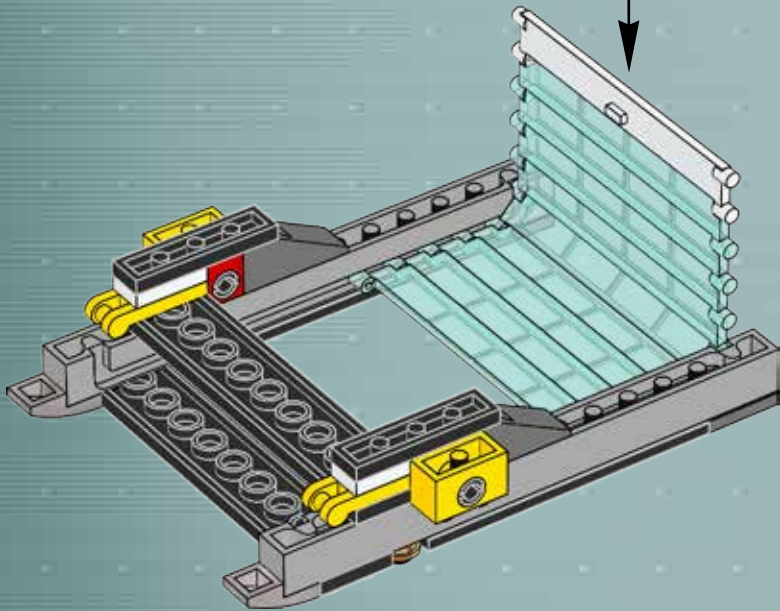
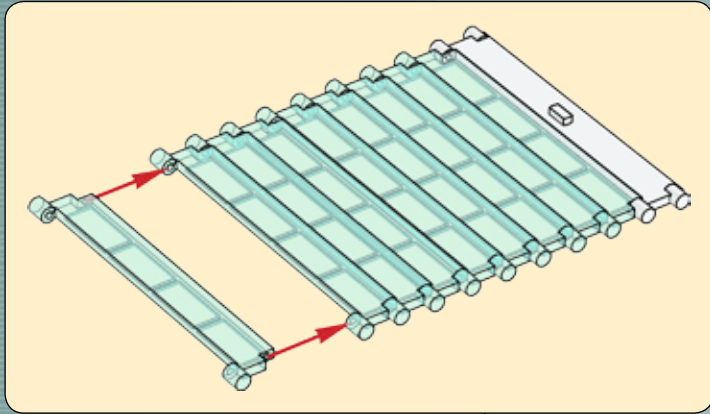

8

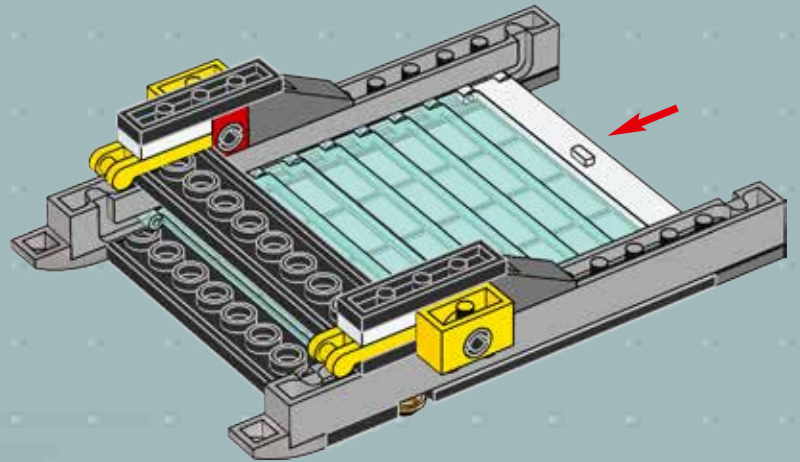





9

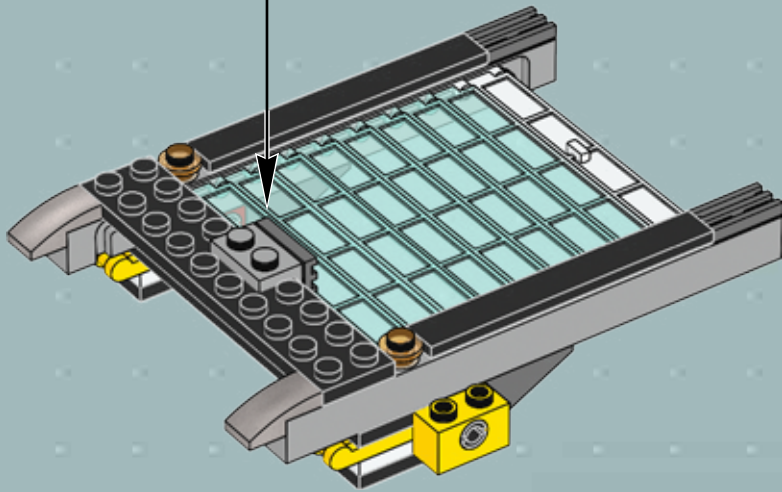
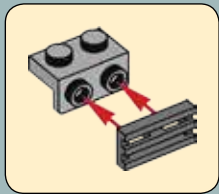

10

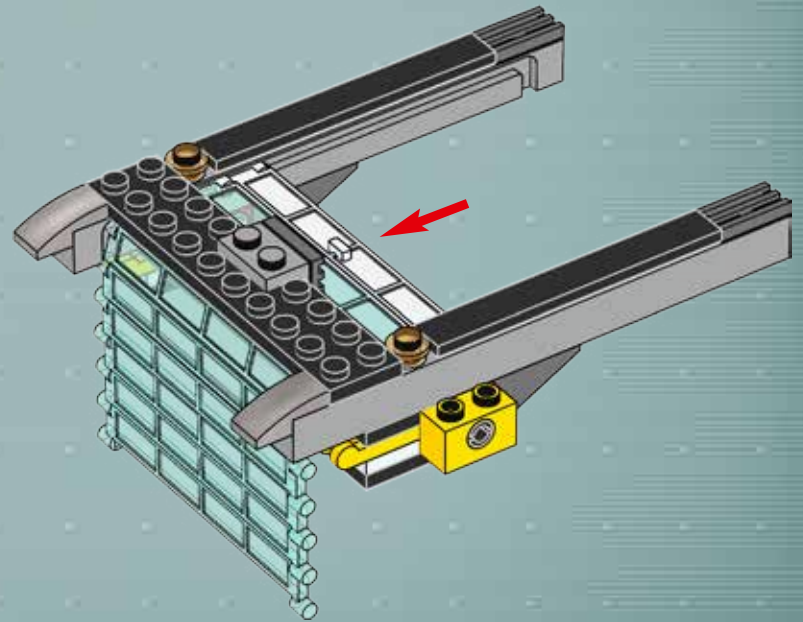

77

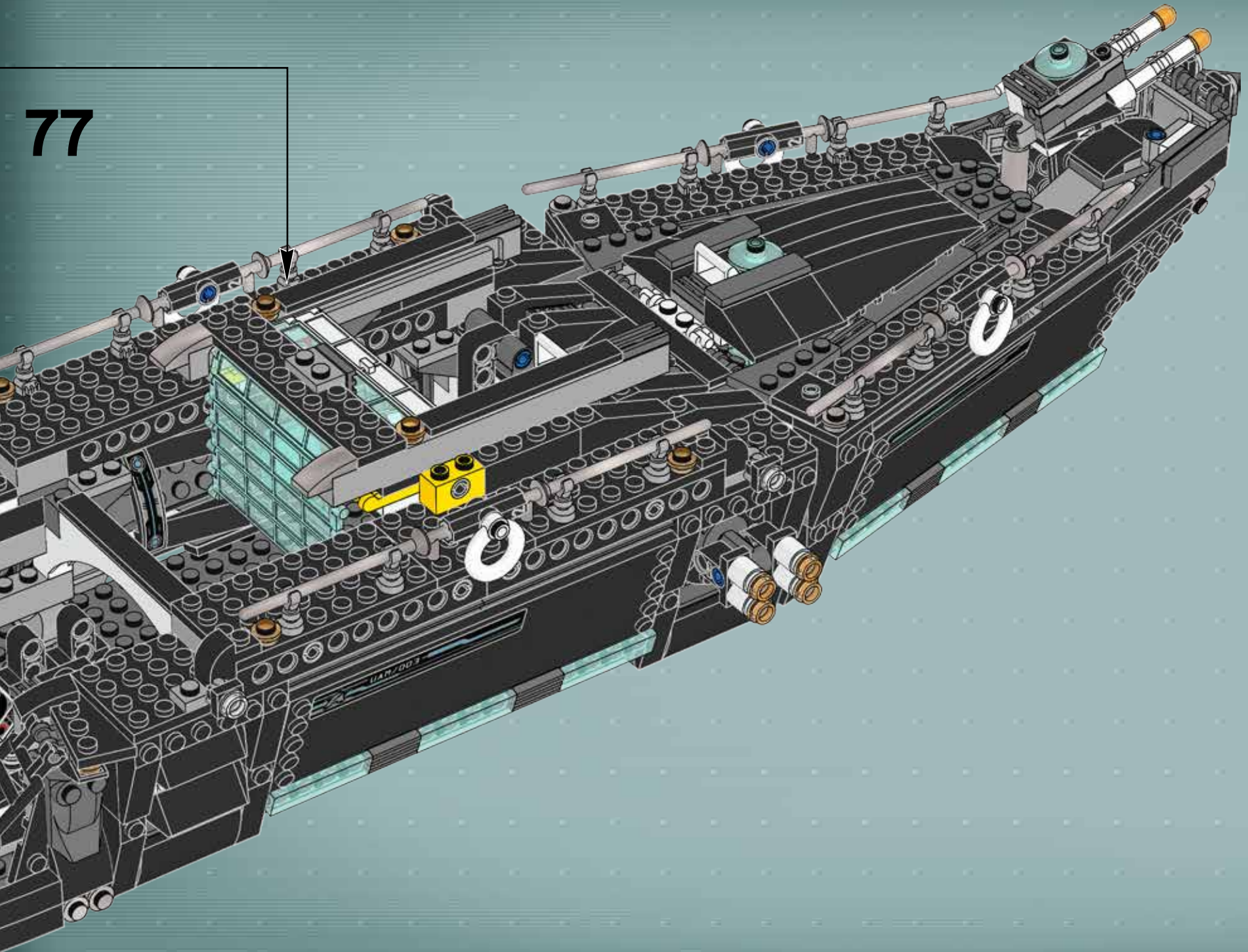

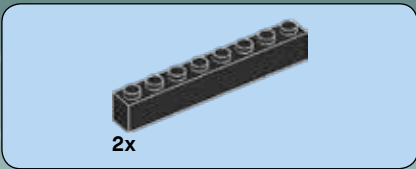

78

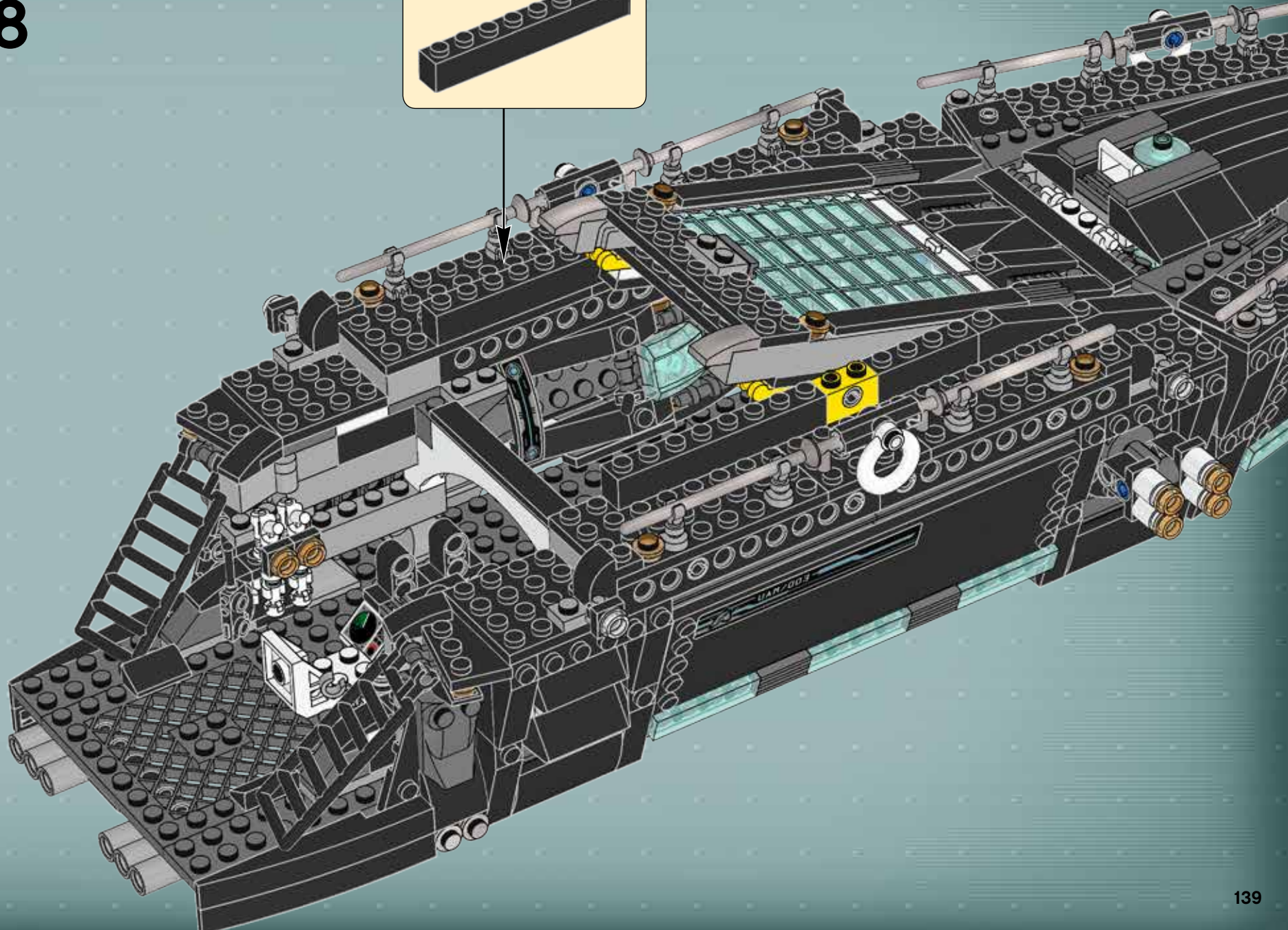
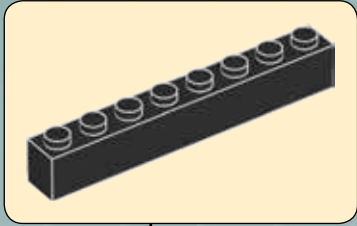

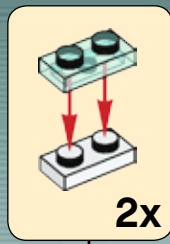
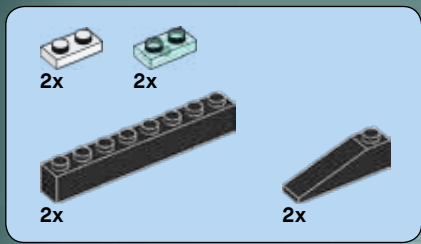

79

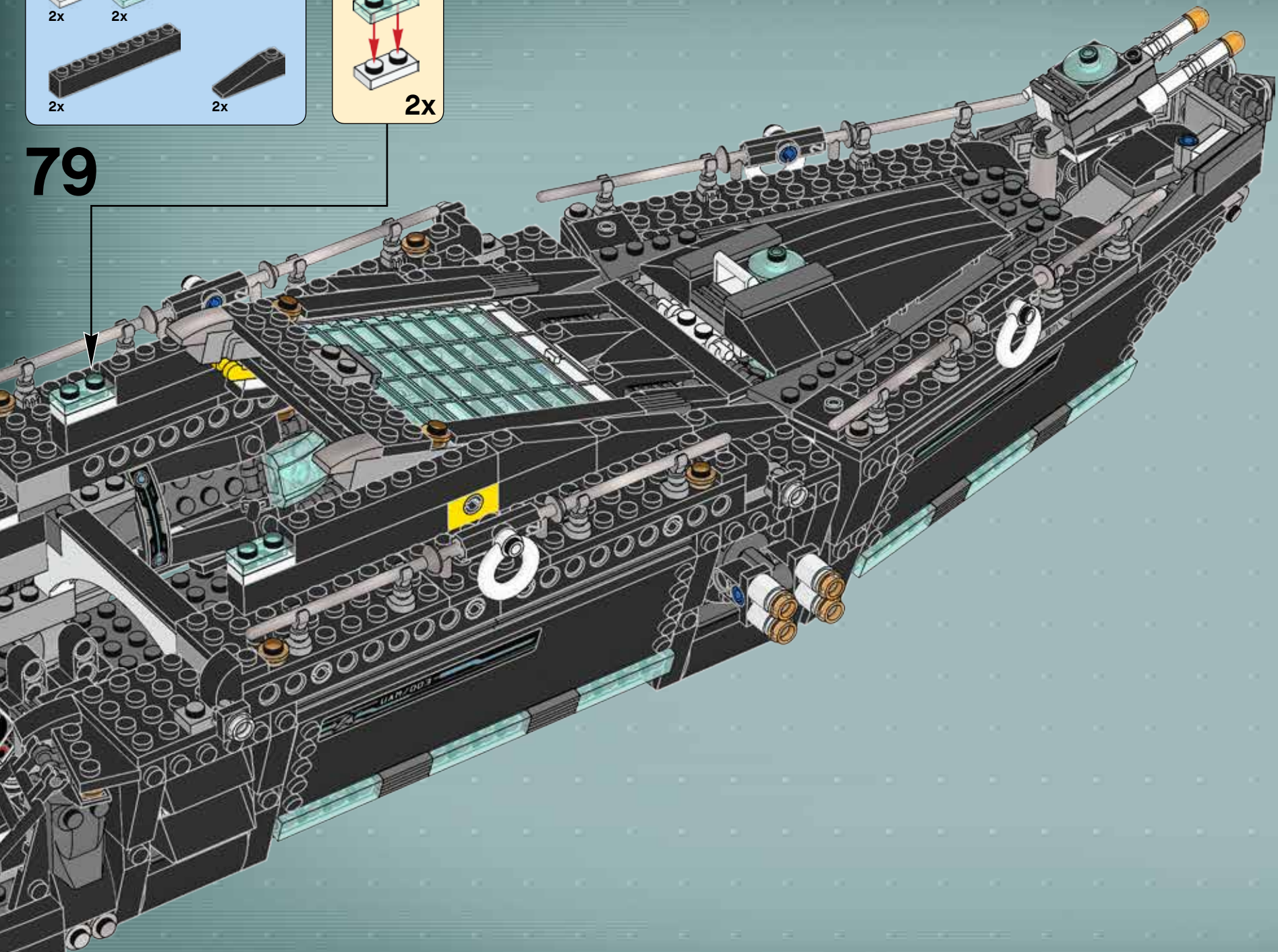

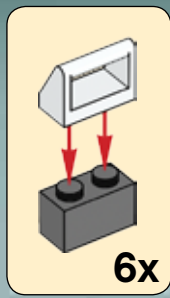
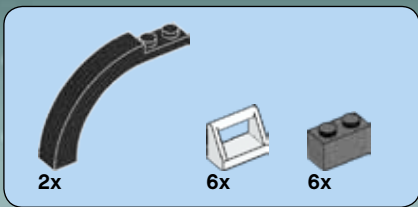

80

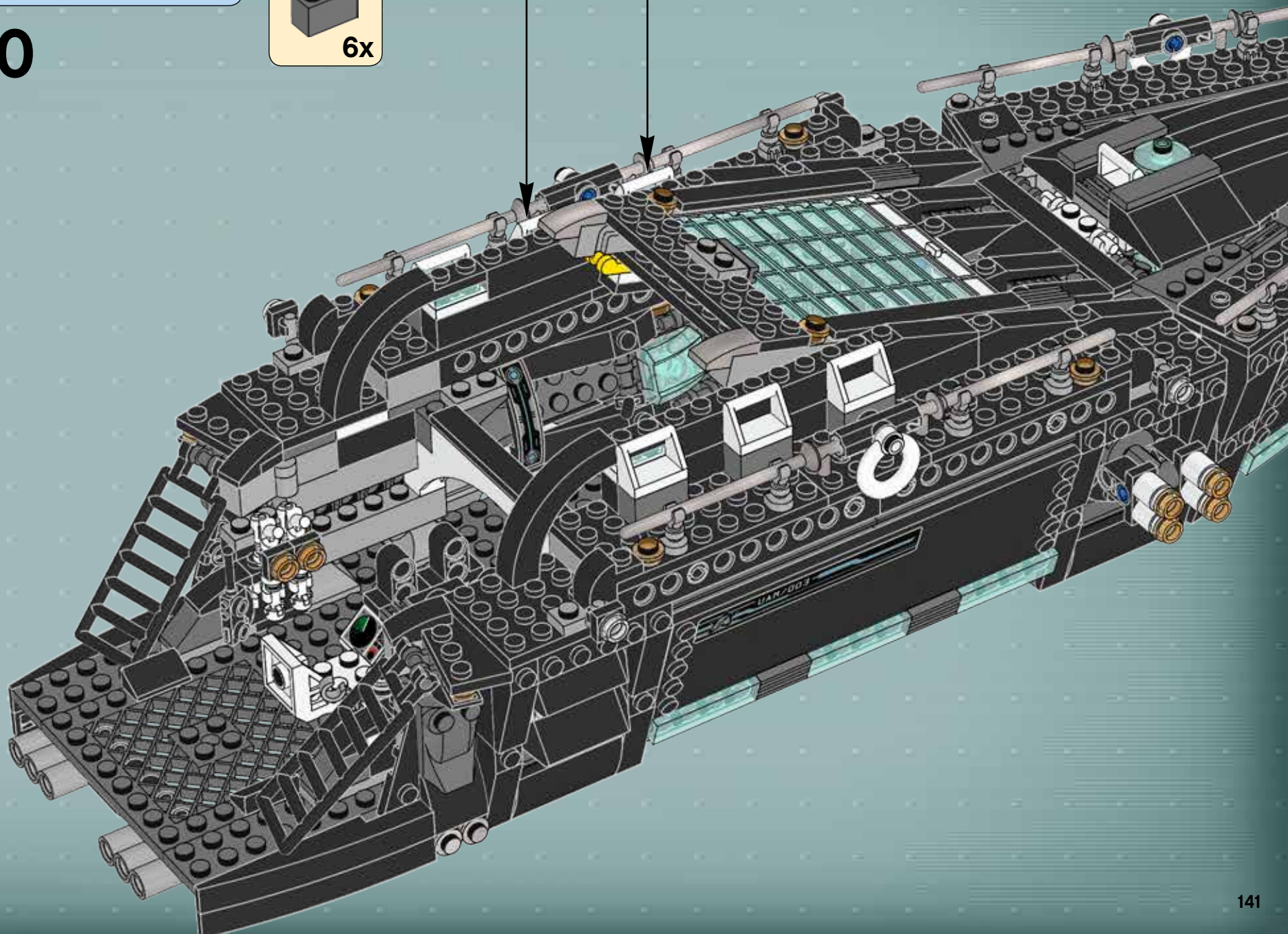

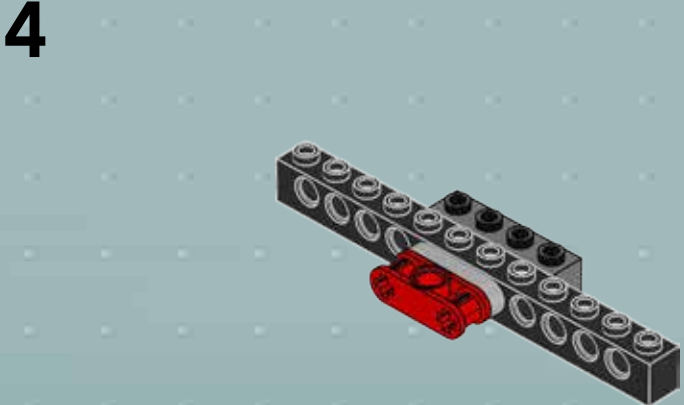
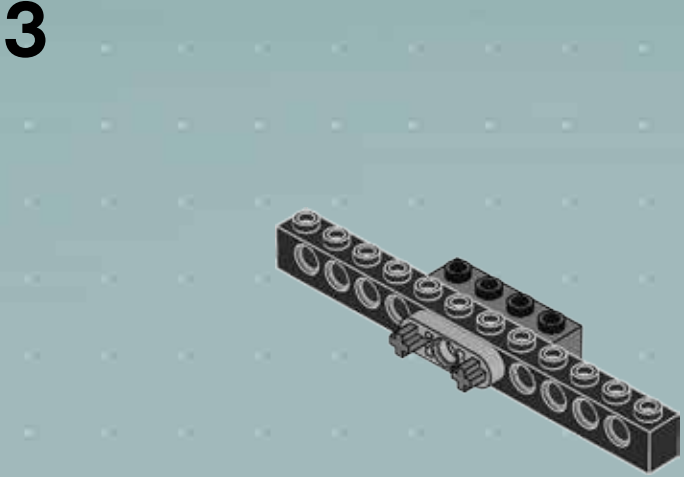
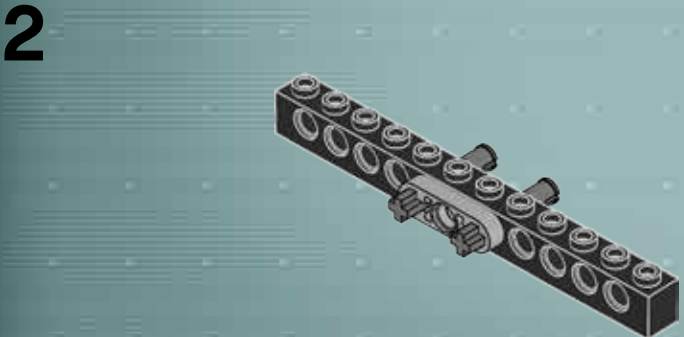
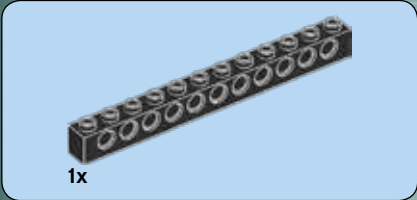
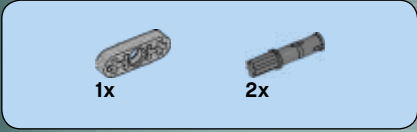
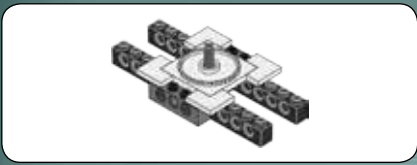

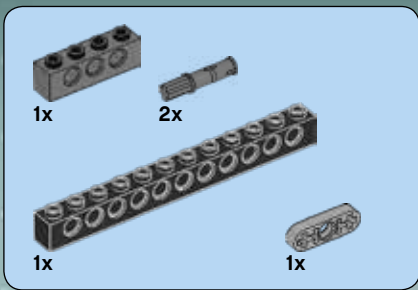

5

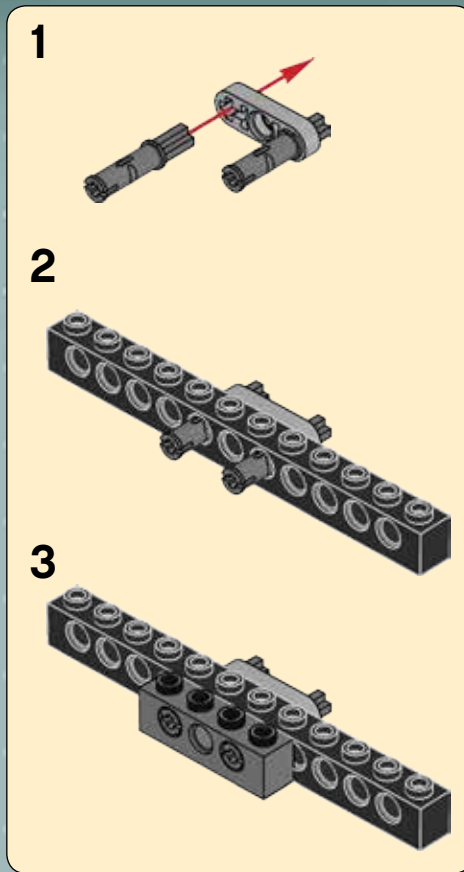
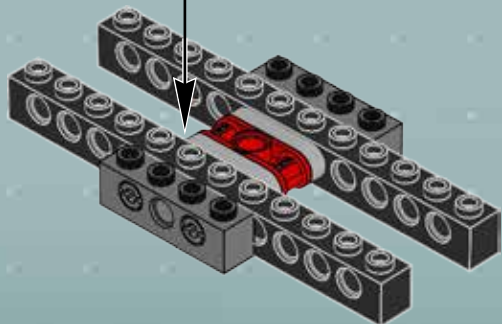

6

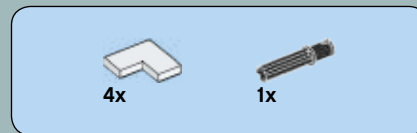
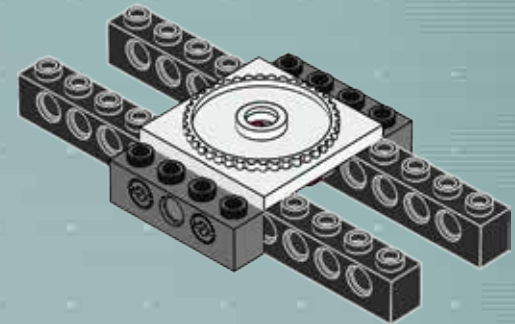

7

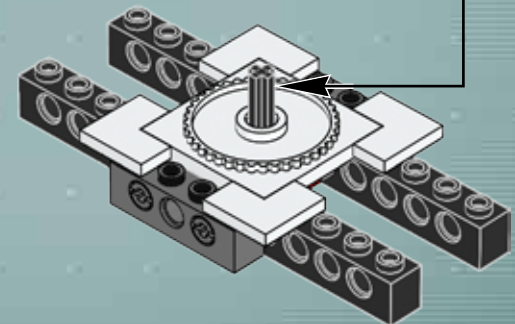
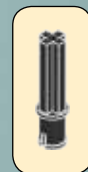

81

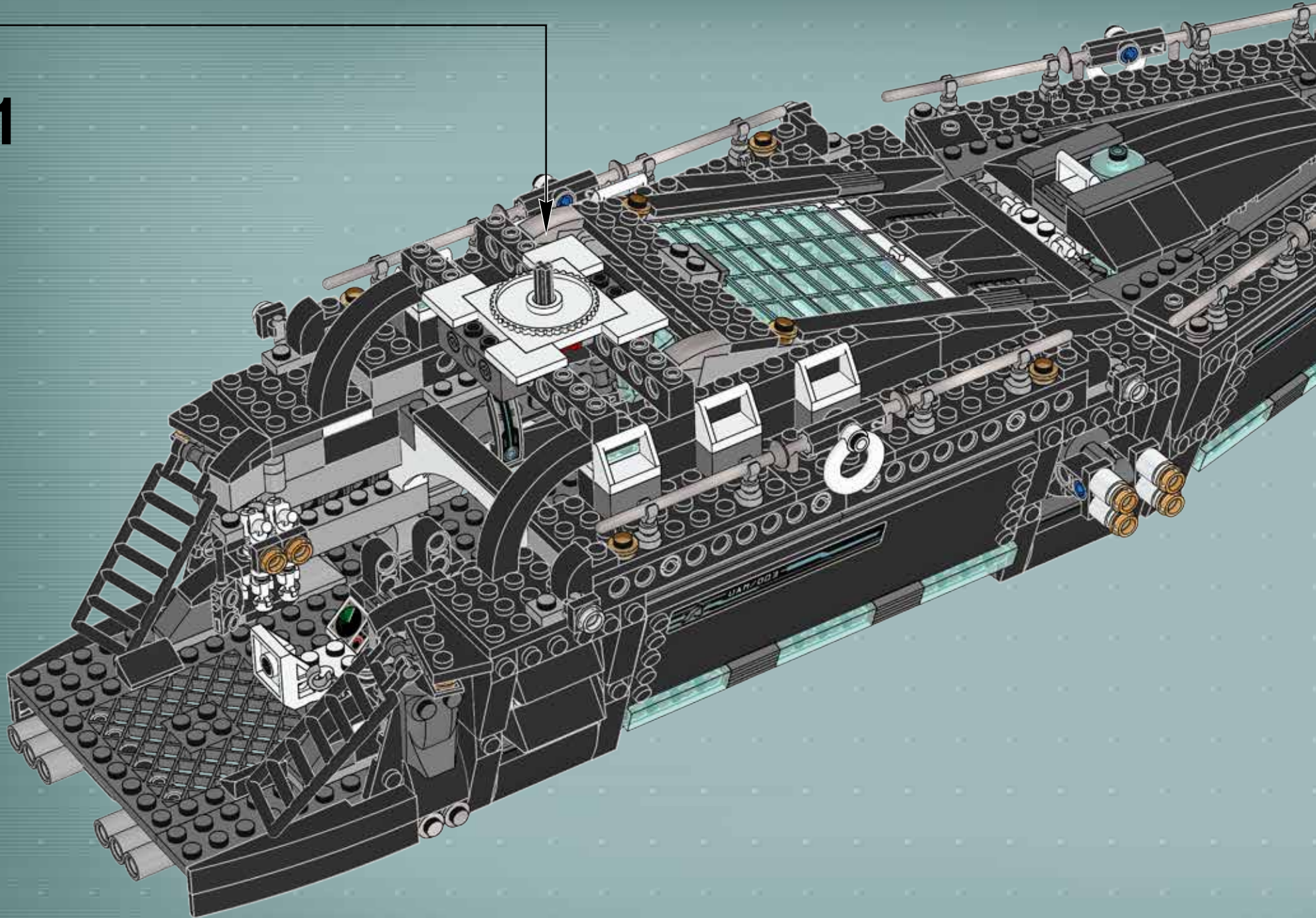





82

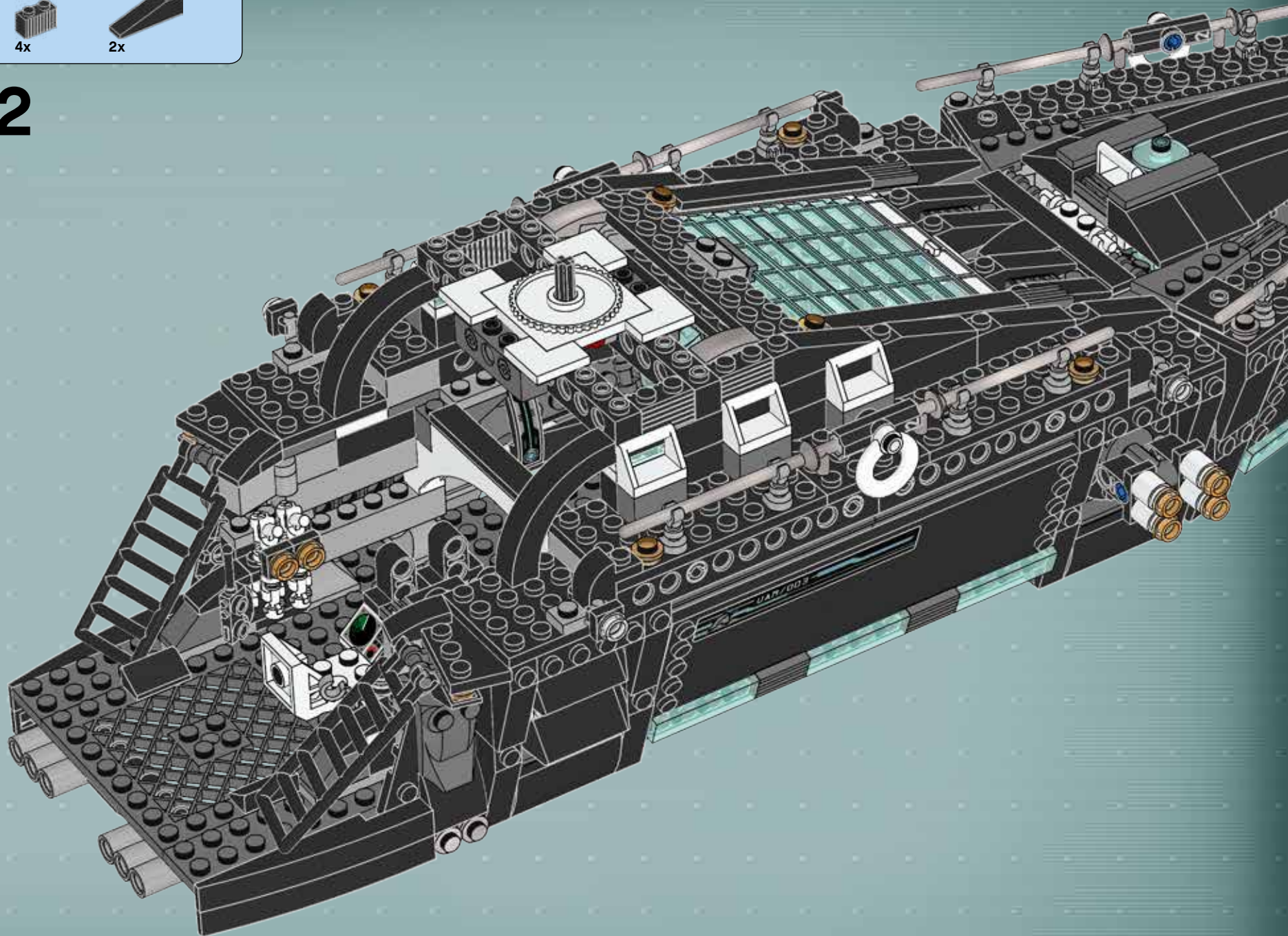

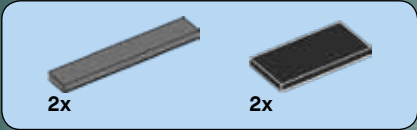

83

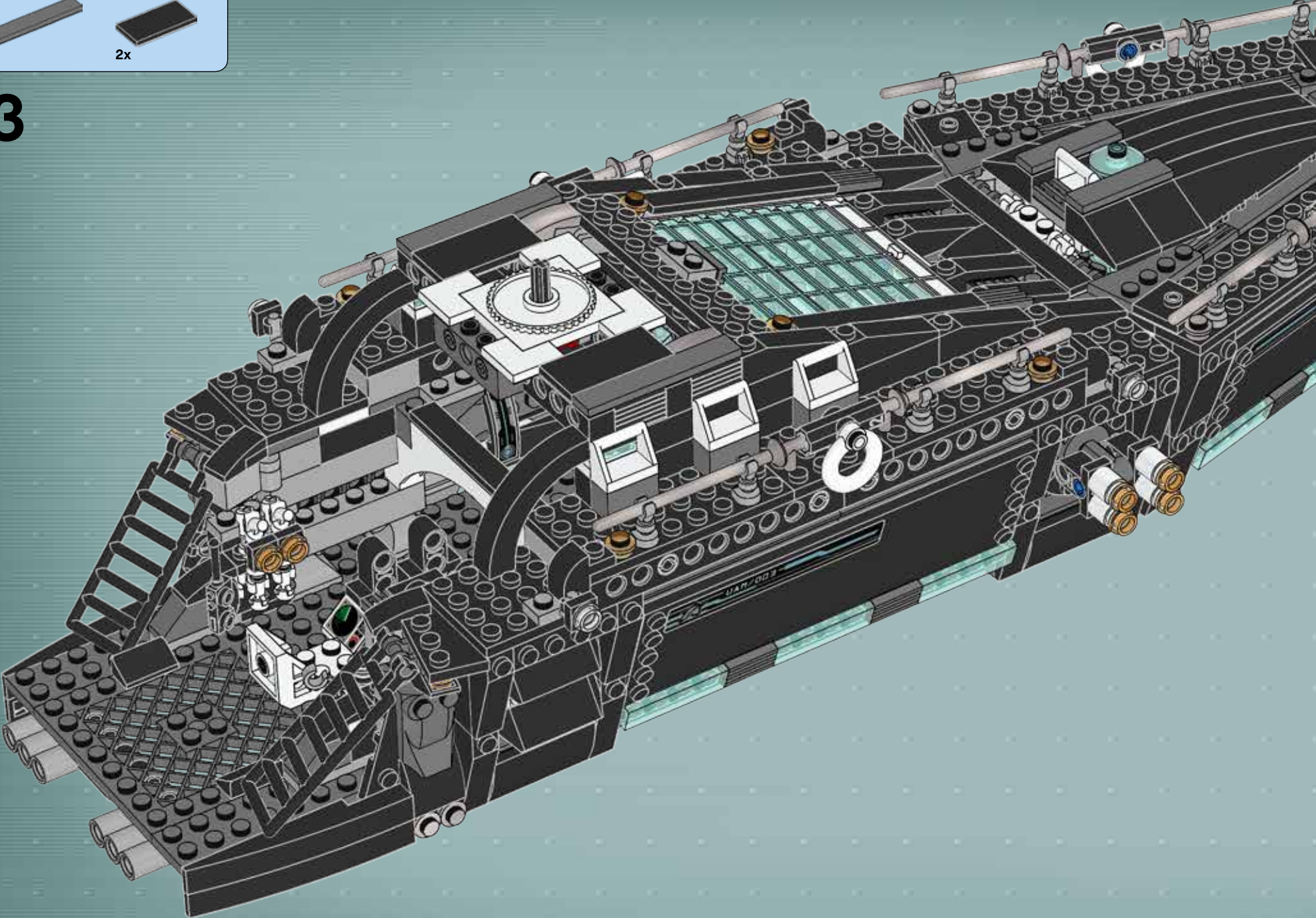

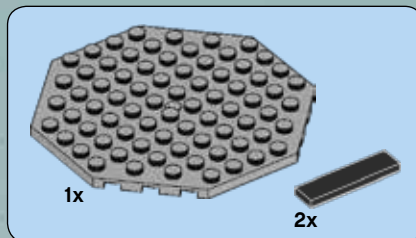
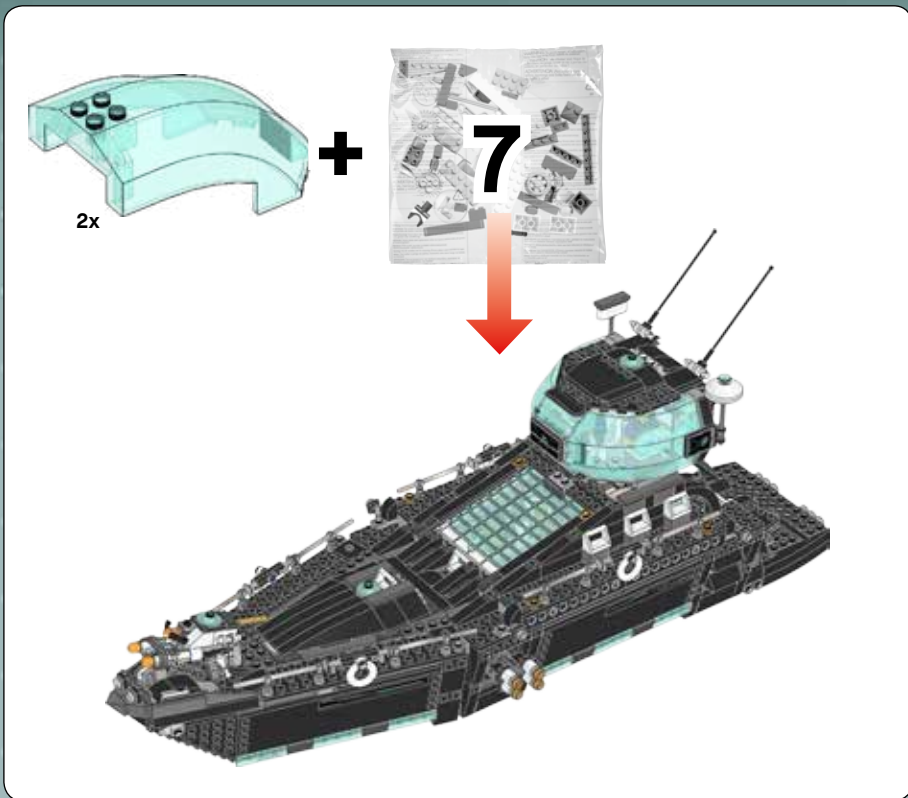

1

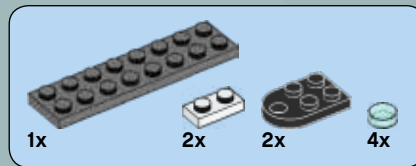
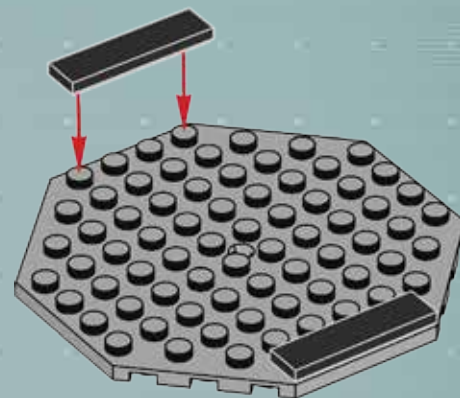

2

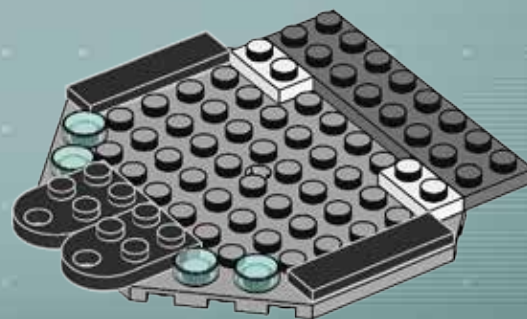

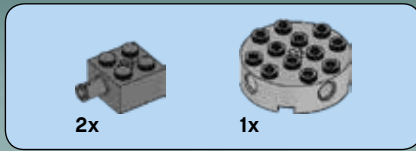
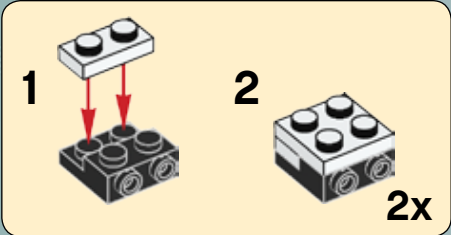
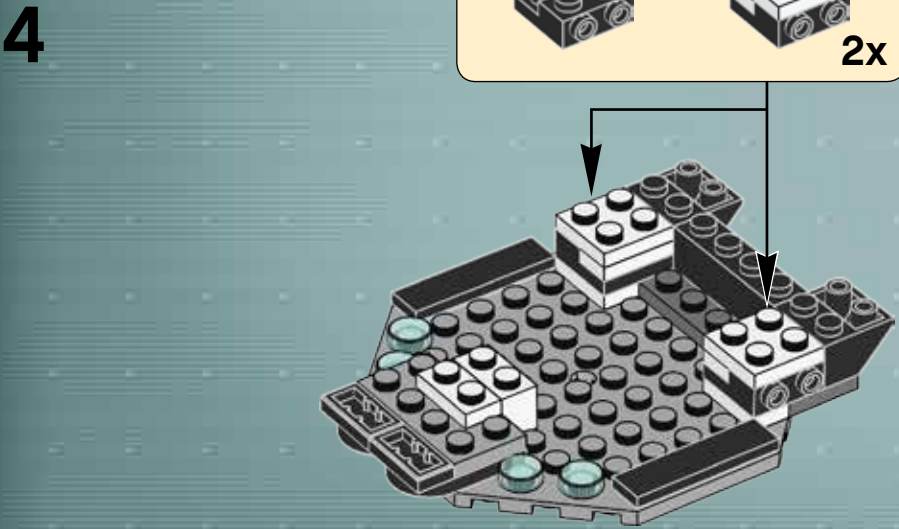
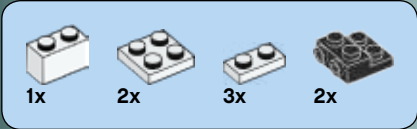
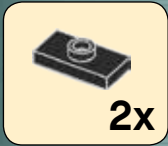
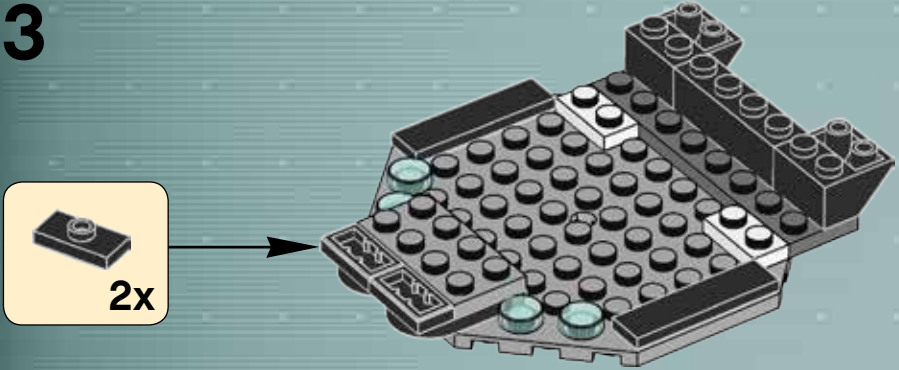
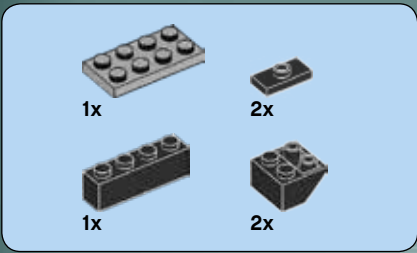

**5**

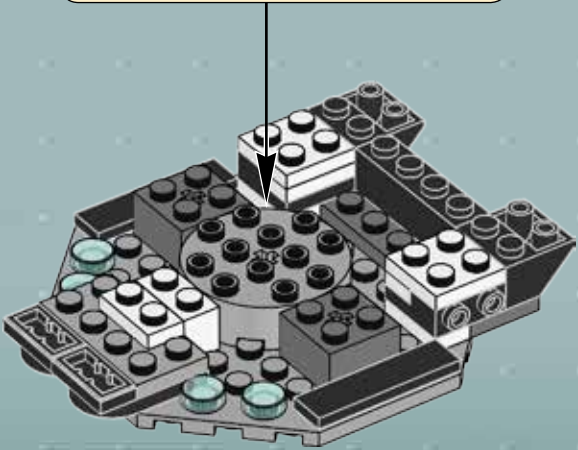
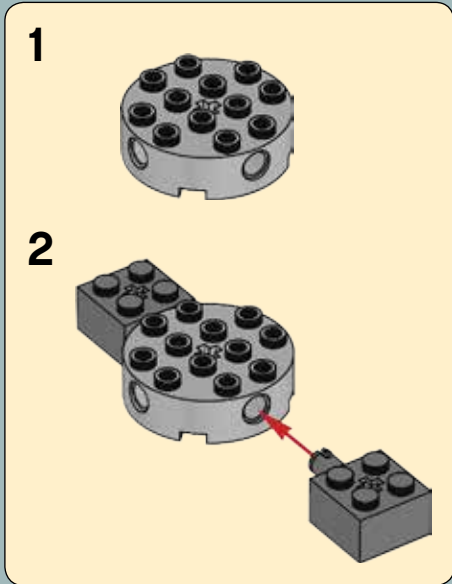

84

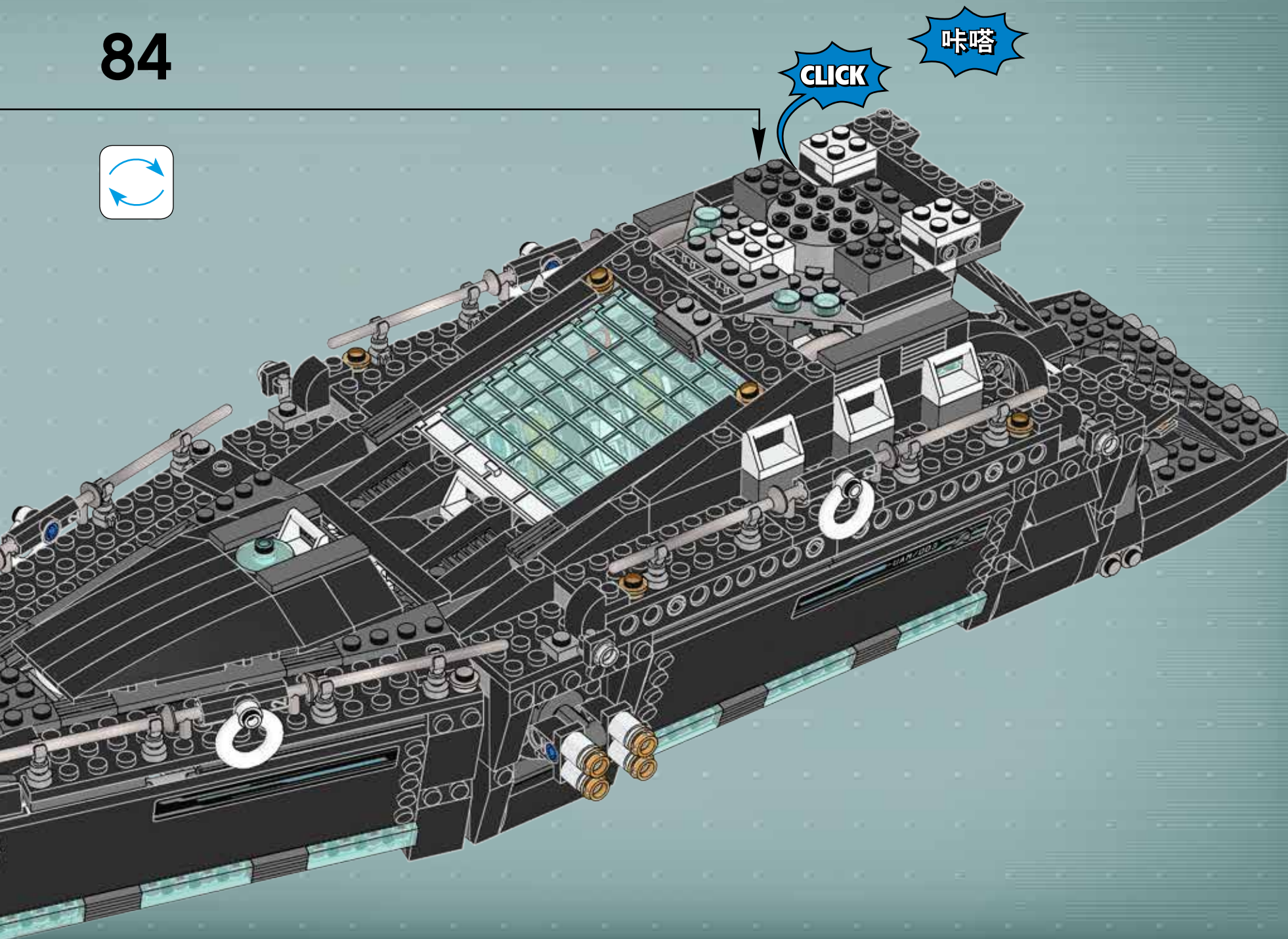

CLICK

咔嗒

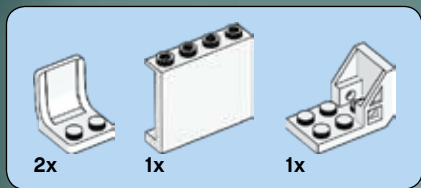

85

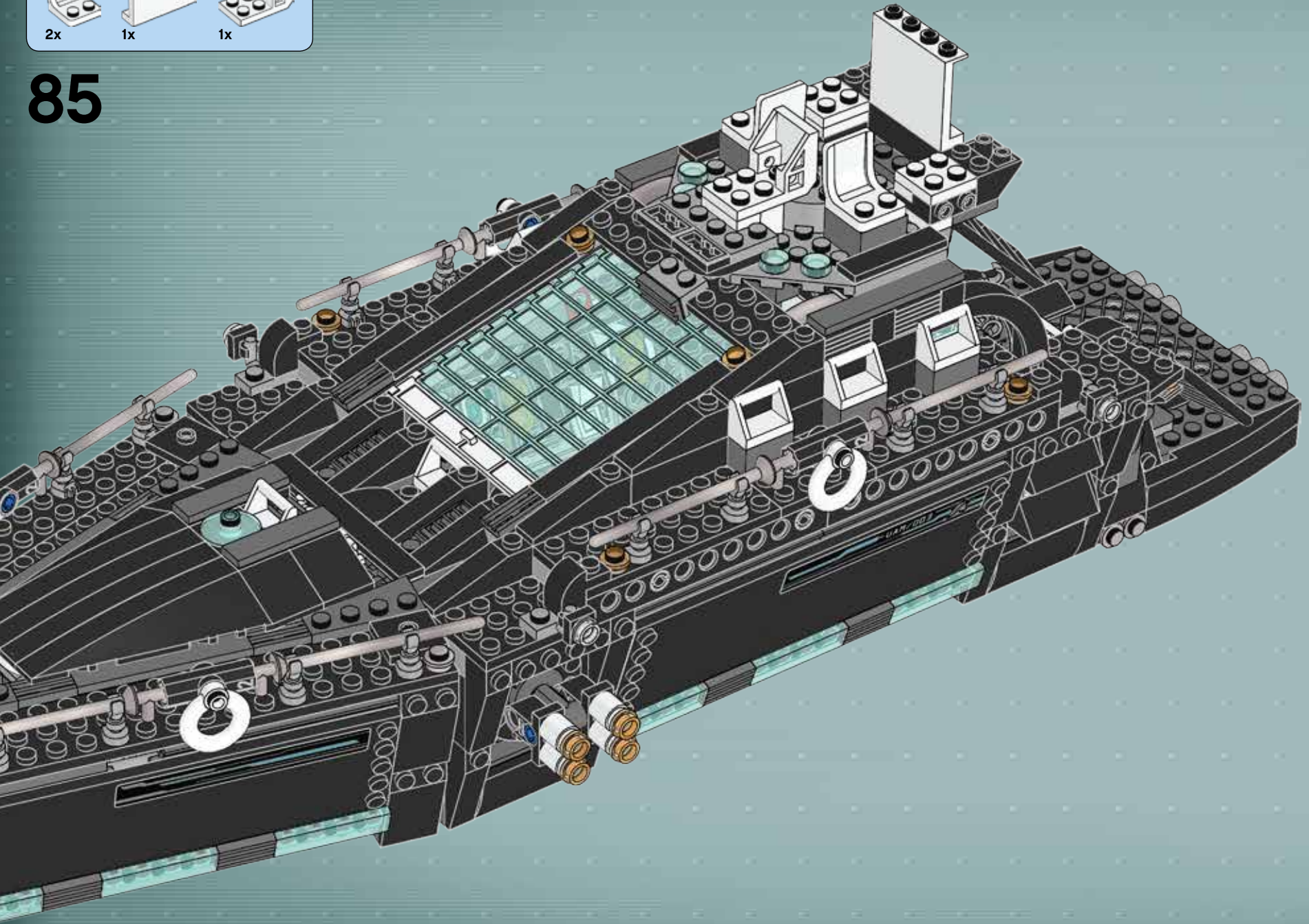

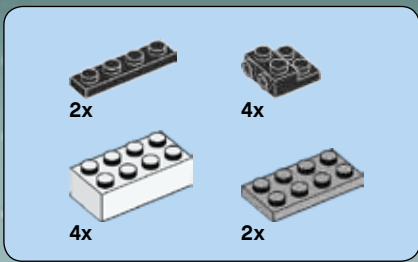

86

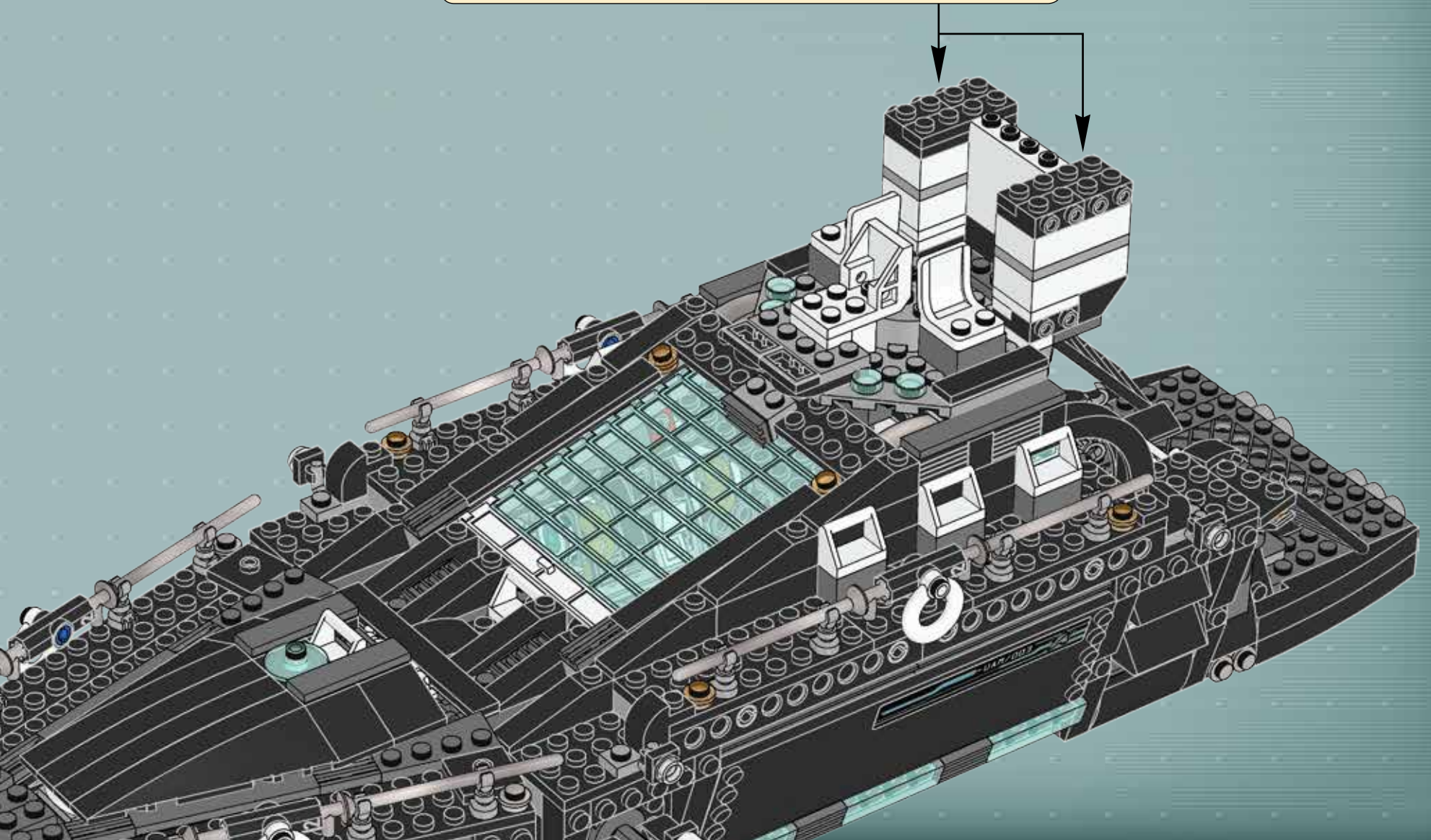
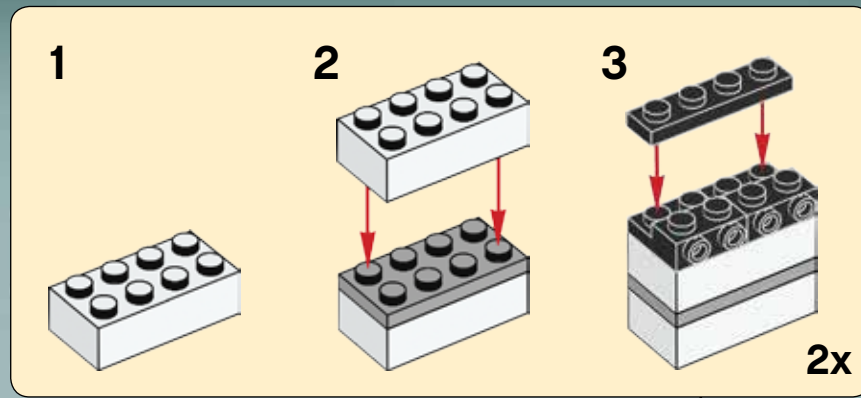

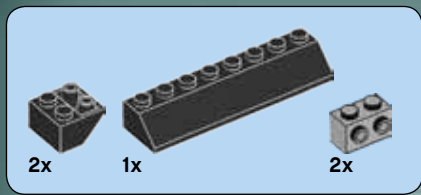

87

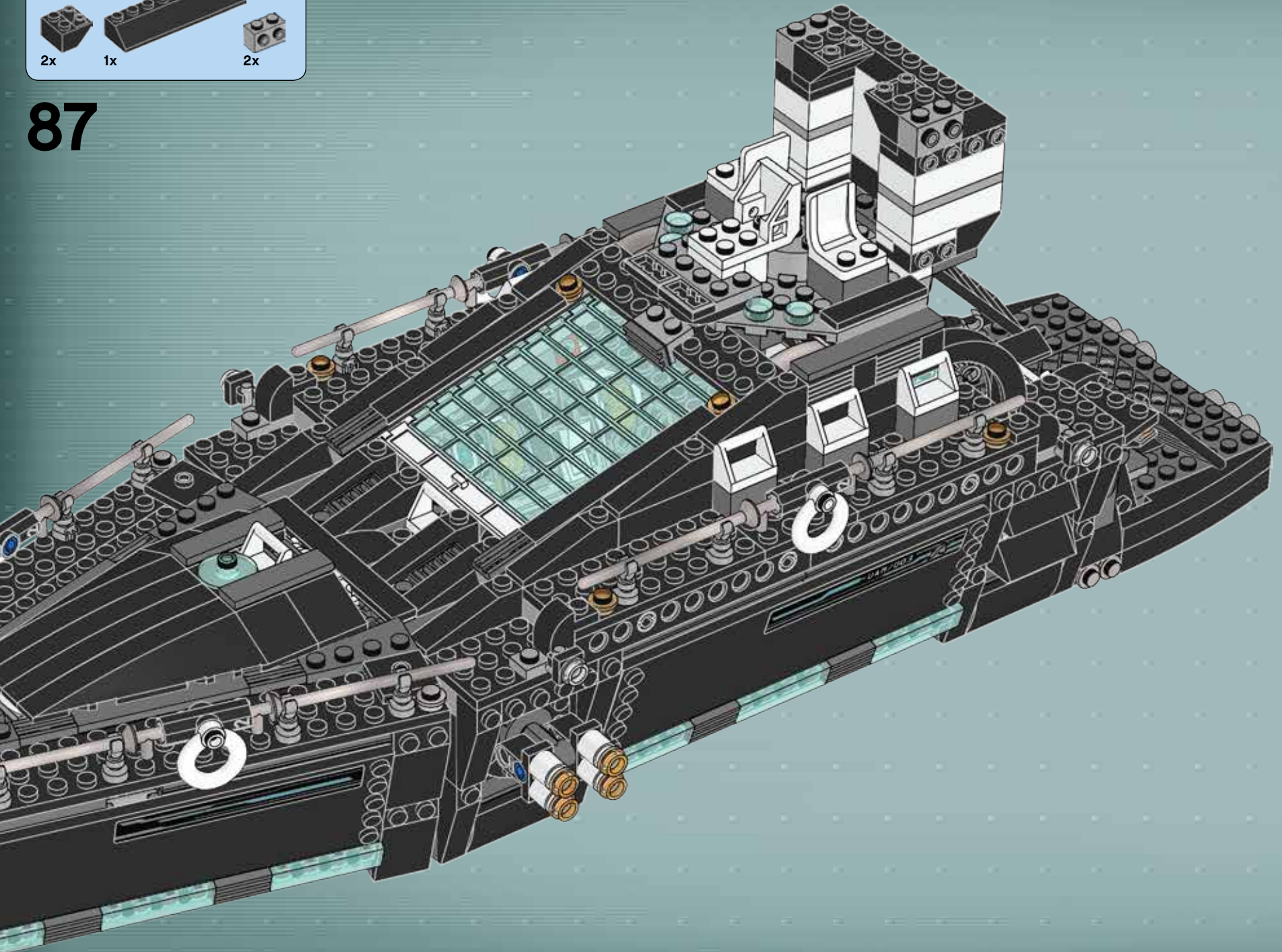



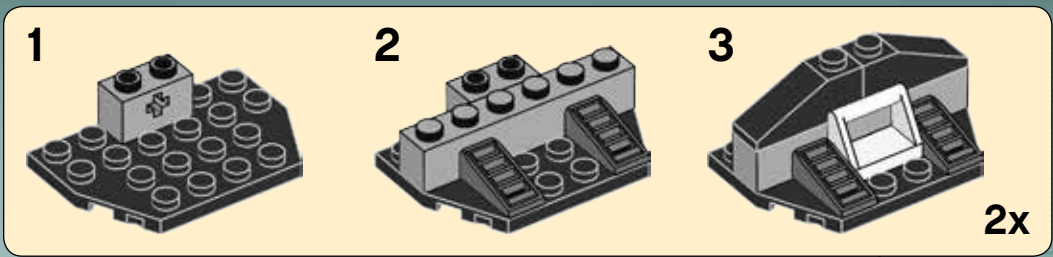
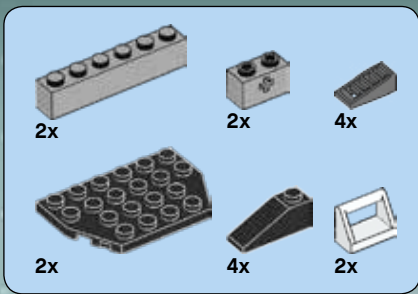

88

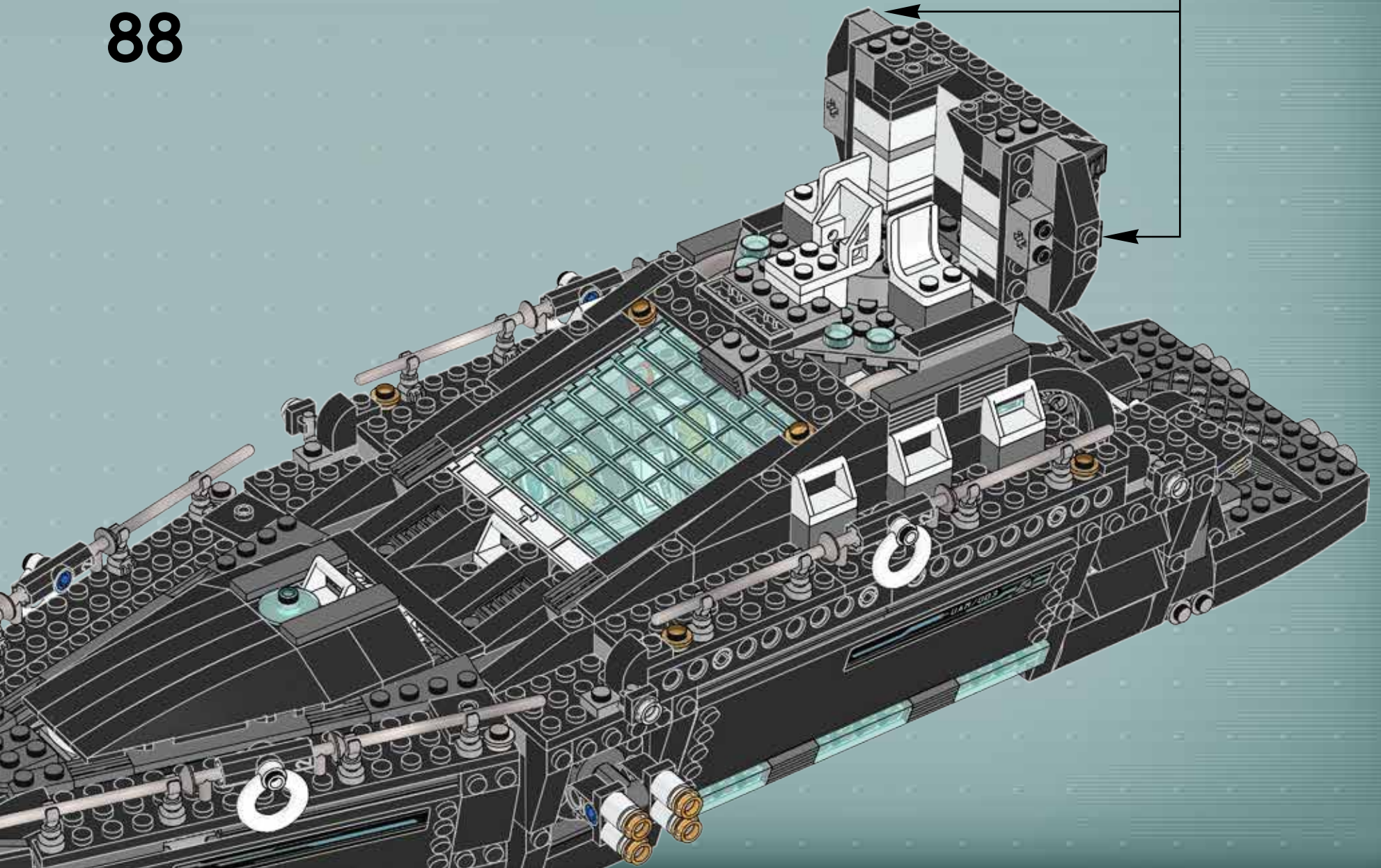

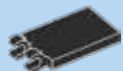

2x

89

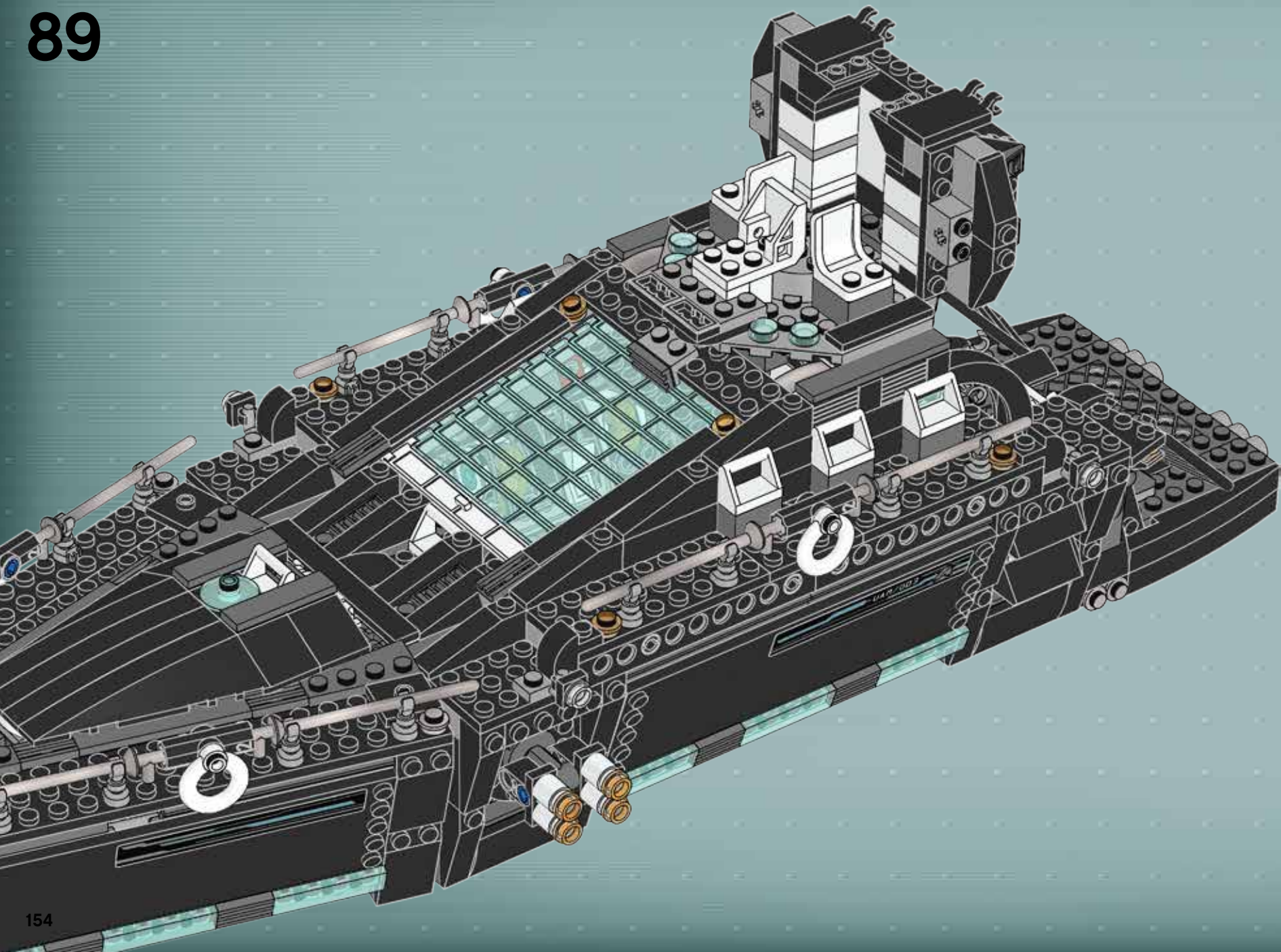

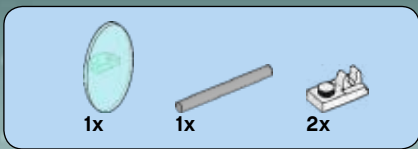

90

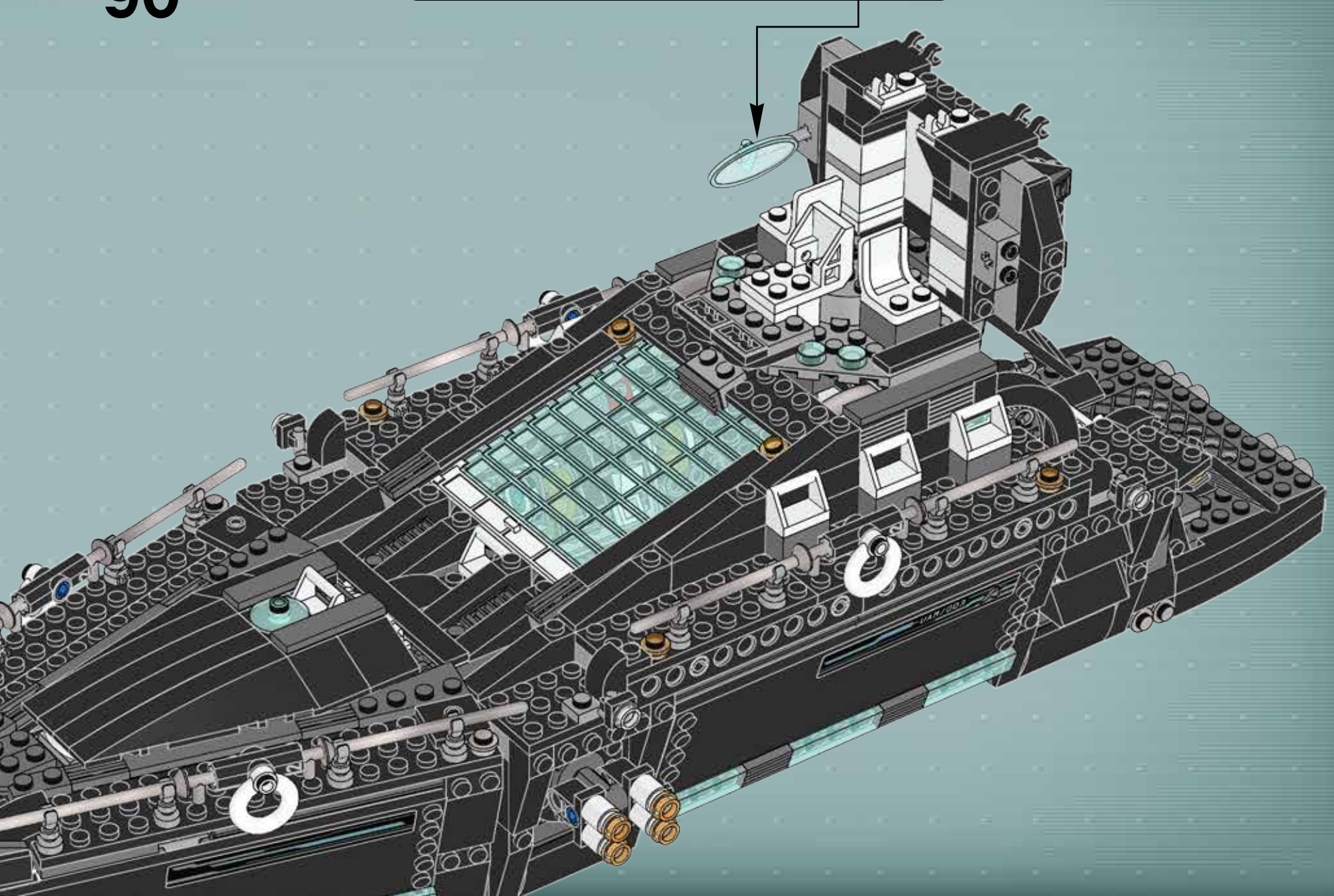
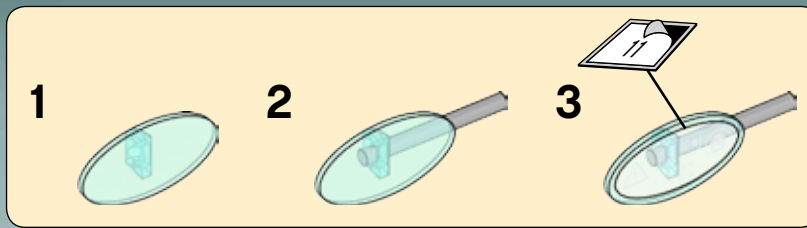

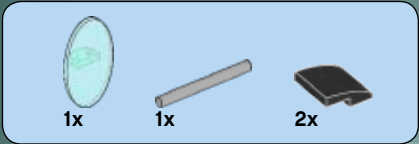

91

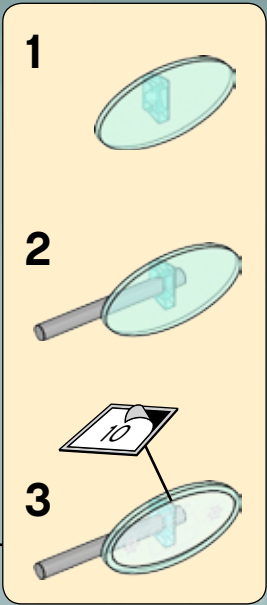
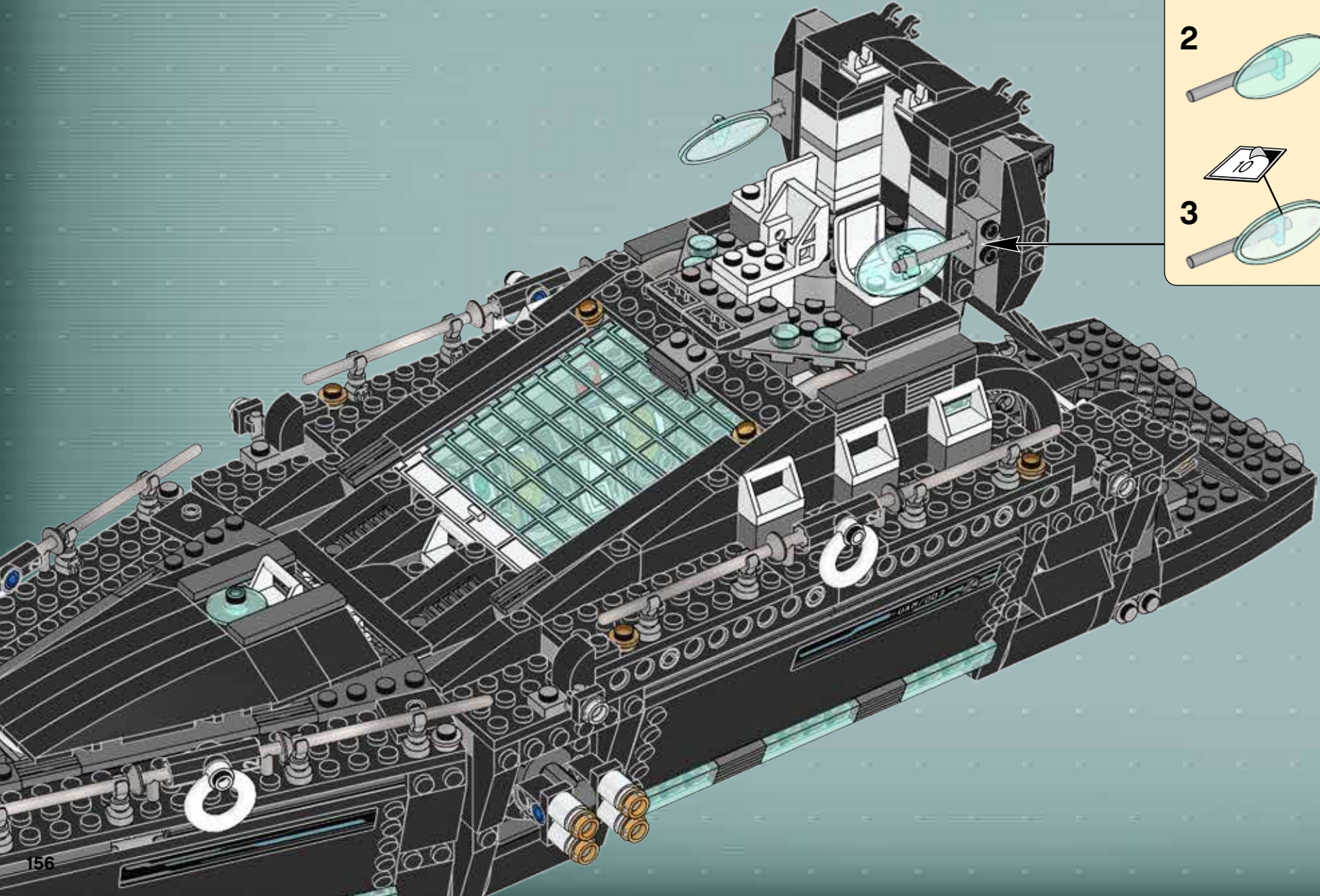

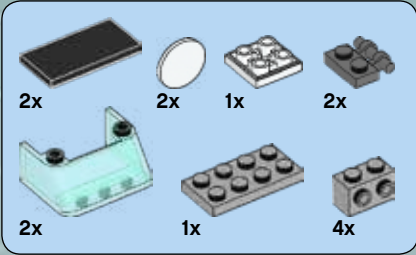

92

1



2

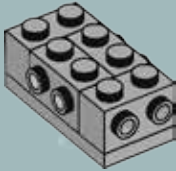

3

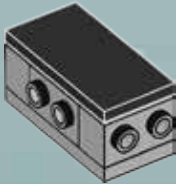

4

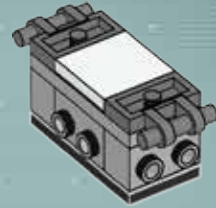
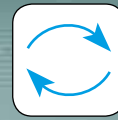

5

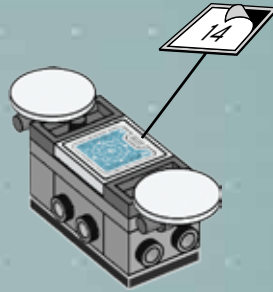

6

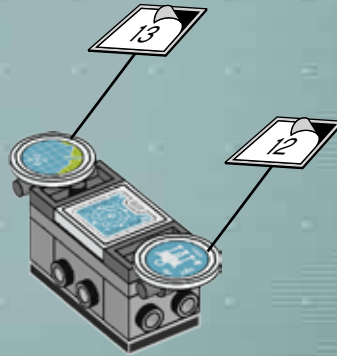

7



8

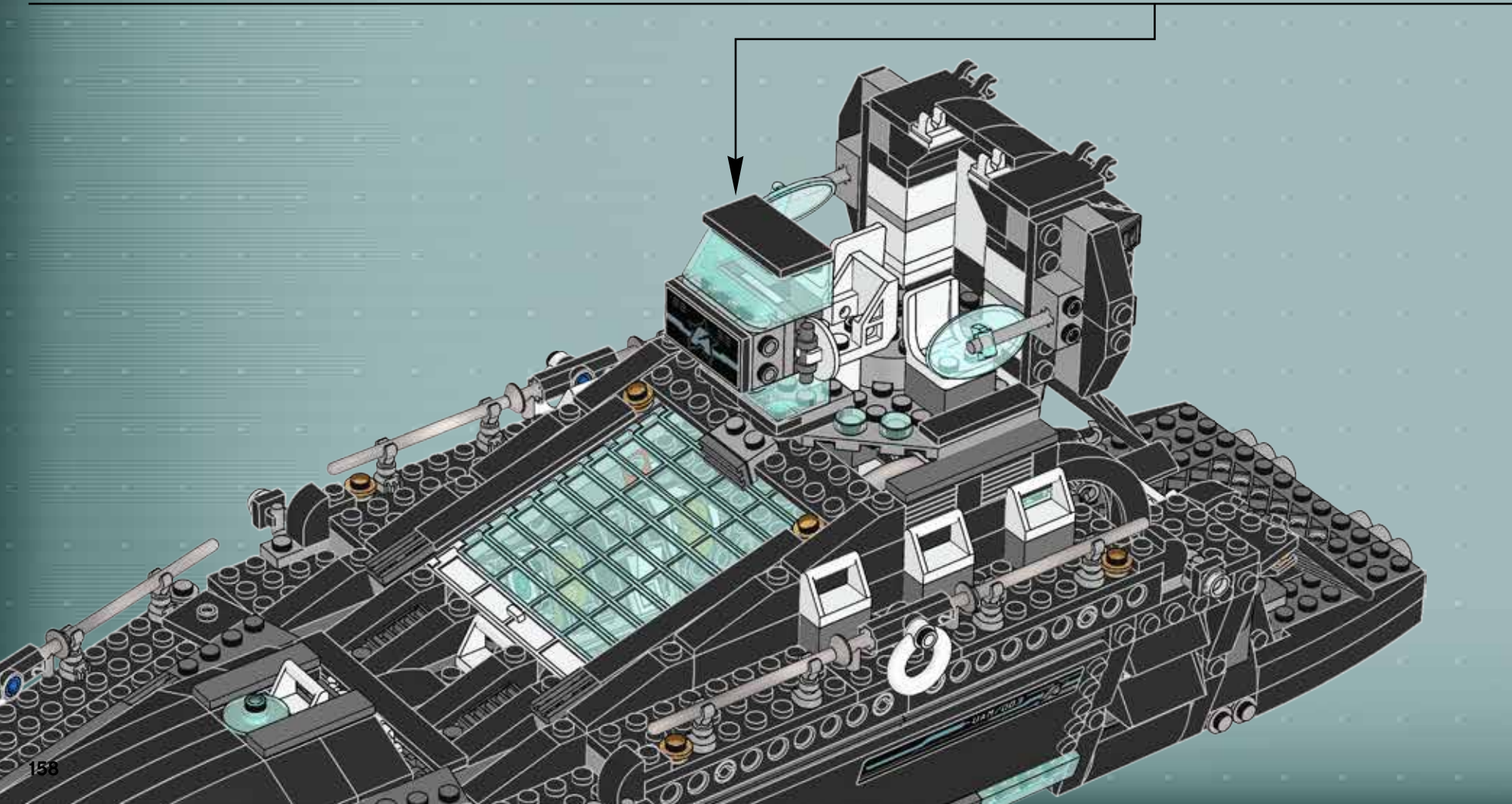
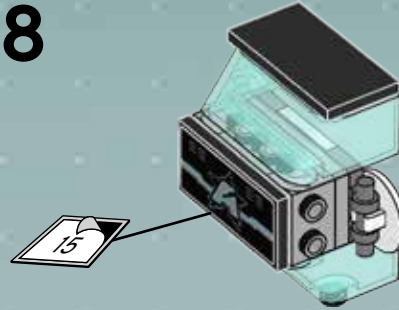
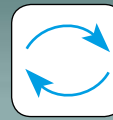

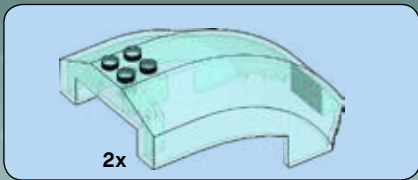

93

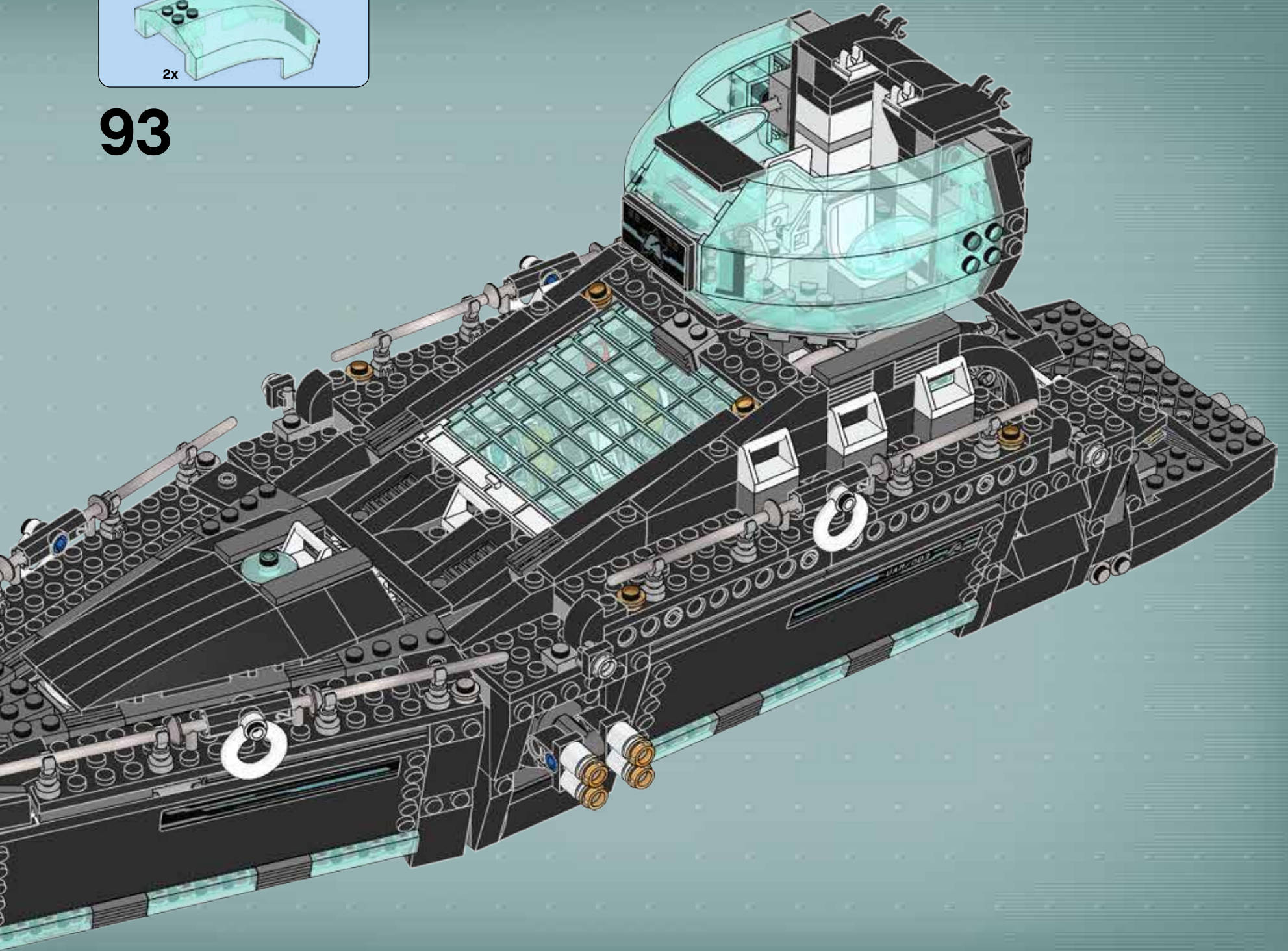

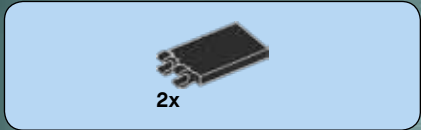

94

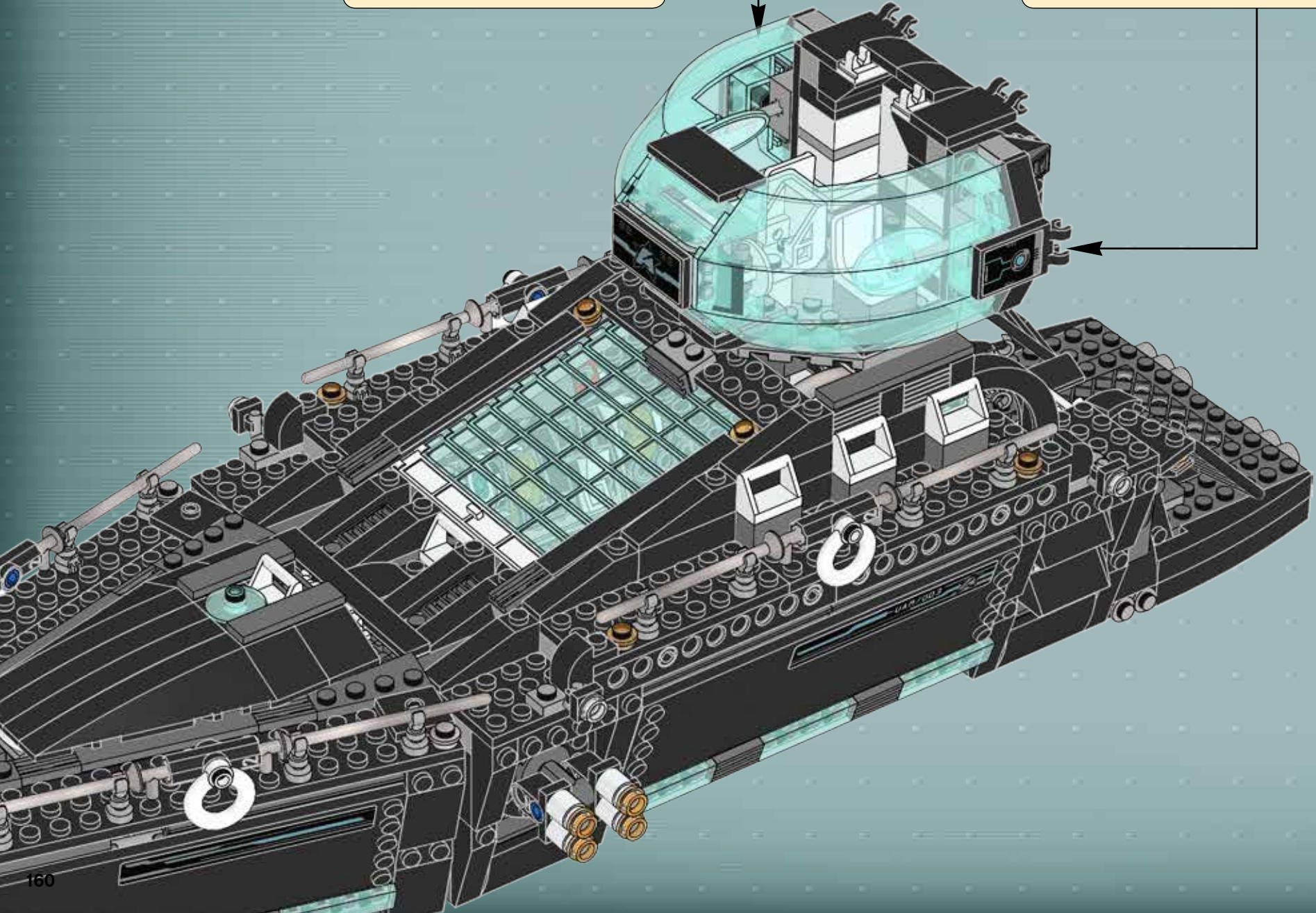
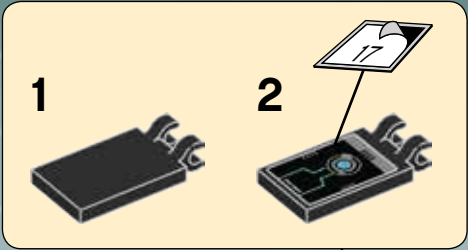
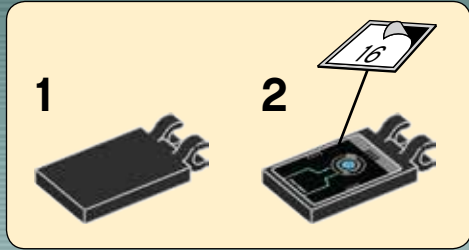





96

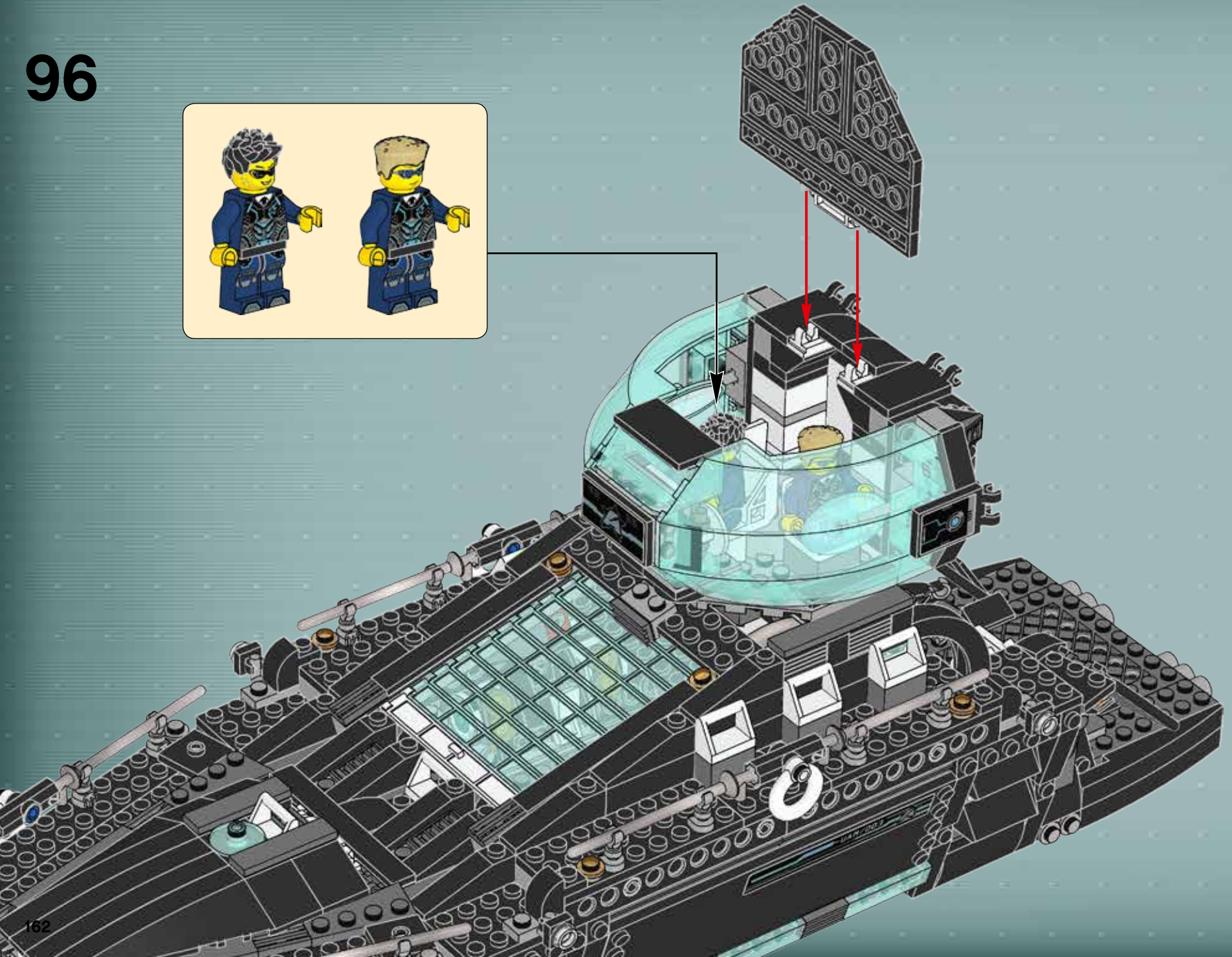

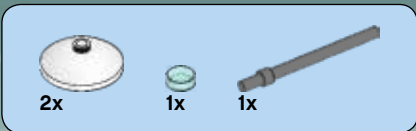

# 97

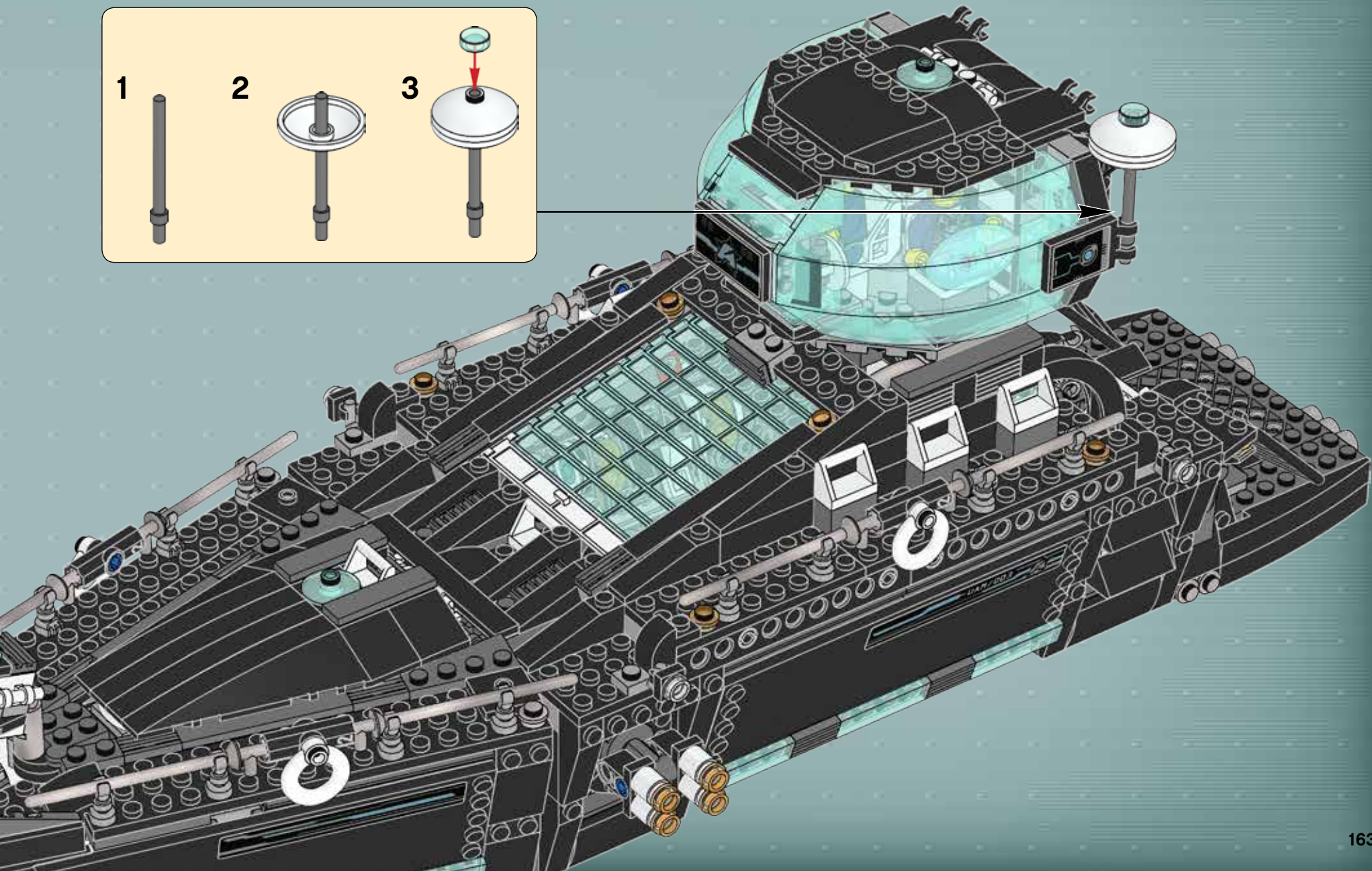
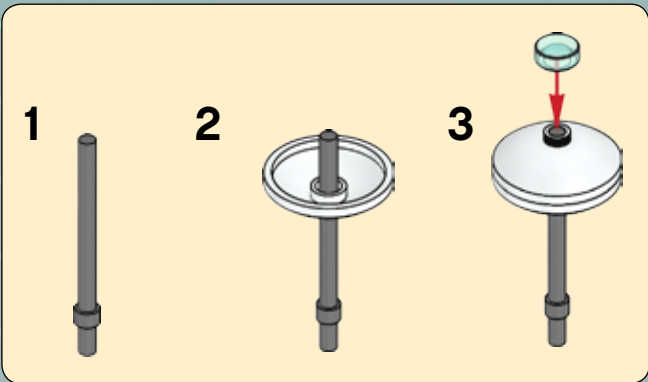

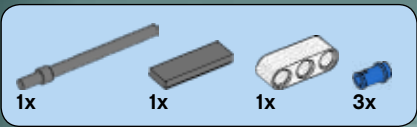

# 98

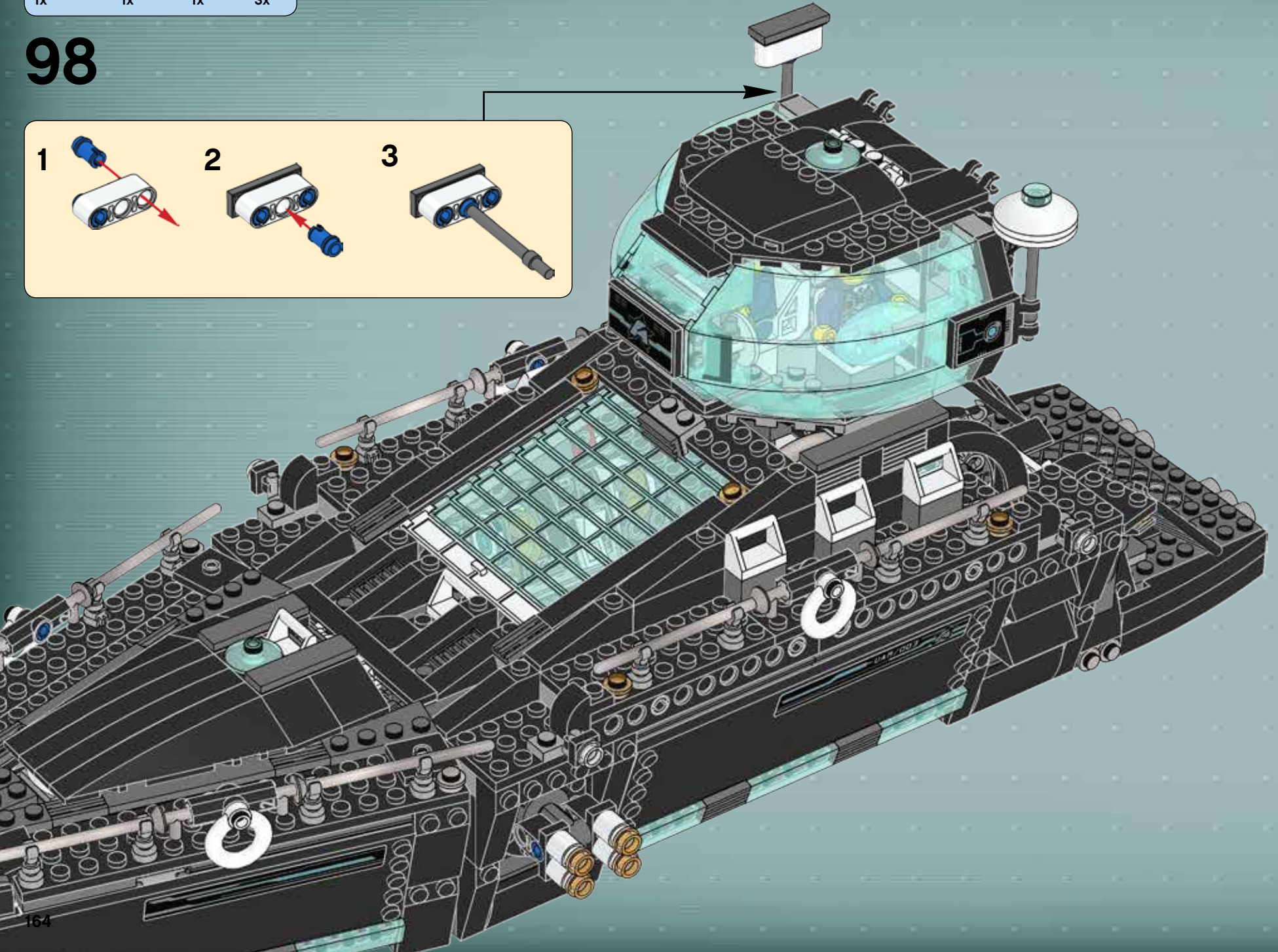
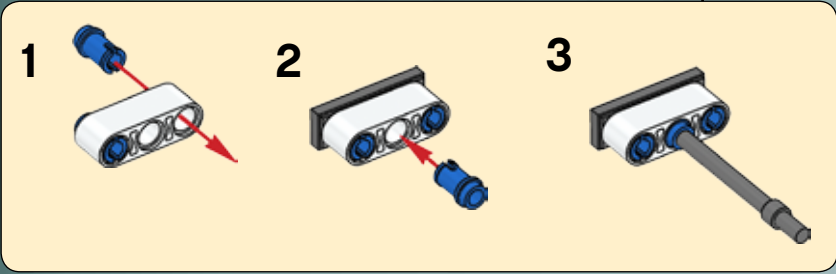

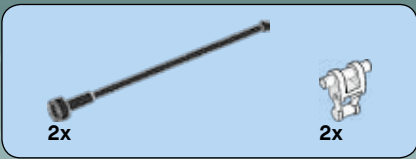

99

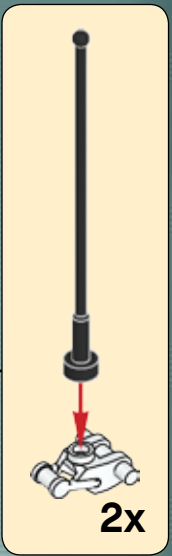
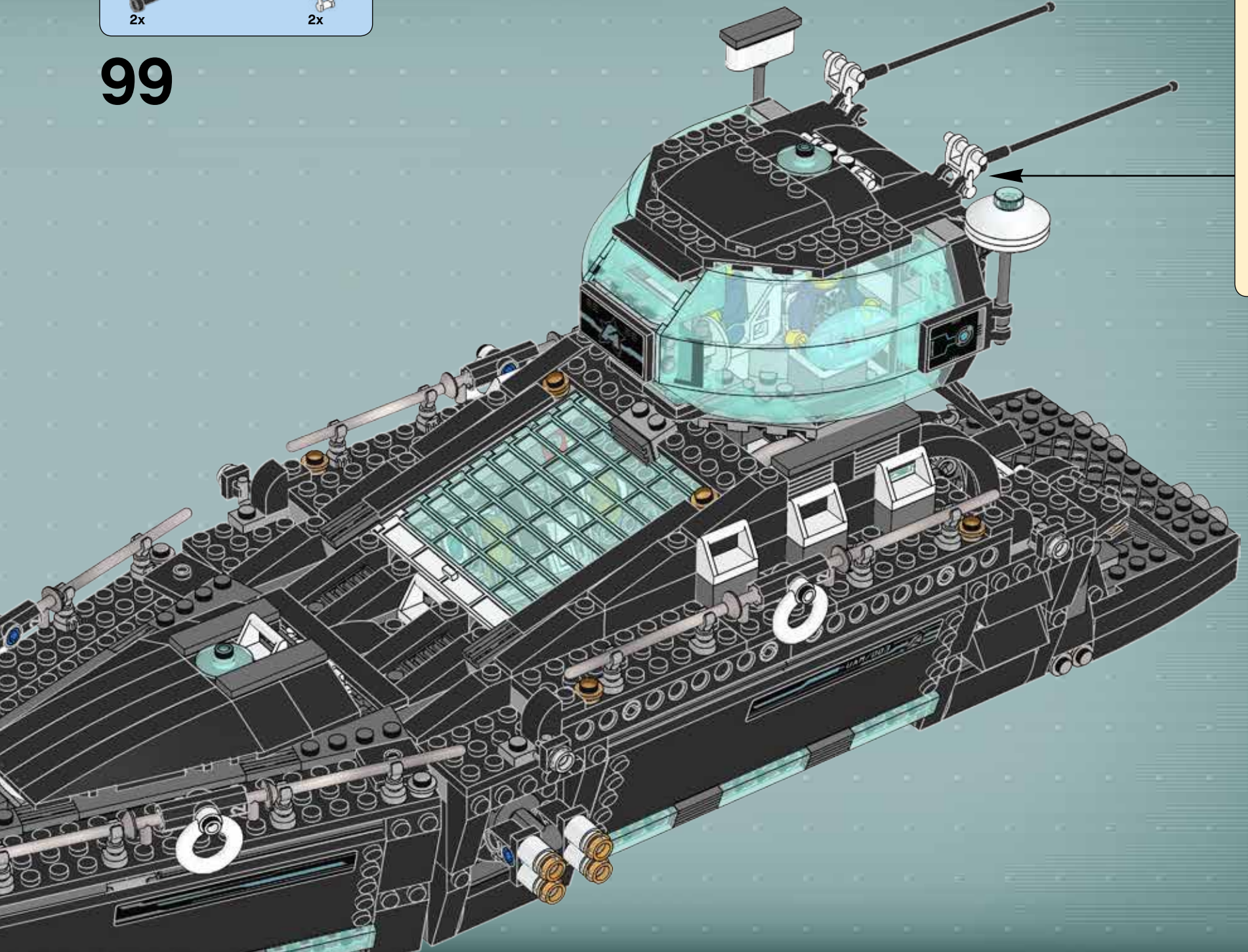

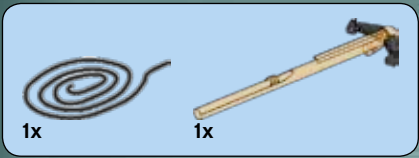

100

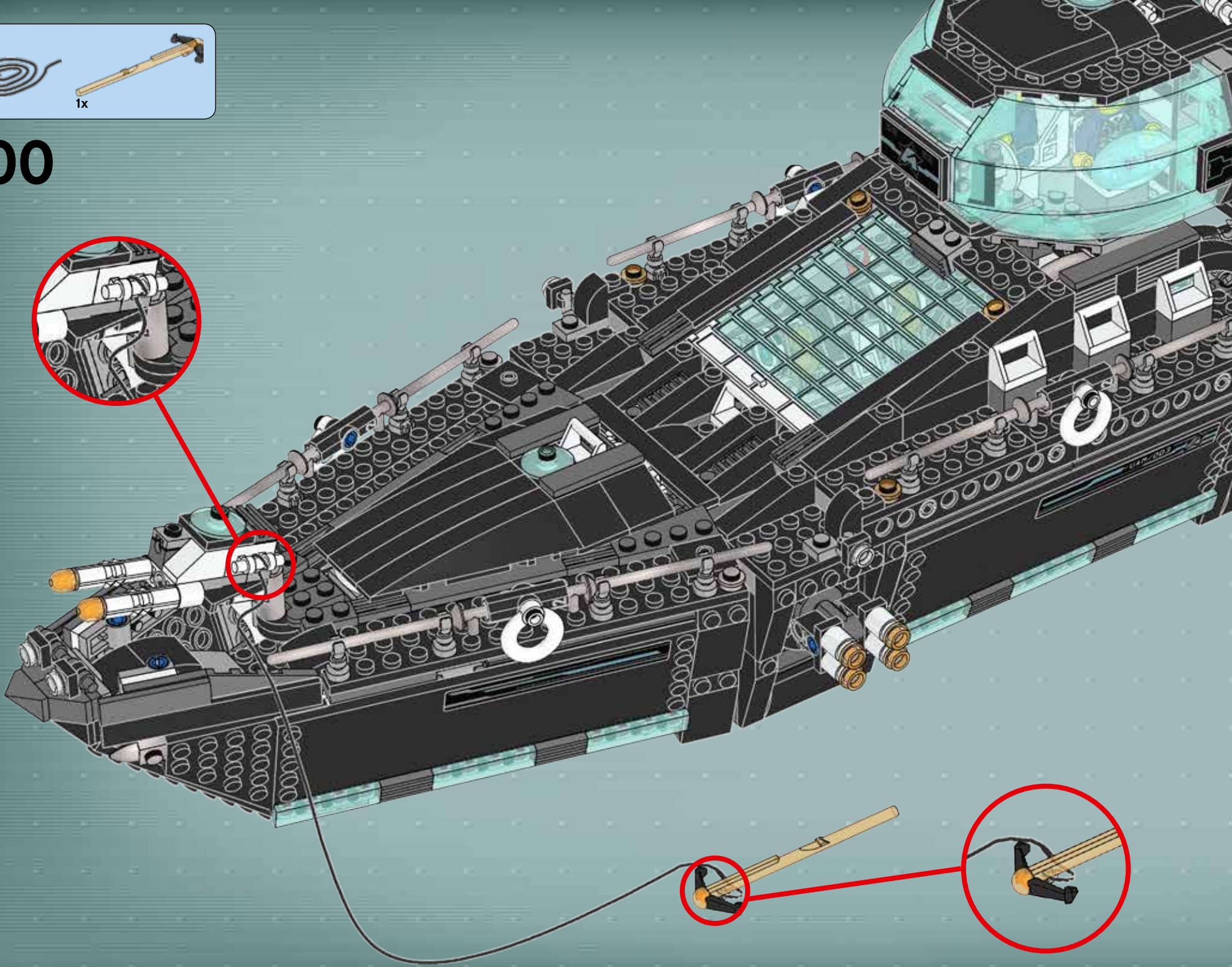

101

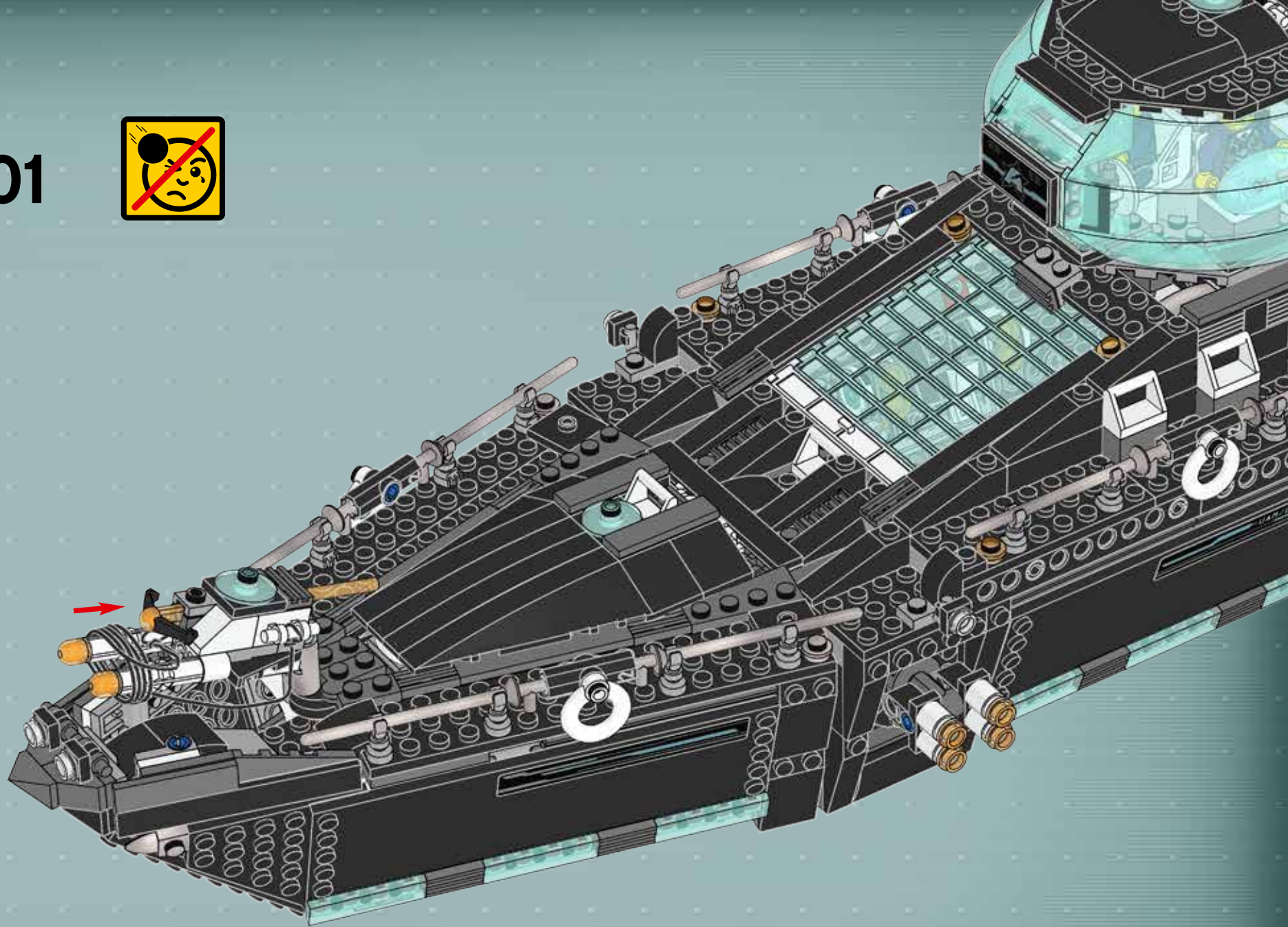



12x



# 102

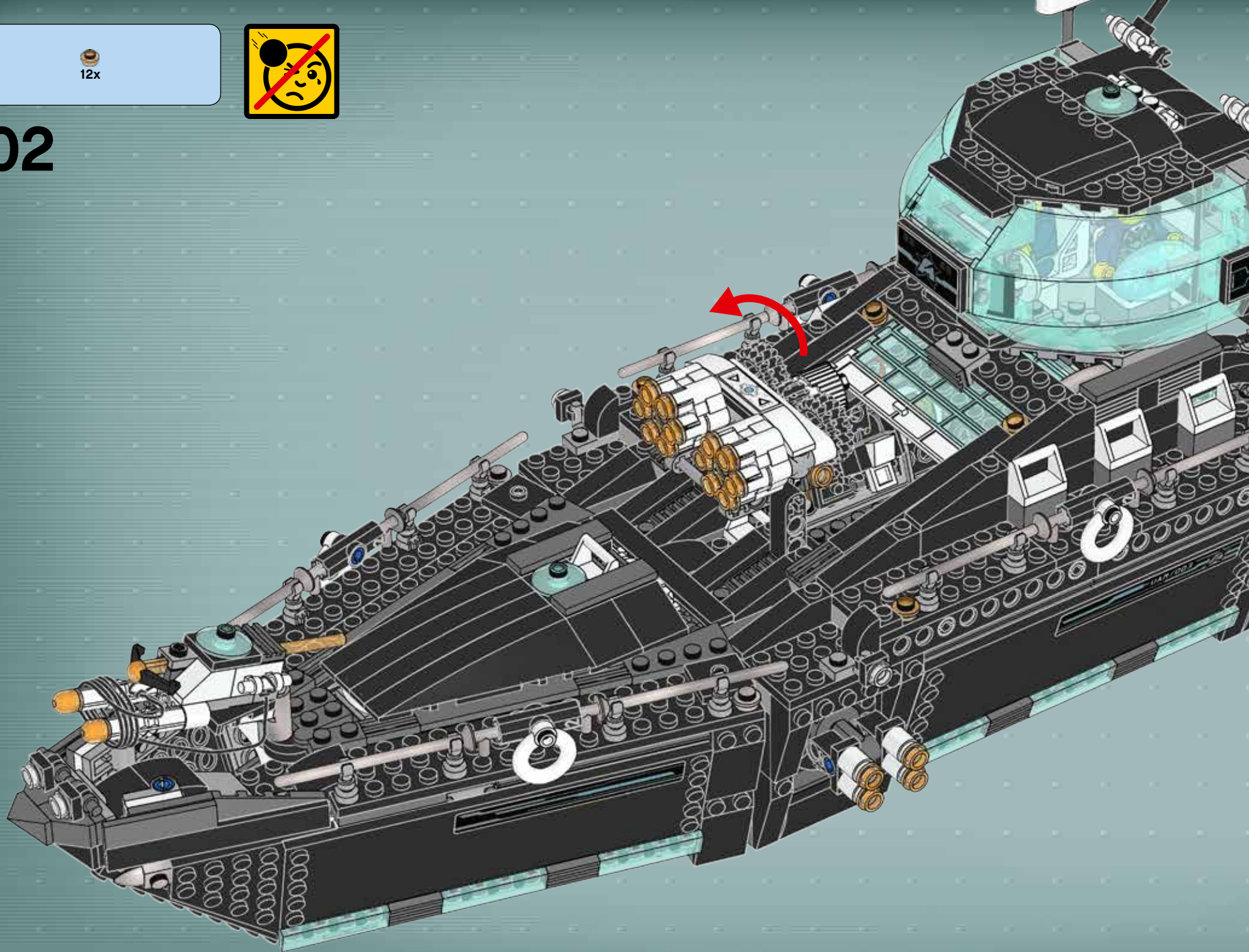



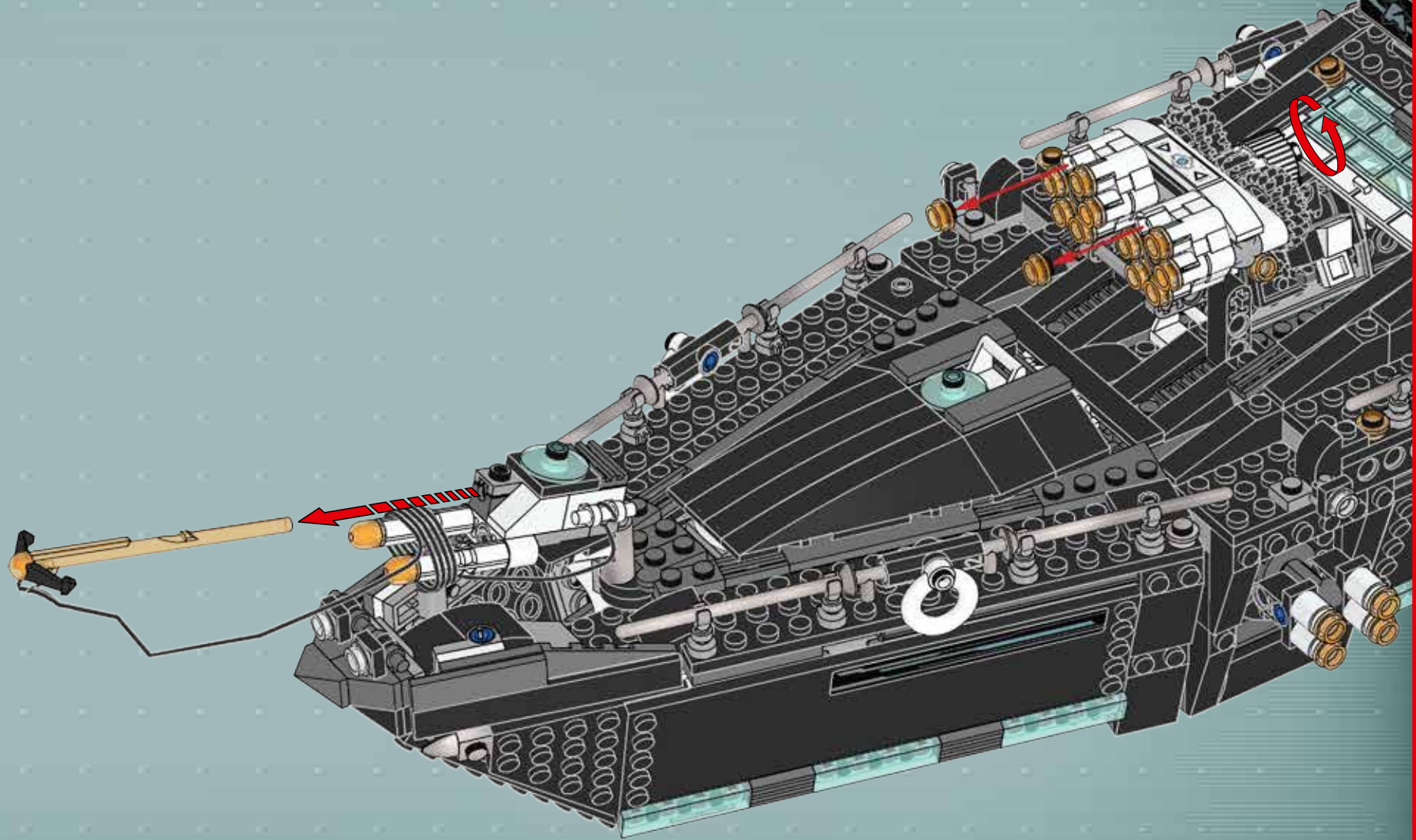

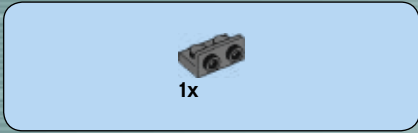

1

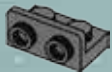

2

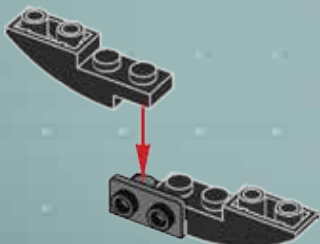

3

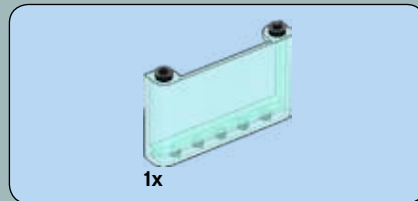
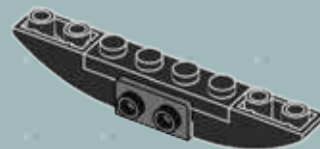

4

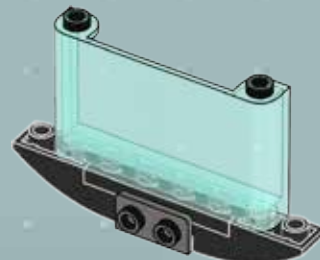

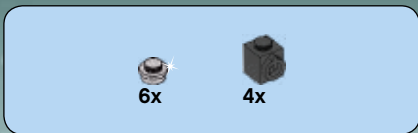

5

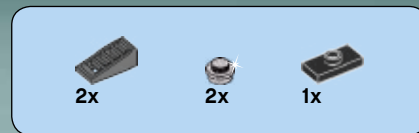
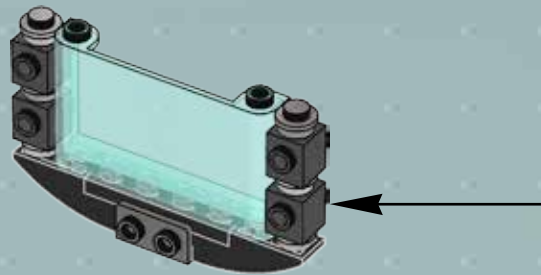
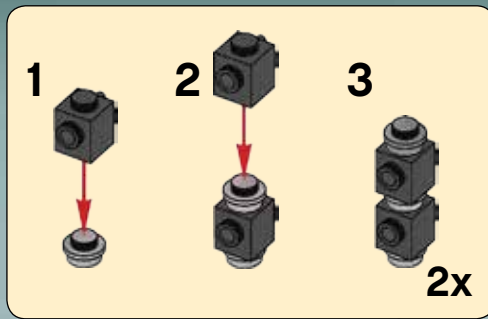

8

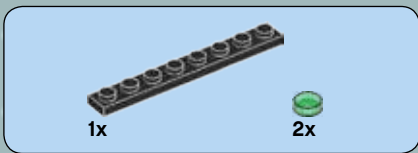
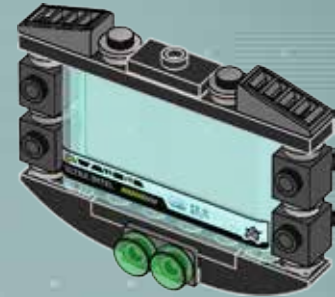

6

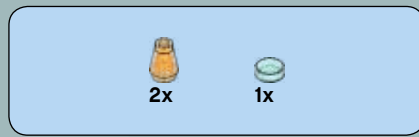
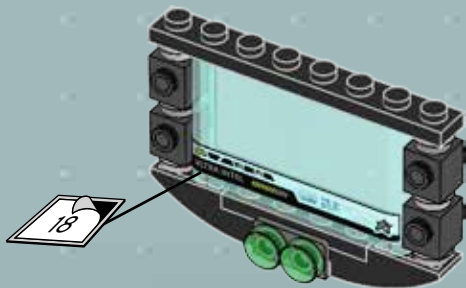

9



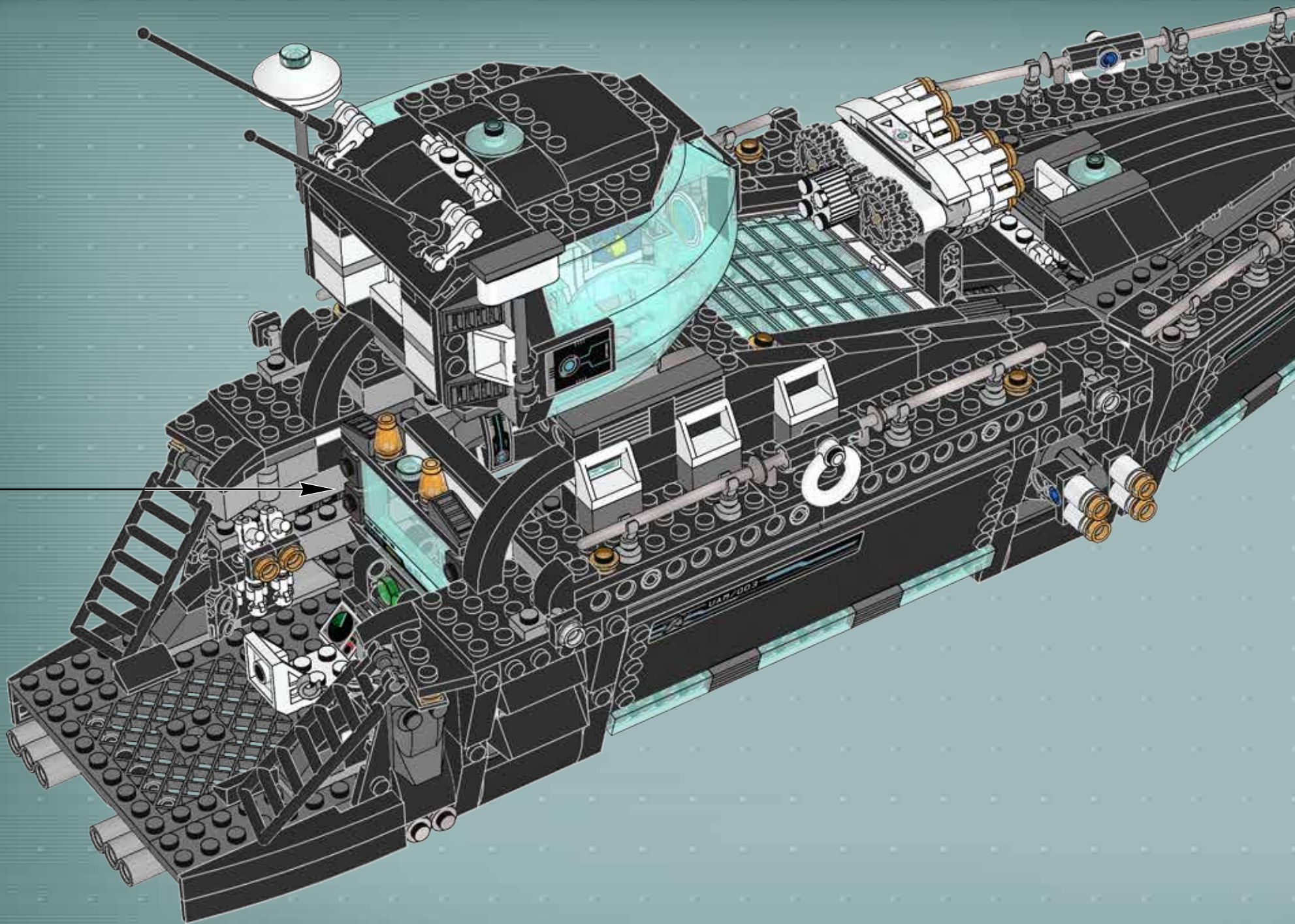

# Download the app and use the AppBrick Gadget to complete the mission!

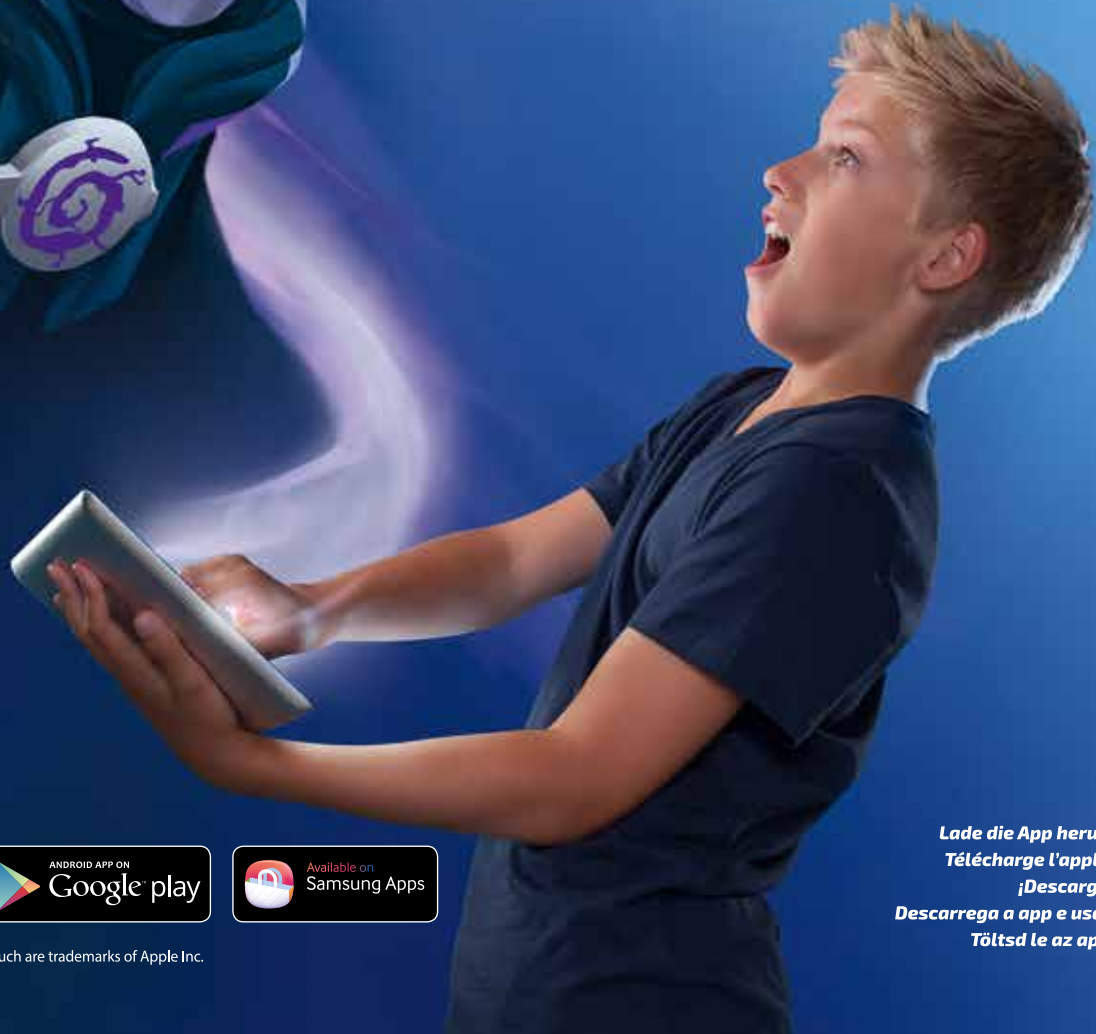

Apple, the Apple logo, iPad, iPhone and iPod touch are trademarks of Apple Inc.  
Google Play is a trademark of Google Inc.

*Lade die App herunter und beende die Mission mithilfe des AppBrick-!  
Télécharge l'application et utilise l'AppBrick pour réussir ta mission !  
¡Descarga la app y usa el AppBrick para completar la misión!  
Descarrega a app e usa o Gadget AppBrick para completares a tua missão!  
Töltsd le az appot és az AppBrick eszközzel teljesítsd a küldetést!*

下载应用程序并使用 AppBrick 工具来完成任务!

# **Unlock the secrets with the new AppBrick Gadgets**



**Schalte geheime Inhalte mit den neuen AppBricks frei!**

**Découvre de nombreux secrets avec l'AppBrick**

**Descubre los secretos con los nuevos AppBricks**

**Desbloqueia os segredos com os novos Gadgets AppBrick**

**Tárd fel a titkokat az új AppBrick eszközökkel!**

**使用新的 AppBrick 工具来解锁秘密**



# ULTRA AGENTS



70171



70172



70173



70166



70167



70168



70169



70170







42036



42033



42034



- 10x 243201
- 1x 4558208
- 4x 4533503
- 4x 300101
- 10x 300401
- 6x 4568956
- 1x 4515347
- 12x 4598527
- 8x 302201
- 1x 4504369
- 26x 302301
- 1x 4501567
- 1x 4500469
- 2x 303901
- 4x 4297083
- 6x 4613256
- 2x 6034044
- 1x 4261941
- 2x 370001
- 1x 4650644
- 1x 6013866
- 1x 6032098
- 2x 6040333
- 2x 6044691
- 2x 407901
- 1x 6054551
- 4x 6058329
- 1x 6061024
- 1x 6070712
- 2x 6076599
- 1x 6079760
- 2x 6081466
- 1x 6093053
- 14x 306201
- 2x 4599044
- 1x 4611927
- 2x 6097145
- 2x 6100932
- 2x 6101992
- 1x 6104617
- 2x 6114966
- 3x 4208160
- 2x 4116816
- 2x 4179580
- 1x 4140626
- 1x 4121932
- 1x 4558168
- 1x 4495927
- 4x 6001831
- 2x 4542578
- 3x 6090084
- 1x 6057027
- 2x 4142865
- 1x 393721
- 2x 654121
- 1x 4128598
- 4x 4206482
- 1x 6117498
- 14x 4514553
- 11x 4143005
- 1x 6117497
- 2x 4107797
- 2x 302223
- 1x 6081406
- 4x 6050850
- 4x 407024
- 2x 4185617
- 1x 4193511
- 2x 4239601
- 6x 370024
- 1x 6102544
- 1x 6089119
- 9x 4184169
- 1x 6079896
- 1x 6081432
- 1x 6081410
- 1x 6078731
- 8x 6066102
- 1x 4160869
- 1x 4283047
- 1x 4283046
- 2x 4504382
- 2x 4548180
- 2x 6051508
- 4x 428626
- 2x 428726
- 2x 329826
- 5x 366026
- 4x 6047276
- 11x 6053077
- 2x 6037746
- 4x 6039869
- 30x 4515362
- 6x 6037664
- 2x 6056500
- 1x 4613153
- 2x 4260488
- 1x 4658977
- 4x 4587844
- 4x 4560182
- 4x 6058966
- 4x 4297713
- 12x 6052126
- 4x 317626
- 1x 4163904
- 1x 4258354
- 8x 4289538
- 4x 287726
- 8x 4144024
- 1x 4515340
- 2x 6104618
- 2x 4515350
- 1x 6018805
- 3x 301026
- 2x 4529549
- 1x 4525236
- 1x 6123924
- 2x 256926
- 1x 4558850
- 1x 4598897
- 6x 4565323
- 1x 4177431
- 14x 362226
- 4x 4162443
- 4x 300826
- 4x 273026
- 2x 389526
- 10x 370326
- 4x 243126
- 12x 416226
- 1x 302026
- 3x 383226
- 4x 428226
- 4x 6092509

- 6x 4243819
- 5x 303526
- 1x 303026
- 1x 303326
- 2x 6109815
- 1x 4639346
- 1x 4546691
- 9x 4258476
- 2x 4228126
- 2x 6028411
- 8x 6022171
- 3x 4581214
- 1x 6103865
- 1x 6064345
- 1x 4667222
- 6x 6051918
- 12x 4586557
- 2x 4514700
- 2x 4646860
- 1x 4646864
- 7x 3005740
- 4x 4567331
- 1x 6115731
- 4x 3005744
- 4x 4567332
- 1x 4654448

- 1x 6006514
- 2x 4524365
- 65x 4222960
- 1x 6097148
- 2x 4567338
- 2x 4278409
- 4x 6055631
- 1x 6031821
- 2x 6102607
- 2x 6102608
- 5x 4494475
- 2x 6097090
- 6x 6089147
- 2x 4612621
- 6x 4611702
- 6x 4211386
- 9x 6015344
- 2x 4520320

- 2x 4211815
- 5x 616608
- 6x 4526985
- 2x 4211807
- 6x 4233493
- 1x 4654582
- 13x 4654580
- 2x 4225033
- 2x 4211436
- 16x 6064023
- 9x 6043656
- 1x 4211881
- 1x 6045988
- 1x 4211421
- 2x 4222047
- 4x 4211429
- 6x 4211438
- 4x 4211438
- 1x 4514846

- 2x 4613165
- 19x 4211395
- 3x 4211452
- 10x 6011459
- 10x 4211461
- 1x 4211527
- 2x 4211640
- 2x 4211848
- 1x 6034493
- 14x 4211393
- 2x 6023978
- 2x 4211705
- 4x 4211566
- 1x 4211413

- 1x 4641048
- 2x 6028812
- 4x 6092649
- 6x 4211053
- 4x 4210651
- 2x 4218696
- 2x 4579354
- 2x 6051334
- 1x 6048898
- 20x 4210631
- 2x 6063277
- 2x 4213574
- 3x 4568734
- 2x 4213607
- 4x 6019987
- 4x 6015356
- 5x 4211135
- 1x 4211124
- 2x 6100030

- 4x 4211064
- 4x 4211060
- 3x 4211046
- 3x 4211044
- 12x 6117972
- 10x 4211043
- 13x 6000606
- 1x 4210718
- 6x 4211088
- 2x 4211068
- 2x 6081987
- 4x 4210900
- 2x 4210851
- 1x 6076203
- 2x 4271950
- 2x 6055313
- 1x 4299022

- 14x 4210660
- 2x 4210658
- 2x 4261908
- 8x 4540386
- 8x 4210998
- 6x 4210967
- 10x 4210997
- 3x 4211067
- 2x 6039176
- 2x 4243831
- 2x 4210794
- 4x 4256149

- 1x 4210469
- 4x 6102774
- 2x 4210788
- 2x 4210782
- 1x 6117394
- 4x 6103777
- 3x 6078279
- 2x 4515367
- 1x 6054858
- 2x 6047418
- 2x 4625146
- 18x 4633691
- 2x 4612827
- 8x 4611884

**Customer Service**  
 Kundenservice  
 Service Consommateurs  
 Servicio Al Consumidor  
 LEGO.com/service or dial

 : 00800 5346 5555  
 : 1-800-422-5346