



LEGO

LEGENDS OF

CHIMA

TM

70206



CHI LAVAL



LEGO.com



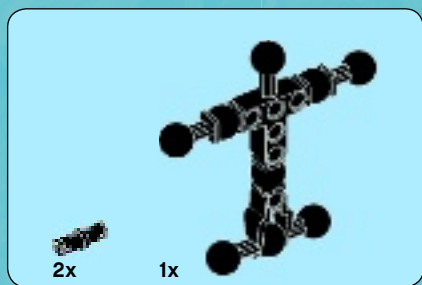

1

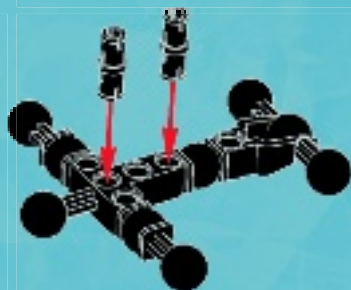

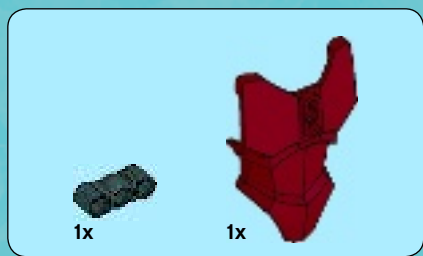

2

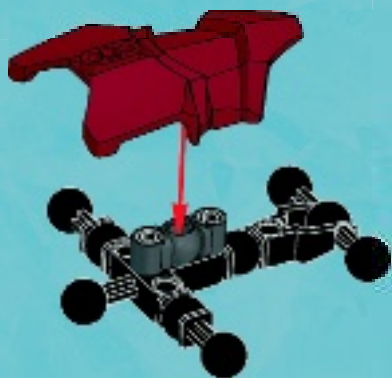

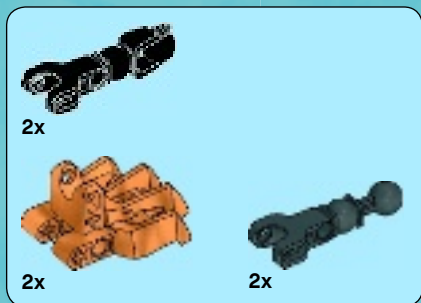

1



3

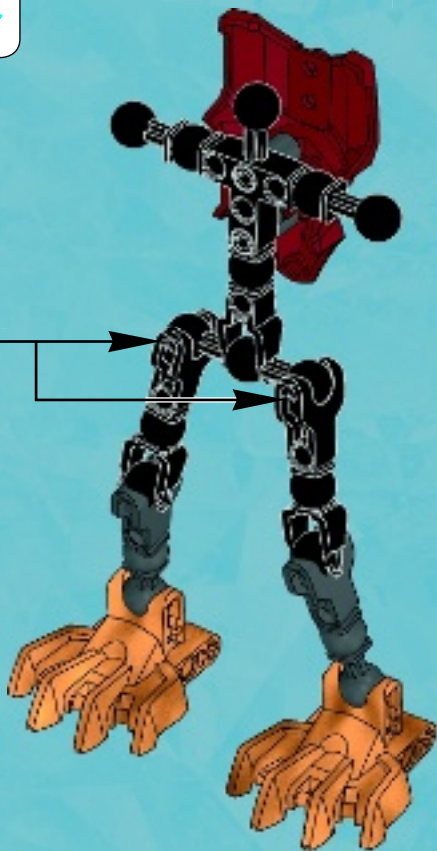
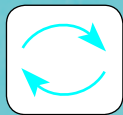



2x



2x

4





2x



1x



1x

1

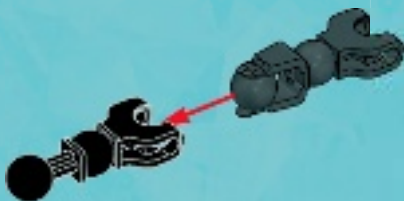



1x



1x

2

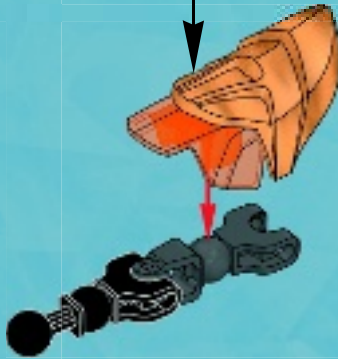
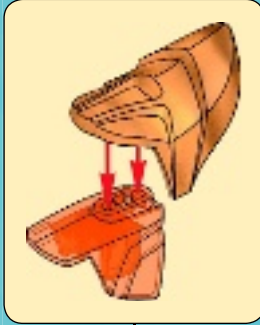

2x

5

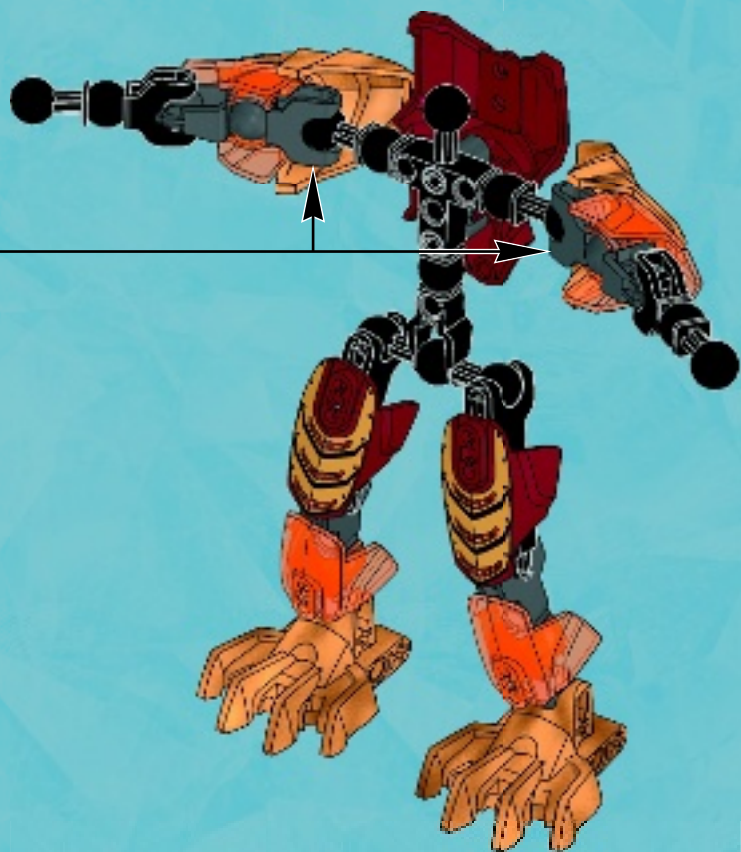



1x



1x



1x

1

1



2

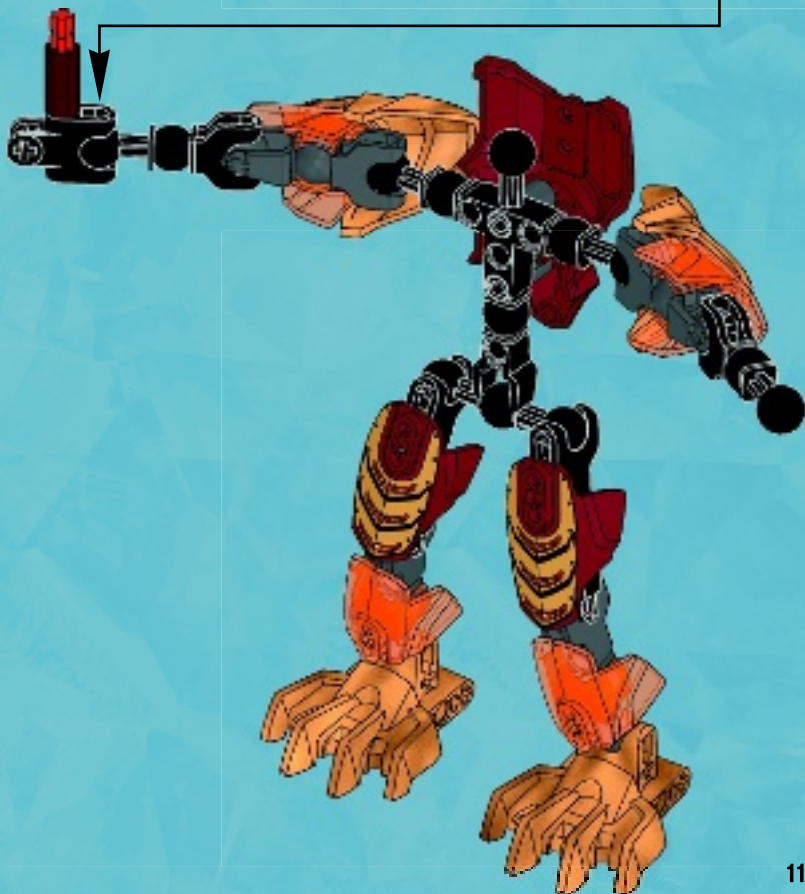



6

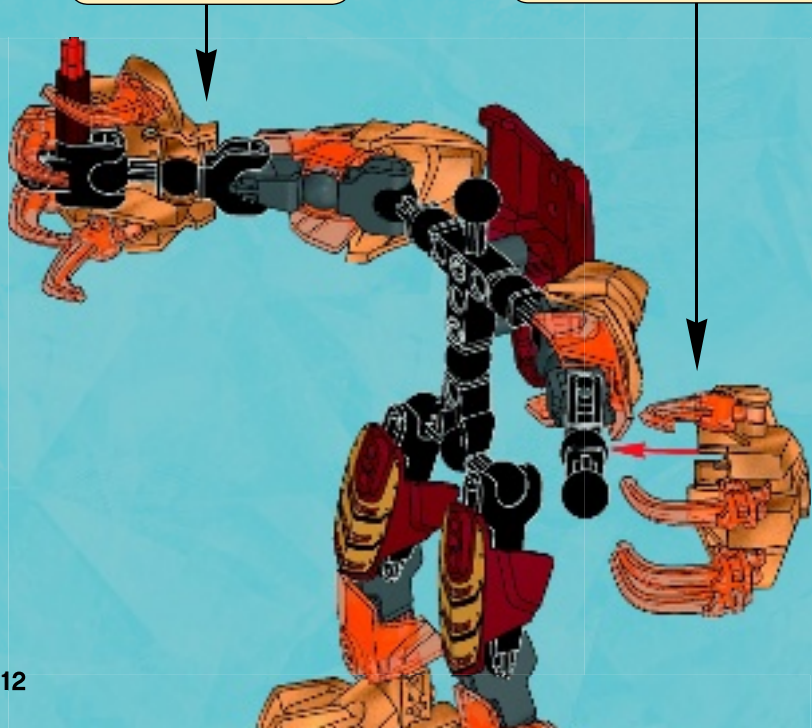
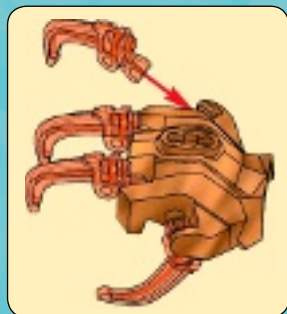



1x

7

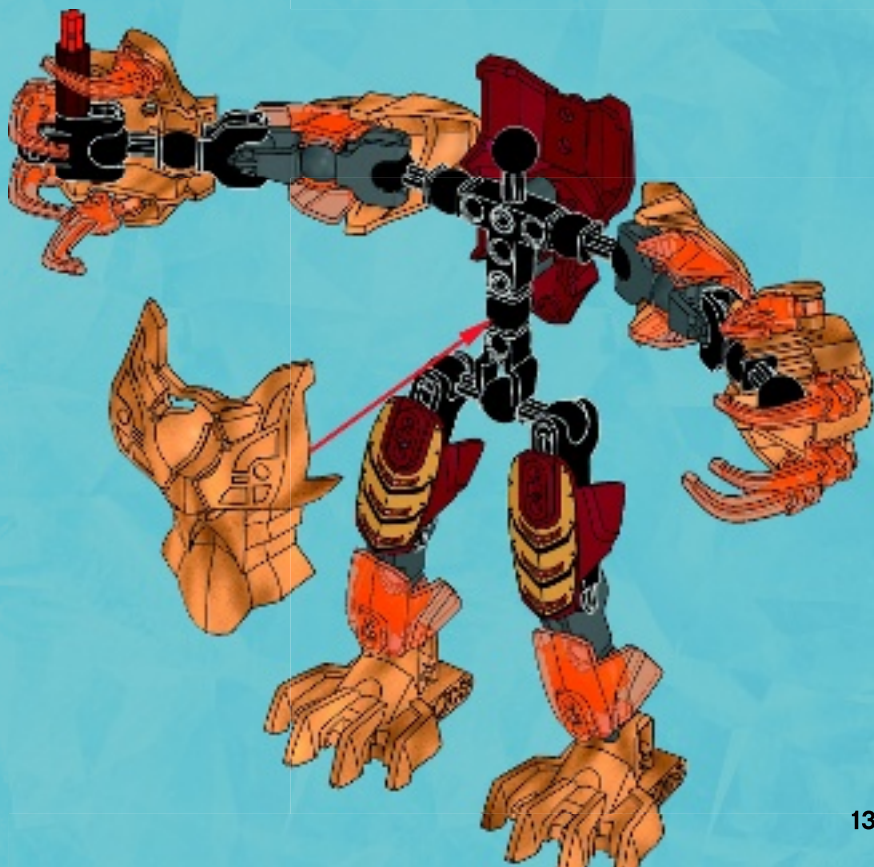

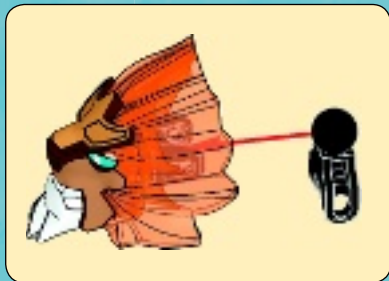

8

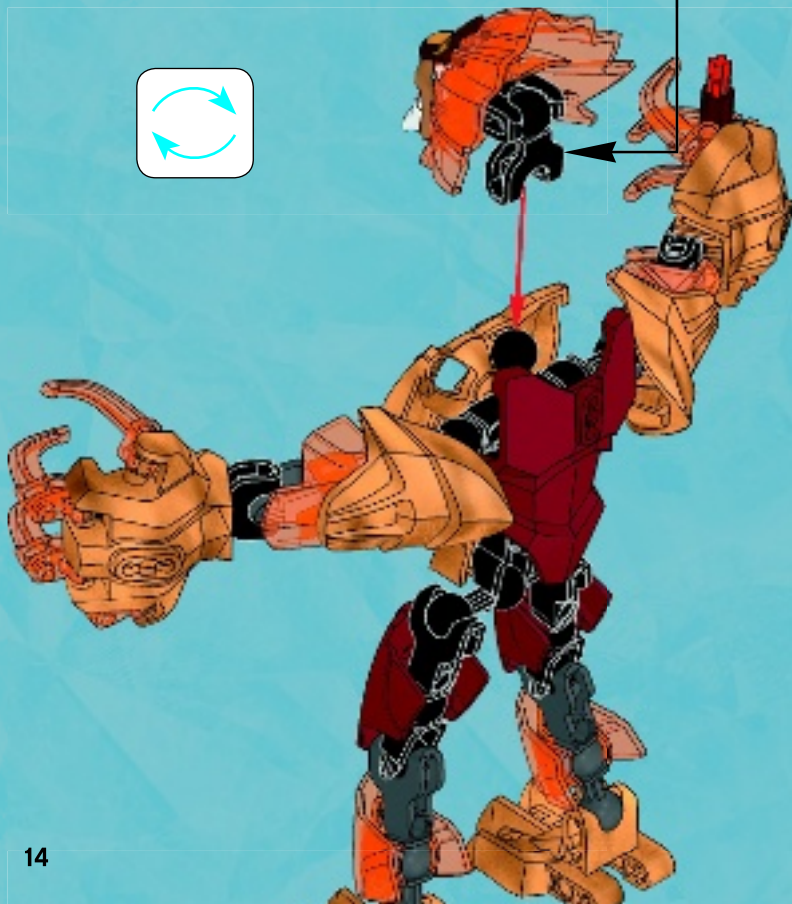
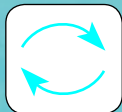

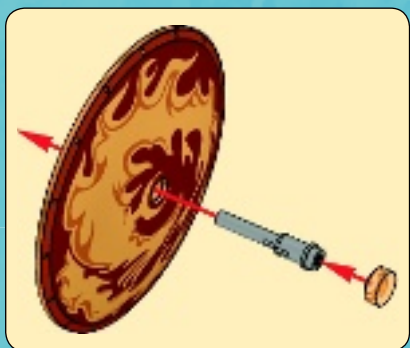

9



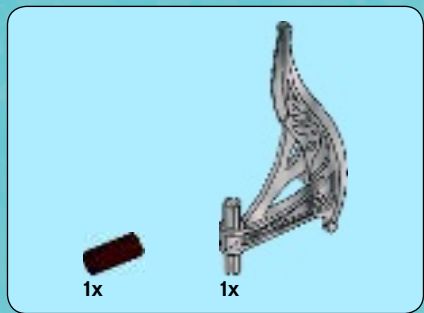

1

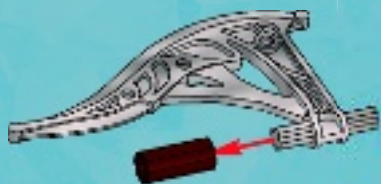

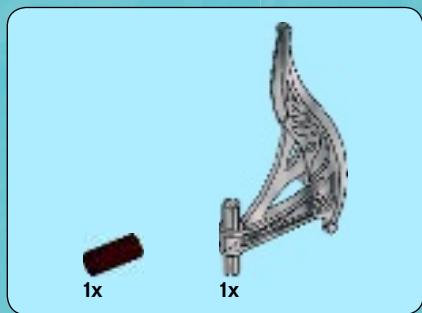

2

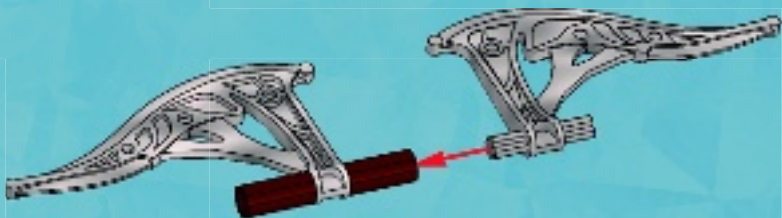



1x

3

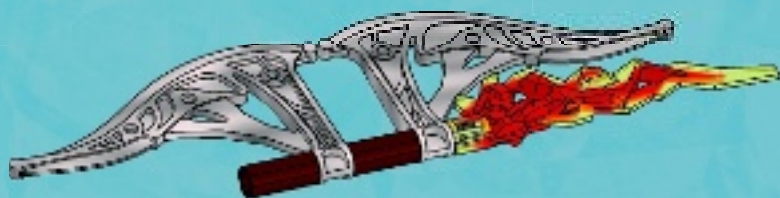

10

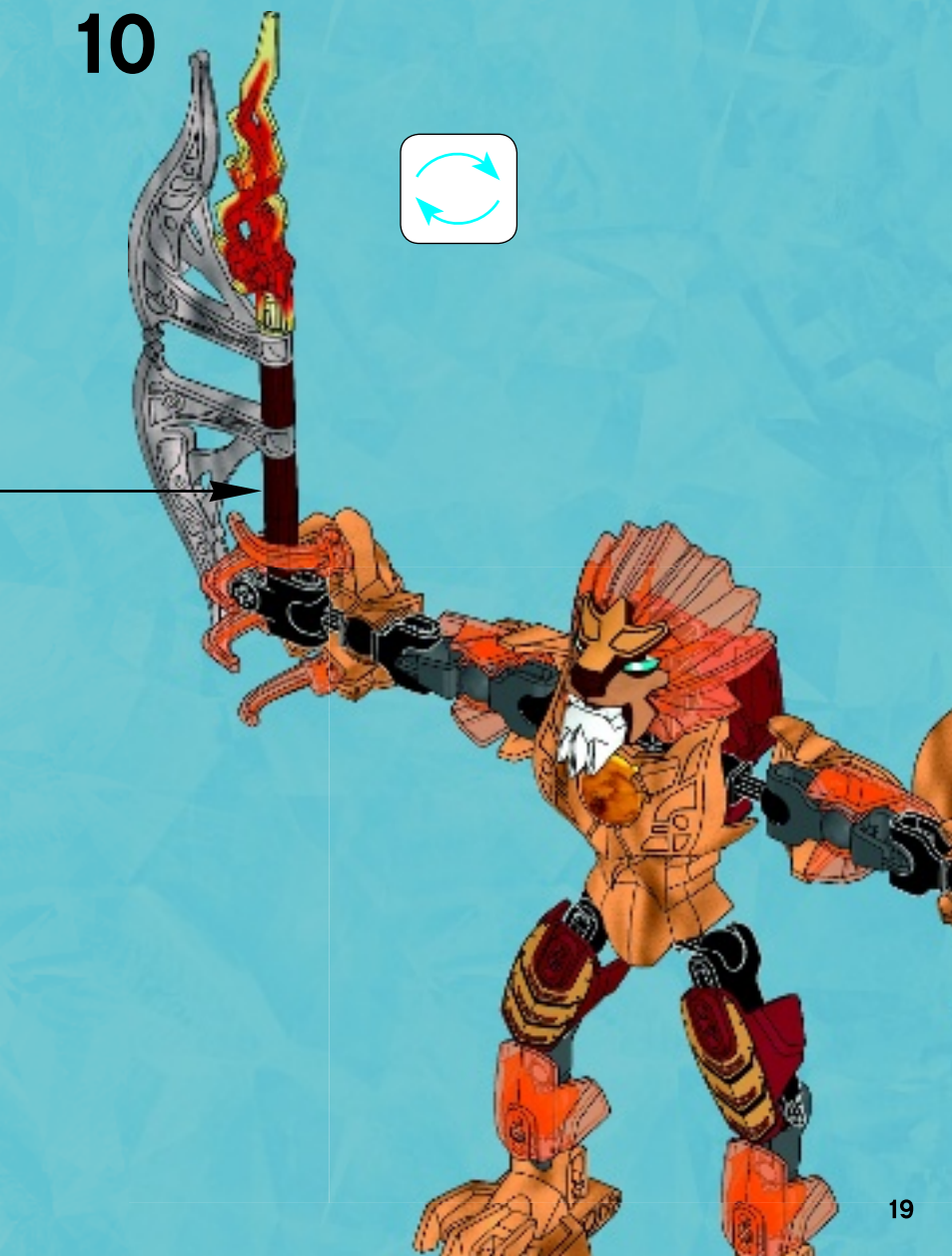



1x

11



2x
4142865

1x
6075267

1x
4610948

1x
4593557



2x
4593555

2x
4593562

1x
4593571

2x
4121715



1x
6016236

8x
6021344

1x
6073108

4x
6076486

1x
6021277



2x
6076797

1x
4646865

3x
4531751

1x
4520320



1x
6001085

2x
4622903

2x
6013996

2x
4622882

2x
6076485

2x
6075042

1x
6076487

1x
6077637

2x
6076488



Customer Service

Kundenservice

Service Consommateurs

Servicio Al Consumidor

LEGO.com/service or dial

: 00800 5346 5555
: 1-800-422-5346



CHI LAVAL
70206

CHI FLUMINOX
70211



LEGO.COM/CHIMA/BI



LEGENDS OF

TM

CHIMA



LEGO.COM/CHIMA

...Or visit:



Apple, the Apple logo, iPad, iPhone and iPod touch are trademarks of Apple Inc., registered in the U.S. and other countries. App Store is a service mark of Apple Inc.



70206



70207



70208



70211

LEGO.COM/CHIMA



70212

70209

70210



LEGENDS OF
CHIMA

70146

70144

70211

70212

70151

70206

70145

LEGO.COM/CHIMA





70144

70145

70146



70206

70208

70209

70211

70212



70149

70150

70151

70156