



LEGENDS OF CHIMA™



70226



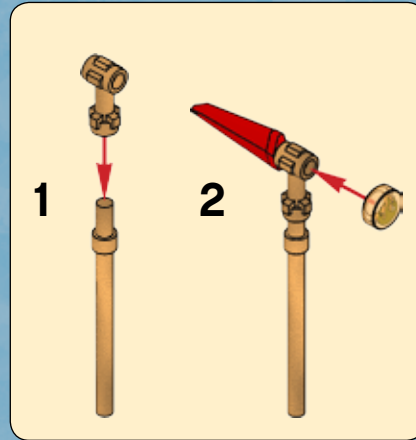
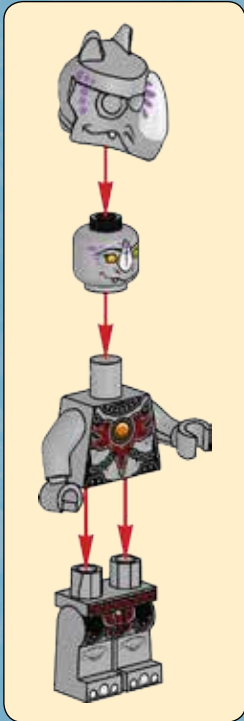
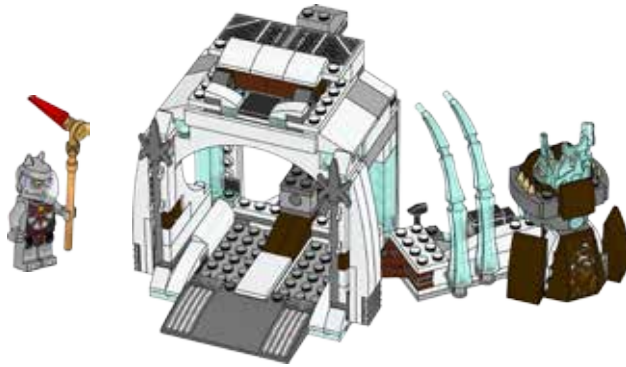
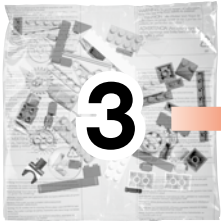

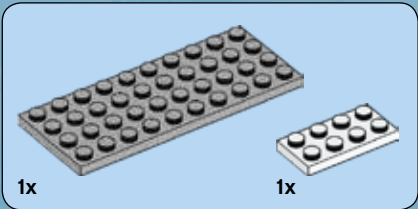

1

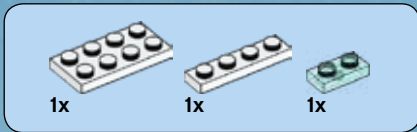
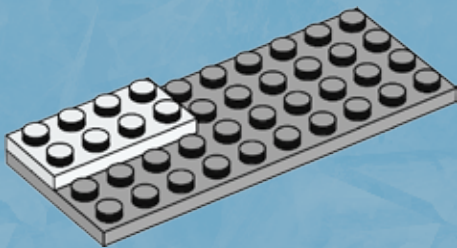

2

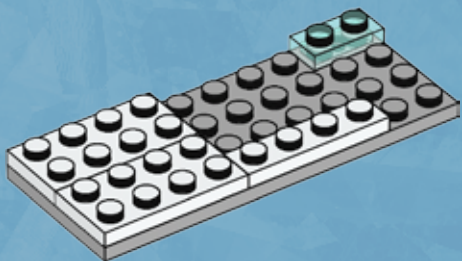



1x

3

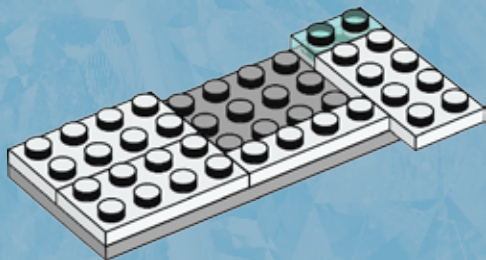

1x



1x

4

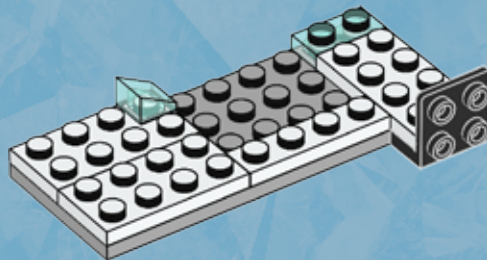



1x

5

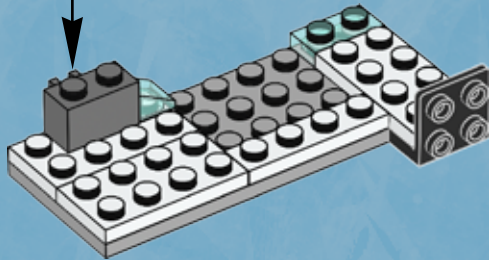
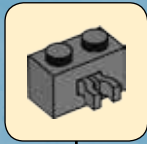

2x

6

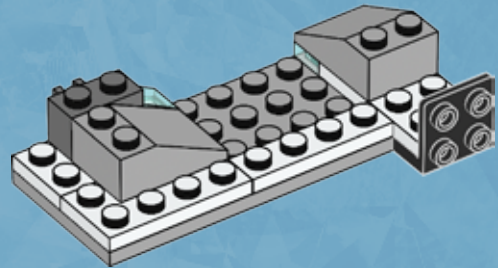



1x



1x



1x

7

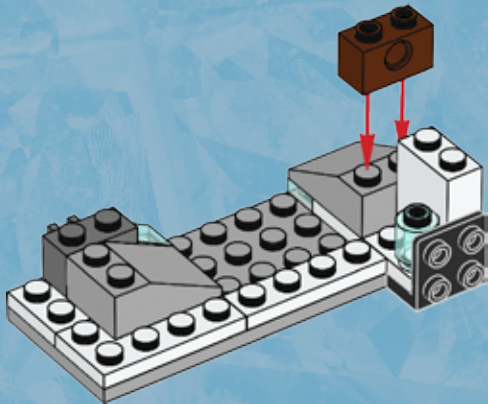

2x



1x

8

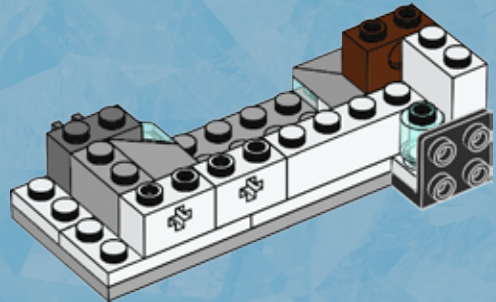



1x

9

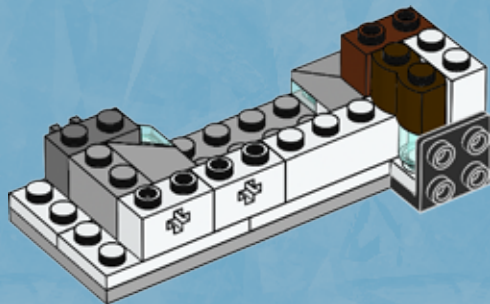

1x



1x

10

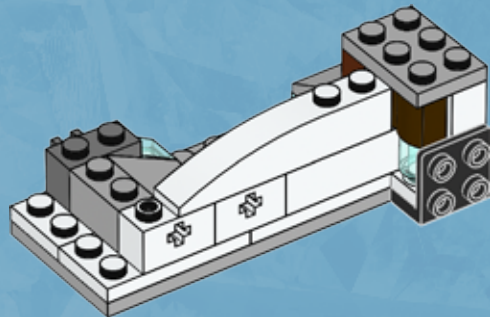



1x



1x

11

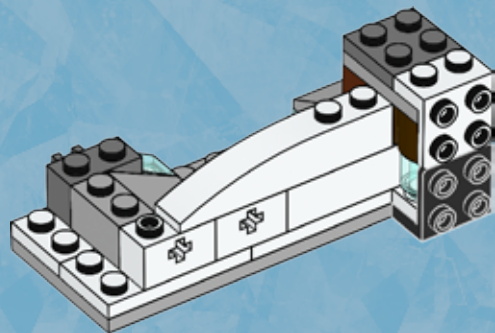



2x

1

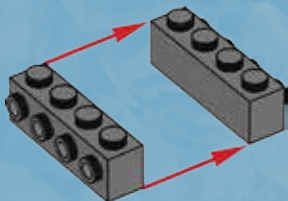

1x

2



2x

3



2x

4





1x

5

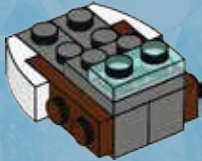

2x

6

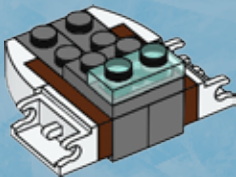

1x

7





8

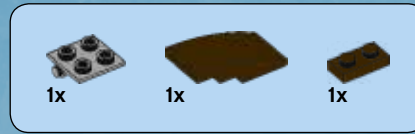
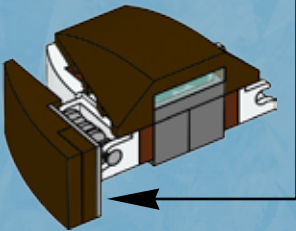
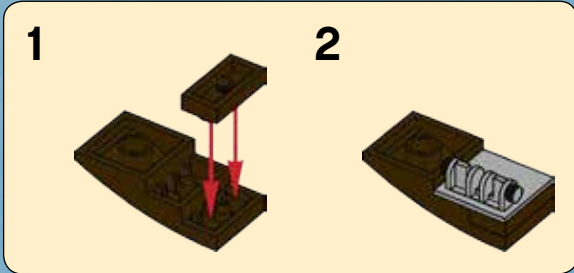

9

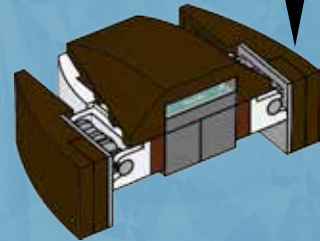
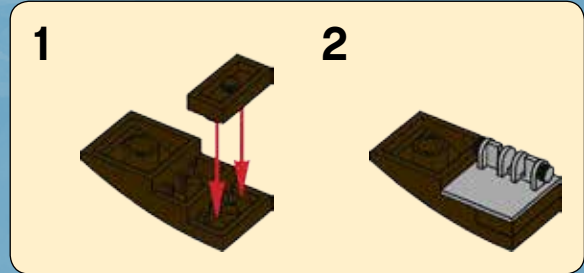

10

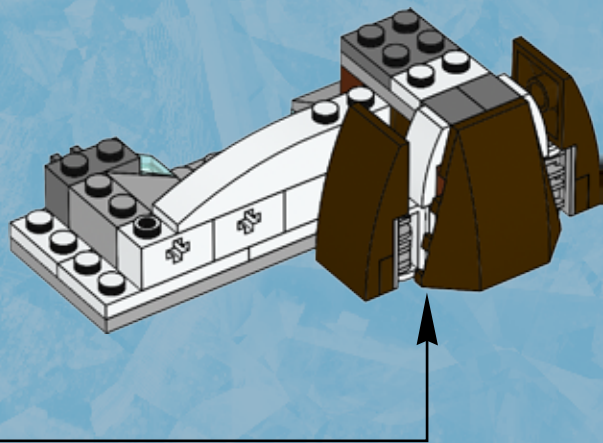

11

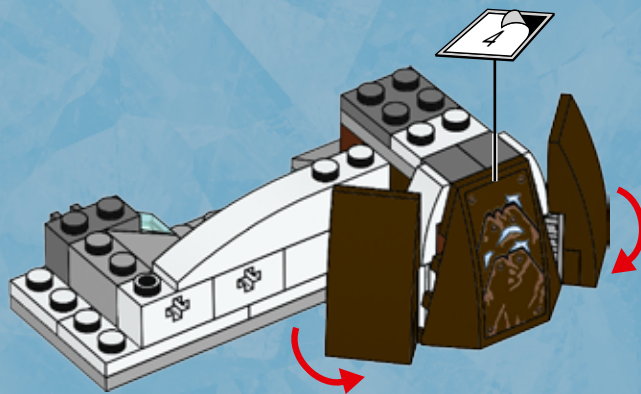



1x

12

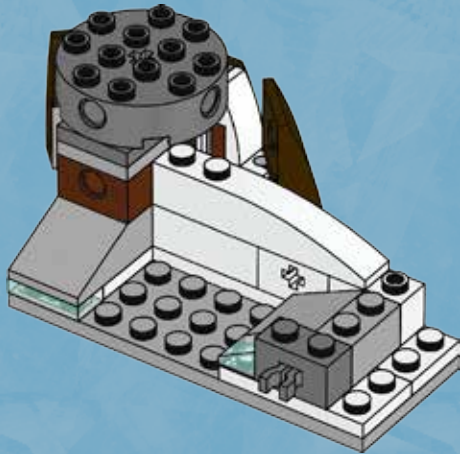

2x

13

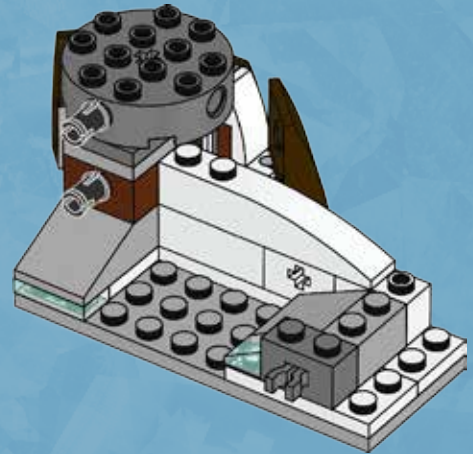



1x



1x

14

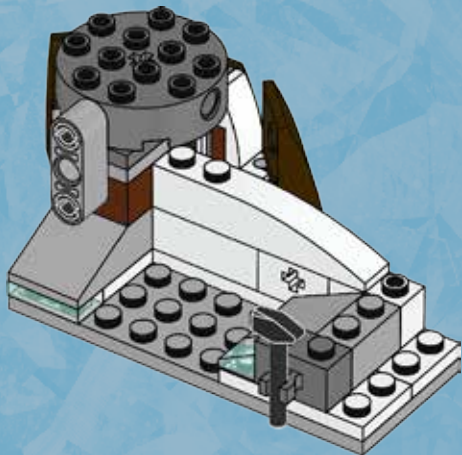

1x



1x



1x



2x



1x



1x

15

1

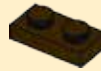

2



3

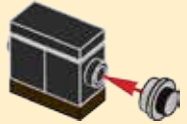

4

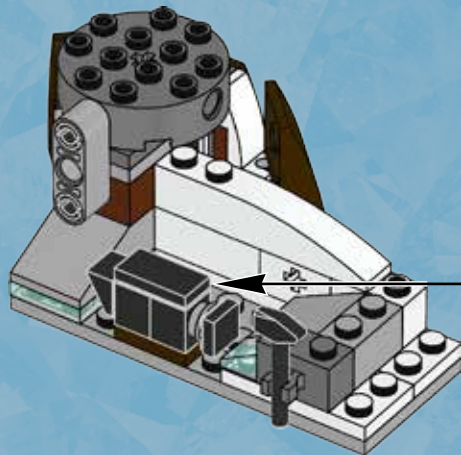
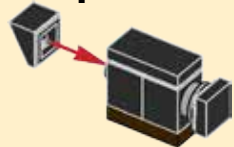



3x

16

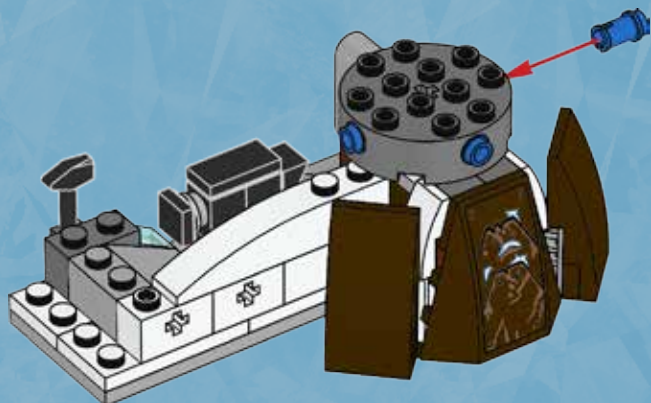
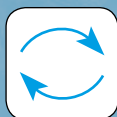

3x

17

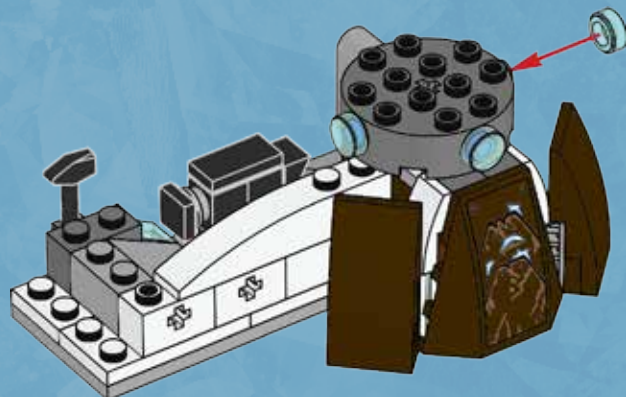



1x



1x



1x

18

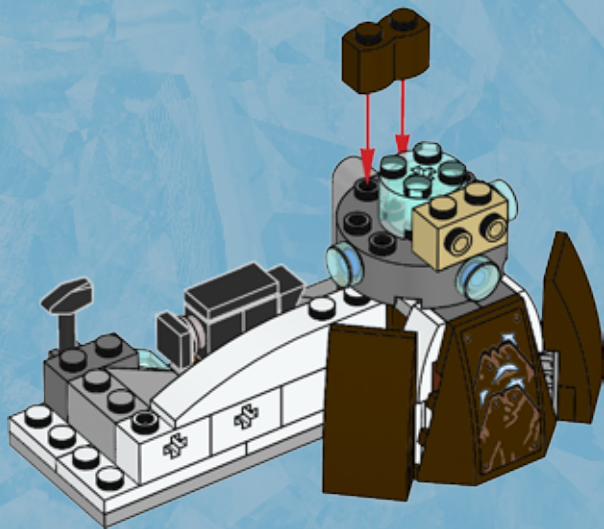

2x



2x



2x

19

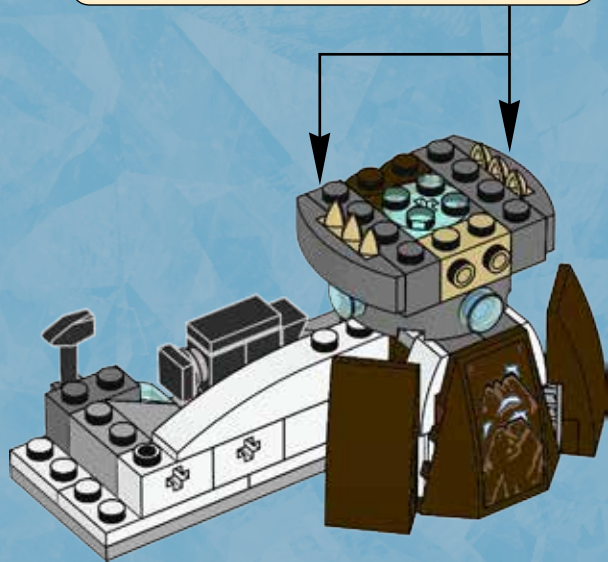
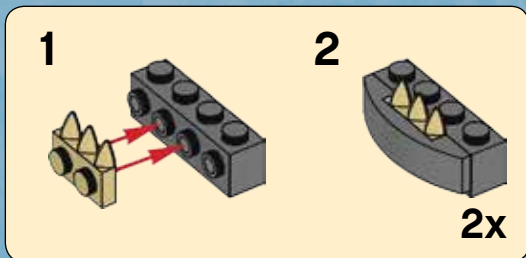



1x

20

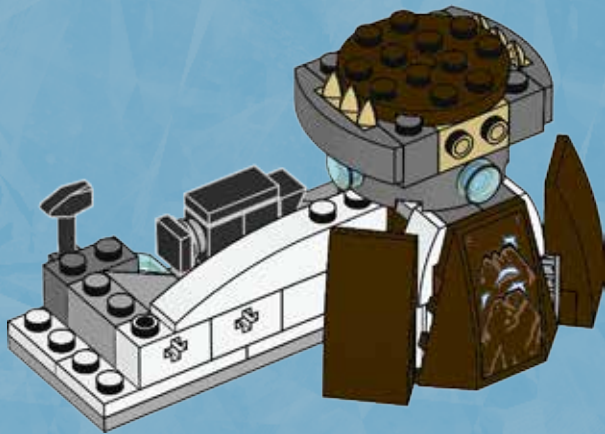

2x

21

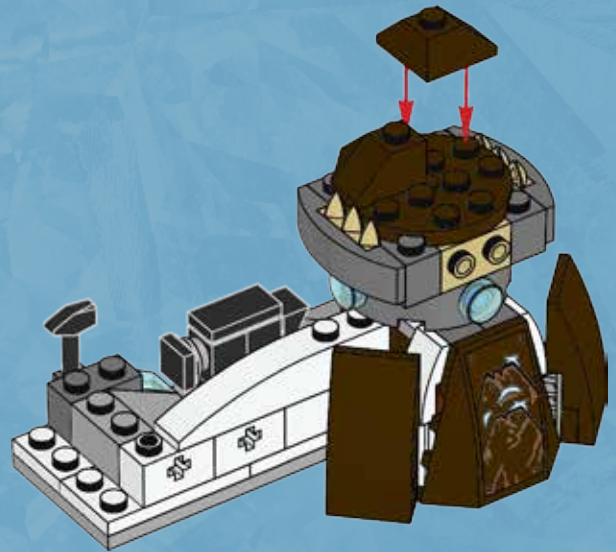



1x

22

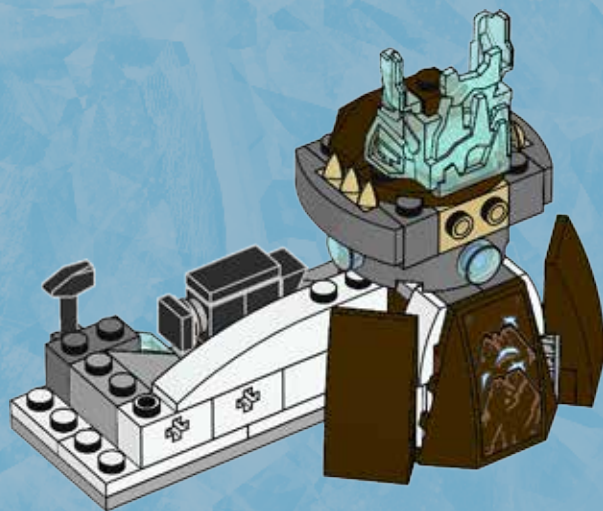

1x



1x

23

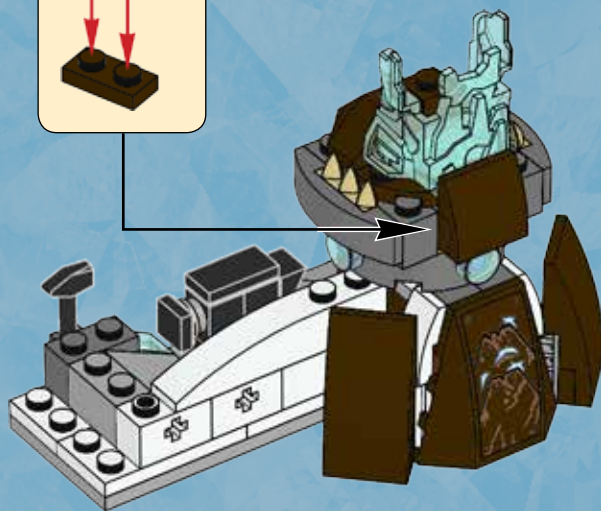
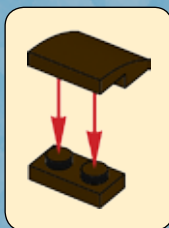

49

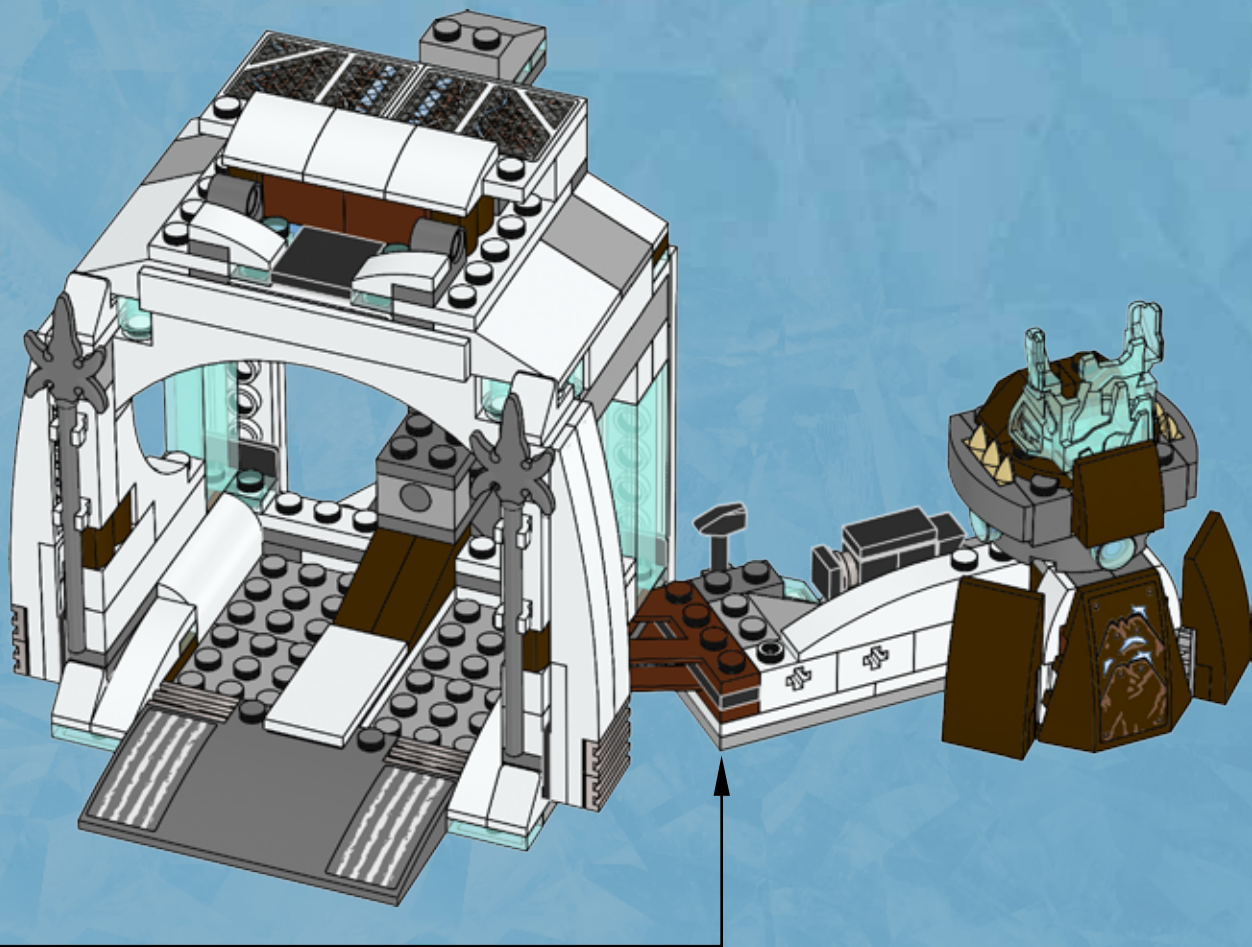



1x

50

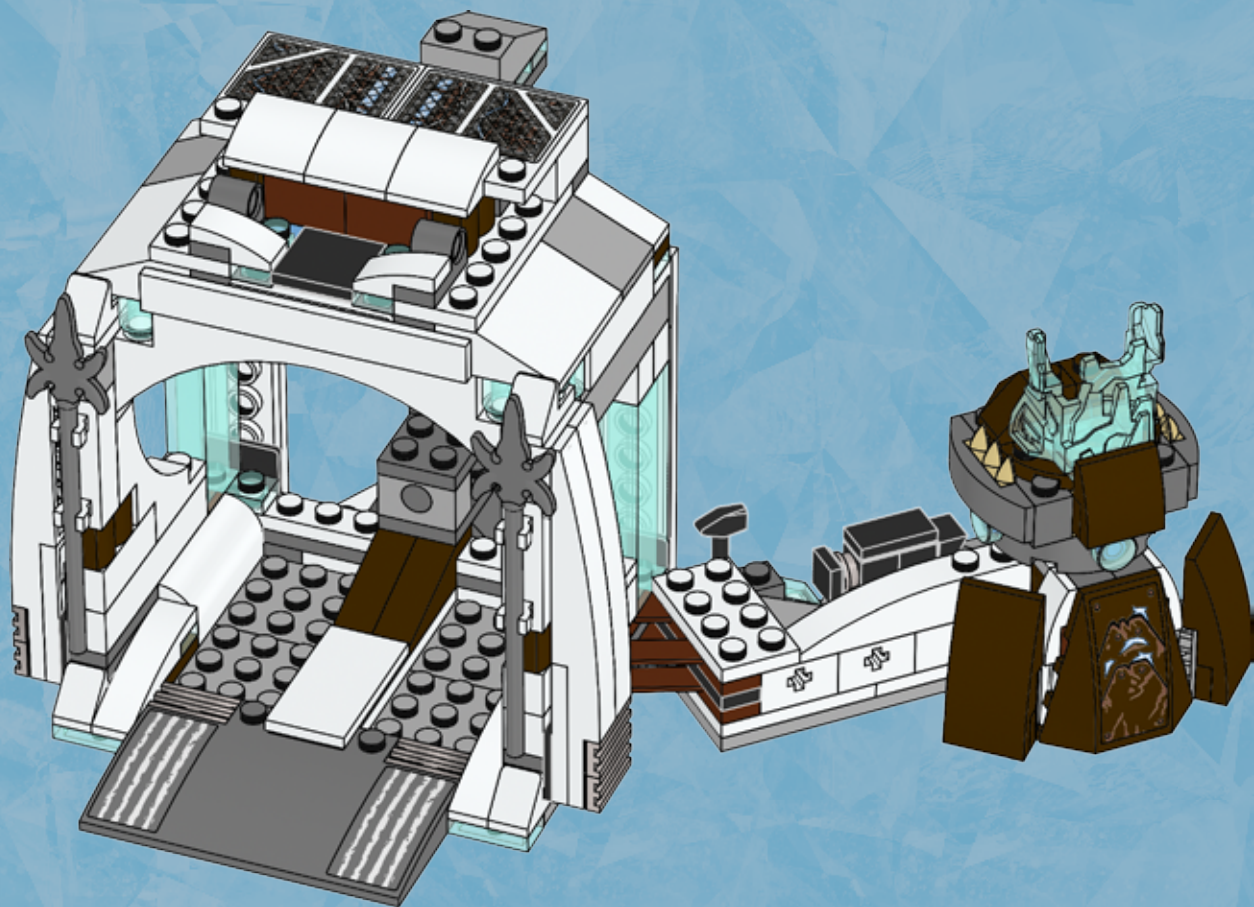

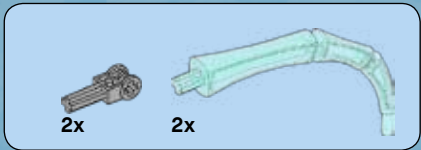

51

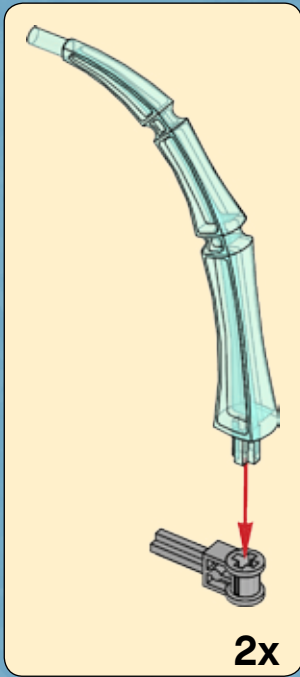
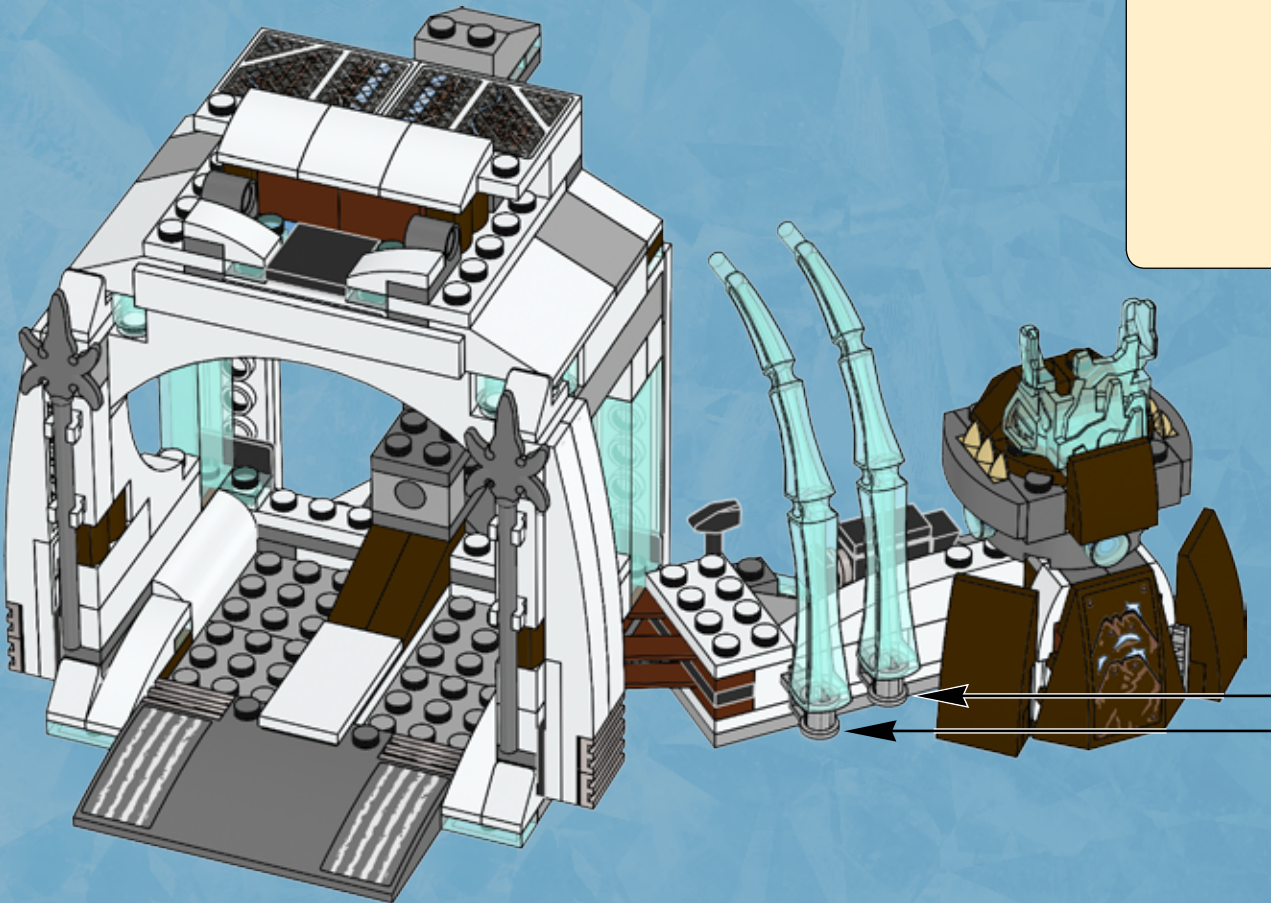

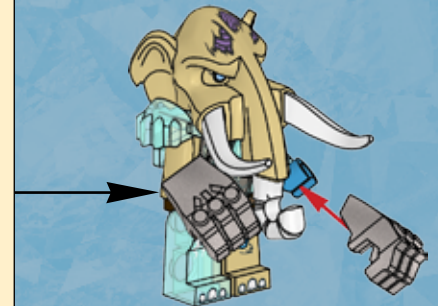
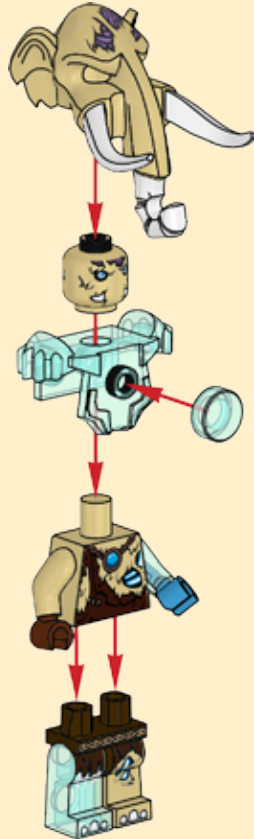
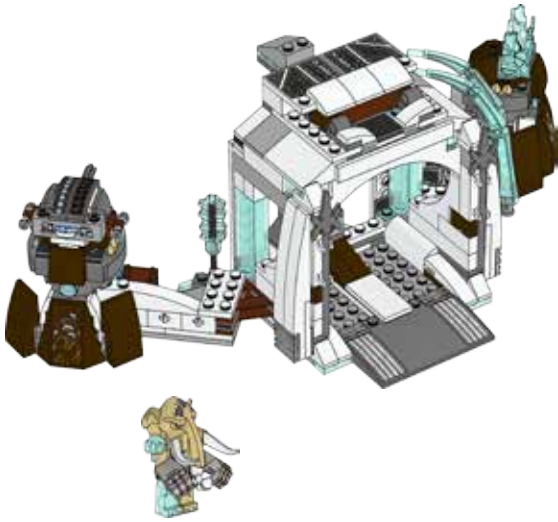
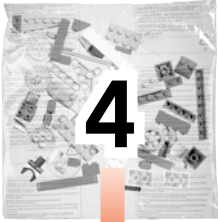

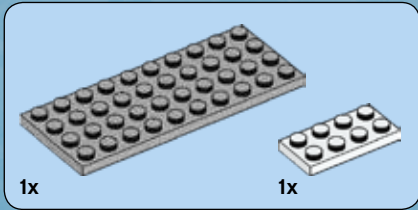
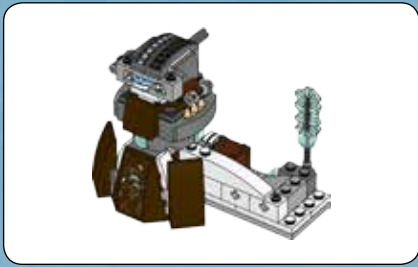

1

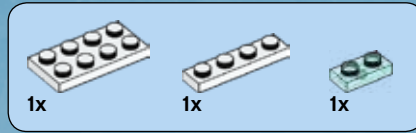
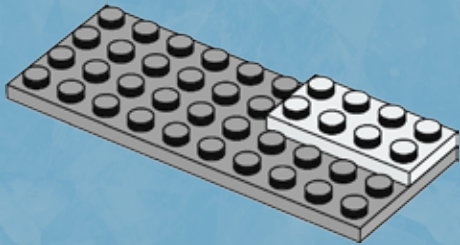

2

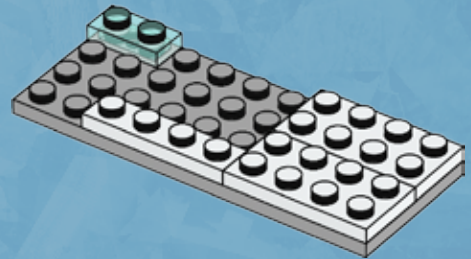



1x

3

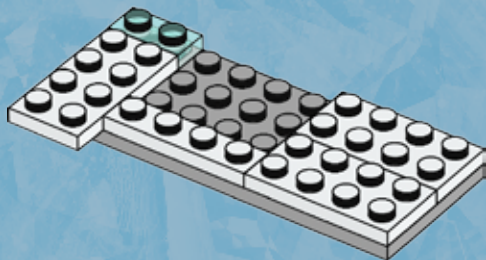

1x



1x

4

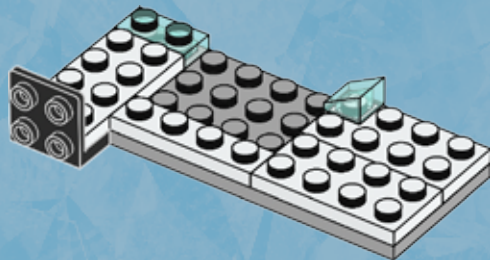



1x

5

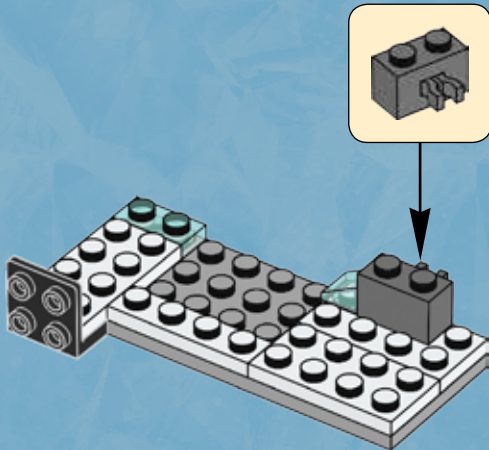

2x

6

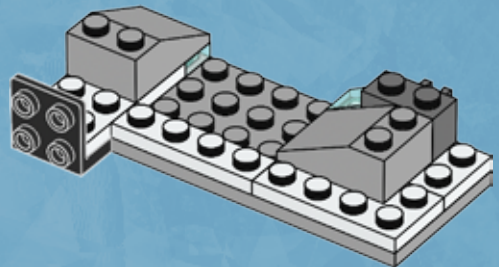



1x



1x

7

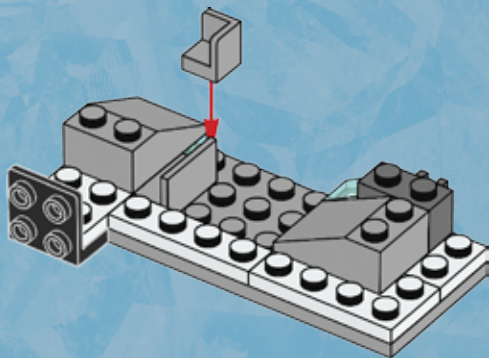

1x



1x



1x

8

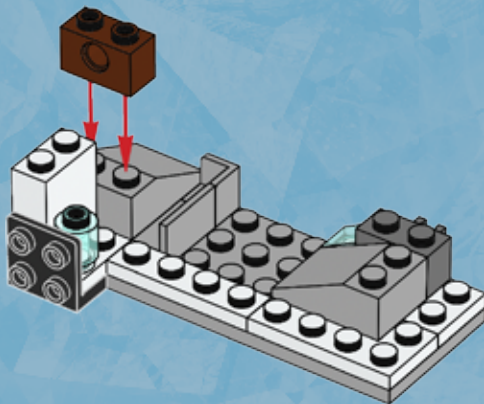

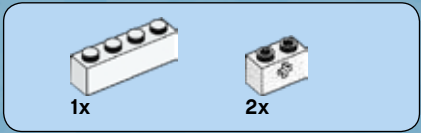

9

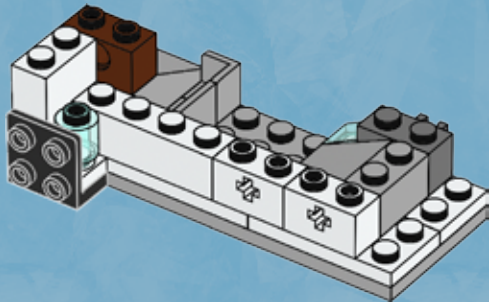

10

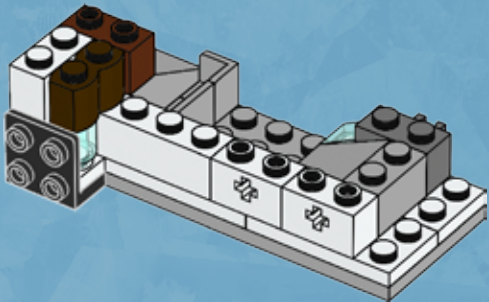



1x



1x

11

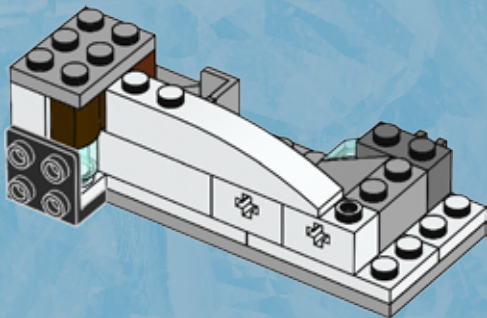

1x



1x

12

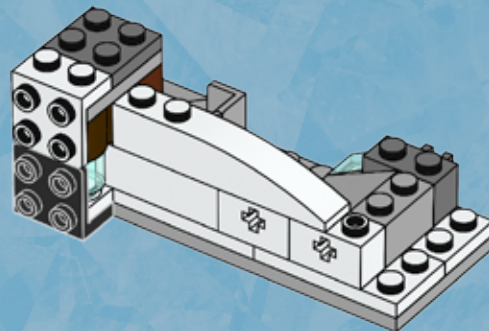



2x

1

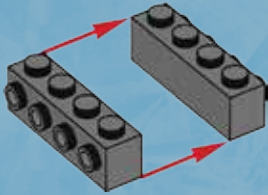

1x

2

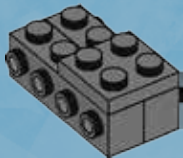

2x

3



2x

4





2x

5

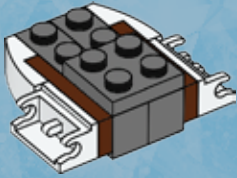

1x

6

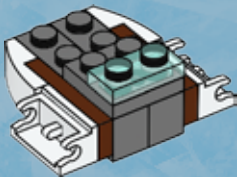

1x

7





8

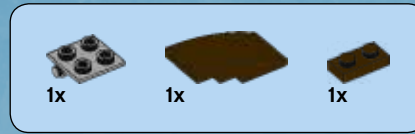
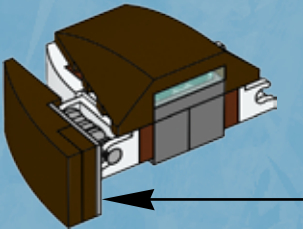
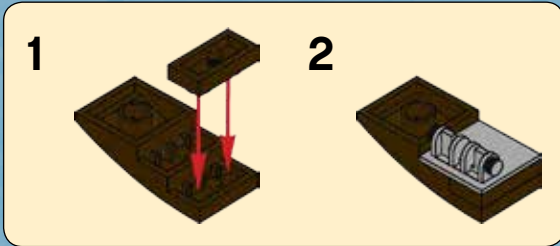

9

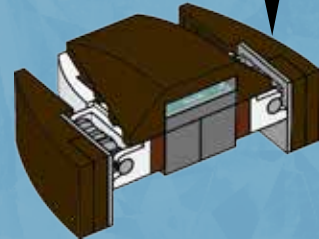
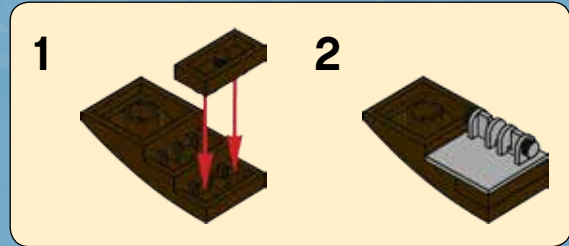

10

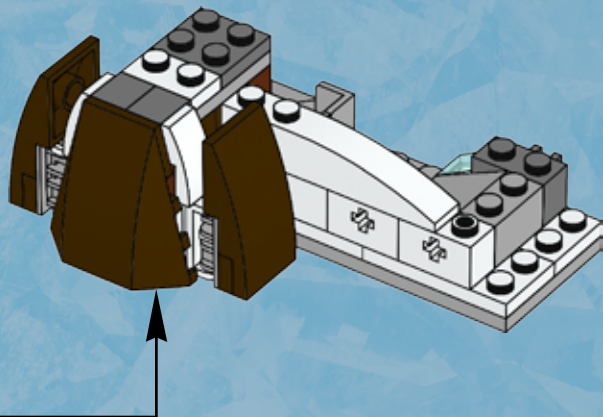

11

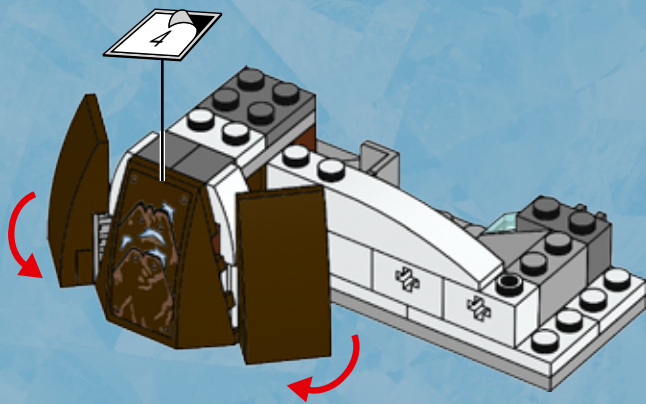



1x



2x

12

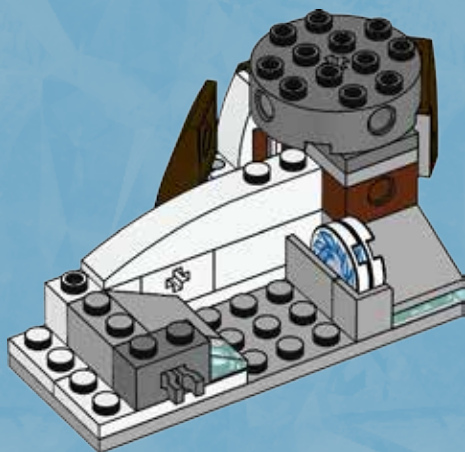

2x

13

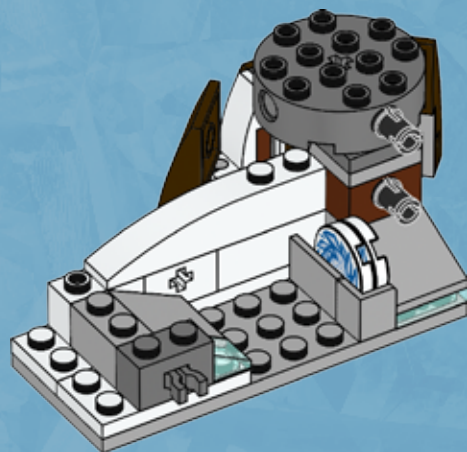



14

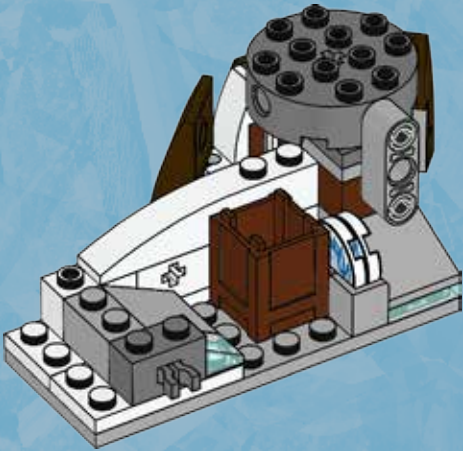

15

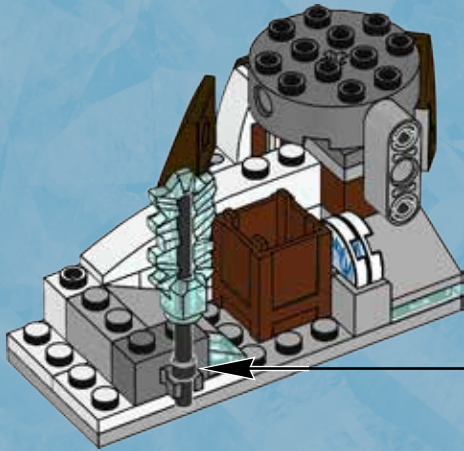
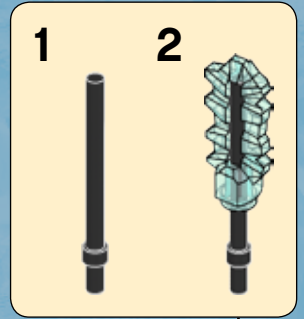



3x

16

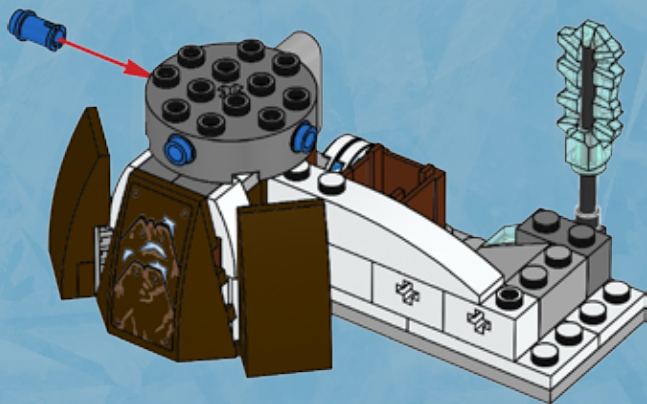

3x

17

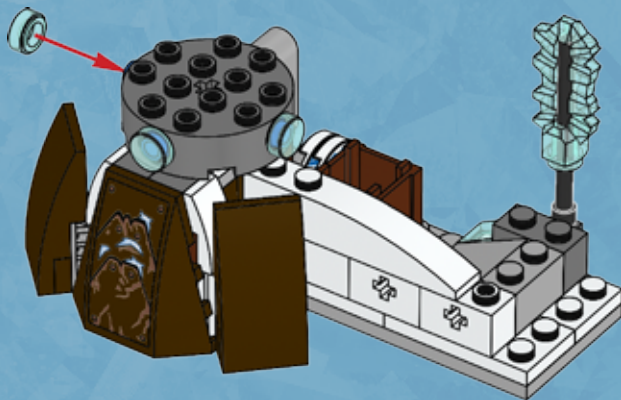



18

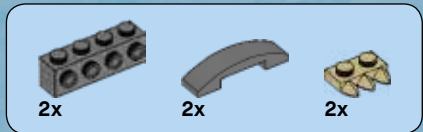
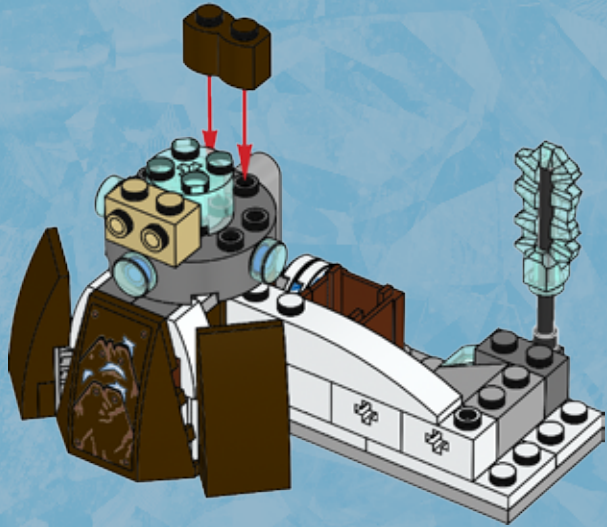

19

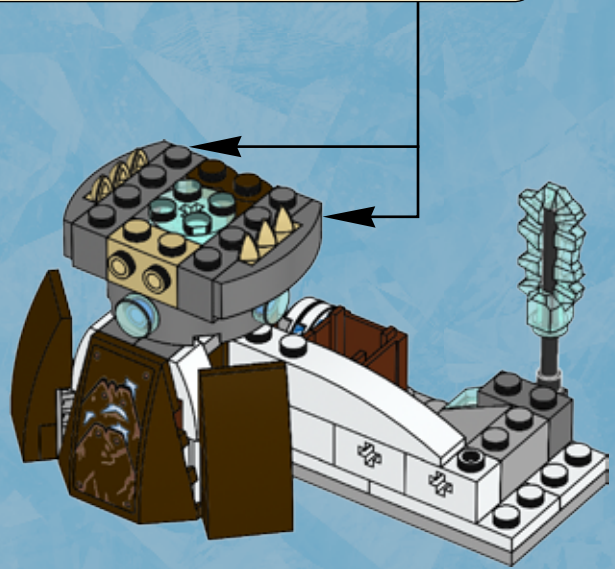
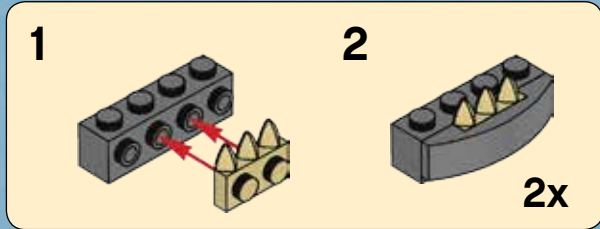

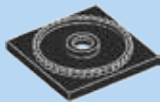

1x

20

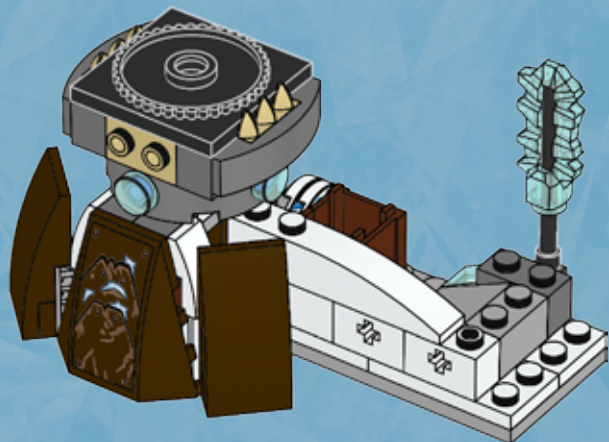

1x



1x

21

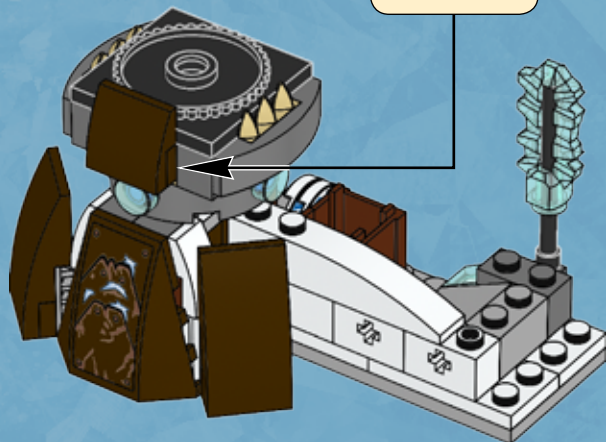
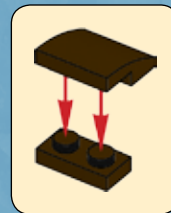



1x

1



2x

2



1x

3





2x

4

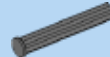
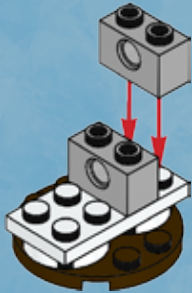

1x

4

5

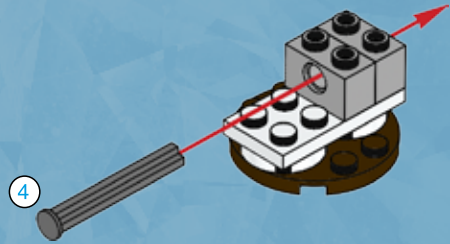

4

1:1

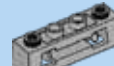

1x



6

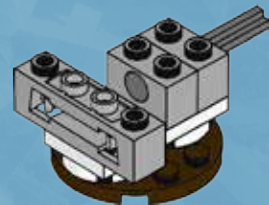



7

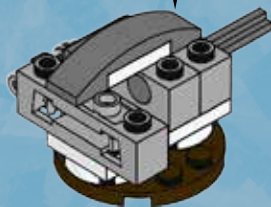
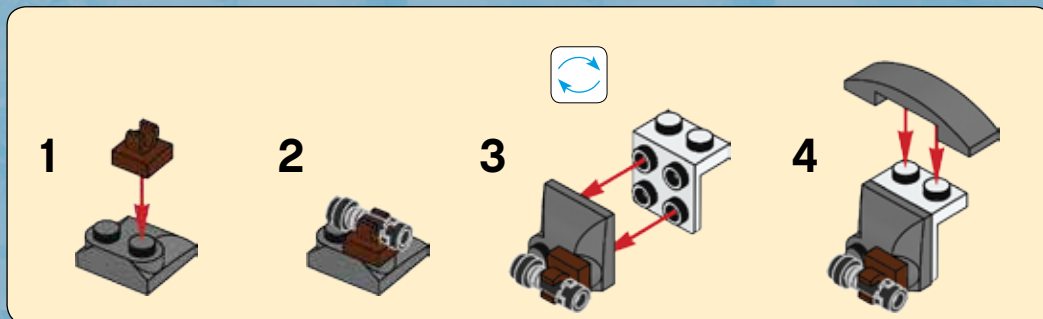

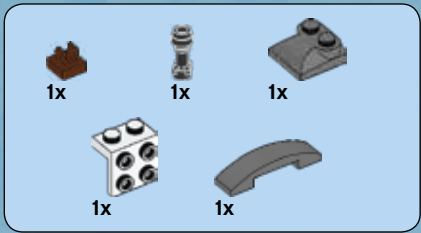

8

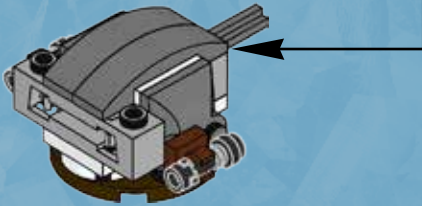
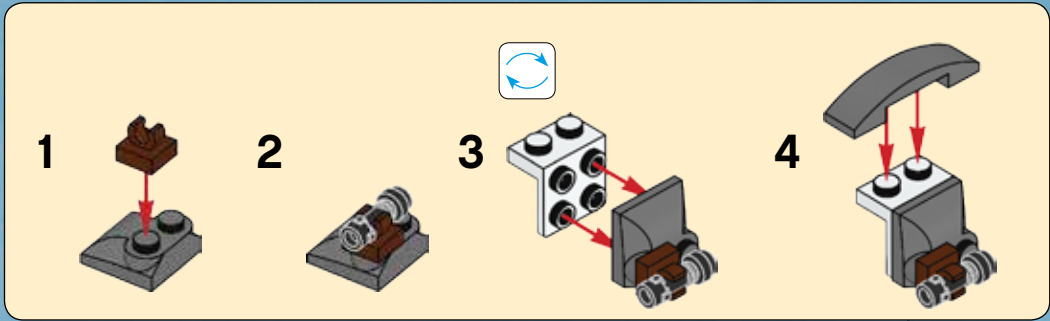

9

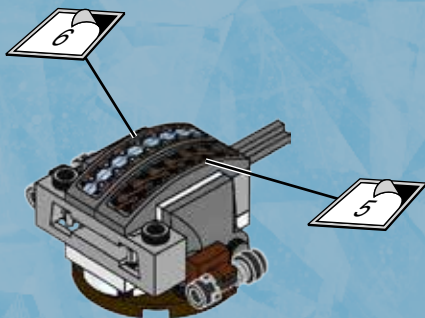

22

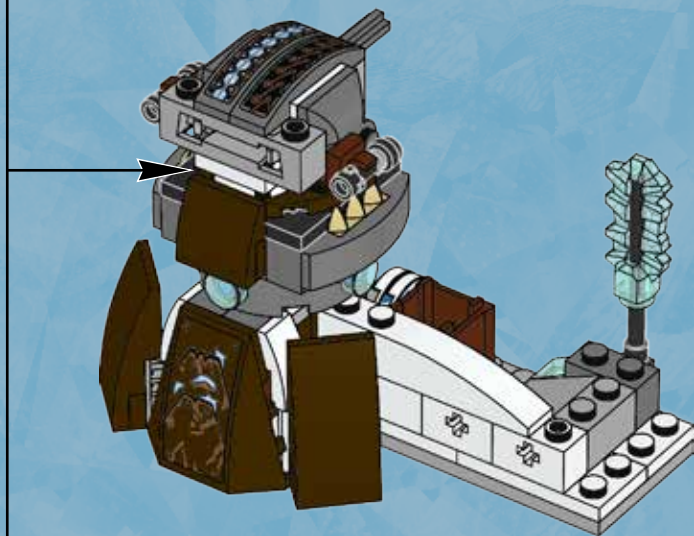



23

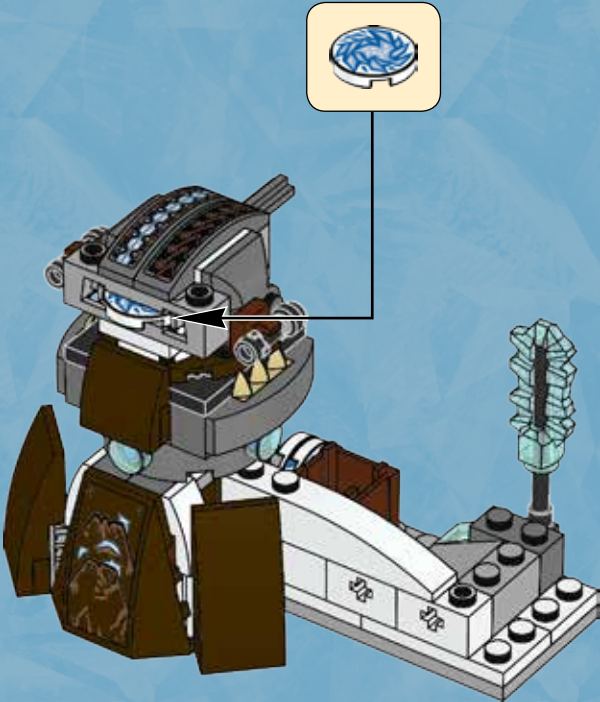

24

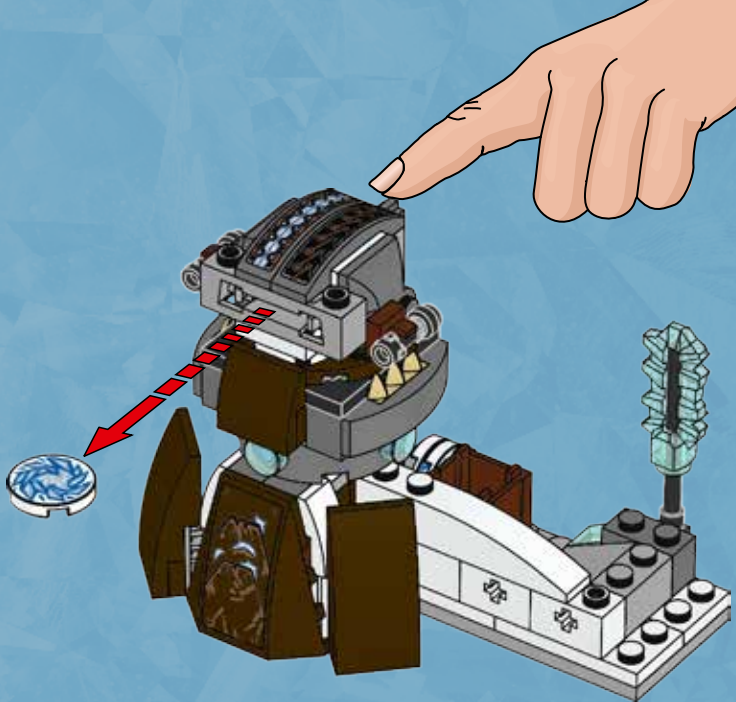

52

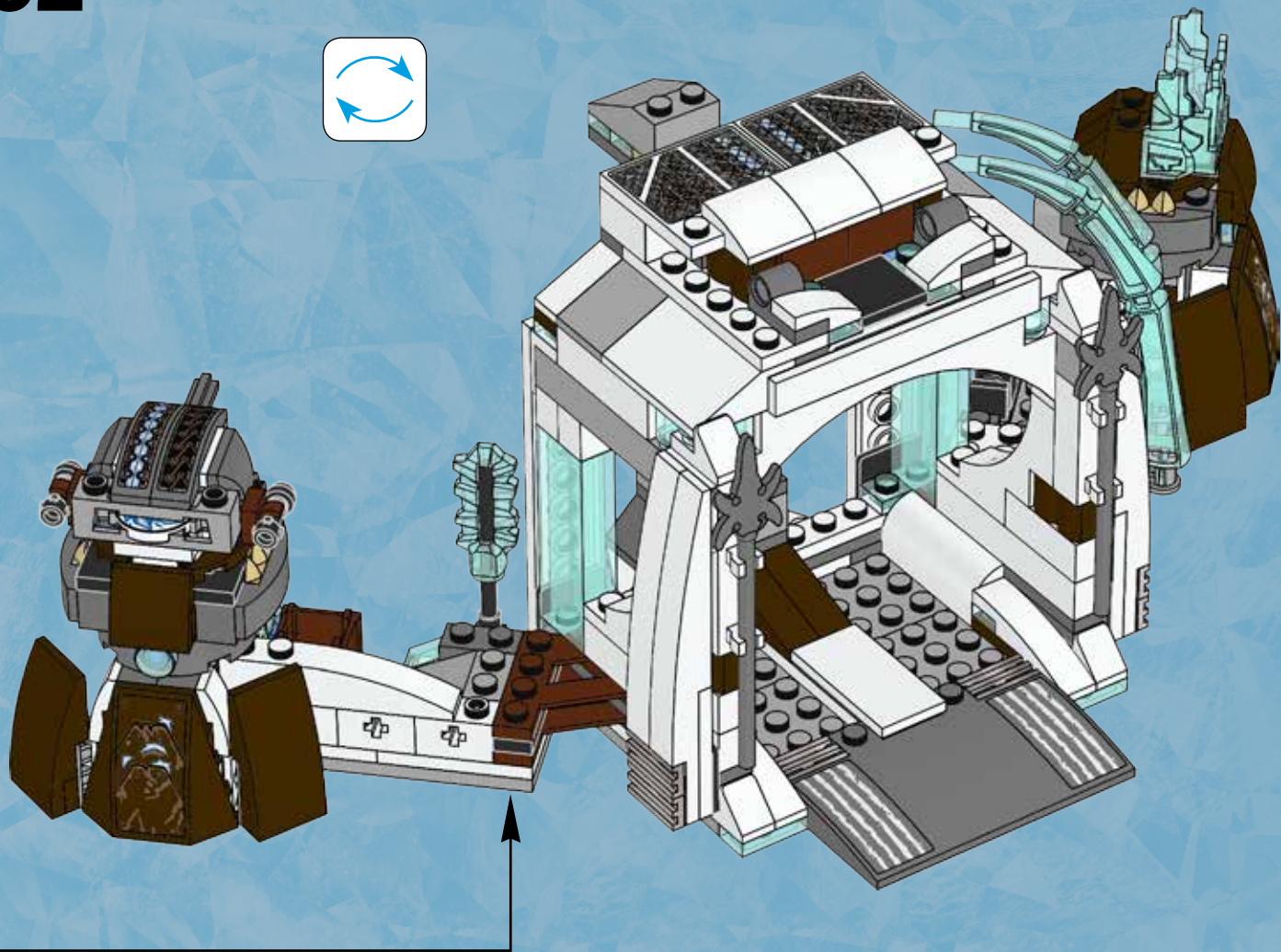



1x

53

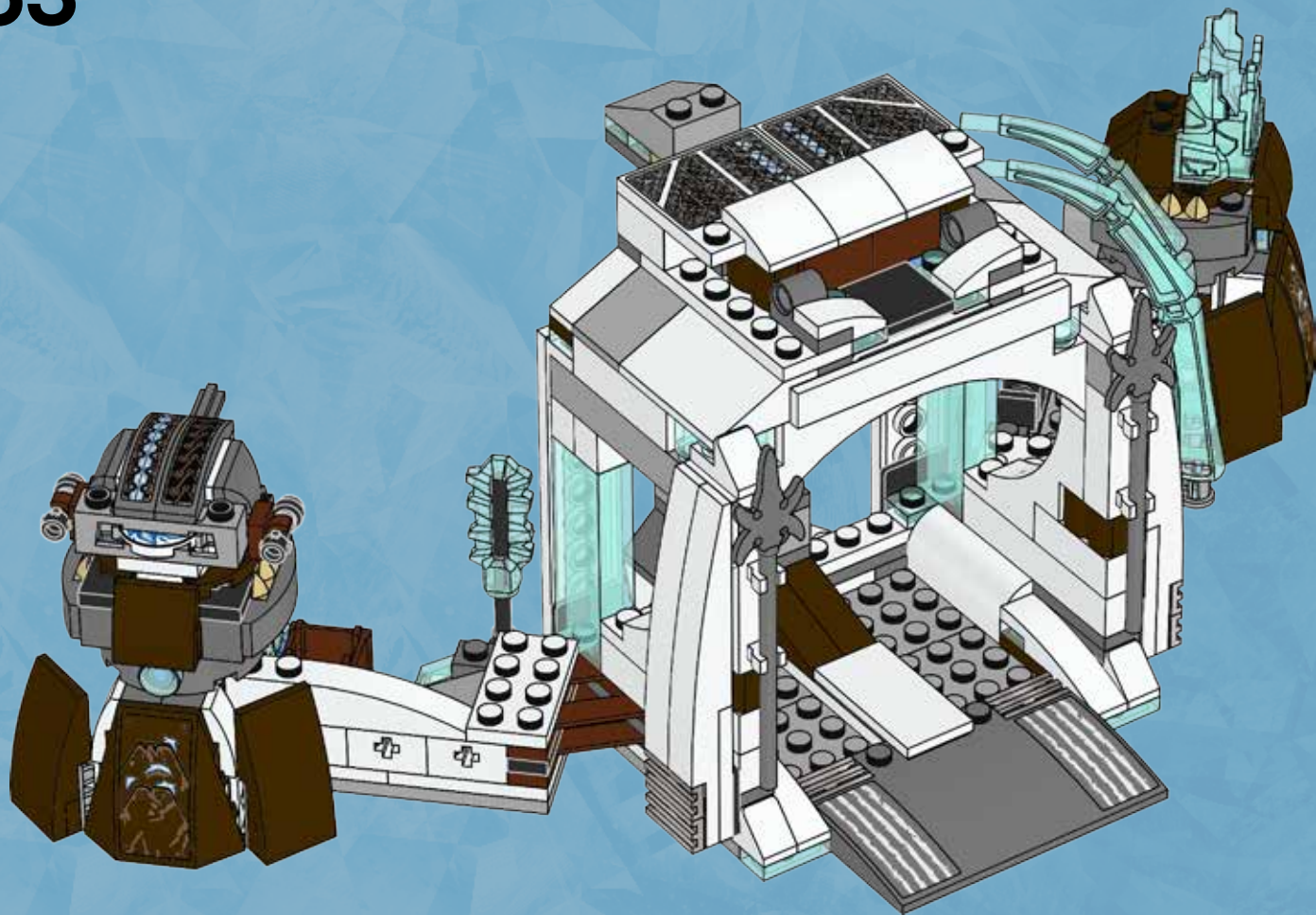

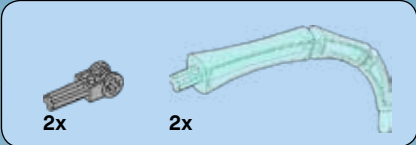

54

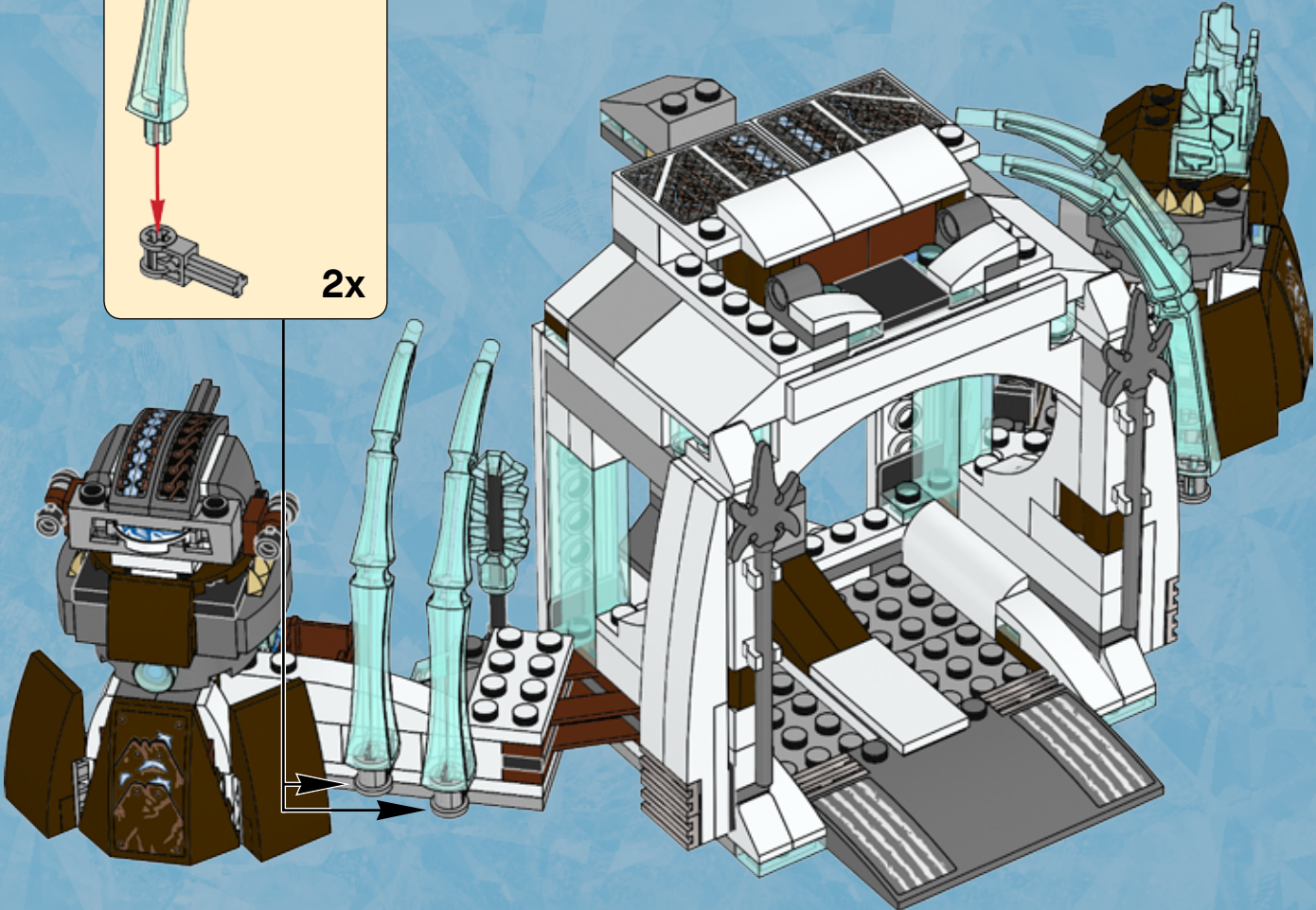
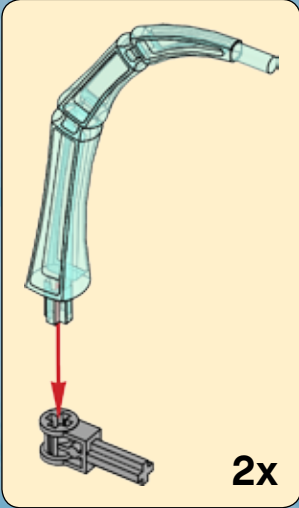

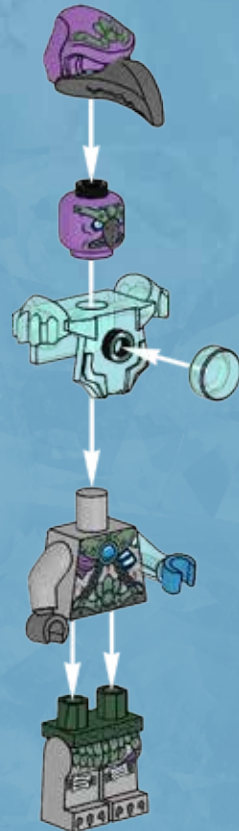
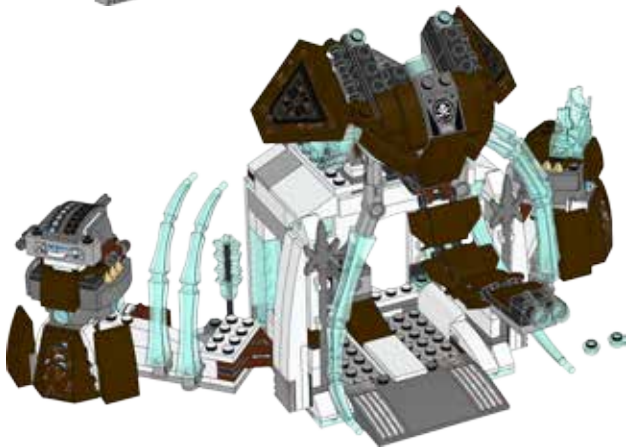
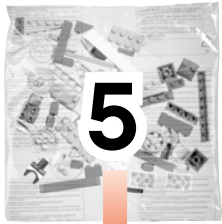

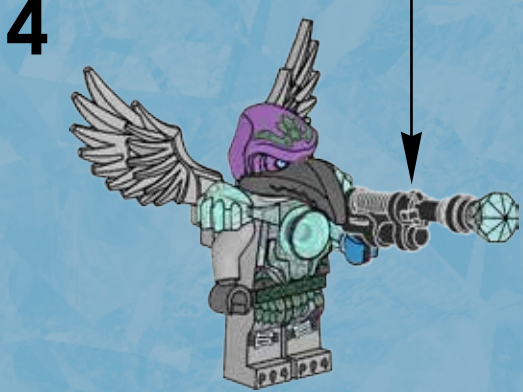
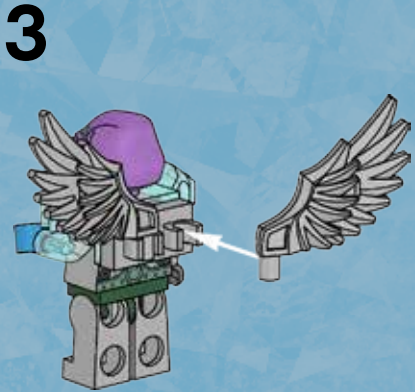
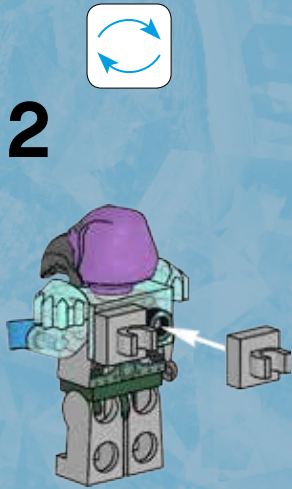
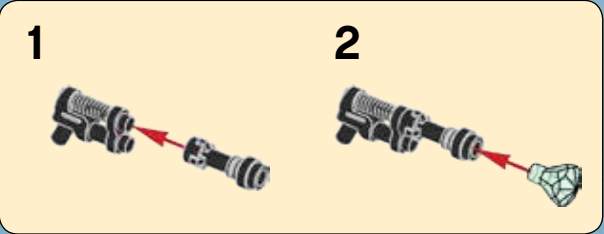

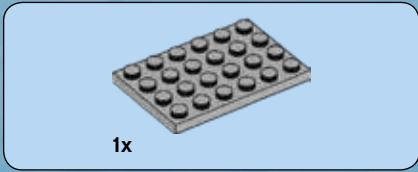
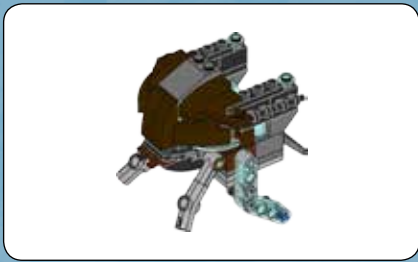

1



2





1x



2x

3

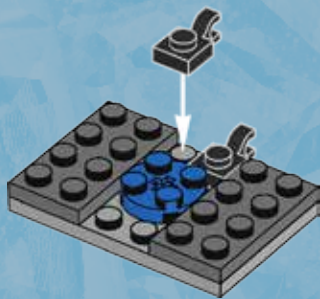

2x

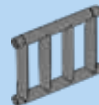

1x

4



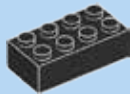

1x



2x

5

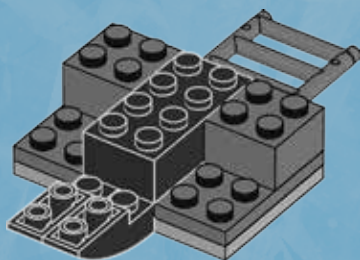

2x



4x

6

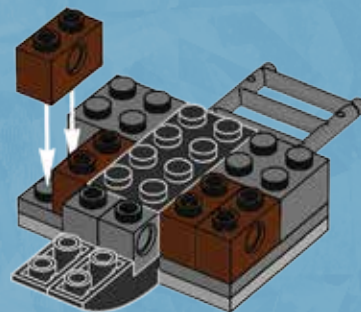



2x



2x

7

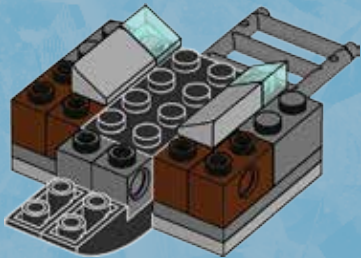

2x

8

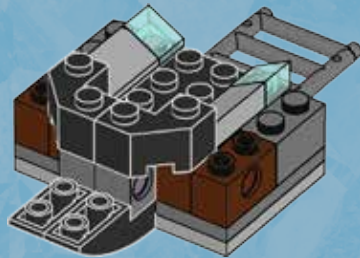



2x



2x

9

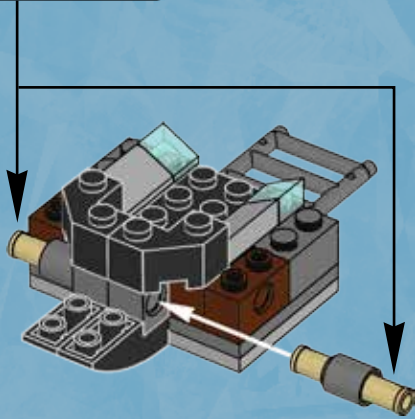
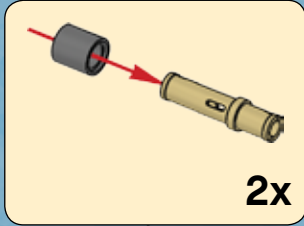

10



2x

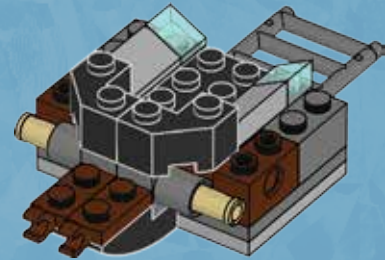

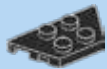

1x

11

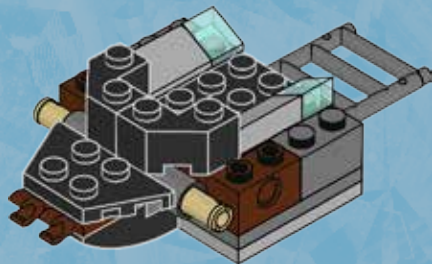

2x



1x

12

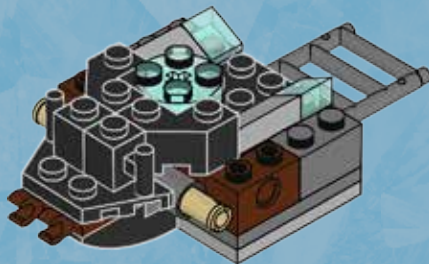



2x



2x



2x

13

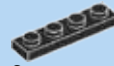
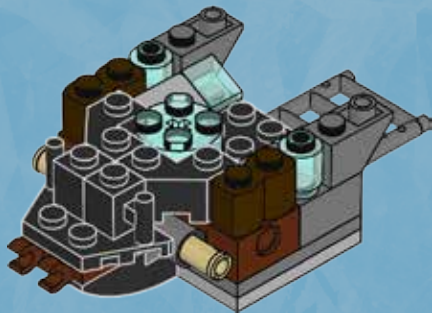

2x

14

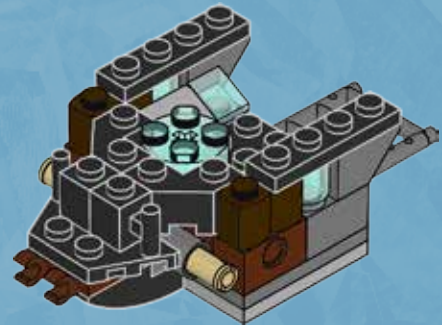



2x



1x

15

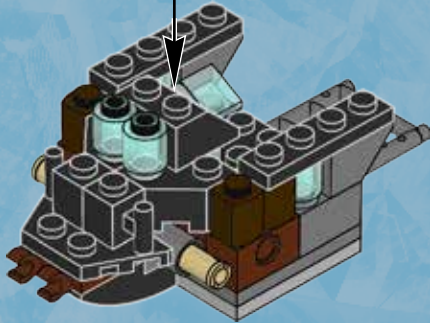

2x



2x

16

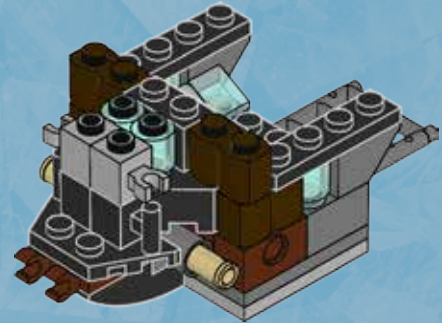



1x



1x

17

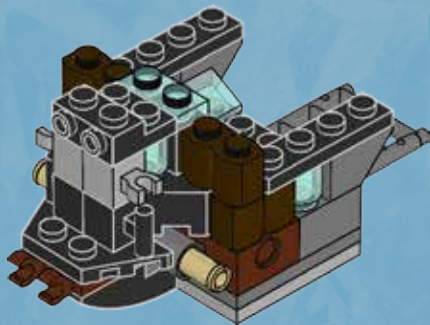

4x

18

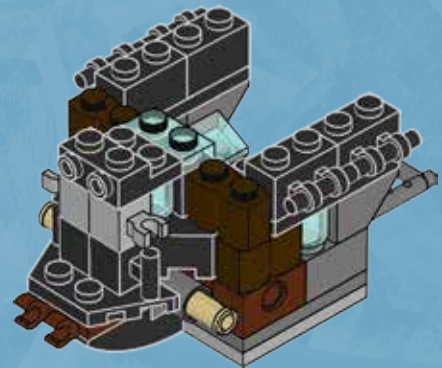



2x

19

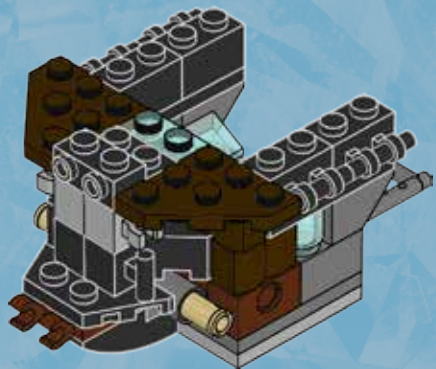

3x



2x



1x

20

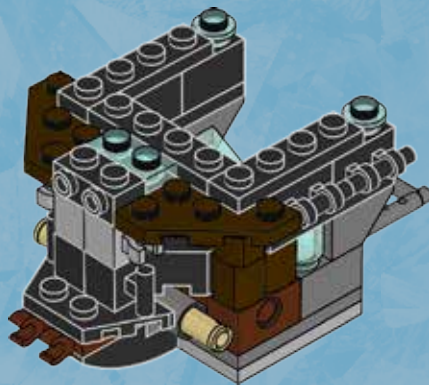



21

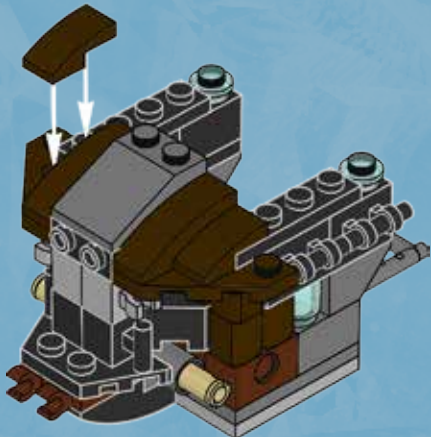

22

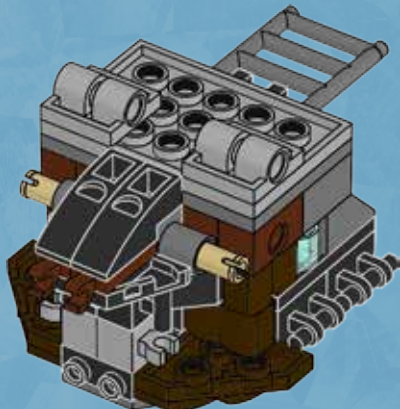



2x



2x

23

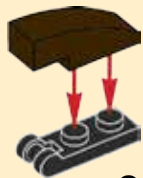

2x

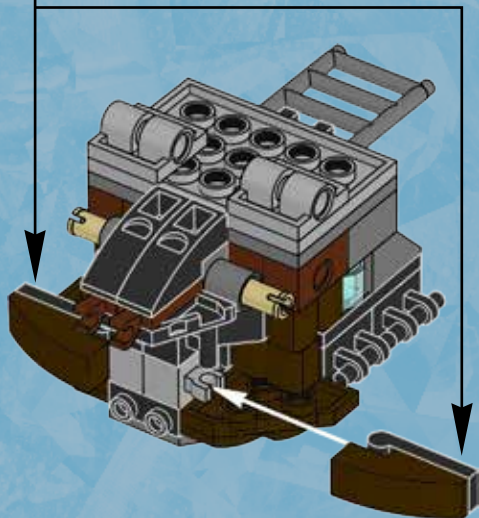

2x

24

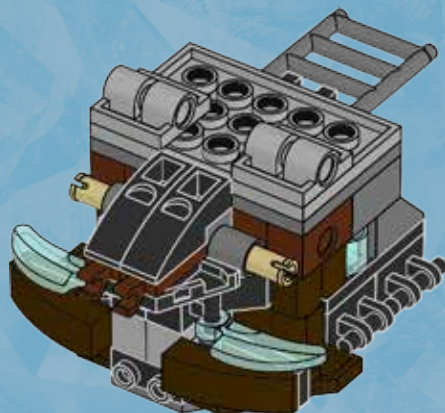



2x



1x

25

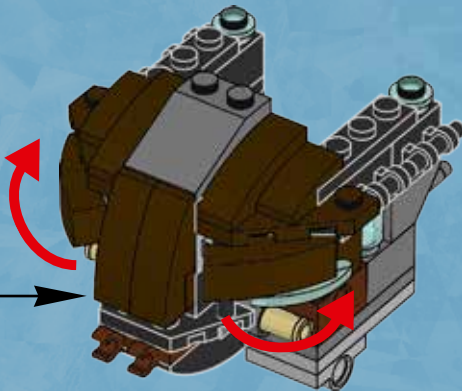
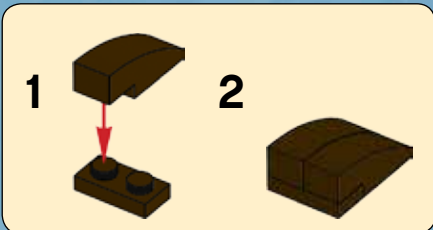
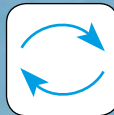



26

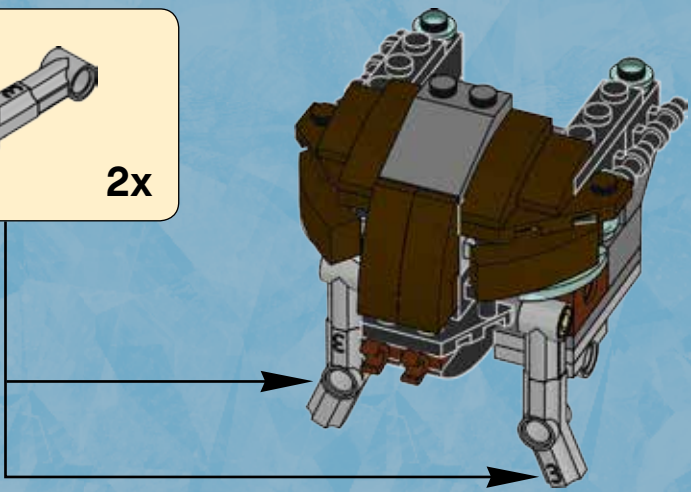
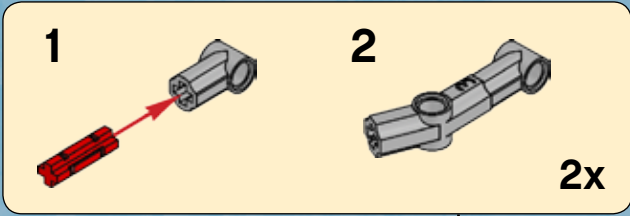

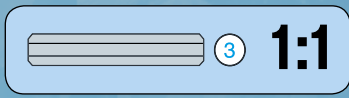
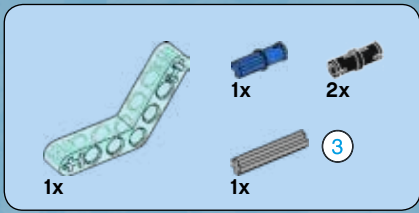

27

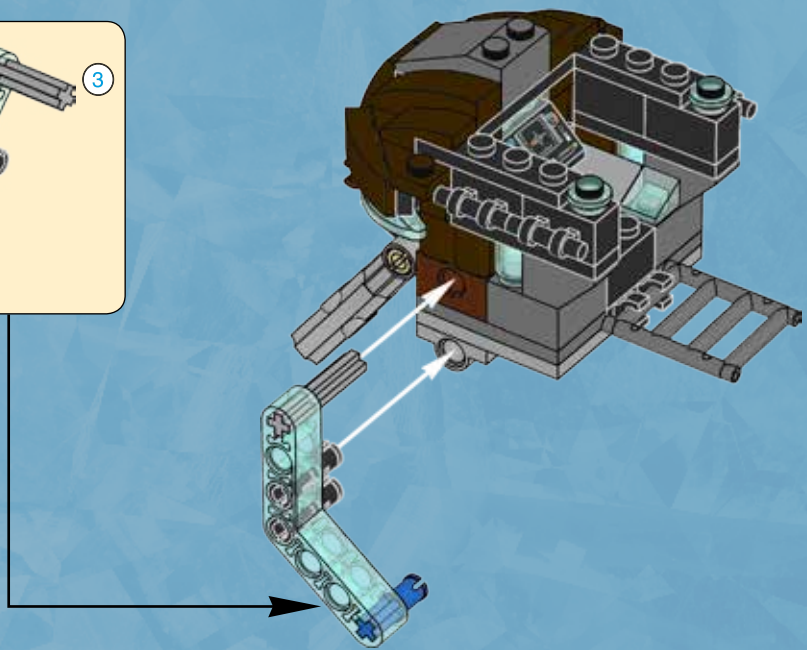
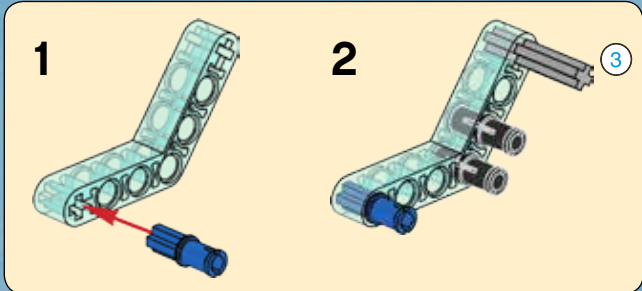

55

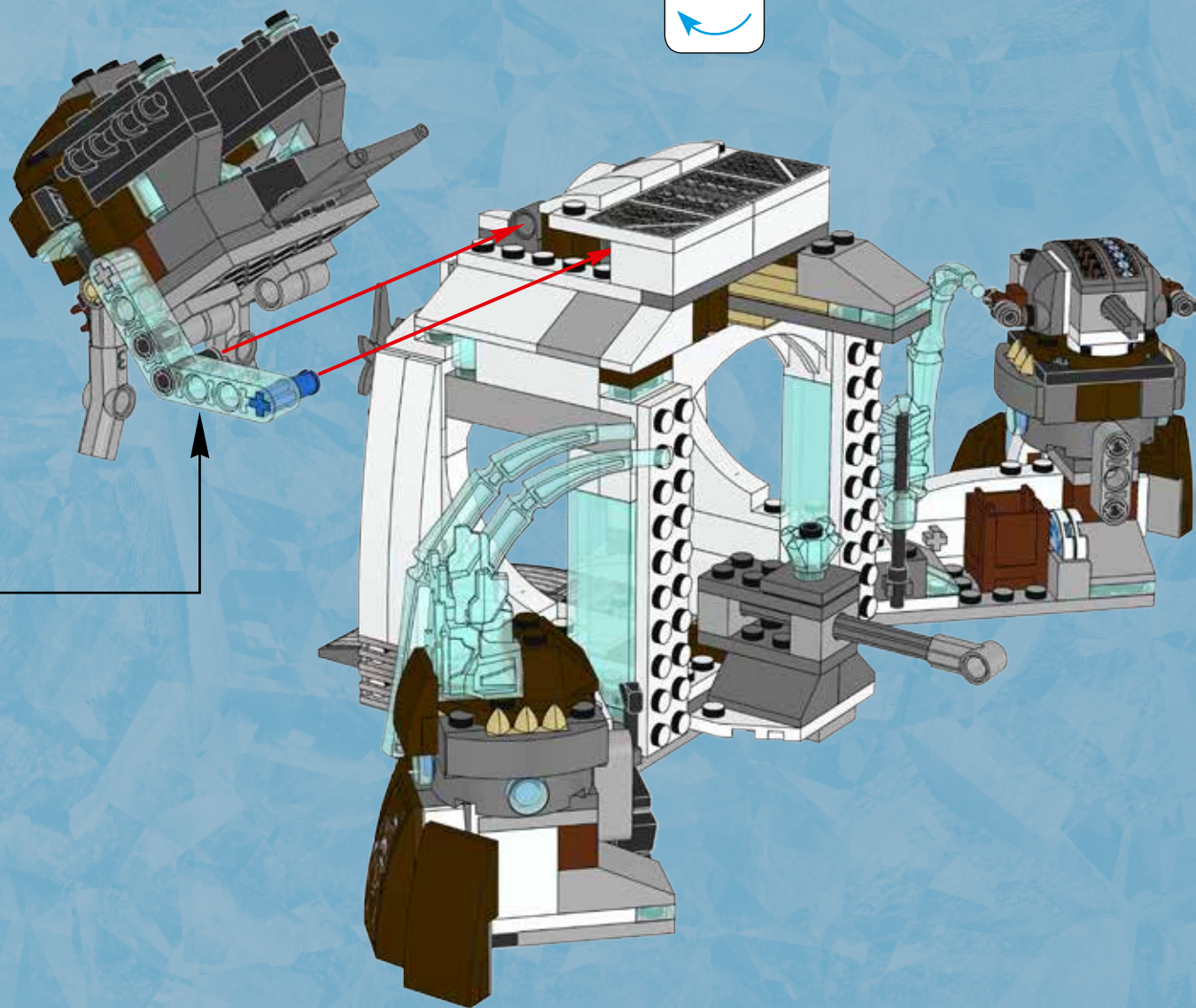
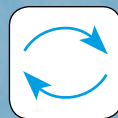

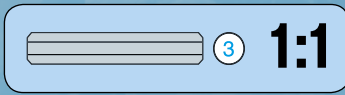
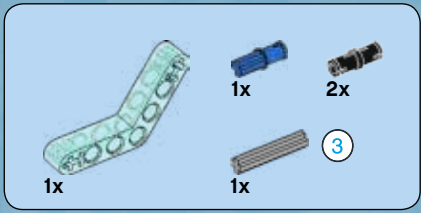

56

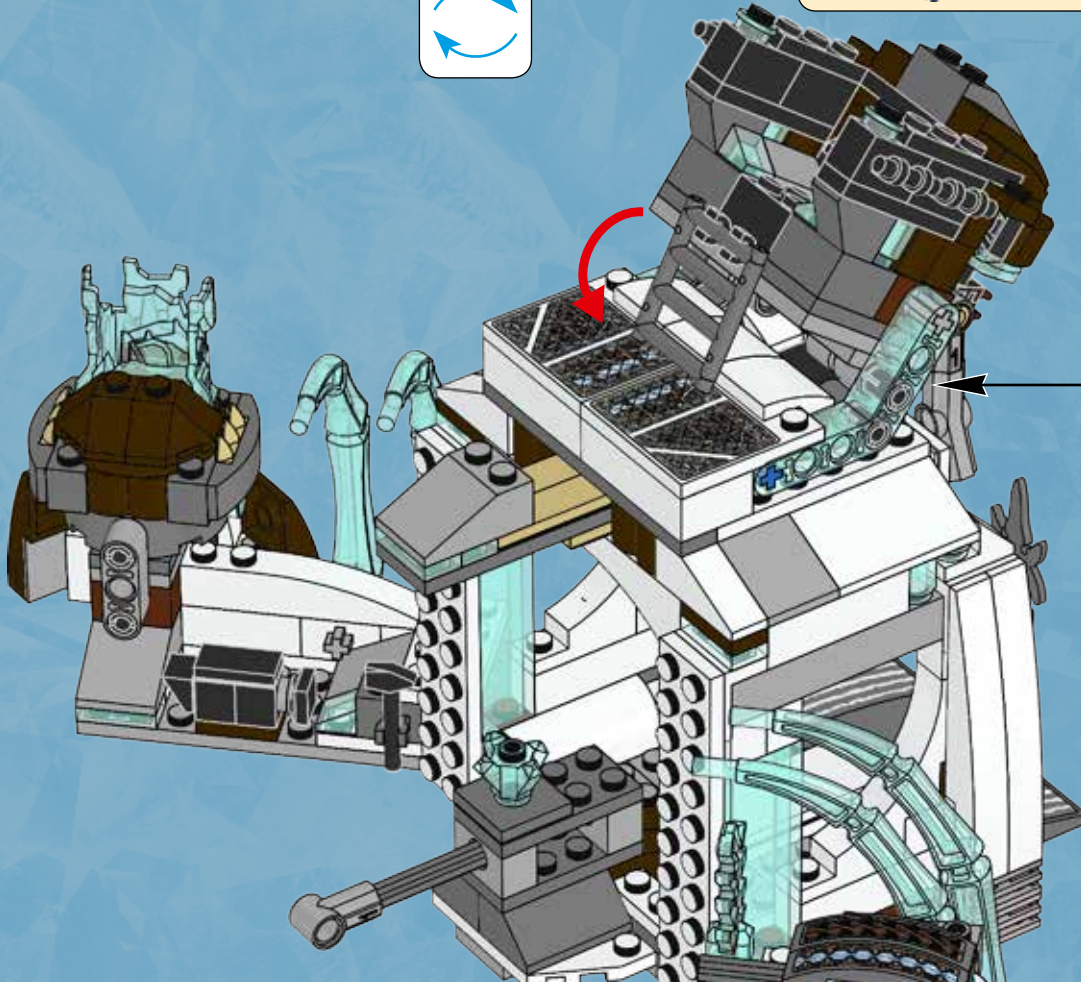
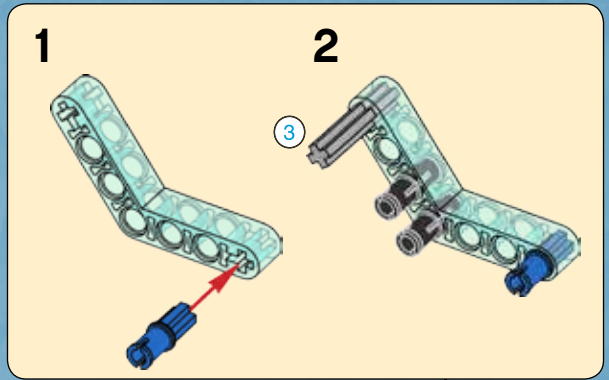



2x

57

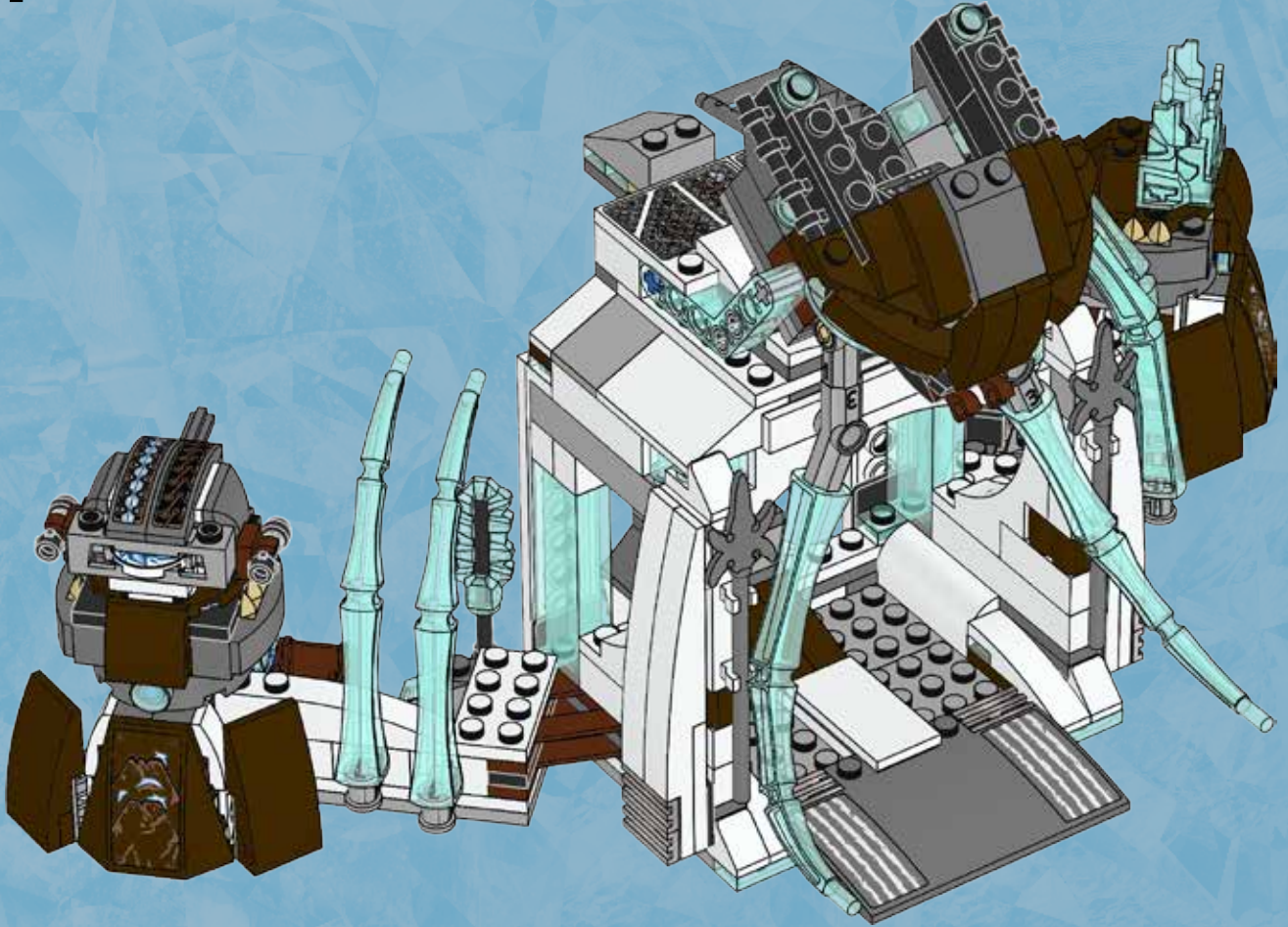

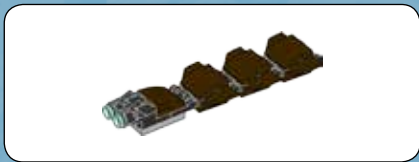

1

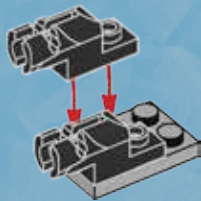

2

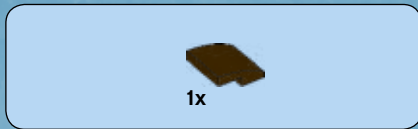
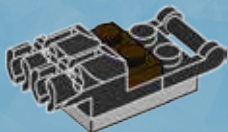

3

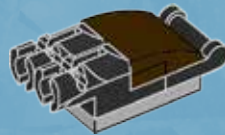

4

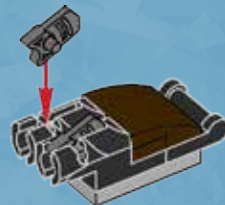

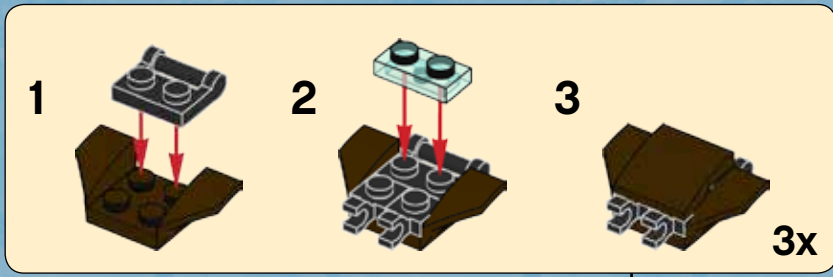
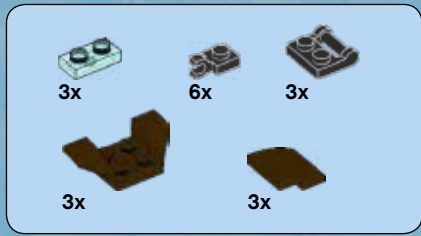

5

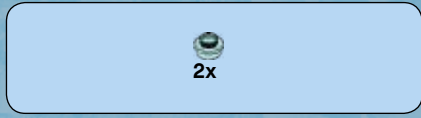
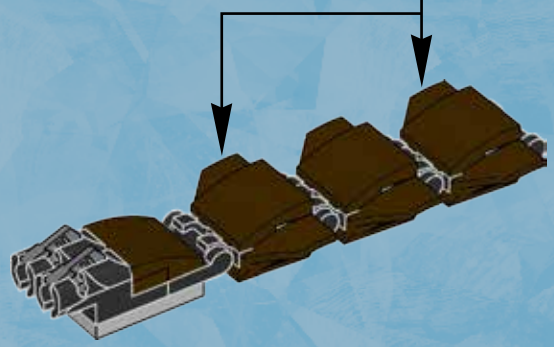

6

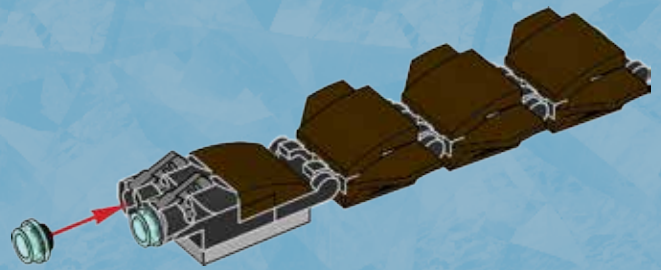

58

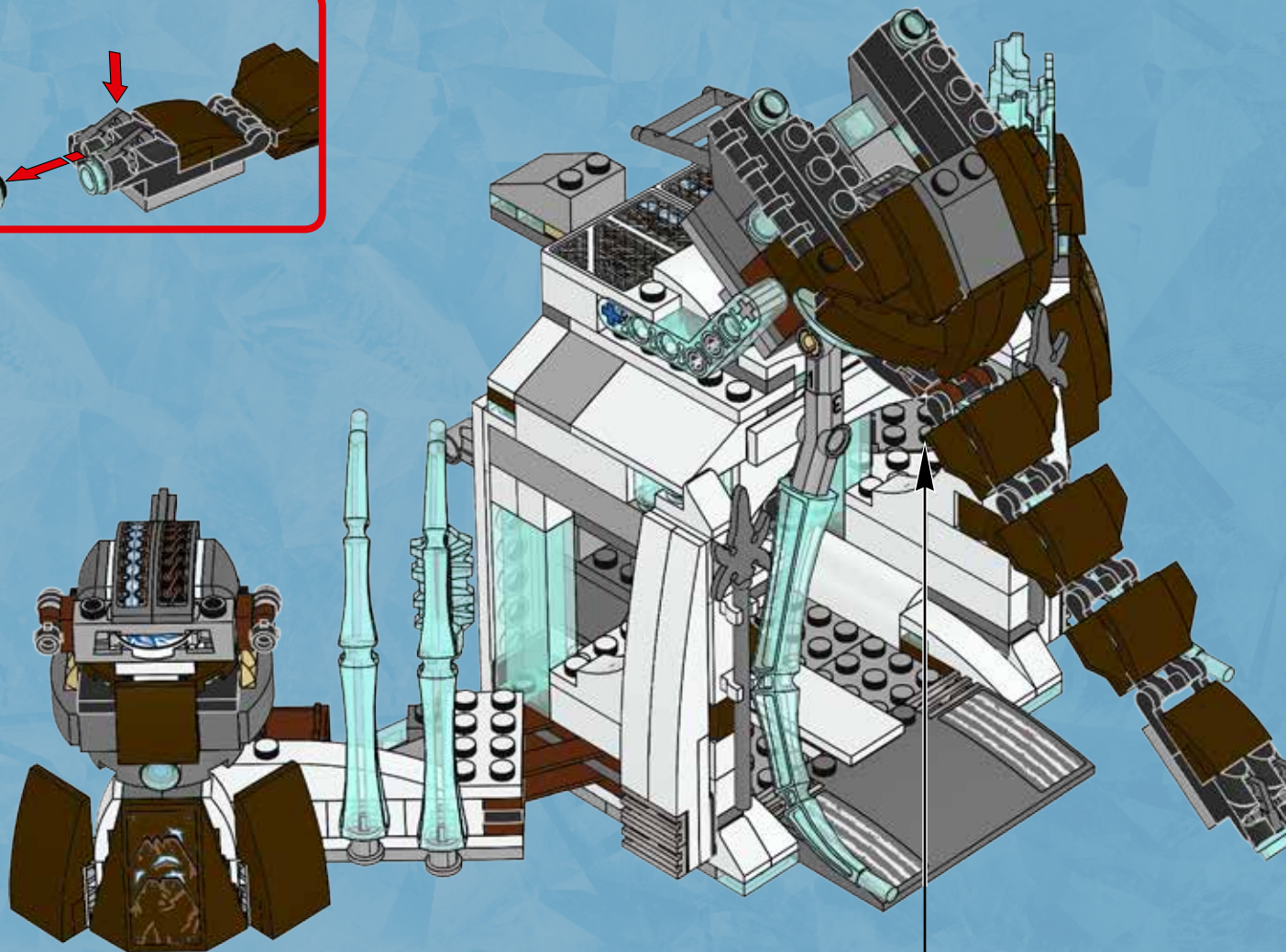
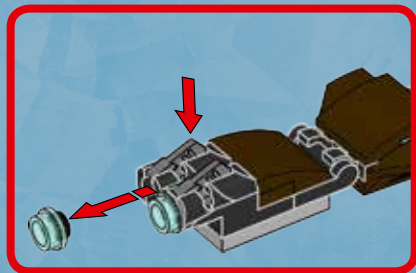



2x

59

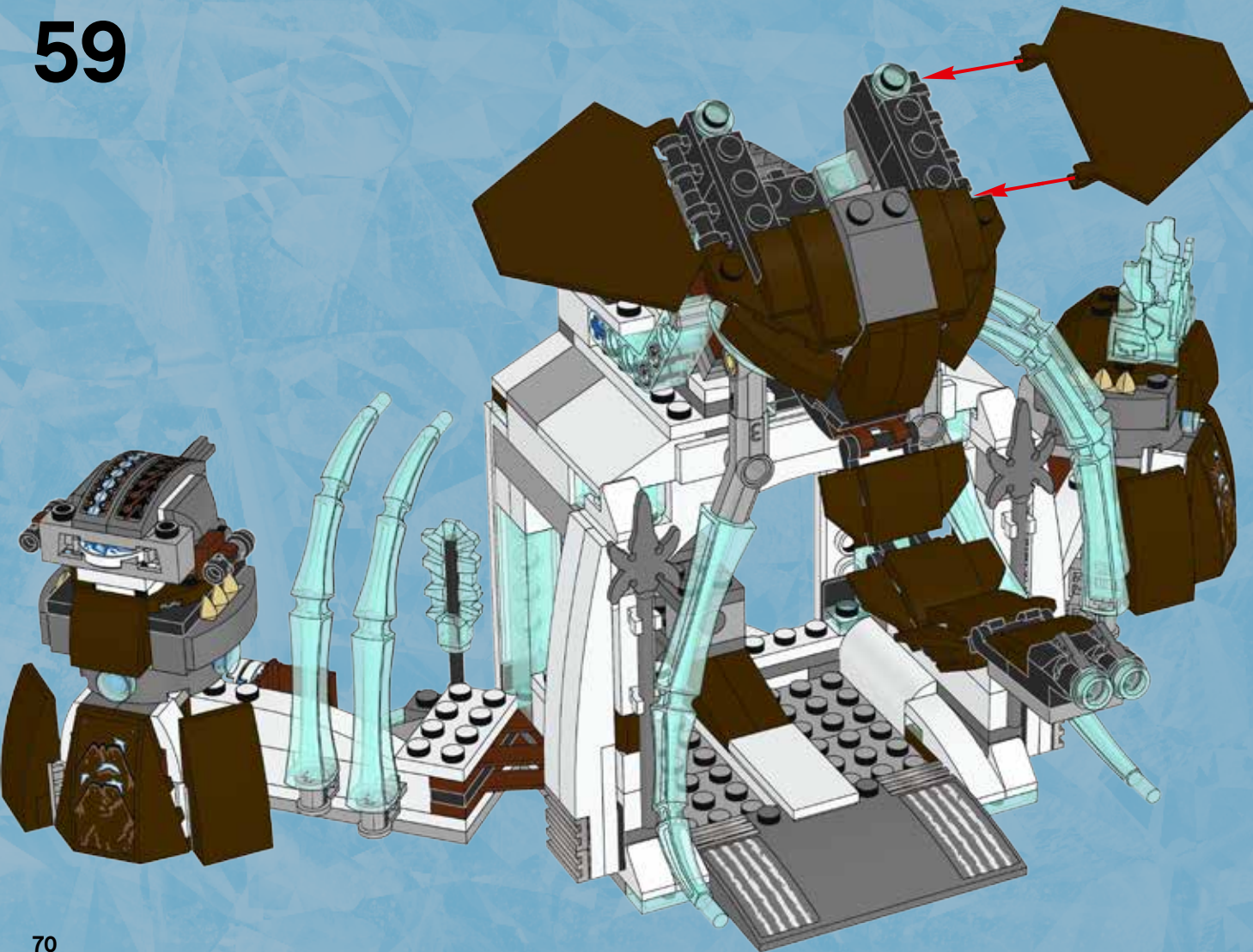

60

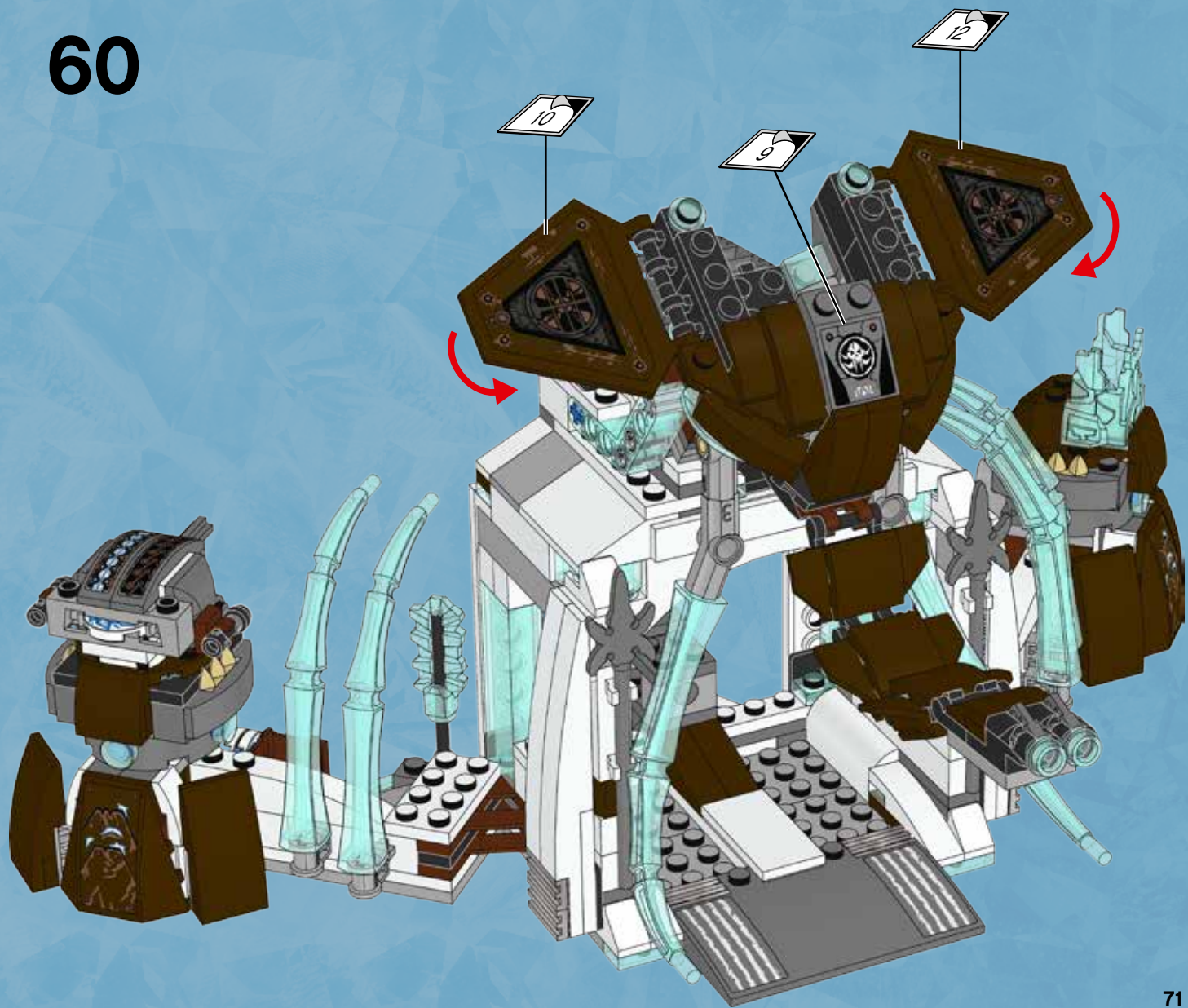

61

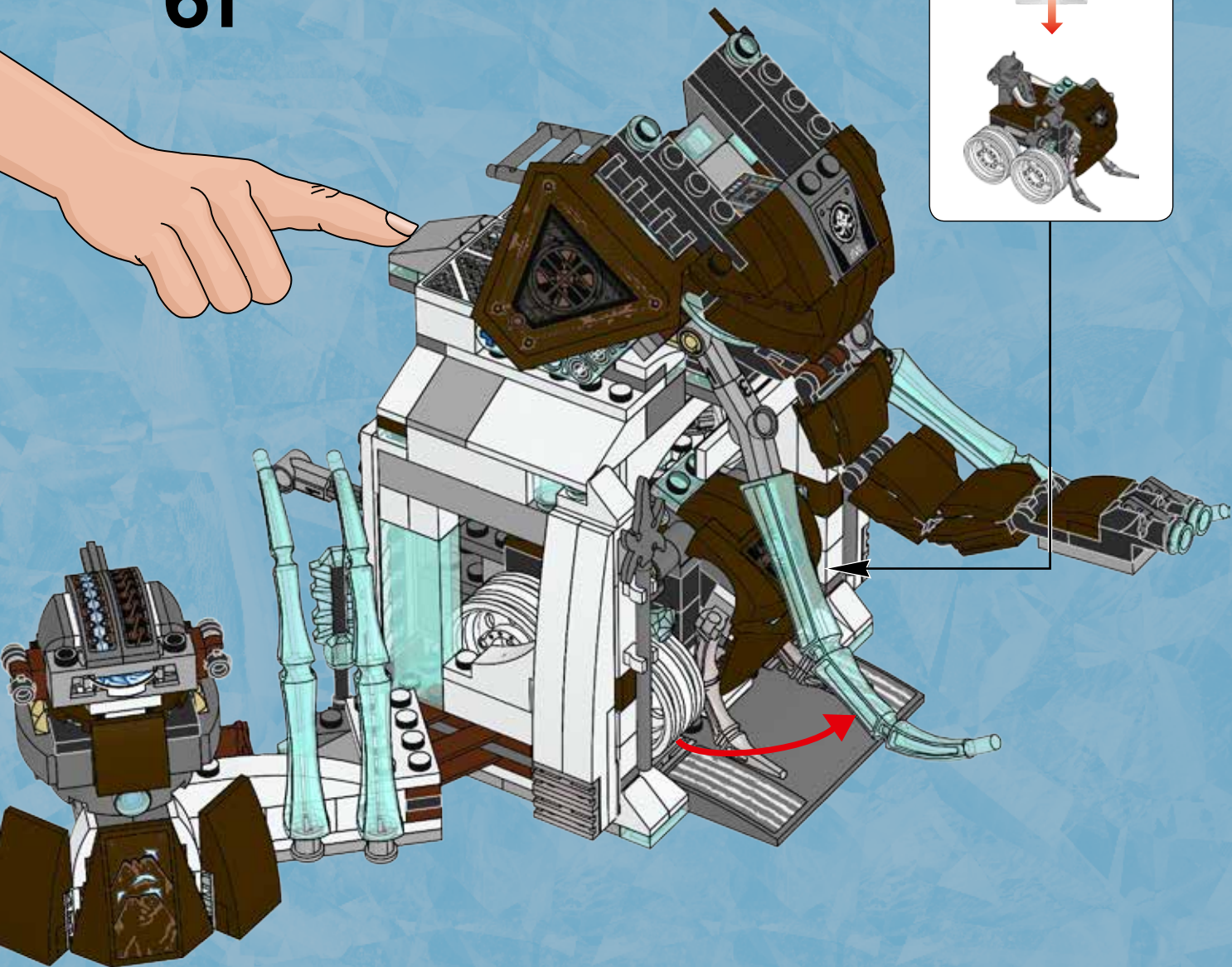
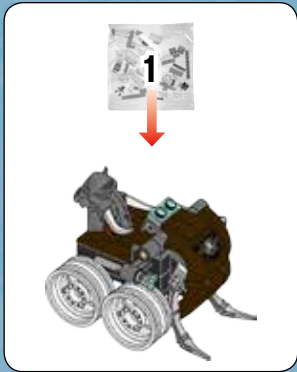
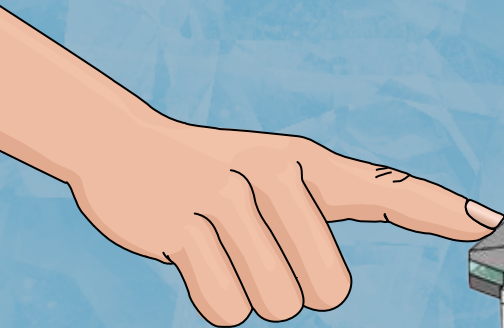

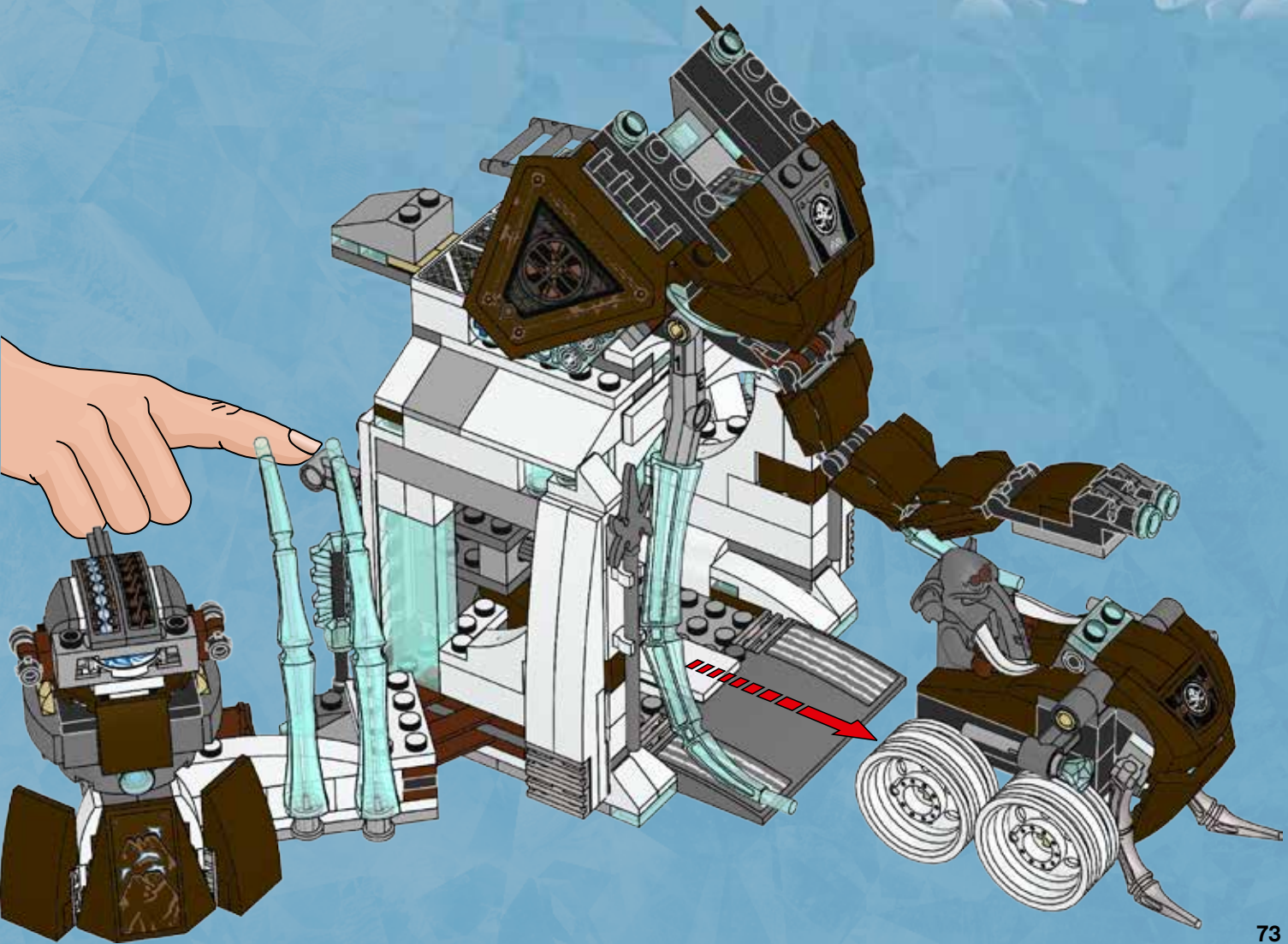

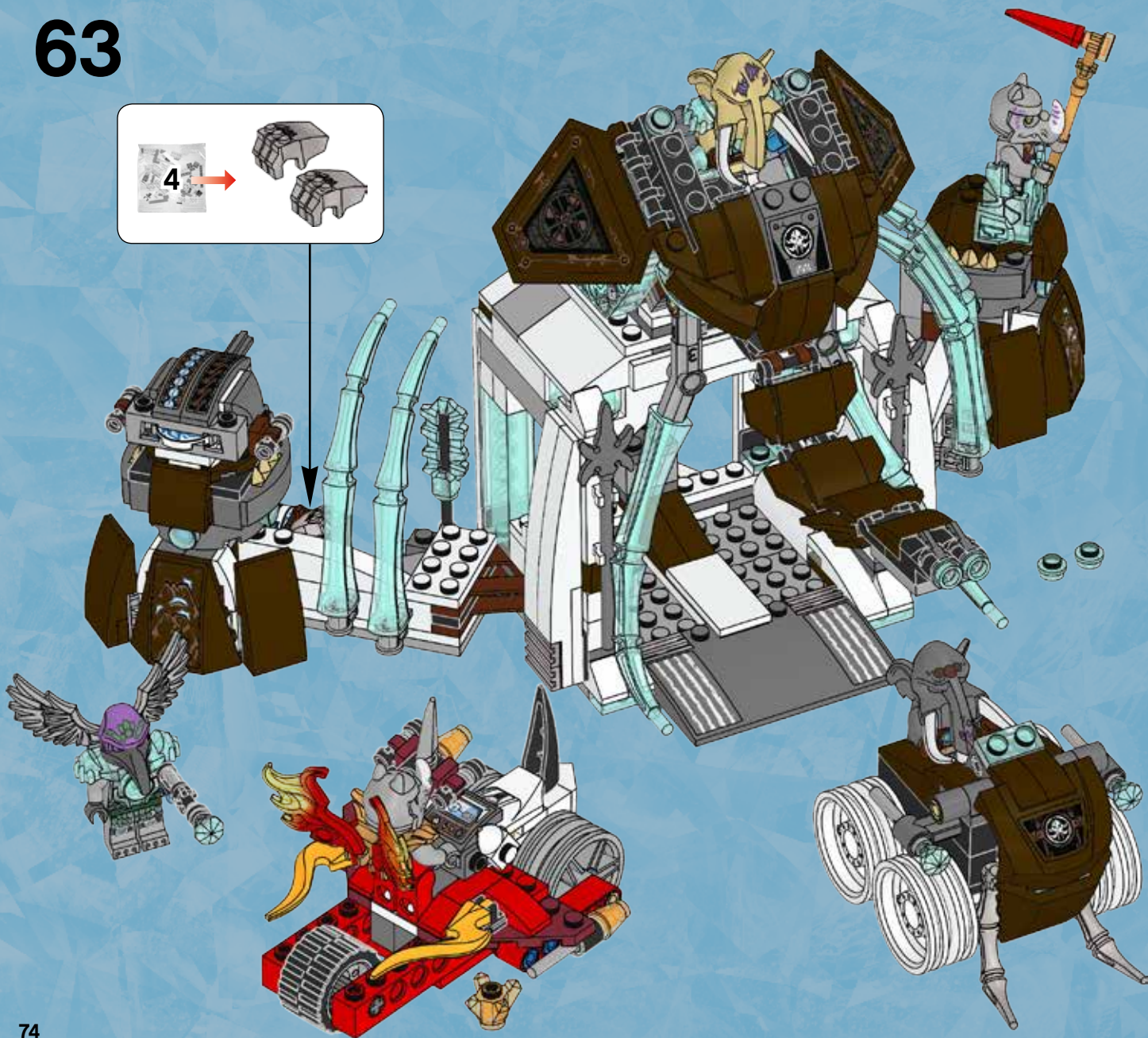
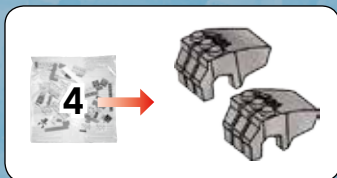

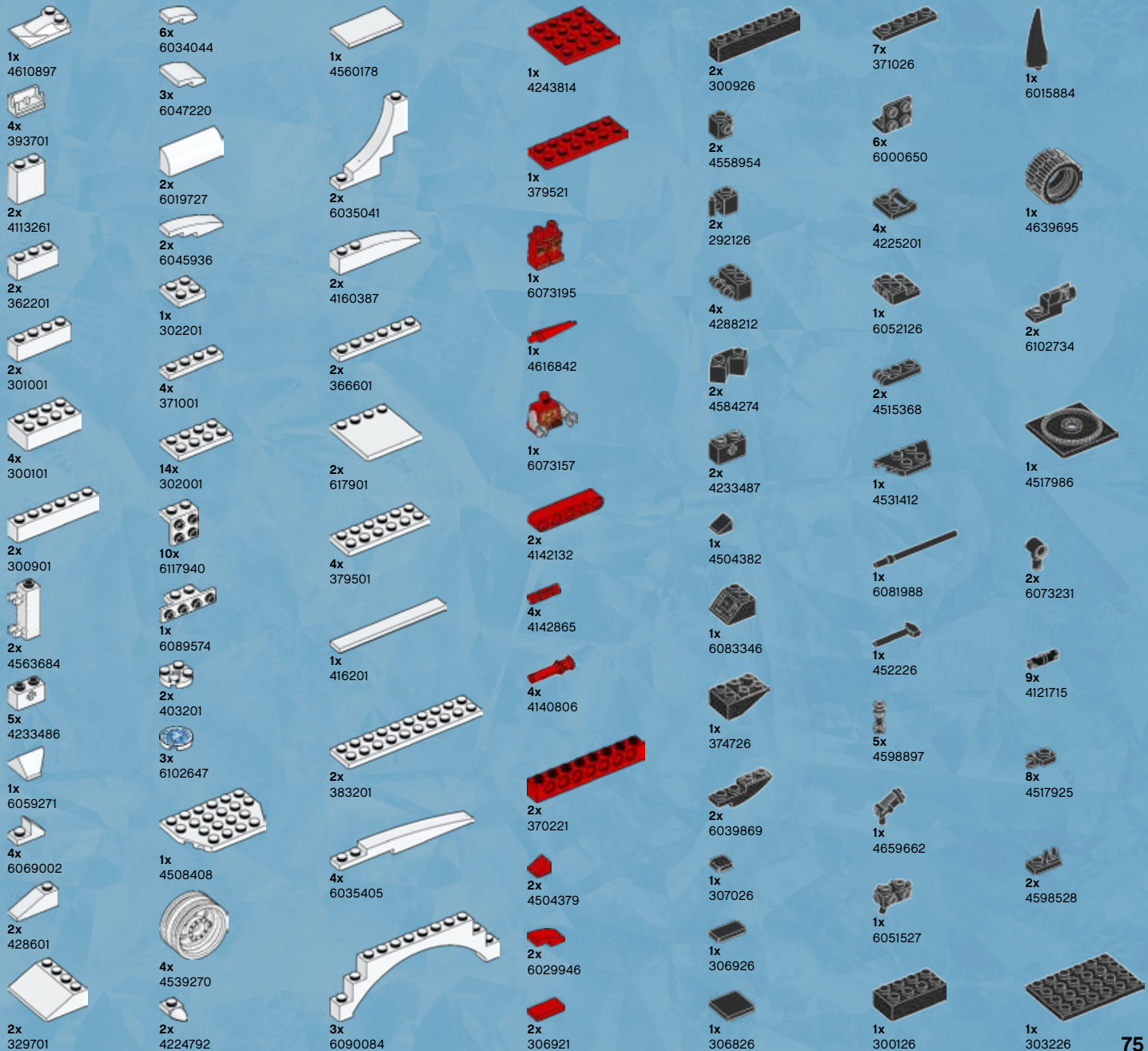



2x
4211392



4x
4533772



4x
4211440



1x
6075075



2x
4568637



7x
4211421



2x
6071229



4x
4211396



1x
4211404



2x
4211402

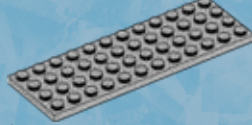

2x
4211401



1x
6028812



1x
6075646



1x
6075649



1x
6116216



1x
6116008



1x
6054537



1x
6057418



1x
6055323



1x
6055256



2x
6074698



1x
4616840



1x
4490127



2x
4541318



4x
4211881



1x
6096150



4x
4520320



2x
4211655



3x
4211550



2x
4211552



2x
4211815



4x
4211536



6x
4211376



1x
4215513



1x
4211515



2x
4211097



4x
4210639



2x
4210762



2x
4213607



2x
4567887



2x
4211096



2x
4218188



1x
4211106



1x
6071261



6x
4648256

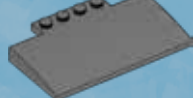

1x
6055166



6x
4211094



1x
4565322



1x
4261908



2x
4218696



2x
6051334



4x
6100030



2x
4210658



1x
4521886



2x
6083620



1x
4499858



3x
4211060



2x
4210875



2x
4265794



8x
4210725



6x
4211133



4x
6019987



1x
4221879



2x
6000606



1x
6074862



1x
6074804



1x
6108726



1x
6109932



4x
4211065



3x
4210998



1x
4211067



2x
4210886

2x
4216668

6x
4211252

4x
4211152

2x
6071274

2x
6008297

4x
6084573

1x
4520638

2x
6071259

1x
6081992

1x
4640843

1x
6115422

2x
4283915

10x
4183544

3x
4178398

4x
6073445

27x
6051918

8x
4163917

8x
6022171

3x
4119482

1x
6019570

1x
6053028

2x
6070887

2x
6071312

1x
6065032

2x
6064825

6x
6064988

1x
4243815

1x
403223

6x
4143005

6x
4206482

6x
6046943

6x
6047037

6x
6022199

4x
6032854

3x
6051188

13x
6058221

2x
6005030

2x
4650257

2x
6095804

3x
6096940

1x
6051183

14x
4519970

2x
6034202

4x
4519742

1x
6074574

1x
6074415

2x
6024495

4x
4544139

1x
6108732

1x
6109897

4x
6046907

6x
4666579

4x
4514554

7x
4619636

1x
4633691

2x
6037408

2x
6093626

1x
6075229

1x
6070630

2x
6097662

2x
6071222

2x
4539070

3x
4567338

1x
4280341

1x
6074926

1x
6066085

2x
6099396

1x
4654448

Customer Service

Kundenservice

Service Consommateurs

Servicio Al Consumidor

LEGO.com/service or dial



: 00800 5346 5555

: 1-800-422-5346



LEGENDS OF CHIMA™



LAVAL
70227



CRAGGER
70227



ROGON
70226



BLADVIC
70225



GORZAN
70222

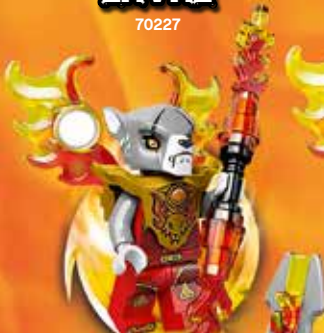

WORRIZ
70220



RAZAR
70223



ERIS
70224



CROMNIUS
70227



CROKENBURG
70231



TORMAK
70222



RINONA
70226



TAZAR
70224



TRAKKAR
70224



BREEZOR
70224



FLINX
70221

A white feline minifigure with a blue and white patterned tunic, holding a large, multi-bladed sword.

SIR FANGAR

70224

A brown feline minifigure with a blue and white patterned tunic, holding a large, multi-bladed sword.

STRAINOR

70227

A white feline minifigure with a blue and white patterned tunic, holding a large, multi-bladed sword.

ICEPAW

70227

A white feline minifigure with a blue and white patterned tunic, holding a large, multi-bladed sword.

ICECLAW

70225

A purple feline minifigure with a blue and white patterned tunic, holding a large, multi-bladed sword.

VORNON

70225

A yellow feline minifigure with a blue and white patterned tunic, holding a large, multi-bladed sword.

ICEBITE

70223

A brown feline minifigure with a blue and white patterned tunic, holding a large, multi-bladed sword.

SYKOR

70232

A brown feline minifigure with a blue and white patterned tunic, holding a large, multi-bladed sword.

SARAW

70227

A white feline minifigure with a blue and white patterned tunic, holding a large, multi-bladed sword.

SIBRESS

70224

A white feline minifigure with a blue and white patterned tunic, holding a large, multi-bladed sword.

LI'ELLA

70229

A grey elephant minifigure with a blue and white patterned tunic, holding a large, multi-bladed sword.

MAULA

70226

A yellow elephant minifigure with a blue and white patterned tunic, holding a large, multi-bladed sword.

MOTTROT

70226

A brown feline minifigure with a blue and white patterned tunic, holding a large, multi-bladed sword.

SIROX

70232

A white feline minifigure with a blue and white patterned tunic, holding a large, multi-bladed sword.

ICERLOT

70230

A brown feline minifigure with a blue and white patterned tunic, holding a large, multi-bladed sword.

BULKAR

70223

A purple feline minifigure with a blue and white patterned tunic, holding a large, multi-bladed sword.

VARDY

70226

A white feline minifigure with a blue and white patterned tunic, holding a large, multi-bladed sword.

VOOM VOOM

70221

A brown feline minifigure with a blue and white patterned tunic, holding a large, multi-bladed sword.

STRAINOR

70220

A white feline minifigure with a blue and white patterned tunic, holding a large, multi-bladed sword.

ICEPAW

70223



LEGENDS OF CHIMA™



70227



70225



70226





LEGENDS OF CHIMA™



70220

70221

70222

70223

70224



LEGENDS OF
CHIMA™



70223

70231

70224

70232

70229

70230



70229



70230



70231



70232

LEGO.COM/CHIMA



club™



**JOIN
FREE TODAY!**

**JOIGNEZ-VOUS
GRATUITEMENT!**



MAGAZINE INCLUDES:

- > Building Ideas and Game Tips
- > Kids' Creations
- > Comic Adventures



LE MAGAZINE COMPREND :

- > Des idées de construction
- > Des créations super cool
- > Des bandes dessinées

2



3



LEGO.com/club | 1-877-518-5346