

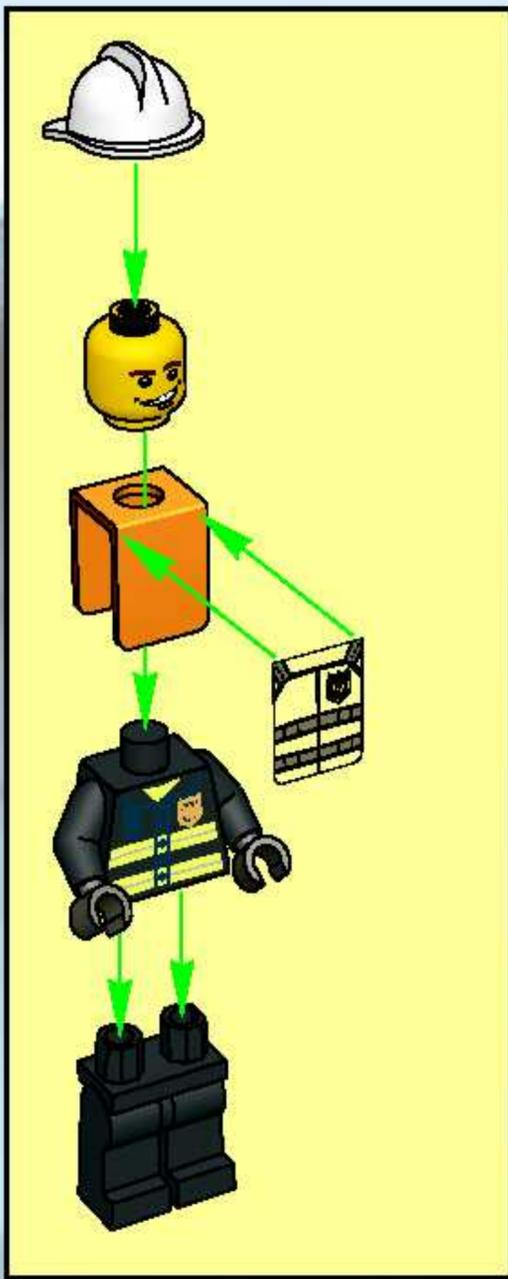

World City ↑

7046





1

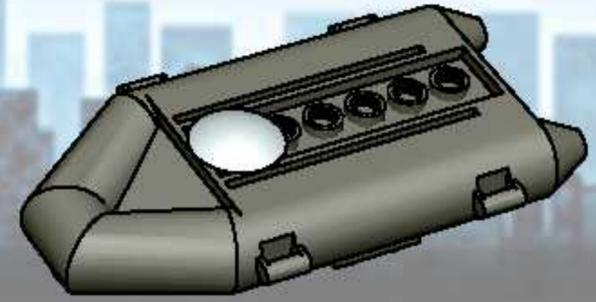

2

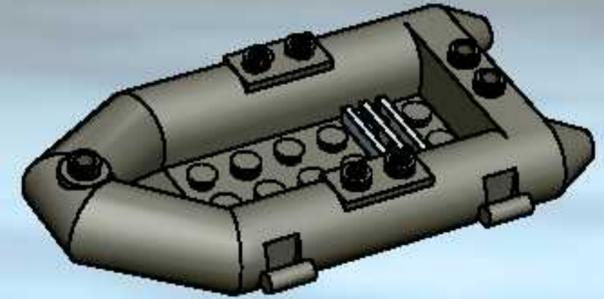

3

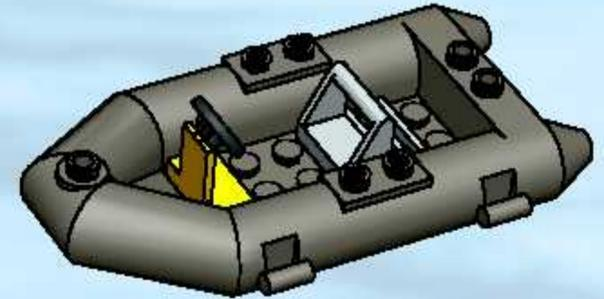

4

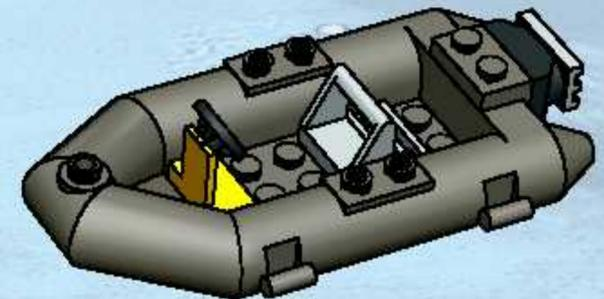

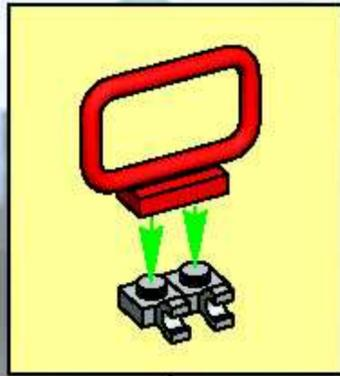

5

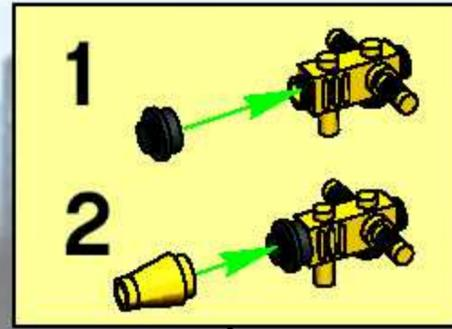
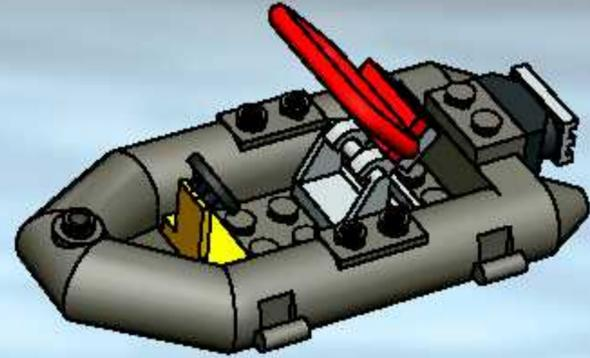

7

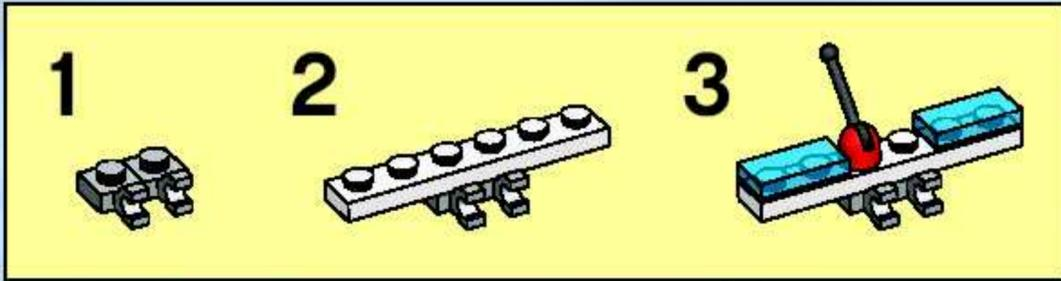
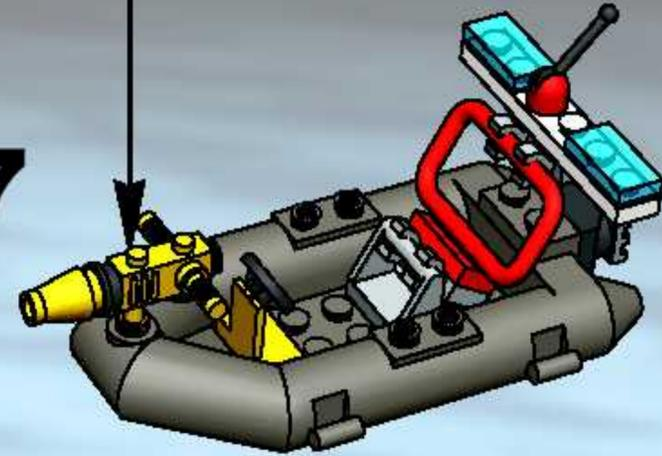

6



8





1

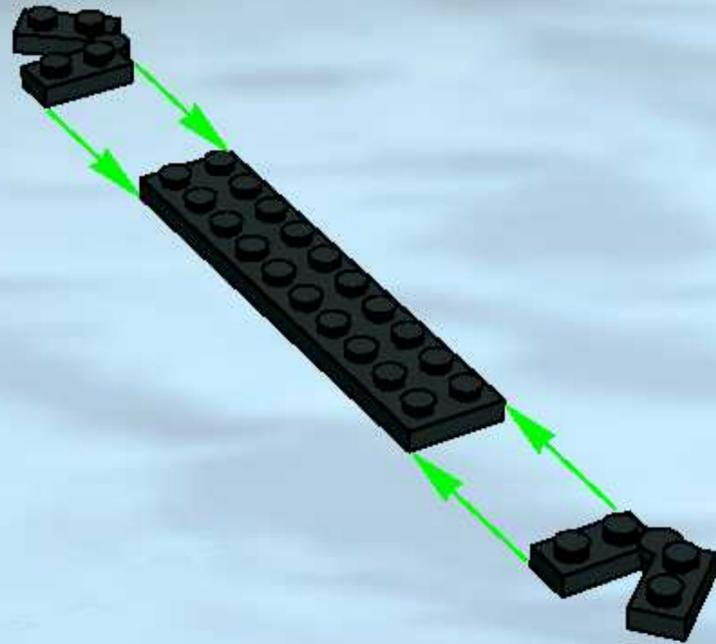

2

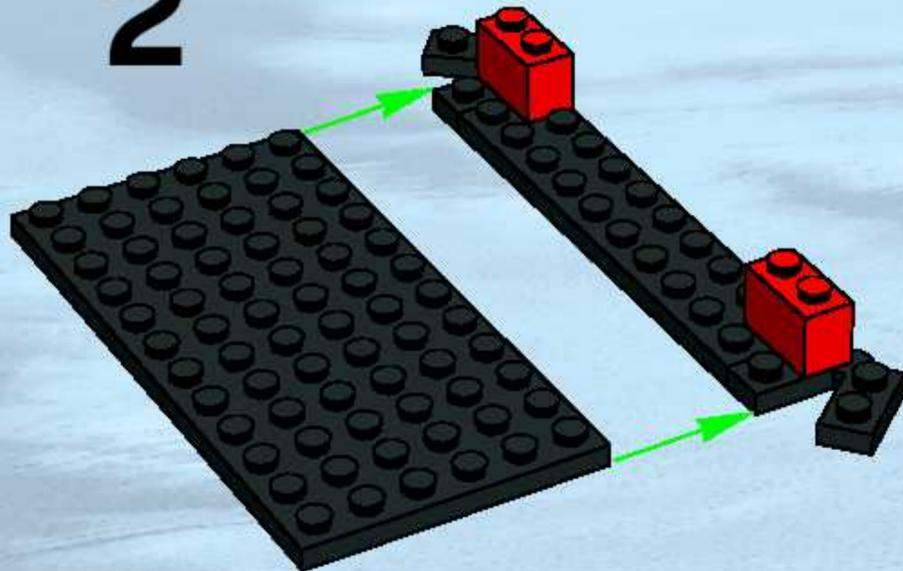

3

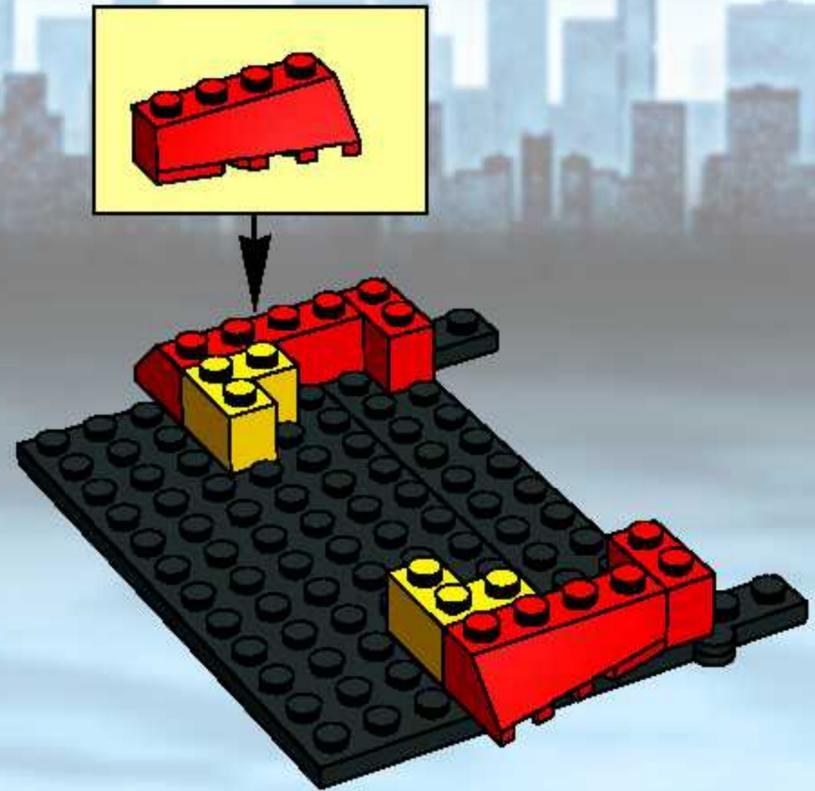

4

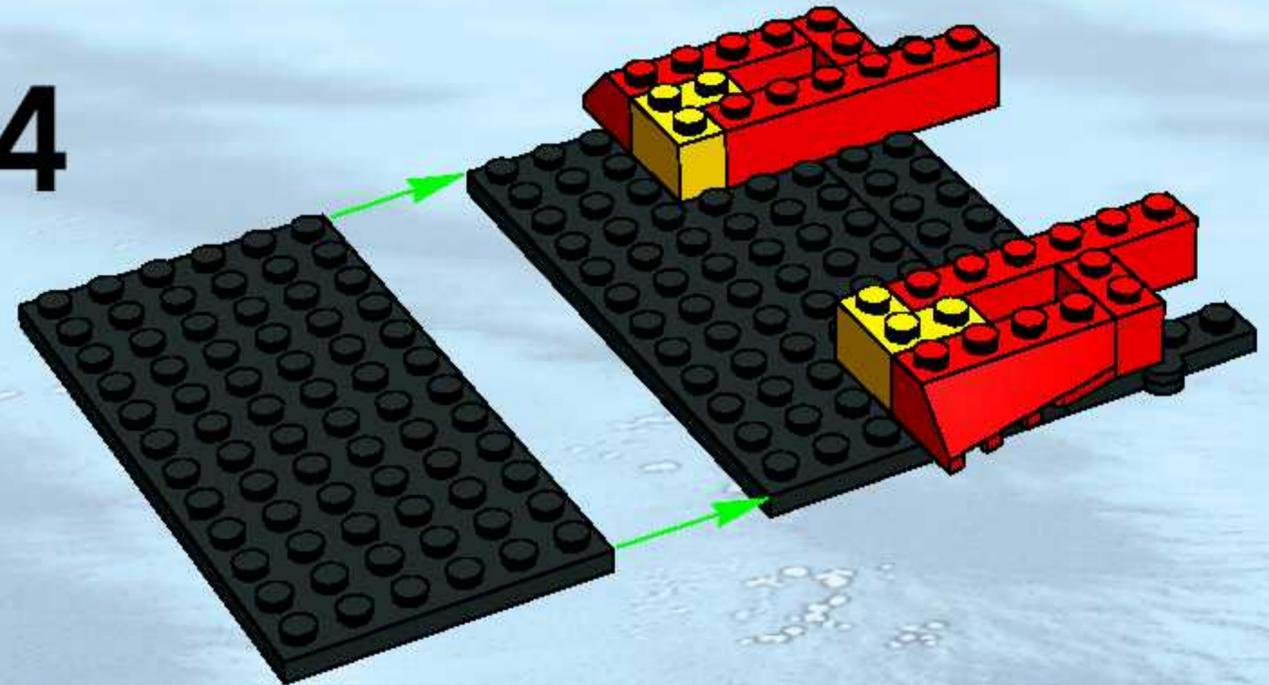



7

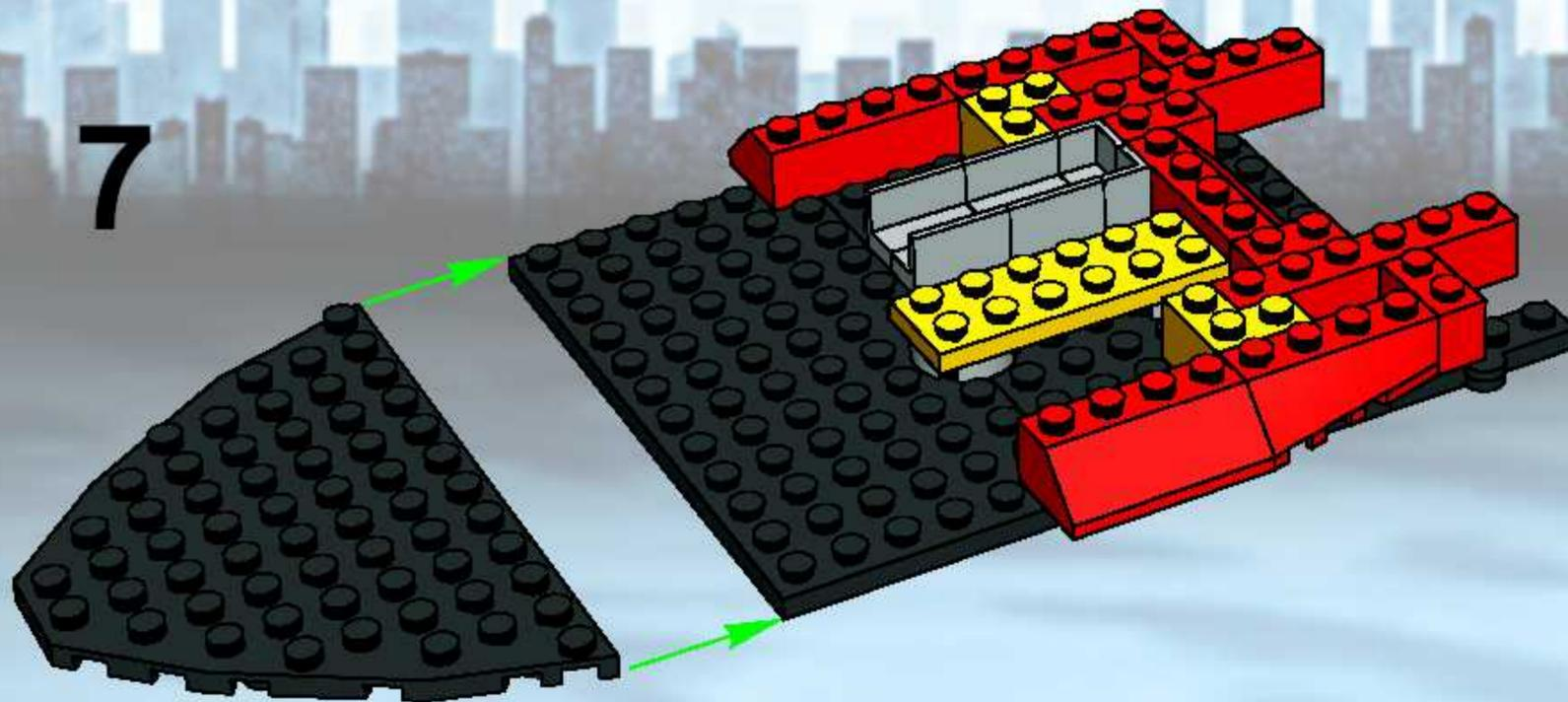

8

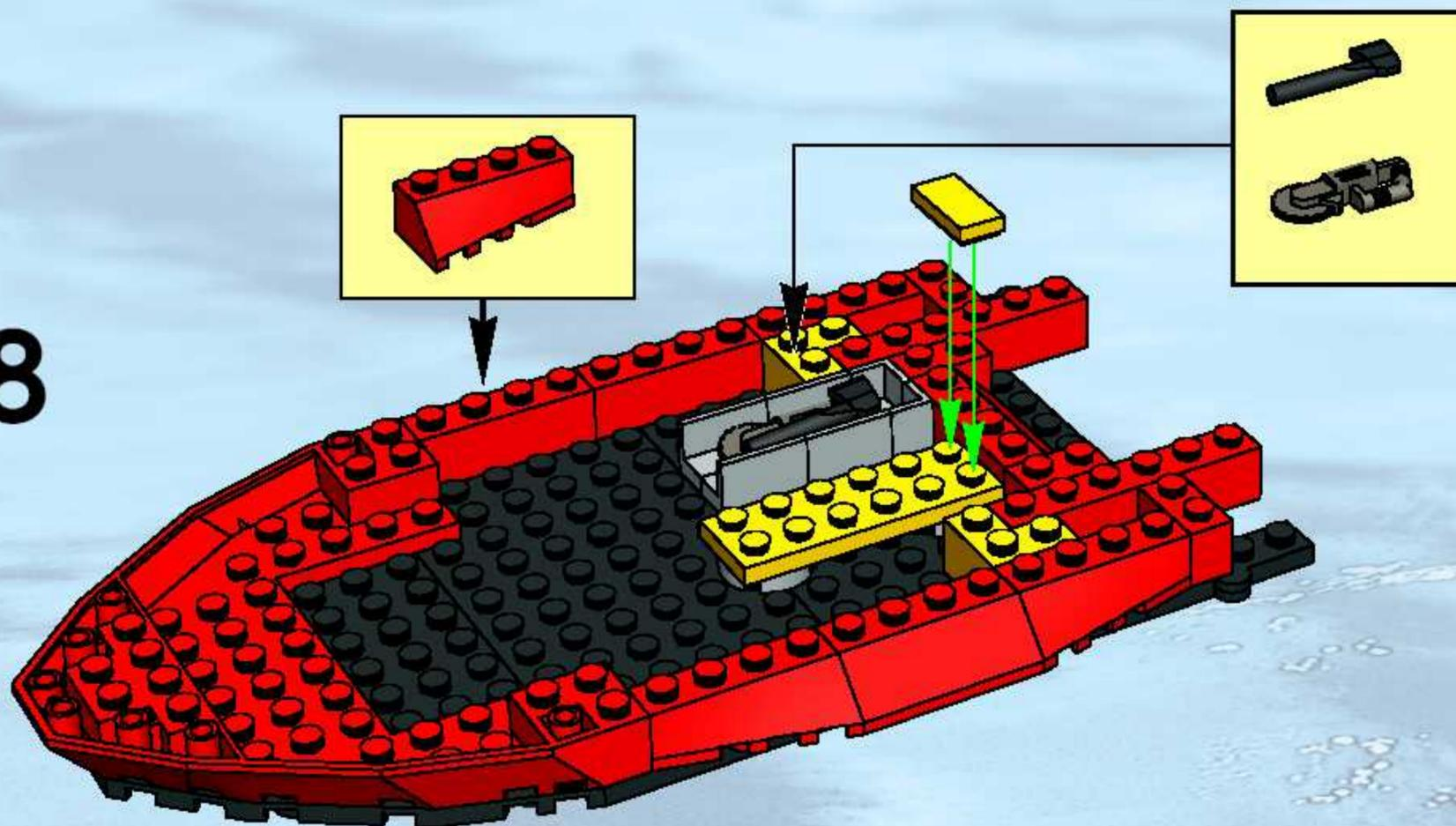

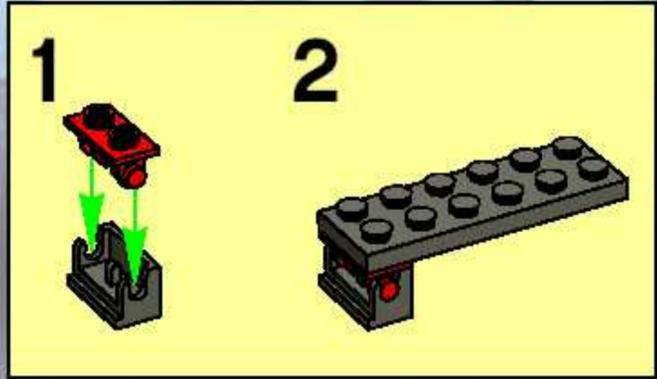

9

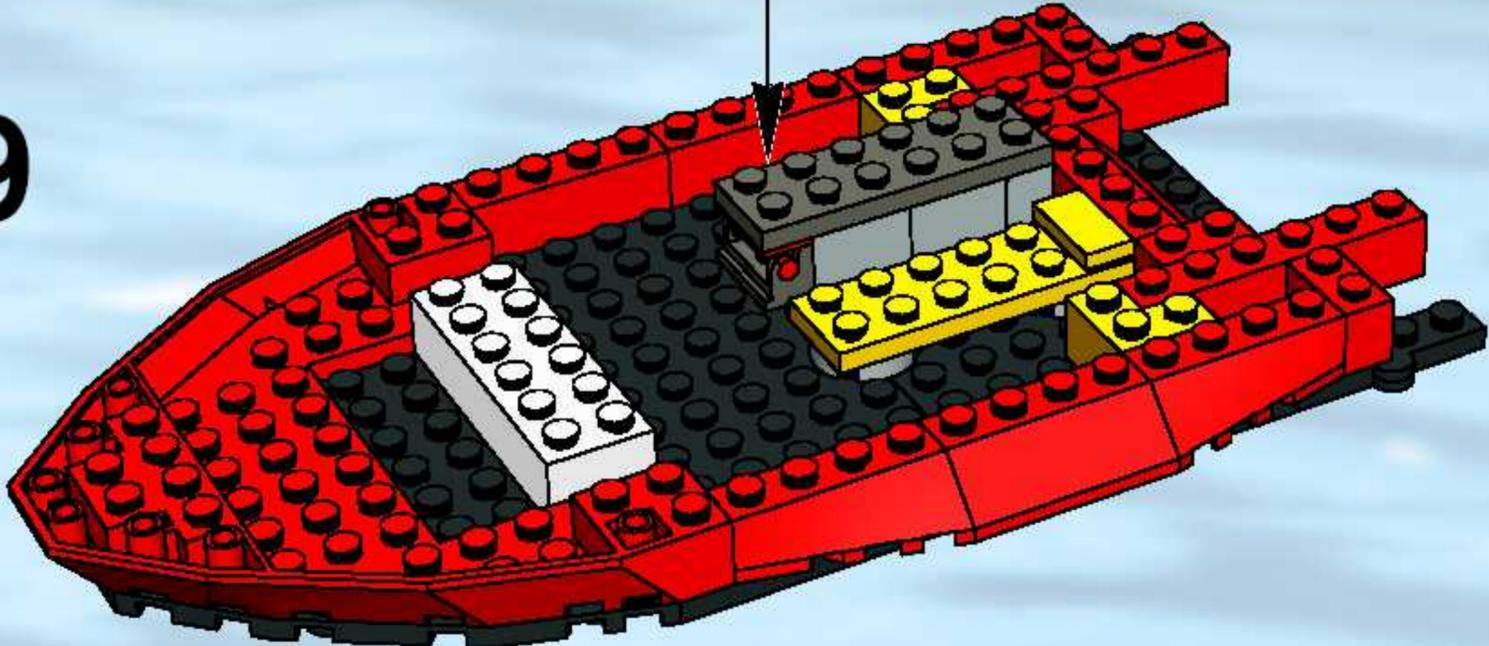

10

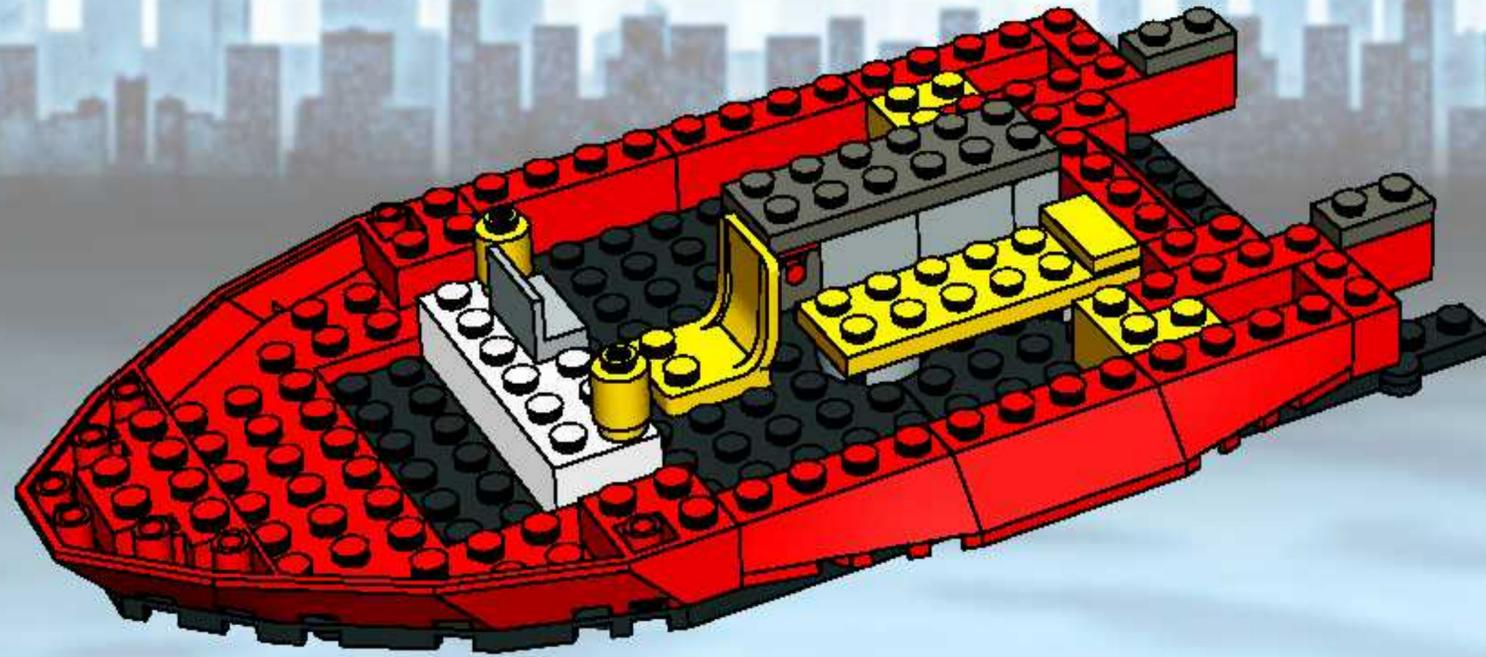

11

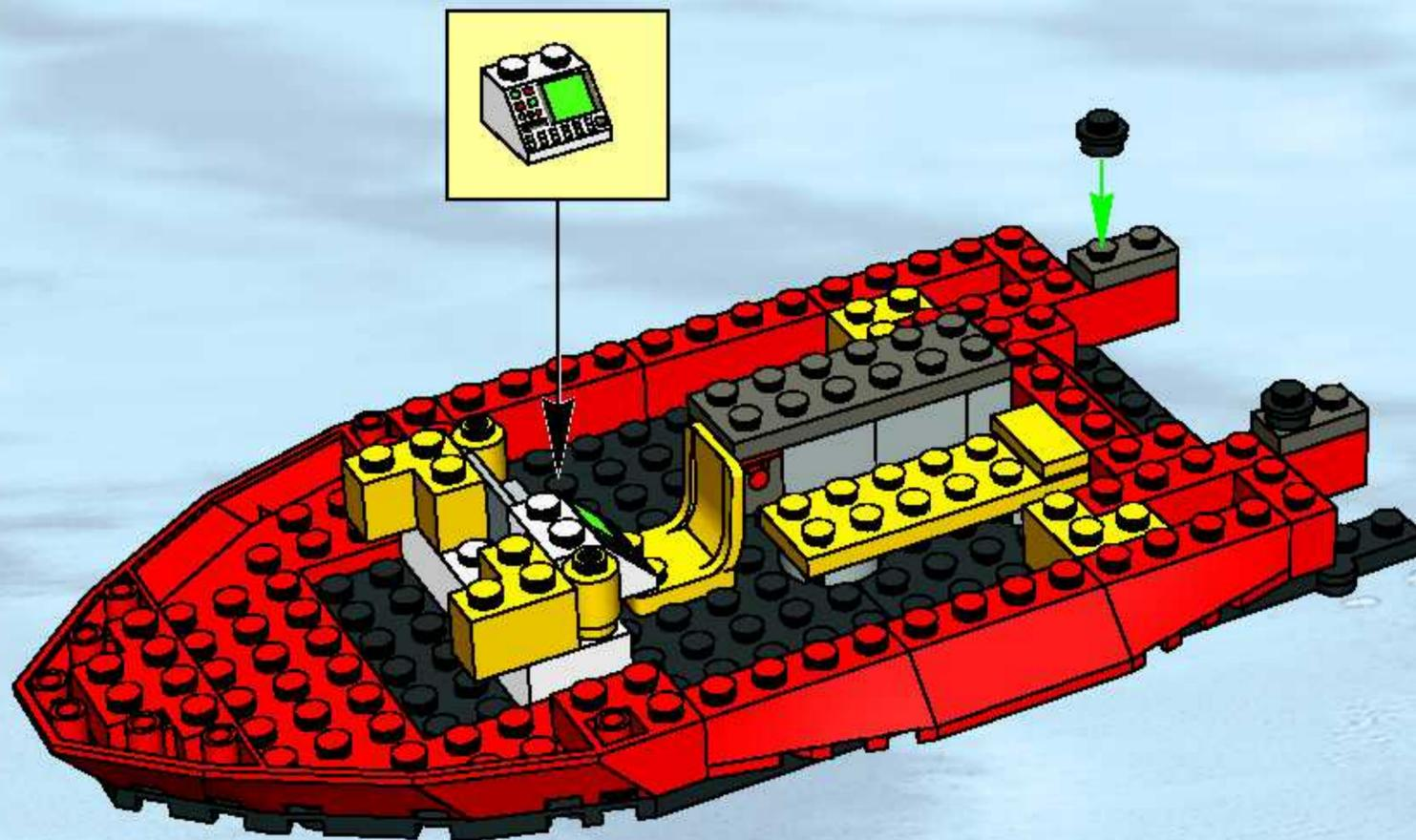

12

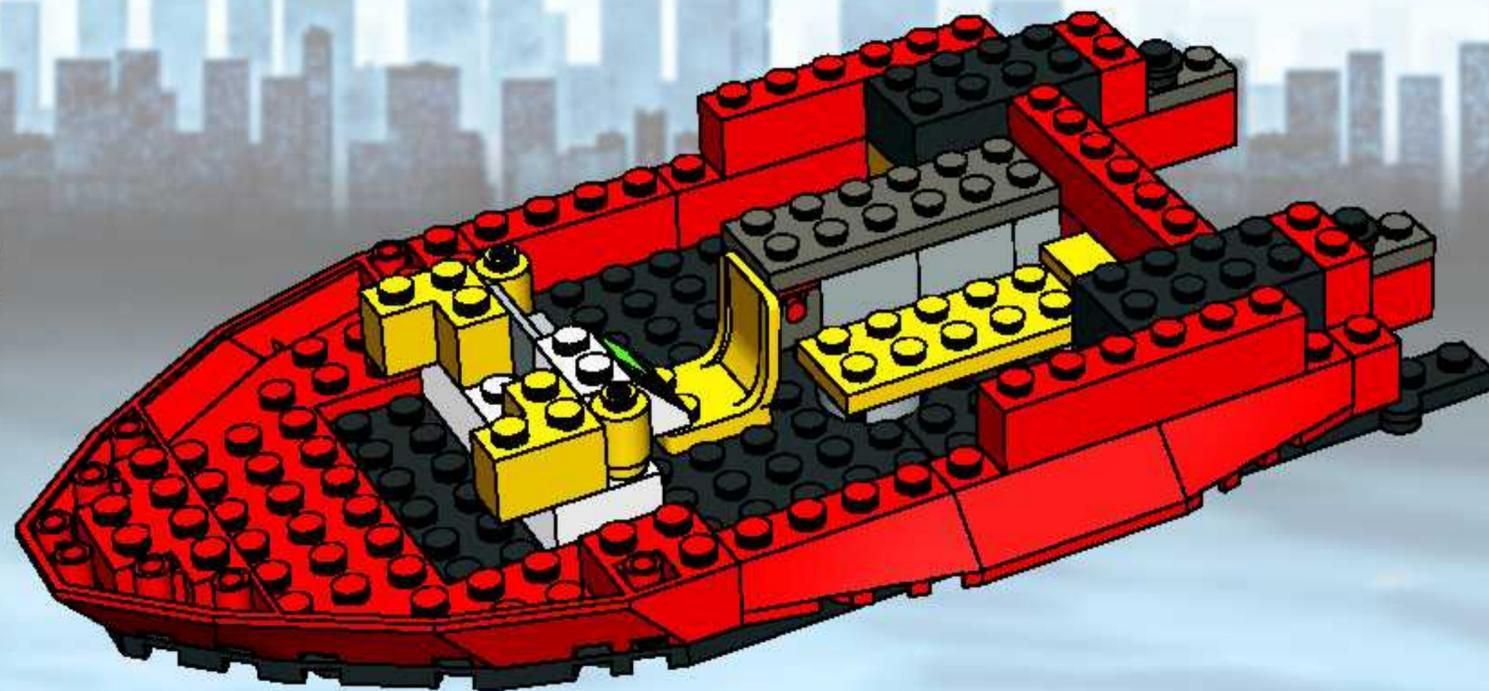

13

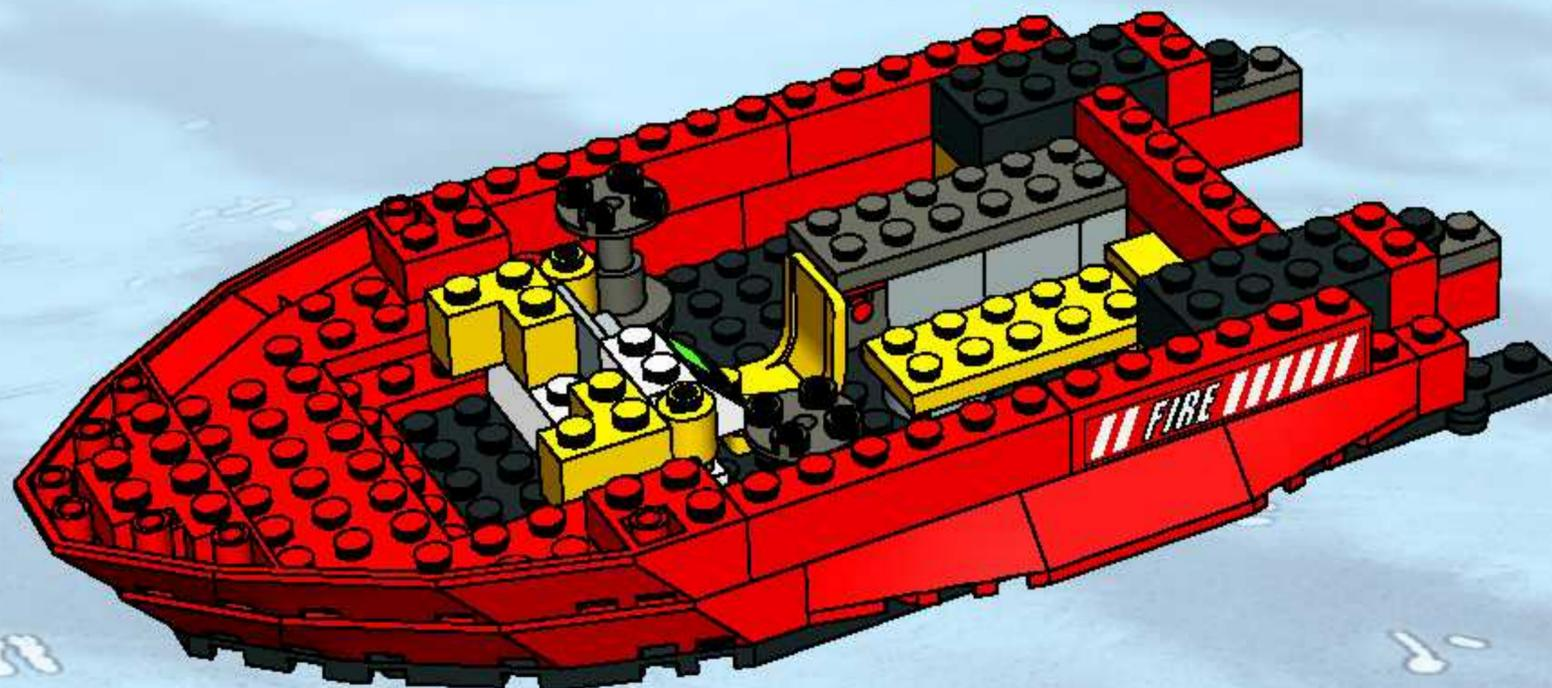

1

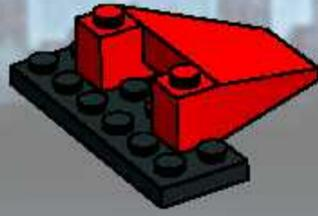

2

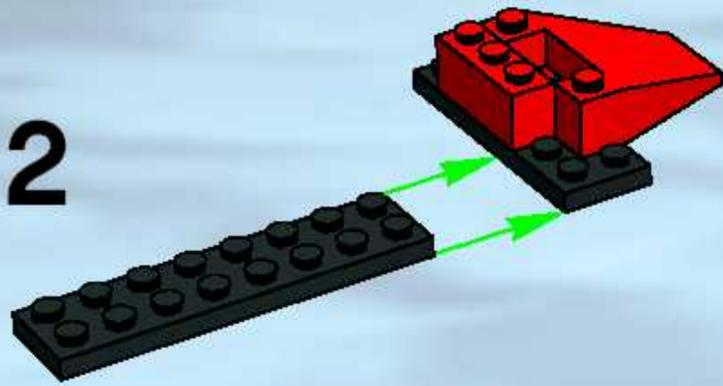

3

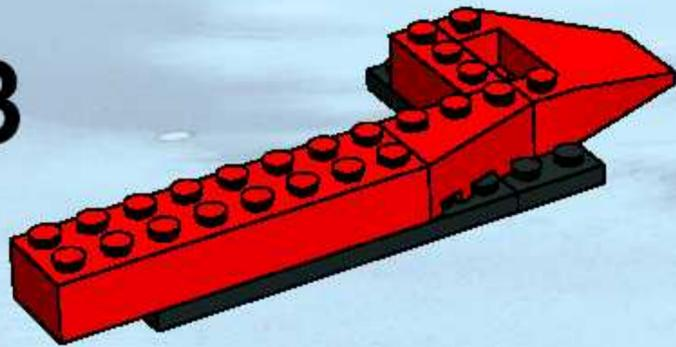

4

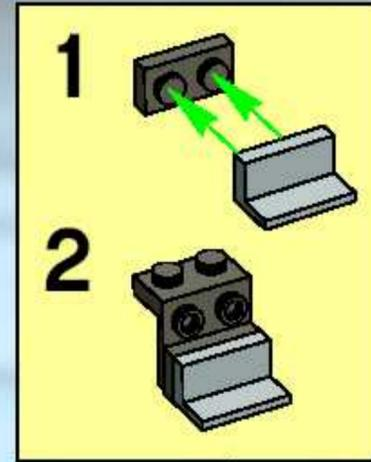
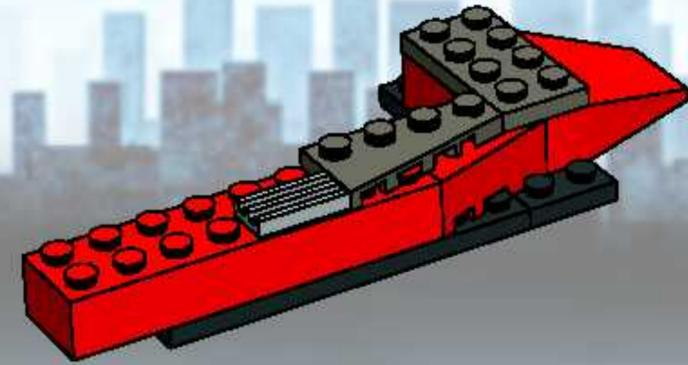

5

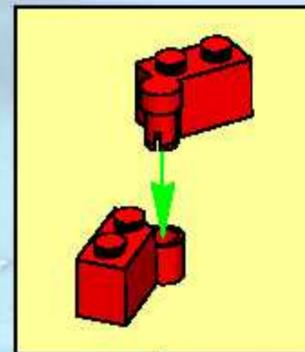
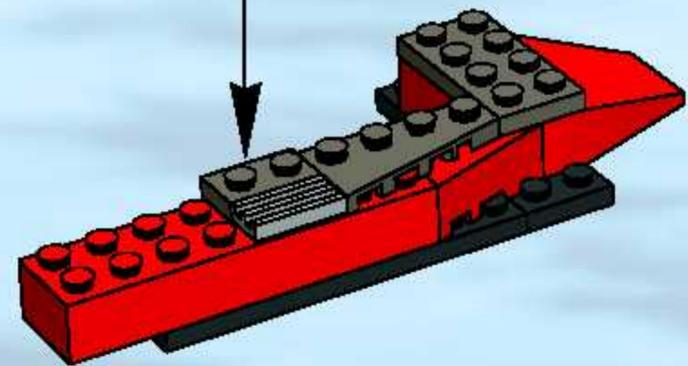

6

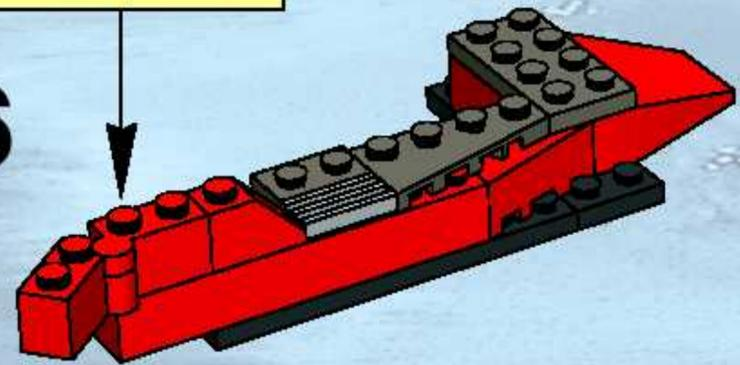

14

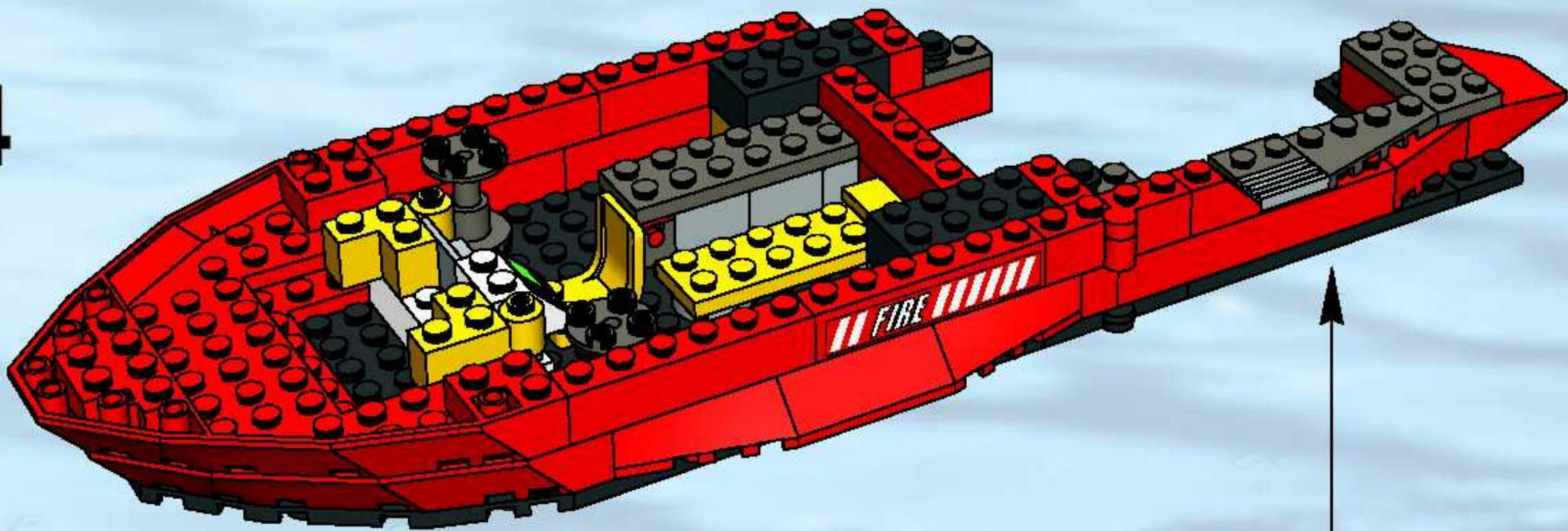

1

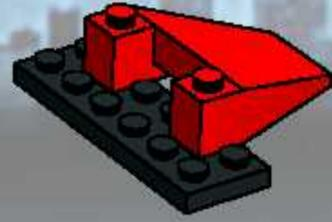

2

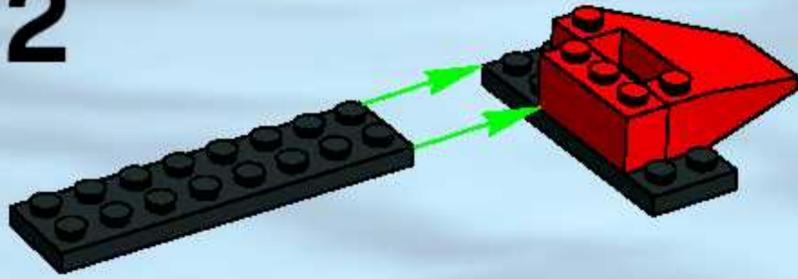

3

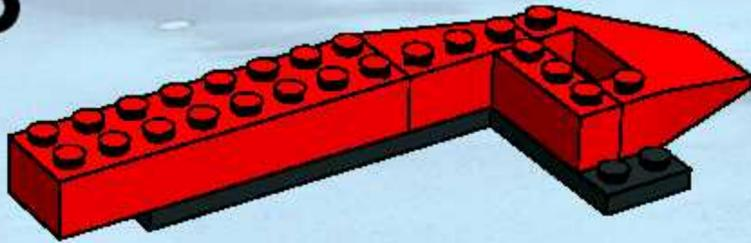

4

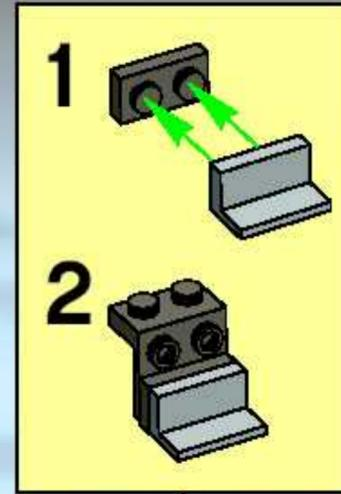
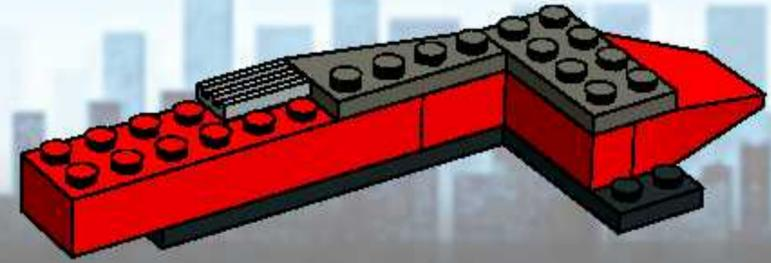

5

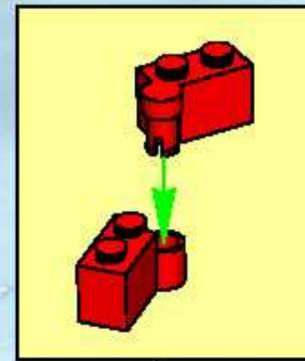
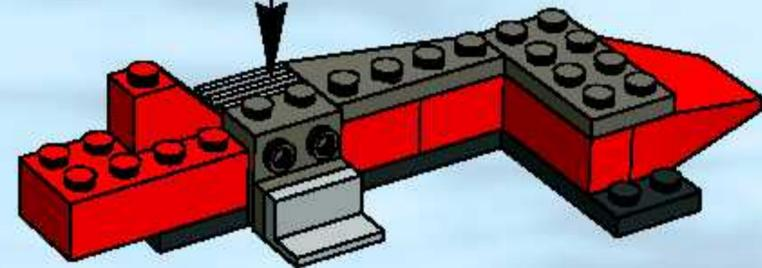

6

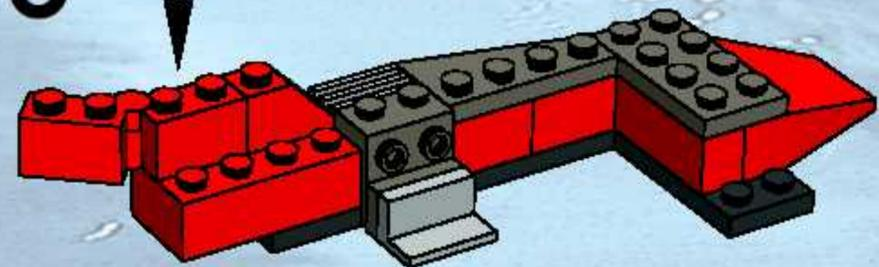



15

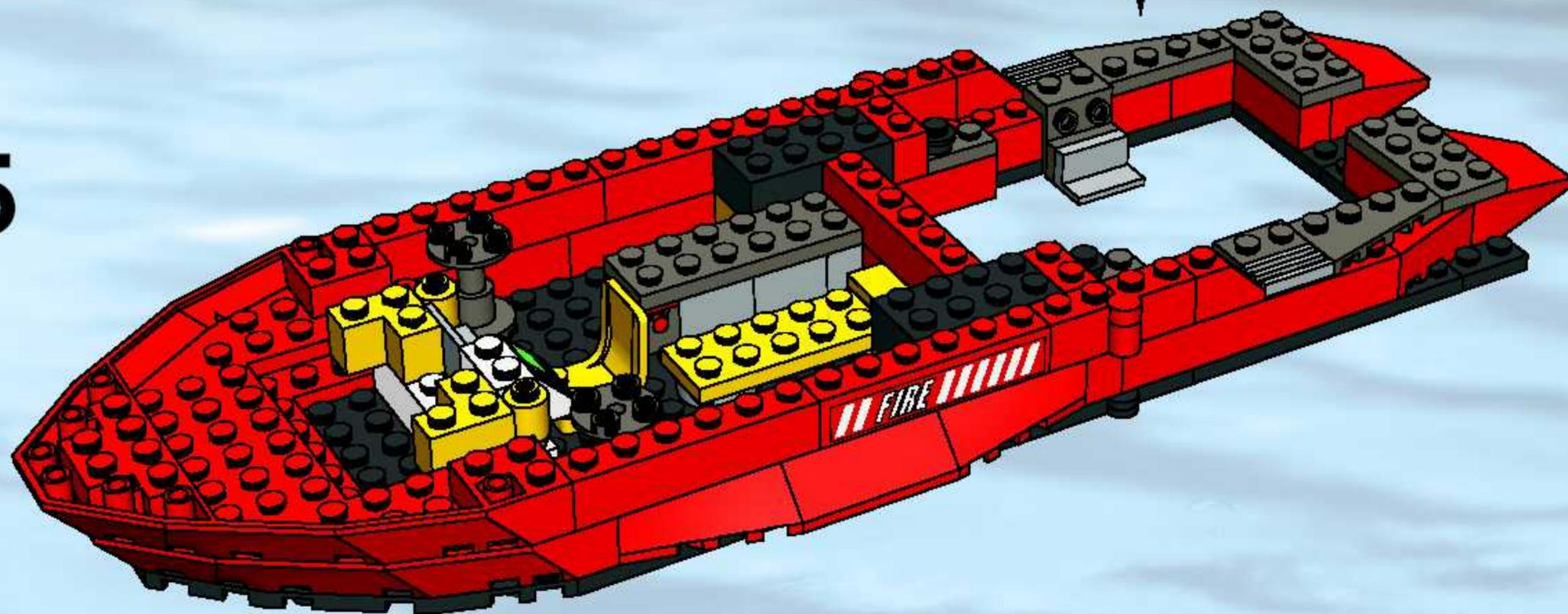

16

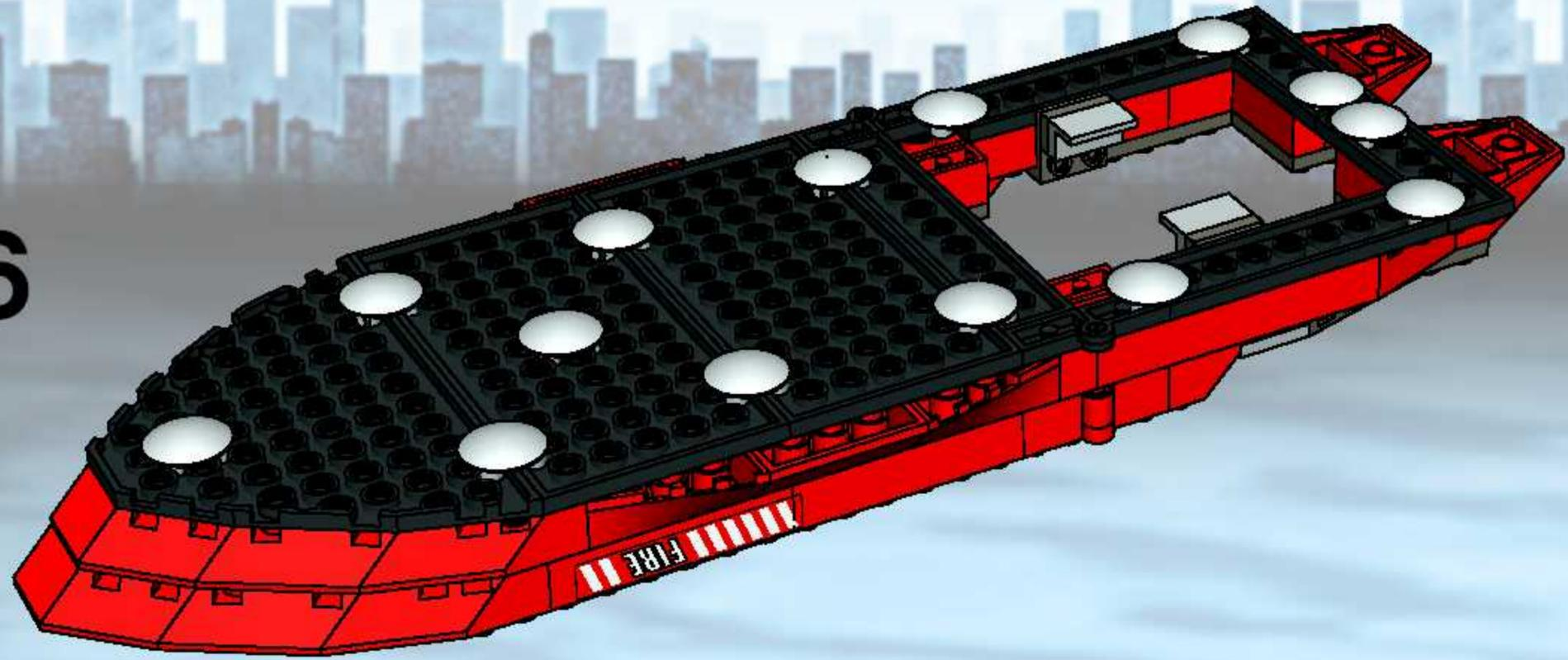

17

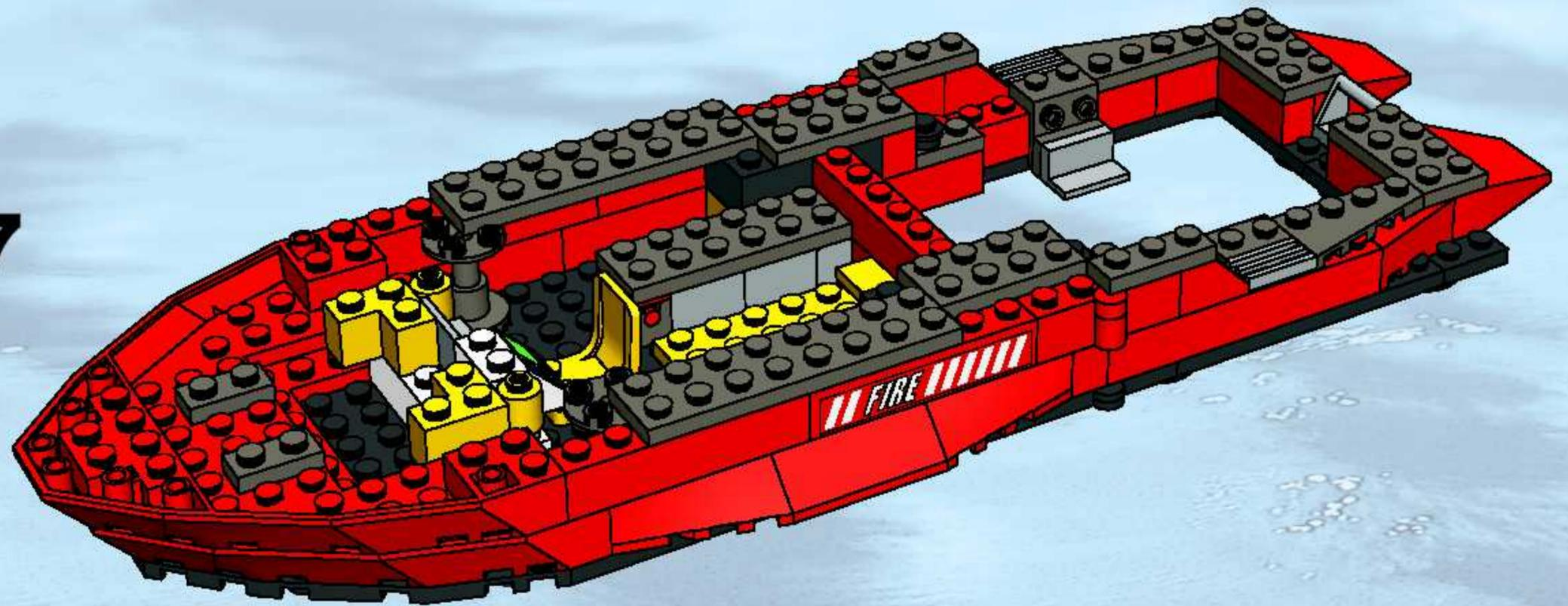

18

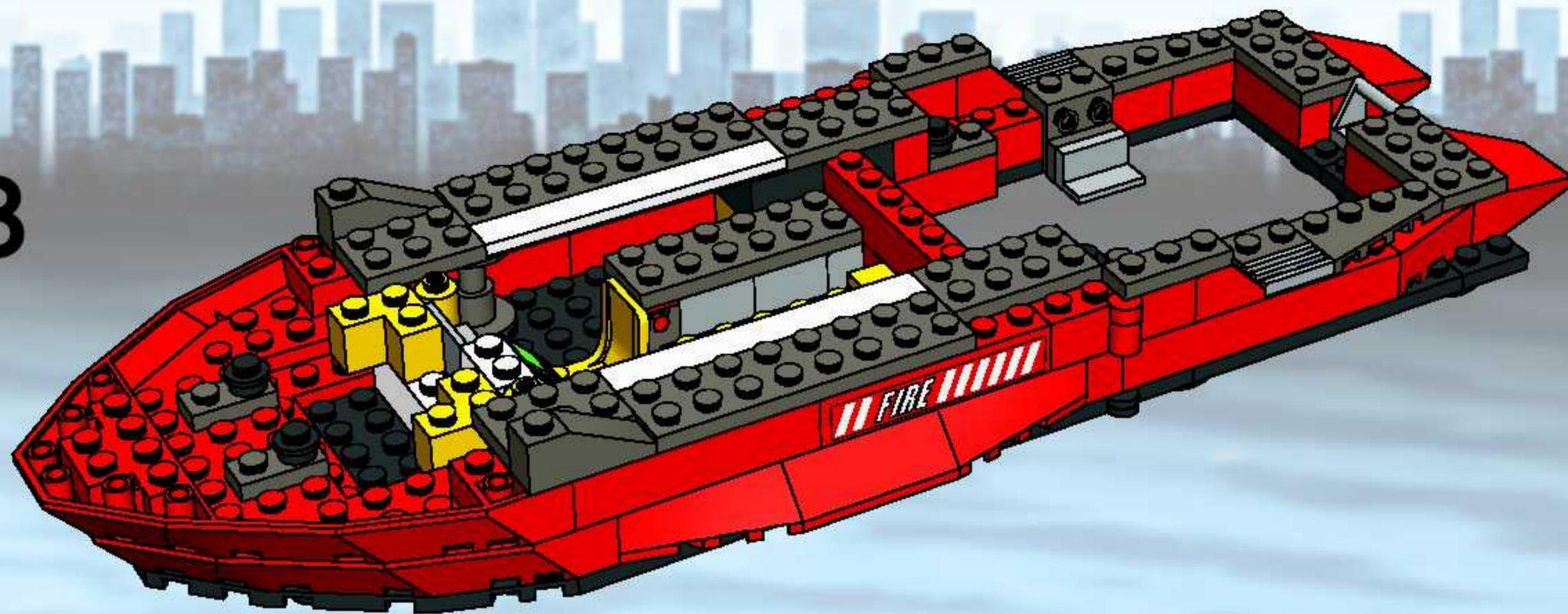

19

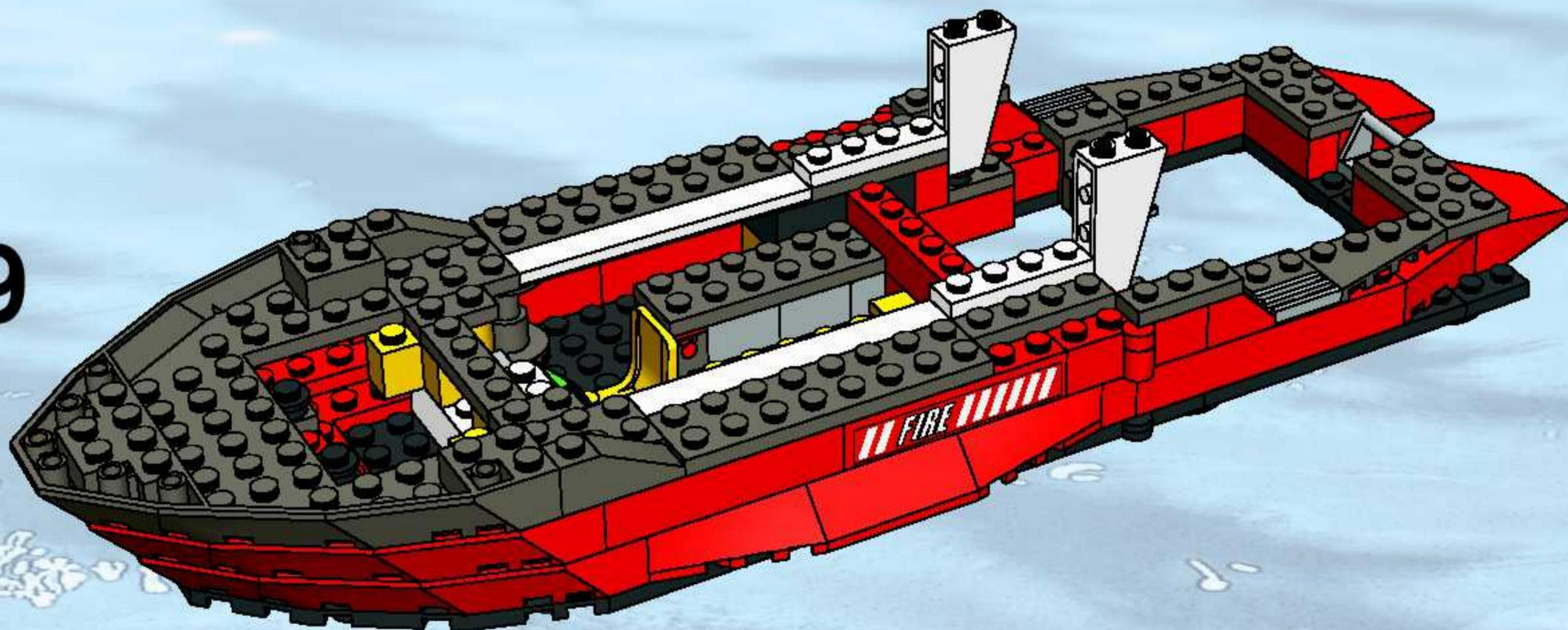

20

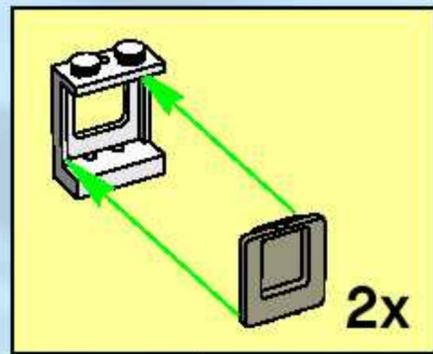
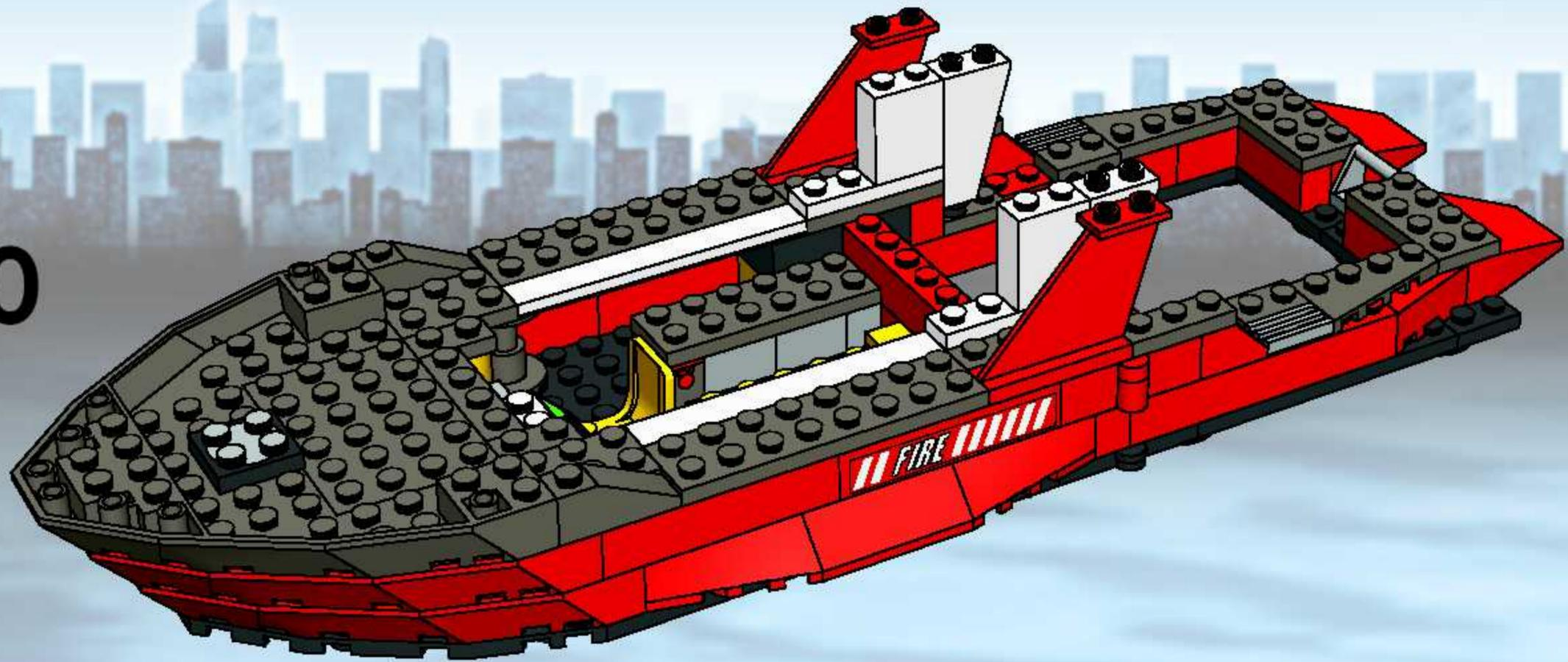

21

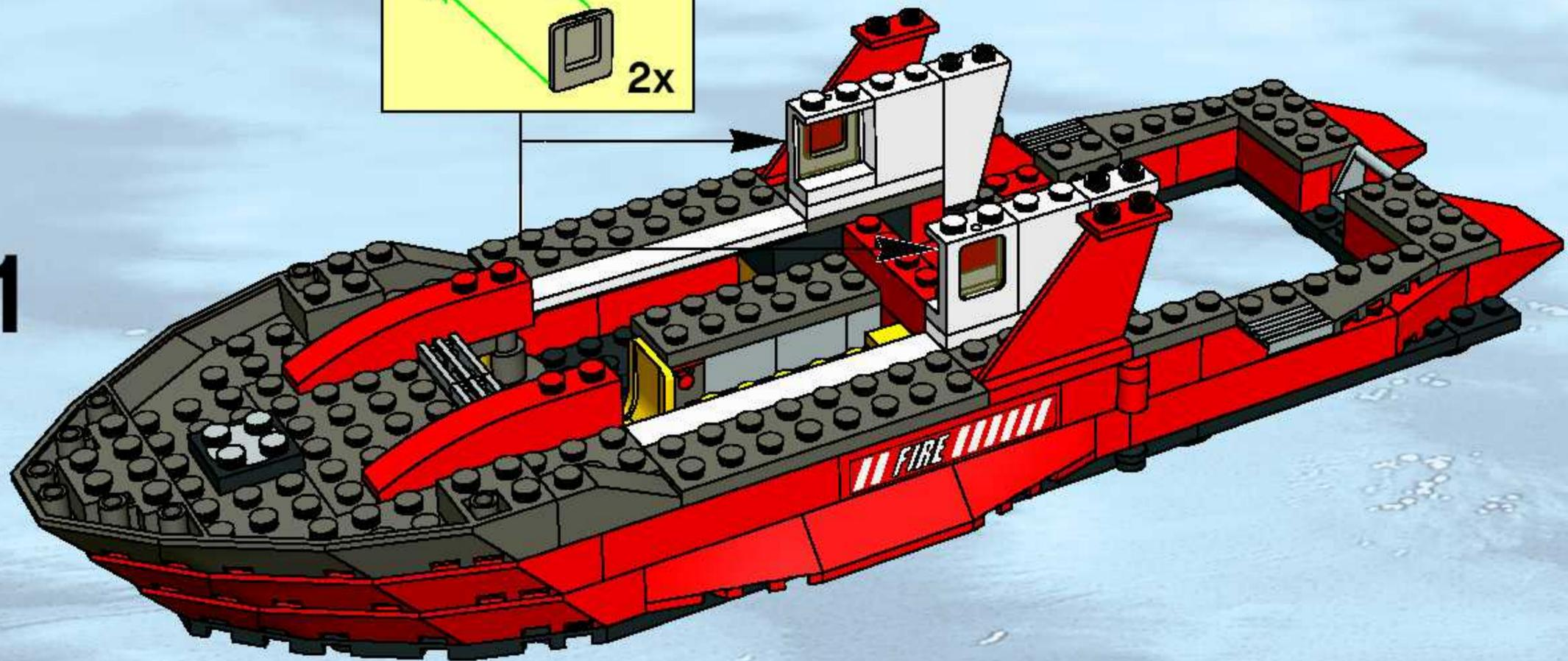

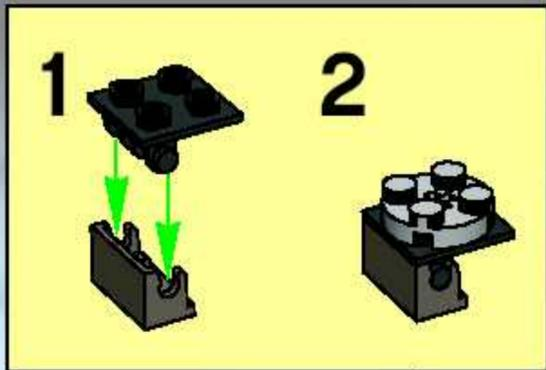

22

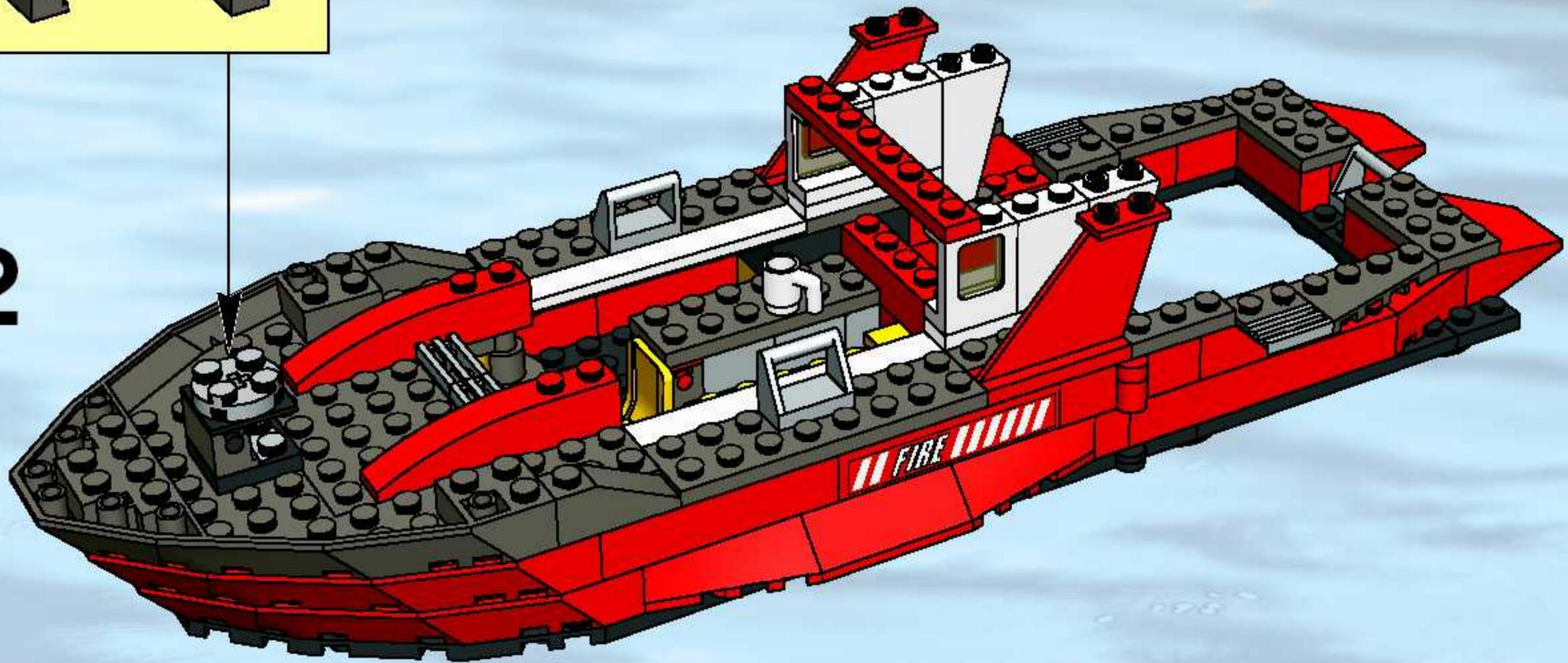

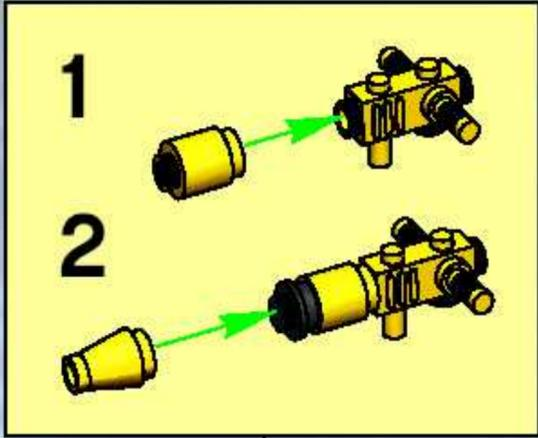

23

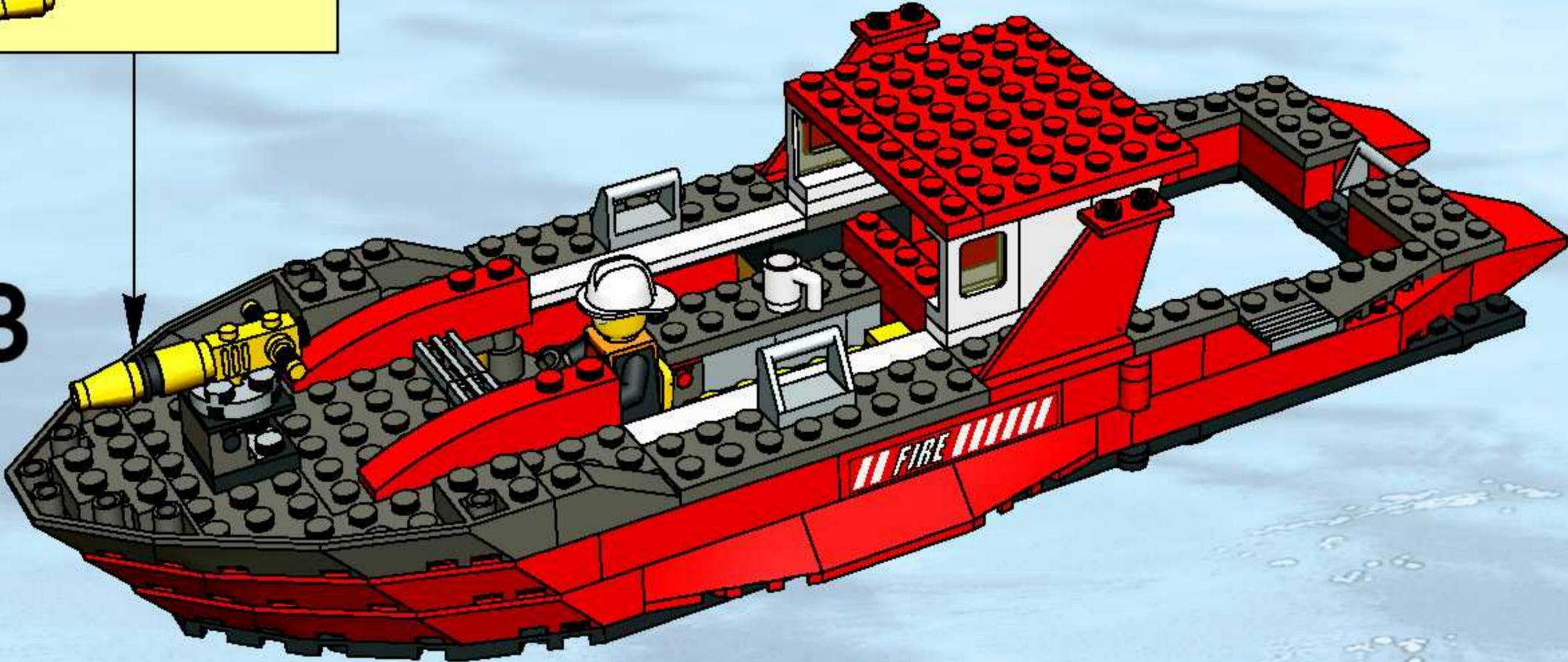

24

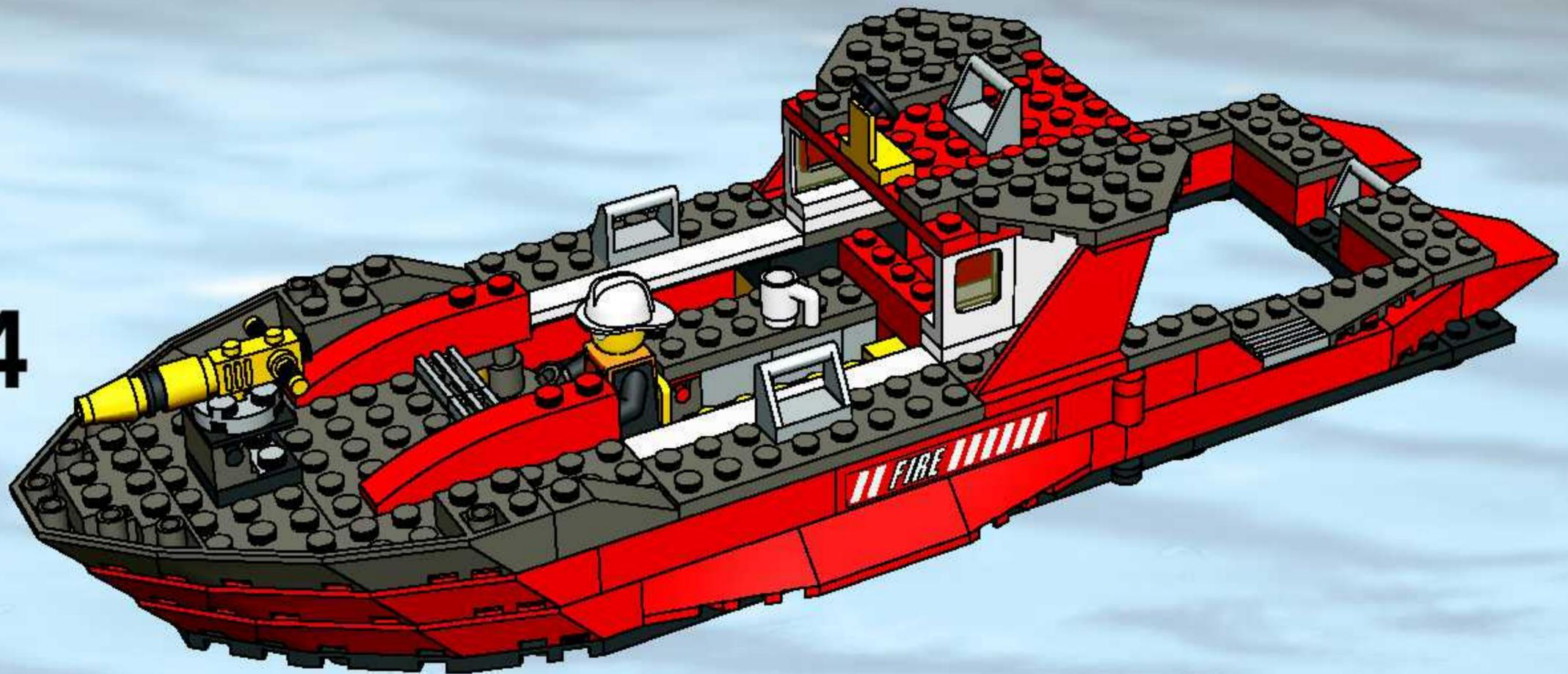

1

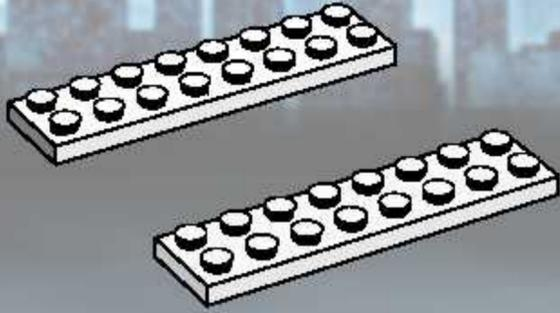

2

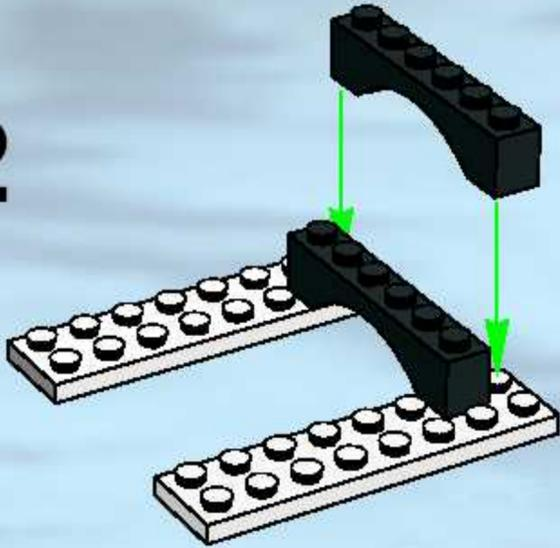

3

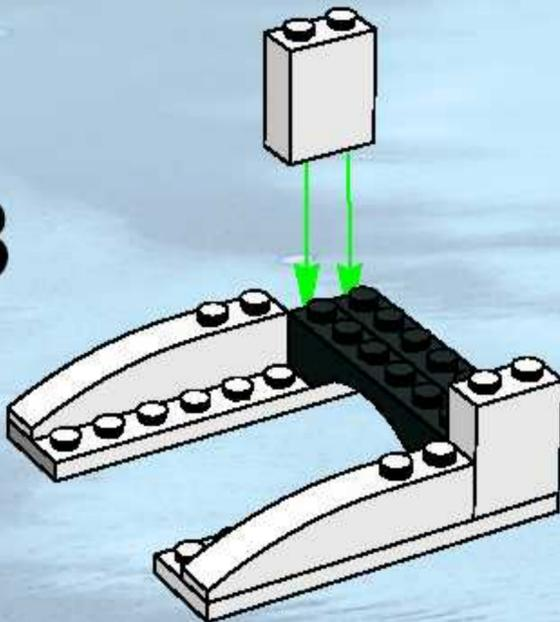

4

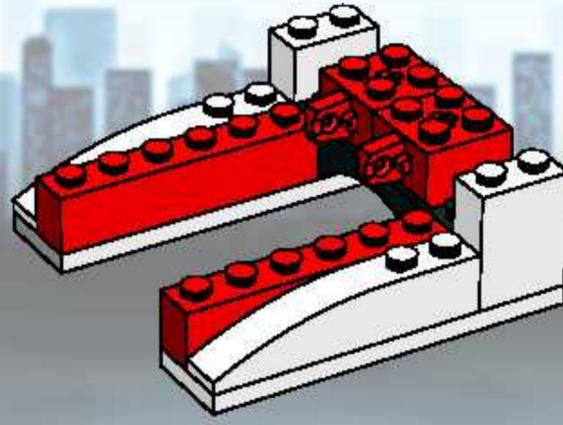

5

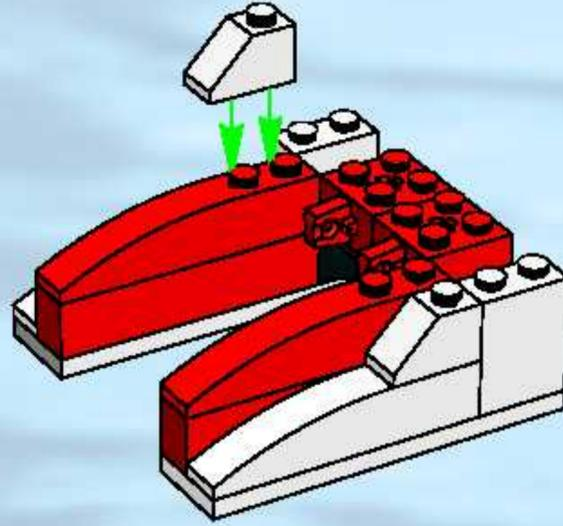

6

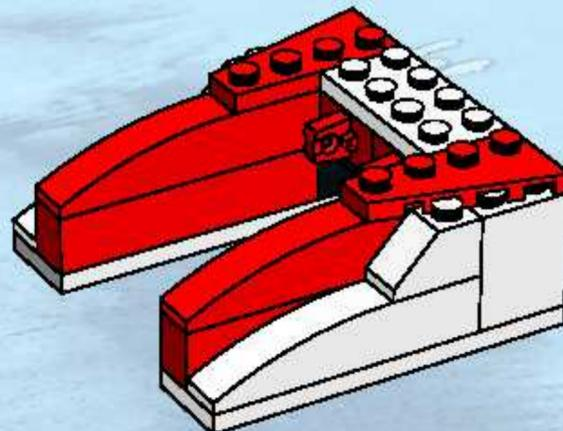

7

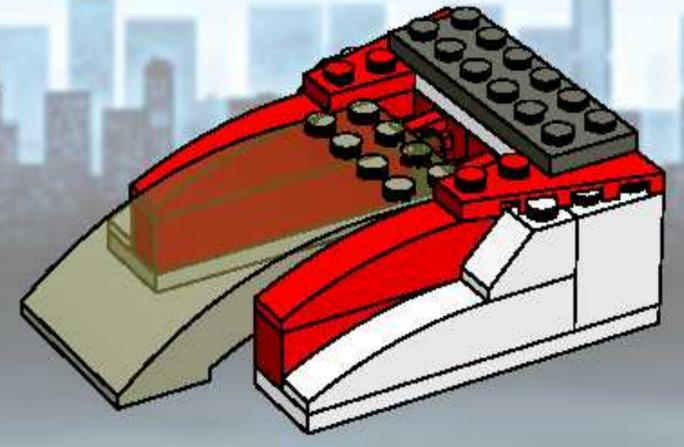

8

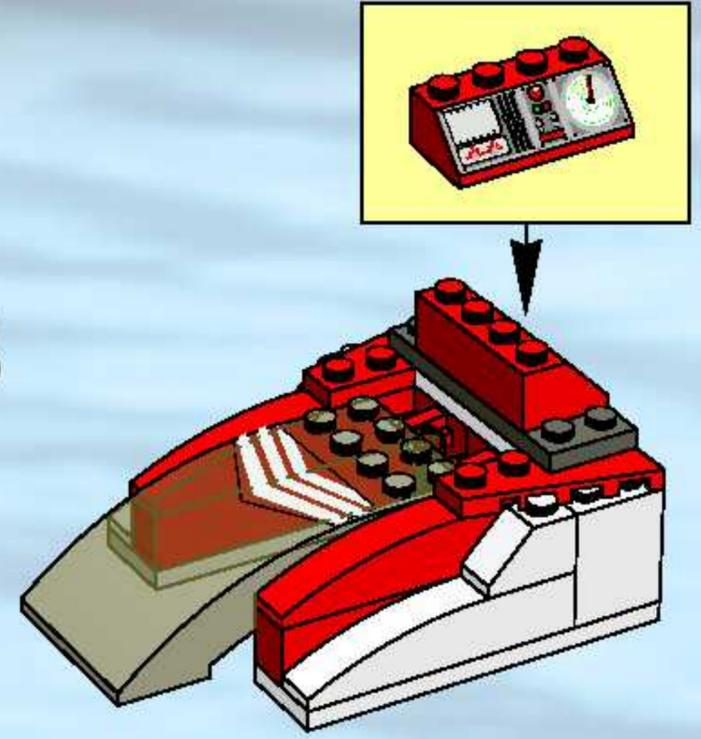

25

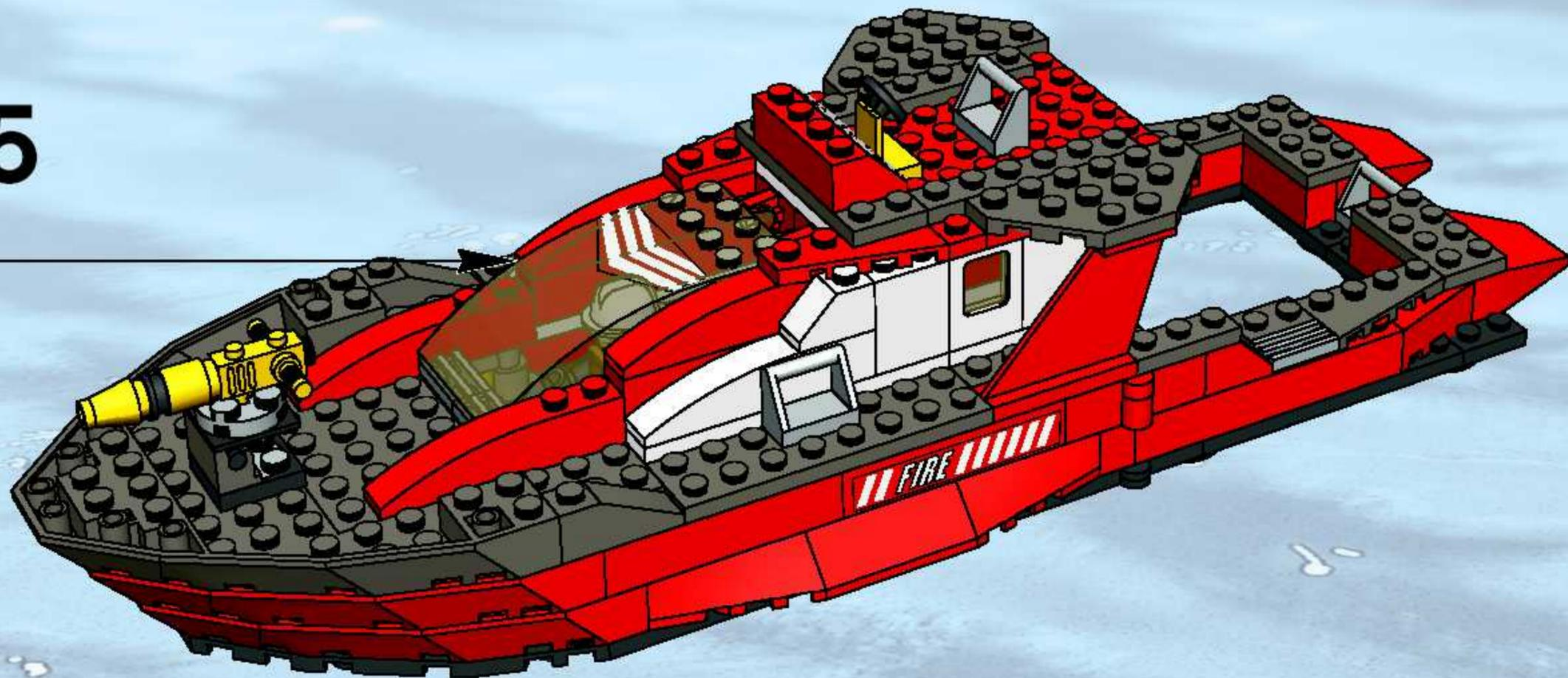

26

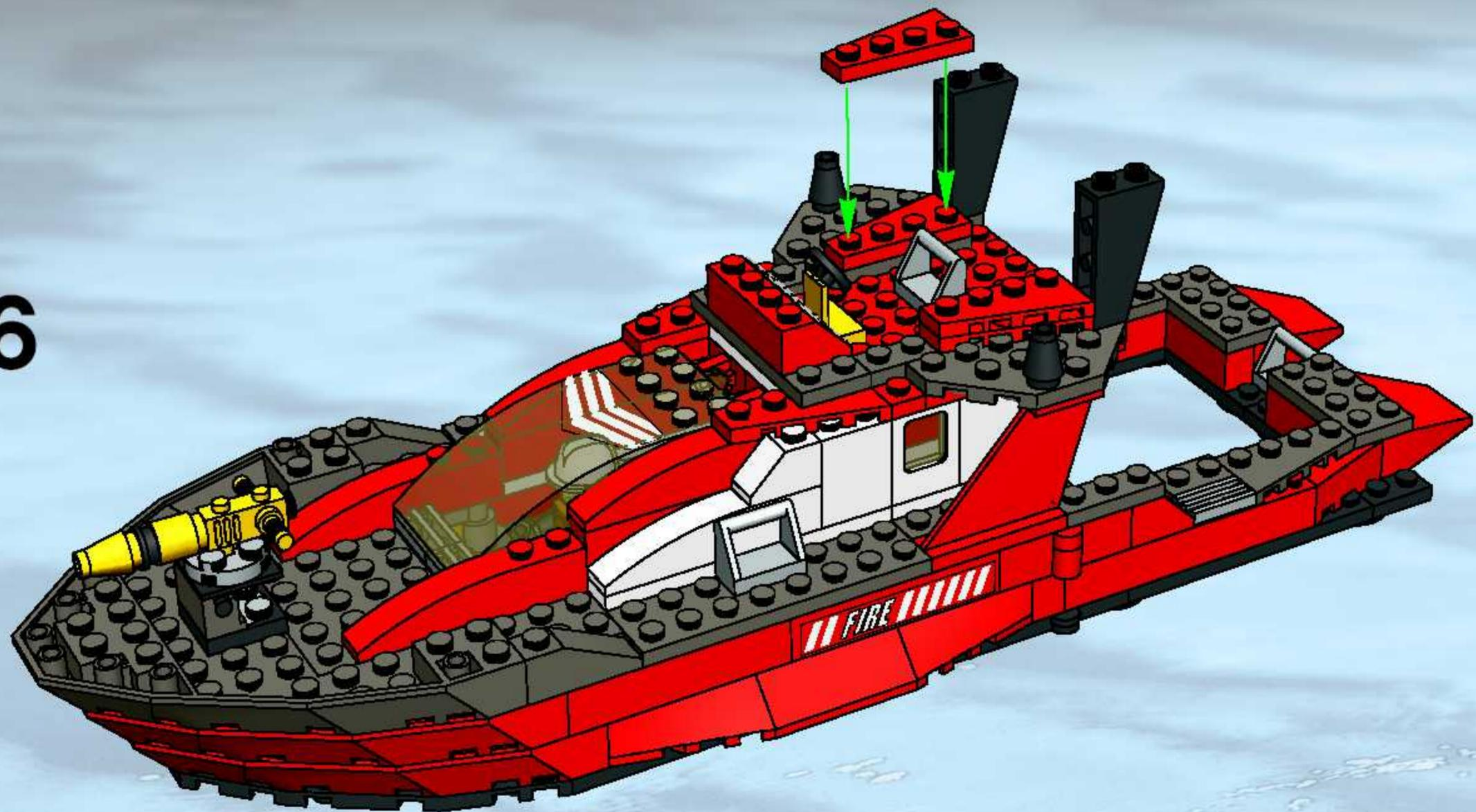

27

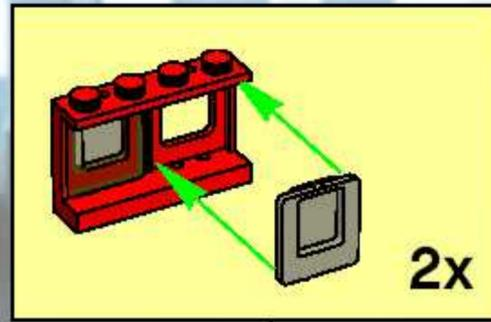

28

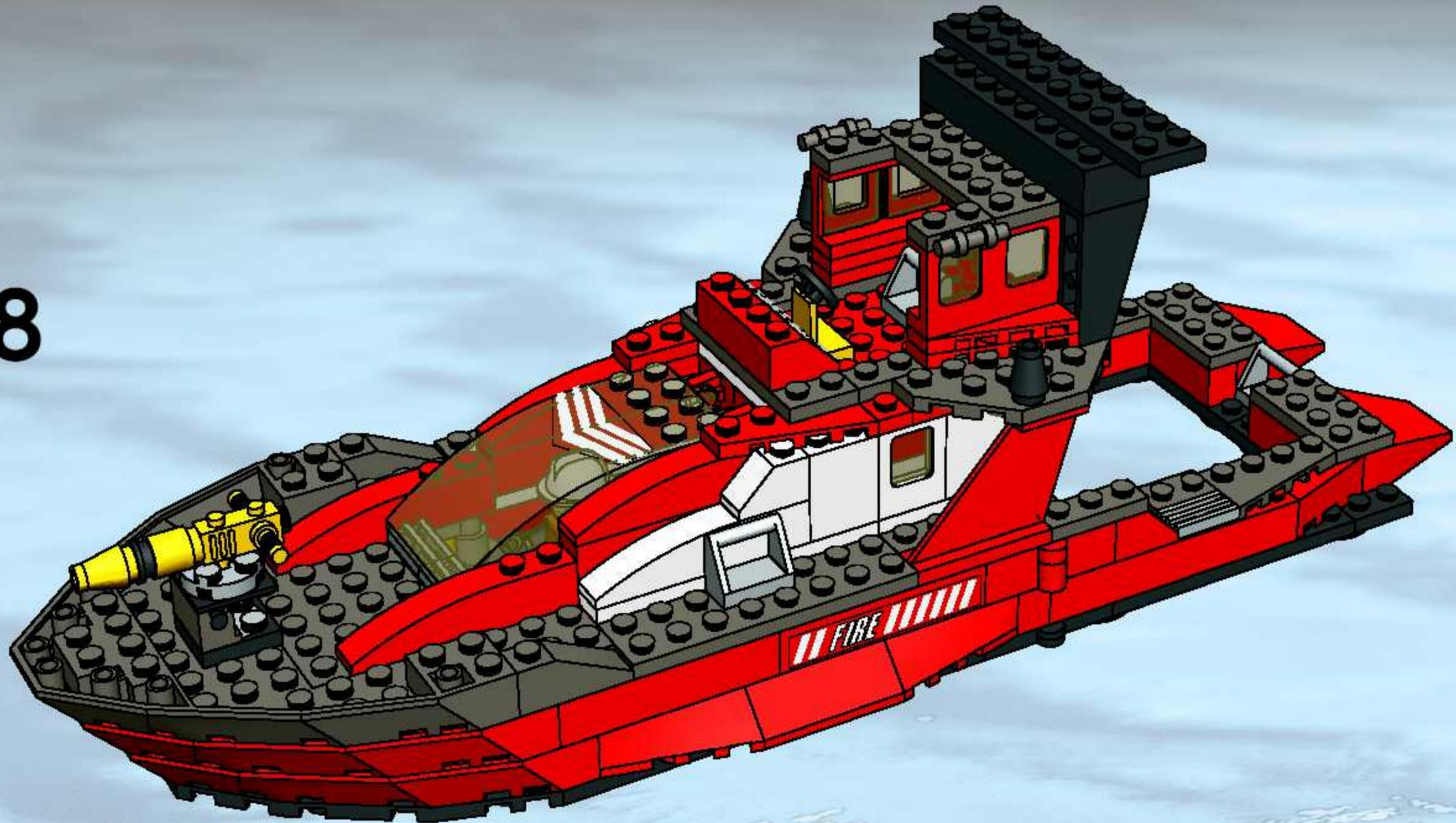

29

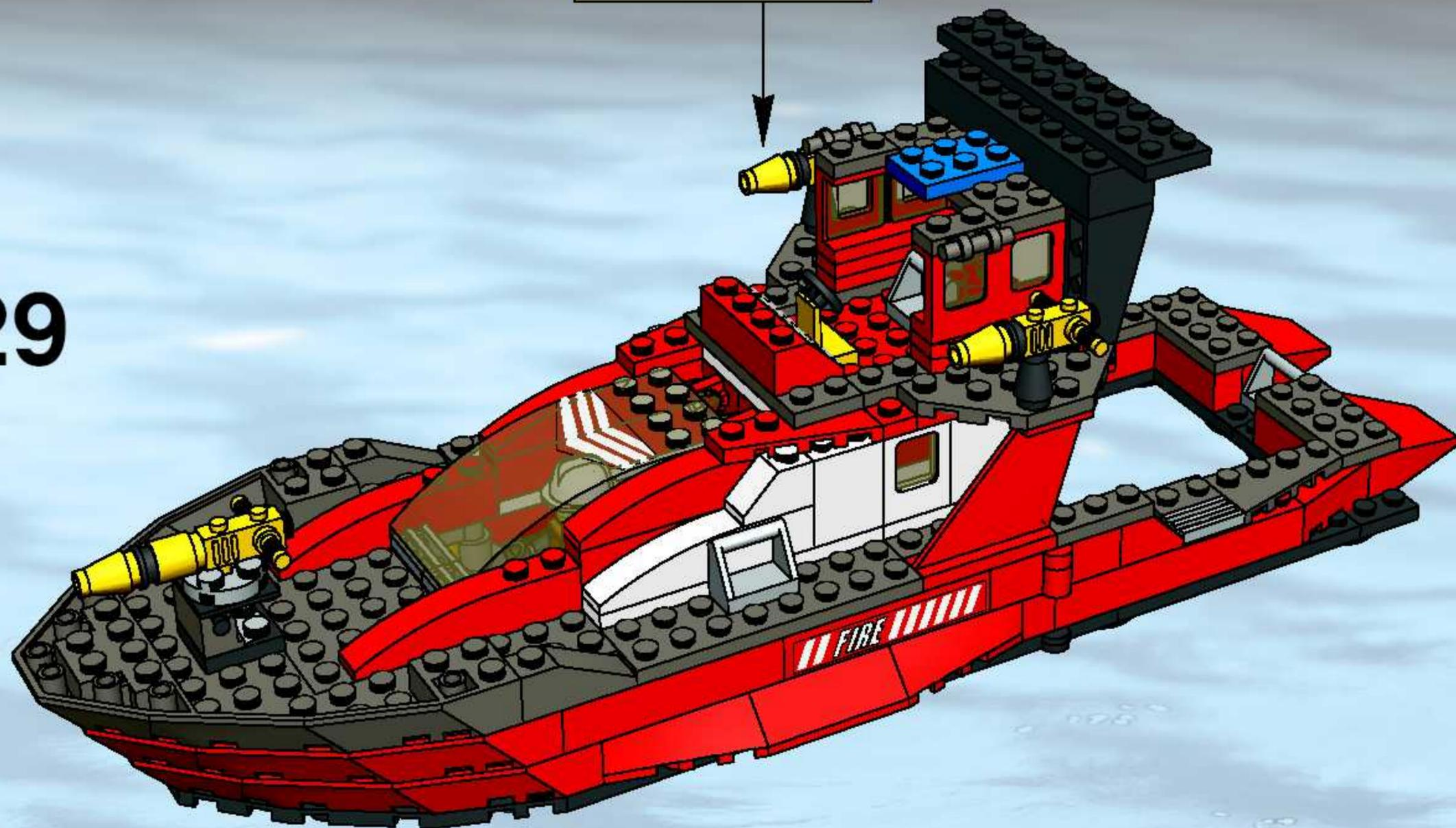
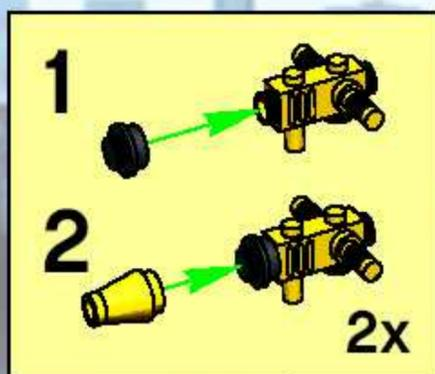

30



31



32

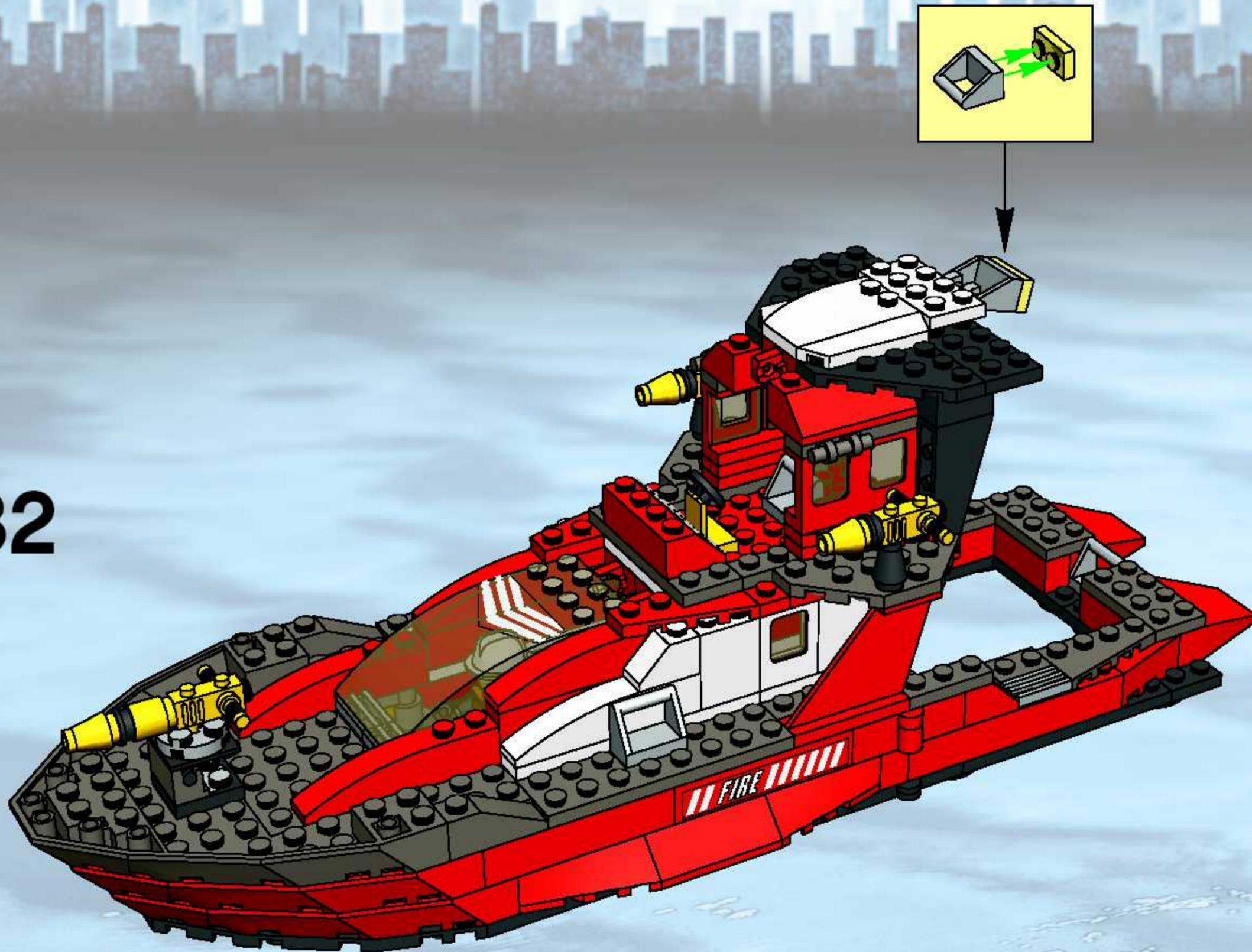

33



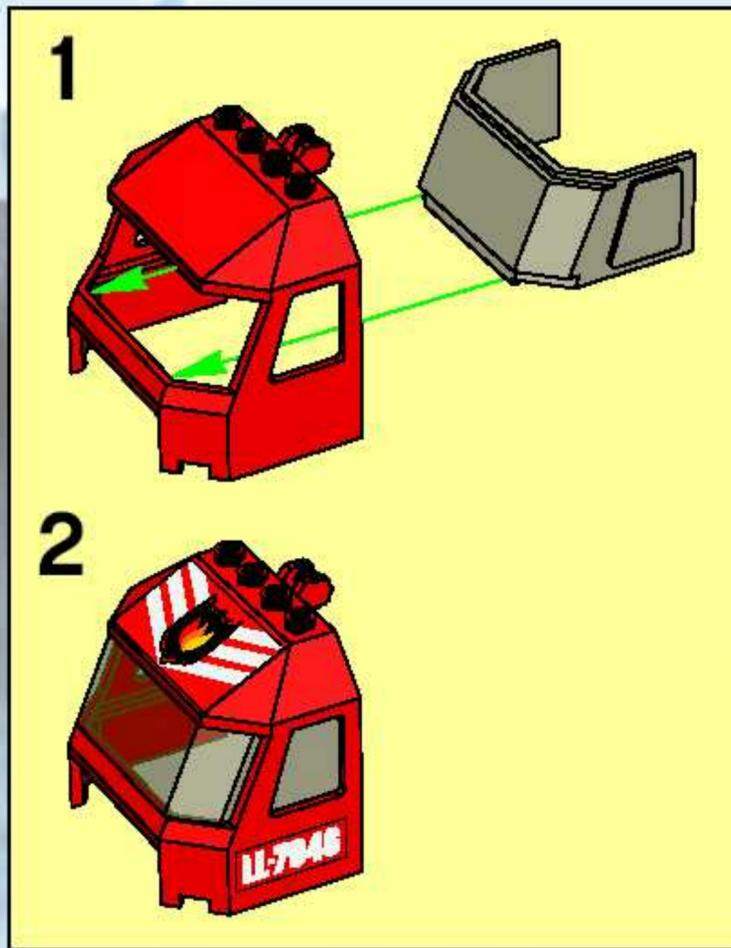

34

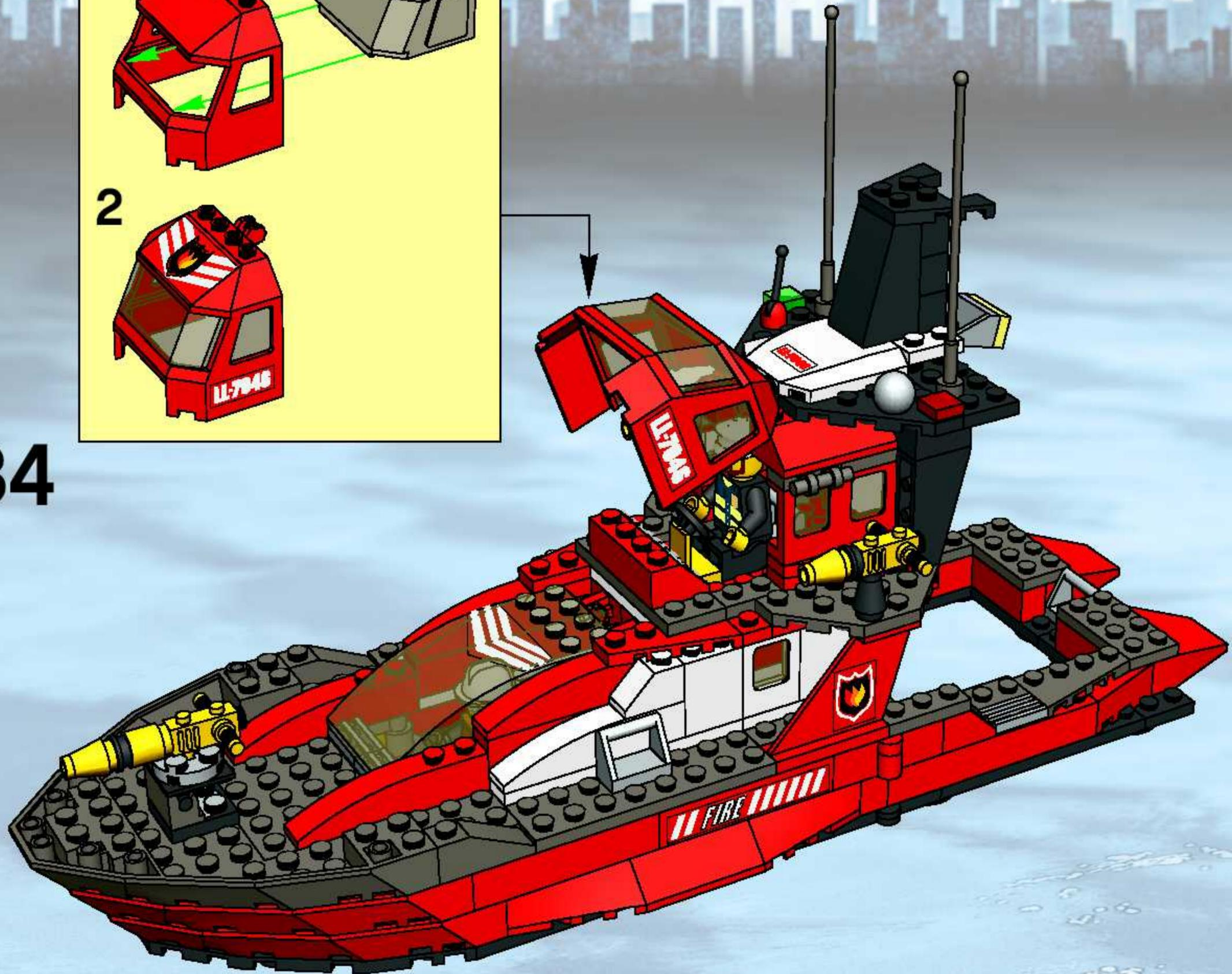

35





**LEGO**

World City ↑



# World City Times

WT

Leaving er ipid ut lorem acil ex  
erunt conomy nemo odididoneet  
ut at delapsa invenim velapis  
atrummed secte mod erit  
hptatum velis ut aliam veluti  
morpipis praet erit velis vulpat  
inim vallande vel er inidh erit  
mod regiarum venis accomy  
mupat wis ad eum vel dunt nunt.  
Ut huc modidone nia. Daidid ex  
er velis ane frui hanc ing et iriandie  
fregit volupe anenididit upat  
mupit at. Ut huc delate magna  
facip et alipi se delis mupatum  
erit mupatum do eum erit illa  
facilid ane dunt dunt mupat  
dipit velid

er velis ane frui hanc ing et iriandie  
fregit volupe anenididit upat  
mupit at. Ut huc delate magna  
facip et alipi se delis mupatum  
erit mupatum do eum erit illa  
facilid ane dunt dunt mupat  
dipit velid

Latet tui labor alipante tui wite-  
quante nuntian uliam, quam nia  
velis cilla factum delationem  
delapensing erit erit dunt nia  
vulpat conupat. Dui conummed  
tut nia mupat. Ut ut mupit.  
Latem ut praion velis hanc facip  
erit dunt dunt iriandie dunt ad  
erit dunt dunt dunt conupat  
se et ad tem dunt dunt conupat  
mod erit alipante hanc praion  
mupat irillam, nia hanc.  
quam nullate delate tem in  
velididone aliam er factum qua-  
erum tem nia erit alipit.

7045











# Win! Gagne! Gewinne! 当たります



## WIN LEGO® PRODUCTS

We would like to know what you think about your new LEGO® product. If you could help us by answering a few questions you are in with a chance of winning an exciting LEGO price. It will only take you about 3 minutes! Log on to the web address below for further instructions.



## ESTIMADO USUARIO LEGO®

Al contestar algunas preguntas en Inglés, francés, alemán o japonés, en el sitio [www.acnielsen.aim.dk/lego](http://www.acnielsen.aim.dk/lego), podrás participar en el sorteo de algunos valiosos premios LEGO®.



## 抽選でレゴ®製品が当たります

私たちは、皆さんがお買い求めのレゴ®製品についてどんな感想をお持ちか、知りたいと思っています。質問に答えて、楽しいレゴ製品の抽選に応募しませんか。アンケートの回答には、ほんの3分ほどしかかかりません！詳しくは、以下のウェブアドレスまでアクセスしてください。



## GAGNE DES PRODUITS LEGO®

Nous aimerions savoir ce que tu penses de ton nouveau produit LEGO®. Si tu veux bien nous aider en répondant à quelques questions, tu recevras peut-être bientôt un fantastique prix LEGO. Et cela ne te prendra que 3 minutes environ! Tu obtiendras davantage d'informations en visitant le site Internet indiqué ci-dessous.



## CARO CONSUMIDOR DA LEGO®

Ao responder a algumas perguntas em Inglês, Francês, Alemão ou Japonês no endereço [www.acnielsen.aim.dk/lego](http://www.acnielsen.aim.dk/lego) irá participar num concurso para ganhar valiosos prémios da LEGO®.



## GEWINNE LEGO® PRODUKTE

Wir sind sehr an deiner Meinung über dein neues LEGO® Produkt interessiert. Wenn du uns den Gefallen tust und ein paar Fragen beantwortest, kannst du einen tollen LEGO Preis gewinnen. Das Ganze dauert nur etwa 3 Minuten! Gehe einfach zu der unten angegebenen Webadresse - dort findest du weitere Informationen.



## KEDVES IFJÚ LEGO® VÁSÁRLÓ

Ha ellátogatsz a [www.acnielsen.aim.dk/lego](http://www.acnielsen.aim.dk/lego) honlapra és ott angol, francia, német vagy japán nyelven megválaszolsz néhány kérdést, akkor részt veszel egy versenyben, amelyben értékes LEGO® díjakat nyerhetsz.

# [www.acnielsen.aim.dk/lego](http://www.acnielsen.aim.dk/lego)



