

**LEGO**

# NINJAGO™

Masters of Spinjitzu



70589



[LEGO.com/NINJAGO](http://LEGO.com/NINJAGO)



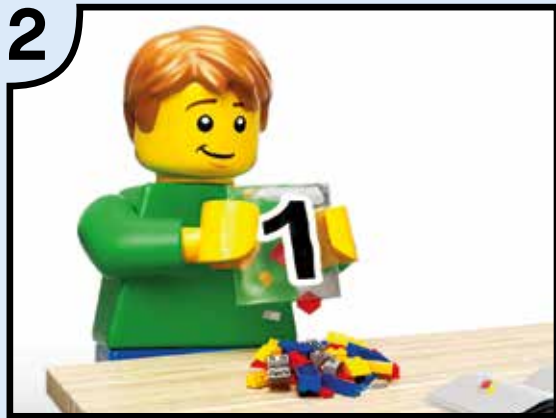

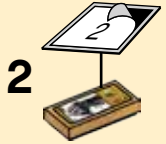
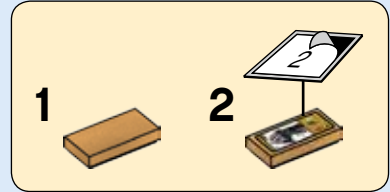
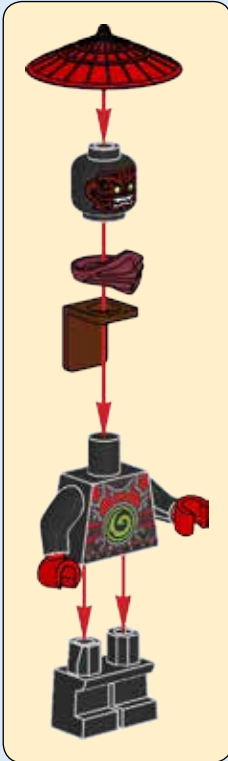

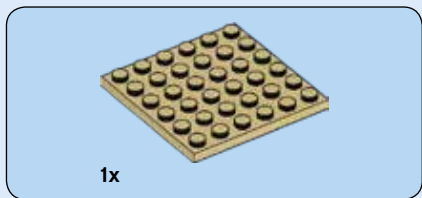

1

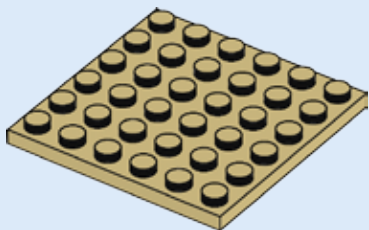

4

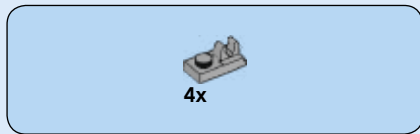

2

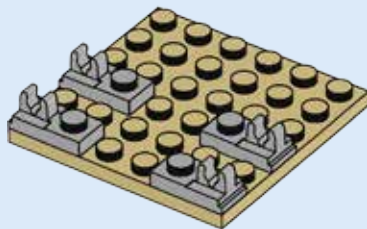



1x

3

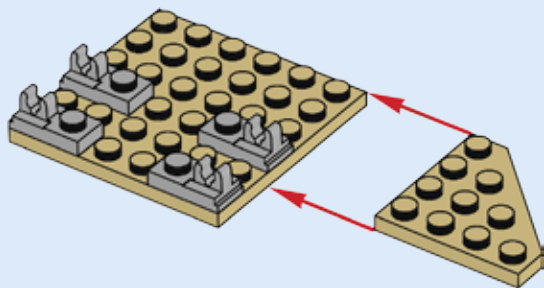

1x

4

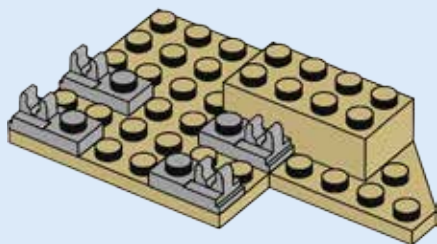



2x



1x

5

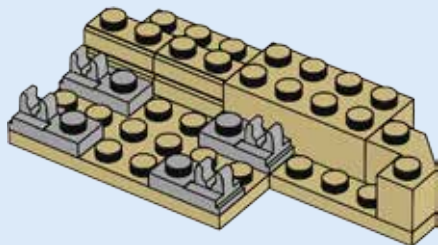

6



1x



1x

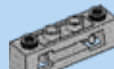

1x



6

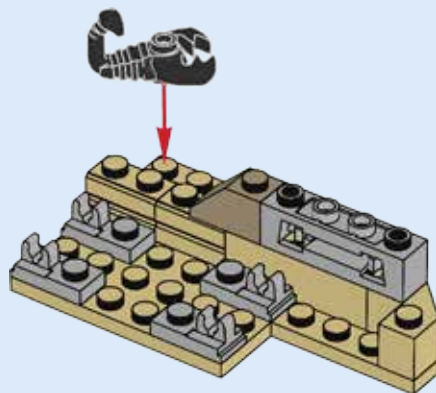

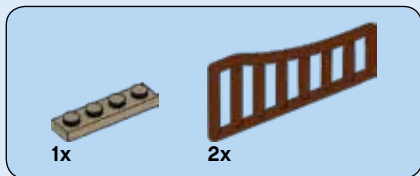

7

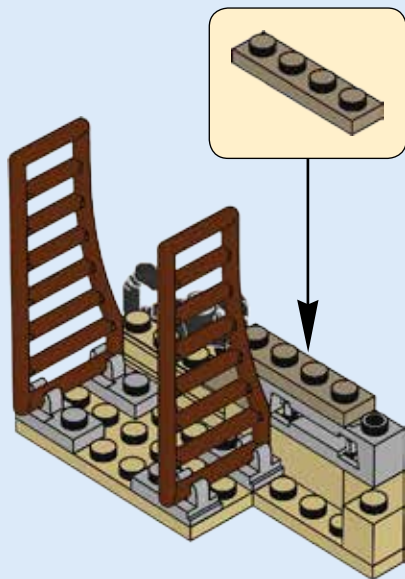





8

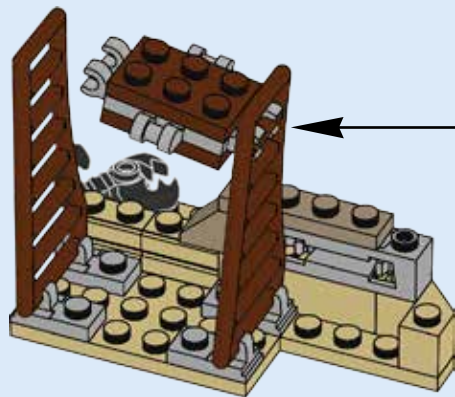
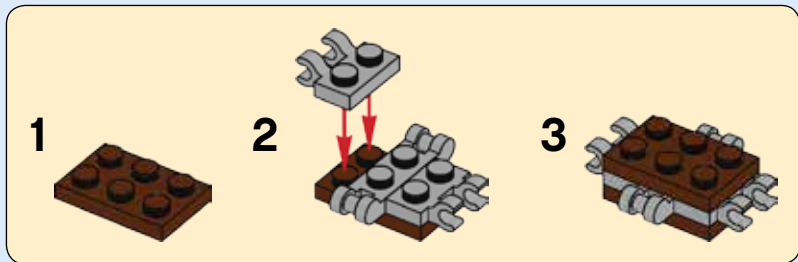



# 9

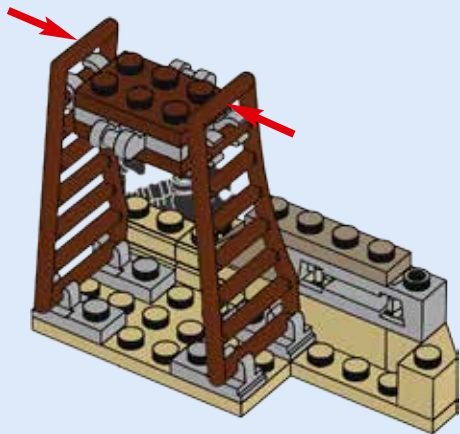

# 10

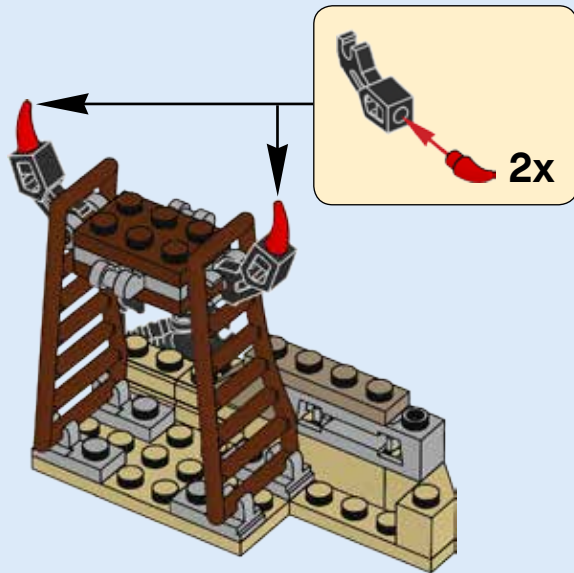

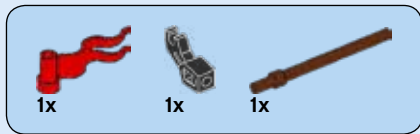

11

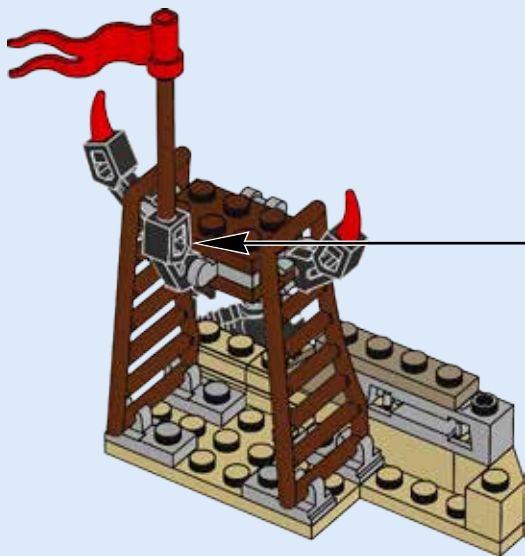

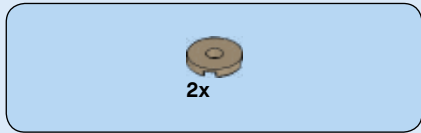

12

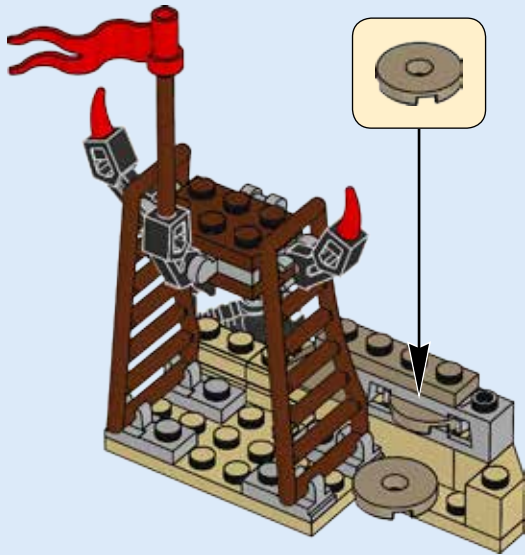



13

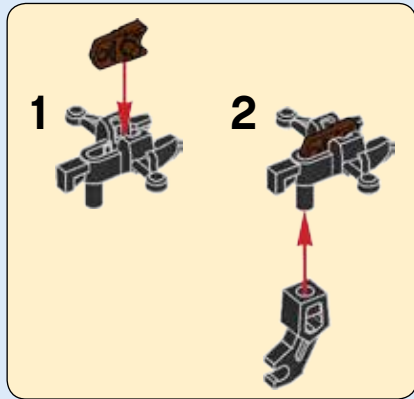
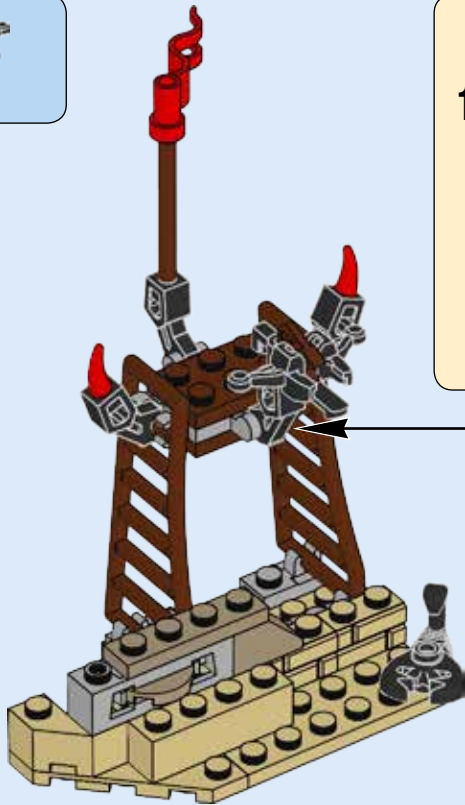
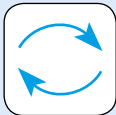



2x

# 14



2x

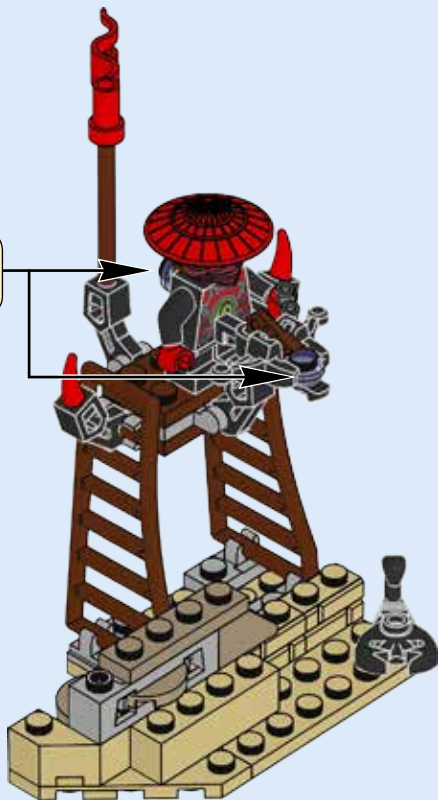

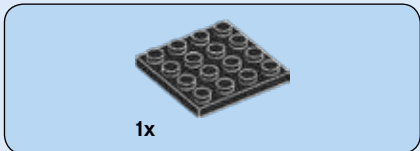

1x

1

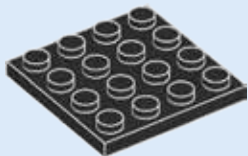

1x

2x

2x

2

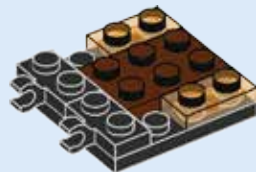



1x



2x

# 3

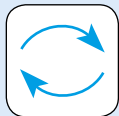

2x



2x

# 4

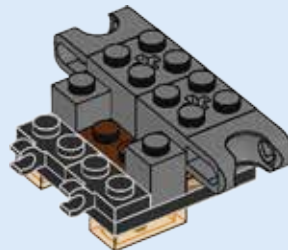
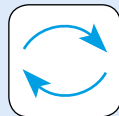





1x



2x

5

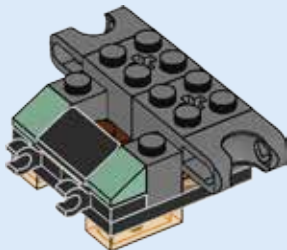



2x

6

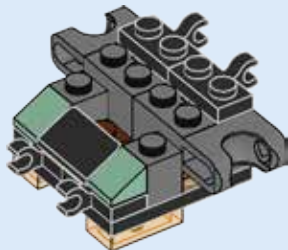

2x



1x



1x

7

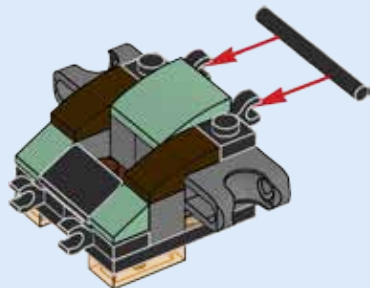

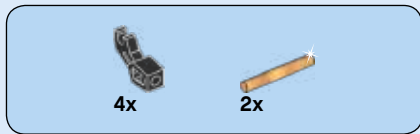

8

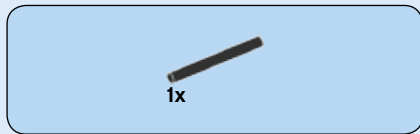
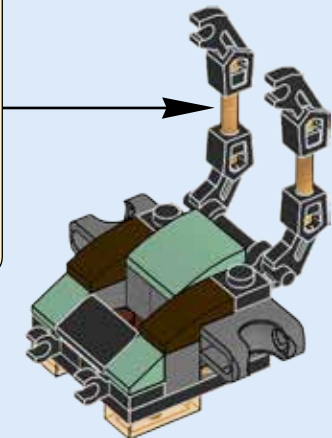
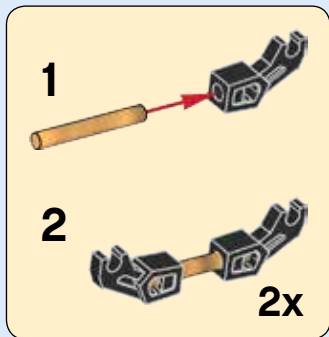

9

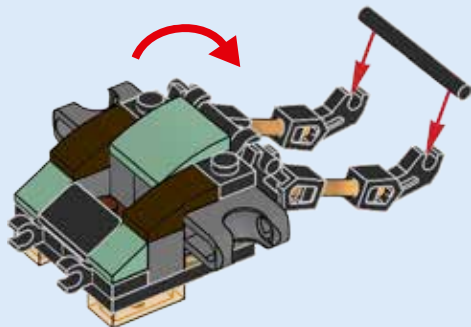



2x



1x

# 10



1x



1x



1x

# 11

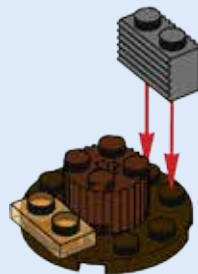



2x



4x

# 12

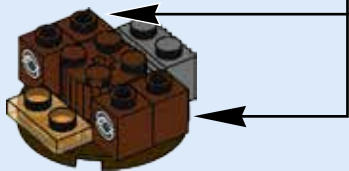
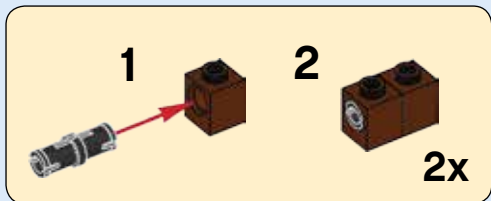

1x



1x

# 13



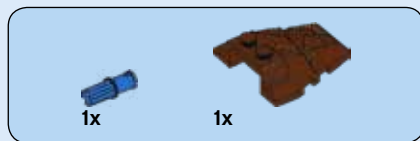

14

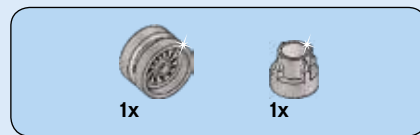

15

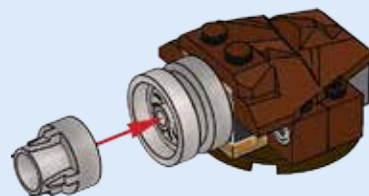



2x

# 16

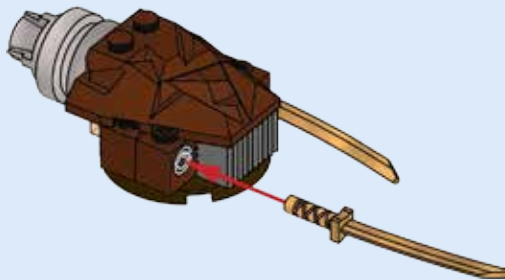

1x

# 17

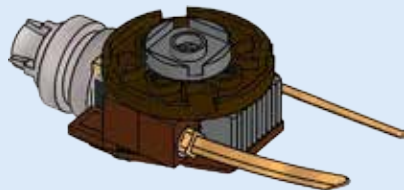
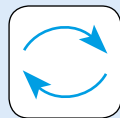





18

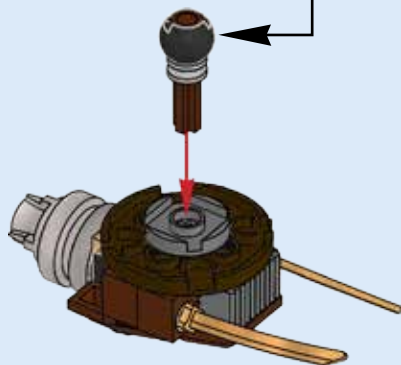
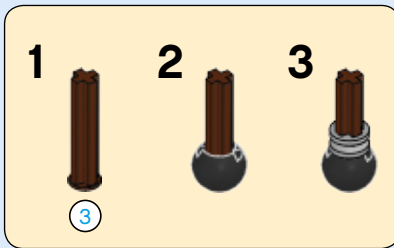

2x

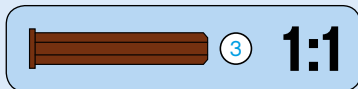

19

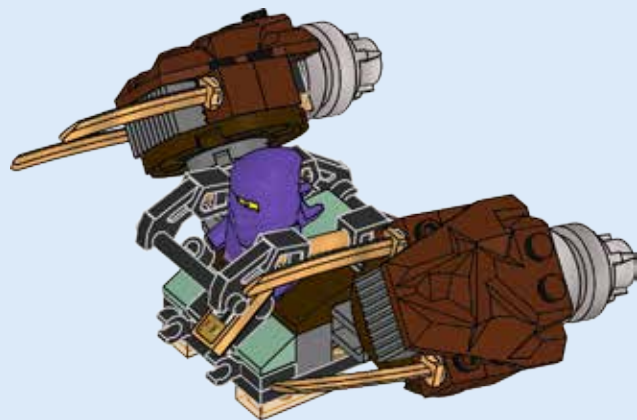
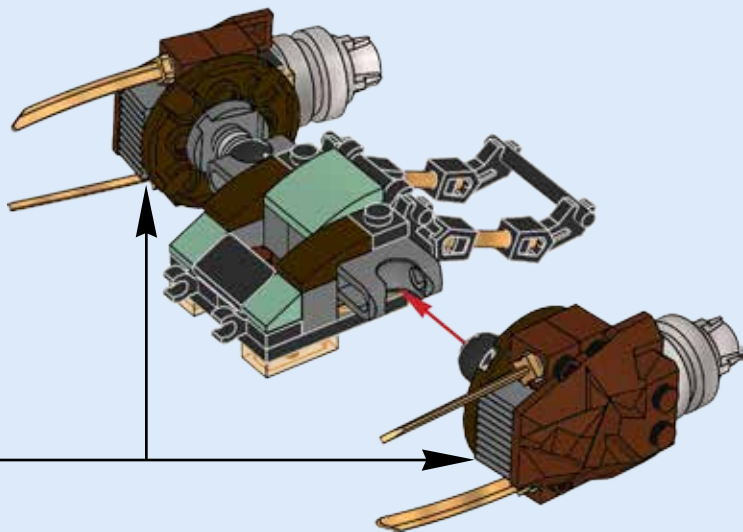

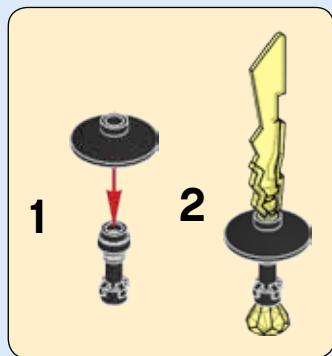
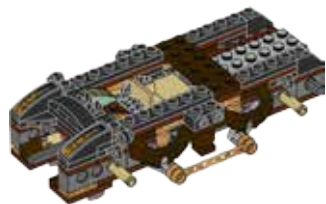
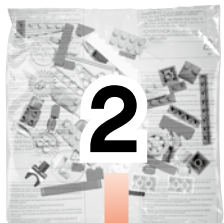

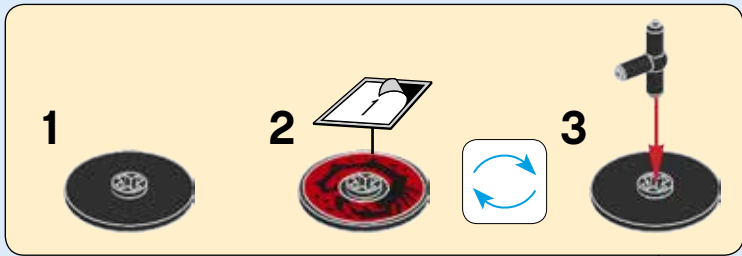

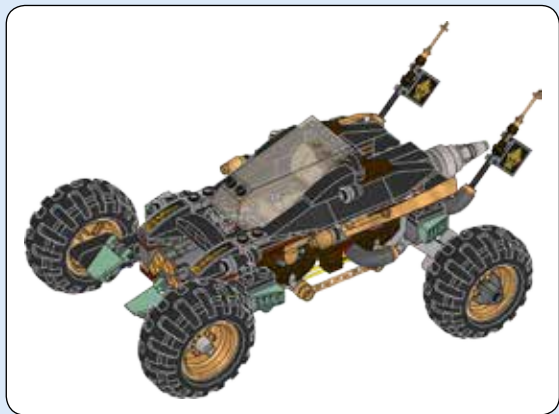

1





2

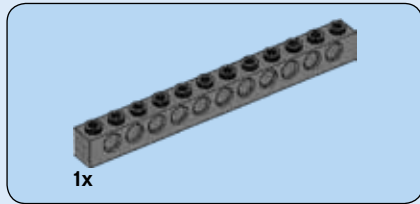
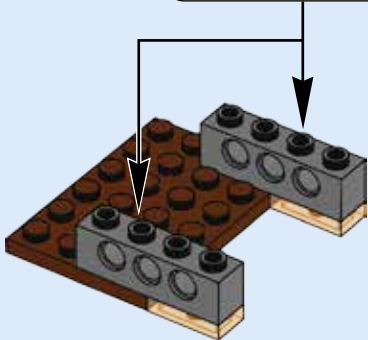
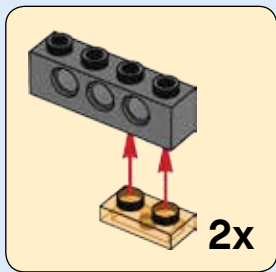

3

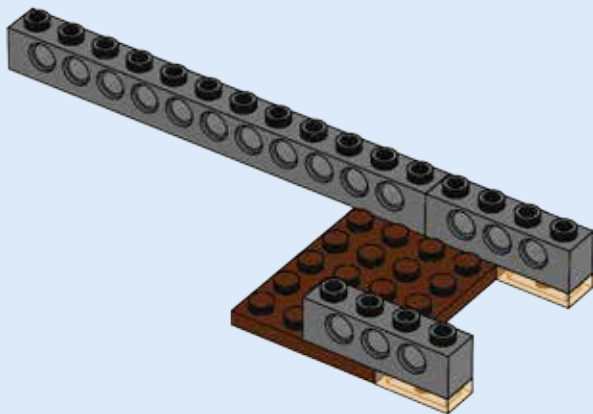



4

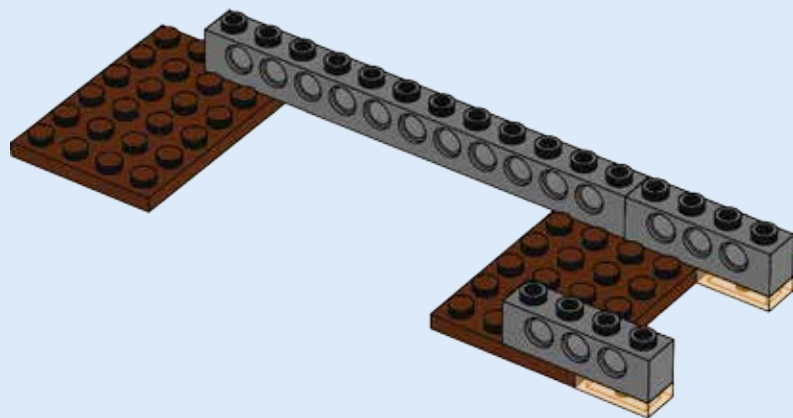





4x

5

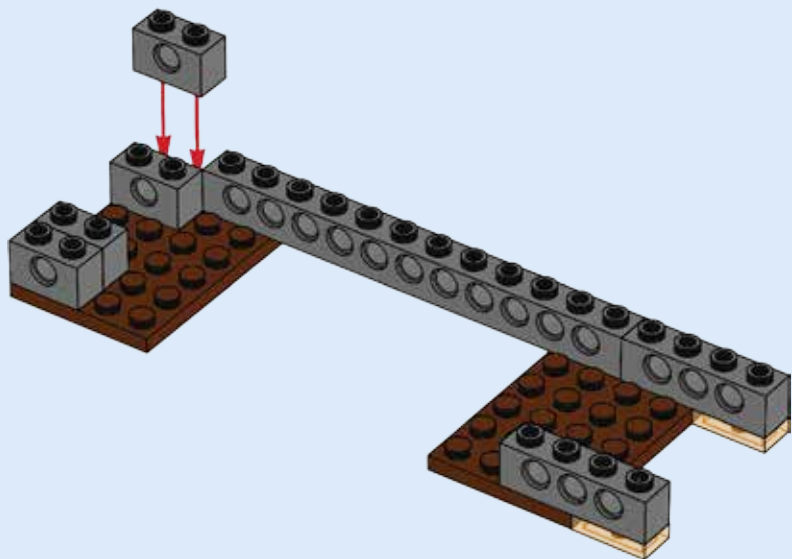

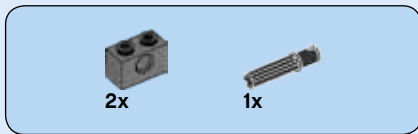

6

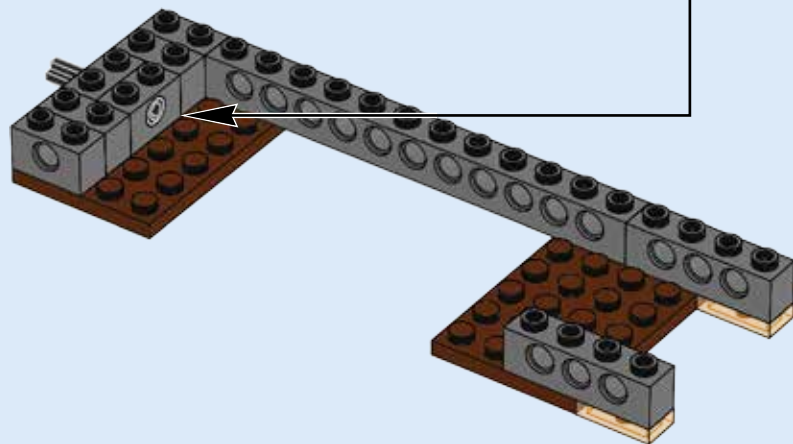
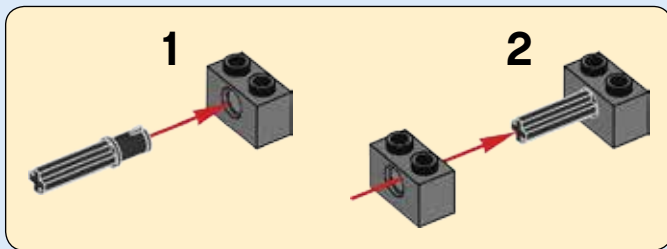



4x

7

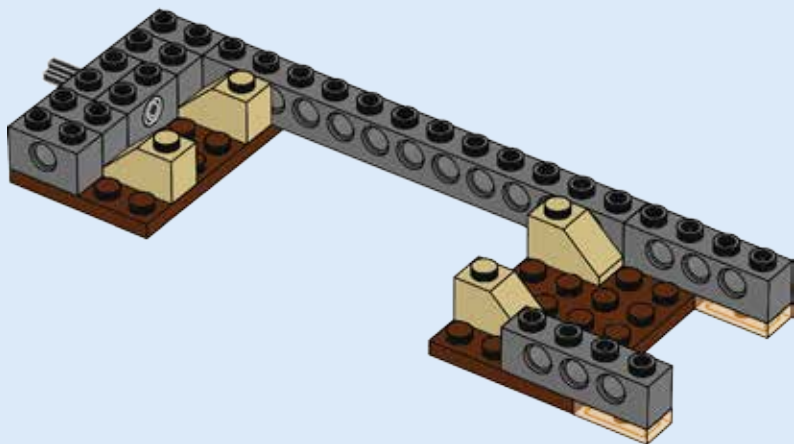



2x

8

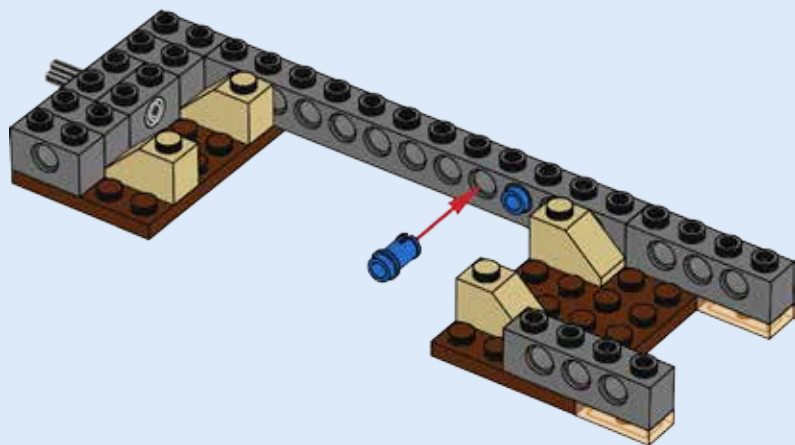



9

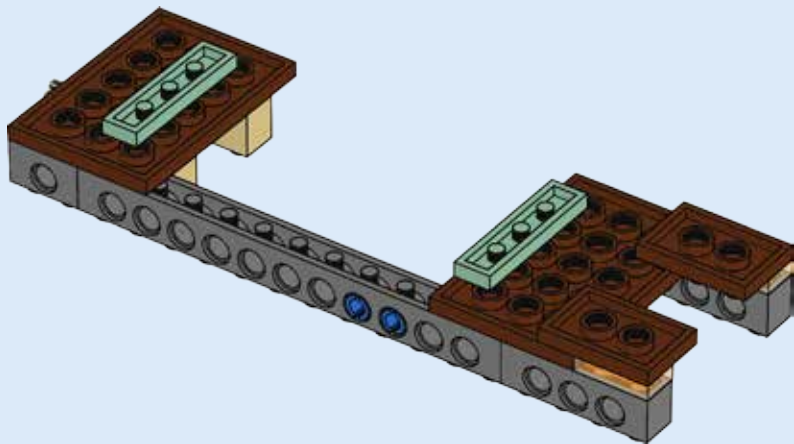
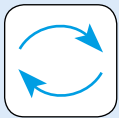



2x



4x

# 10

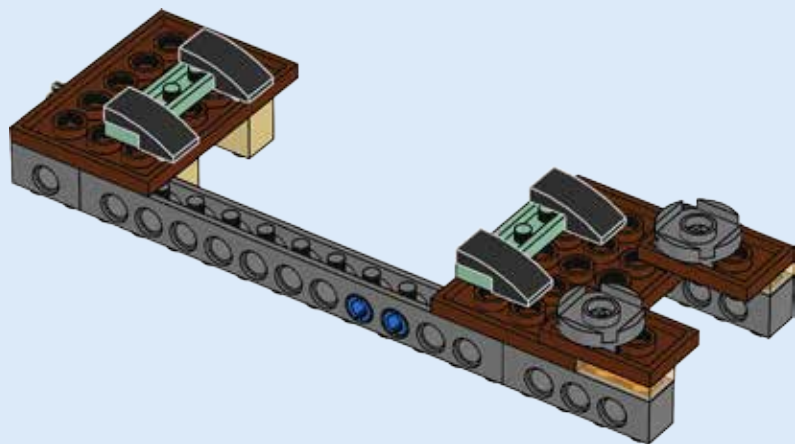



2x

# 11

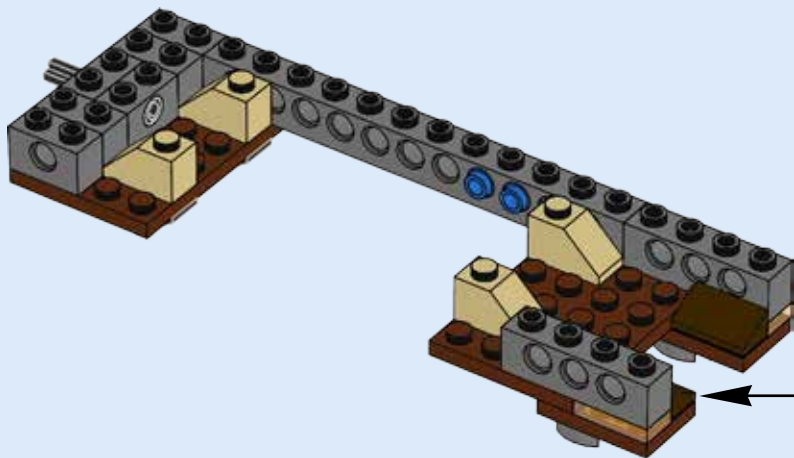
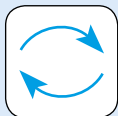





12

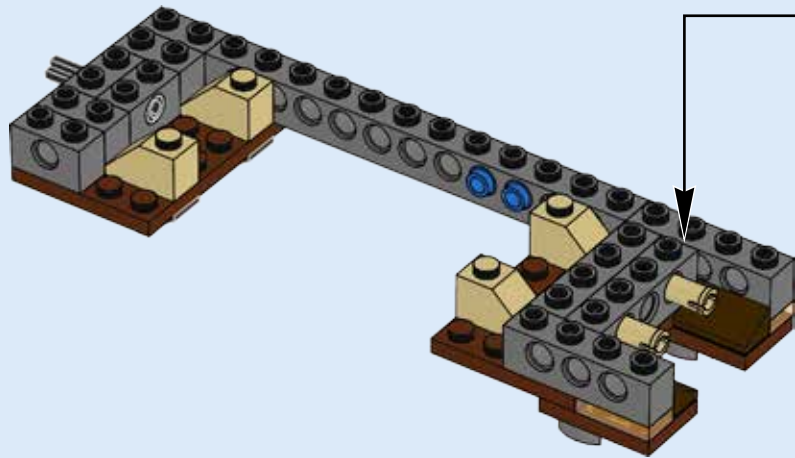
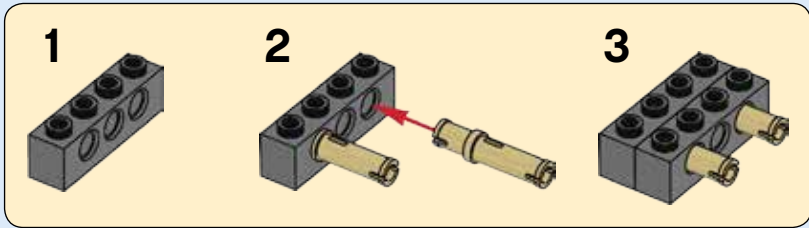

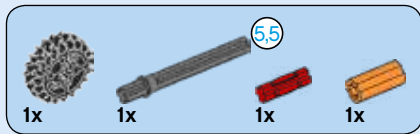

# 13

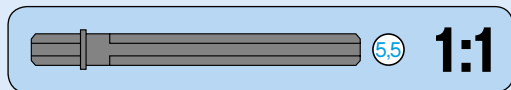
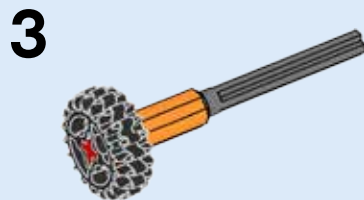
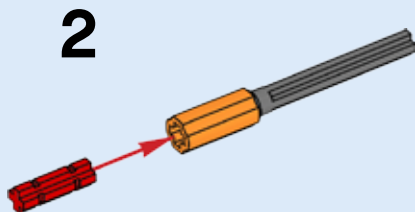
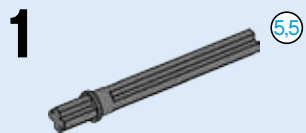

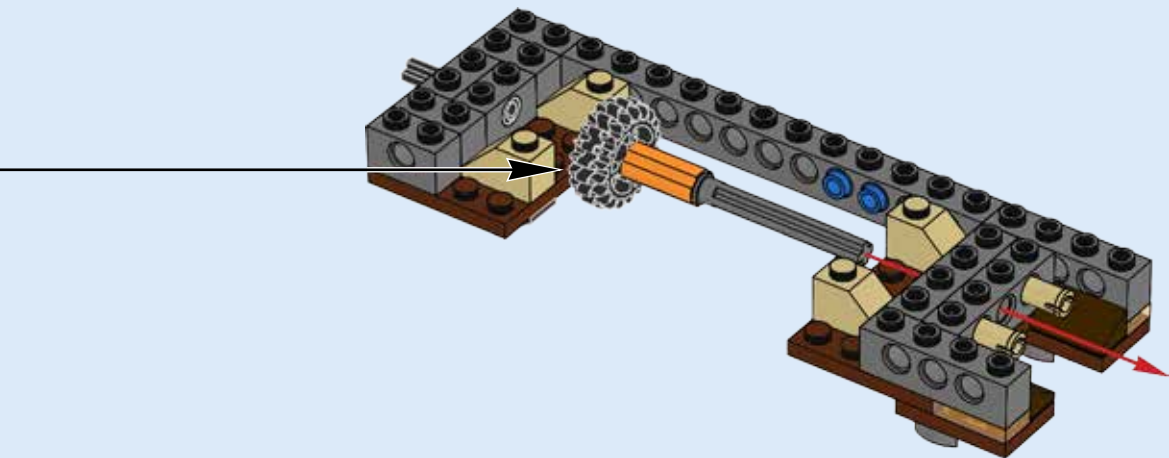

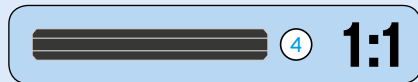
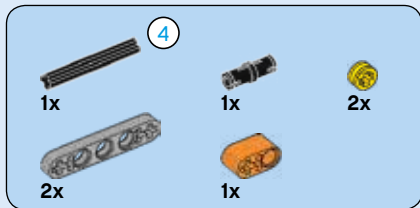

# 14

## 1



## 2

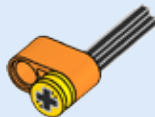

## 3

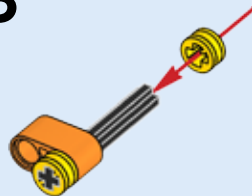

4

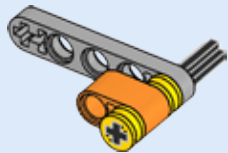

5

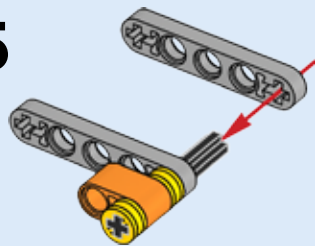

6

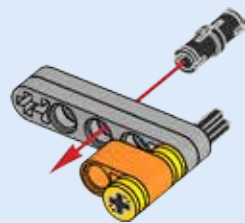

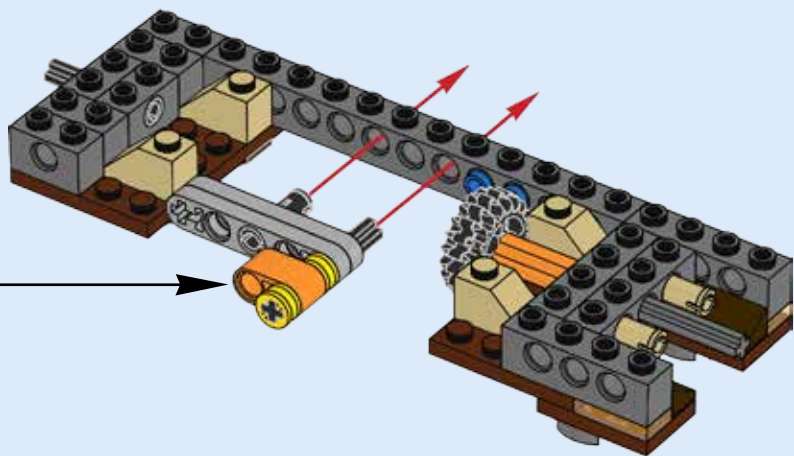

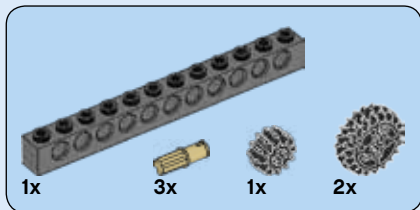

15

1

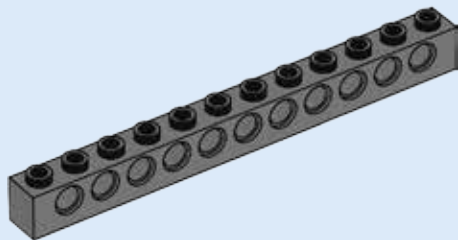

2

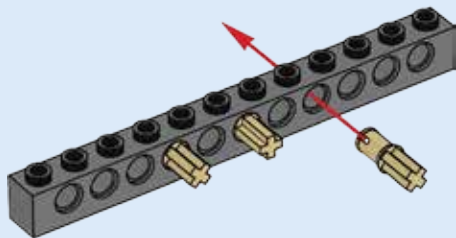

3

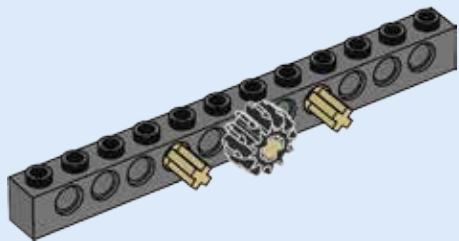

4

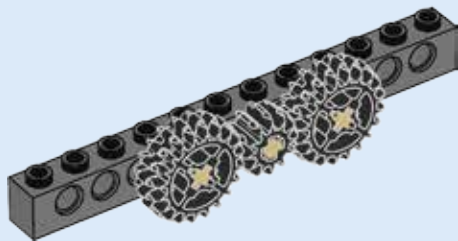



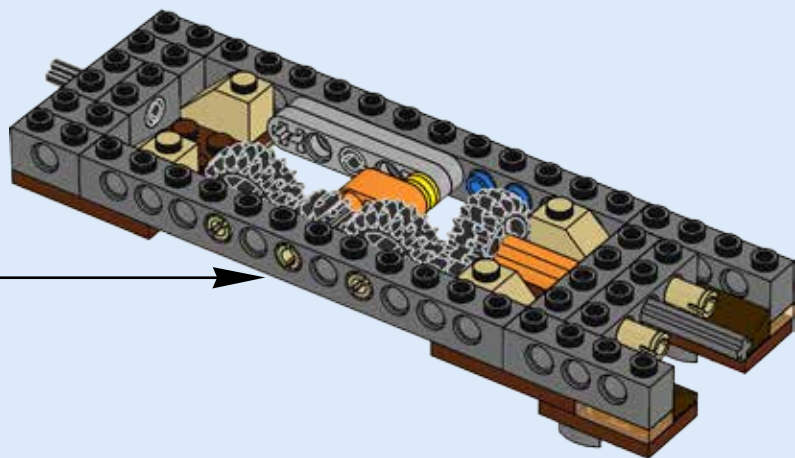



16

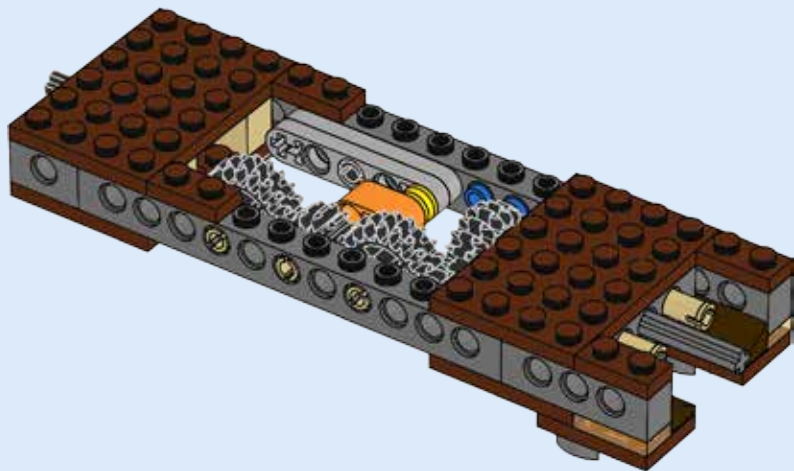



2x

17

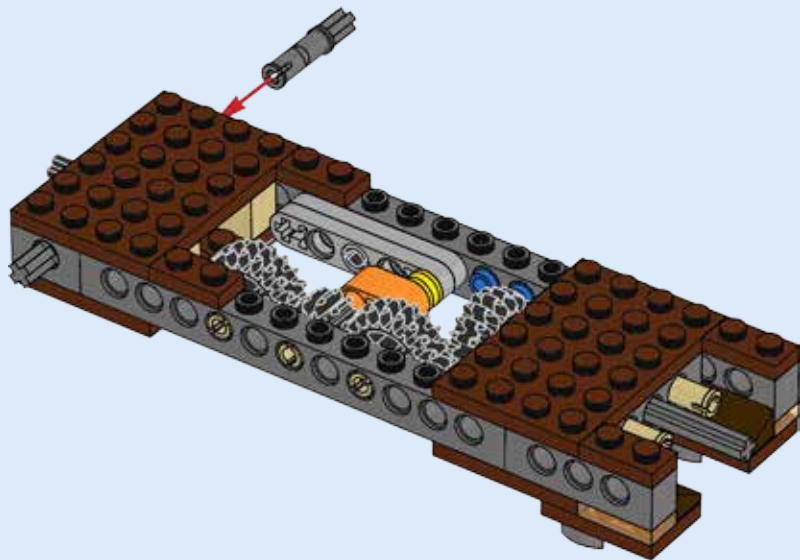



1x



4x

# 18



2x

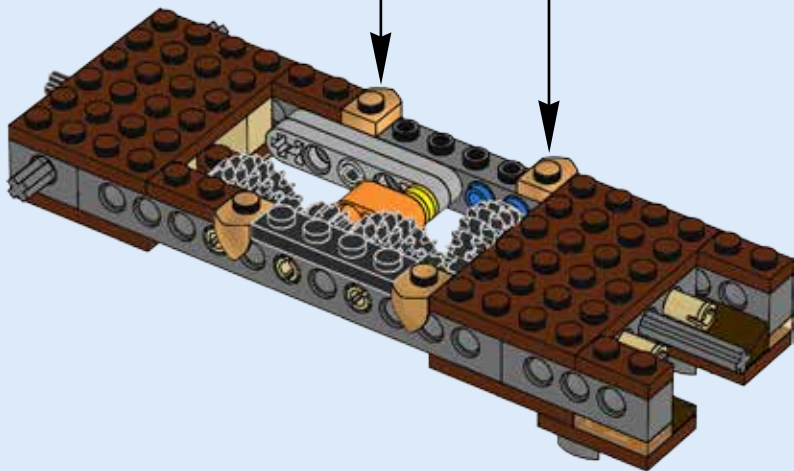

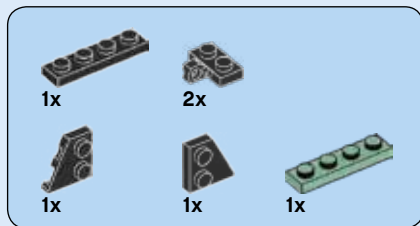

19

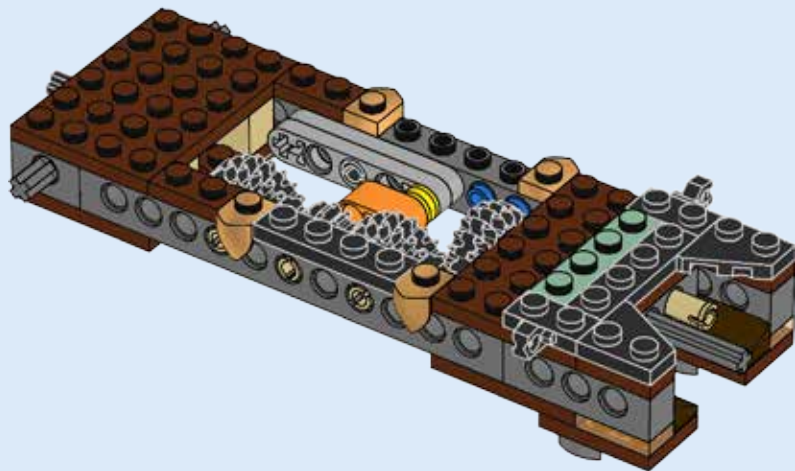



2x



2x

# 20

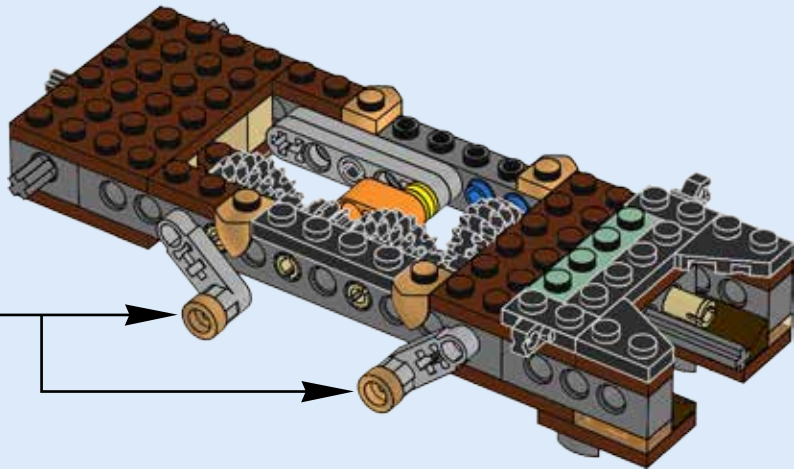

2x



1x

# 21

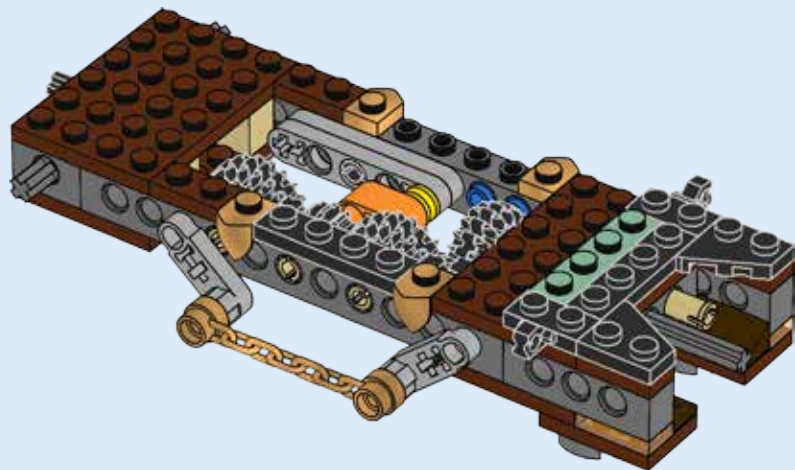



2x



2x

# 22

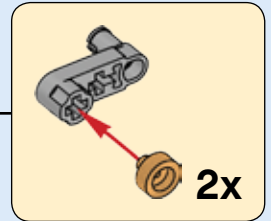
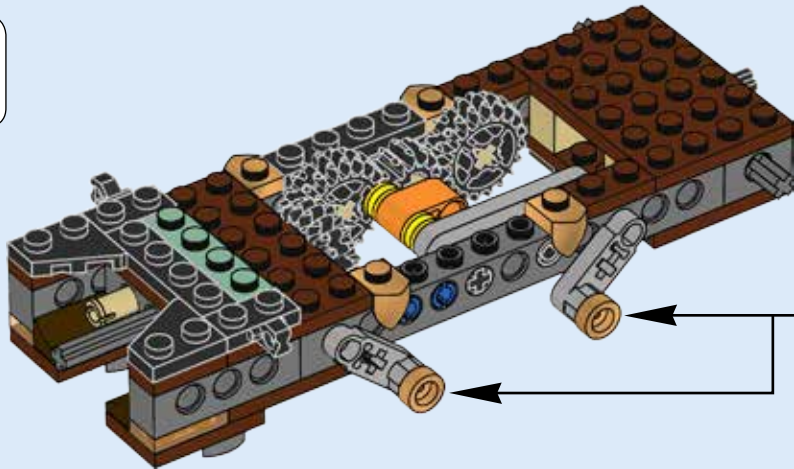
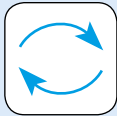





1x

# 23

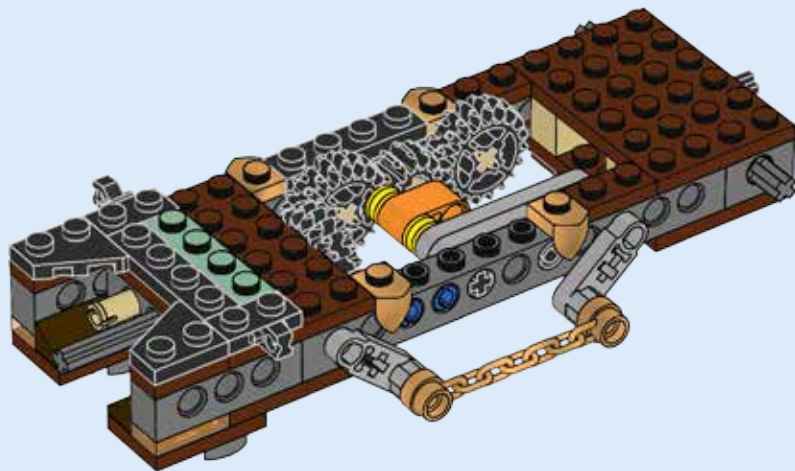

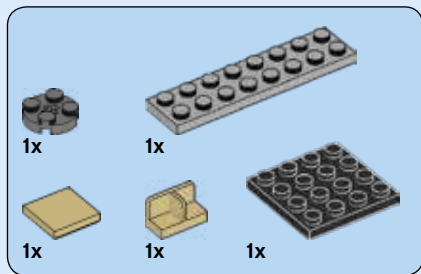

# 24

## 1

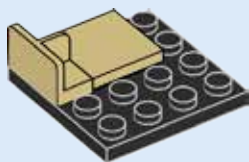

## 2

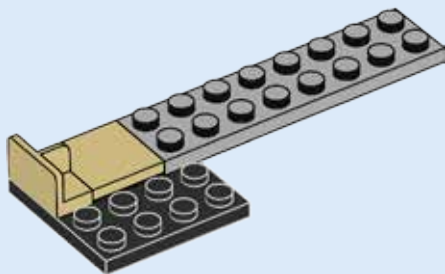

## 3

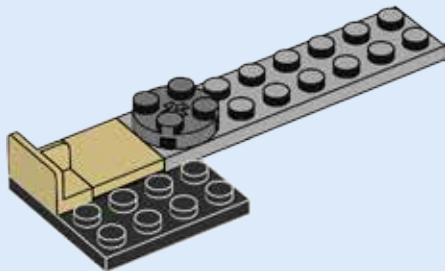

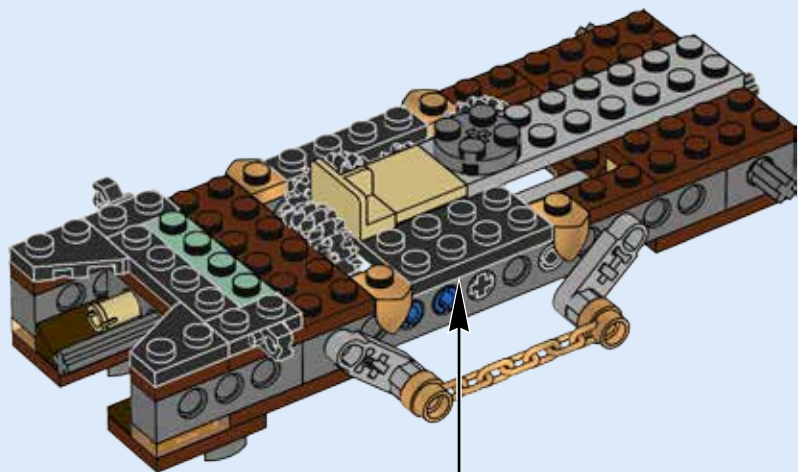



2x



2x

# 25

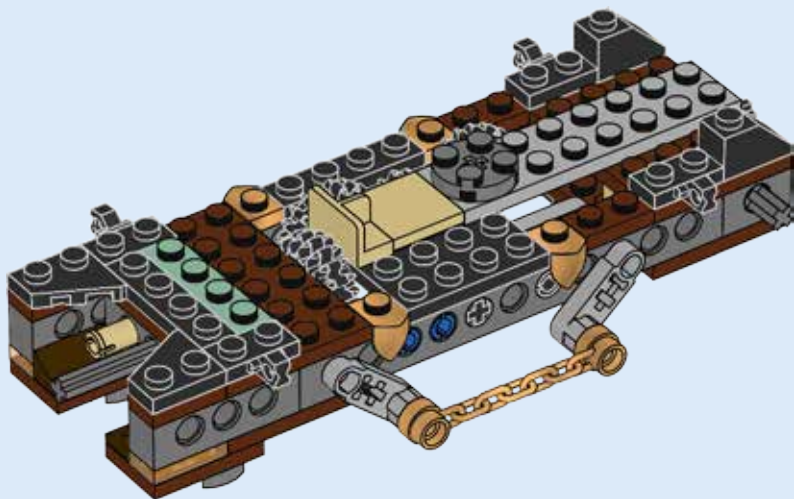



4x

# 26

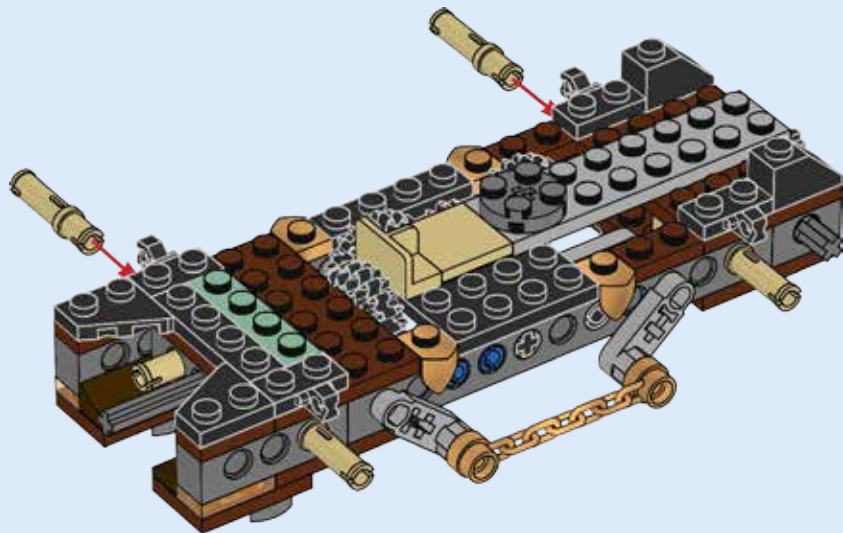



27

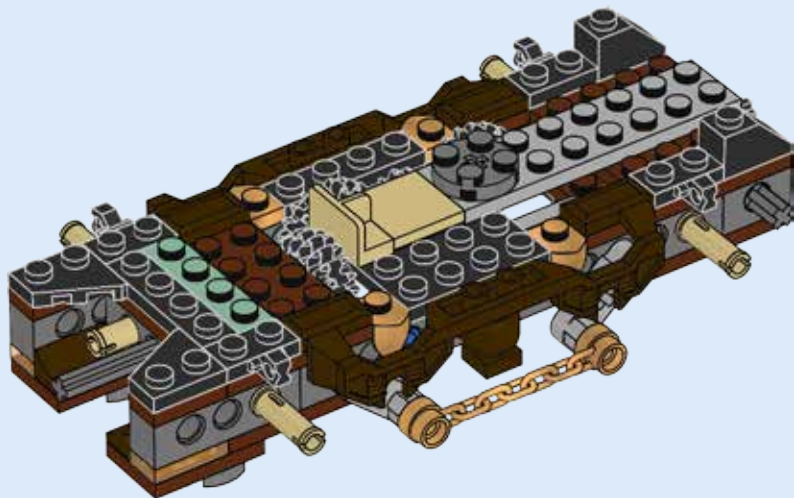



5x



2x

# 28

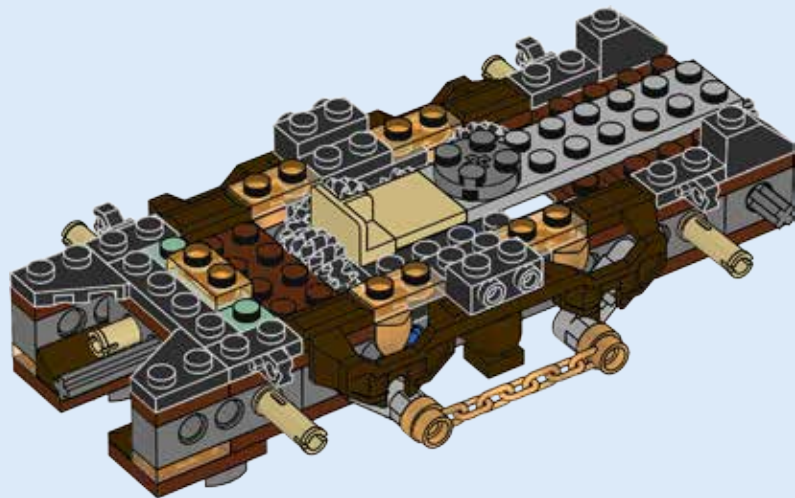



2x

# 29

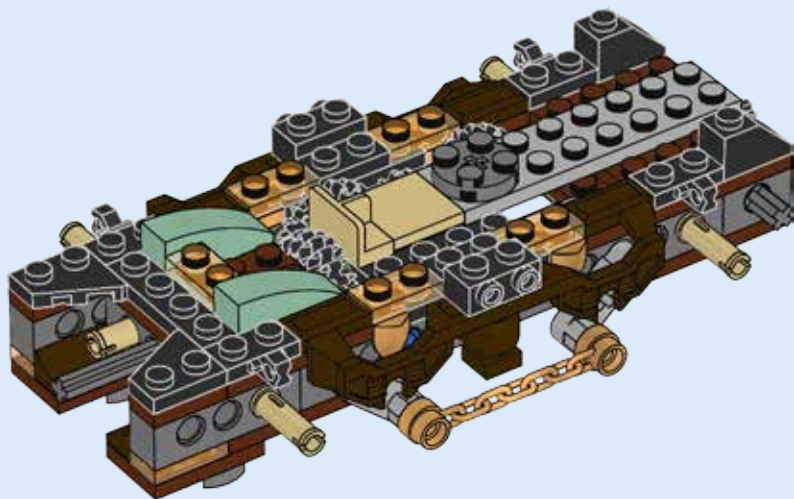



# 30

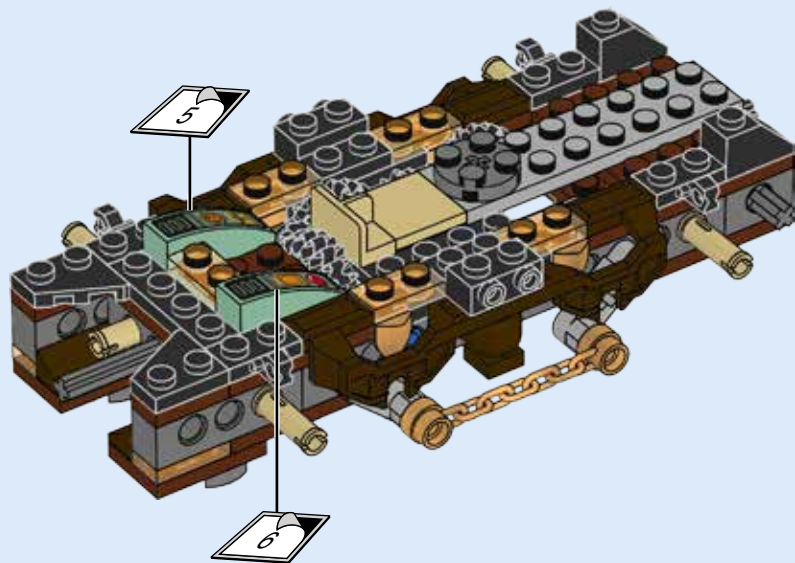

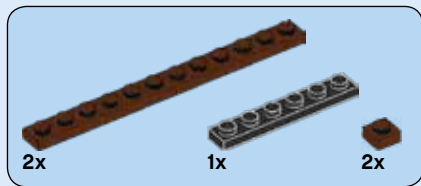

**31**

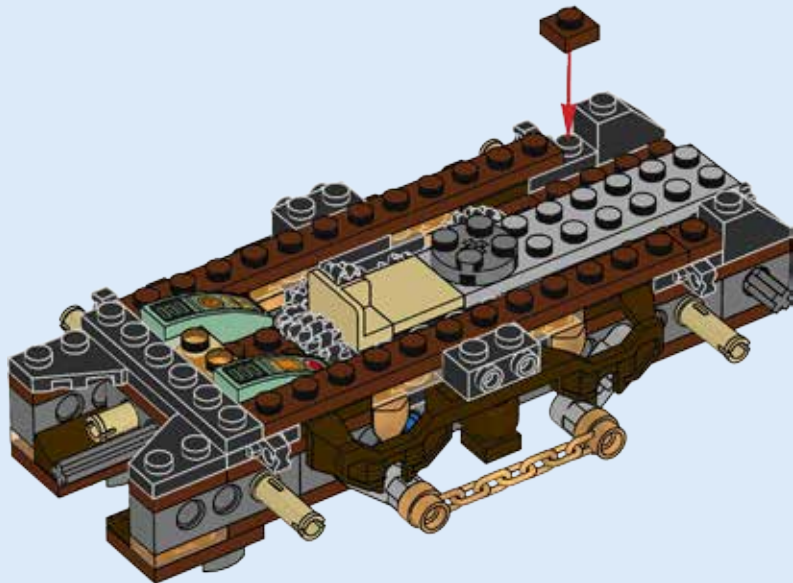



32

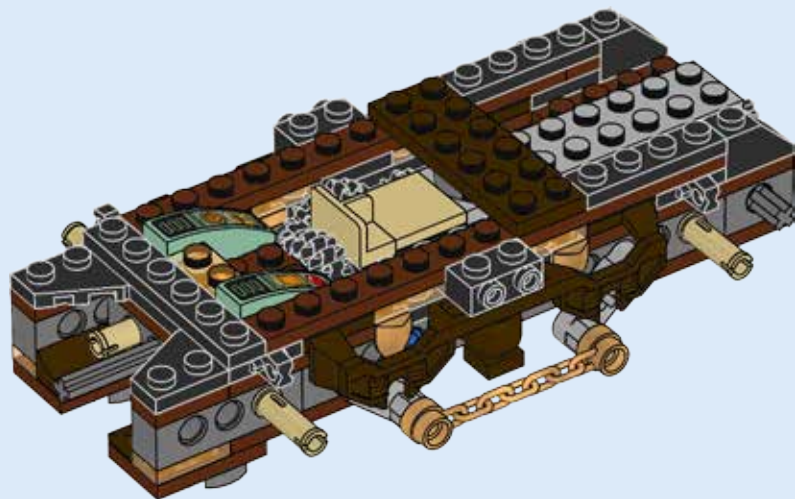

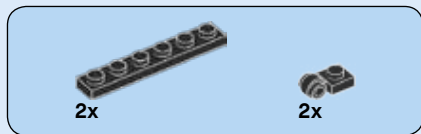

# 33

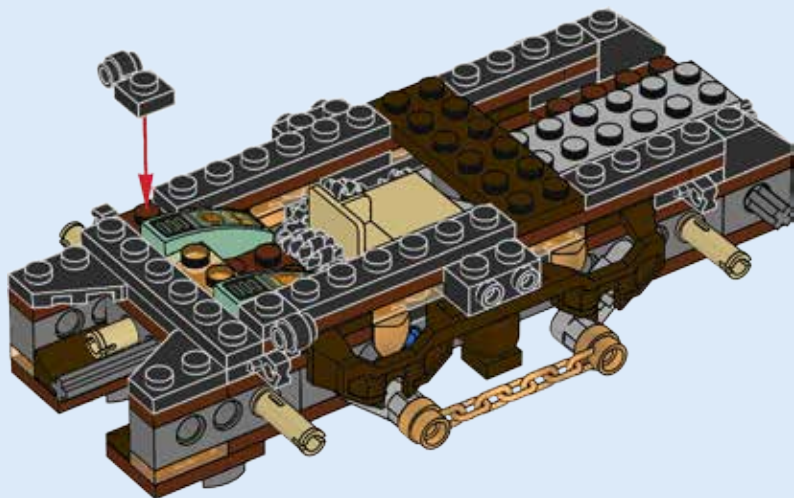



2x

# 34

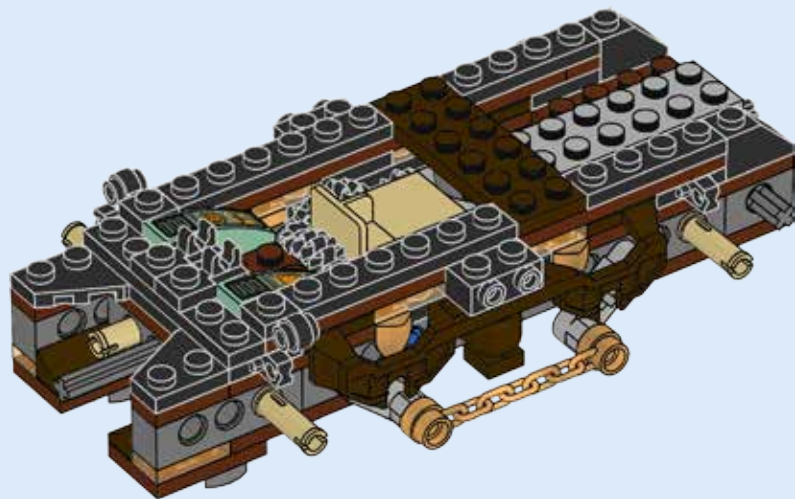



2x



1x

# 35

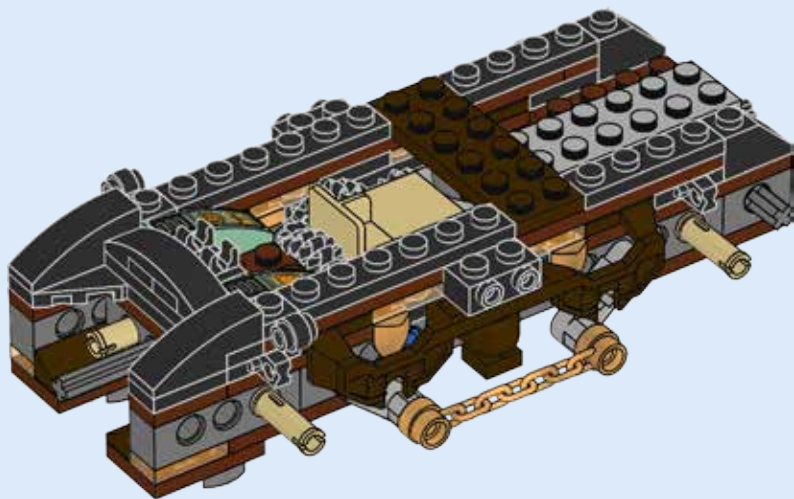

# 36

