

LEGO

NINJAGO

70672



A circular graphic element in the bottom right corner. It features a blue and white color scheme. At the top, there is a small icon of a smartphone displaying a QR code, with a blue Ninjabot character holding it. Below this is a blue and white icon of a smartphone displaying a QR code, with a blue Ninjabot character holding it. At the bottom, there is a blue and white icon of a smartphone displaying a QR code, with a blue Ninjabot character holding it. The text "Instructions PLUS" is written in blue and white. At the bottom, there is a blue and white icon of a smartphone displaying a QR code, with a blue Ninjabot character holding it. The text "LEGO LIFE" is written in blue and white.





- 1** Download the LEGO® Life App  
 Lade dir die LEGO® Life App herunter  
 Télécharge l'application LEGO® Life  
 Télécharger l'application LEGO® Life  
 Scarica l'app LEGO® Life  
 Descarga la app LEGO® Life  
 Descarrega a App LEGO® Life  
 Töltsd le a LEGO® Life Appot!  
 Lejupielādē lietotni LEGO® Life  
 下载 LEGO® Life 应用程序



- 2** Scan the code on the front cover  
 Scanne den Code auf der Titelseite  
 Scanne le code sur la page de  
 couverture  
 Scanner le code sur la page  
 couverture  
 Scansiona il codice sulla copertina  
 Escanea el código de la portada  
 Faz scan do código na frente da capa  
 Olvasd be a borítón látható kódot!  
 Noskenē kodu uz priekšējā vāka  
 扫描封面上的二维码



- 3** Get Instructions PLUS  
 Hol dir Instructions PLUS  
 Obtens les instructions PLUS  
 Obtenir les Instructions PLUS  
 Scarica Instructions PLUS  
 Descubre Instruccions PLUS  
 Obtém Instruções PLUS  
 Szerezd be az Instructions PLUS  
 kiegészítőt!  
 Sanem "Instructions PLUS"  
 获取更多说明

**LEGO.com/apps**

Check for compatibility  
 Kompatibilität prüfen  
 Vérifier la compatibilité  
 Controlla la compatibilità  
 Comprueba tu compatibilidad

Verificar a compatibilidade  
 Ellenőrizd a kompatibilitást  
 Pārbaudīt saderību  
 检查兼容性

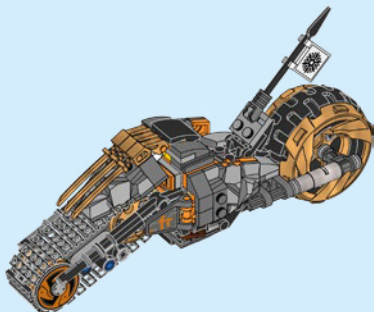
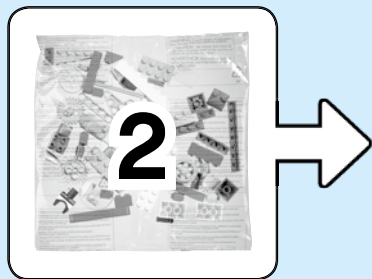
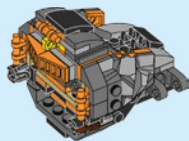
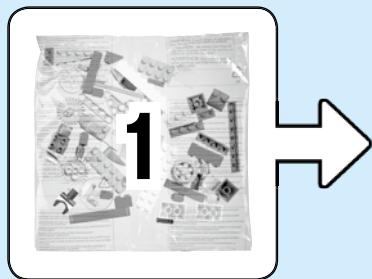

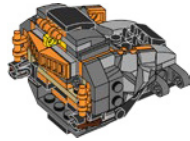
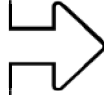

1

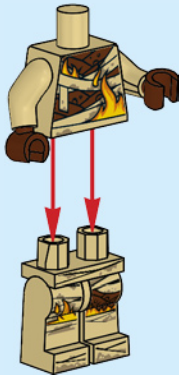

2

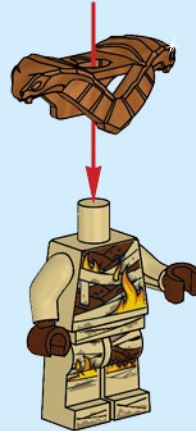

3





1

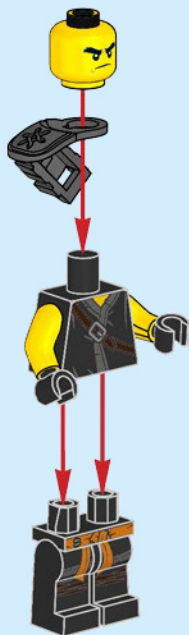

6

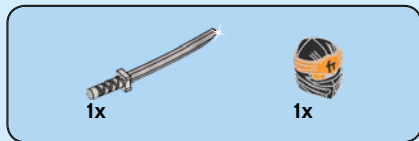

2



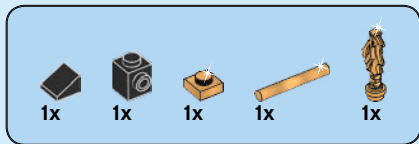

3

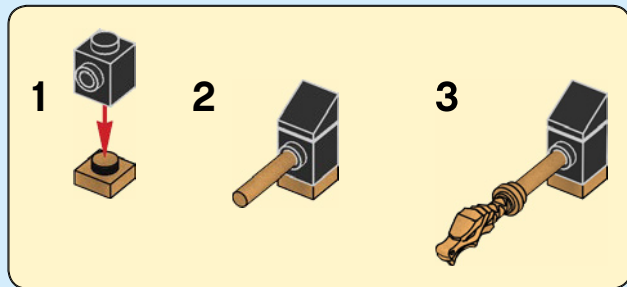

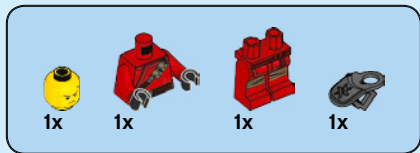

1

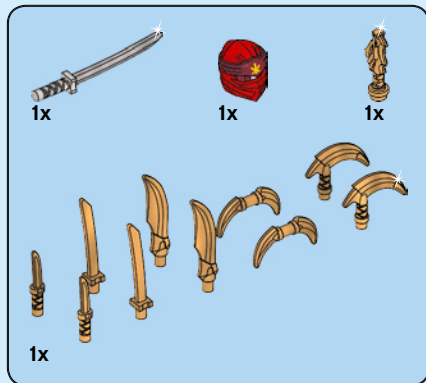
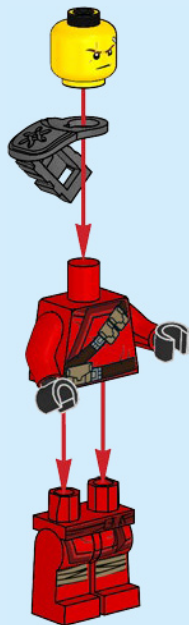

2

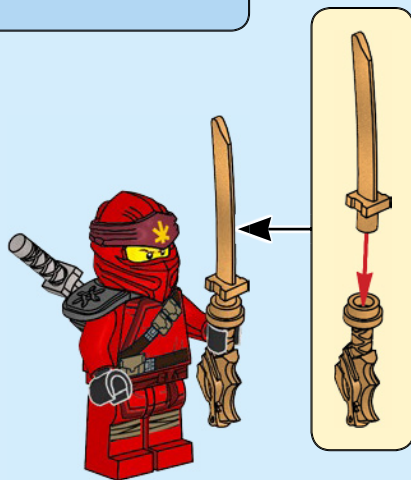



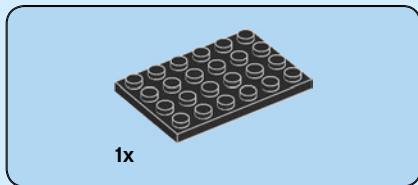
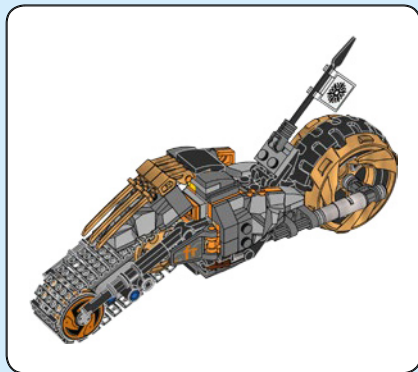

**1**

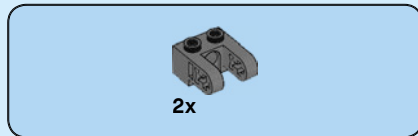
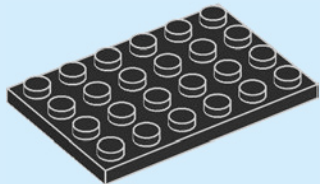

**2**

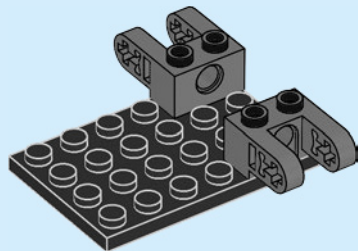

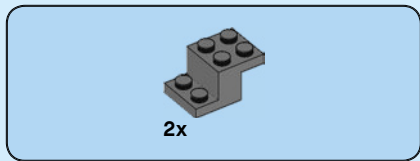

3

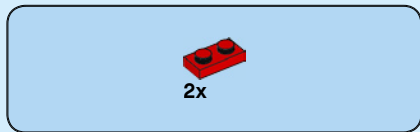
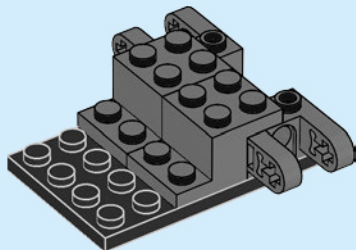

4

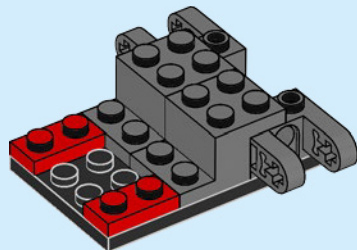



4x

5

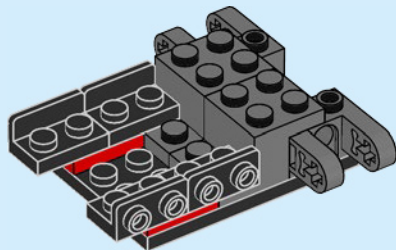

1x



2x

6

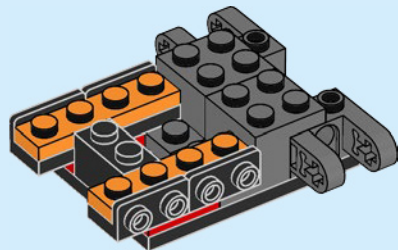

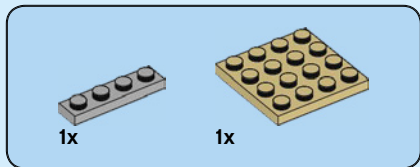

7

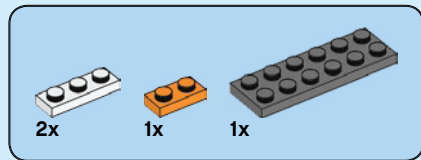
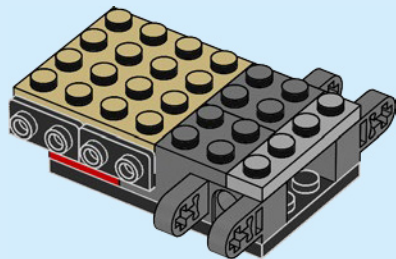

8

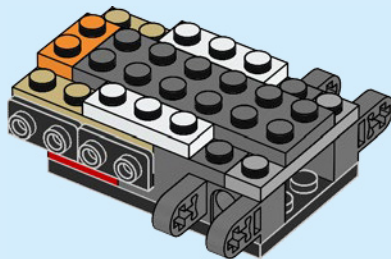



1x



1x



2x

# 9

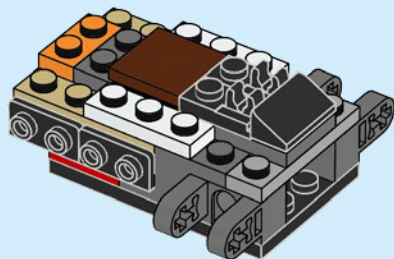

2x



2x

# 10

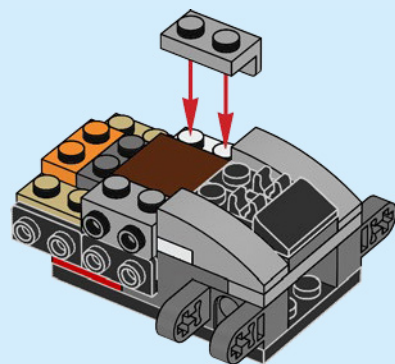



2x

11

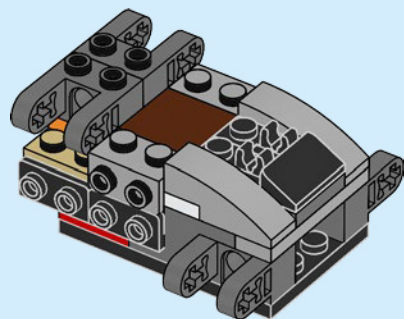

2x



2x

12

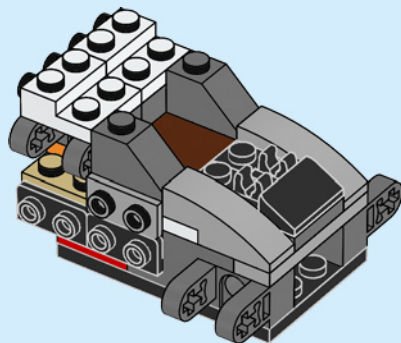



2x



1x

# 13

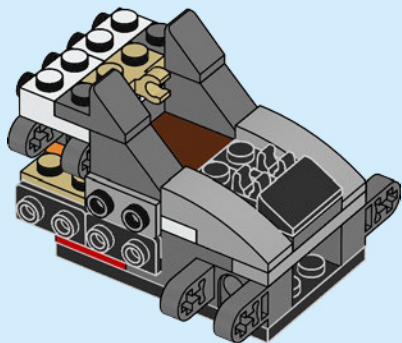

1x



1x

# 14

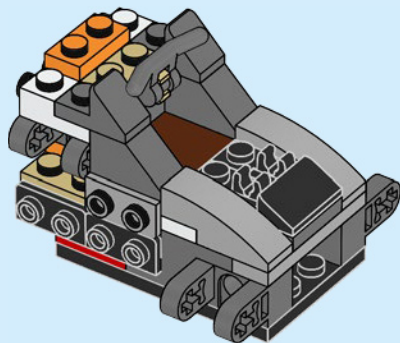



2x



2x

# 15

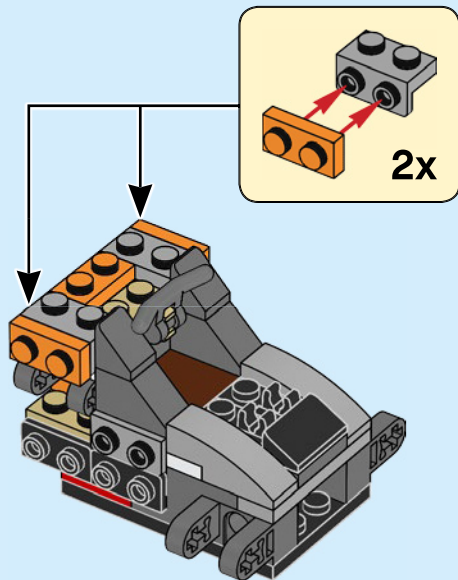

1x



2x

# 16

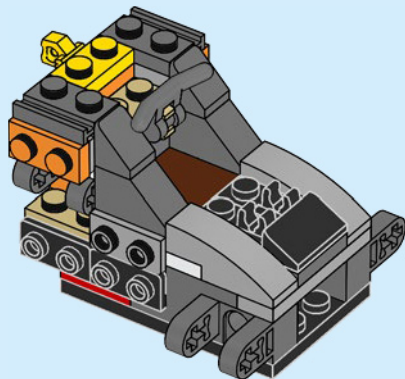





1x



1x

# 17

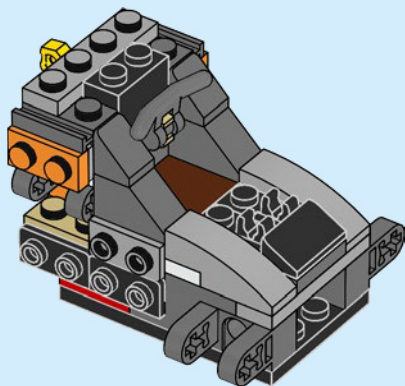

1x

# 18

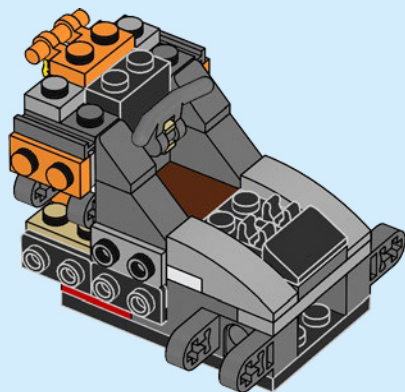



2x



1x

# 19

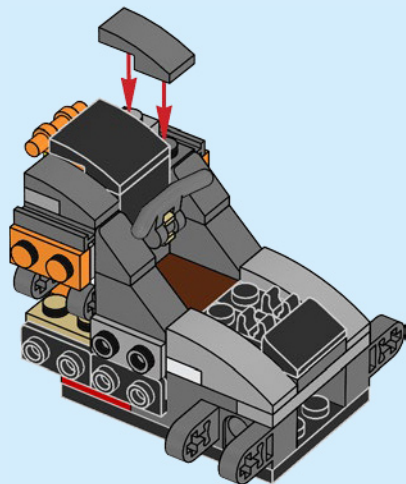

18



1x

# 20

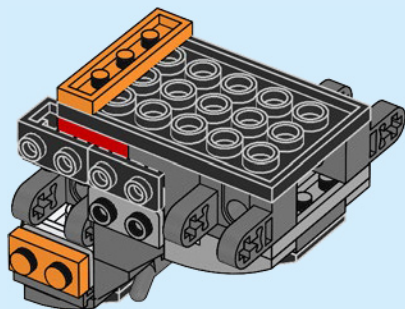





1x



1x

# 22

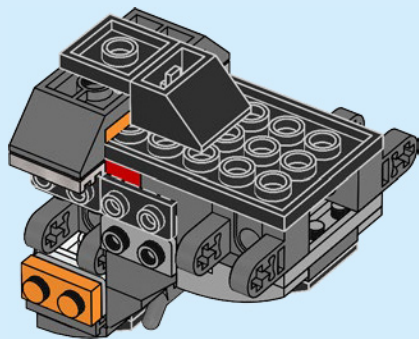

2x



2x

# 23

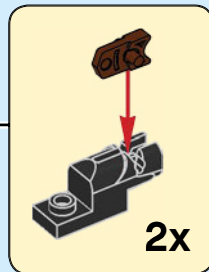
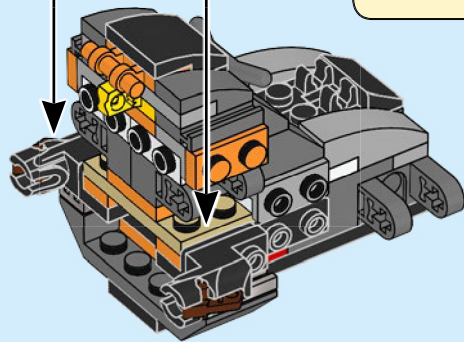

2x



1x



1x

24

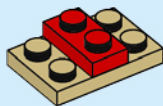

1x

25

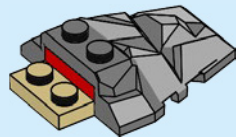

1x

26

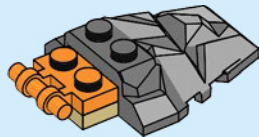



1x



1x

27

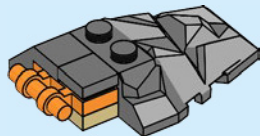

22



1x

28

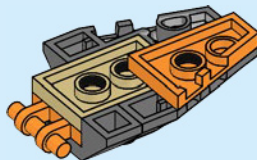

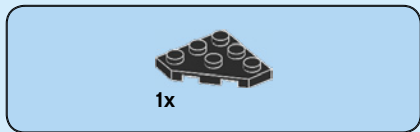

29

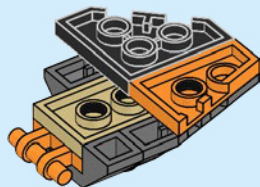

30

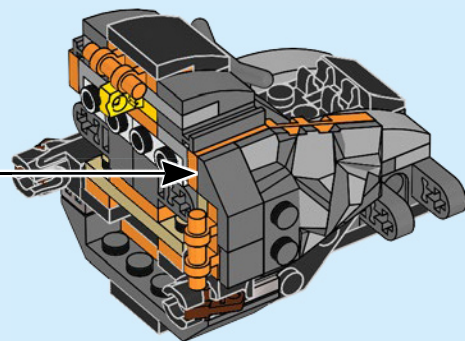



1x



1x

# 31

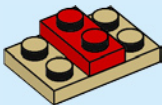

1x

# 32

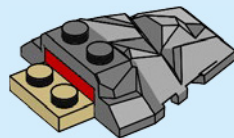





1x

33

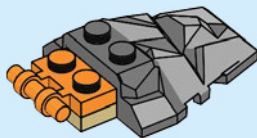

1x



1x

34

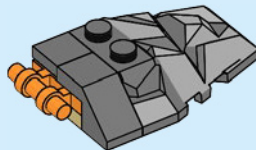

1x

35

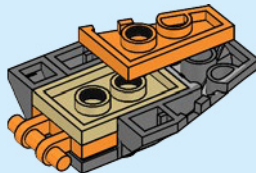
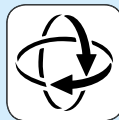



1x

36

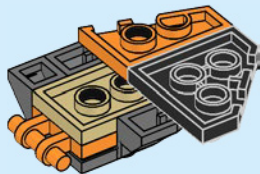

37

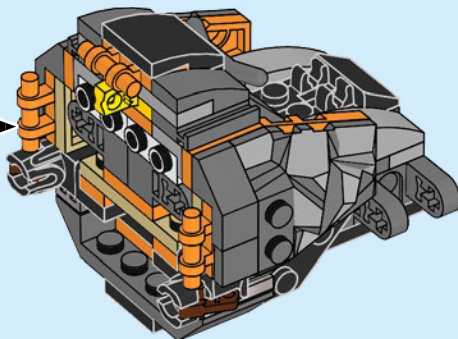



1x



2x

38

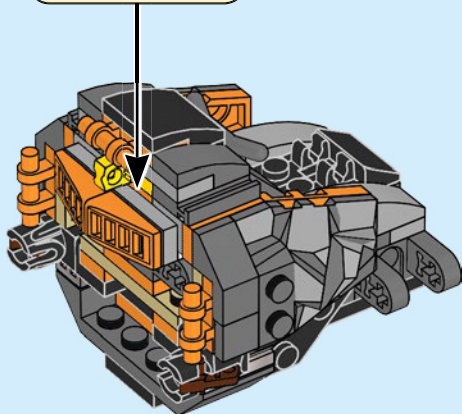
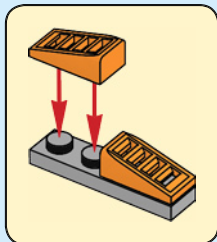

1x



1x

39

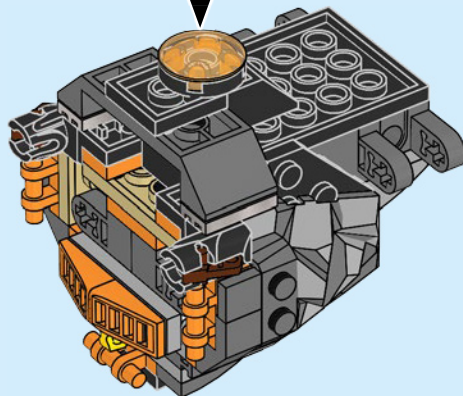
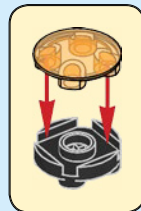

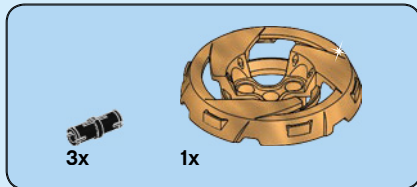
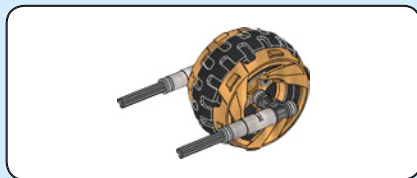
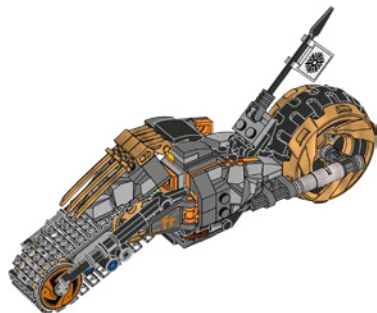
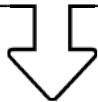
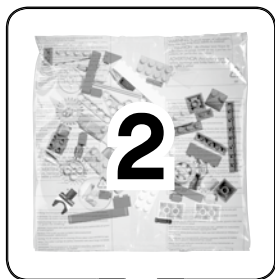

40

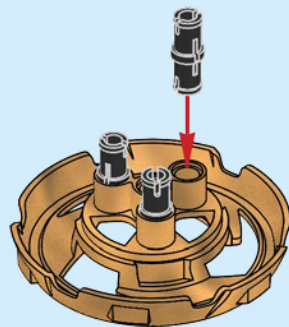

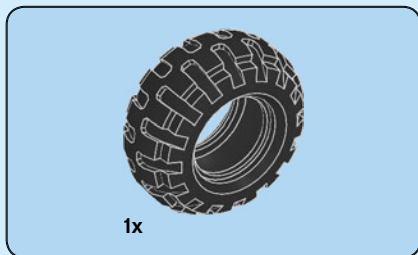

41

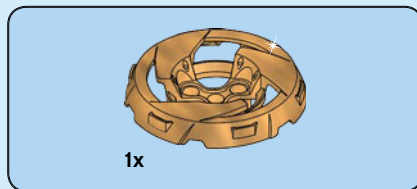
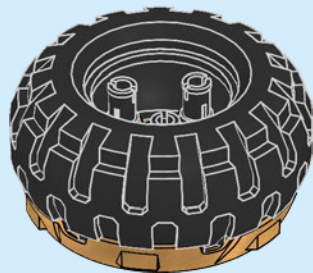

42

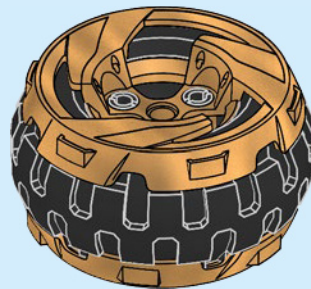

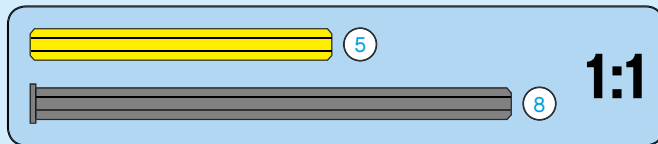
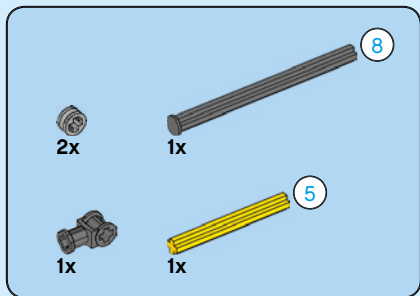

43

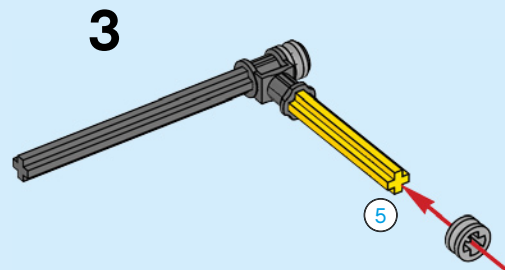
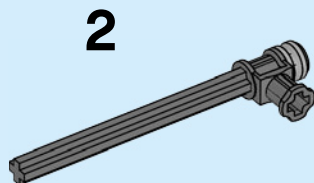
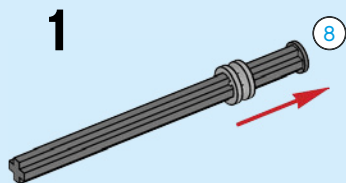

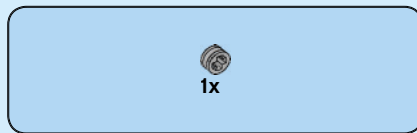
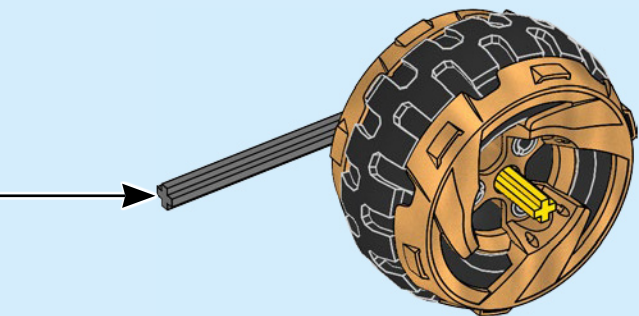

44

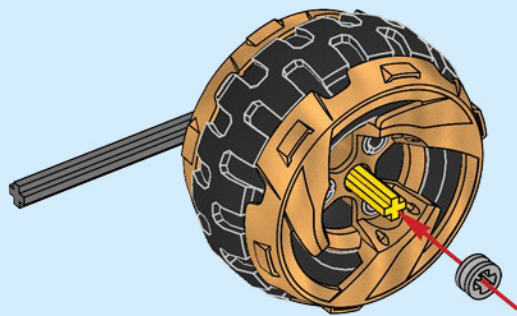

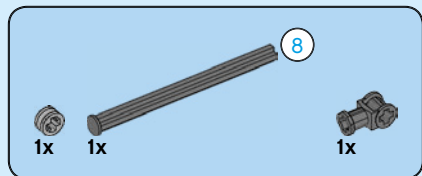

45

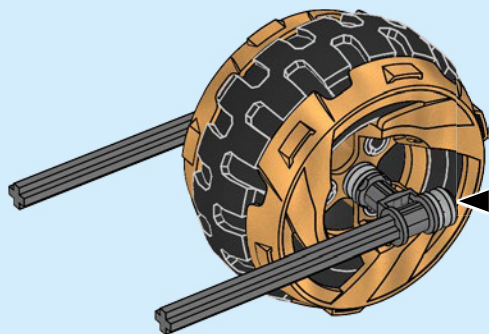
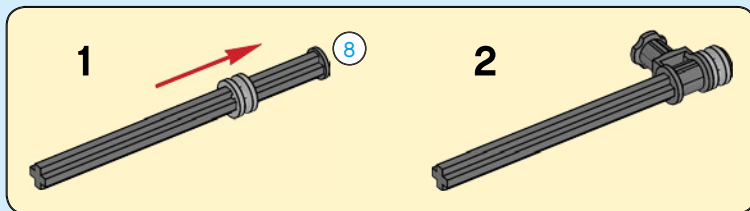
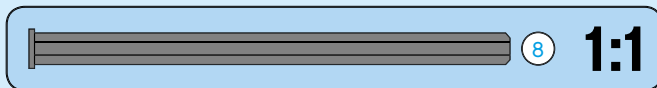





2x



2x



2x

# 46

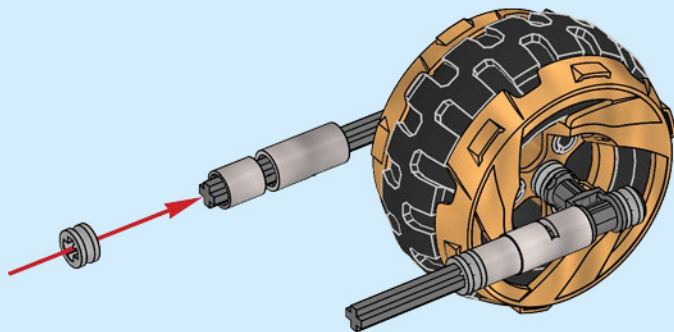

47

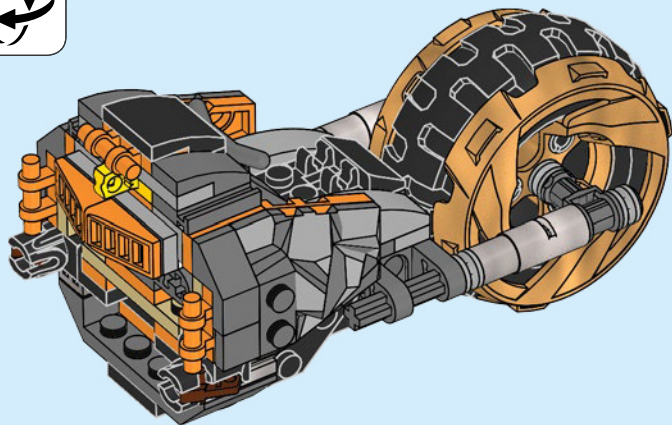

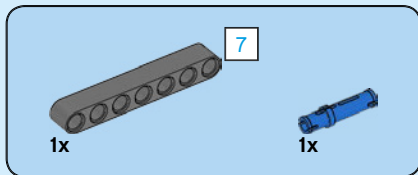
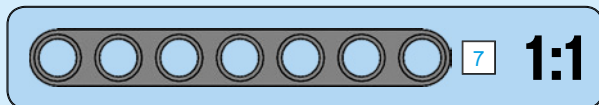
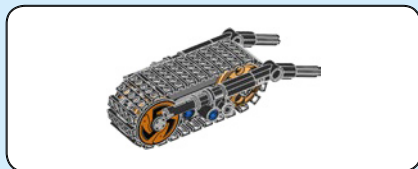

48

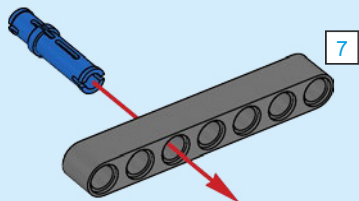

49

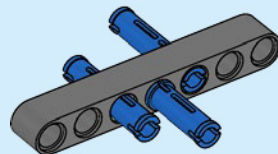



2x

50

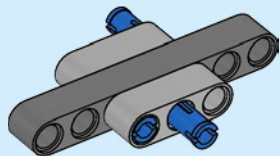

36



2x

51

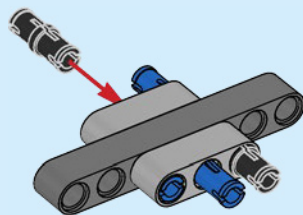

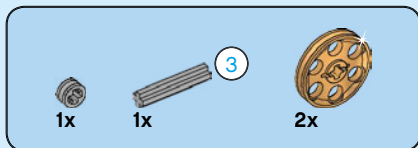

52

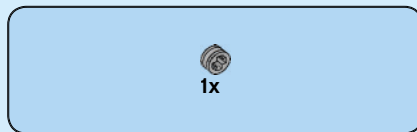
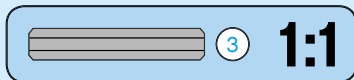
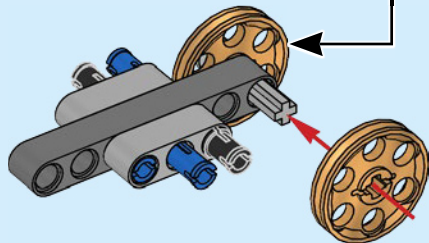
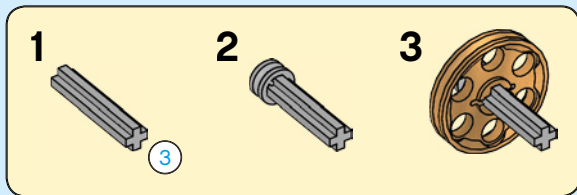

53

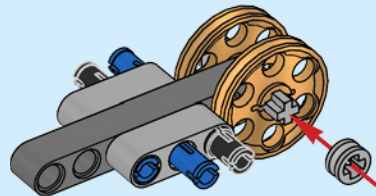

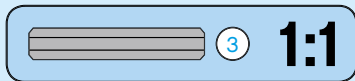
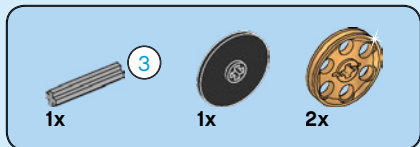

54

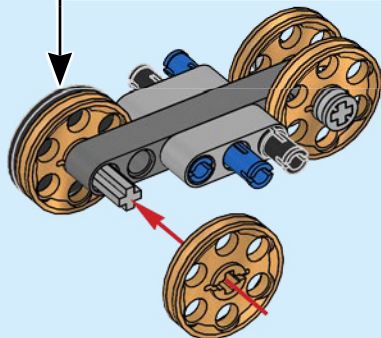
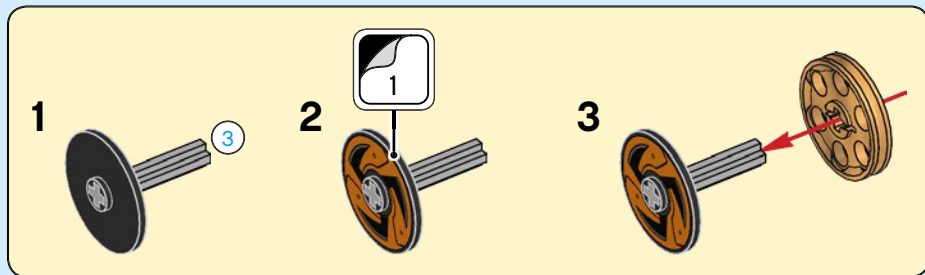



55

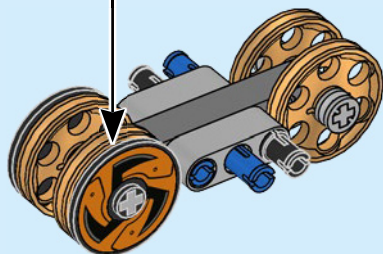

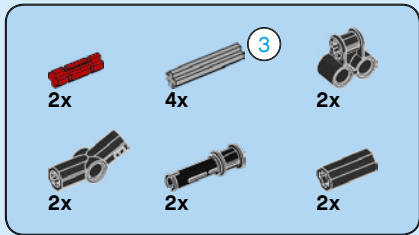
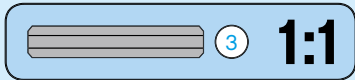

56

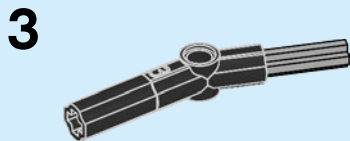
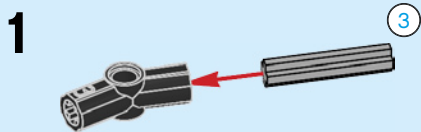



4

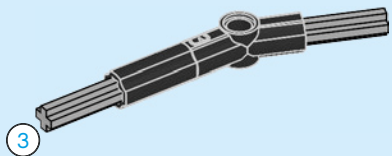

5

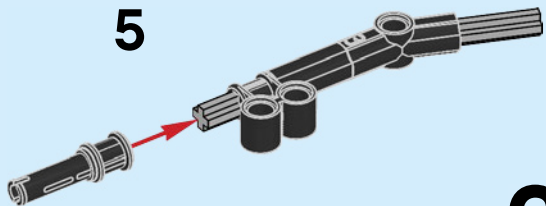

2x

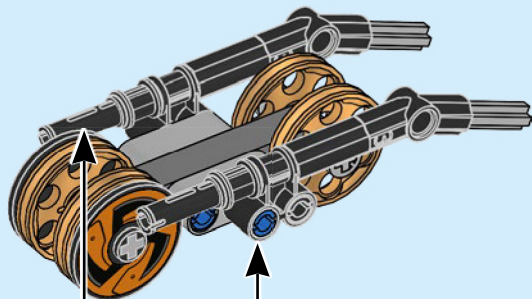



57

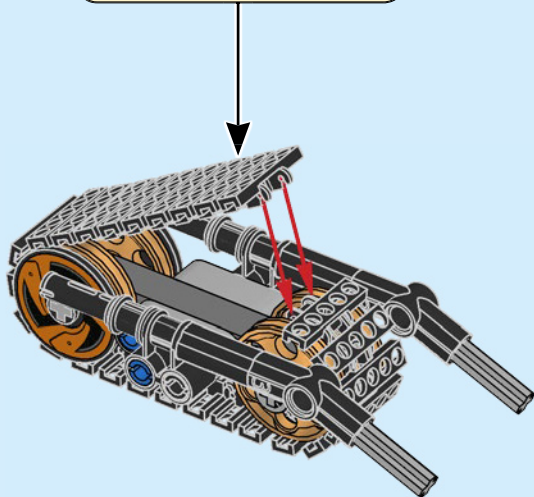
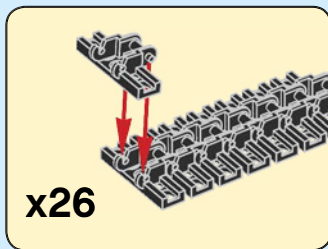

58

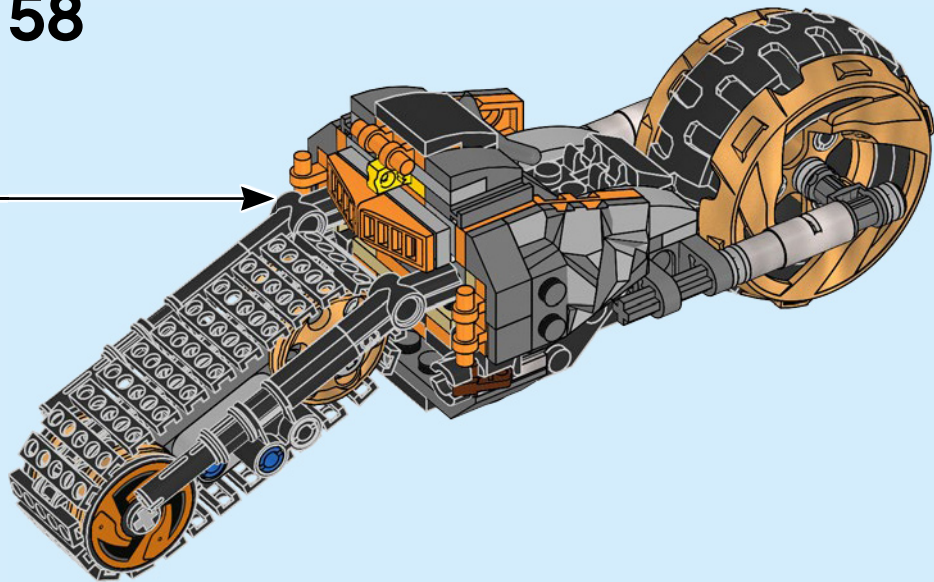



2x

59

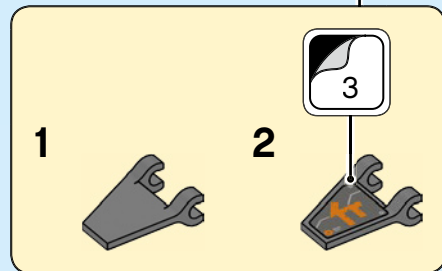
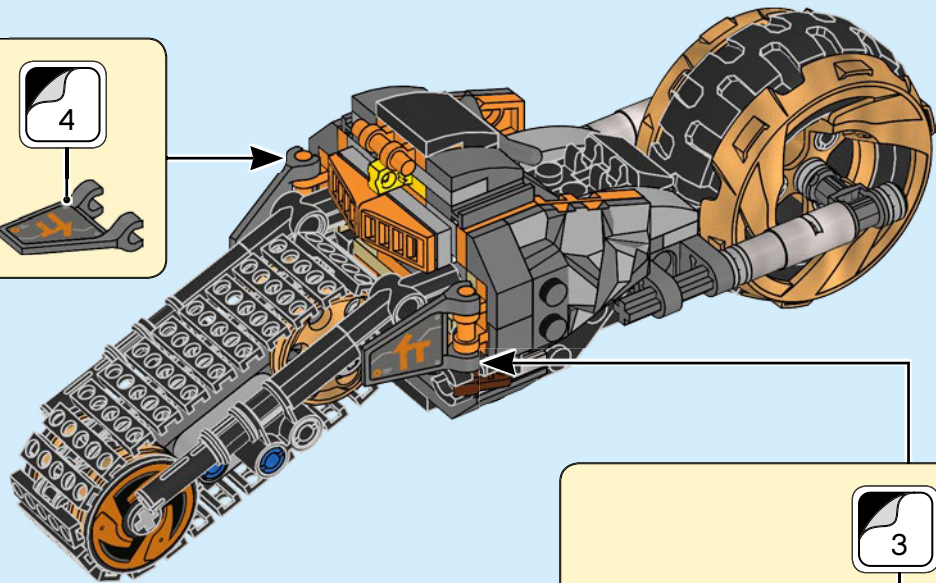
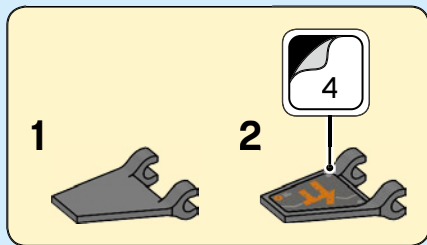

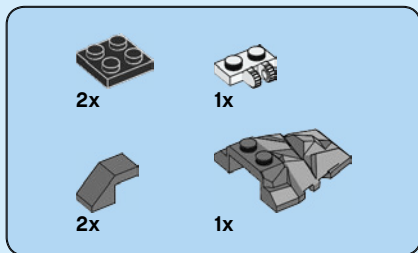

60

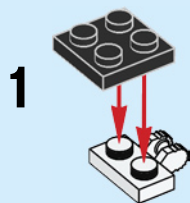

2

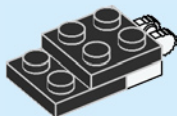

3

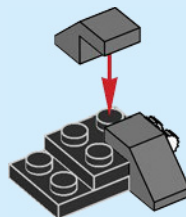

4

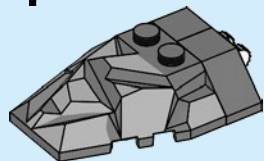

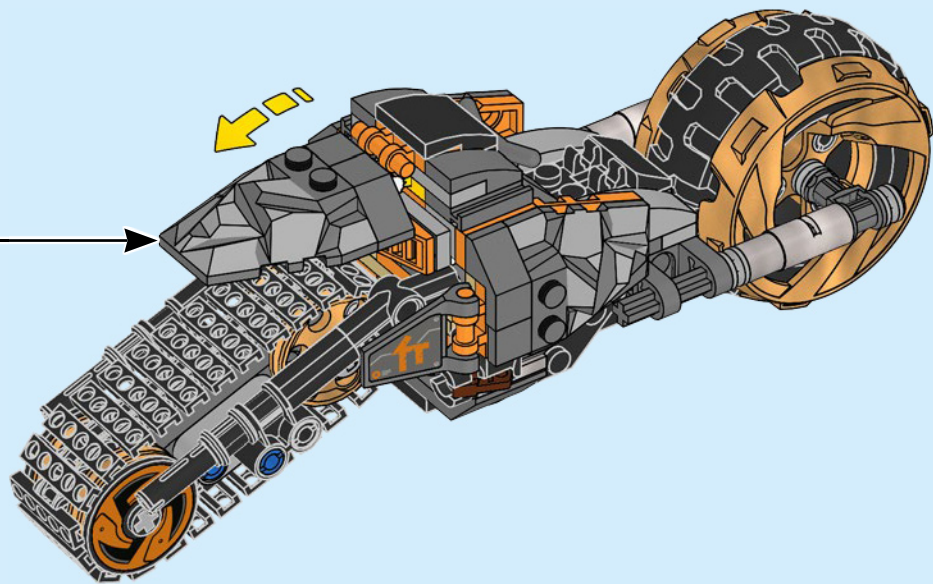



3x



3x

# 61

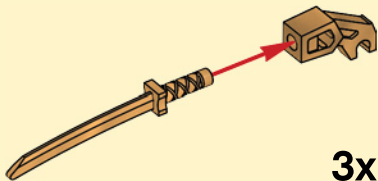

3x

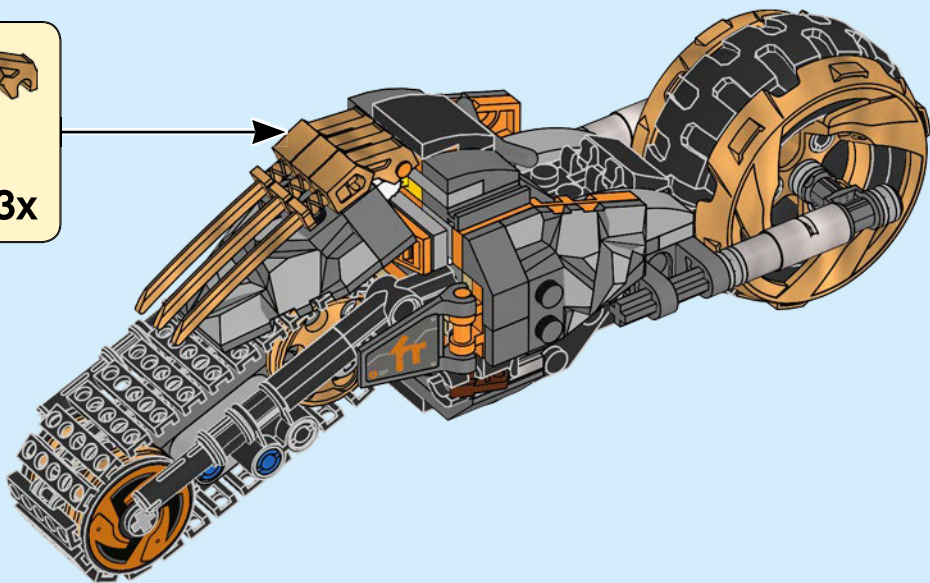

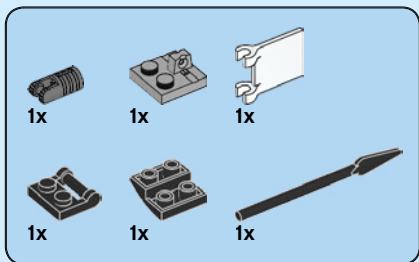

62

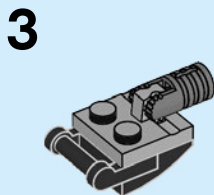
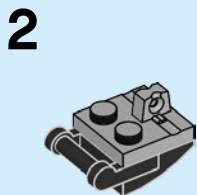
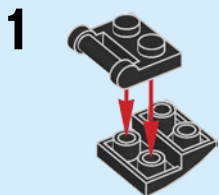



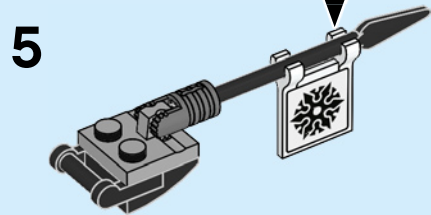
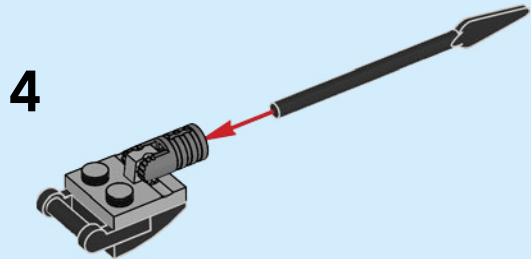
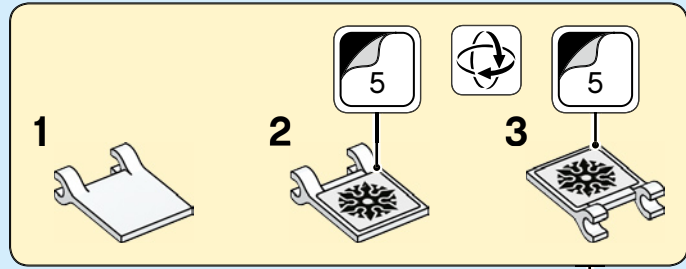

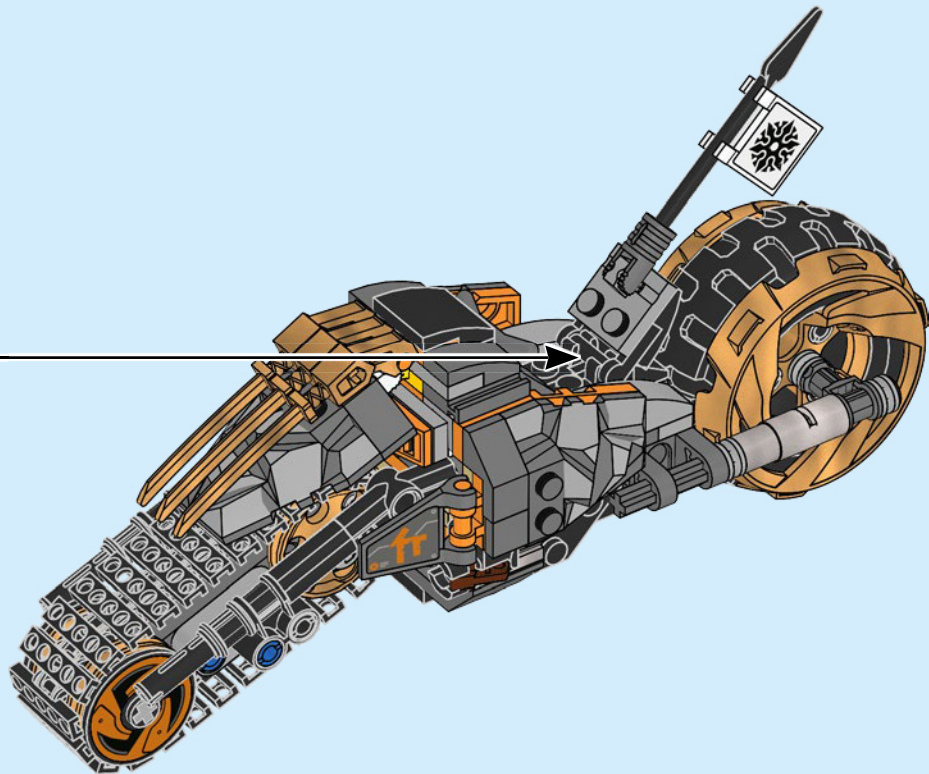



4x

63



2x

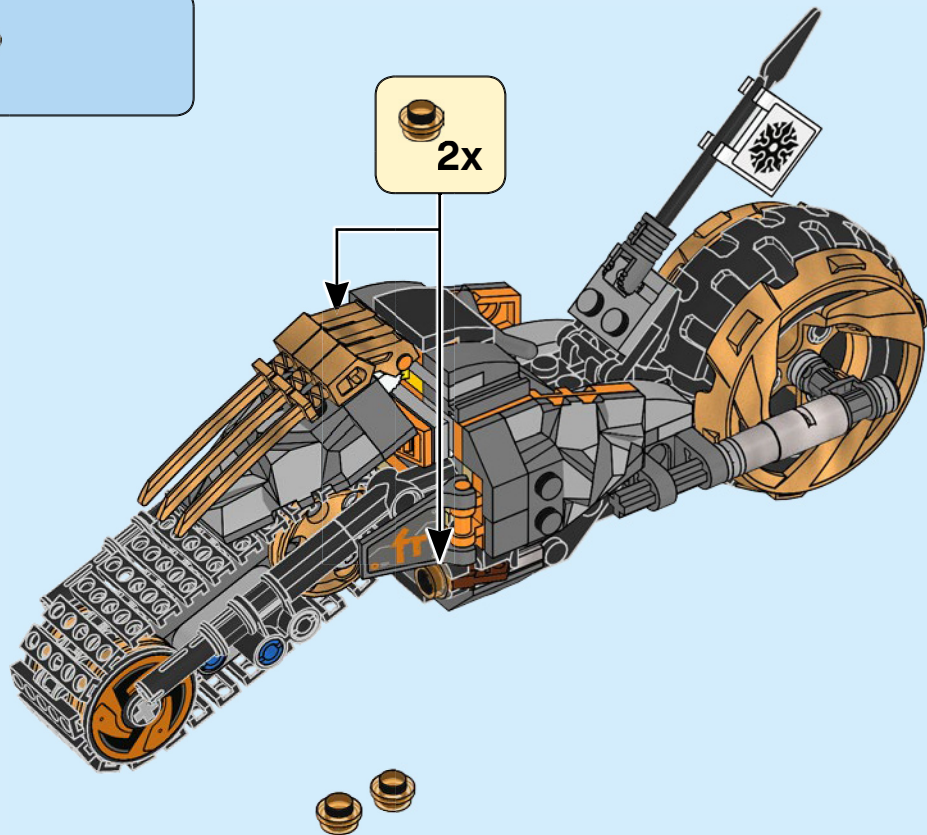

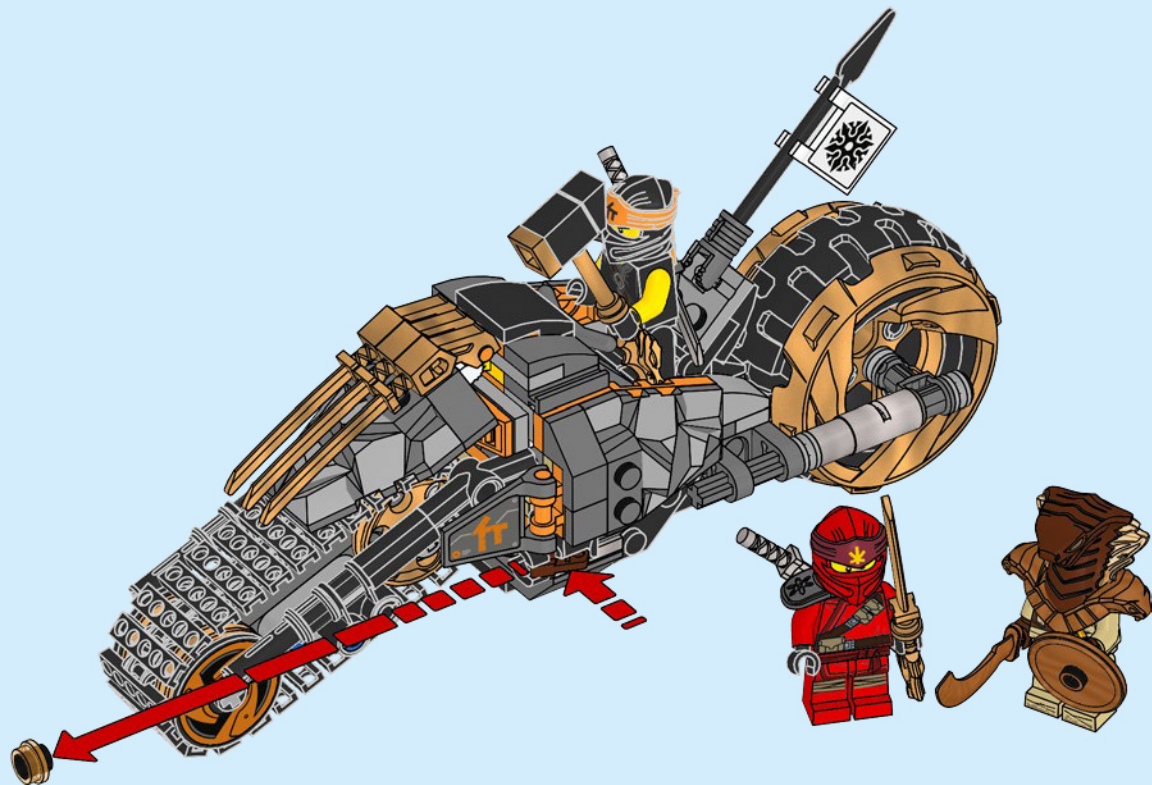





1x  
4515337



1x  
6011794



2x  
6046979



2x  
362301



1x  
6268098



1x  
6177314



2x  
4118790



1x  
4243824



1x  
6267099



2x  
4142865



1x  
6267150



4x  
302321



1x  
6192016



1x  
6190411



1x  
4185617



1x  
6130008



1x  
6267585



26x  
6047885



1x  
4548180



1x  
403226



5x  
4121715



2x  
4140430



1x  
6267583



2x  
4512363



2x  
4598528



2x  
300426



1x  
4558954



1x  
4504382



1x  
4225201



3x  
302226



1x  
6211476



1x  
366026



1x  
6053077



2x  
4140801



2x  
6261386



4x  
6020193



2x  
4218868



2x  
6102734



2x  
4227684



1x  
449726



1x  
4297209



1x  
303226



1x  
6267106



1x  
6267581



1x  
6263977



1x  
4271949



1x  
6268089



2x  
6114374



3x  
4514553



1x  
4180512



1x  
4180540



4x  
4177932



2x  
6167615



3x  
4190164



3x  
4118782



4x  
6240227



1x  
6171727

5

2x  
4210848

1x  
4210695

2x  
6184977

4x  
6168776

2x  
6069164

2x  
6029948

2x  
4211135

2x  
4215387

2x  
4543086

1x  
4261908

4x  
4547958

2x  
6099909

3x  
6268373

1x  
4211002

1x  
6182451

1x  
4495931

2x  
4499858

2x  
6224825

1x  
6069887

3x  
6006741

1x  
6093529

4x  
6257902

3x  
6116596

2x  
6264181

1x  
6238704

8x  
4211573

4x  
4654582

1x  
4666449

6x  
4211815

2x  
4211655

2x  
4251163

3x  
4211445

2x  
6161155

2x  
6245499

2x  
4619636

2x  
6116593

2x  
6267464

1x  
6262186

1x  
6267181

1x  
6264135

3

7

8



Customer Service

Kundenservice

Service Consommateurs

Servicio Al Consumidor

LEGO.com/service or dial



: 00800 5346 5555

: 1-800-422-5346

# WIN

GO TO [WWW.LEGO.COM/PRODUCTFEEDBACK](http://WWW.LEGO.COM/PRODUCTFEEDBACK) AND  
GIVE US YOUR SHORT **FEEDBACK** ABOUT THIS  
LEGO® SET FOR A CHANCE TO WIN  
A COOL LEGO PRIZE.

Terms & Conditions apply



## LEGO.com/productfeedback

### GEWINNE

Erzähle uns auf  
[www.LEGO.com/productfeedback](http://www.LEGO.com/productfeedback)

etwas über die Erfahrungen, die du mit  
diesem LEGO® Set gemacht hast, und  
sichere dir die Chance auf einen coolen  
LEGO Preis!

Es gelten die Teilnahmebedingungen

### GAGNE

Rends-toi sur  
[www.LEGO.com/productfeedback](http://www.LEGO.com/productfeedback)

et donne-nous quelques commentaires sur  
ce produit LEGO® pour avoir une chance  
de gagner un prix LEGO !

Voir Conditions Générales

### GANAN

Visita  
[www.LEGO.com/productfeedback](http://www.LEGO.com/productfeedback)

y envíanos tu opinión acerca de este set  
LEGO®. ¡Participarás en el sorteo de un  
premio LEGO!

Términos y Condiciones aplicables

### 获取奖品

登录  
[www.LEGO.com/productfeedback](http://www.LEGO.com/productfeedback)

给出关于此乐高®套装的简短反馈，  
就有机会获得炫酷乐高奖品

《条款及条件》适用

LEGO, the LEGO logo, NINJAGO and the NINJAGO logo are trademarks of the/sont des marques de commerce du/son marcas registradas de LEGO Group. ©2019 The LEGO Group.

6282608/6282614