



BIONICLE®

70795



LEGO.com/bionicle



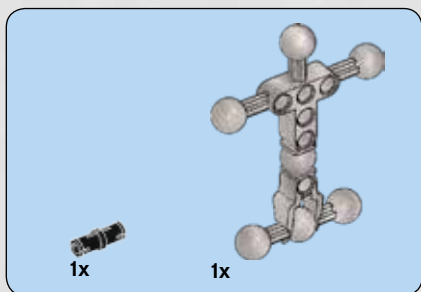

1

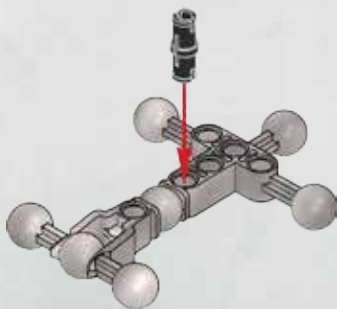

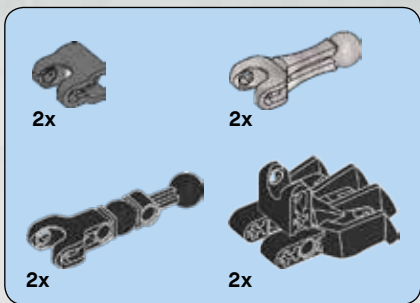

2

1



2

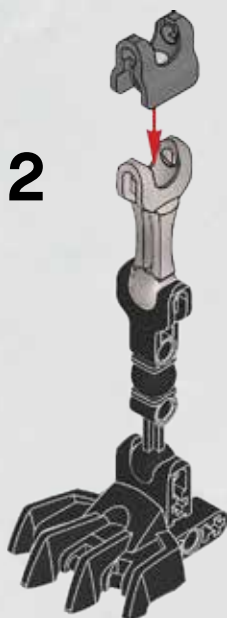

2x

3

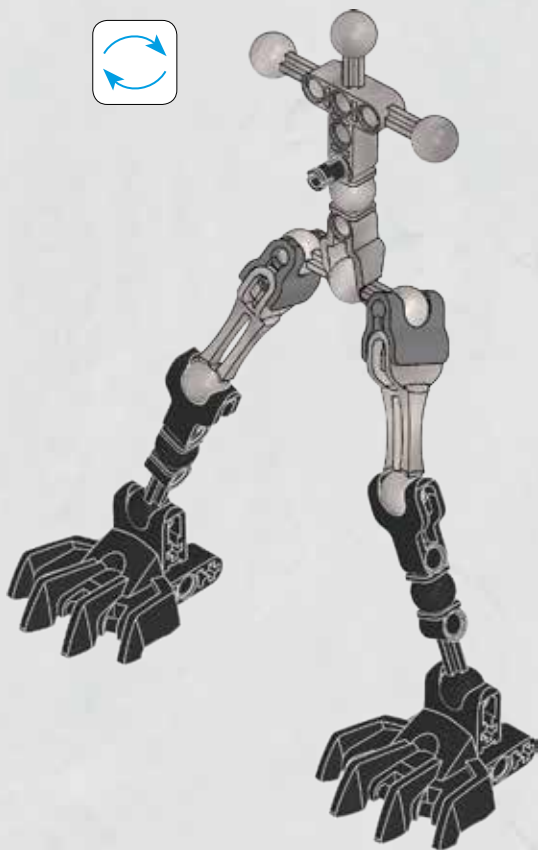



4

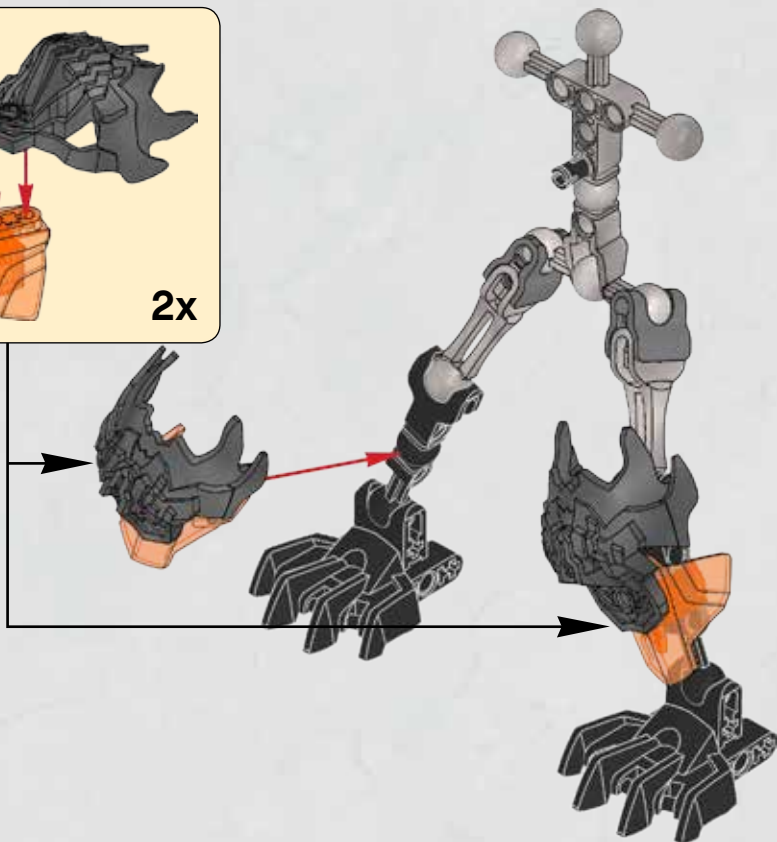
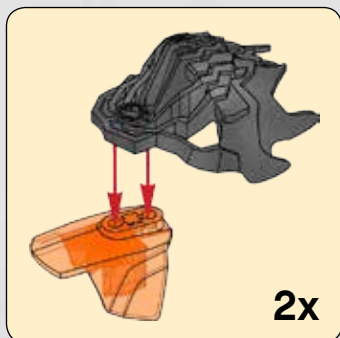

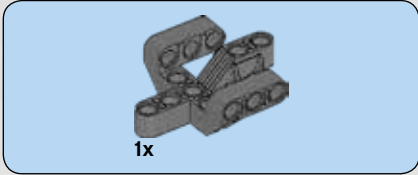
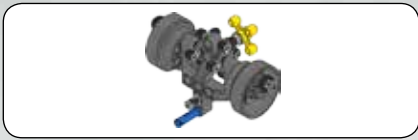

5

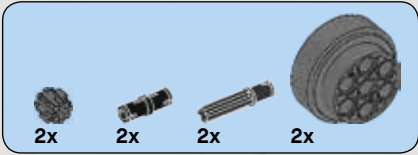
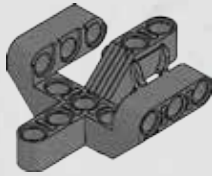

6

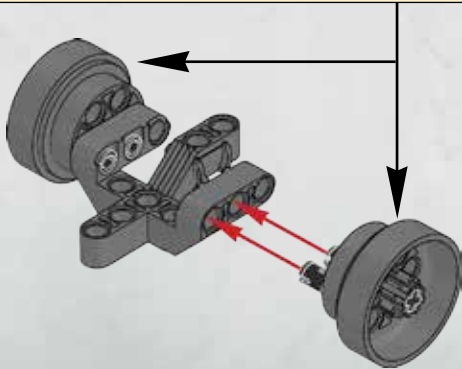
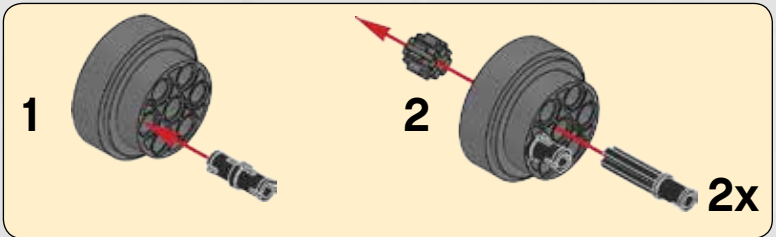

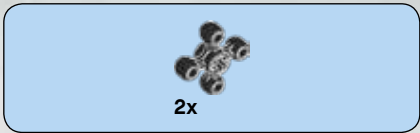

7

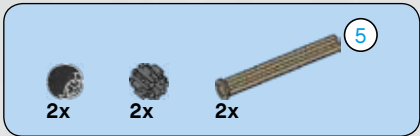
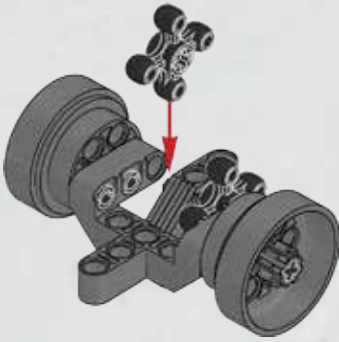

8

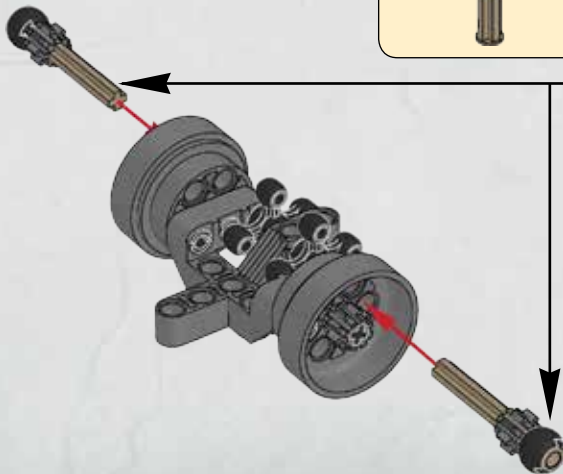
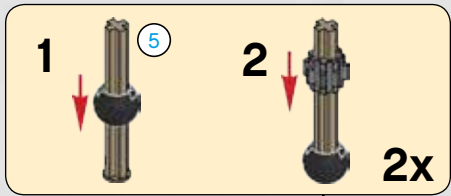

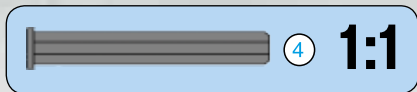
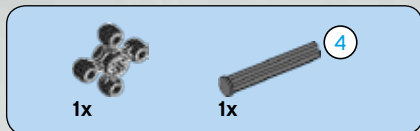

9

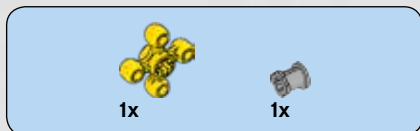
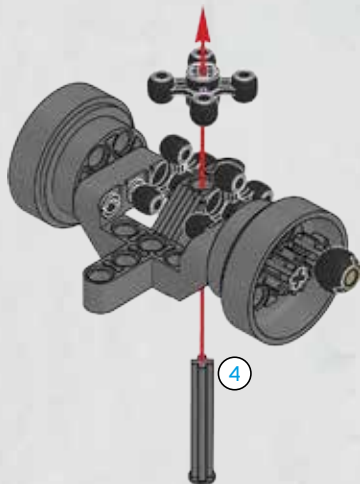

10

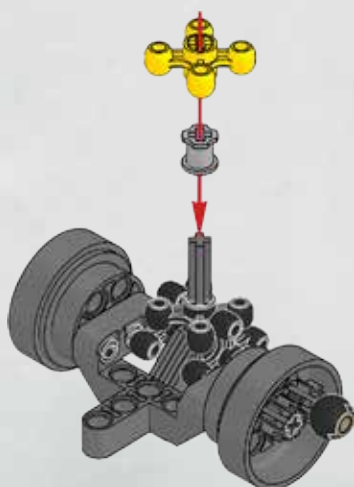



1x



1x

11

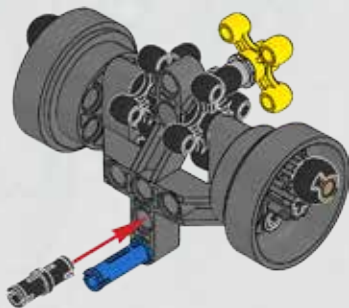

12





1x

13

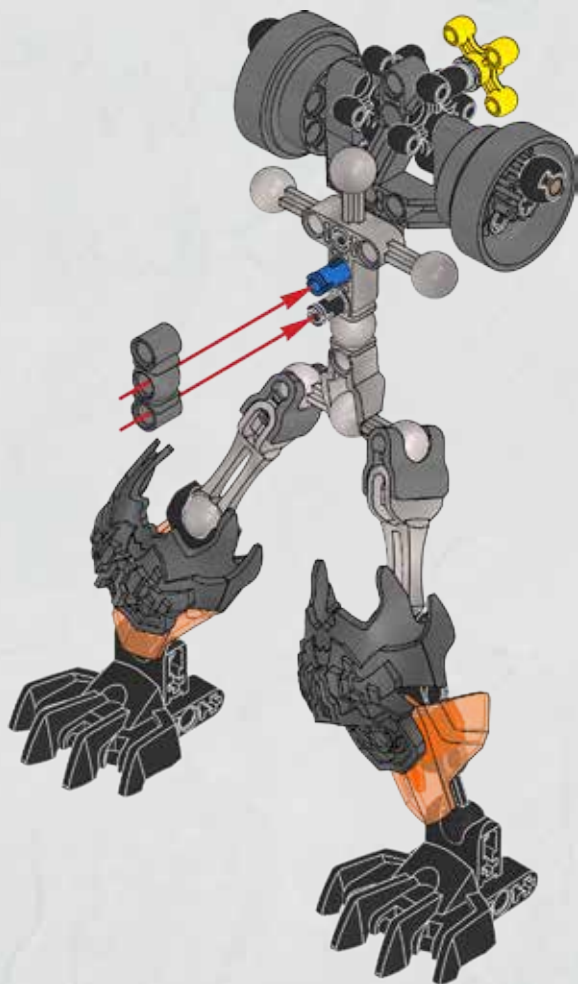



1x

14



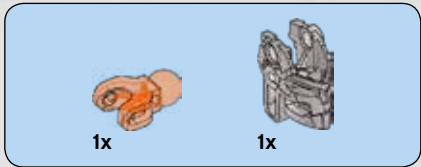

15

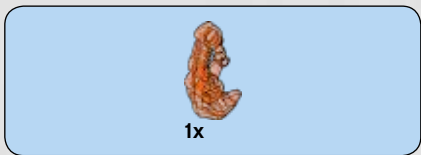
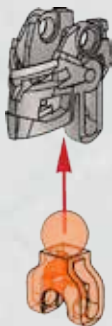

16

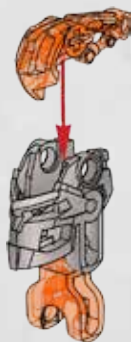

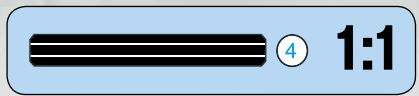
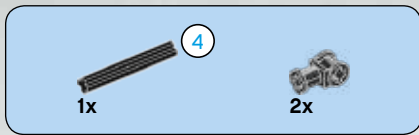

17

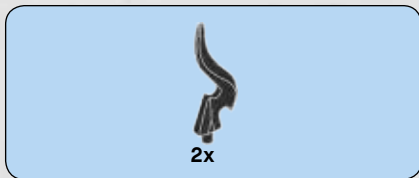
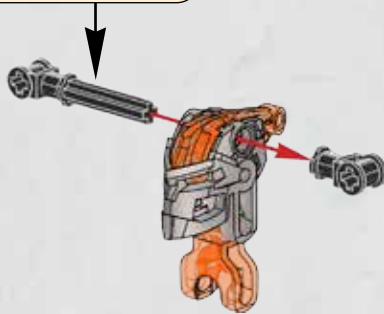
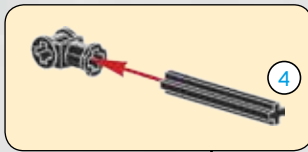

18

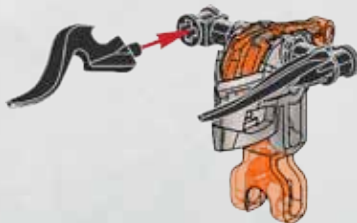

19

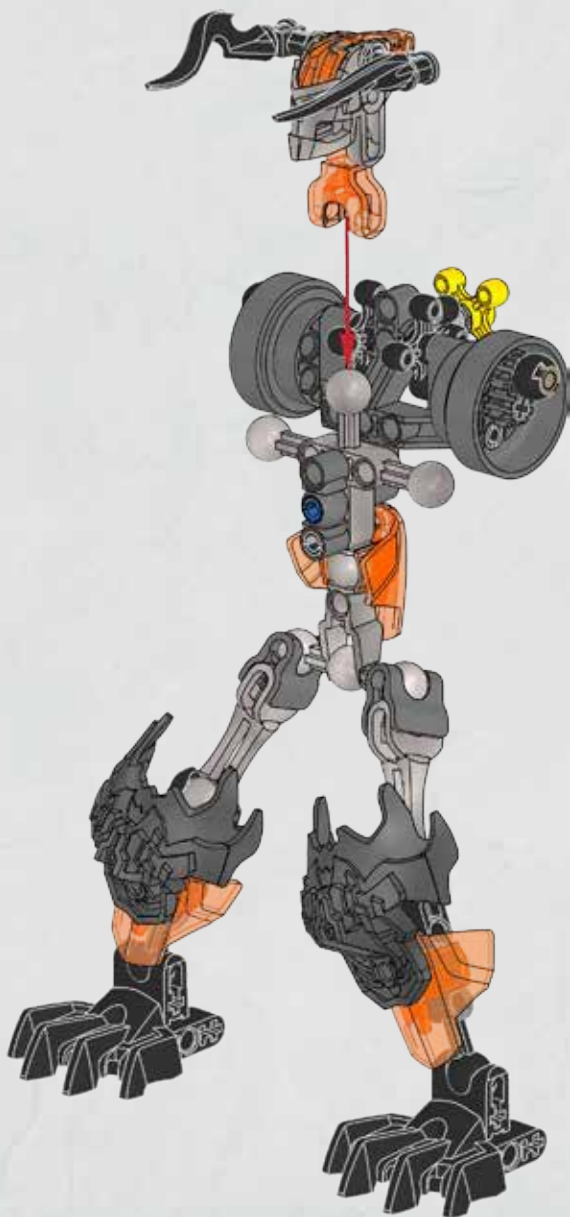

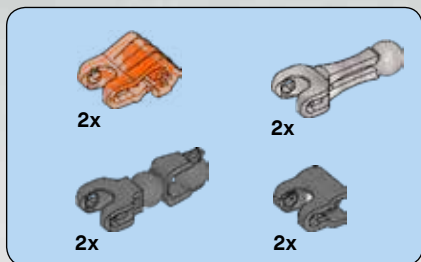

20

1

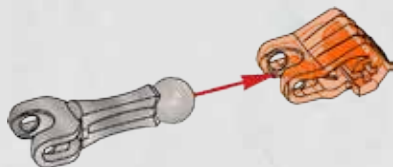

2

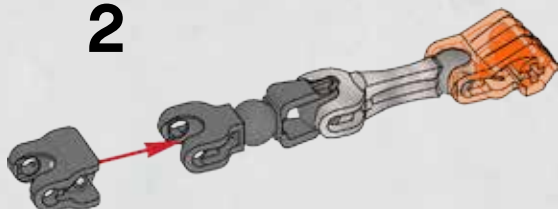

2x

21



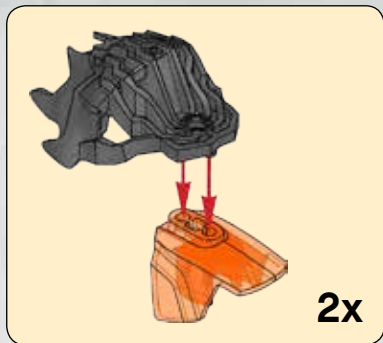
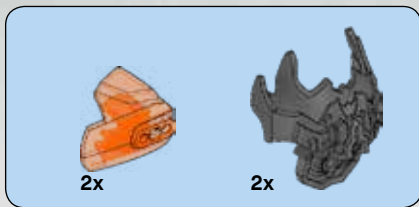

22



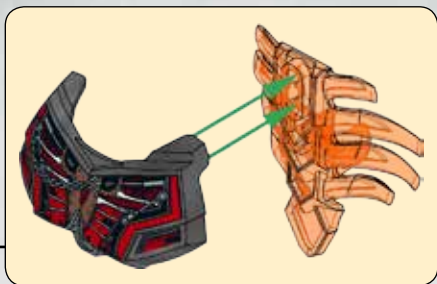

23

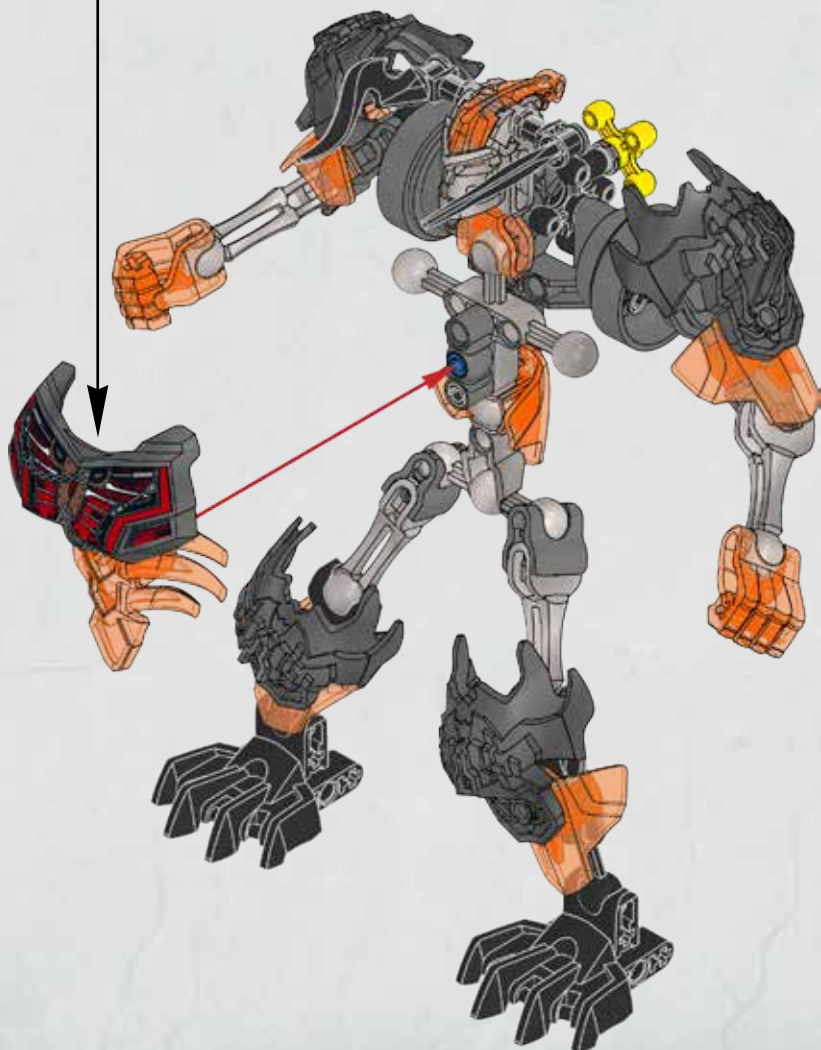

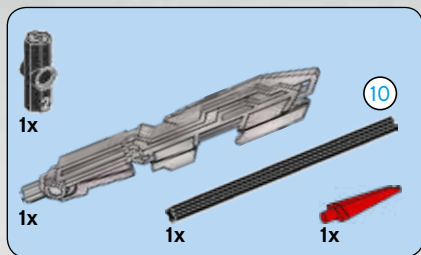

24

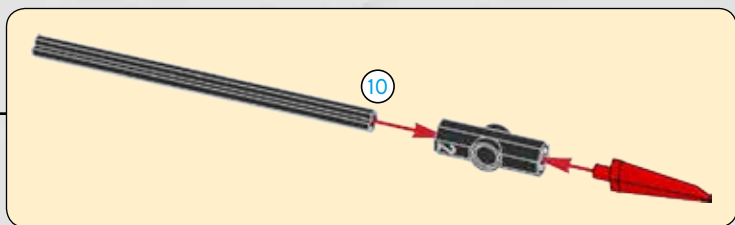
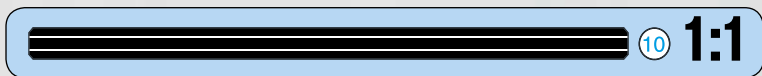



1x



1x

25

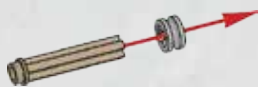

1x



1x

26

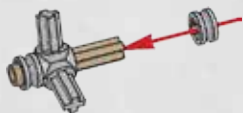

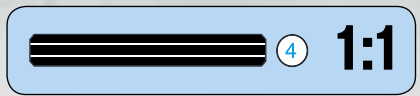
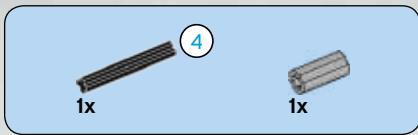

27

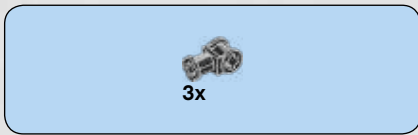
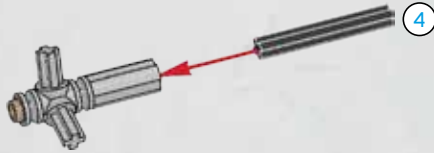

28

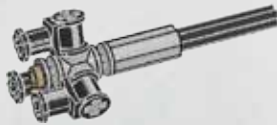

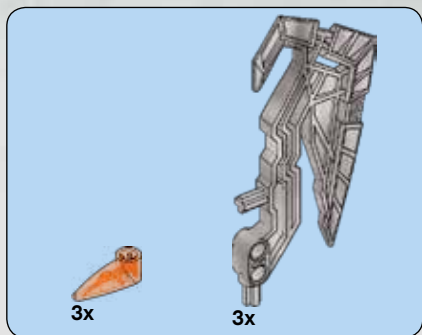

29

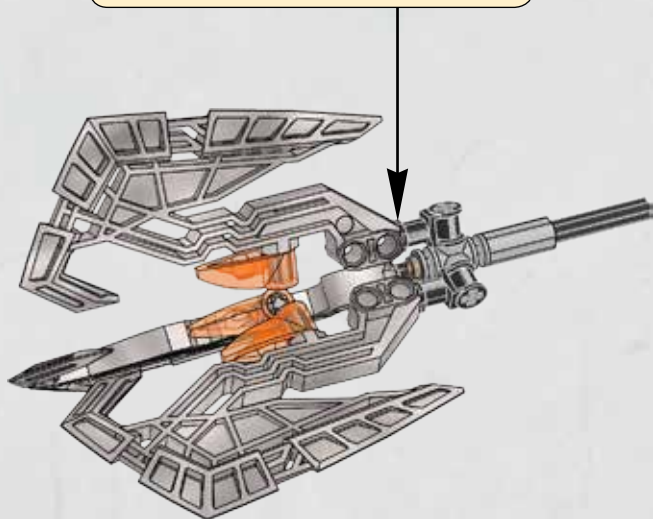
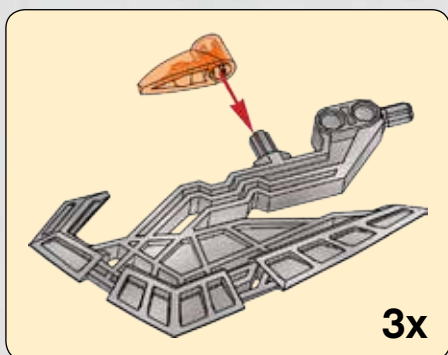



1x

30



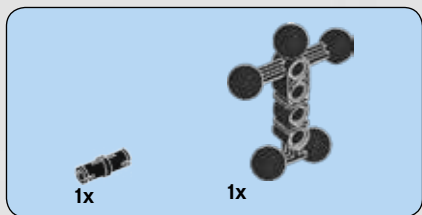

1

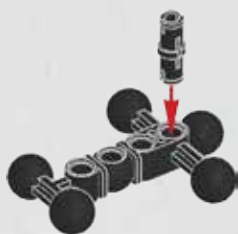

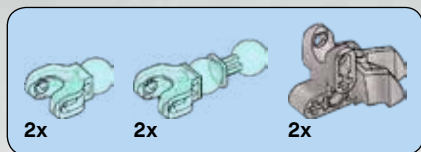

2

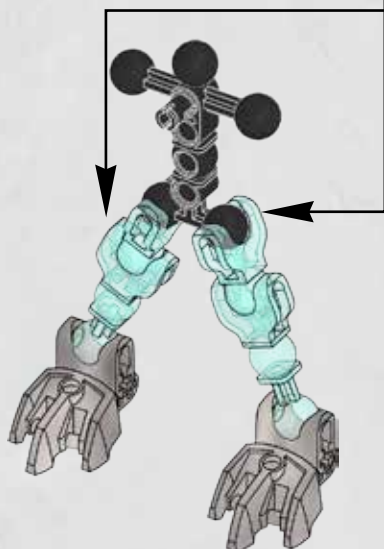
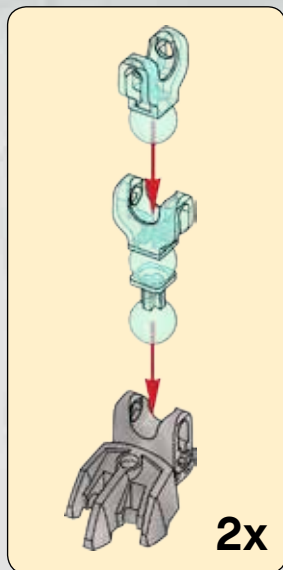



2x

3

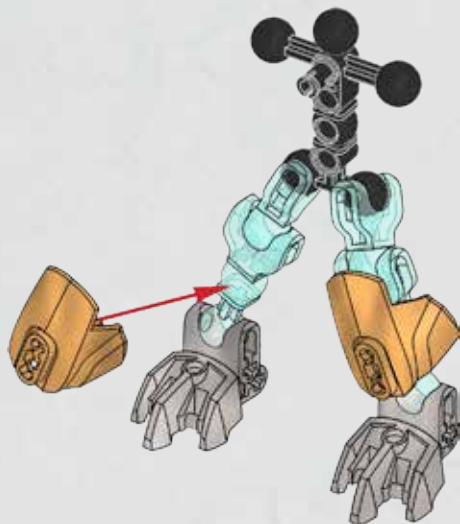

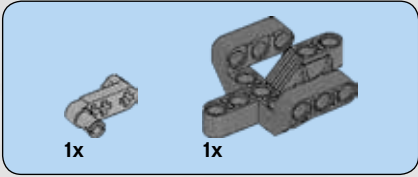
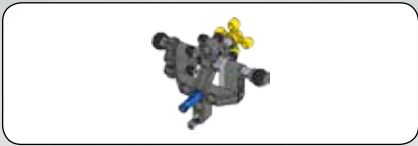

4

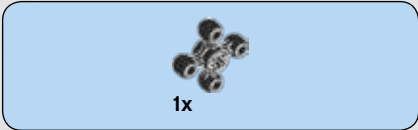
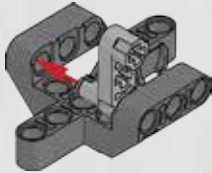

5





6

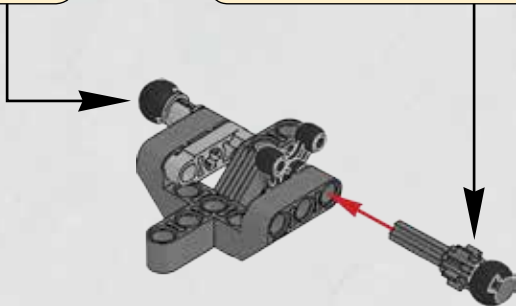
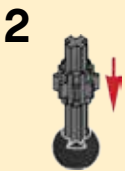
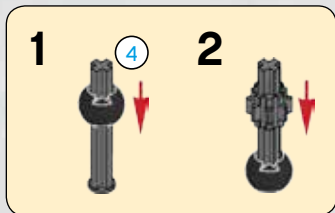
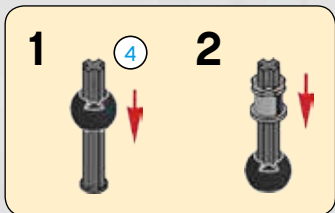



7

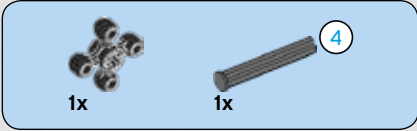
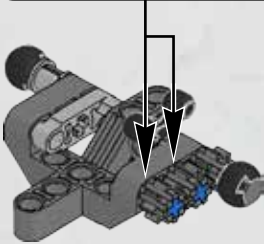
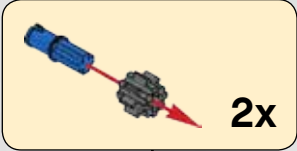

8

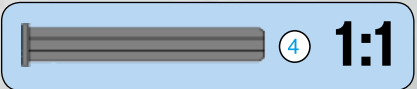
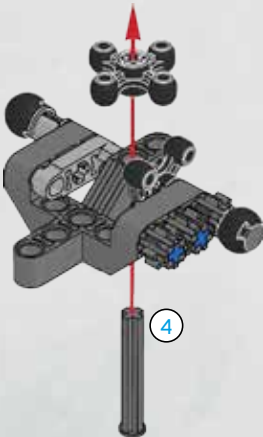



1x



1x

9

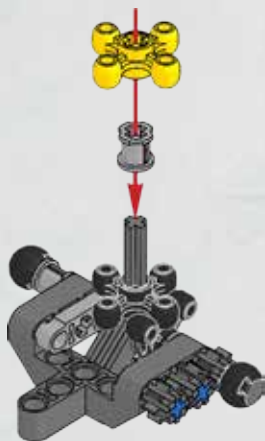

1x



1x

10

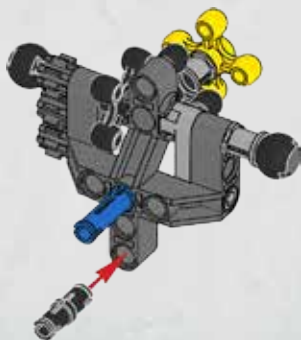

11

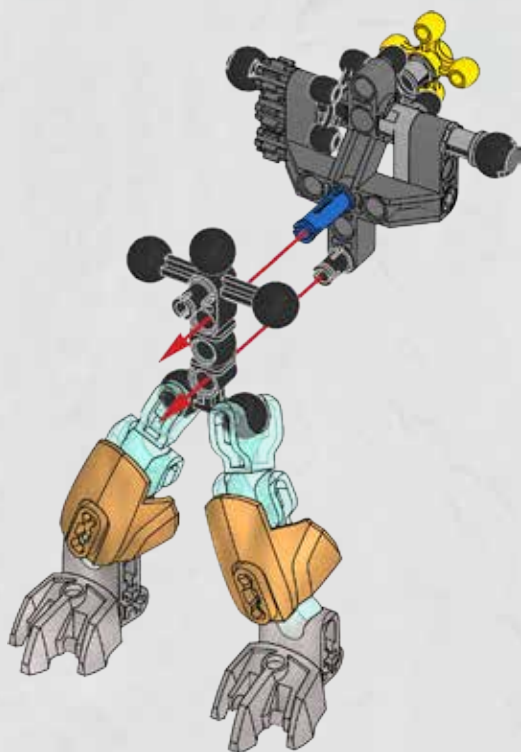



1x

12

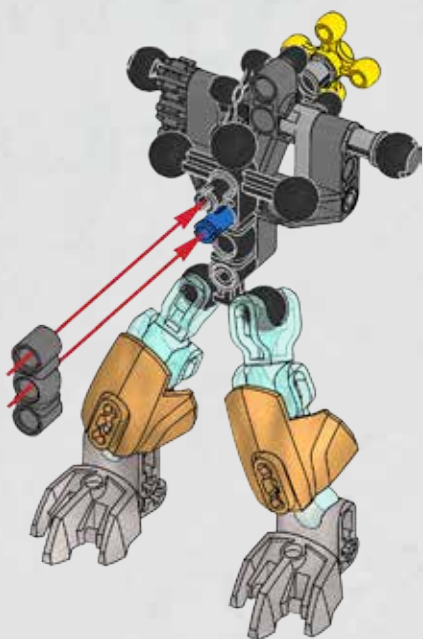



2x

13

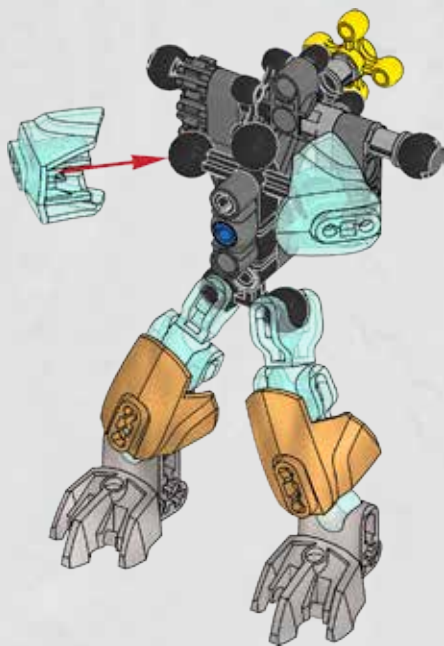

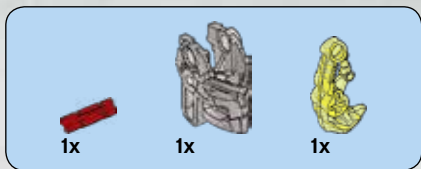

14

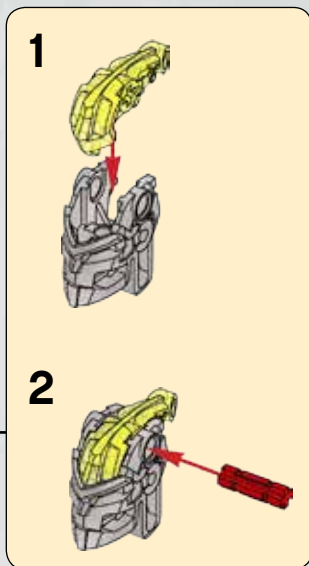
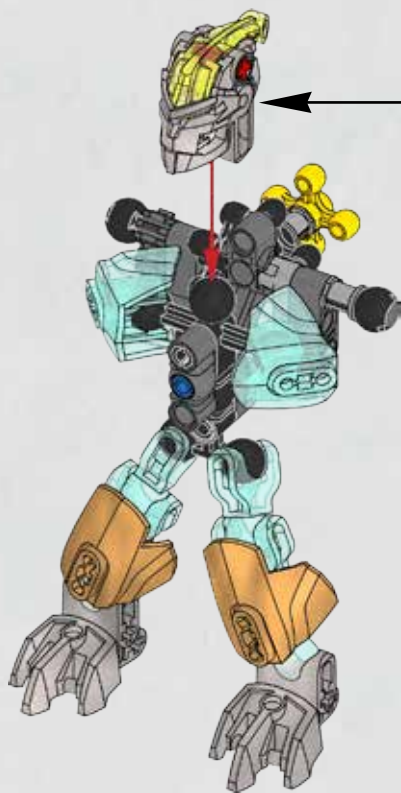

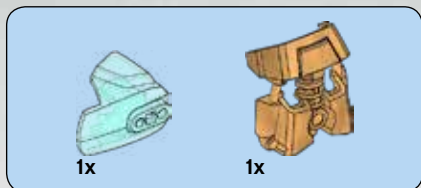

15

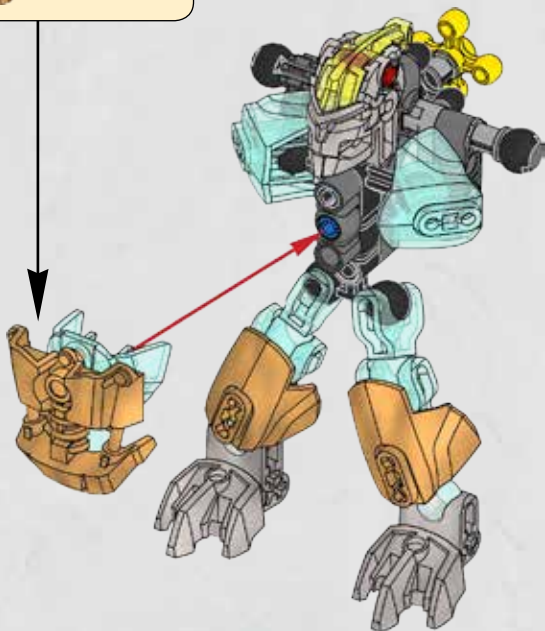
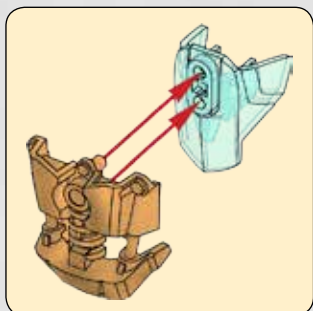



2x



2x

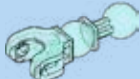

2x

16

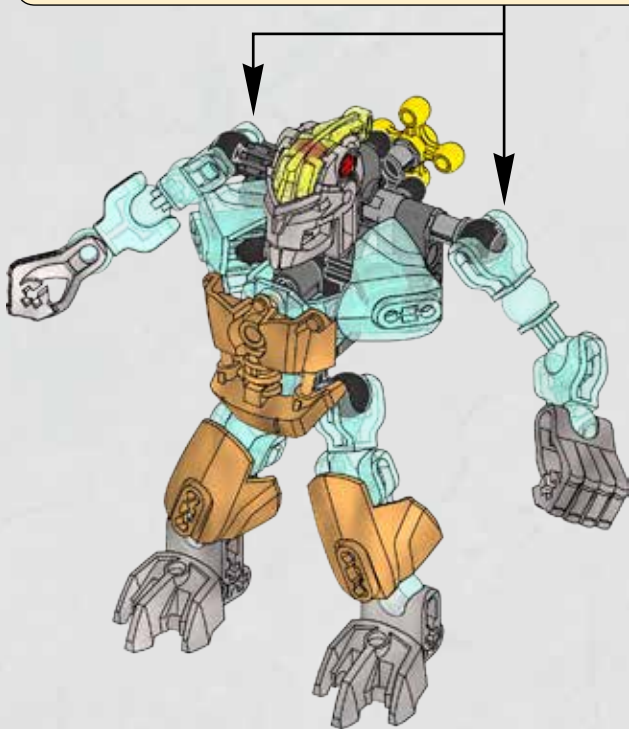
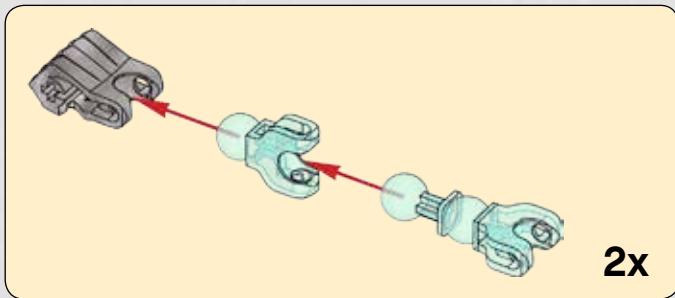

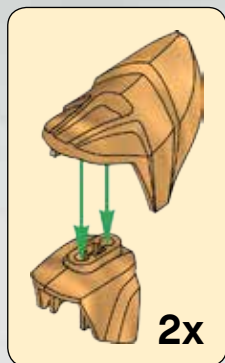
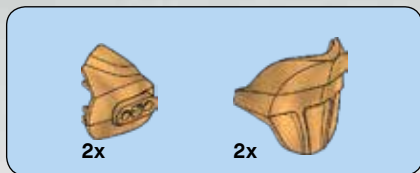

17

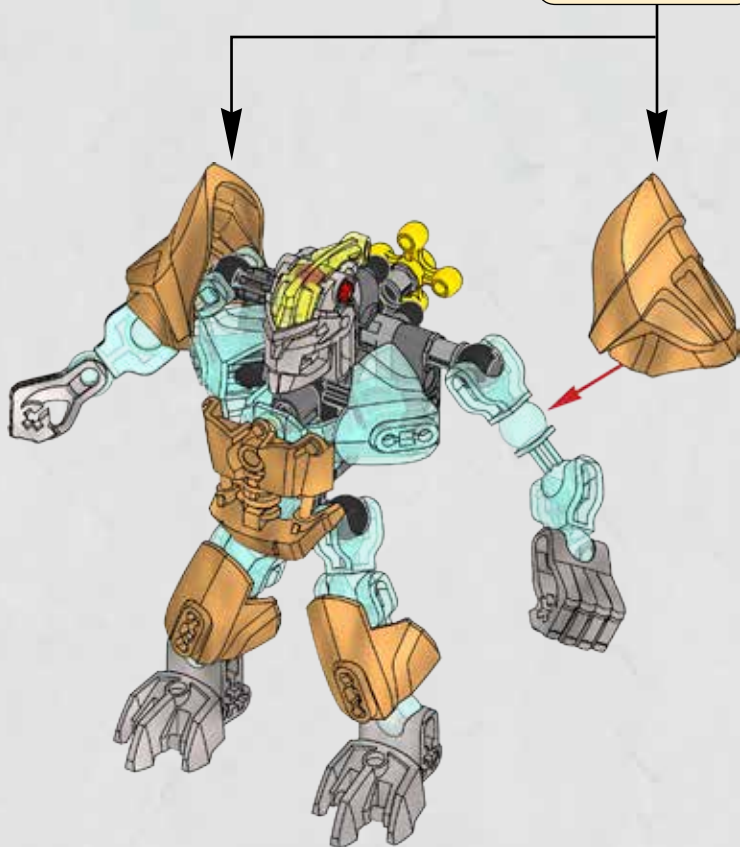

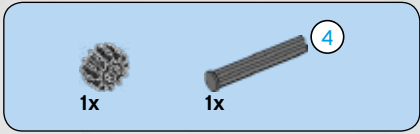

18



19





1x



1x

20



1x



1x

21



22



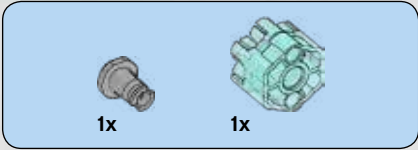

23

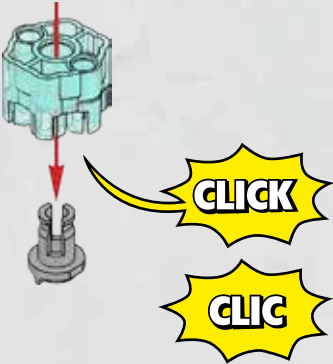

24



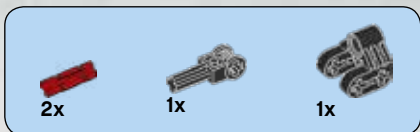

25

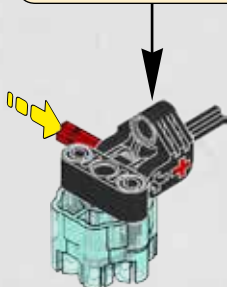
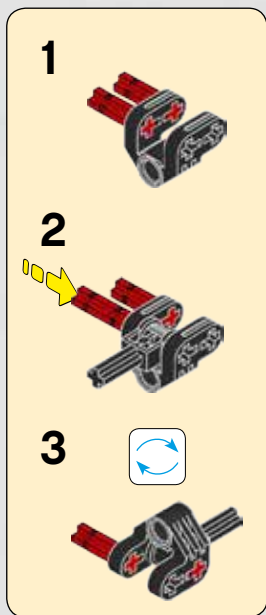

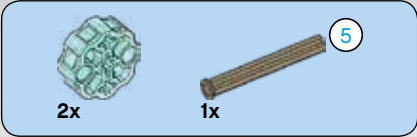

26

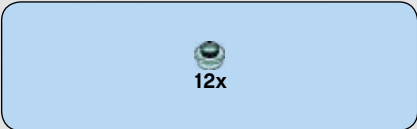
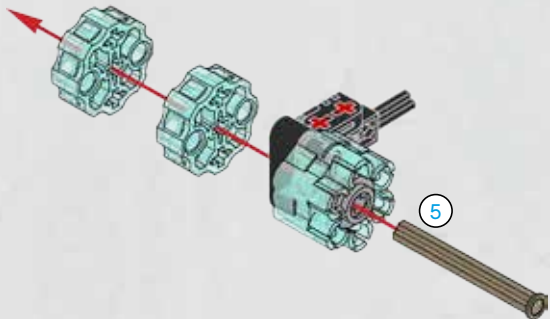

27

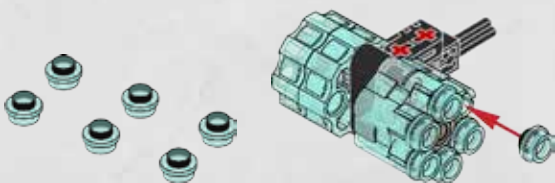
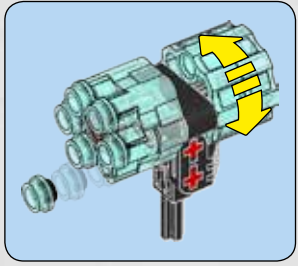

28

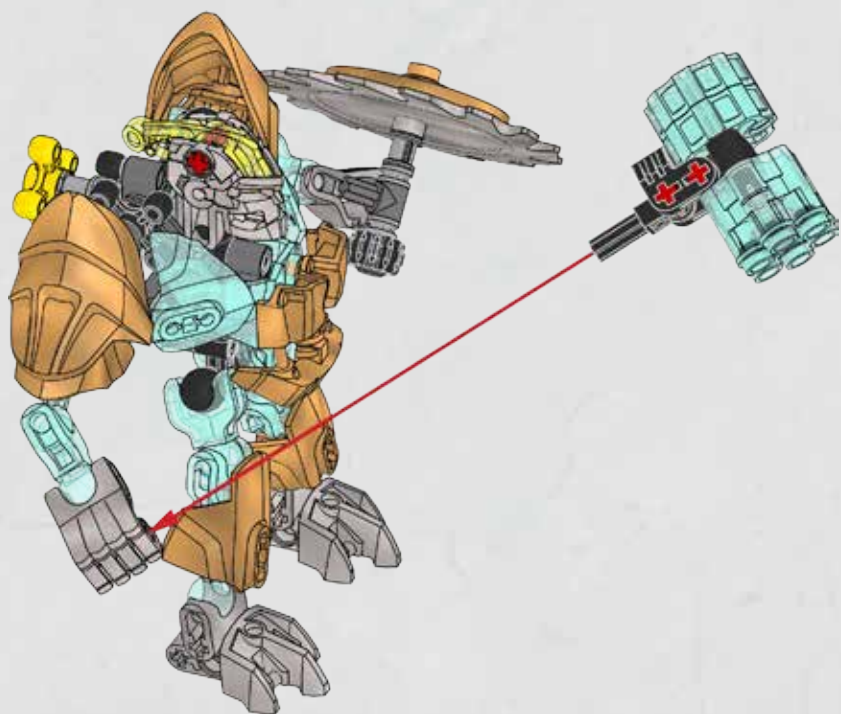

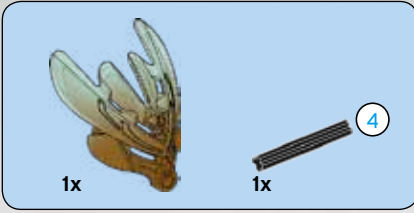

29

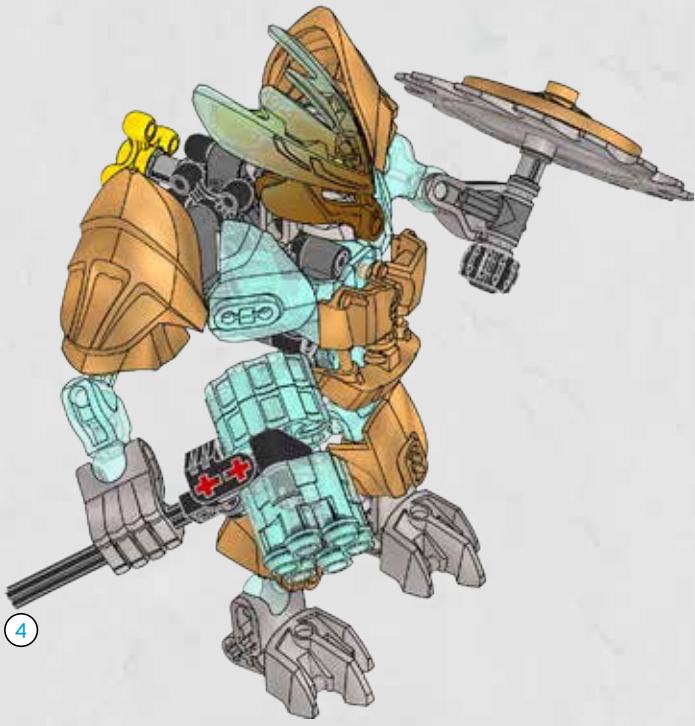

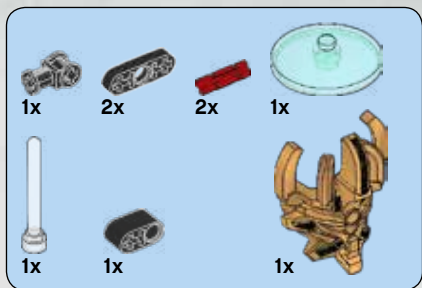

30

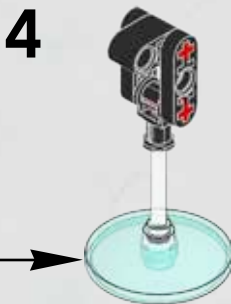
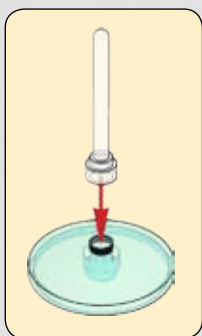

31



- 1x 4616842
- 5x 4142865
- 2x 4206482
- 2x 4514553
- 2x 4203493
- 2x 6114248
- 1x 6006140
- 1x 6007966
- 4x 4286267
- 2x 4107828
- 1x 4610371
- 1x 4667277
- 2x 4593553
- 2x 6056379
- 8x 4121715
- 1x 4107783
- 6x 4107081
- 2x 6089119
- 1x 4107765
- 3x 370526
- 1x 373726
- 1x 4177431
- 5x 4248204
- 1x 4656652

- 12x 4163917
- 2x 4654432
- 4x 6043677
- 4x 6043679
- 2x 6029234
- 1x 6029235
- 1x 6100096
- 1x 4293877
- 1x 6102640
- 5x 6076486
- 1x 6114324
- 2x 6046528

- 1x 6046498
- 3x 6111281
- 1x 6102639
- 1x 6031821
- 3x 6055631
- 1x 4563045
- 4x 4211573
- 3x 4211622
- 1x 6115685
- 1x 4512360
- 1x 4502595
- 1x 4211865
- 1x 6097090
- 2x 6102645
- 4x 6106472
- 2x 6001085

- 2x 4622903
- 1x 6005331
- 5x 6083620
- 7x 6012451
- 2x 4549886
- 1x 6058138
- 1x 6115790
- 2x 4624197
- 2x 6092885
- 1x 6102792
- 2x 6075042
- 1x 6115891

- 2x 4619077
- 2x 6100892
- 2x 6102606
- 3x 6114372
- 4x 6114326
- 1x 6114358
- 1x 6114379
- 1x 6079017
- 4x 6114328
- 1x 6115669



Customer Service
Kundenservice
Service Consommateurs
Servicio Al Consumidor
LEGO.com/service or dial

- 00800 5346 5555 :
- 1-800-422-5346 :





70794

70795

LEGO.com/bionicle/bi



LEGO.com/bionicle



Download App
Télécharger l'application
Descarga la App



Available on the
App Store

Apple, the Apple logo, iPad, iPhone and iPod touch are trademarks of Apple Inc. Apple, le logo Apple, iPad, iPhone et iPod touch sont des marques de commerce d'Apple Inc. Apple, el logotipo de Apple, iPad, iPhone e iPod touch son marcas comerciales de Apple Inc.

GET IT ON
Google play

Google Play is a trademark of Google Inc. Google Play est une marque de commerce de Google Inc. Google Play es una marca comercial de Google Inc.





70791

70794



70795

70792

70793