



BIONICLE

71310







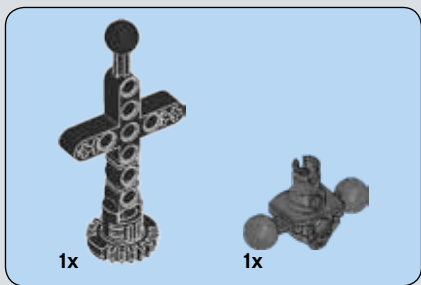

1

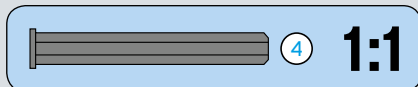
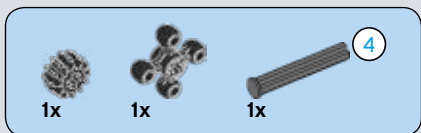
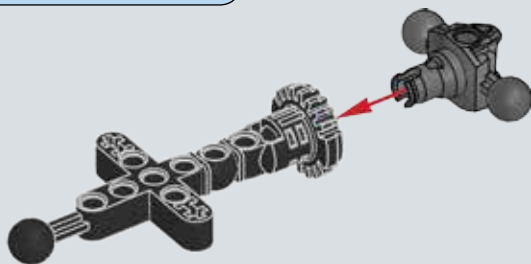

2

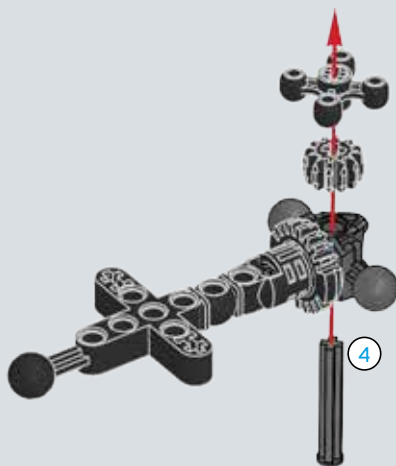

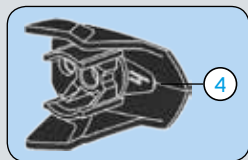

3

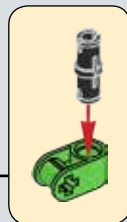
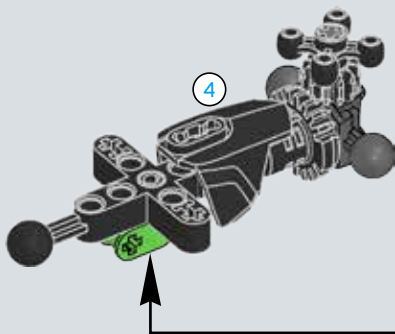

4

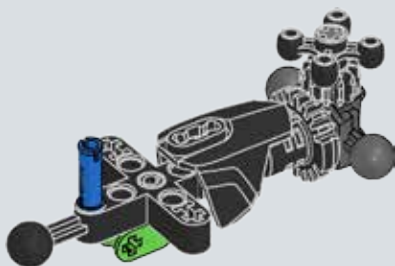

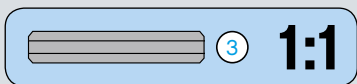
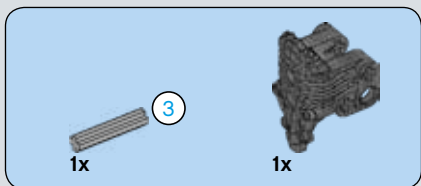

5

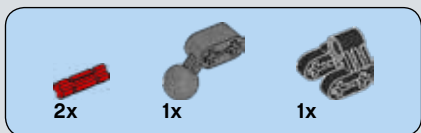
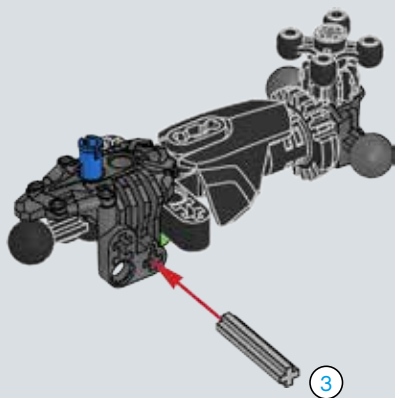

6

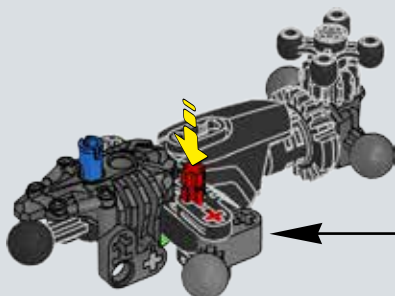

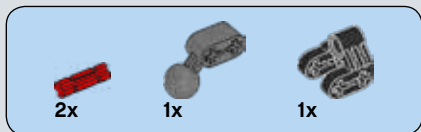

7

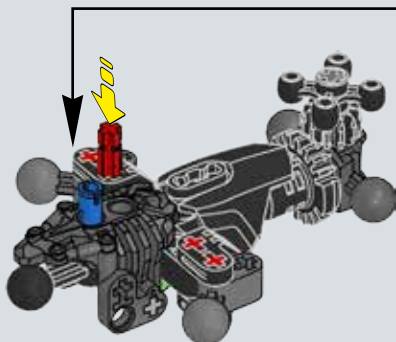

8

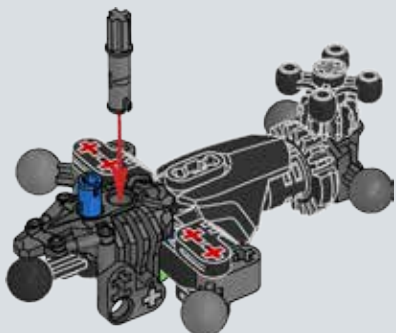

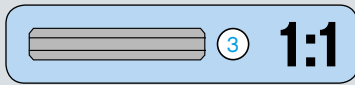
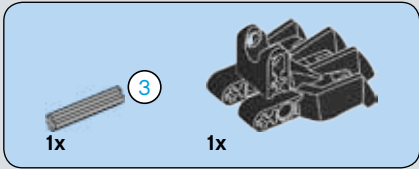

9

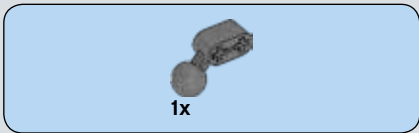
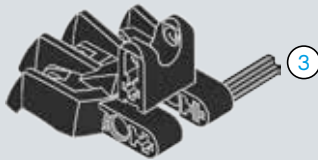

10

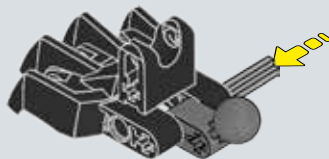



11

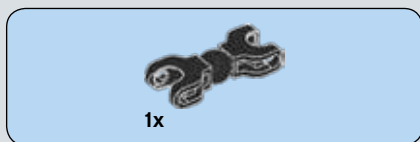
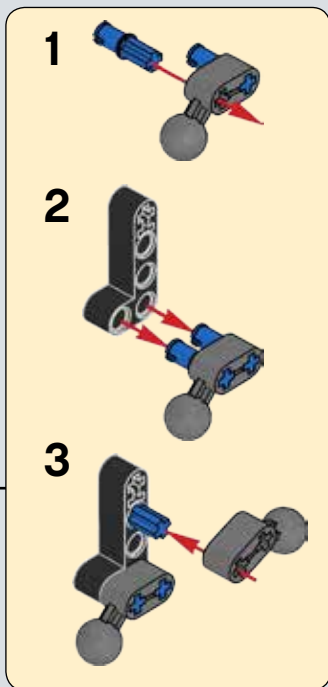
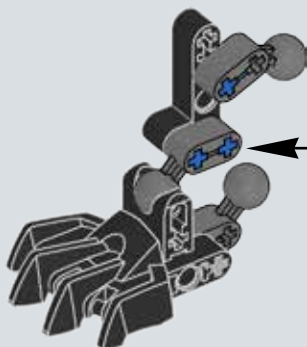

12

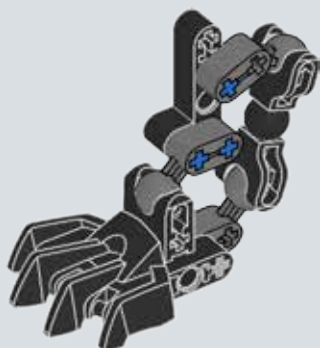

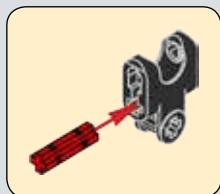
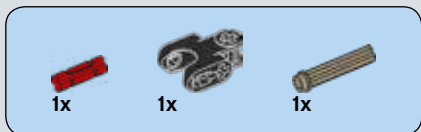

13

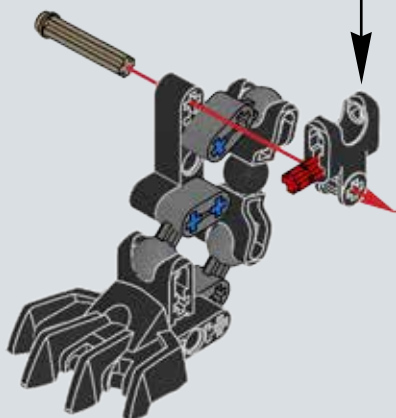

14

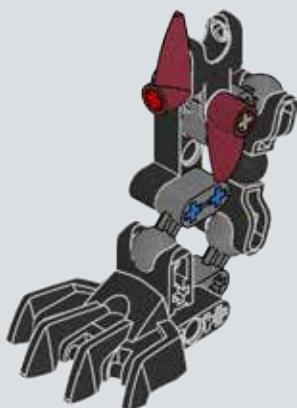

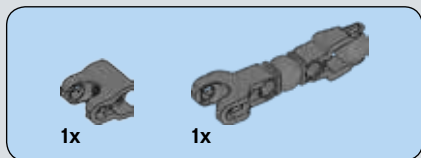

15

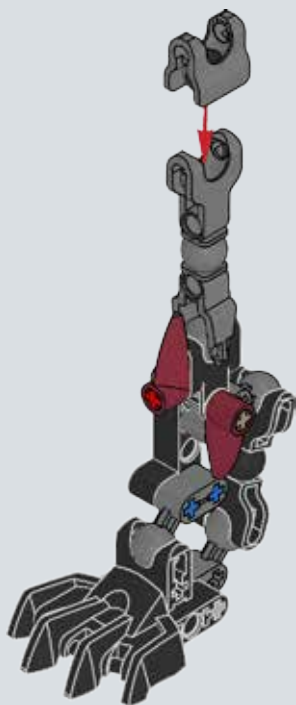

16

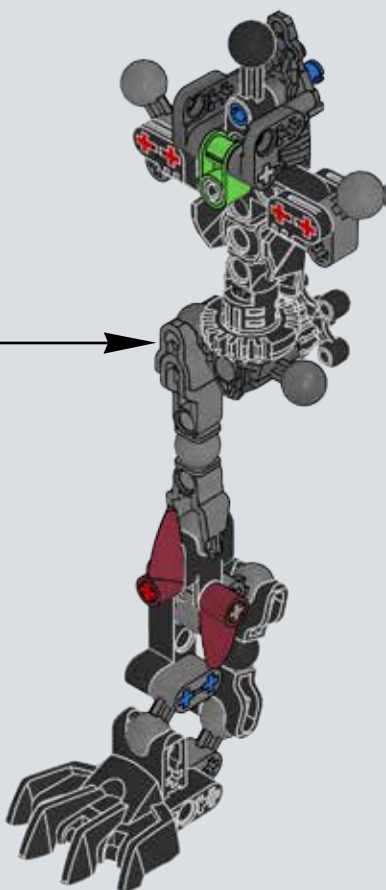

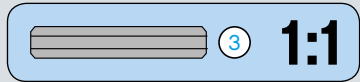
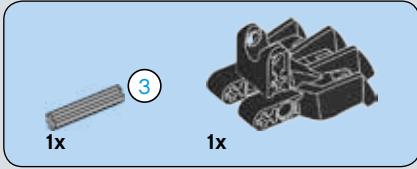

17

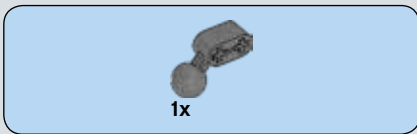
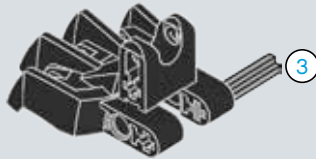

18

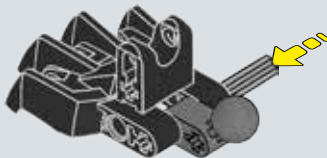



19

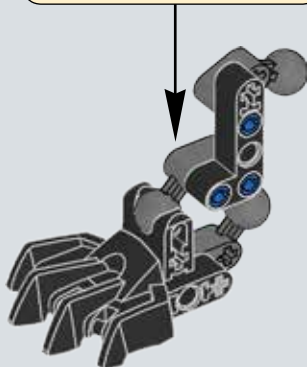
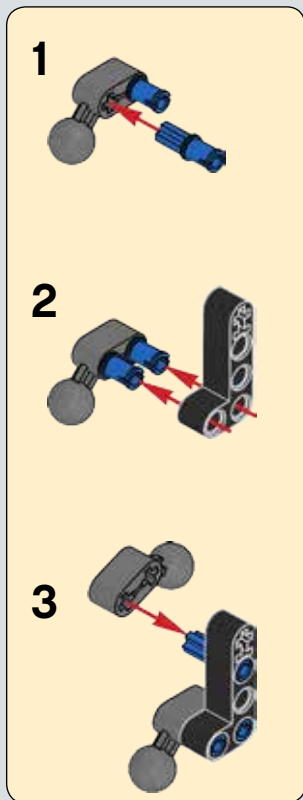



1x

20



1x



1x



1x

21

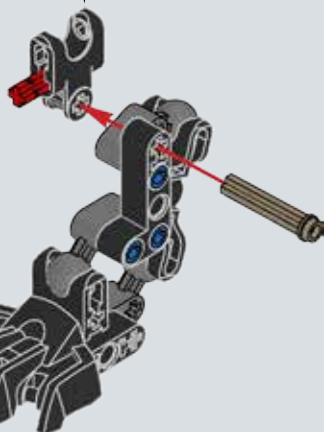
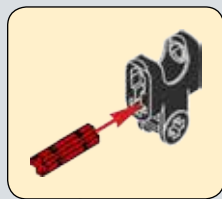



2x

22

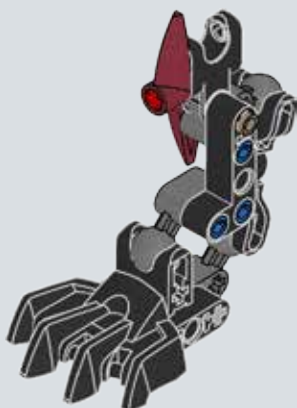

1x

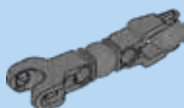

1x

23

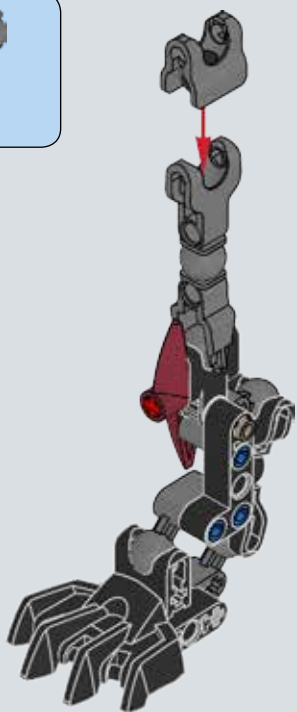

24

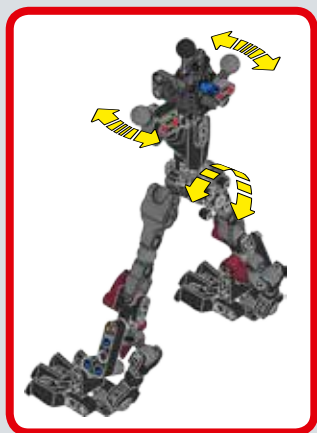
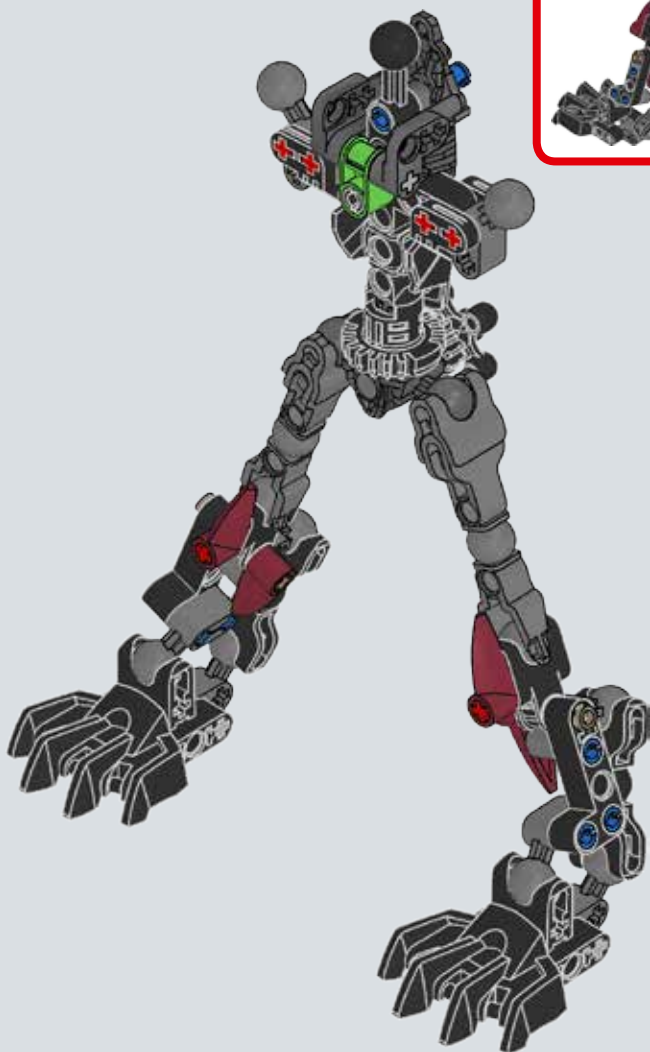

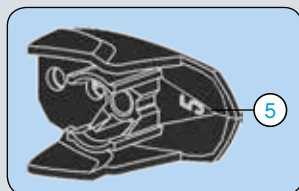
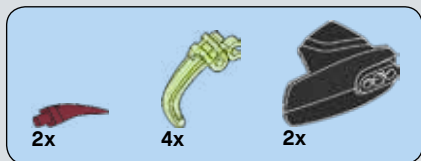

25

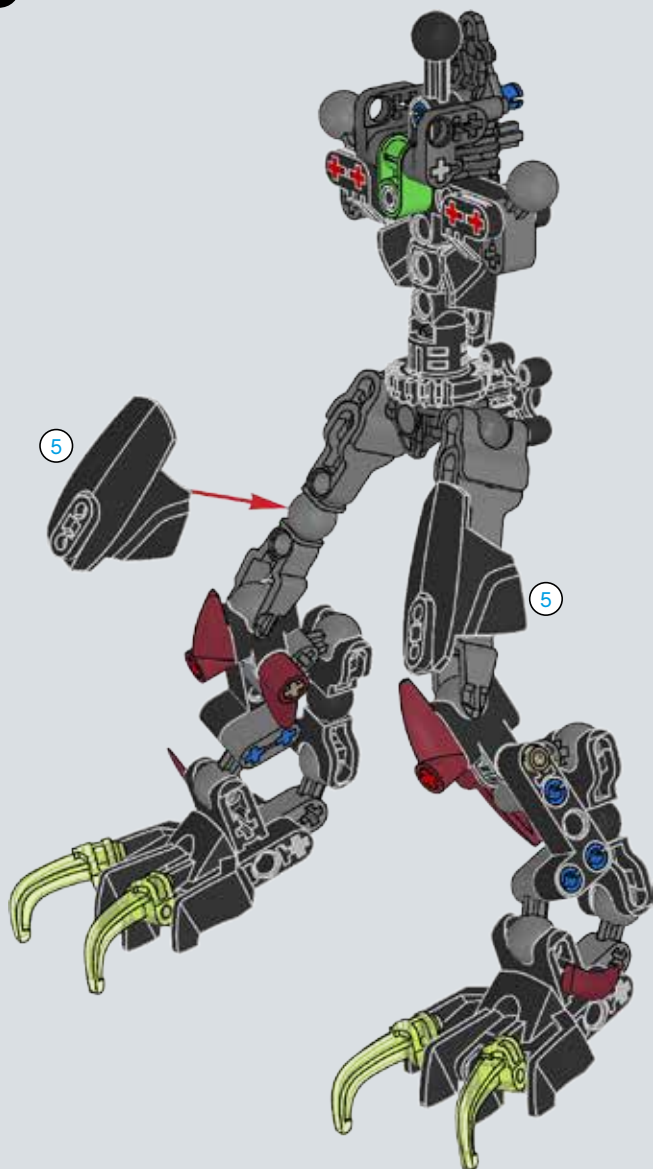

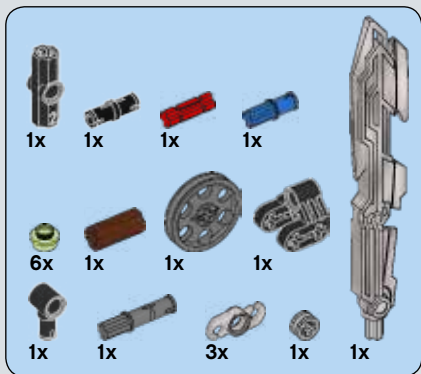

26

1



2



3

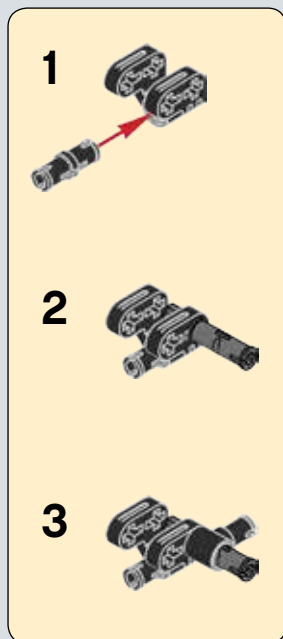
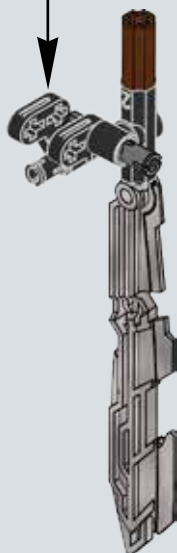

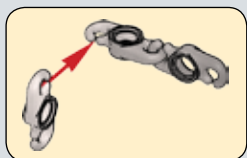

4

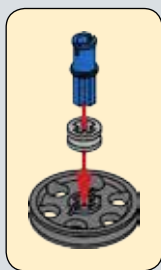
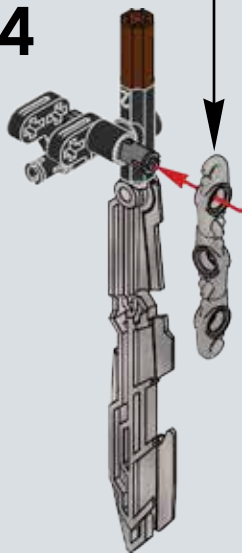

5

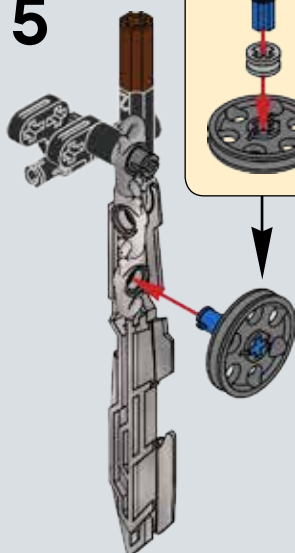

6

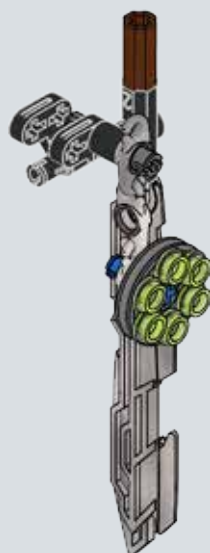

27

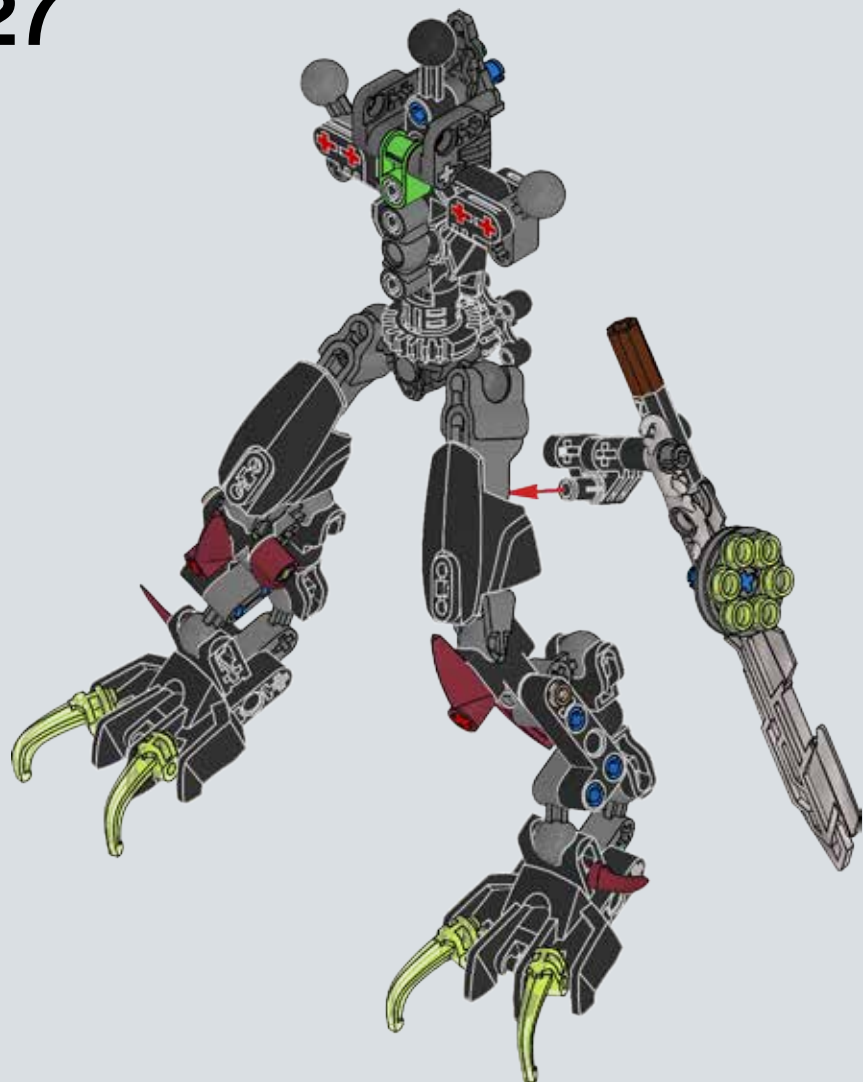



2x



1x

28

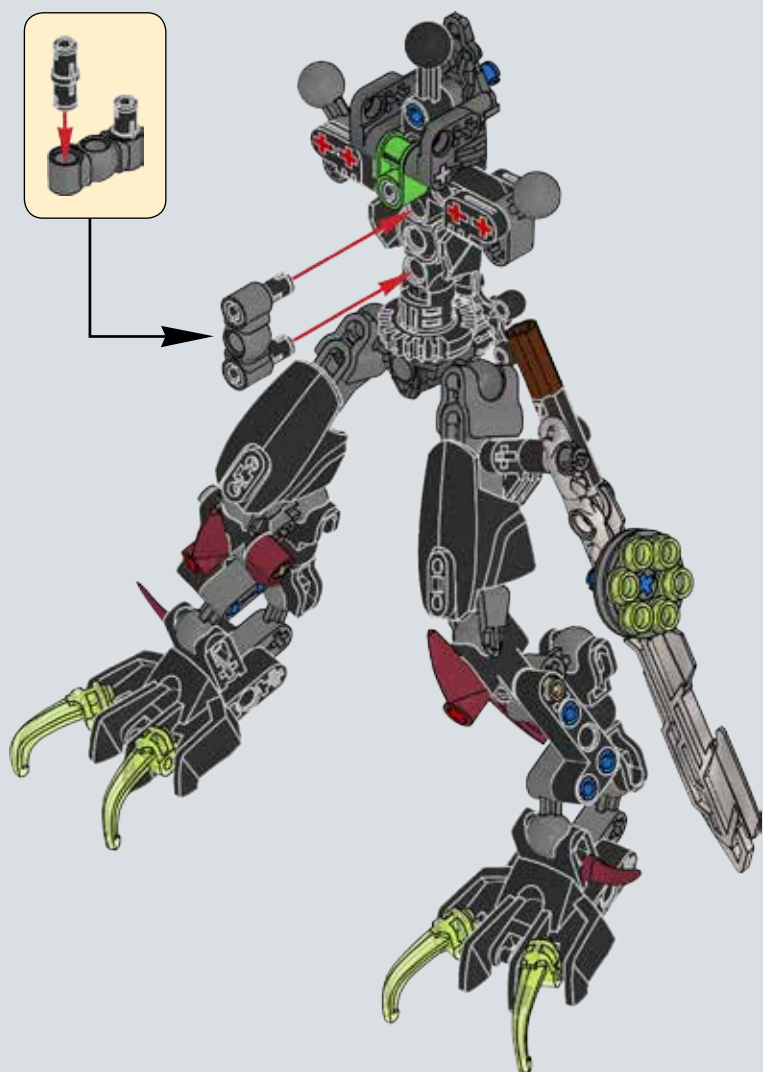



29

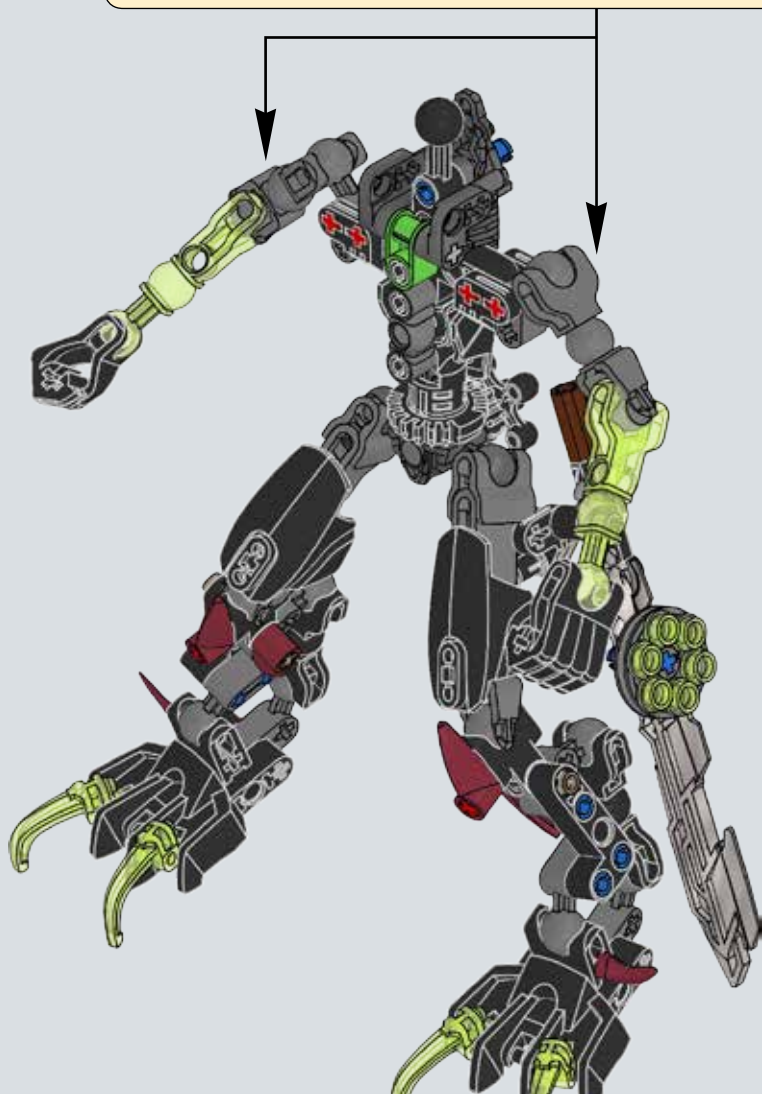
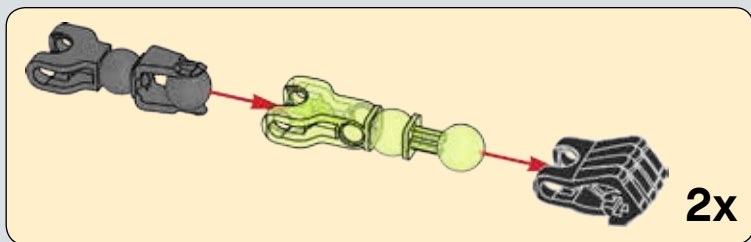

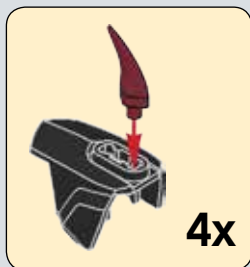
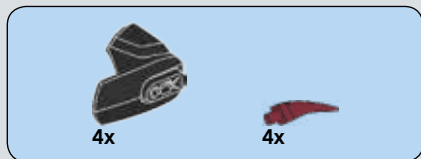

30

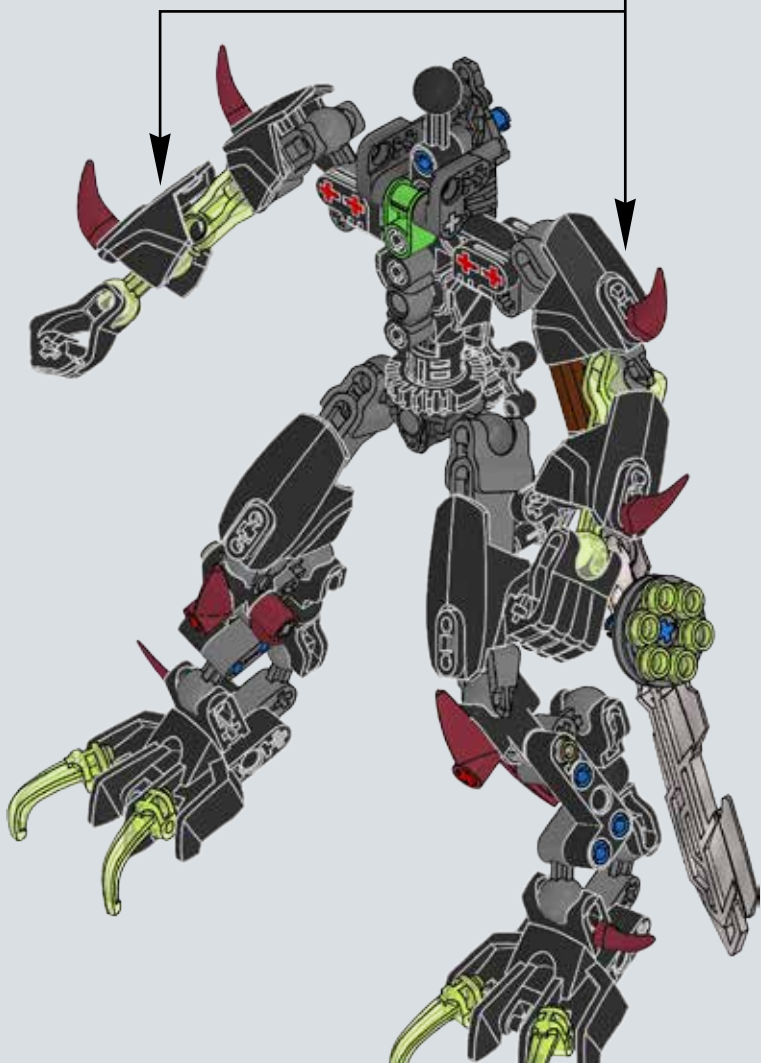



2x

31



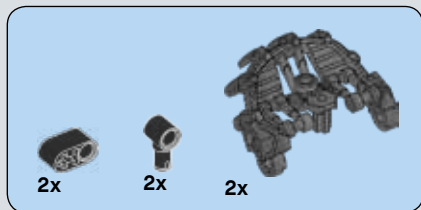

32

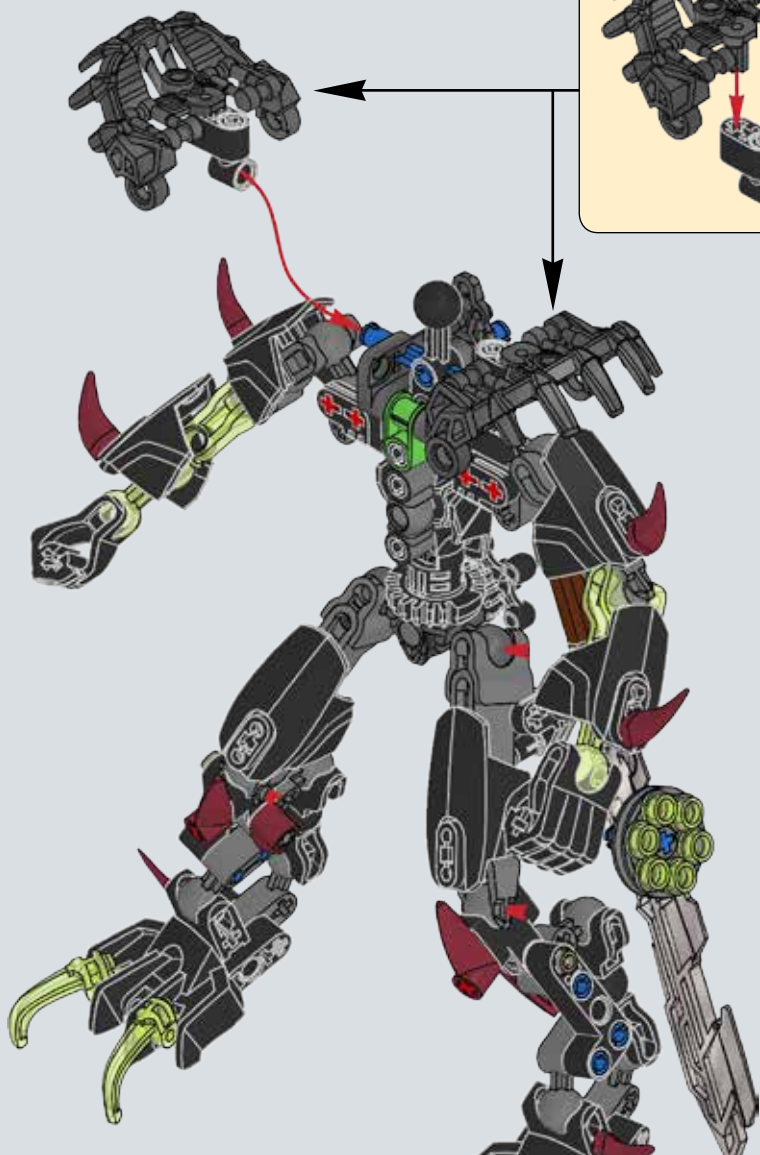
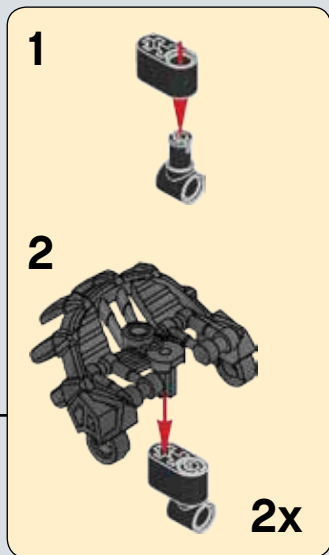



4x



1x

33

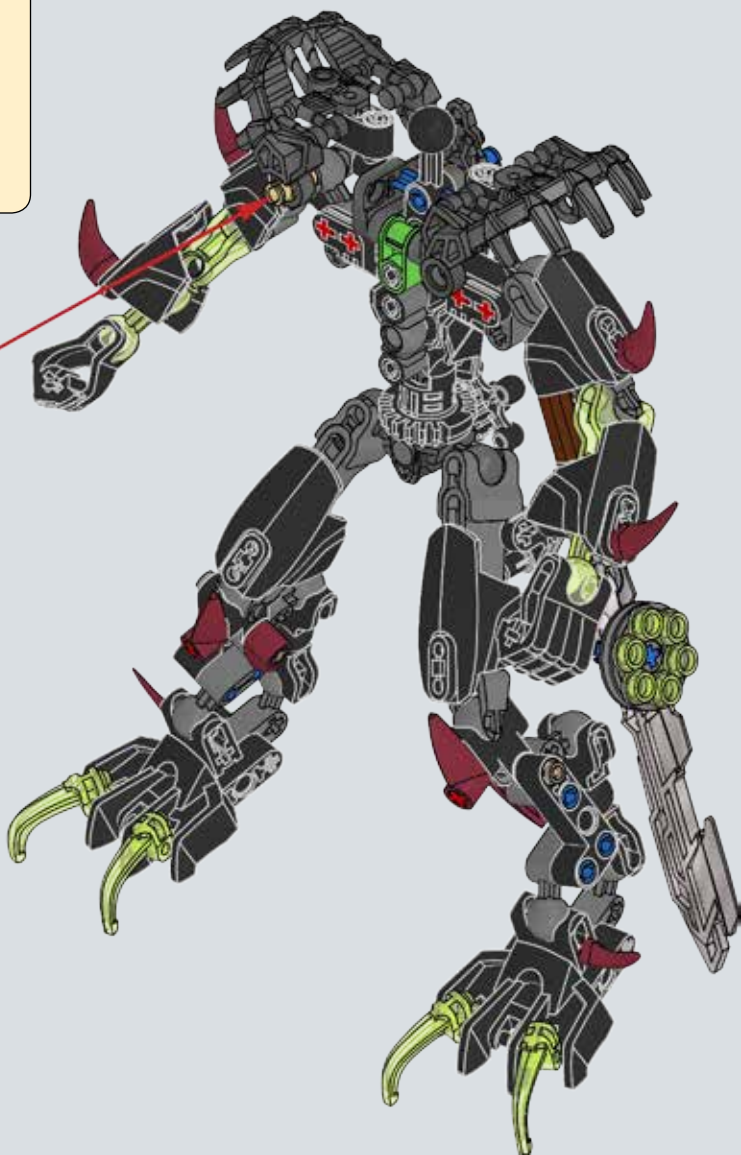
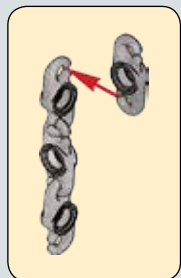

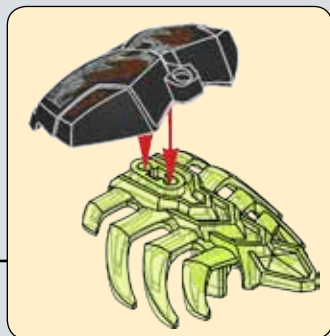
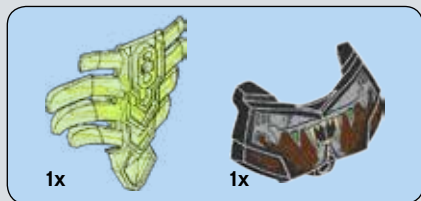

34

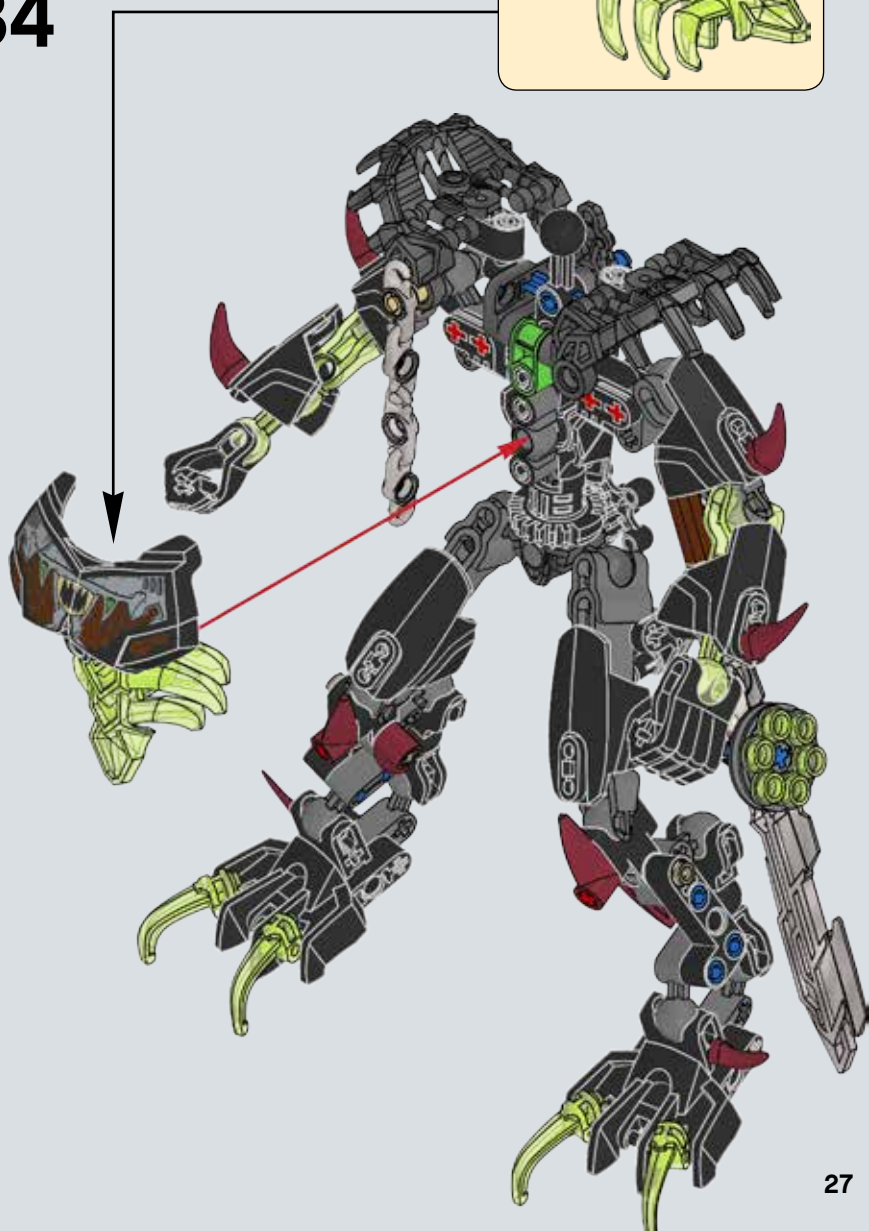



35

1



2

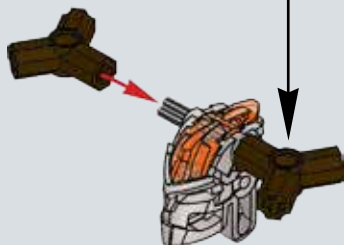
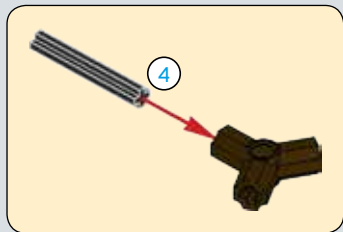

3

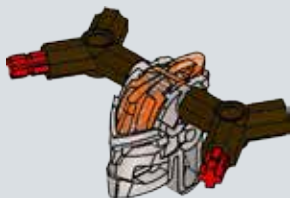

4

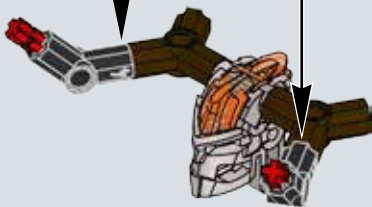
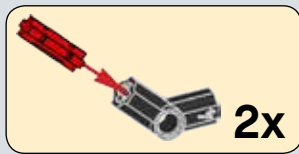

5

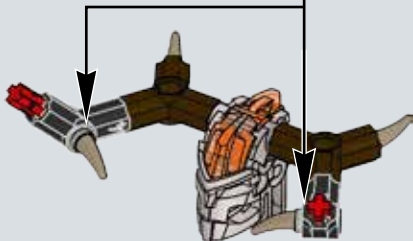
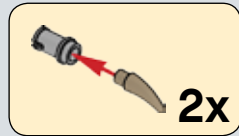

6

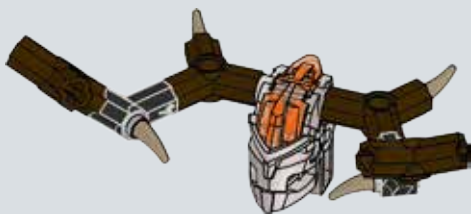

7

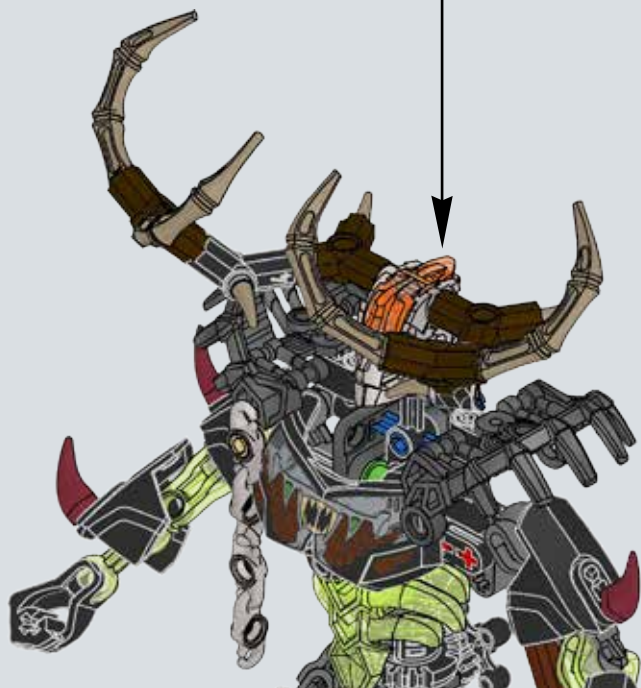
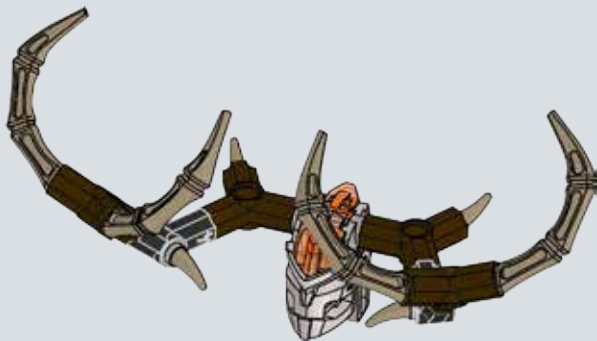

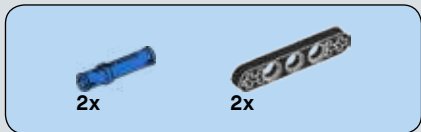
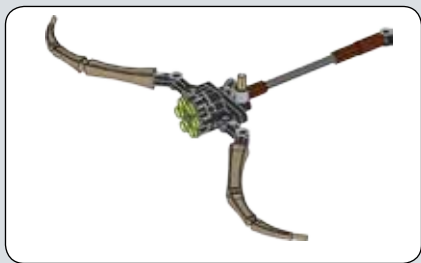

1

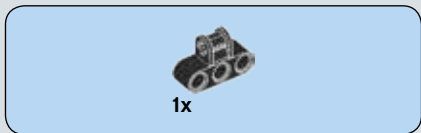
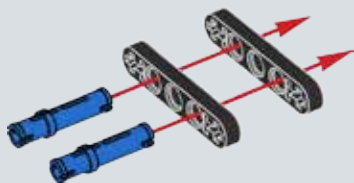

2

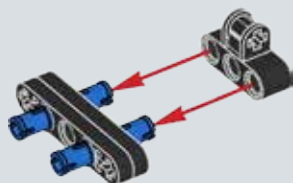

3

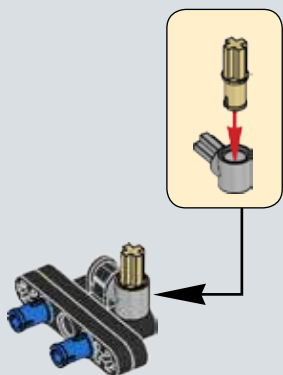

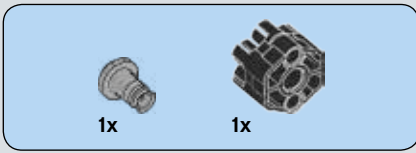

4

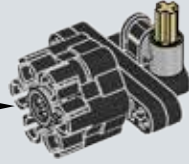
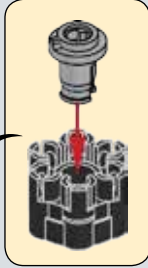

CLICK

CLIC

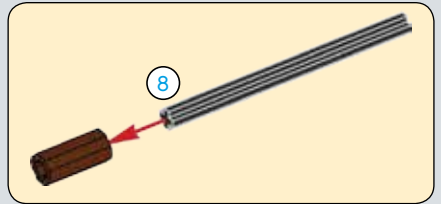
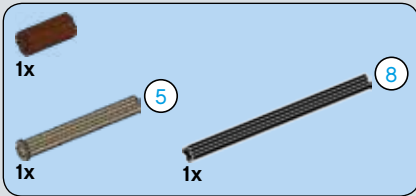

5

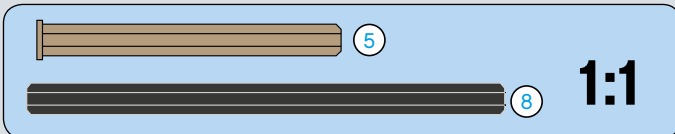
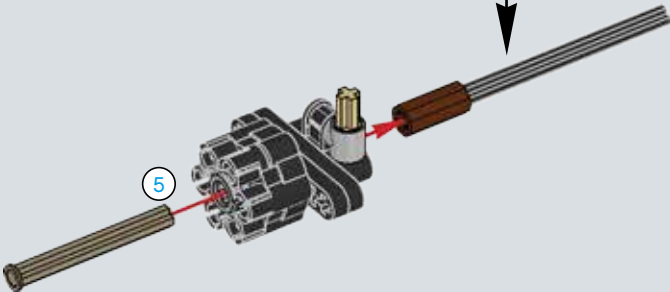



1x



1x

6

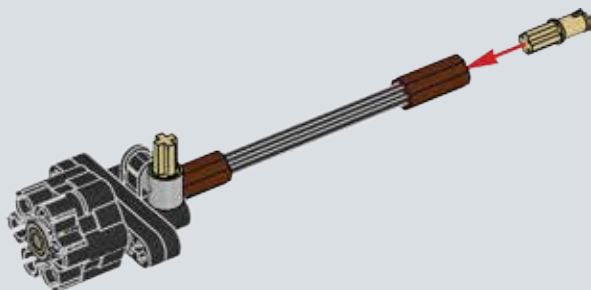

1x



1x

7

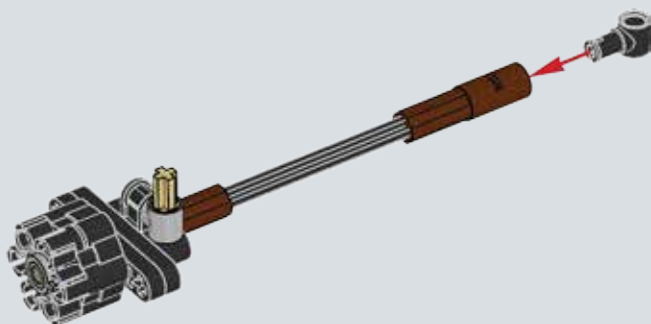

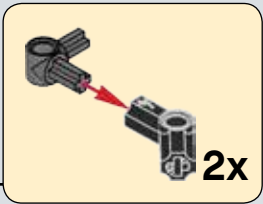

8

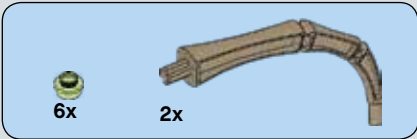
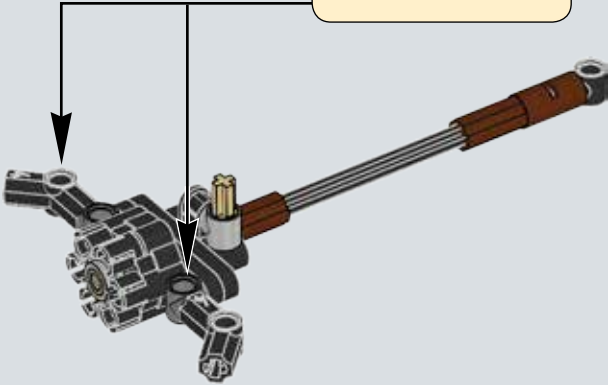

9

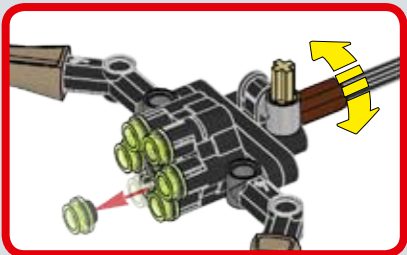
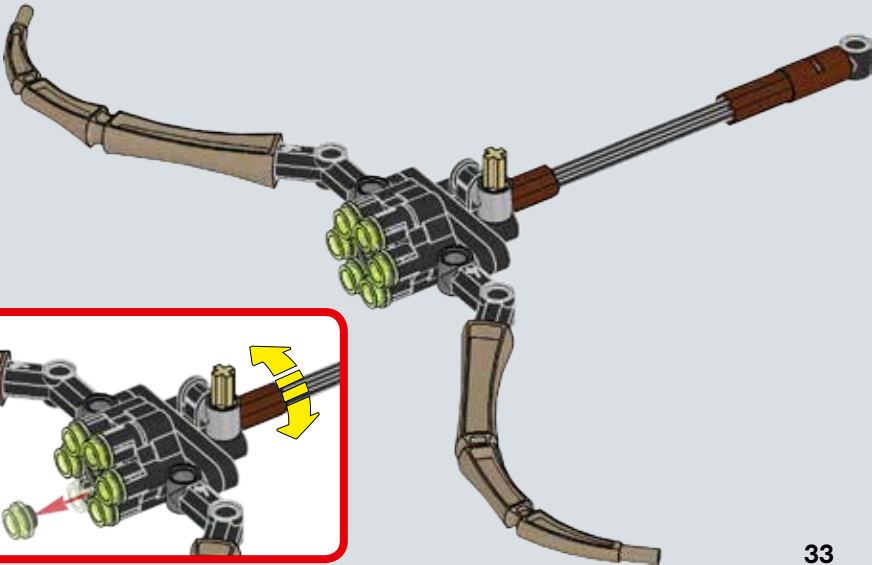



1x

36





37

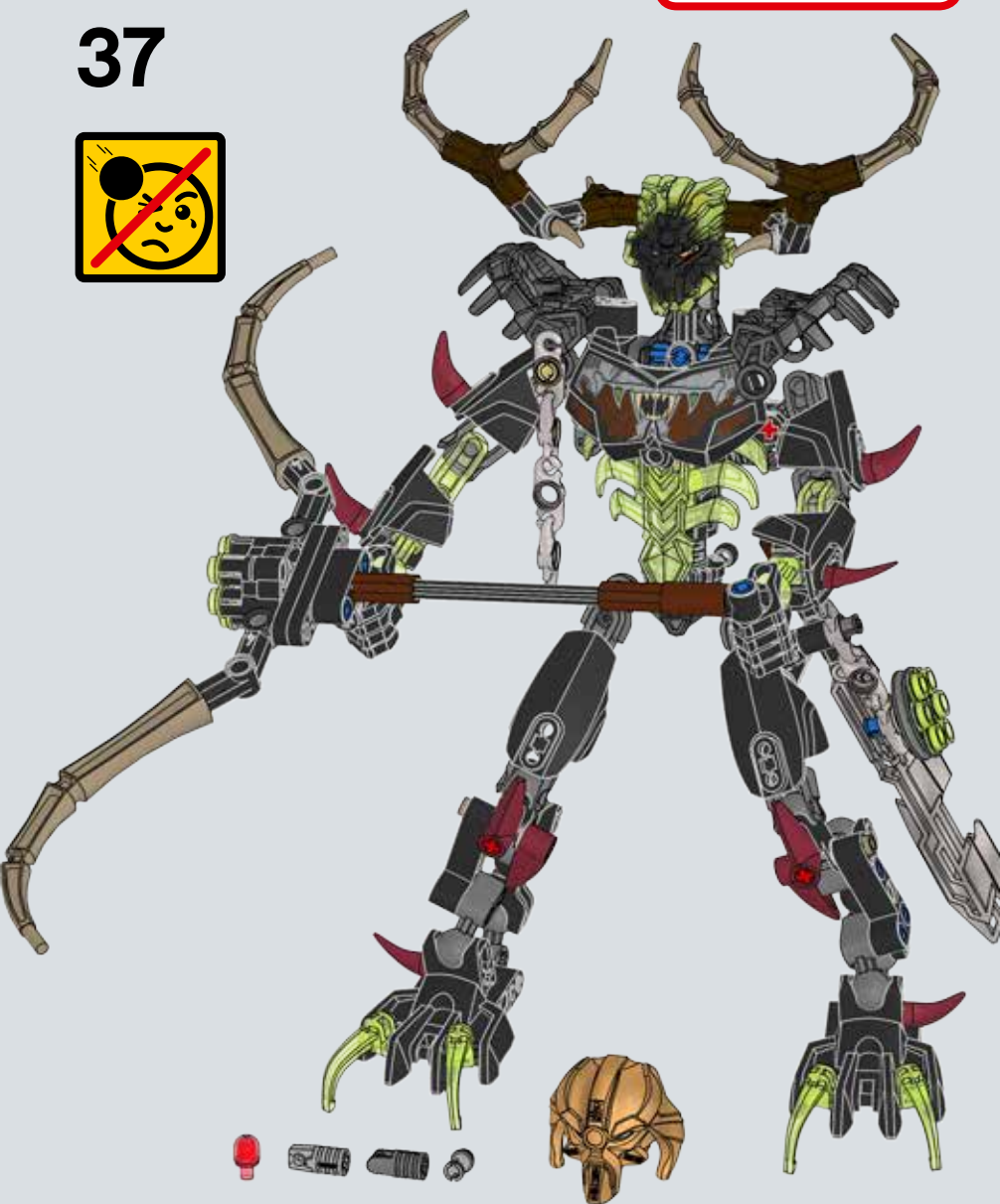

38





1

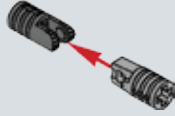

2

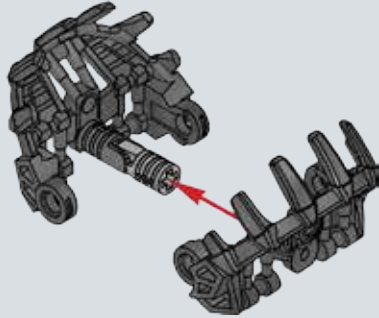

3

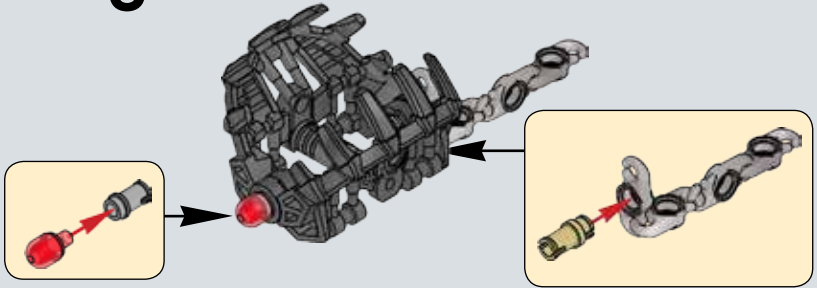

4

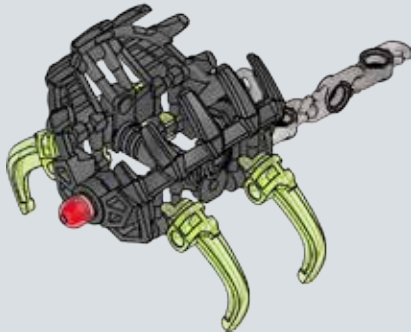

1x
6013938

2x
4666579

11x
4142865

10x
4206482

3x
4514553

4x
6073231

1x
4107783

1x
4177431

4x
4121610

4x
4121715

2x
6006140

1x
4248204

3x
4610371

1x
6007966

5x
6044720

1x
370526

2x
4612482

2x
4120017

2x
4632637

2x
6030286

1x
6135125

2x
4593567

2x
6056379

1x
6135166

2x
6056379

2x
6056379

1x
6135166

2x
6056379

1x
6135166

1x
6135166

1x
6135166

2x
4610948

1x
6100104

1x
6097399

1x
4497943

1x
6135215

4x
6022717

2x
6031821

4x
6133123

1x
6055631

4x
6133131

6x
6133143

3x
4531751

1x
6055781

1x
4211573

1x
4211573

1x
4211573

1x
4211573

1x
4211573

1x
4211573

1x
4211573

1x
4211573

1x
4211573

3x
4211483

1x
4211679

1x
6097090

1x
6123815

3x
4211815

12x
6057034

1x
4210695

2x
6005331

2x
6106472

1x
4587275

2x
6015356

8x
4289258

1x
6001085

2x
6133126

1x
370726

1x
370726

1x
370726

1x
370726

1x
370726

1x
370726

1x
370726

1x
370726

1x
6083620

2x
4622903

2x
6121358

1x
6135225

4x
6005755

4x
6133534

1x
6135060

1x
6114322

2x
6133155

1x
6133155

1x
6133155

1x
6133155

1x
6133155

1x
6133155

1x
6133155

1x
6133155

1x
6133155

1x
6133155

1x
6133155

1x
6133155

1x
6133155

1x
6133155

1x
6133155

1x
6114379

7x
6124042

1x
6102606

1x
6138237

1x
6139106

2x
6135124



Customer Service

Kundenservice

Service Consommateurs

Servicio Al Consumidor

LEGO.com/service or dial



00800 5346 5555 :



1-800-422-5346 :



LEGO

BIONICLE



UNITE for battle



71300+71310



LEGO.com/bionicle

**UNIS-LES pour le combat
Sólo podemos luchar UNIDOS**

Download App
Télécharger l'application
Descarga la App



Download on the
App Store

Apple, the Apple logo, iPad, iPhone and iPod touch are trademarks of Apple Inc. Apple, le logo Apple, iPad, iPhone et iPod touch sont des marques de commerce d'Apple Inc. Apple, el logotipo de Apple, iPad, iPhone e iPod touch son marcas comerciales de Apple Inc.



Google Play is a trademark of Google Inc.
Google Play est une marque de commerce de Google Inc.
Google Play es una marca comercial de Google Inc.



A collection of Bionicle figures and parts against a fiery orange background. The figures are arranged in a grid-like fashion, with some floating and some standing on a stone floor. The background is a gradient of orange and yellow, suggesting a sunset or a fire. The figures are made of plastic and have various colors and designs. Some are holding weapons or tools. The numbers 71311, 71302, 71301, 71311, 71307, and 71306 are placed near the figures. A large, dark, mechanical part is visible in the bottom left corner.

71311

71302

71301

71311

71307

71306



71303



71300



71304



71308



71305



71309

