



# NINJAGO

71787



5



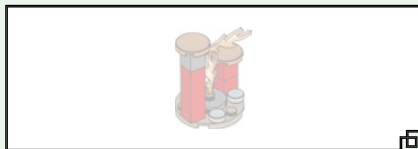
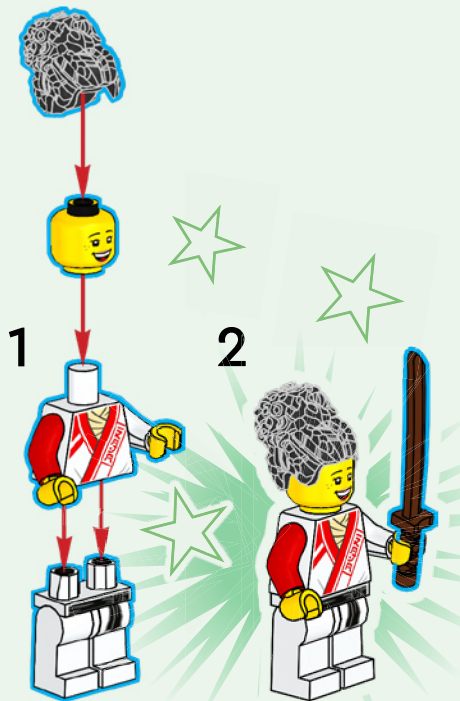

1



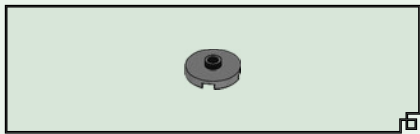

2



4





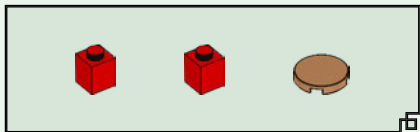

3

1

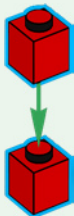

2

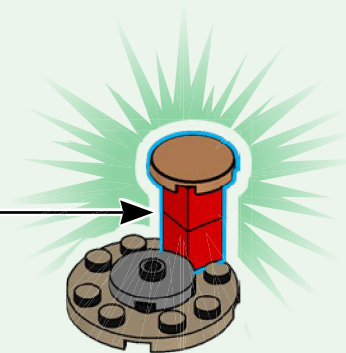



4



6



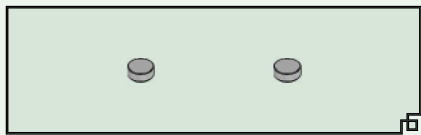

5



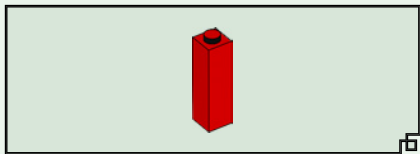

6



8





7

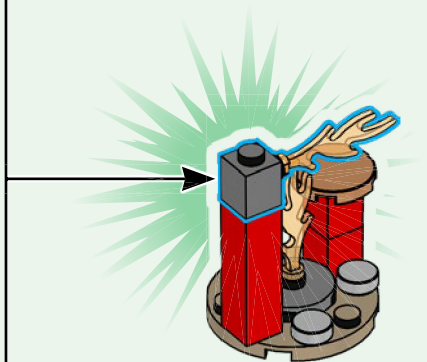
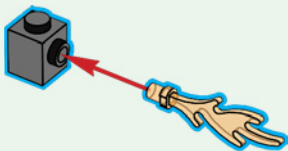



8



10



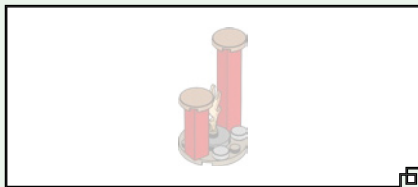

1



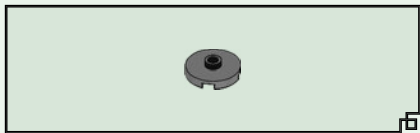

2

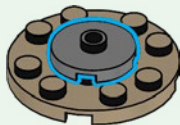





3



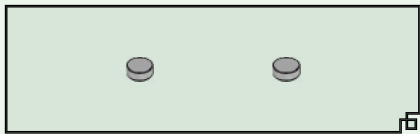

4



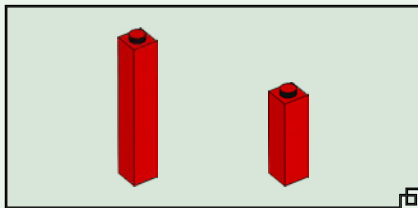

5

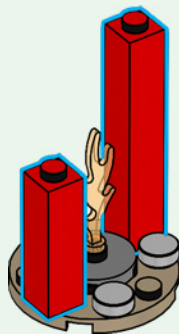

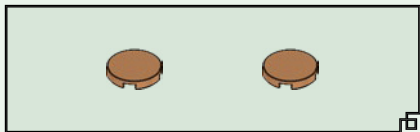

6

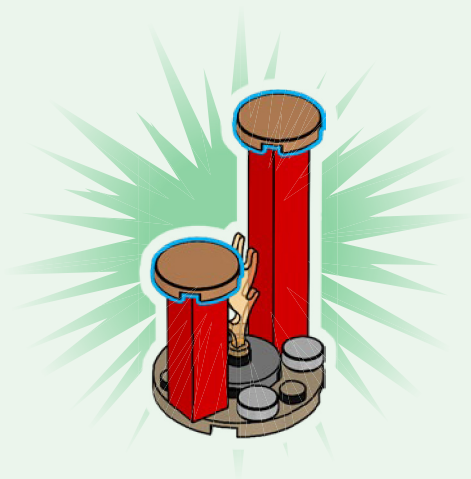



1



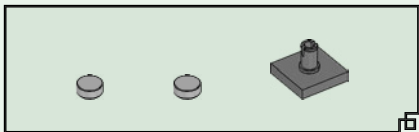

2

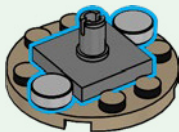



3

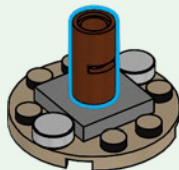



4

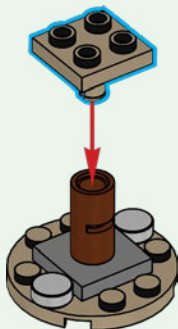



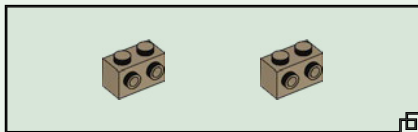

5

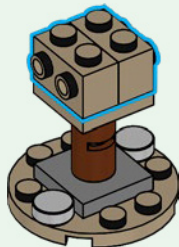

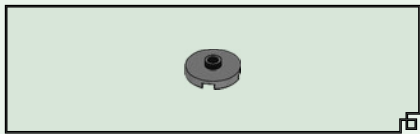

6

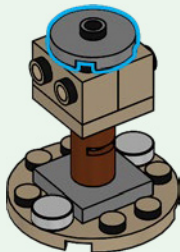

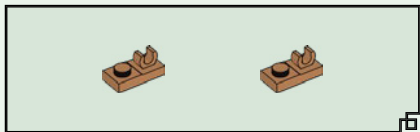

7

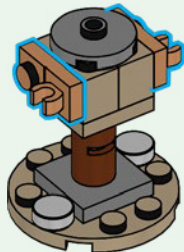

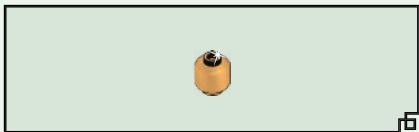

8

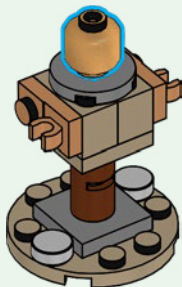



9



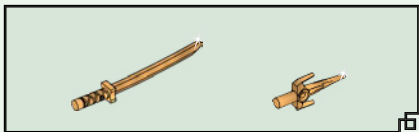

10



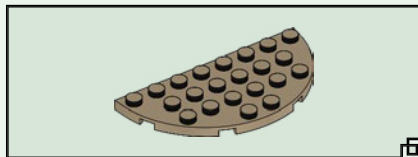
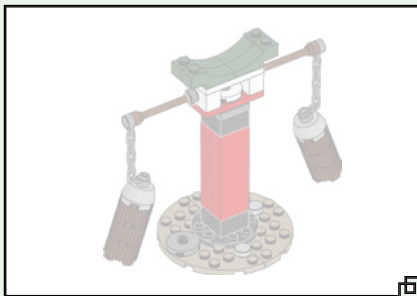

1

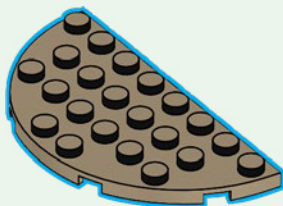

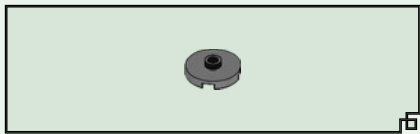

2

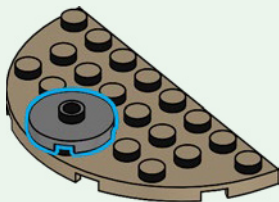





3

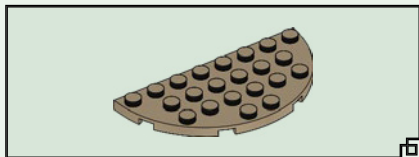
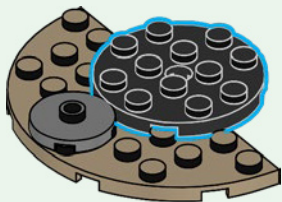

4

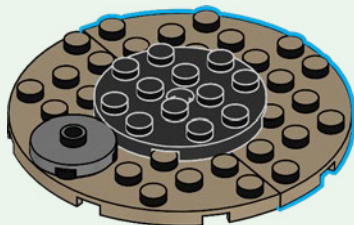

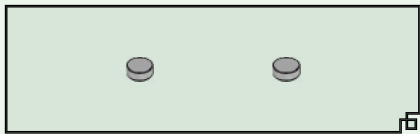

5

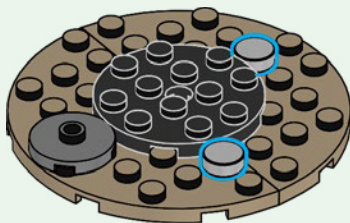

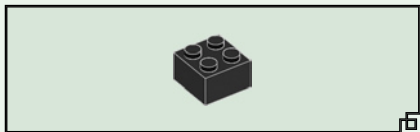

6

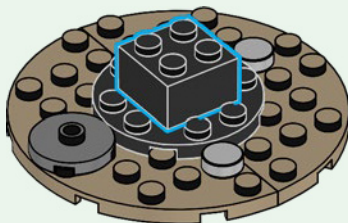

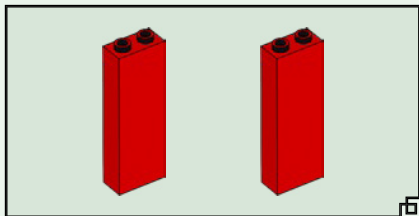

7

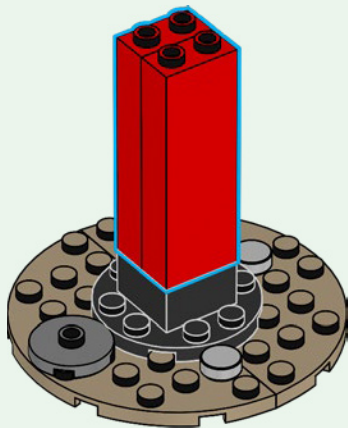

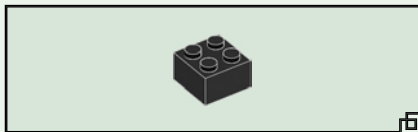

8

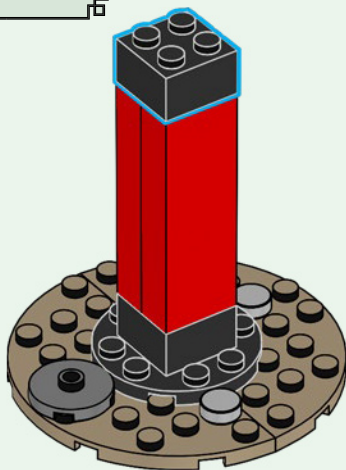

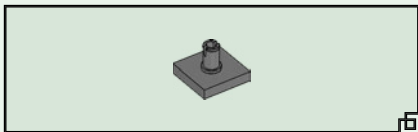

9

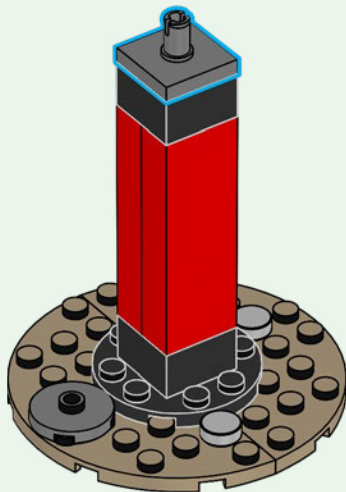

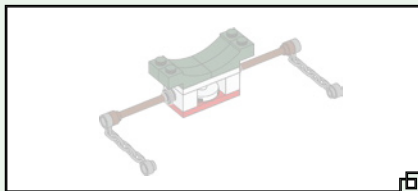

10

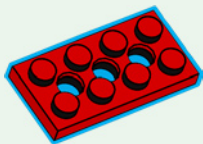

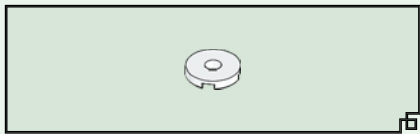

11





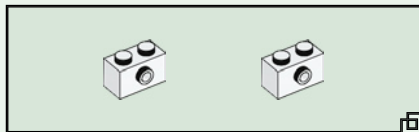

12

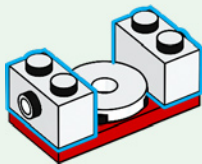



13

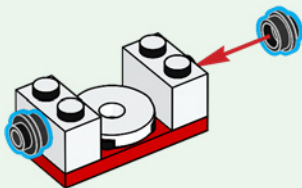

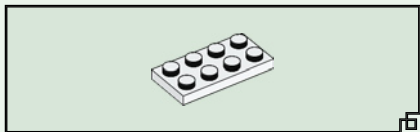

14

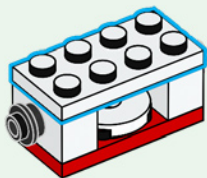

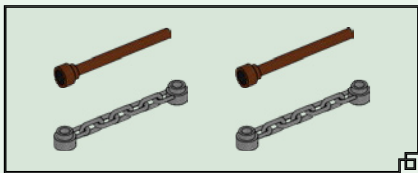
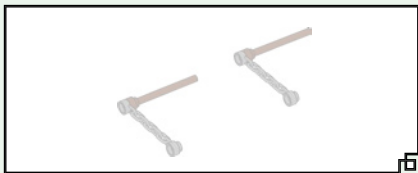

15

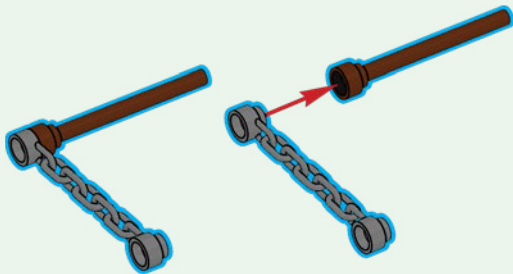

16

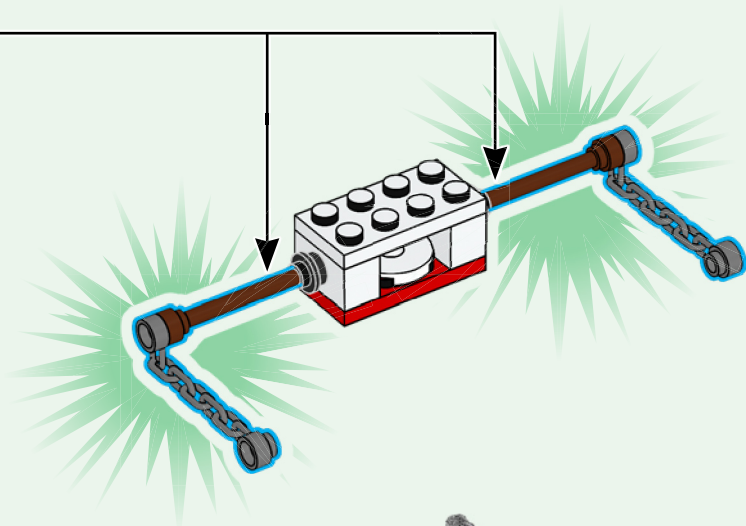

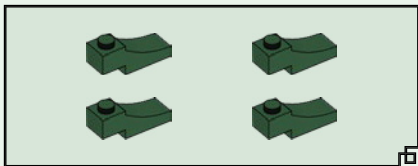

17

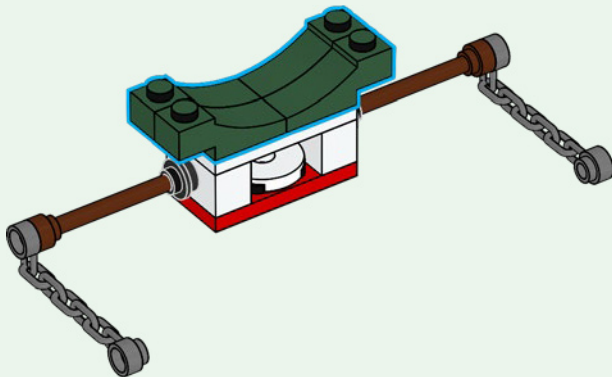

18

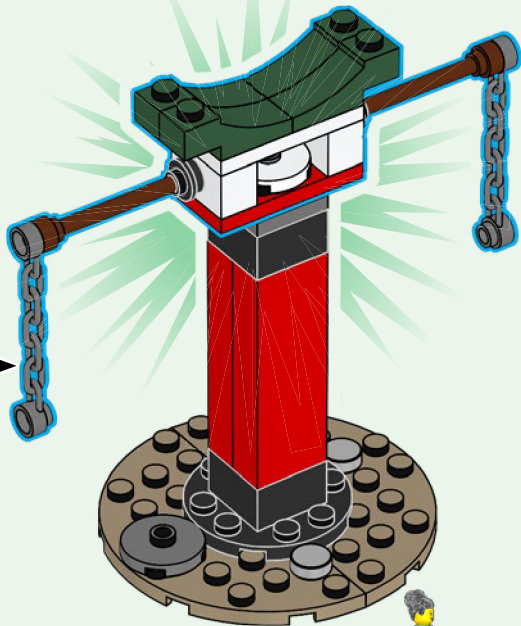

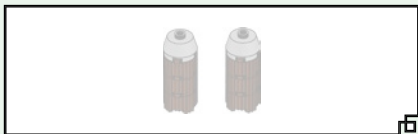

19

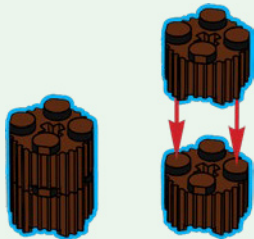





20



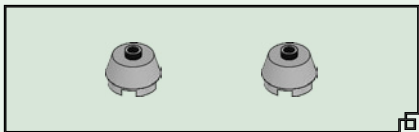

21

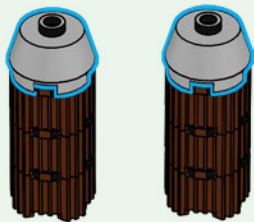

22

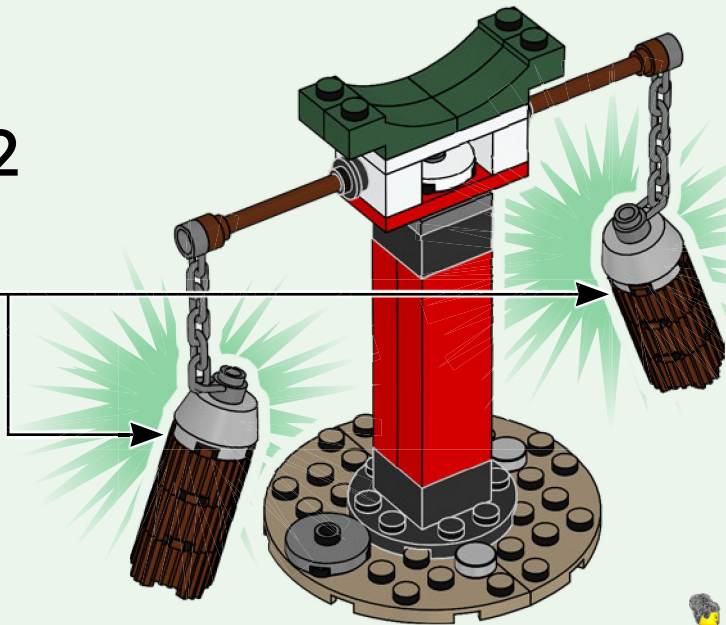



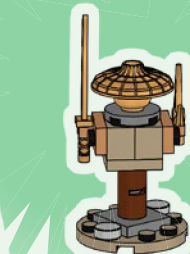
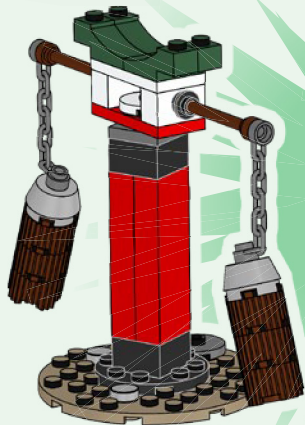

**LEGO**

# NINJAGO



71785



71782



71781



71783





LEGO, the LEGO logo and NINJAGO are trademarks of the LEGO Group.  
©2023 The LEGO Group. 6449689

Rebuild  
the  
world™

