



CITY



WARNING: CHOKING HAZARD.
Small parts. Not for children under 3 years.

7206



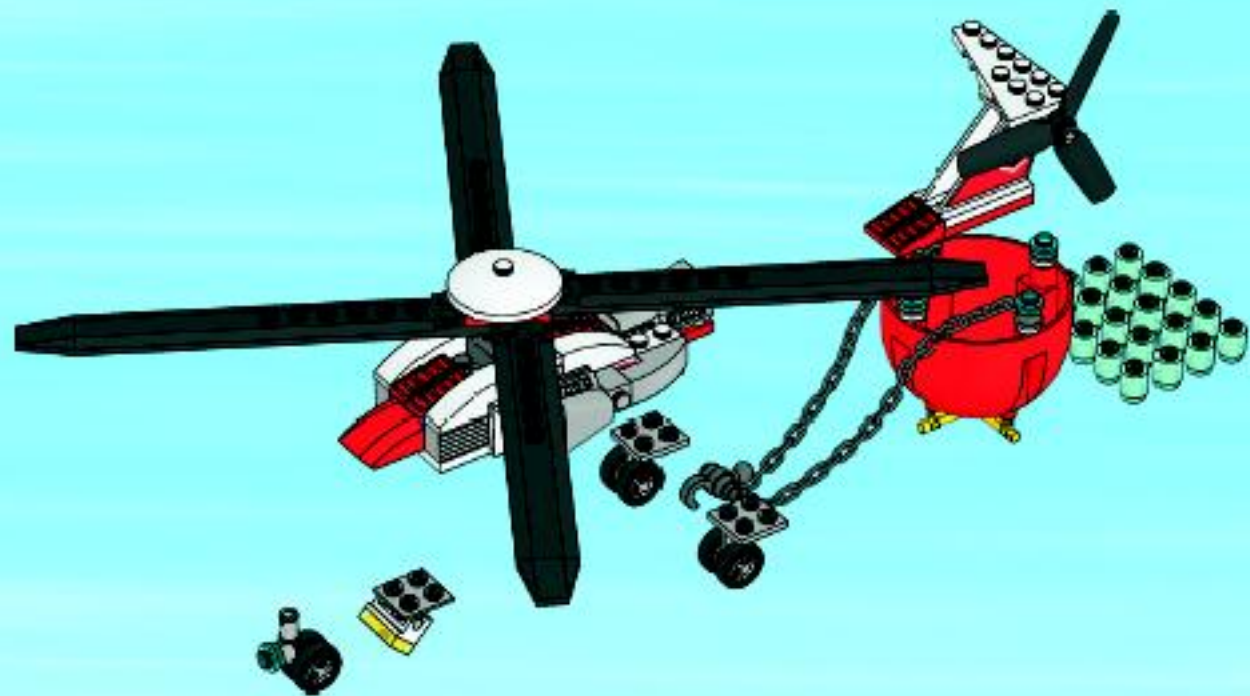



AVERTISSEMENT : RISQUE D'ÉTOUFFEMENT.
Contient des petites pièces. Ne convient pas aux enfants de moins de 3 ans.



ADVERTENCIA: PELIGRO DE ASFIXIA.
No recomendado para niños menores de 3 años. Contiene piezas pequeñas.



1

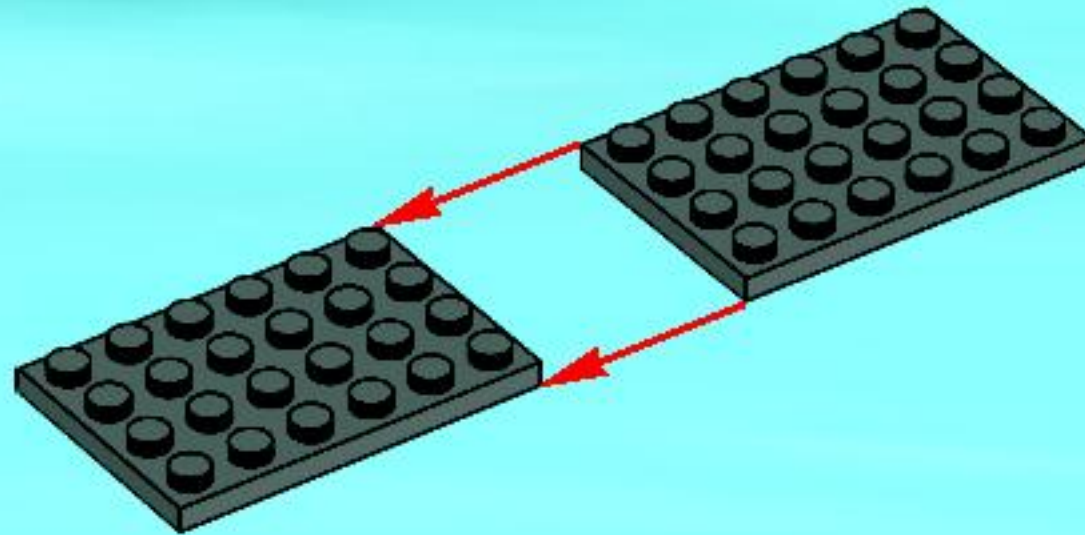

2

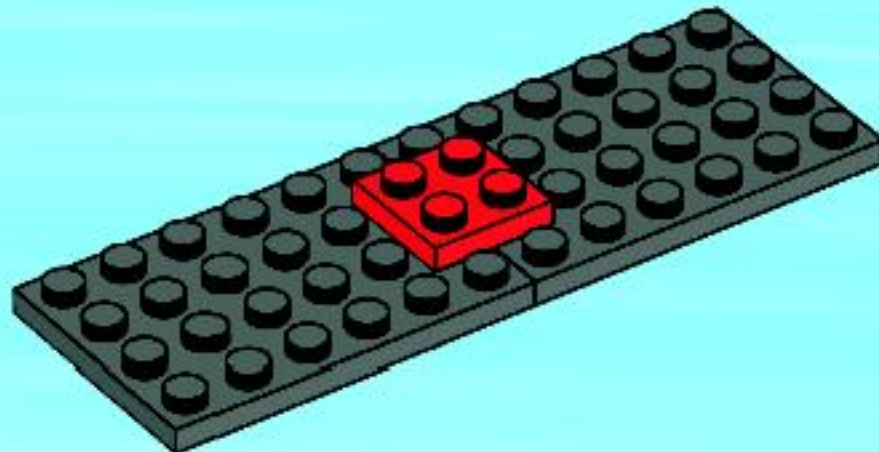

3

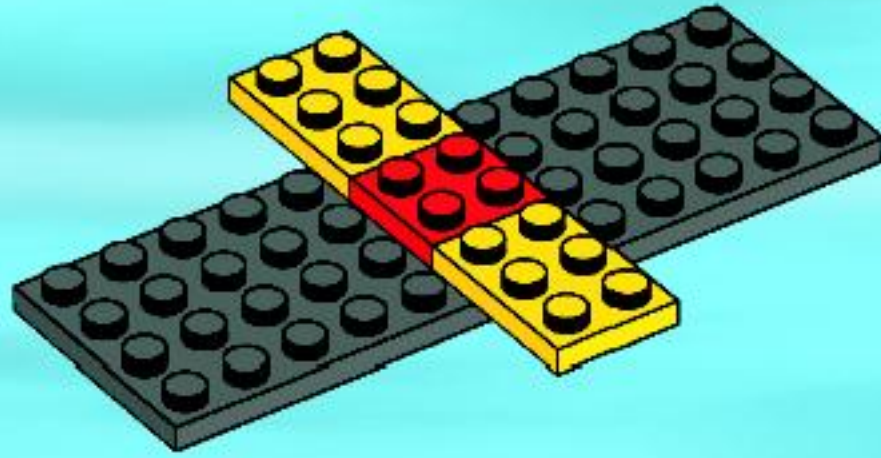

4

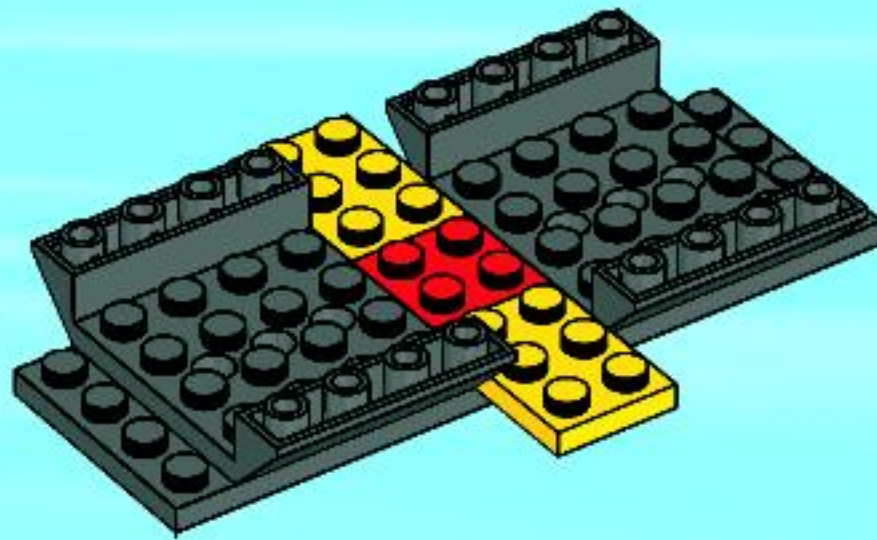

1

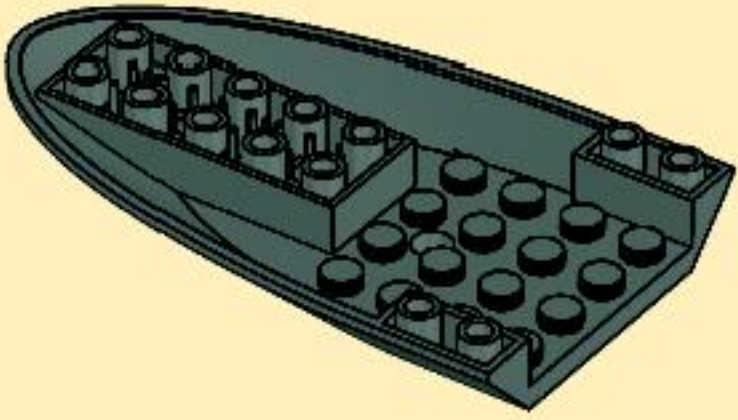

2



3

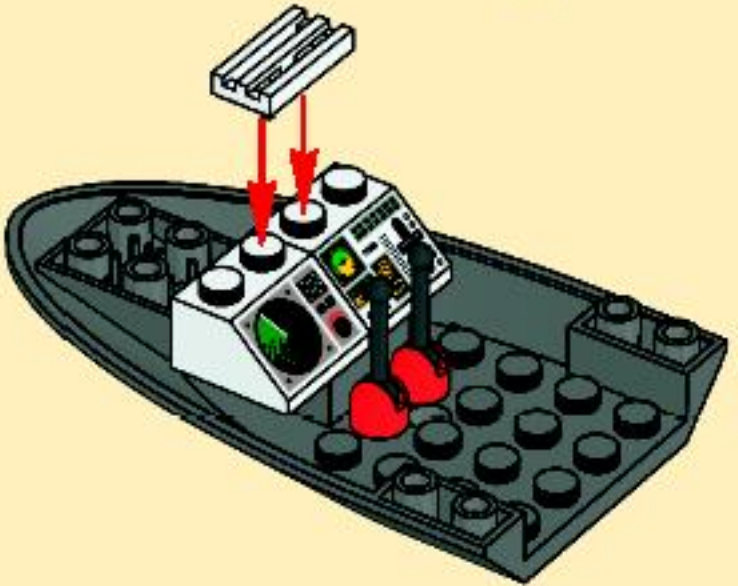

4



5

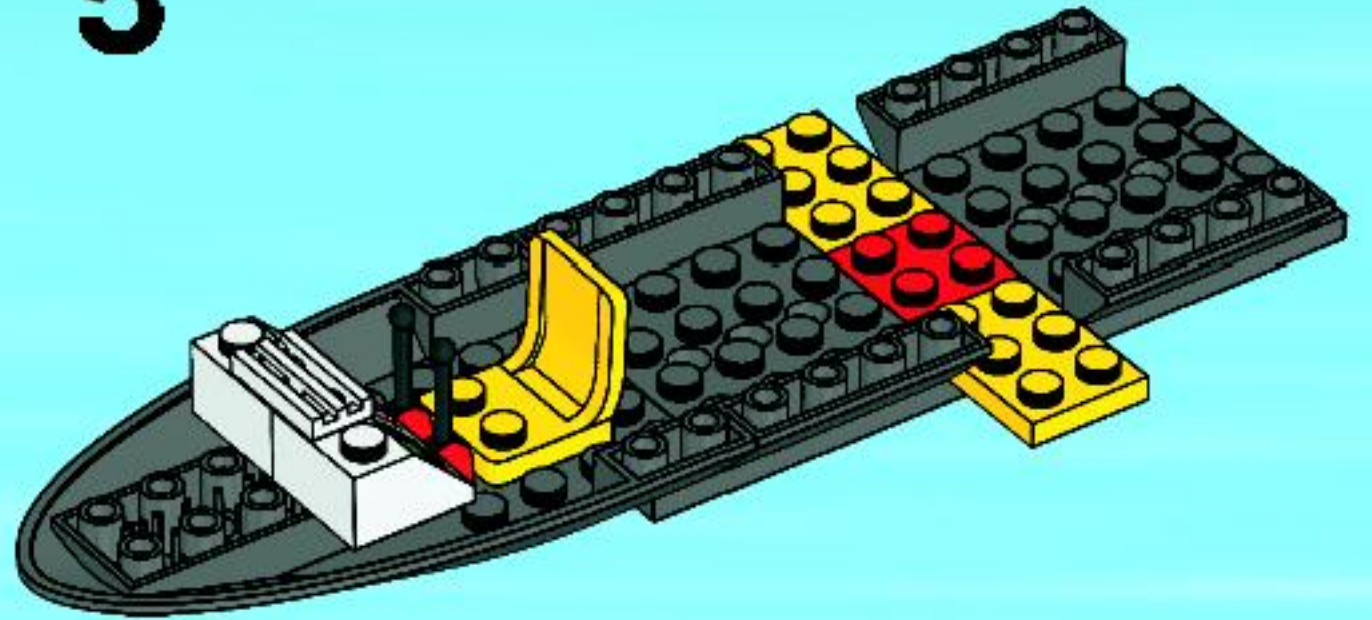

6

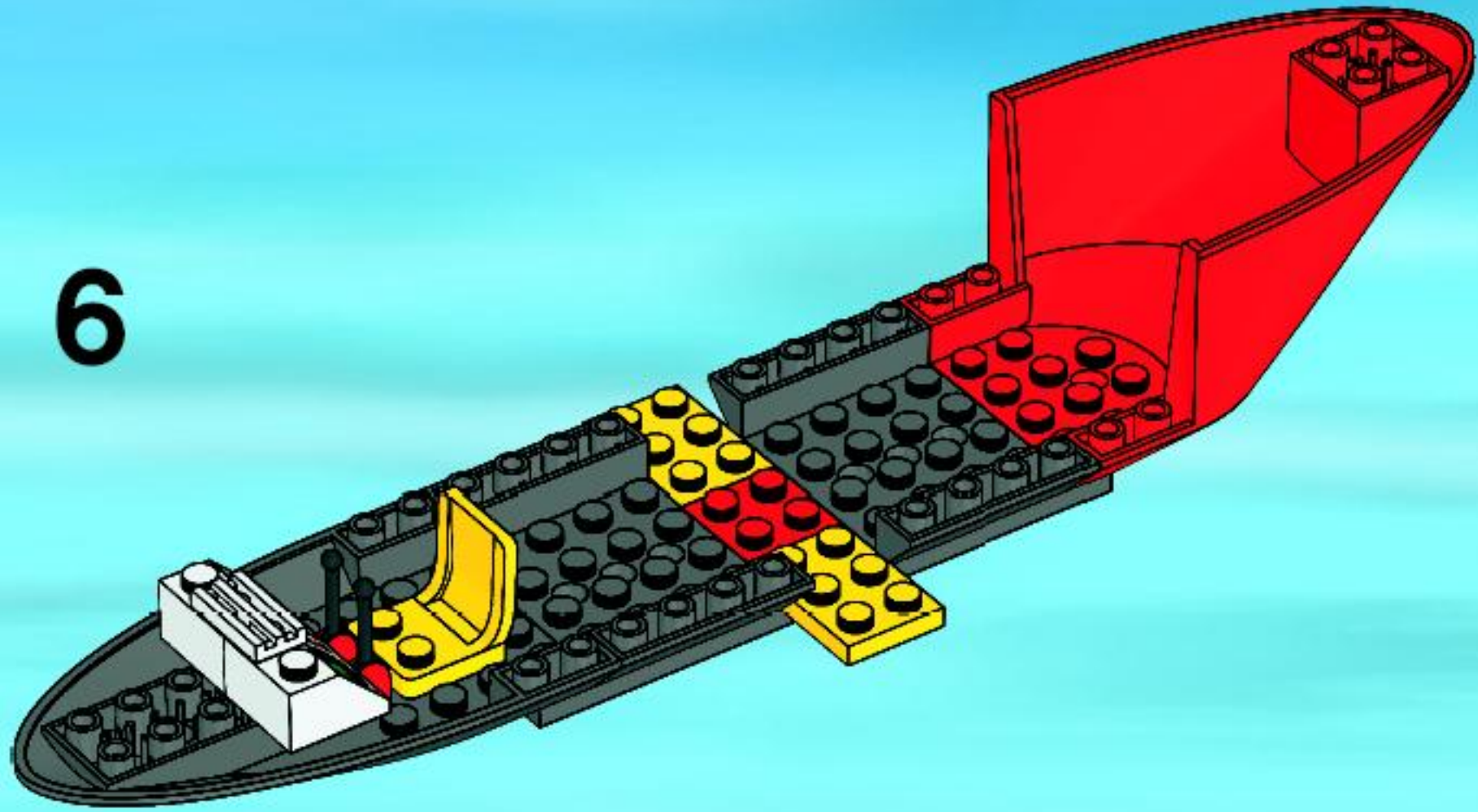

7

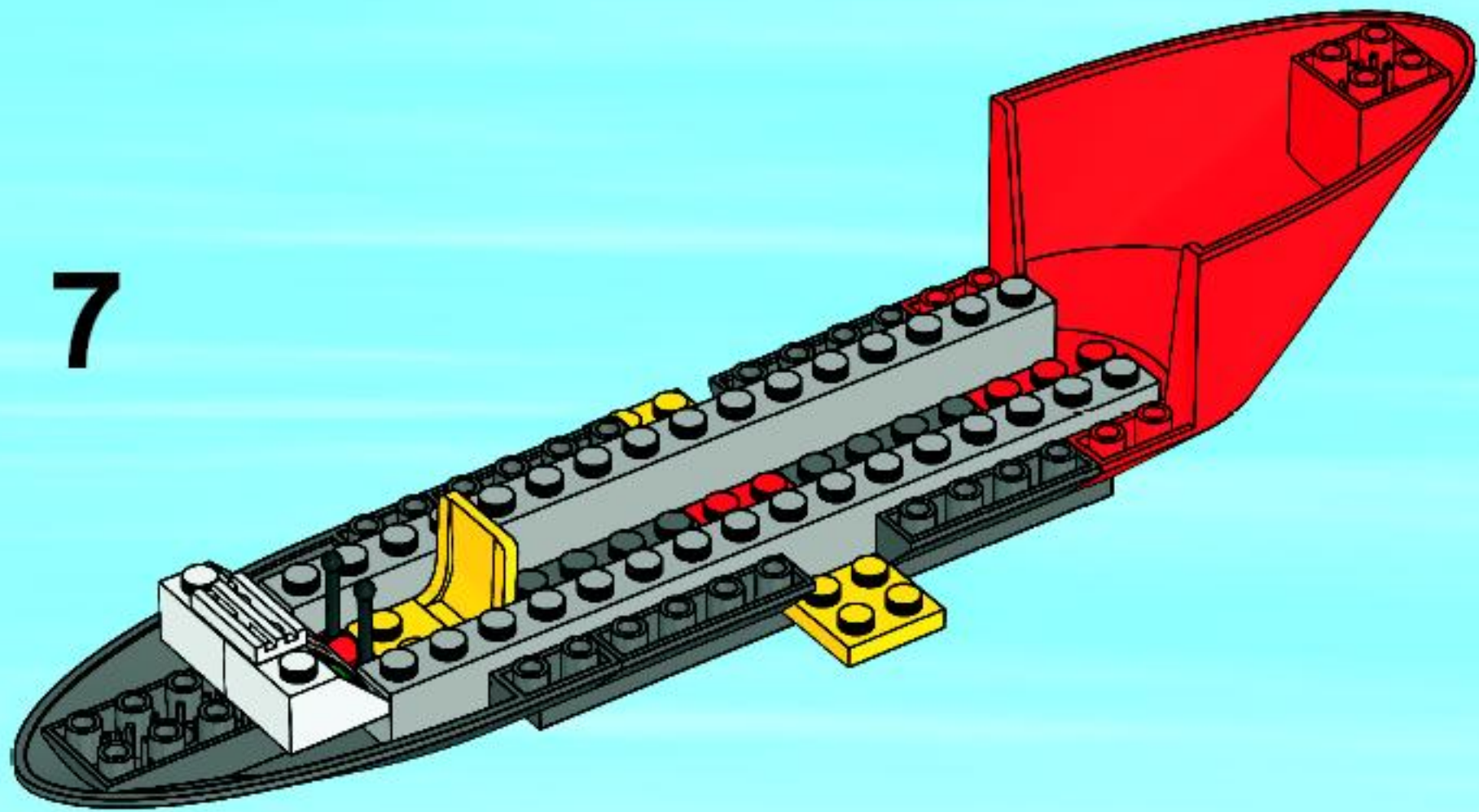

8

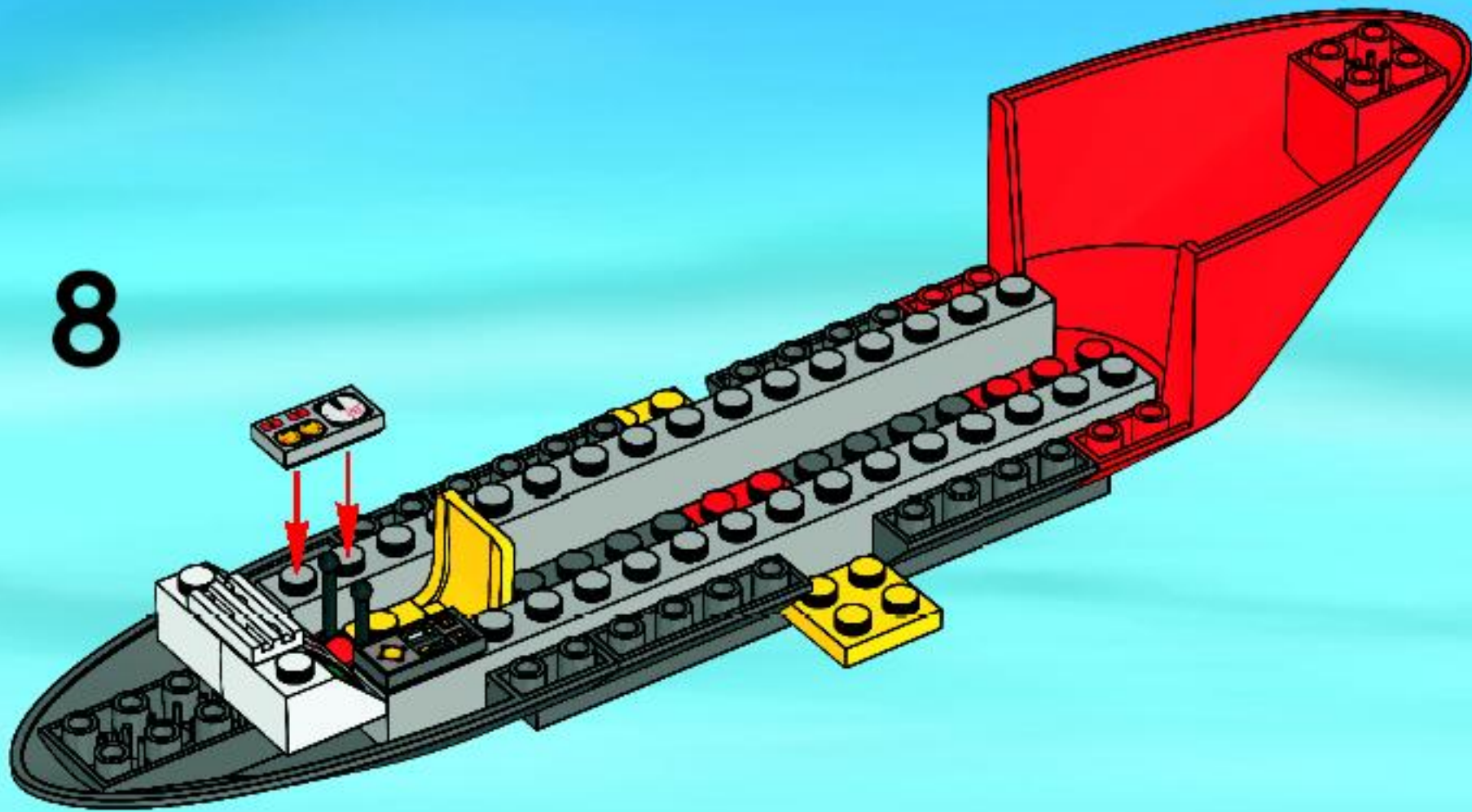

9

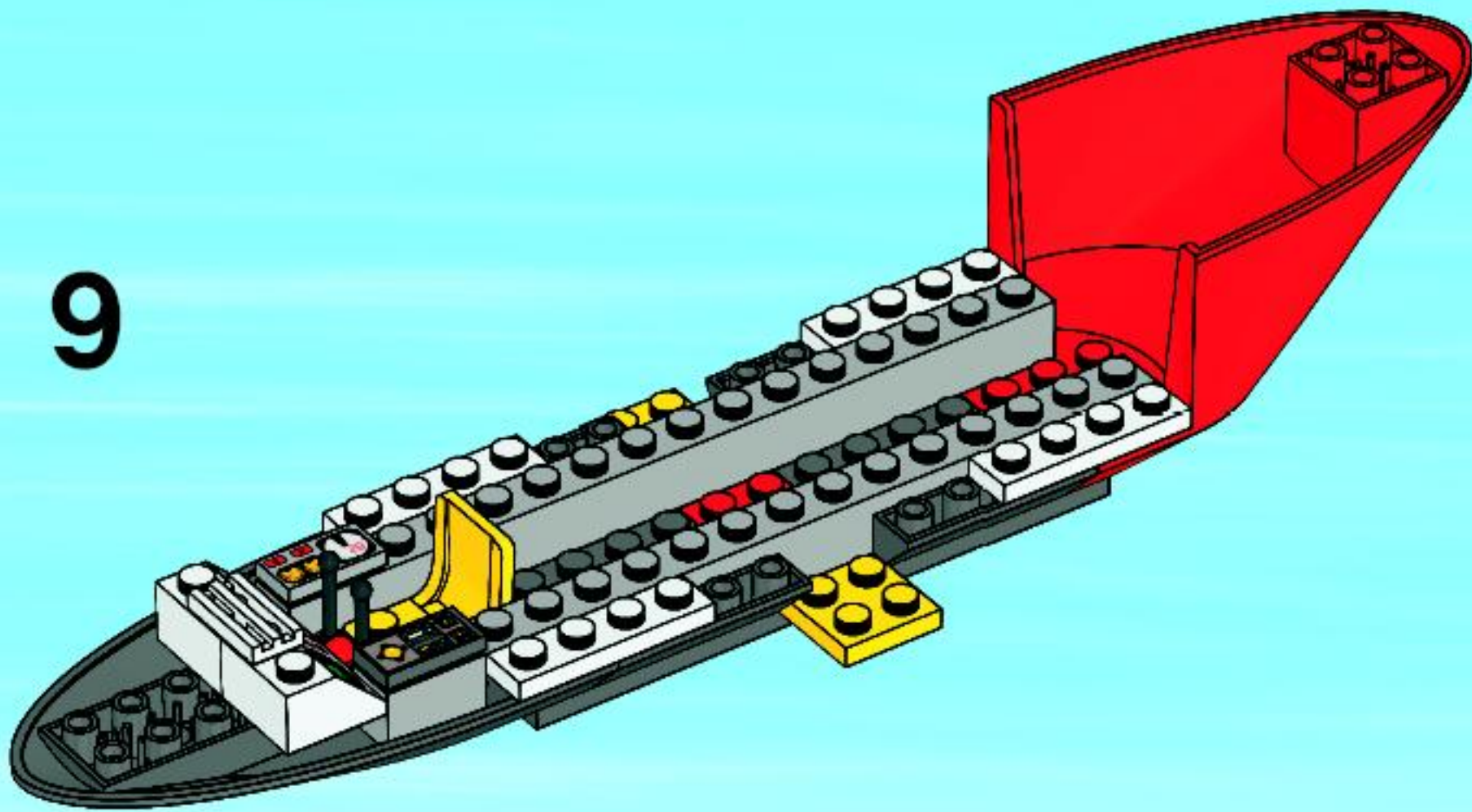

10

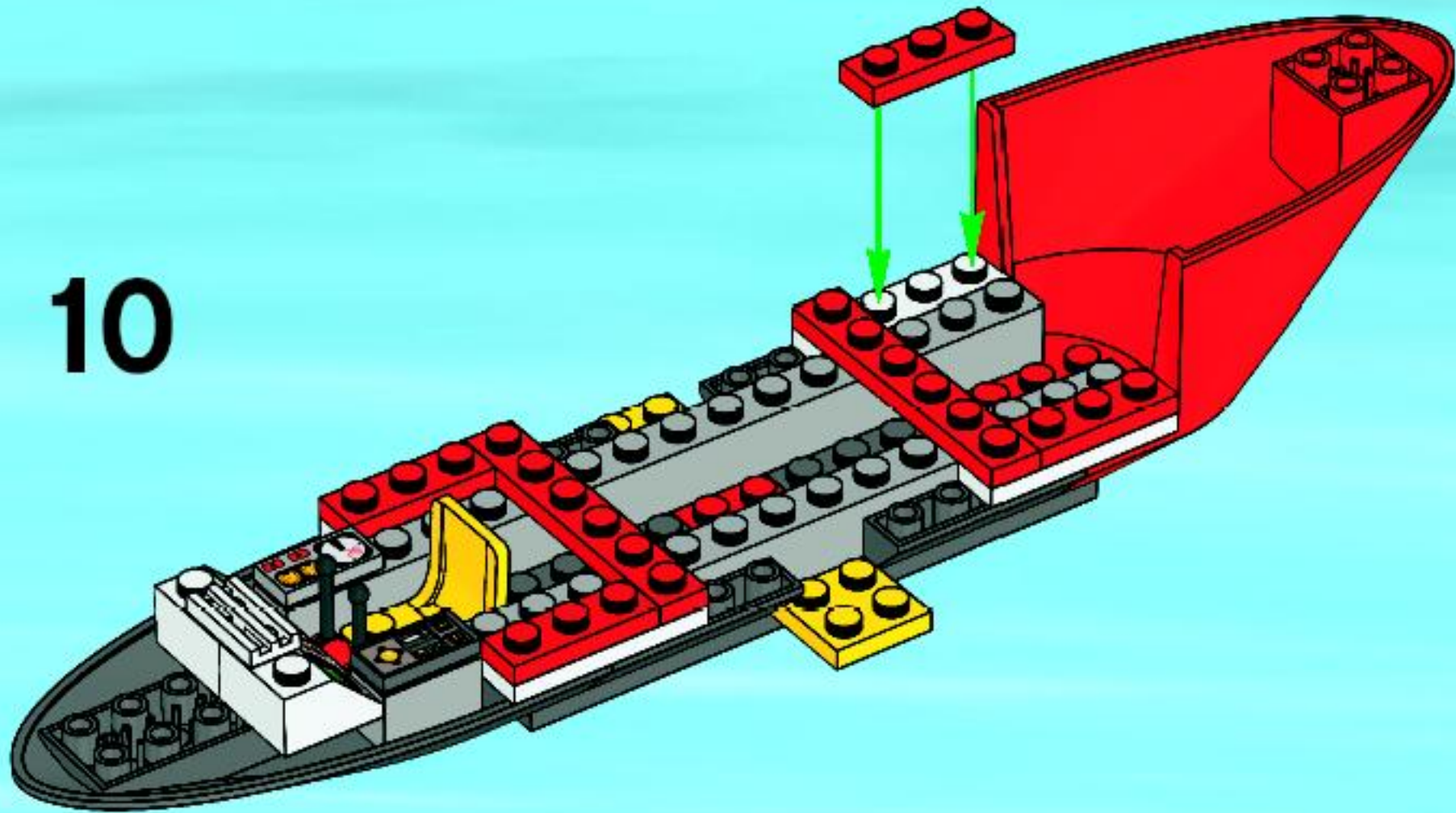

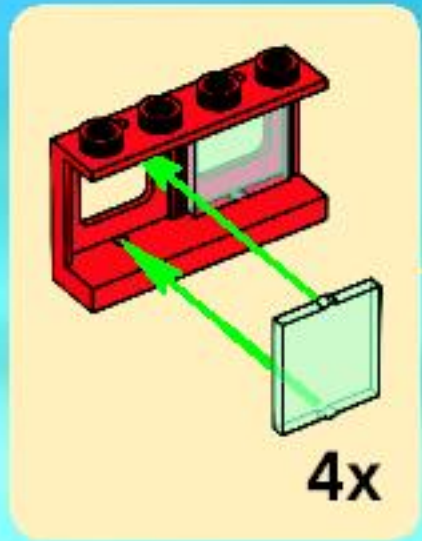

11

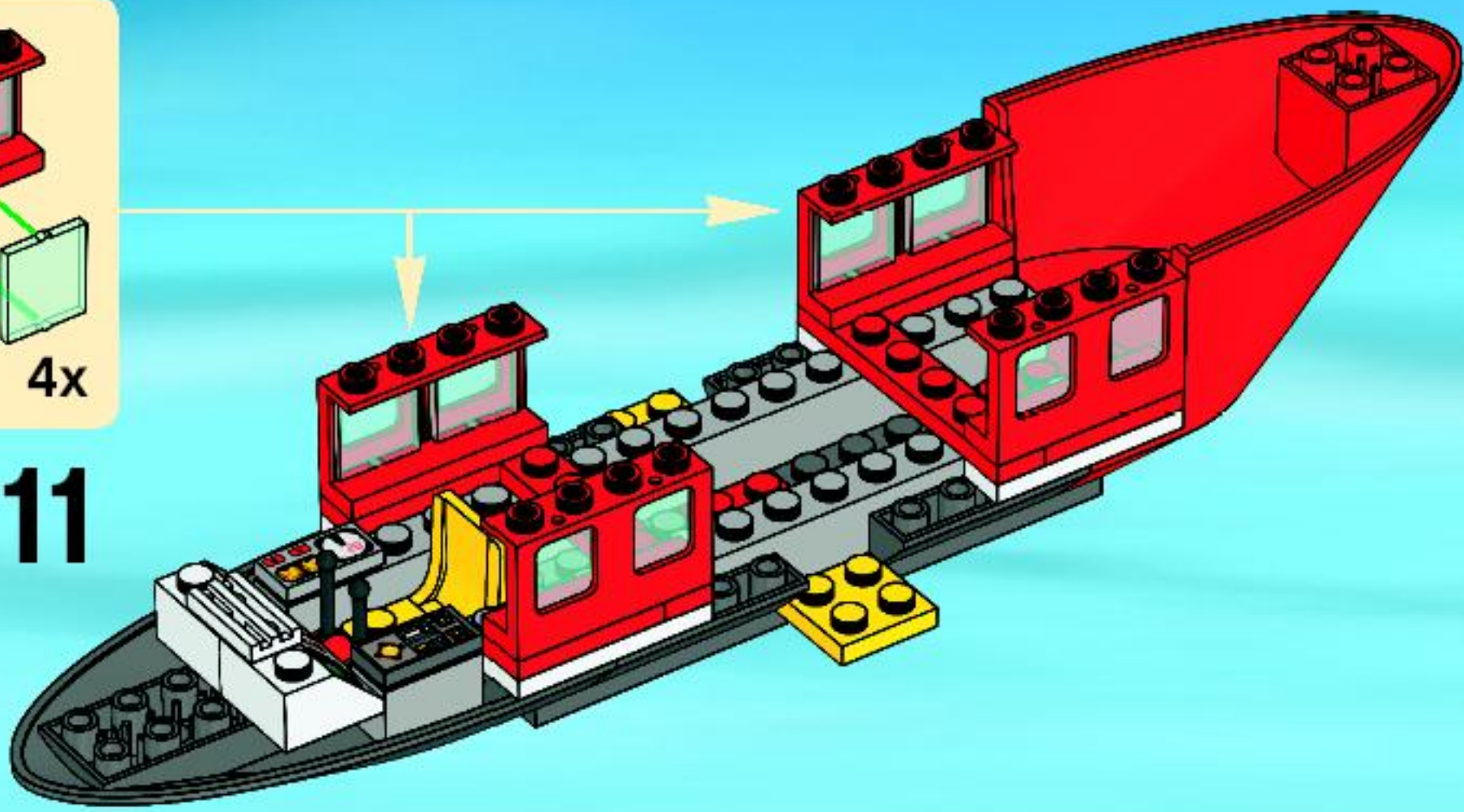

12

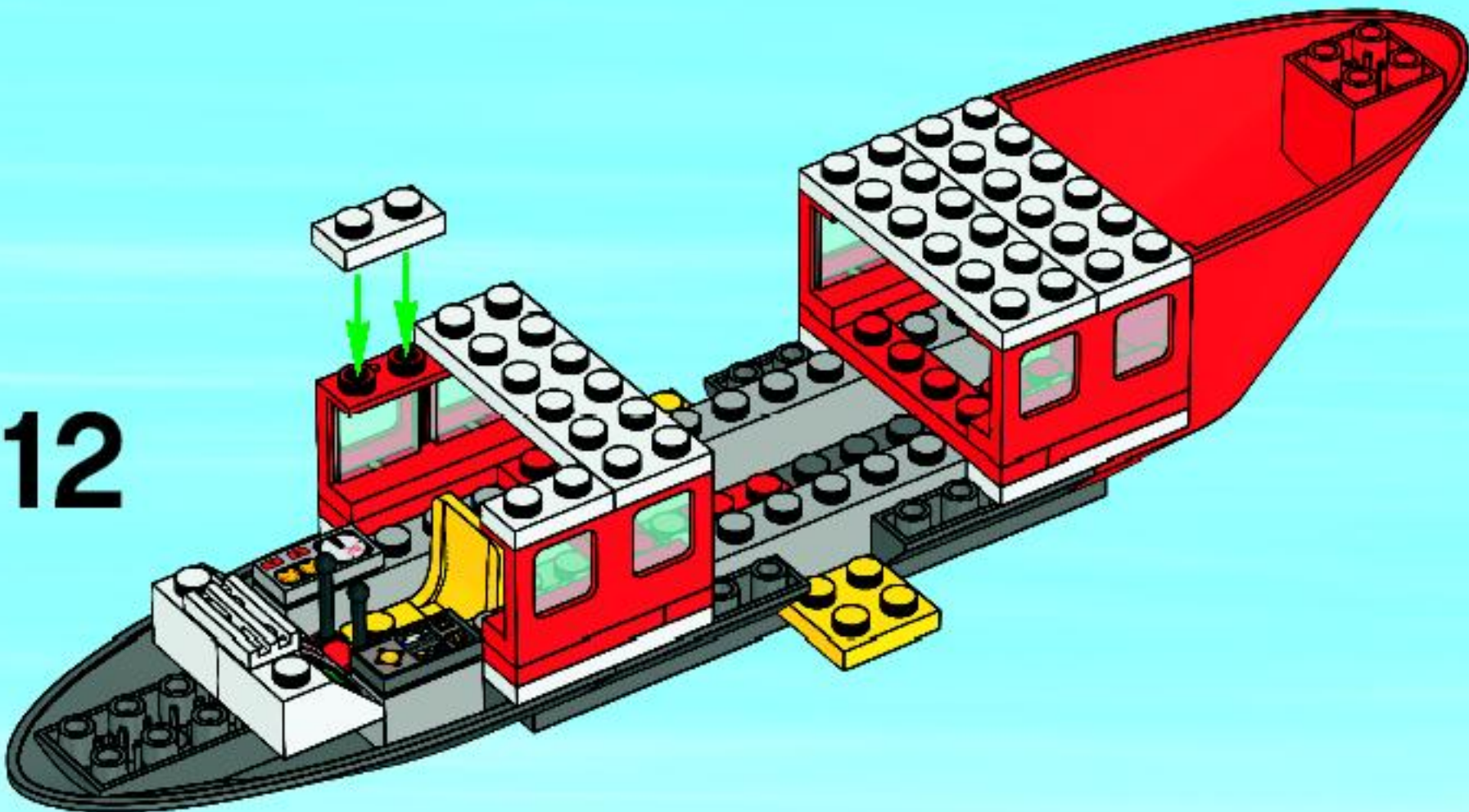

13

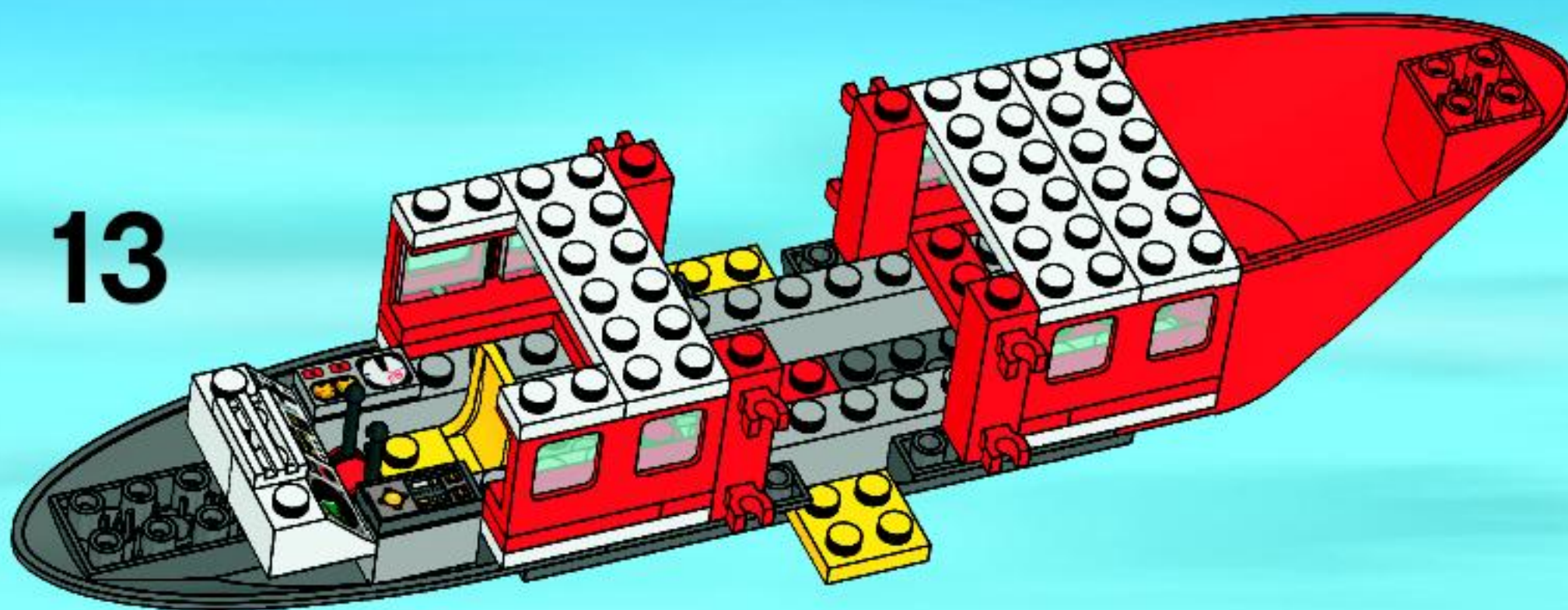

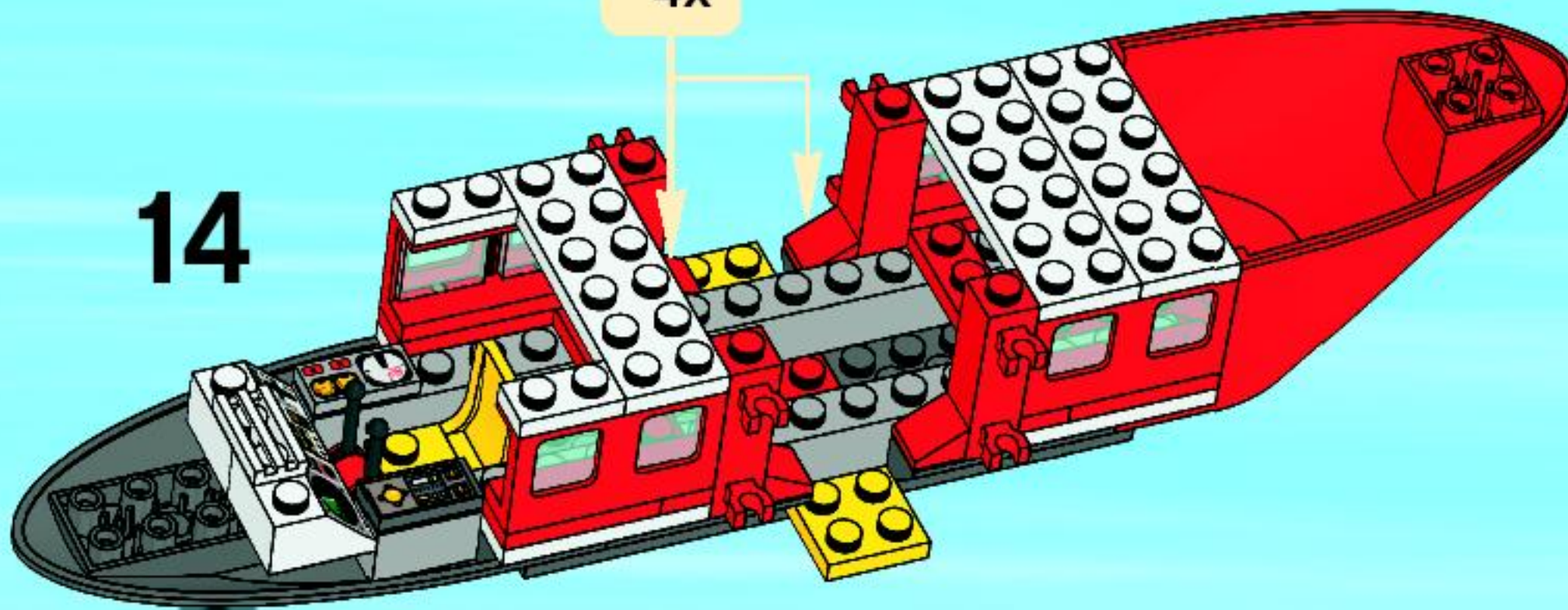

4x

14



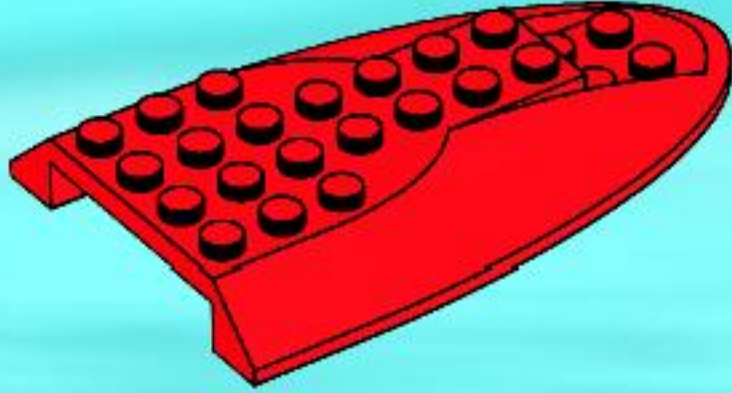

1



2

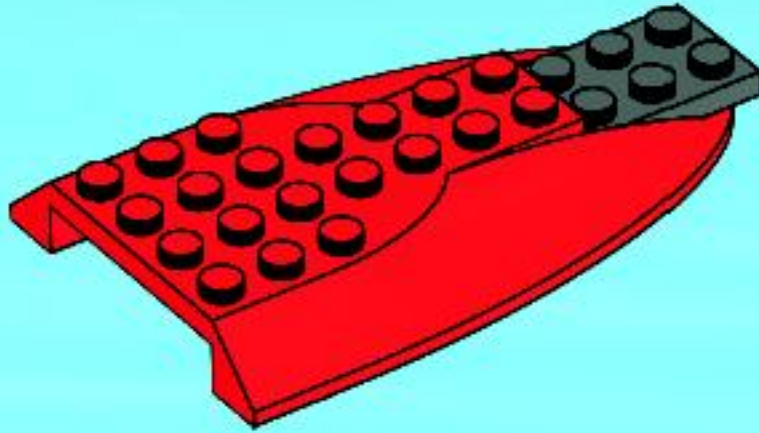

3

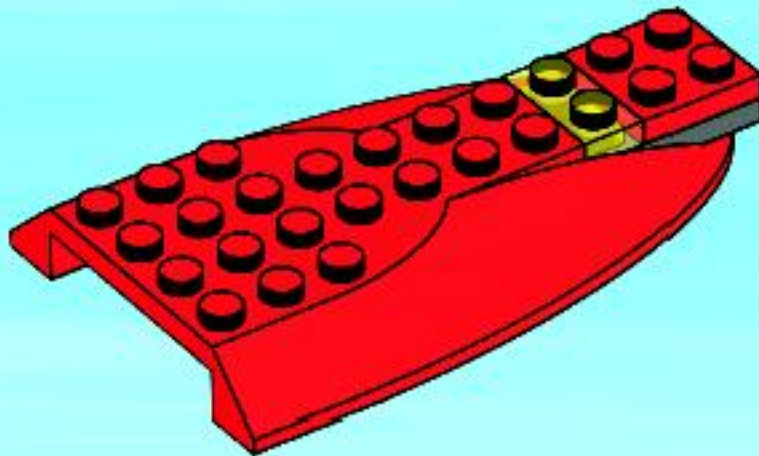

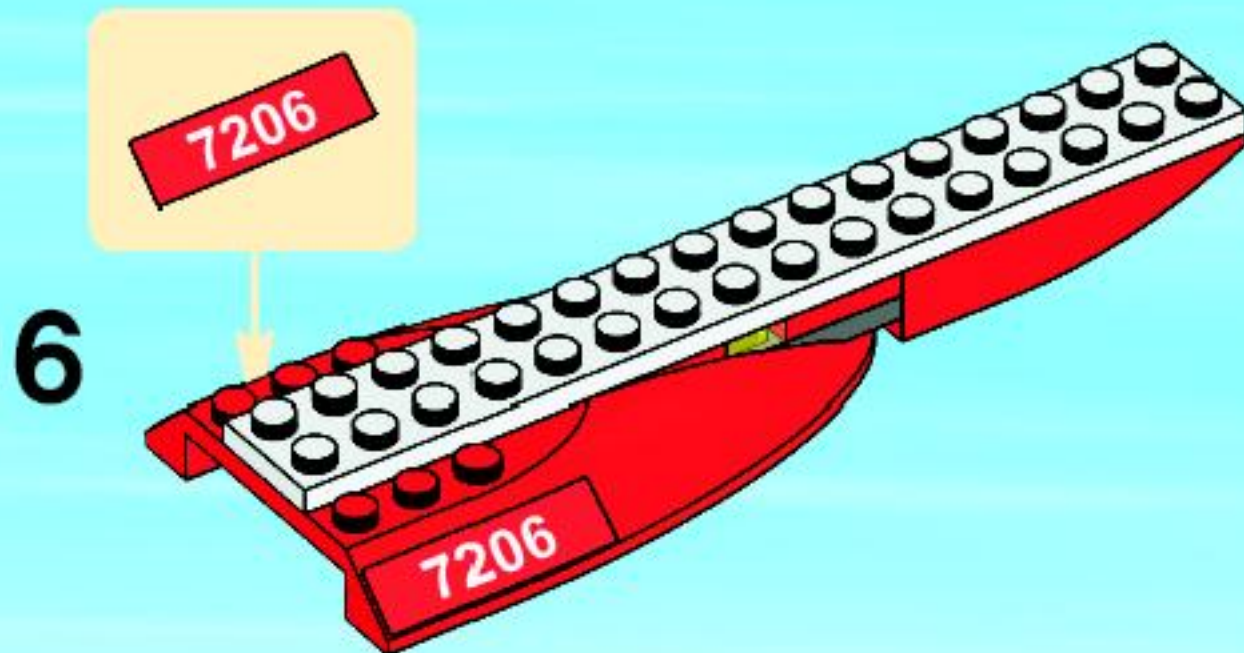
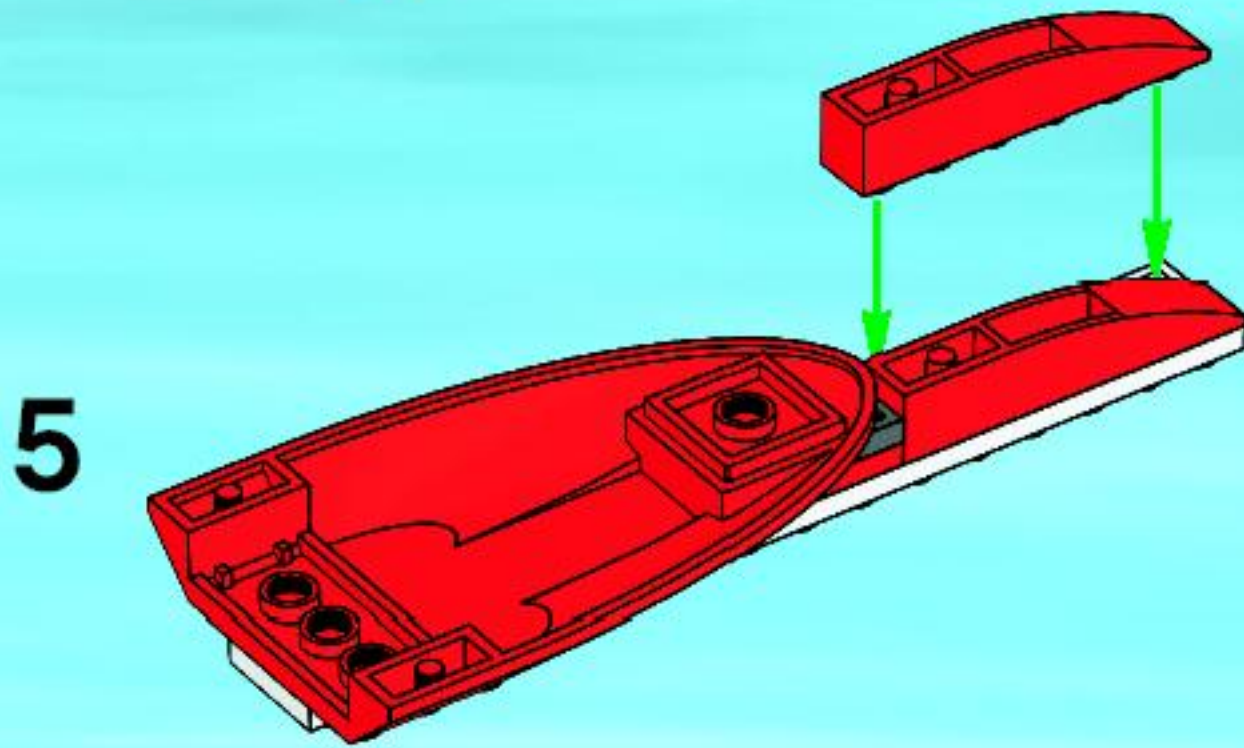
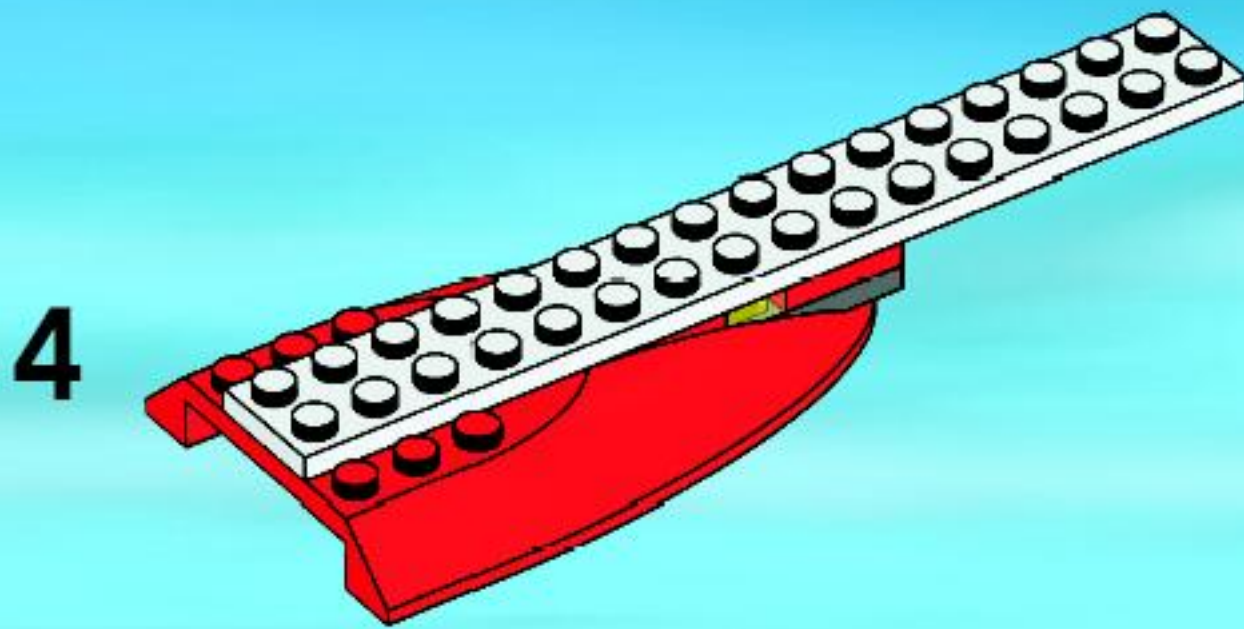

15

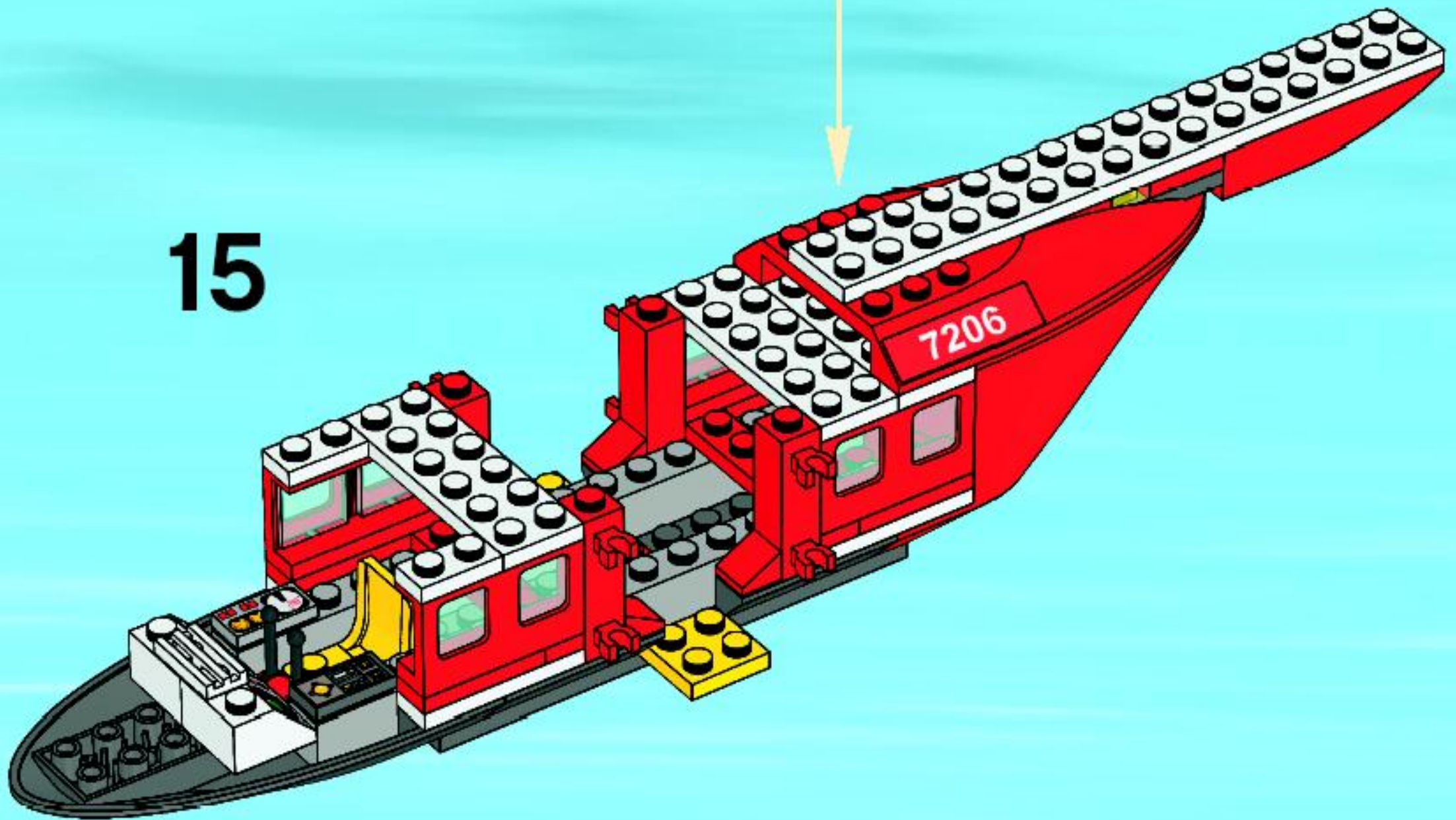

16

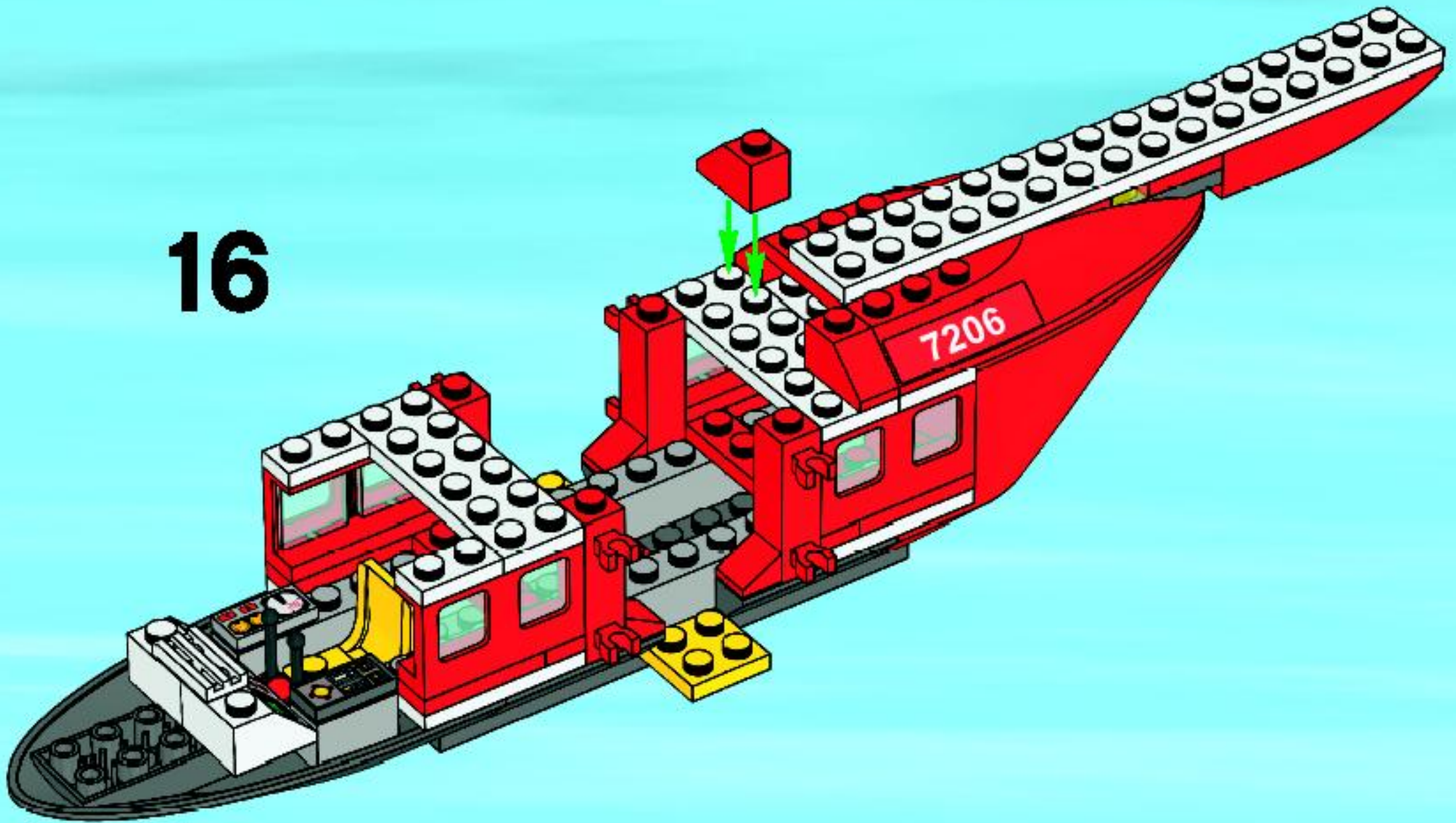

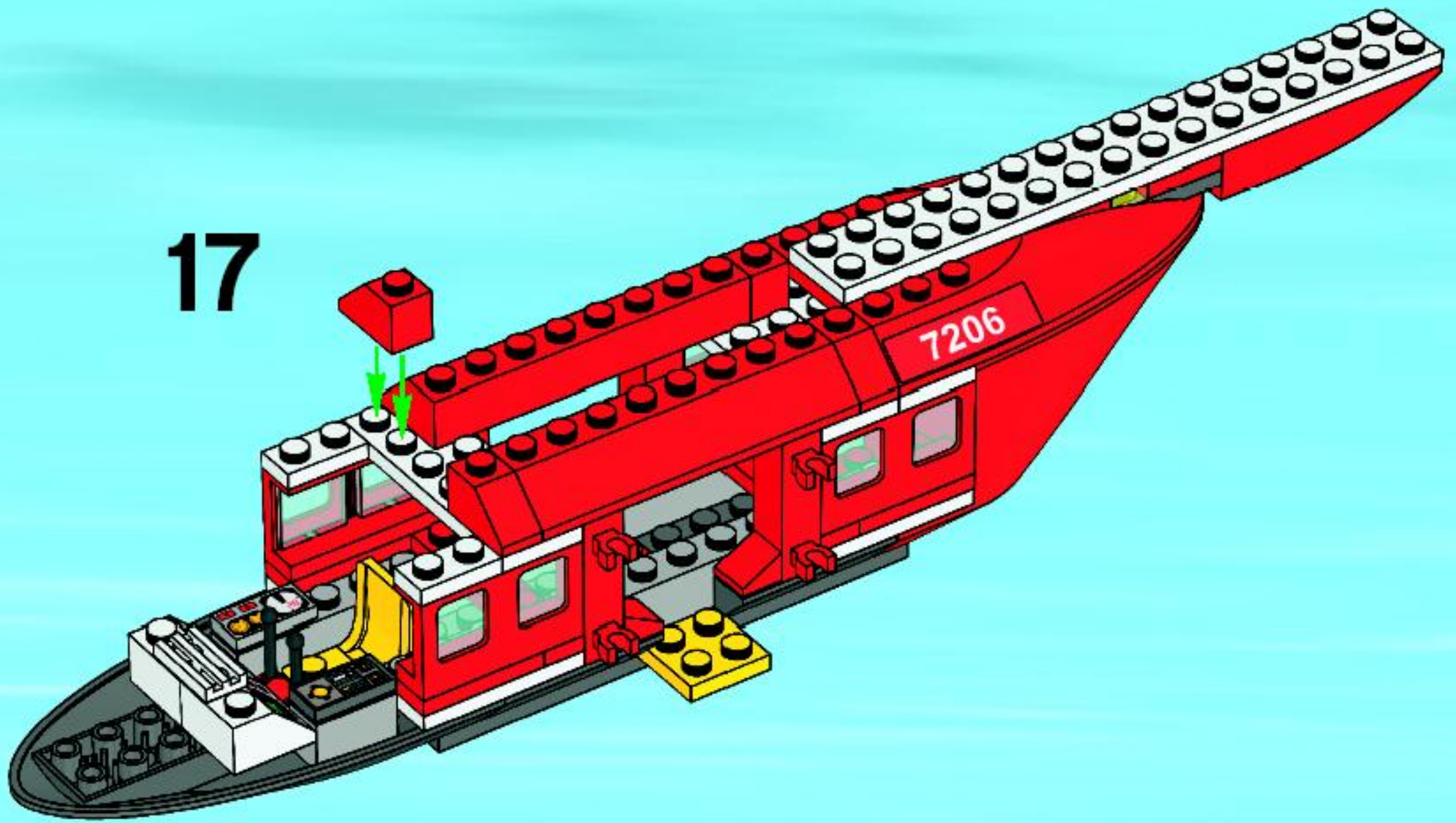

17

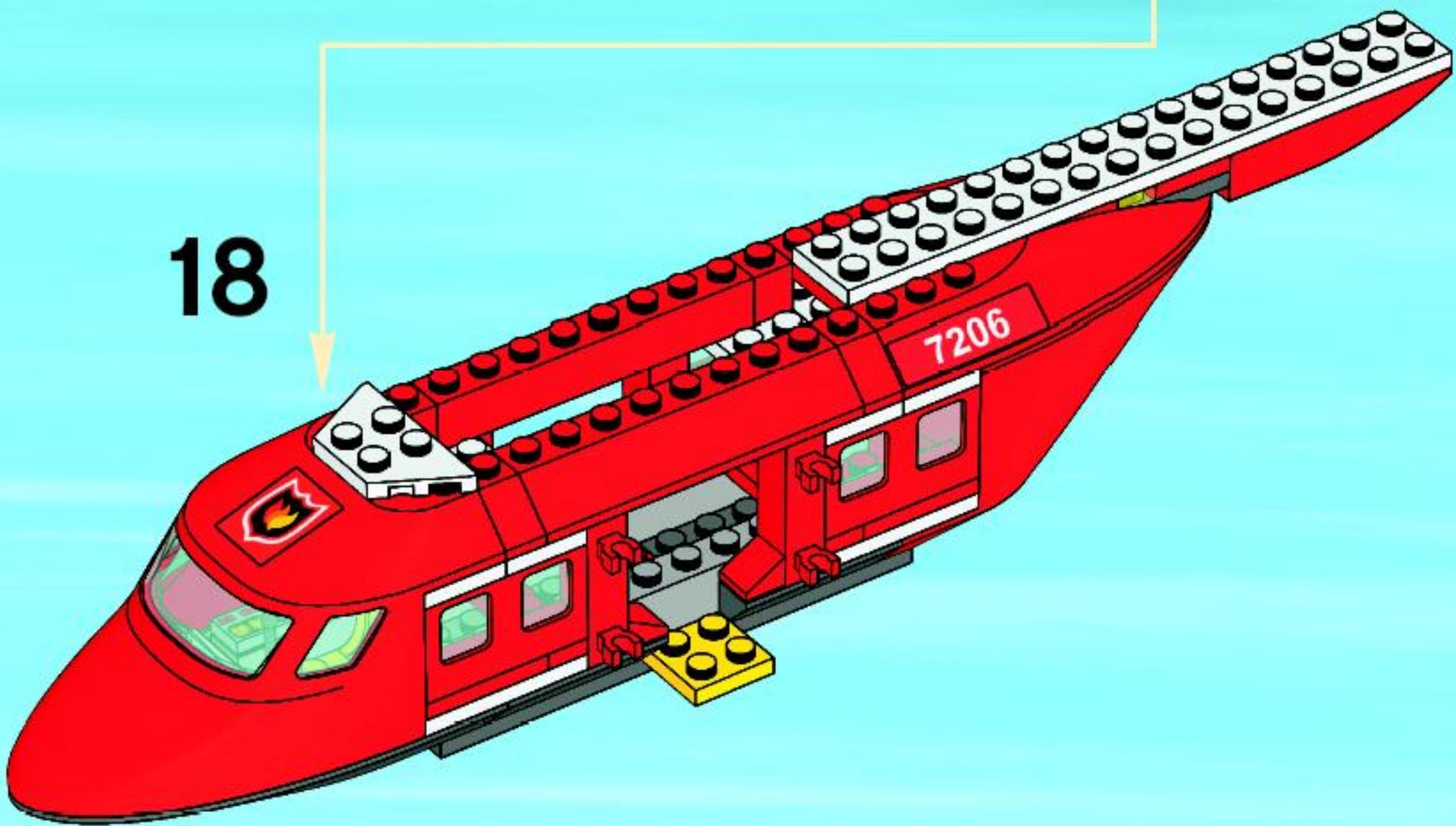
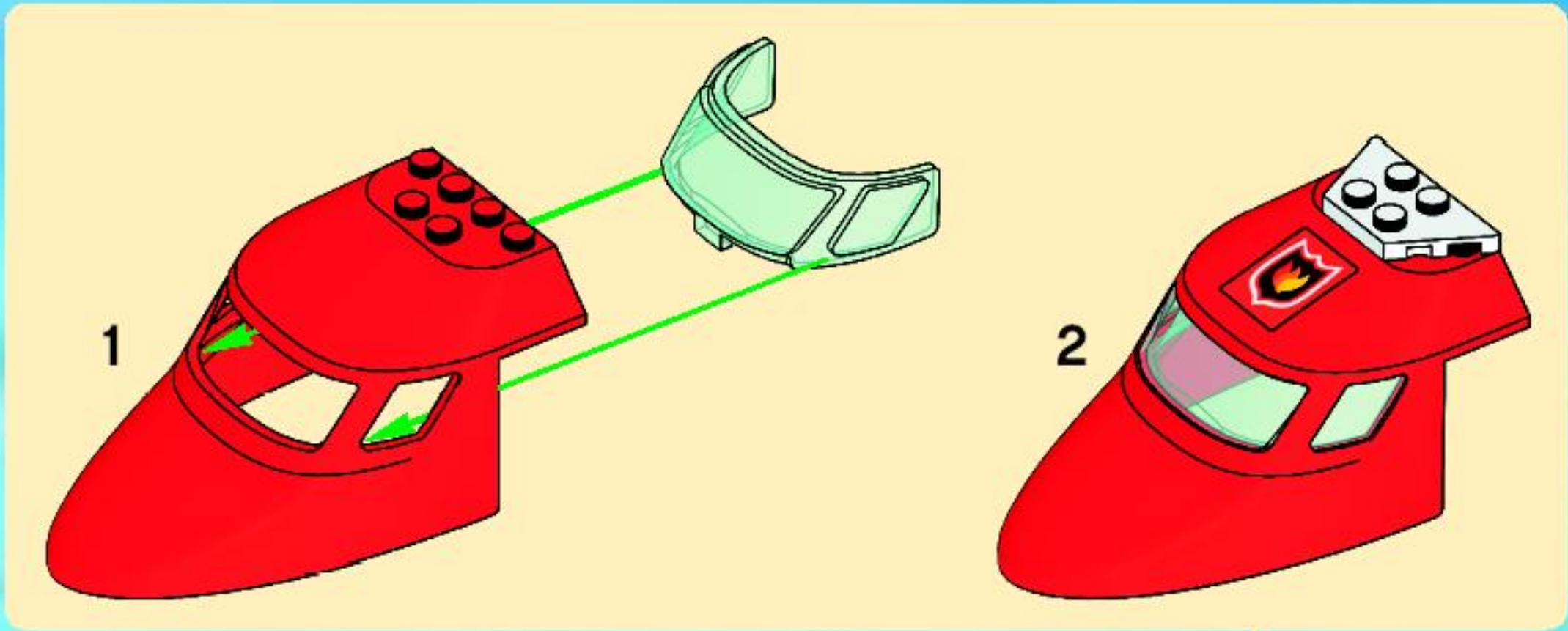

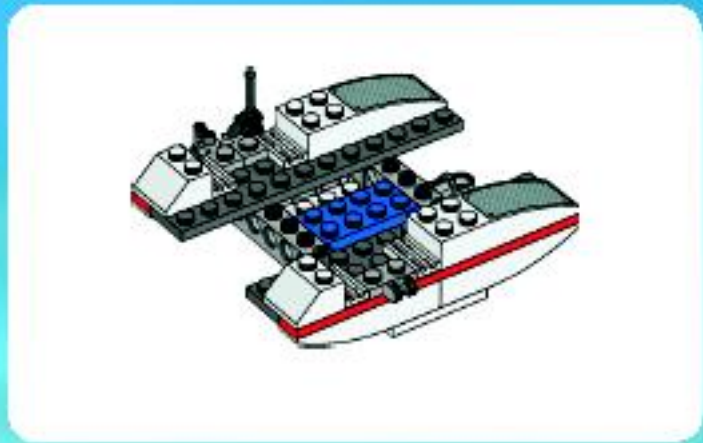

1

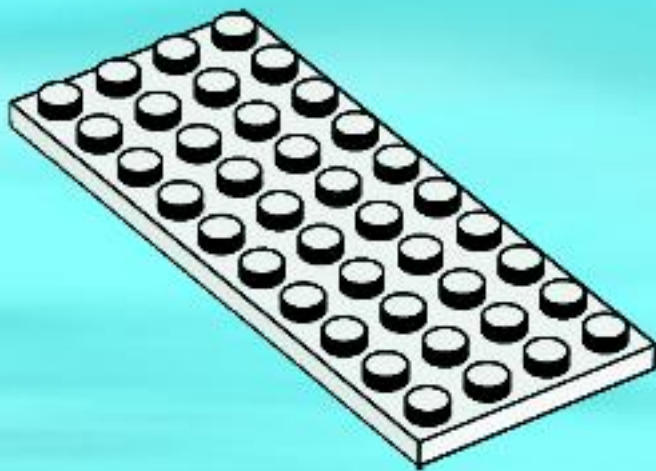

2

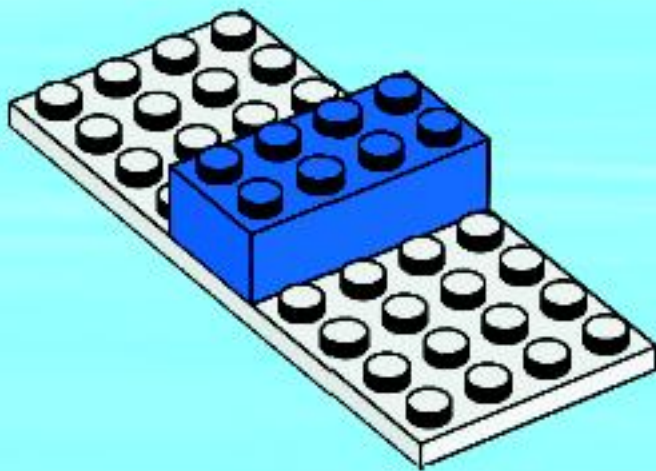

3

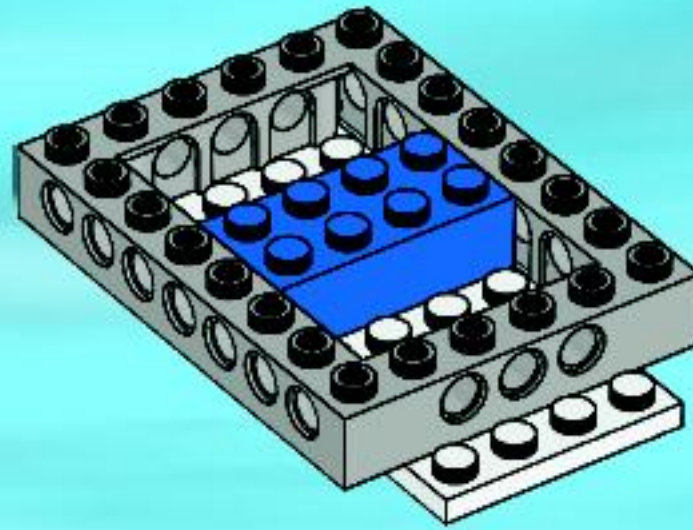

4

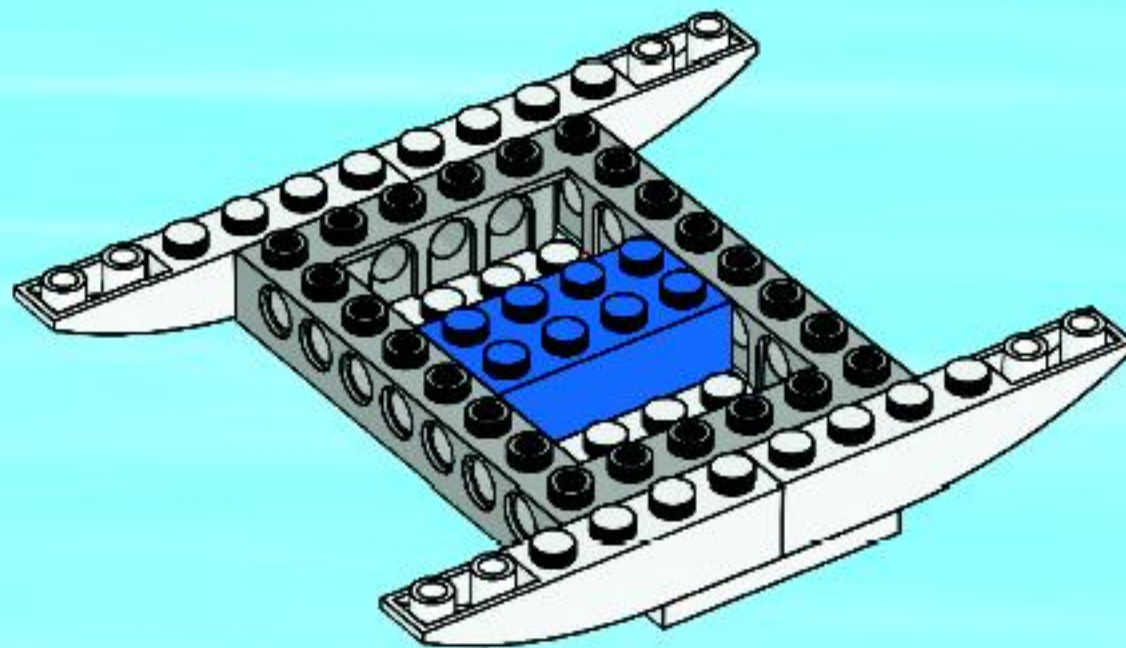

5

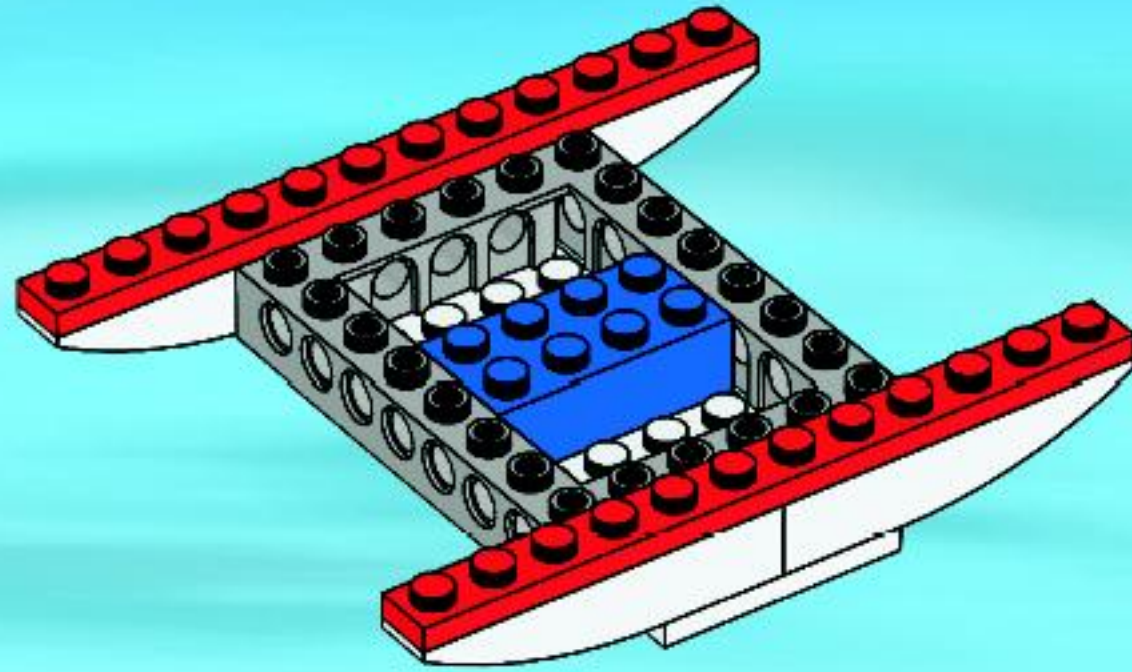

6

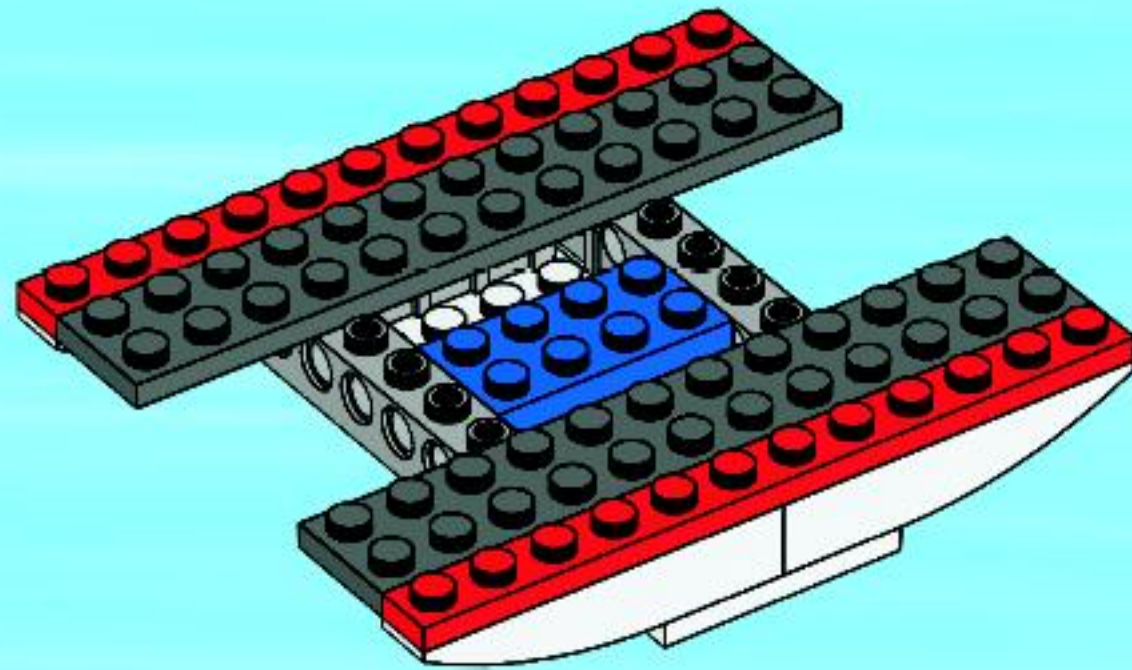

7

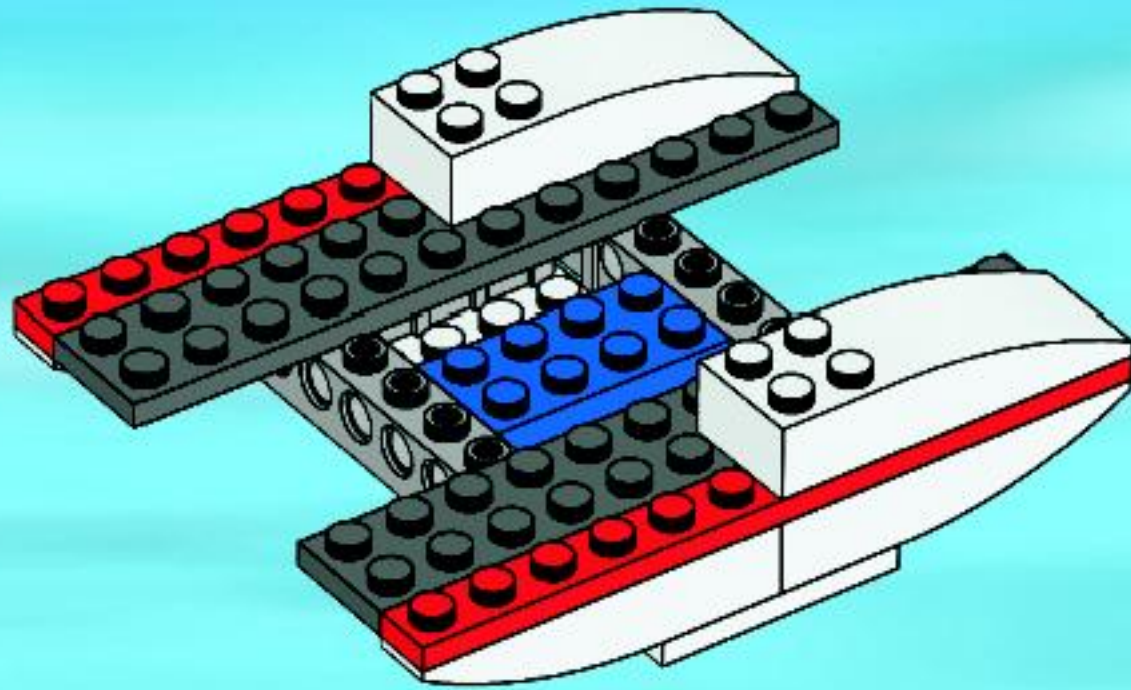

8

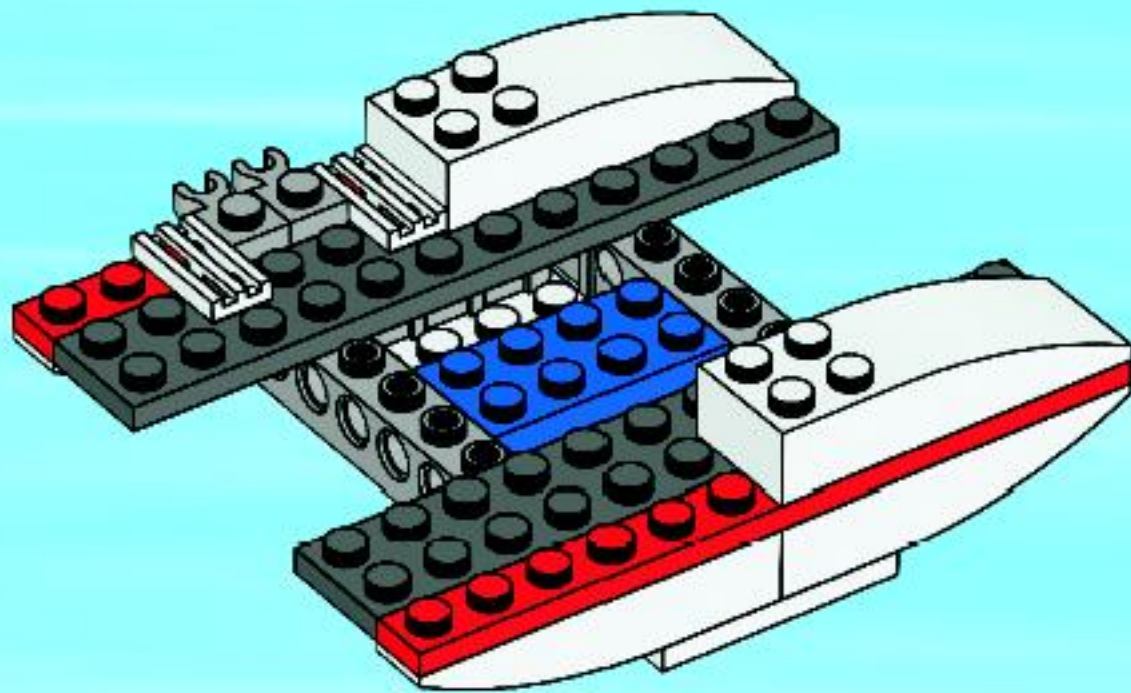

9

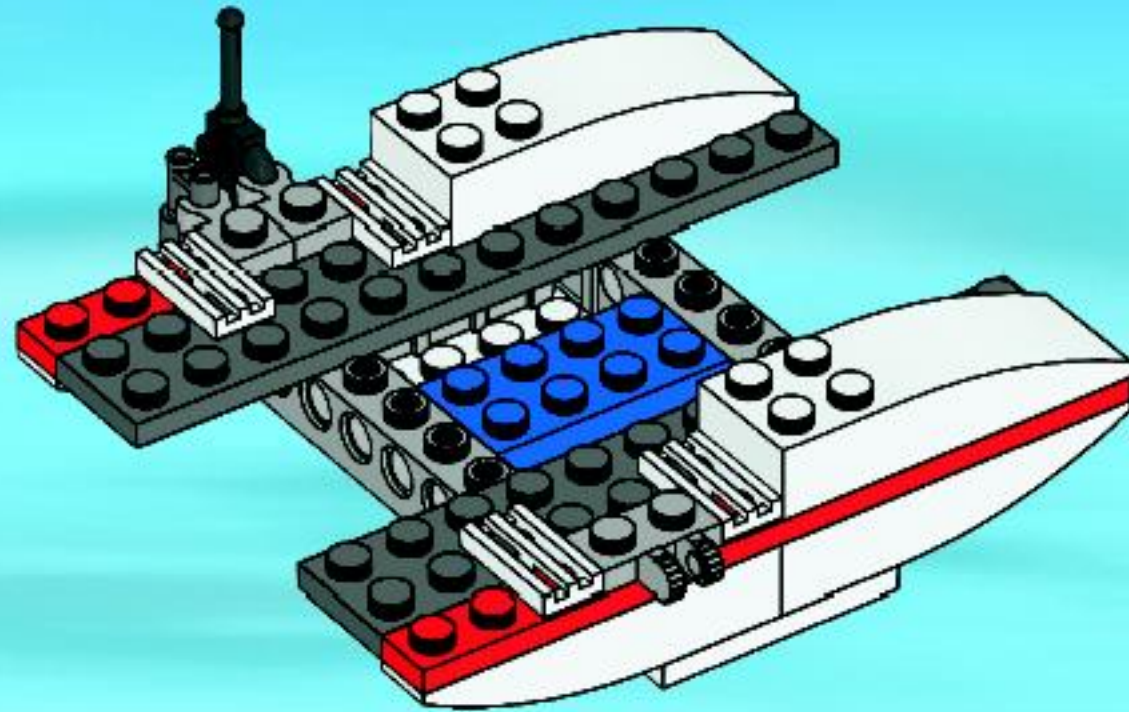

10

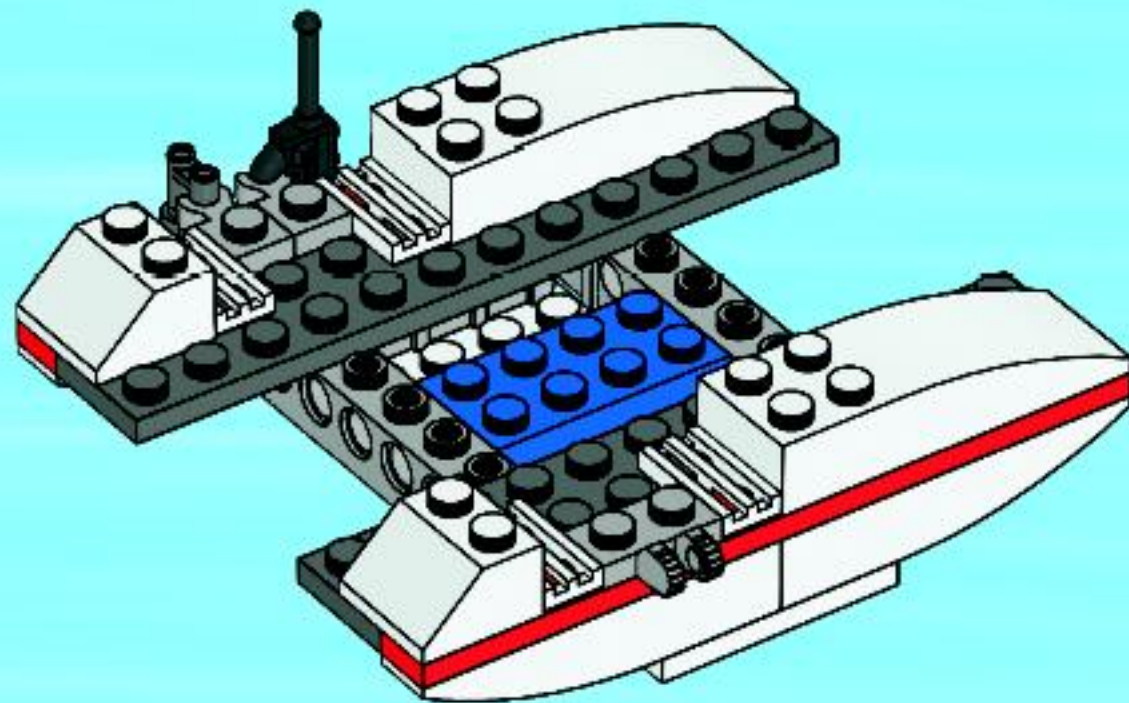

11

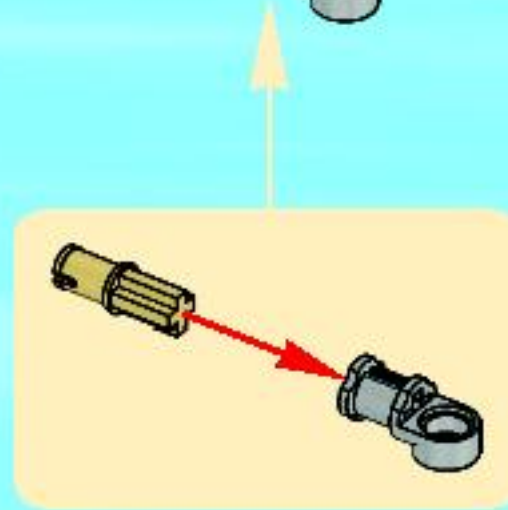
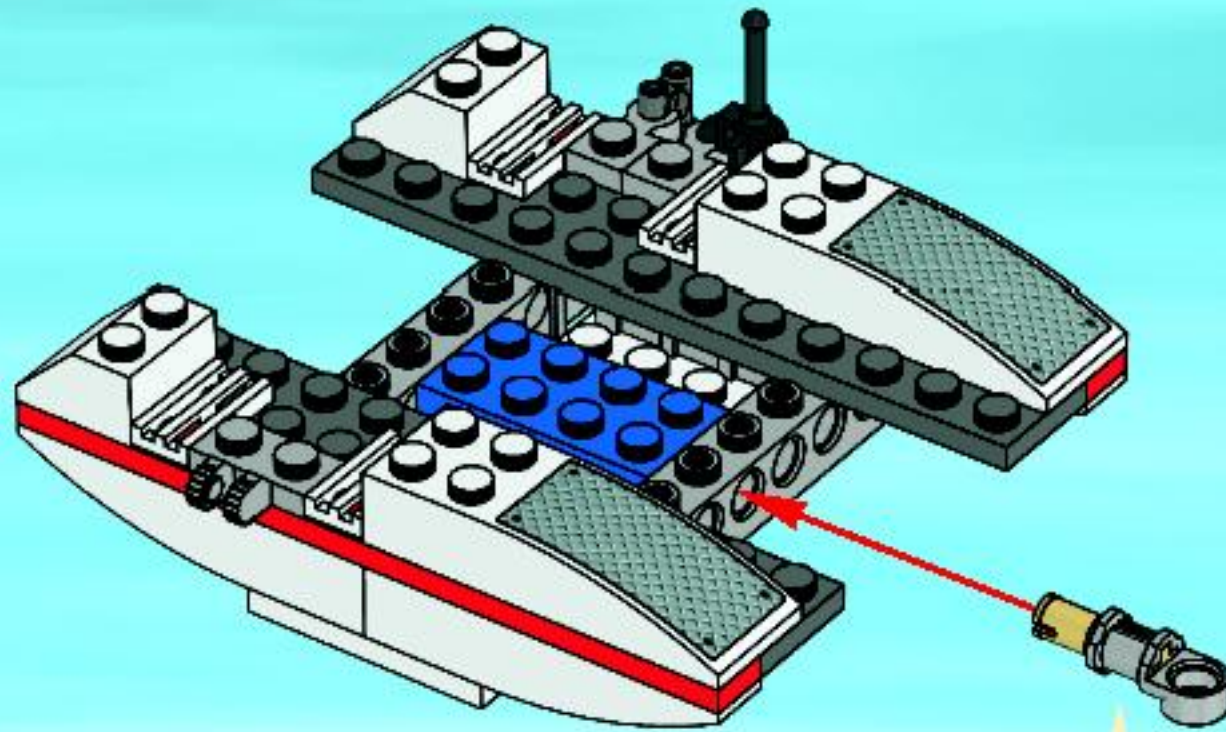

19

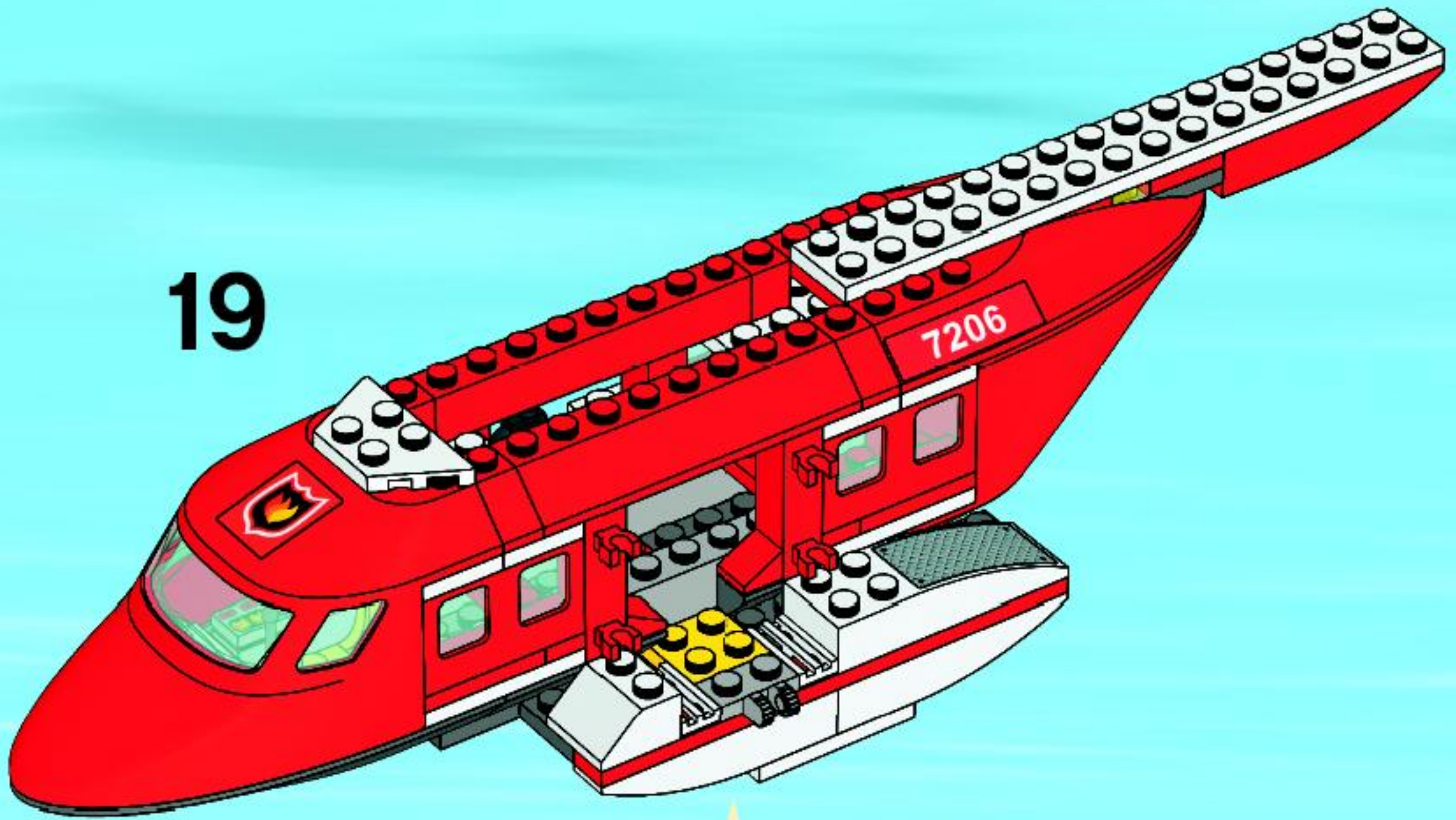

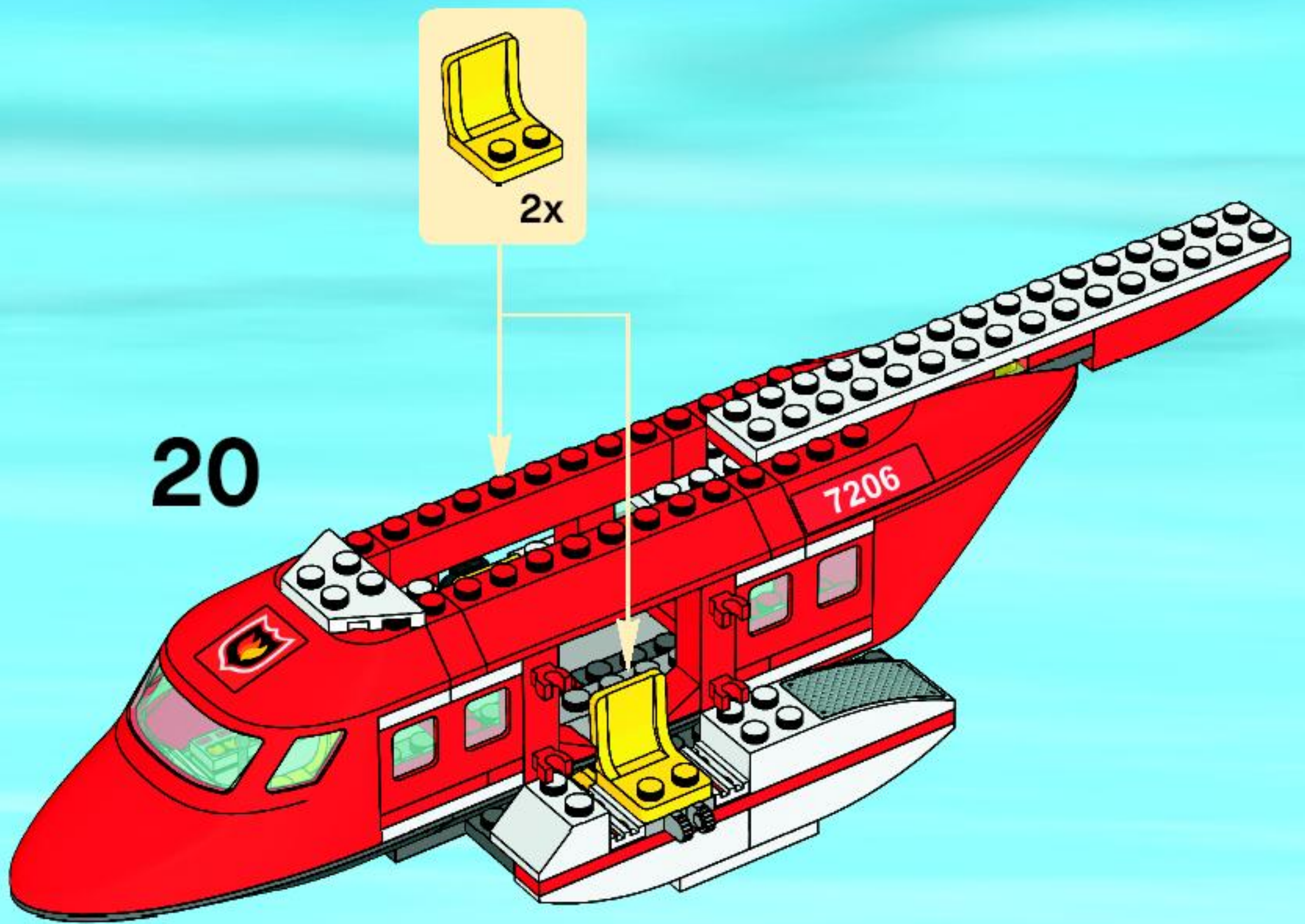

21

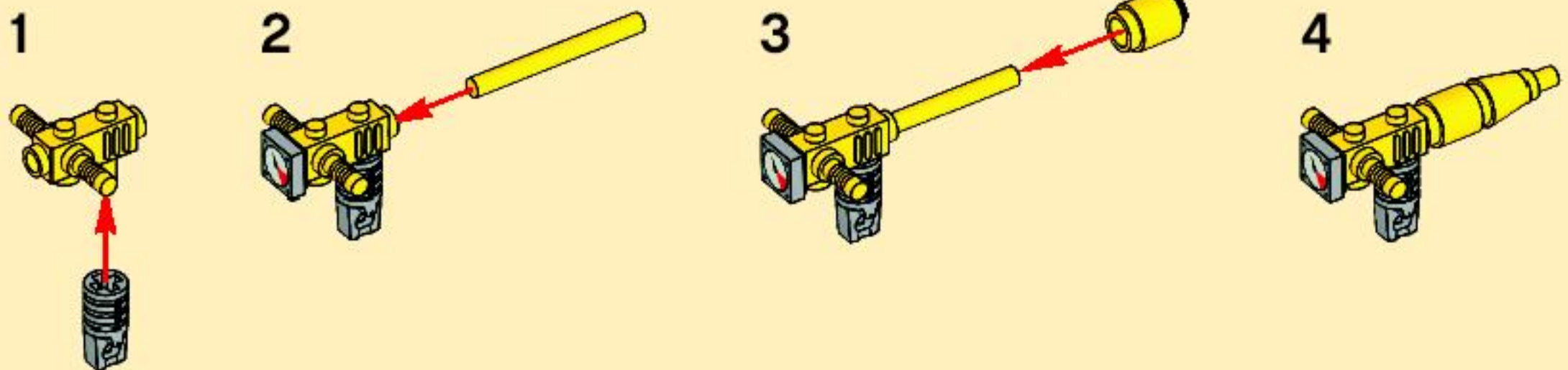
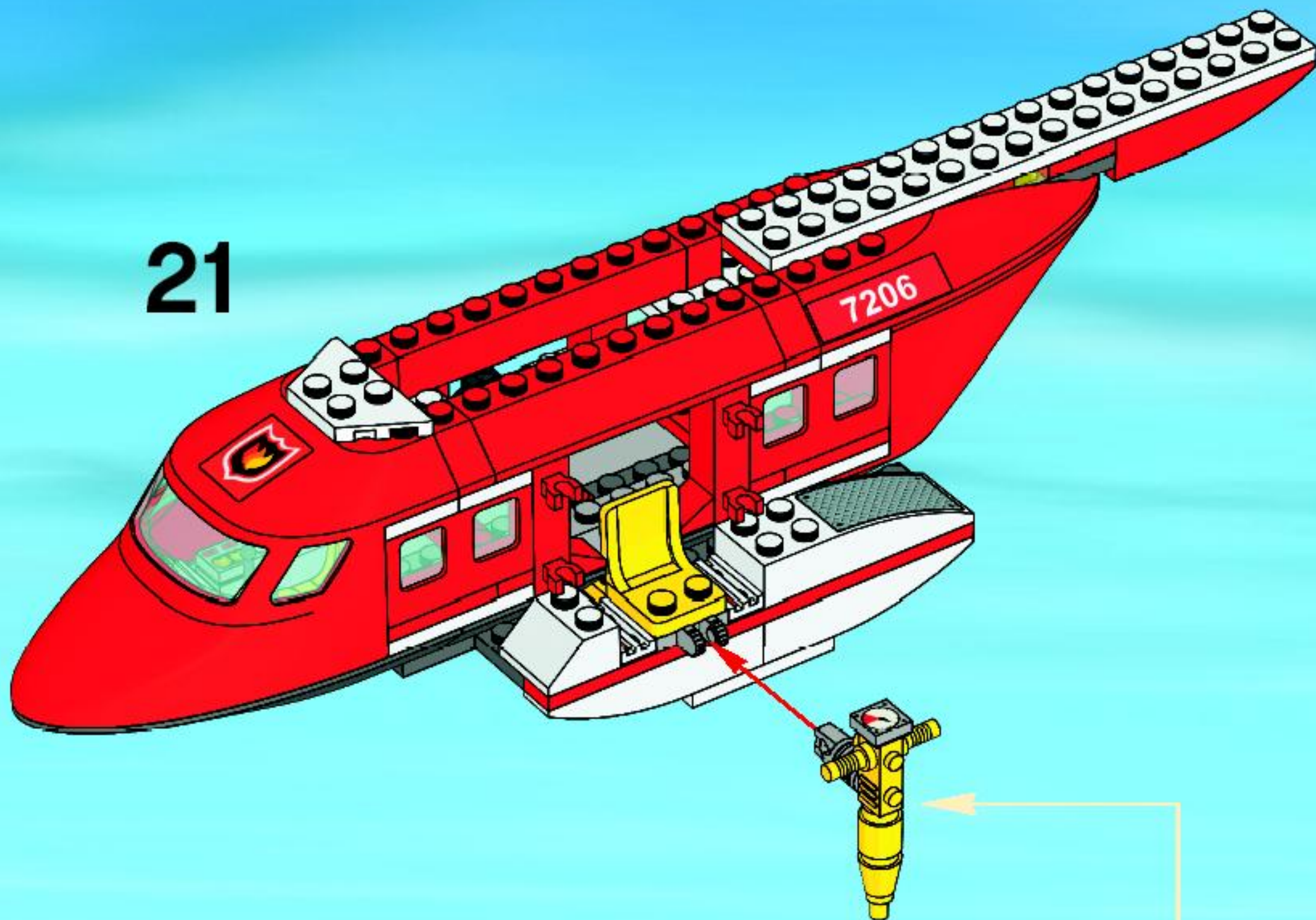

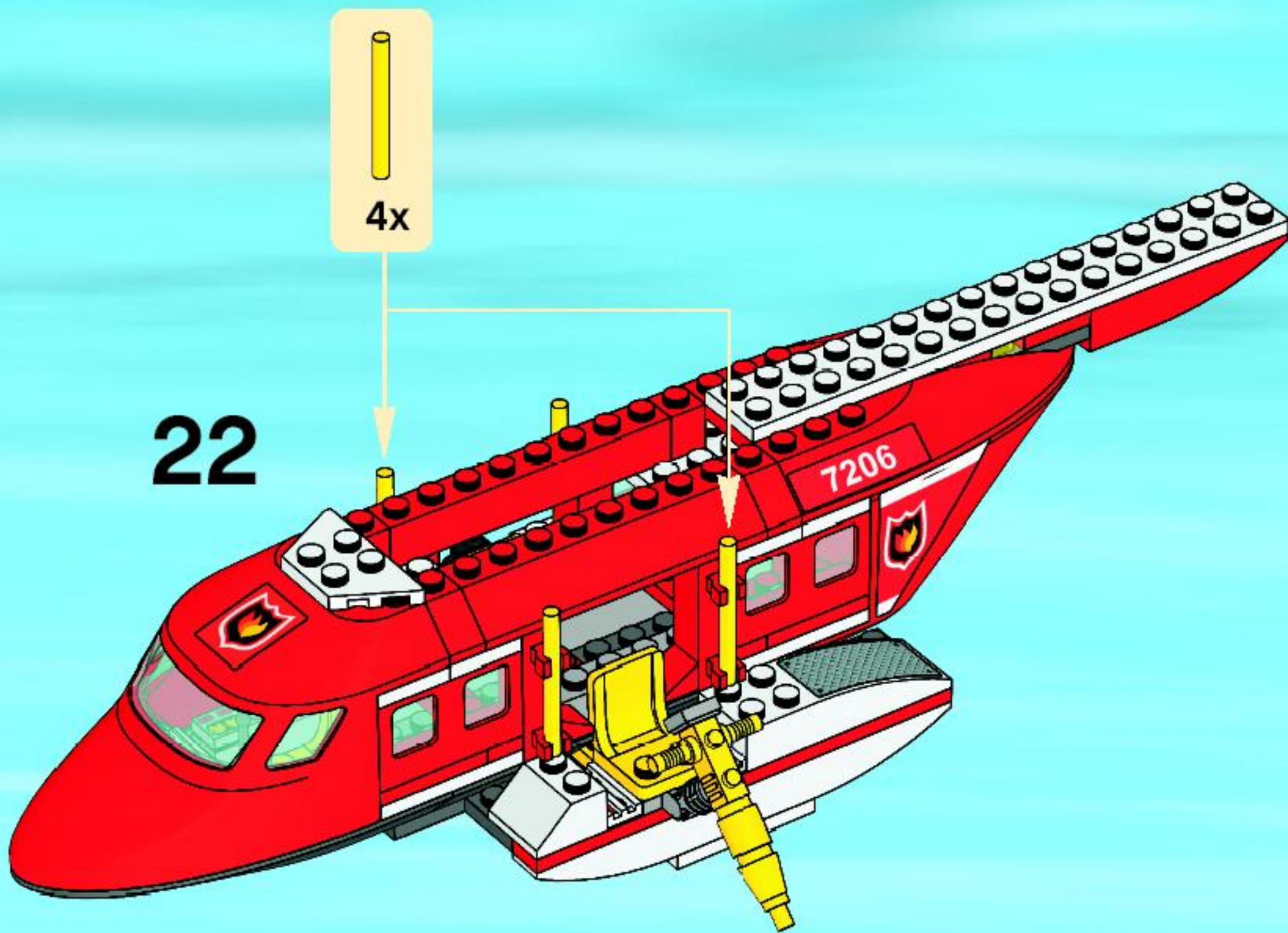

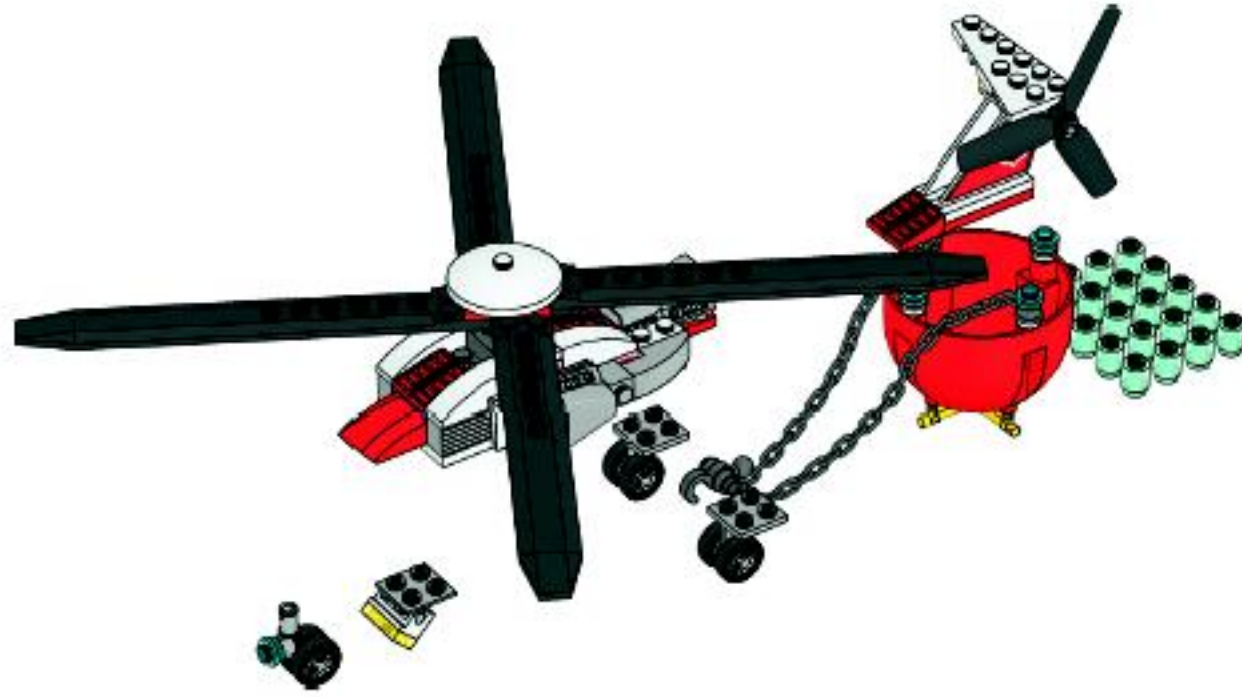

23

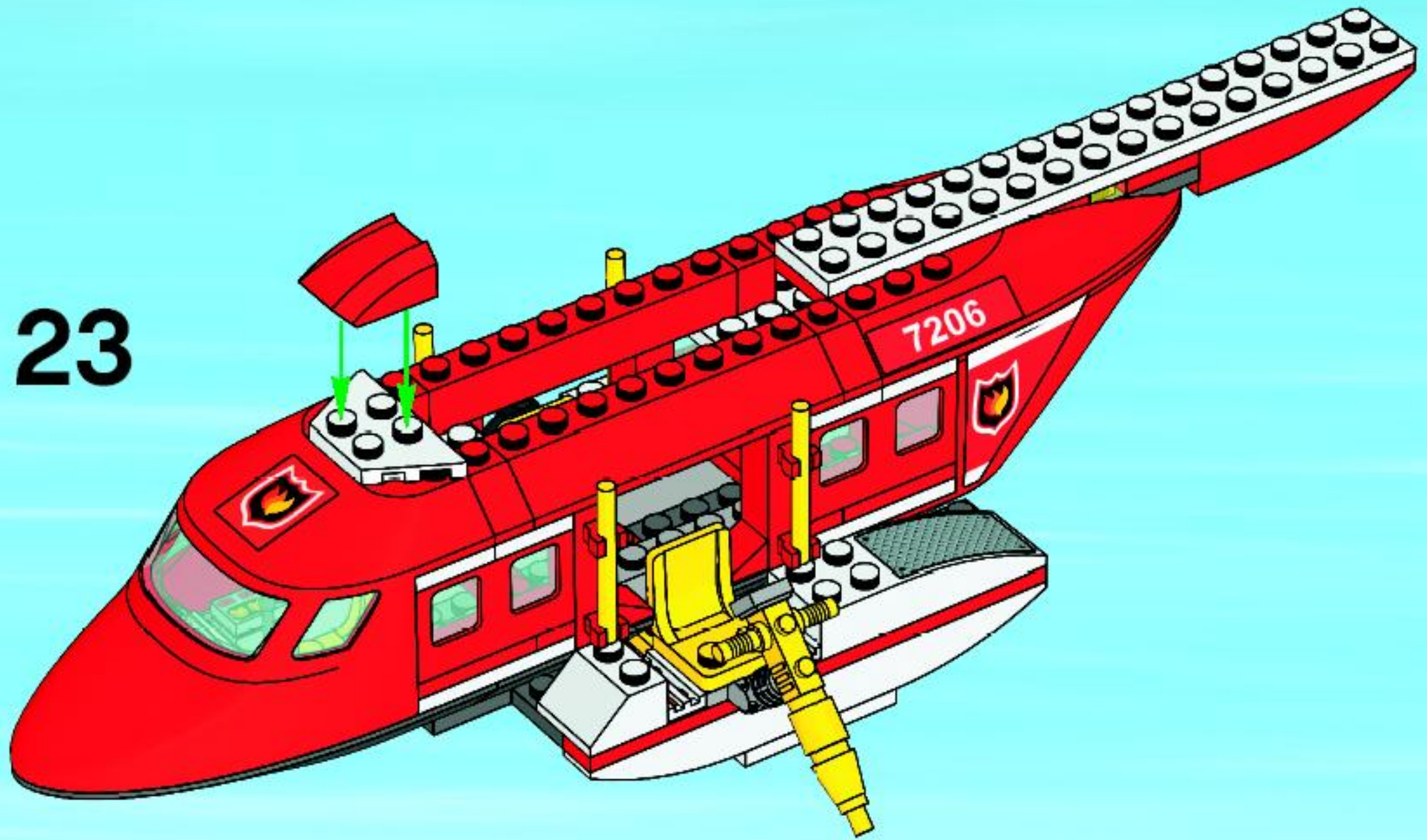

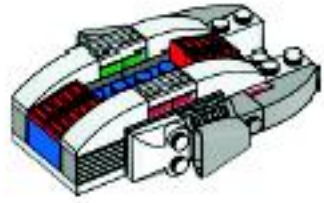

1

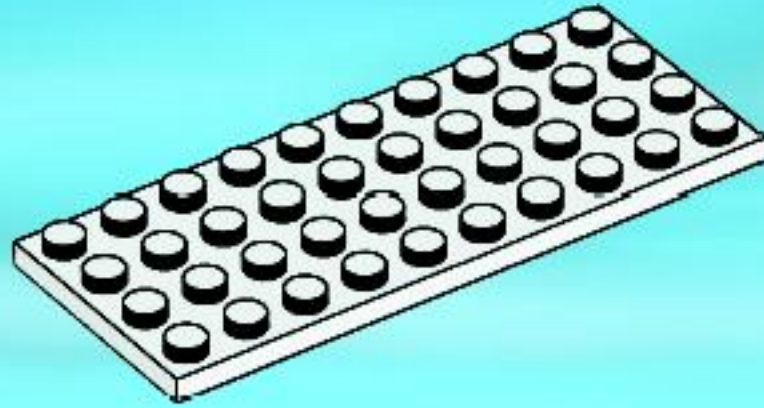

2

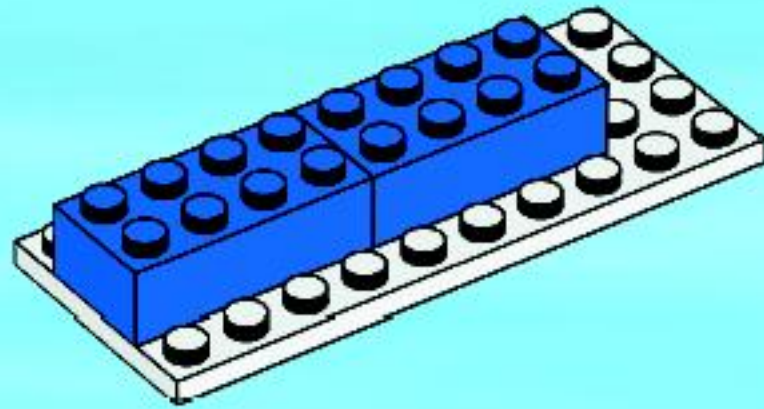

3

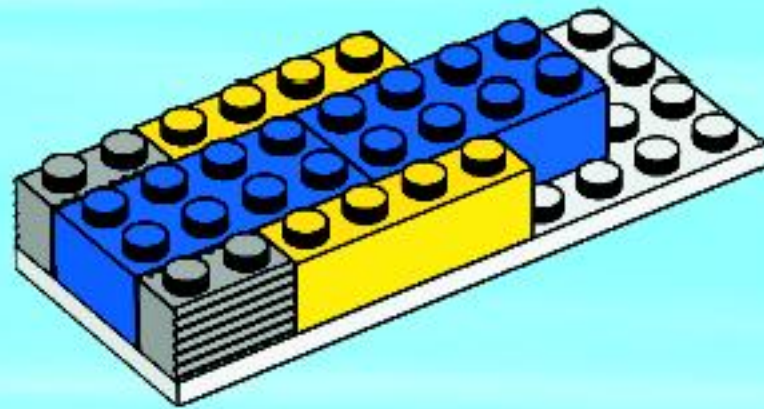

4

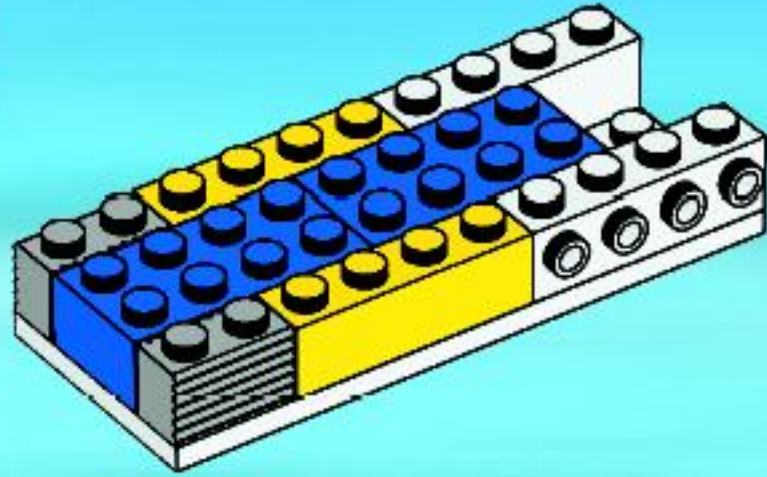

5

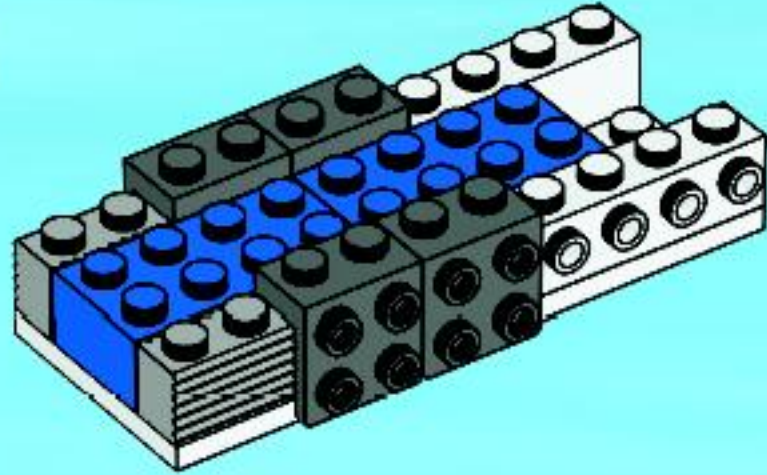

6

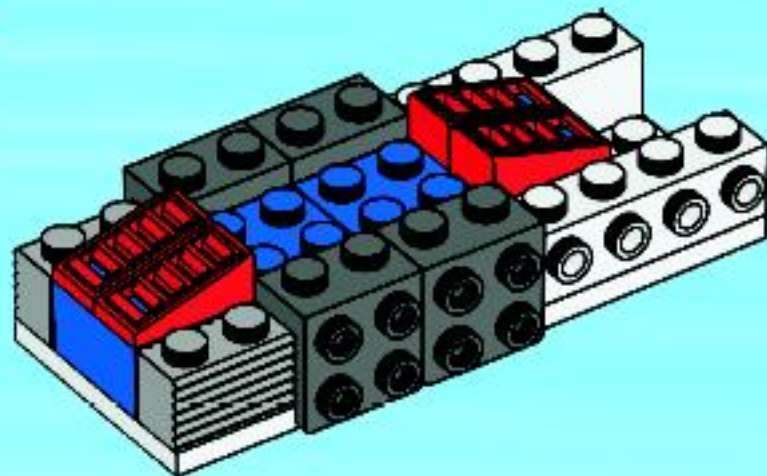

7

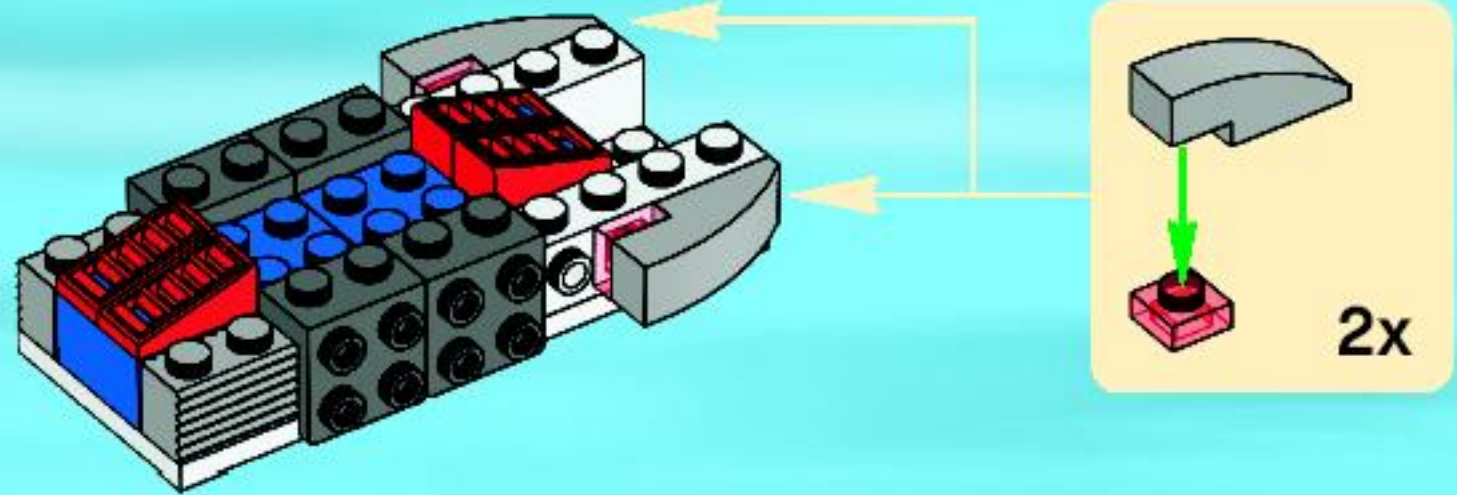

8

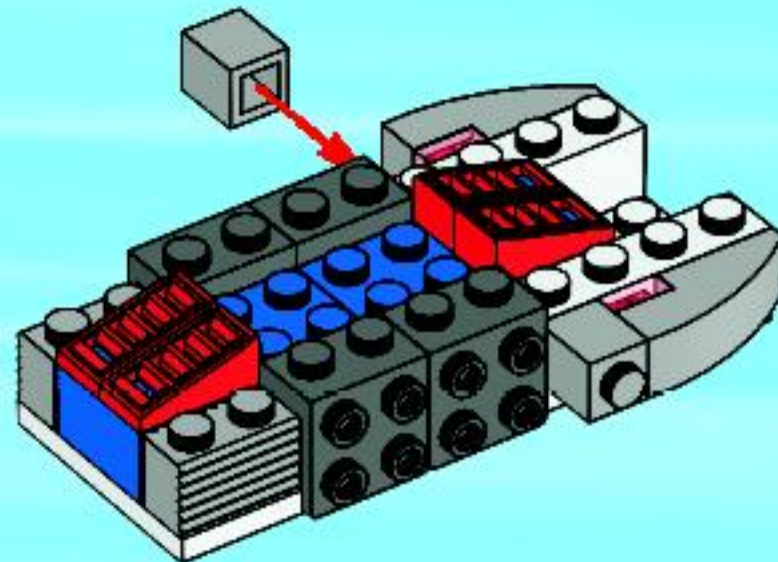

9

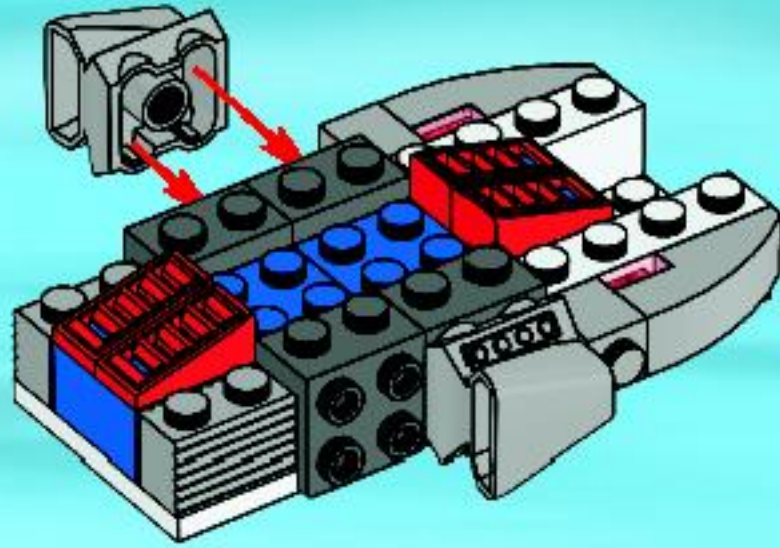

10

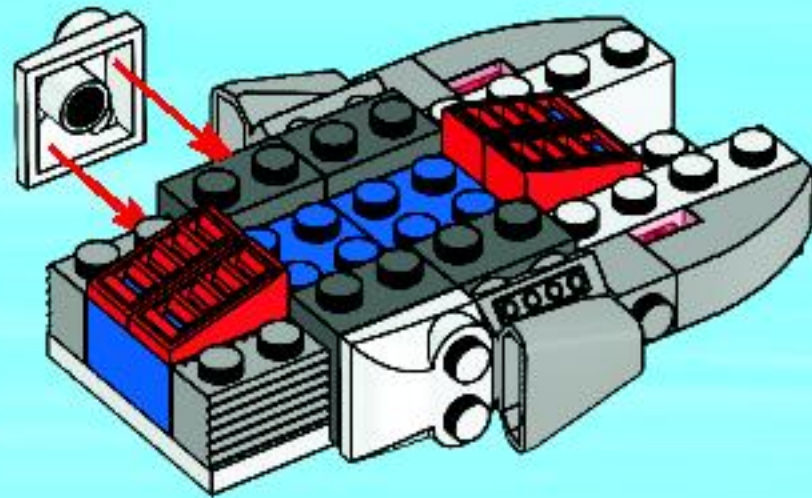

11

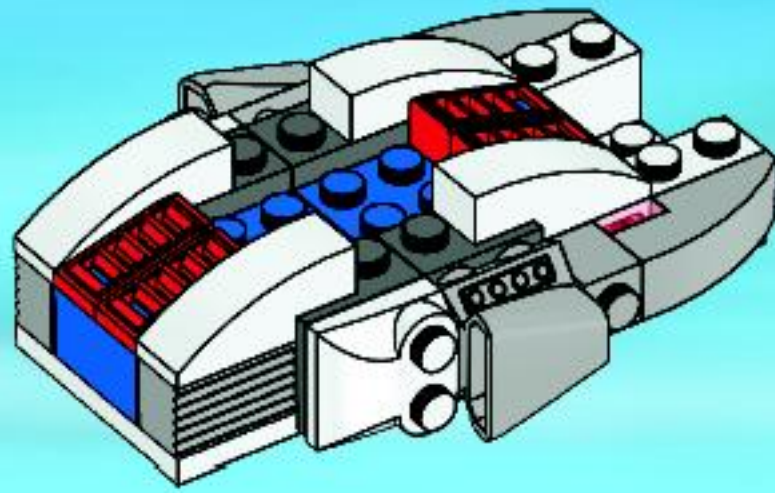

12

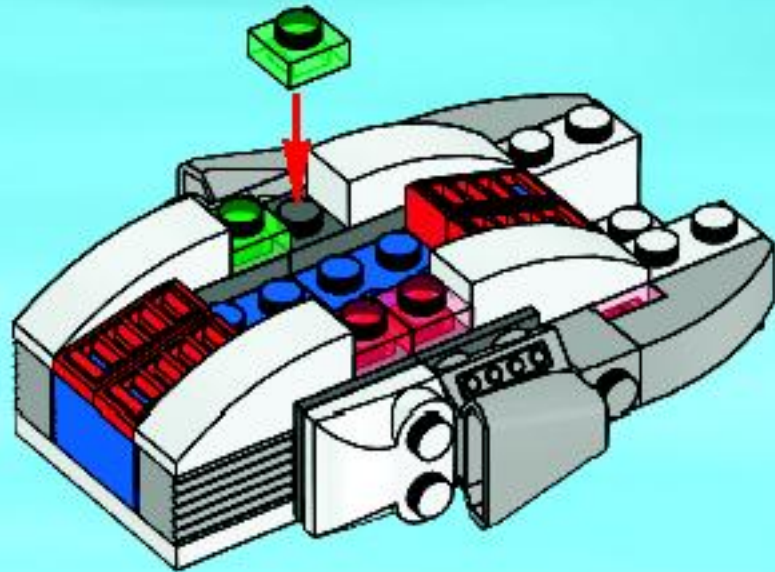

13

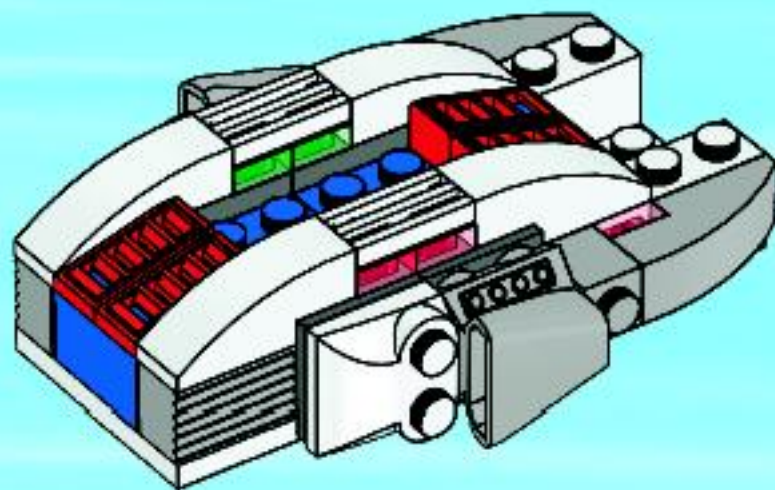

24

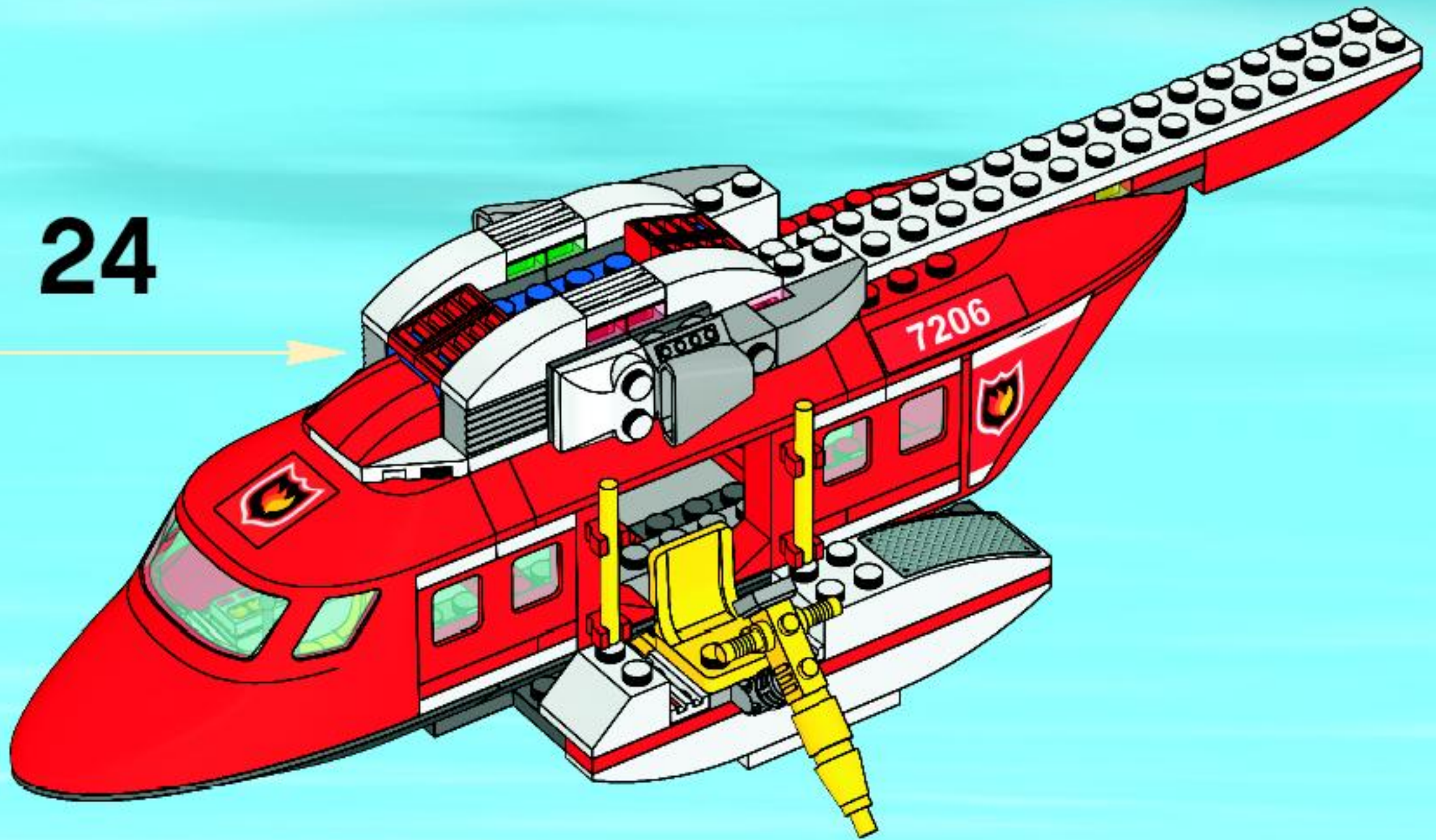

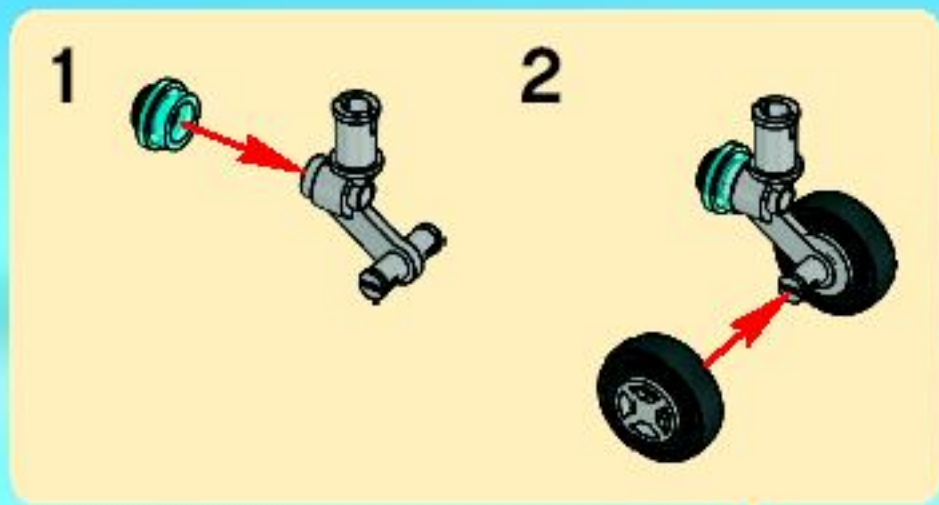

25

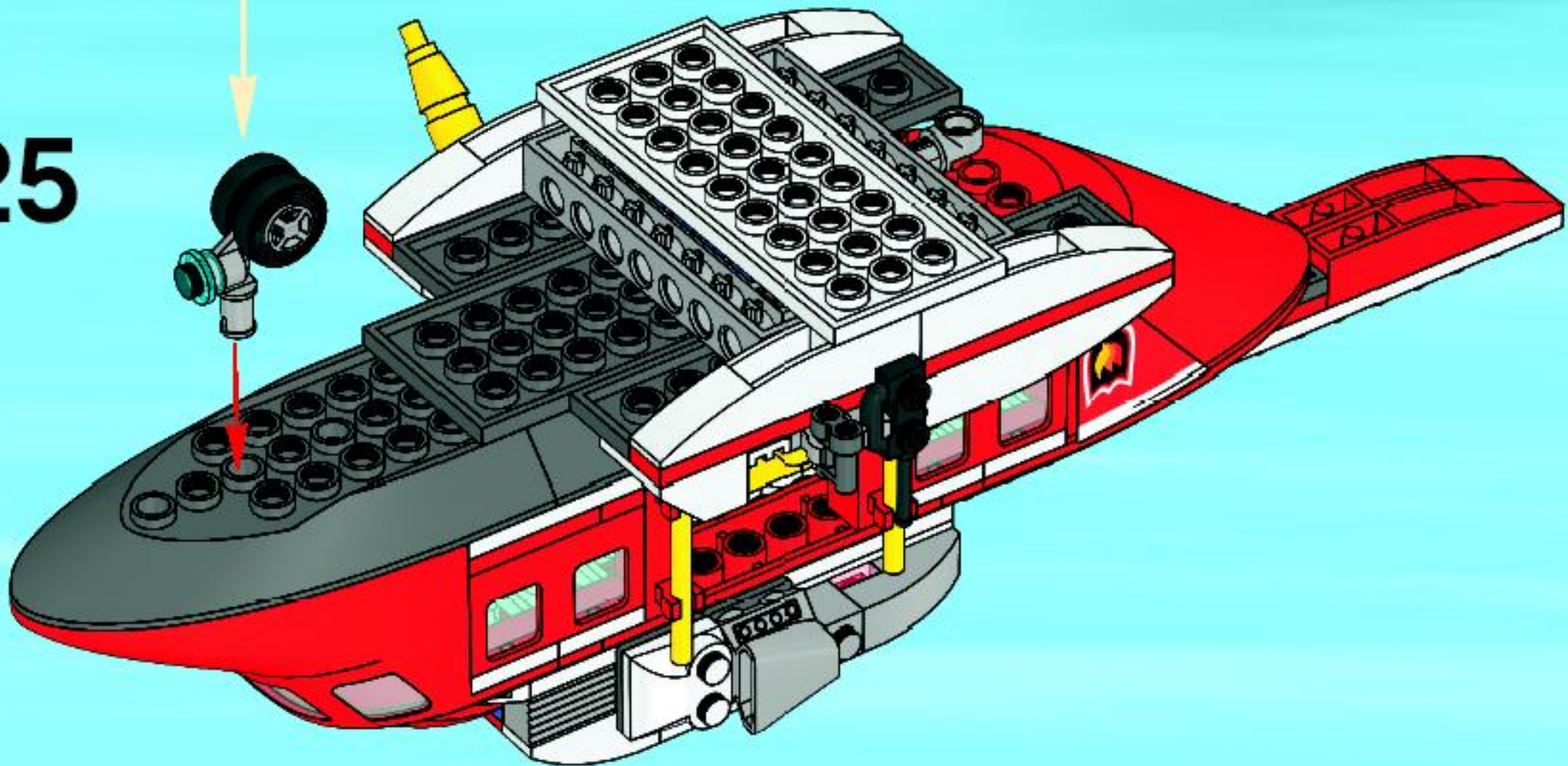

1



2

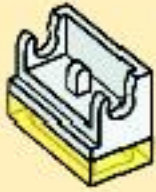

3



26

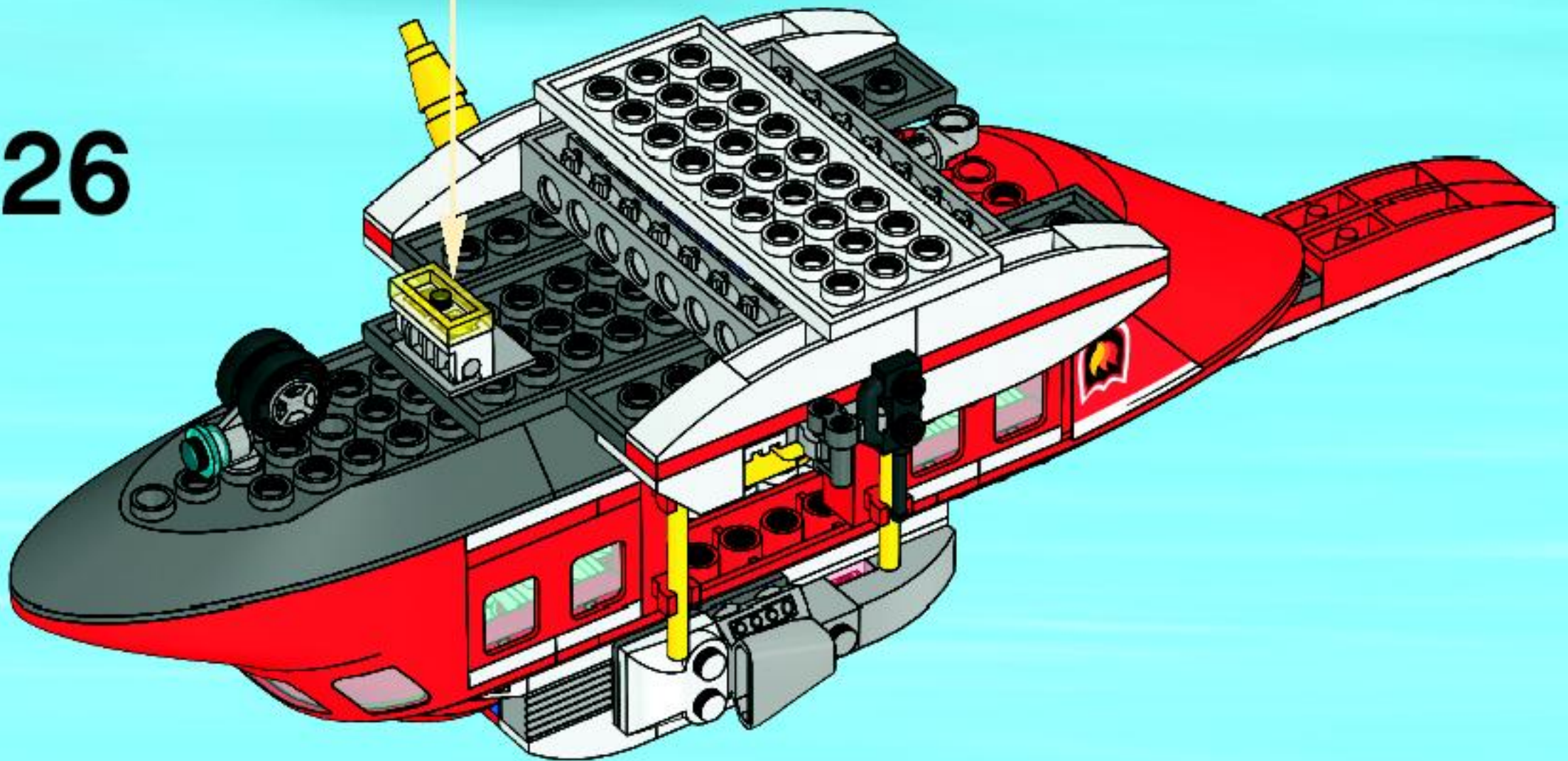

27

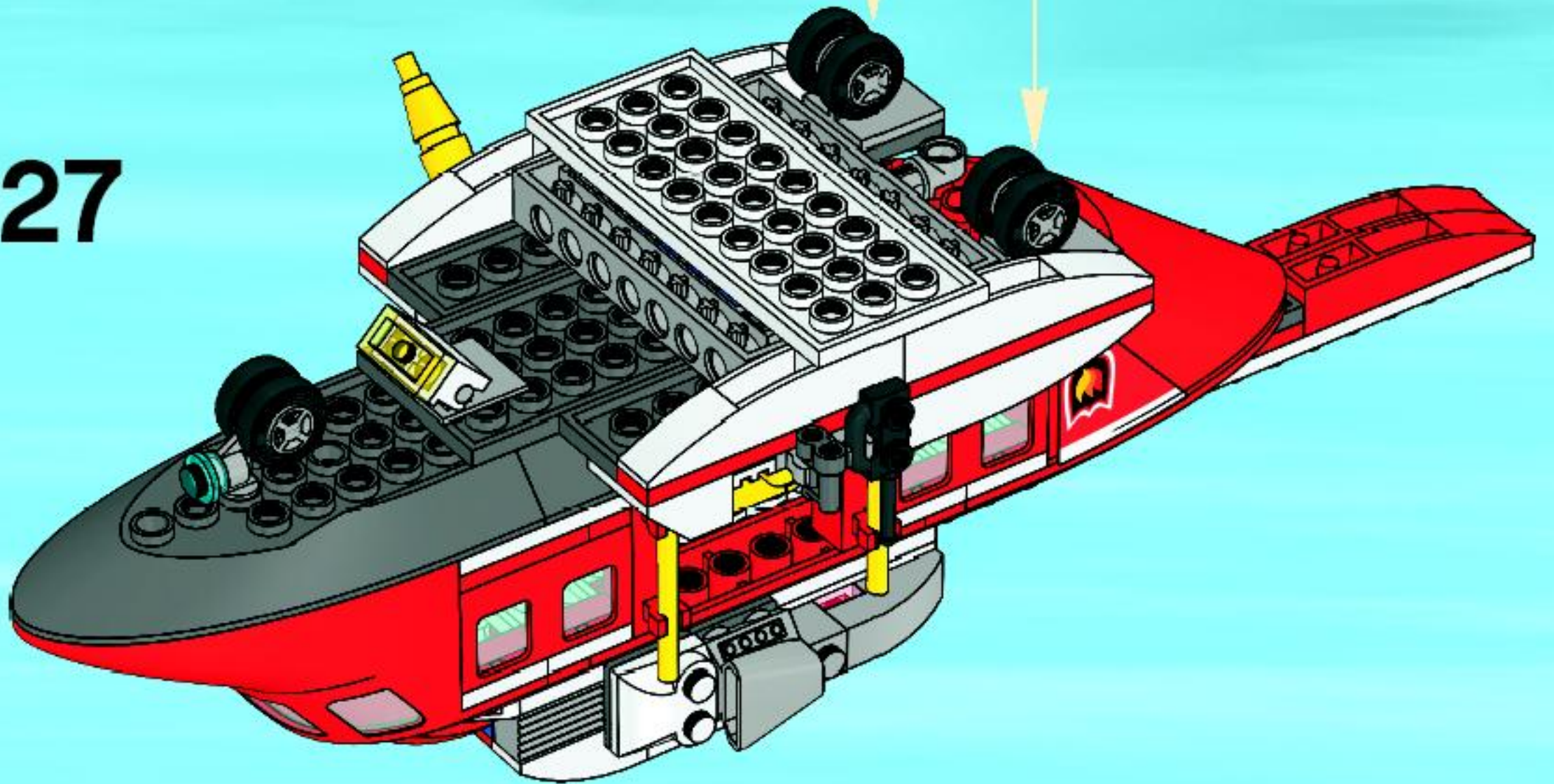
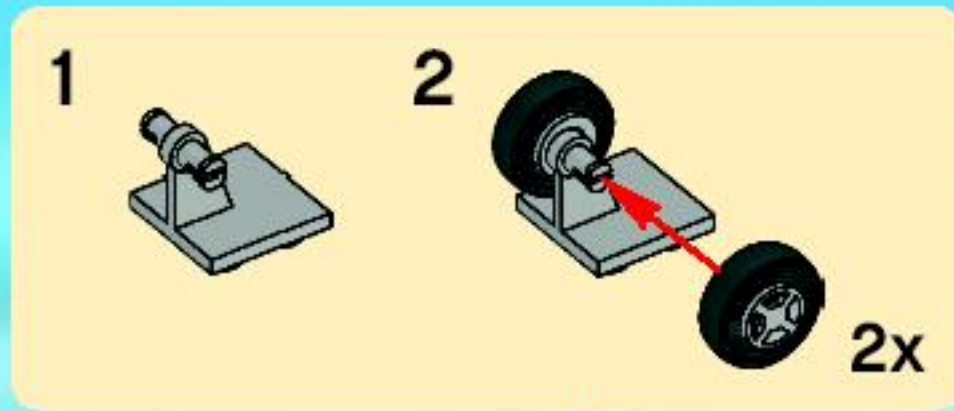

28

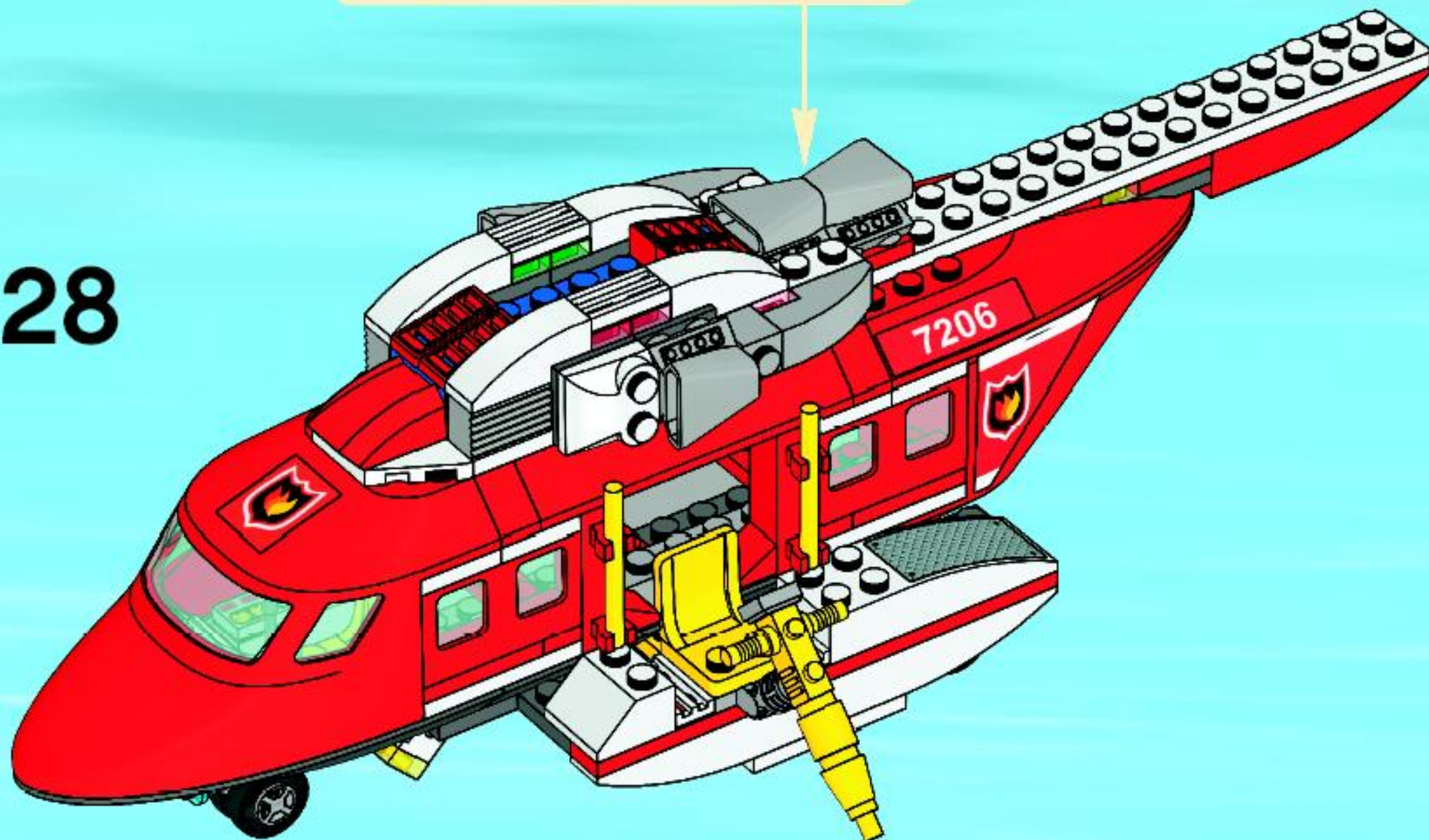
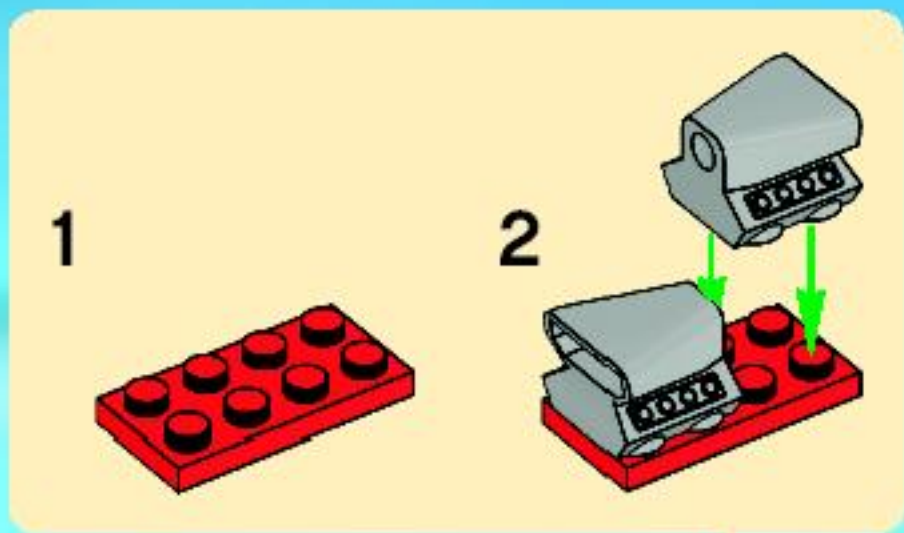

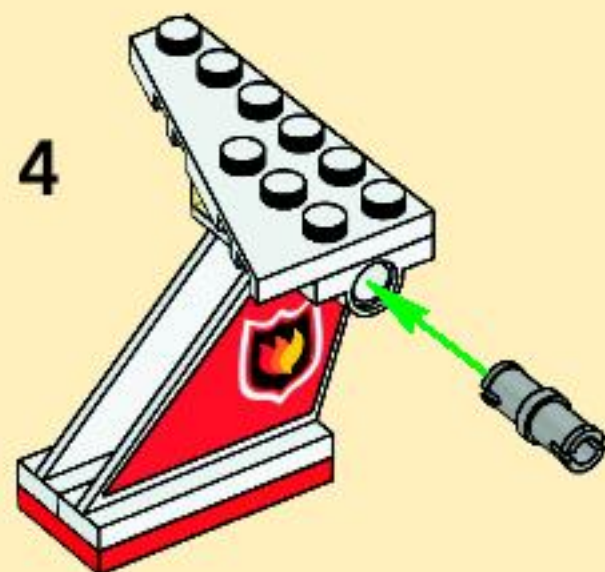
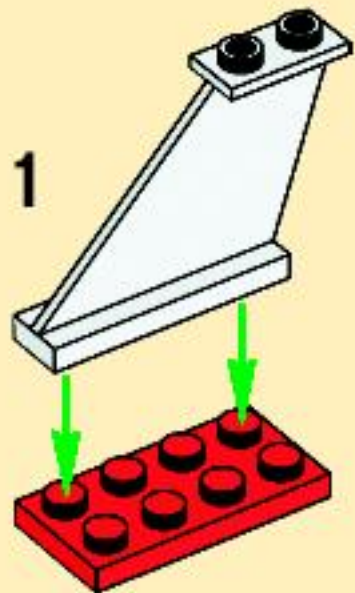

29

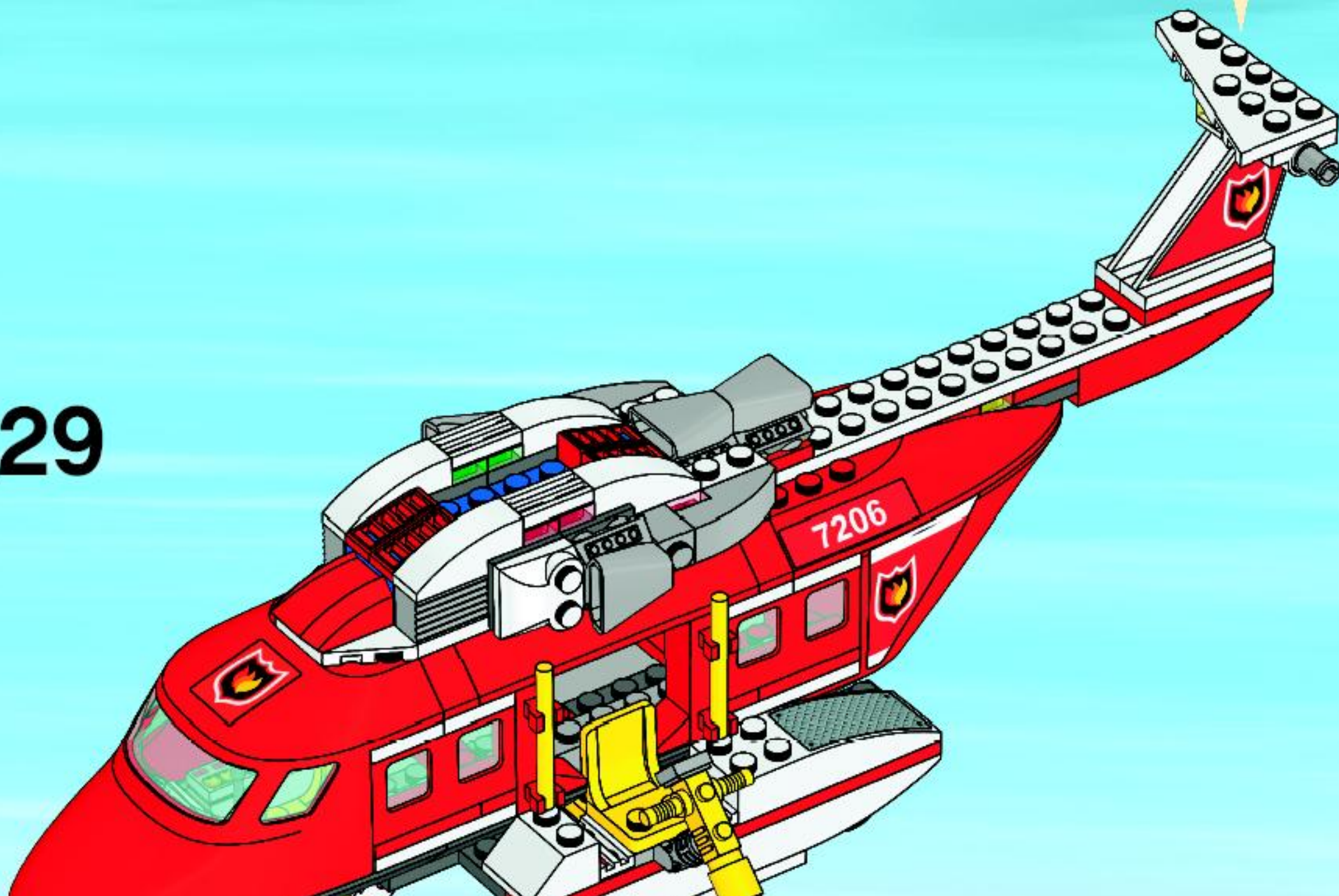

30

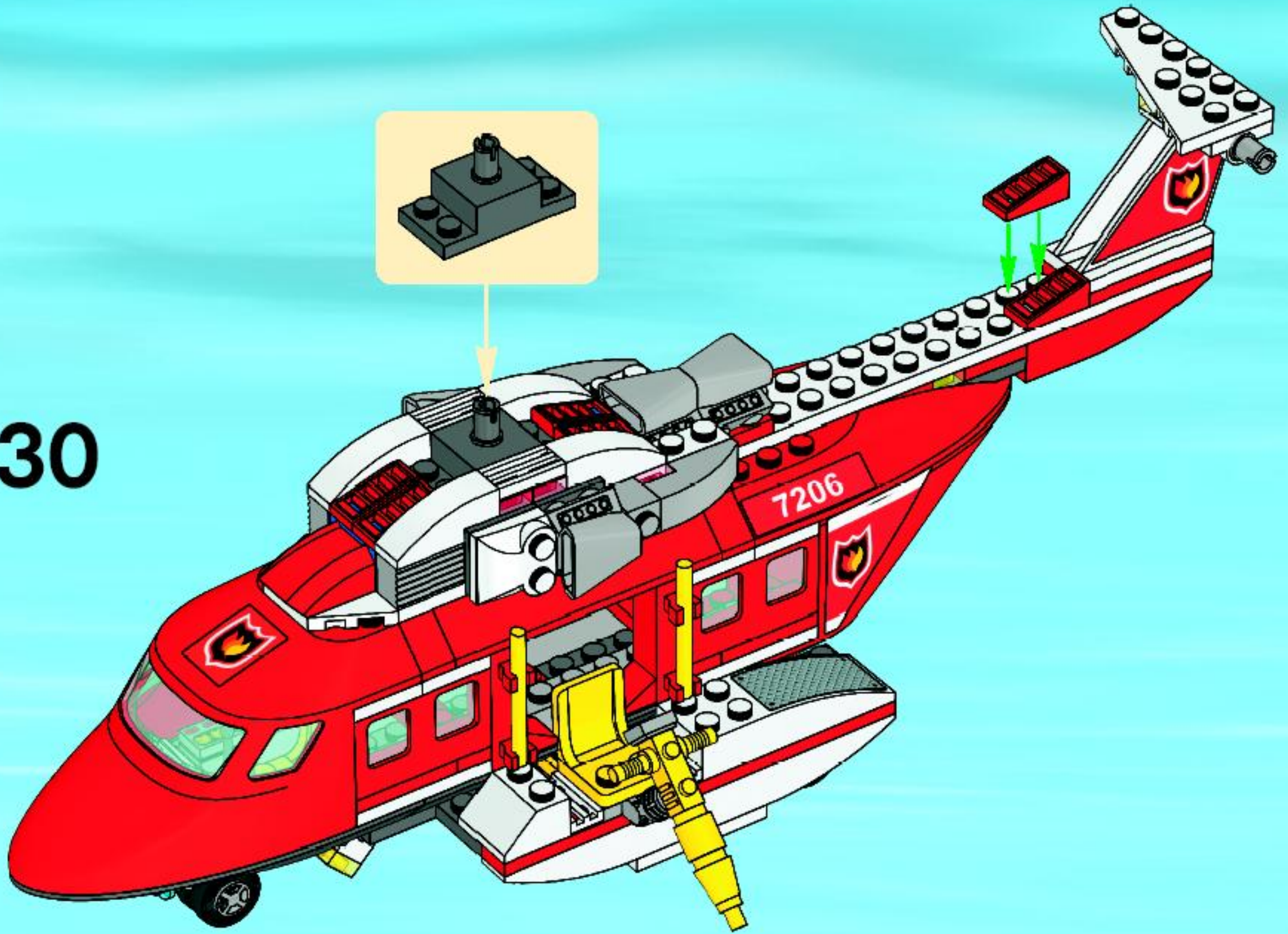

31

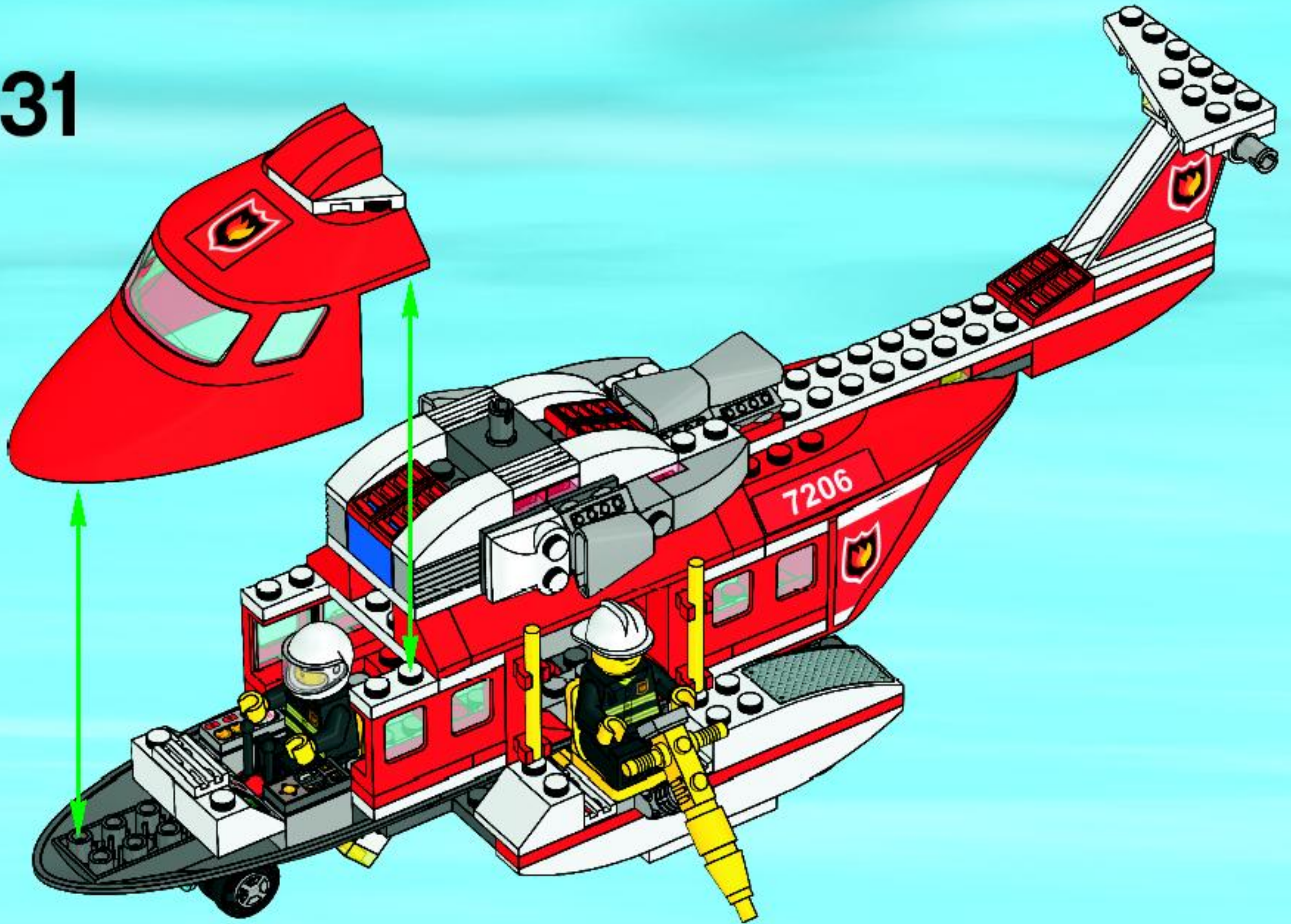



1



2

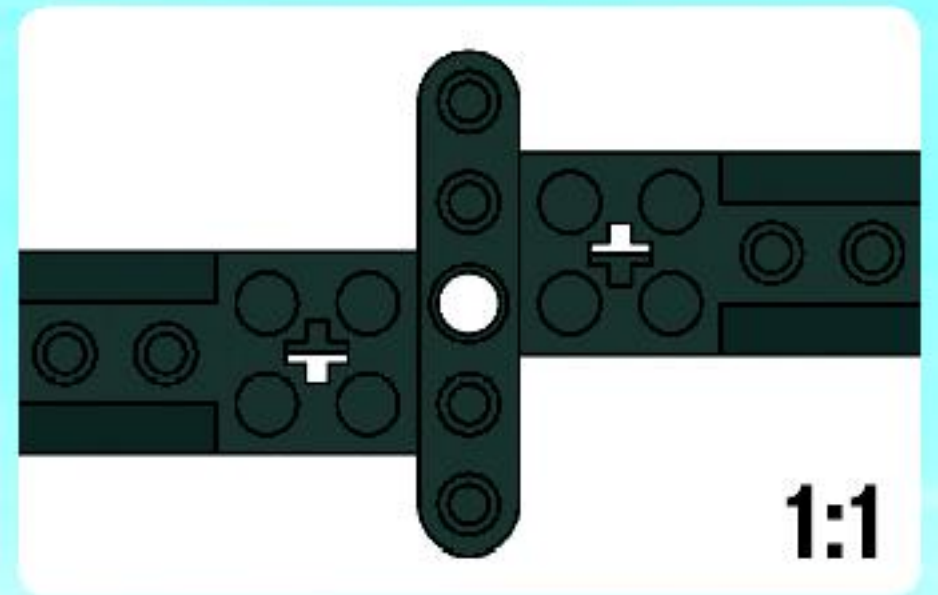
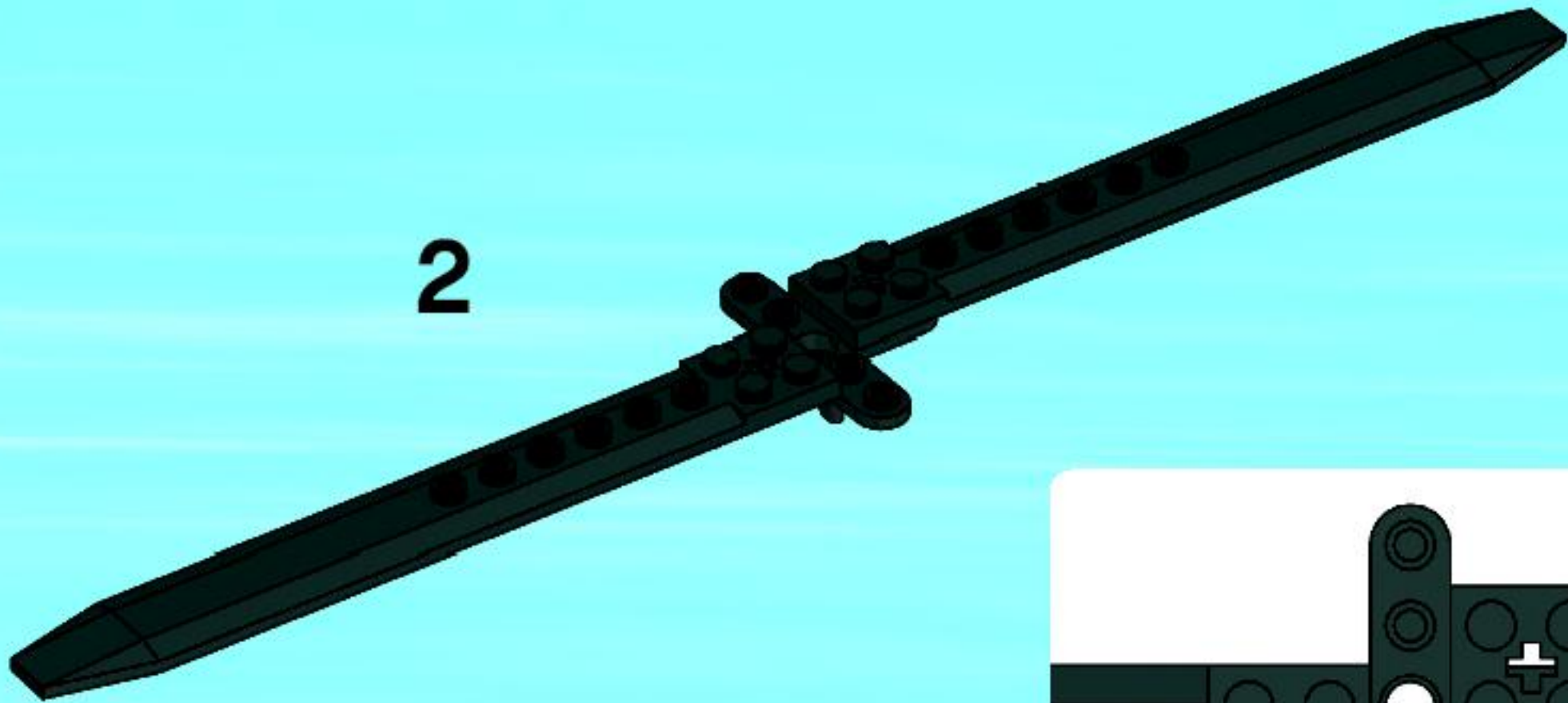

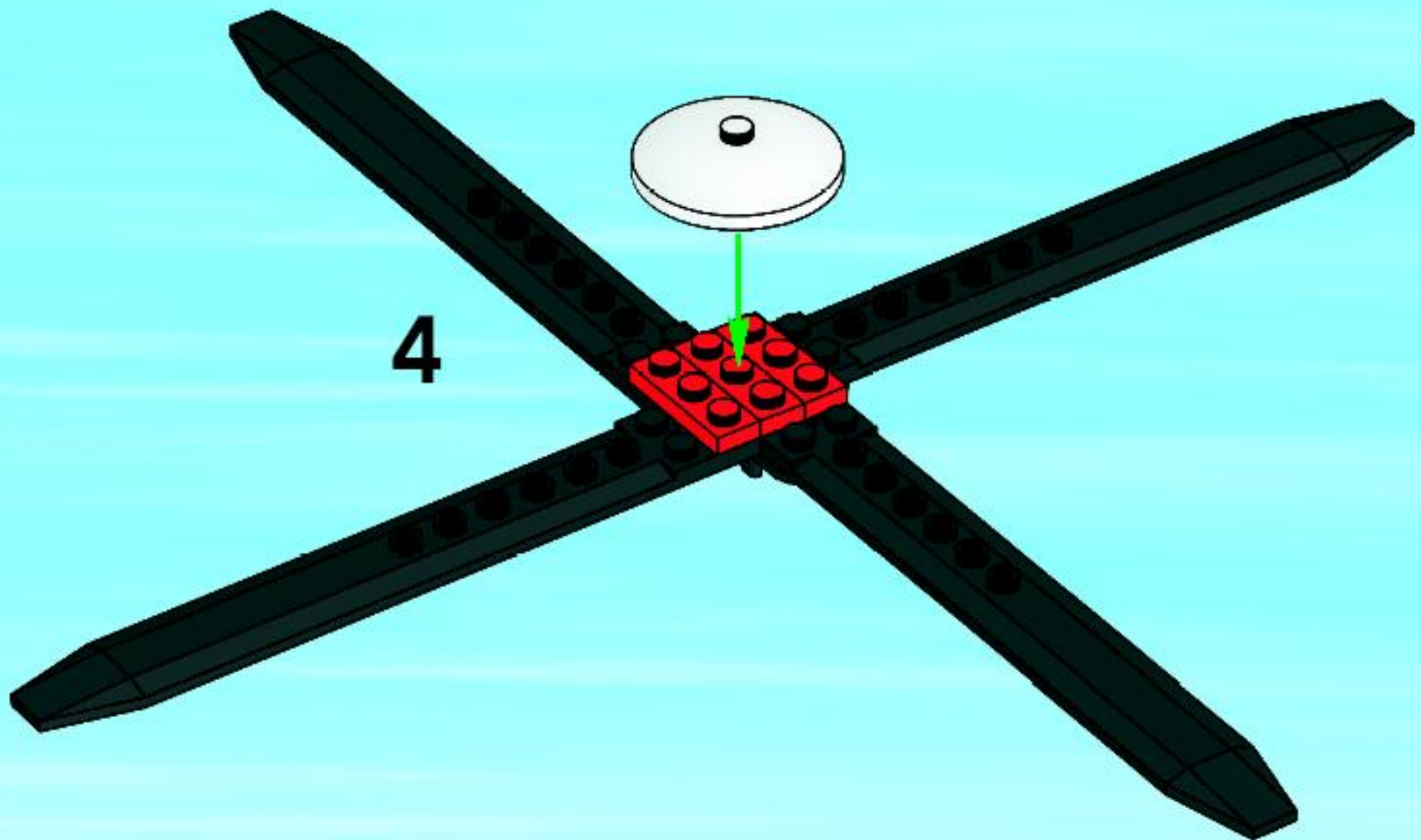
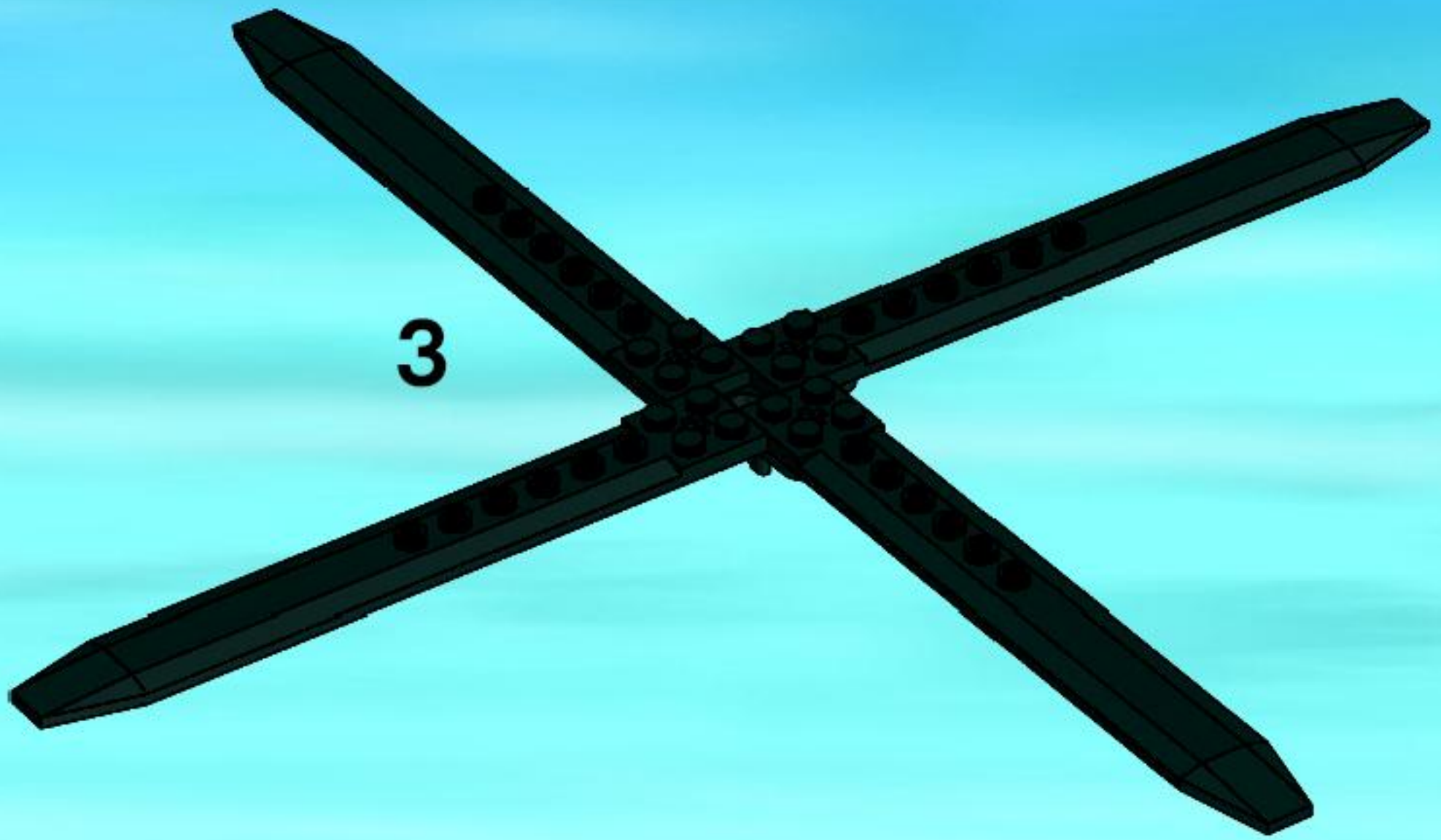

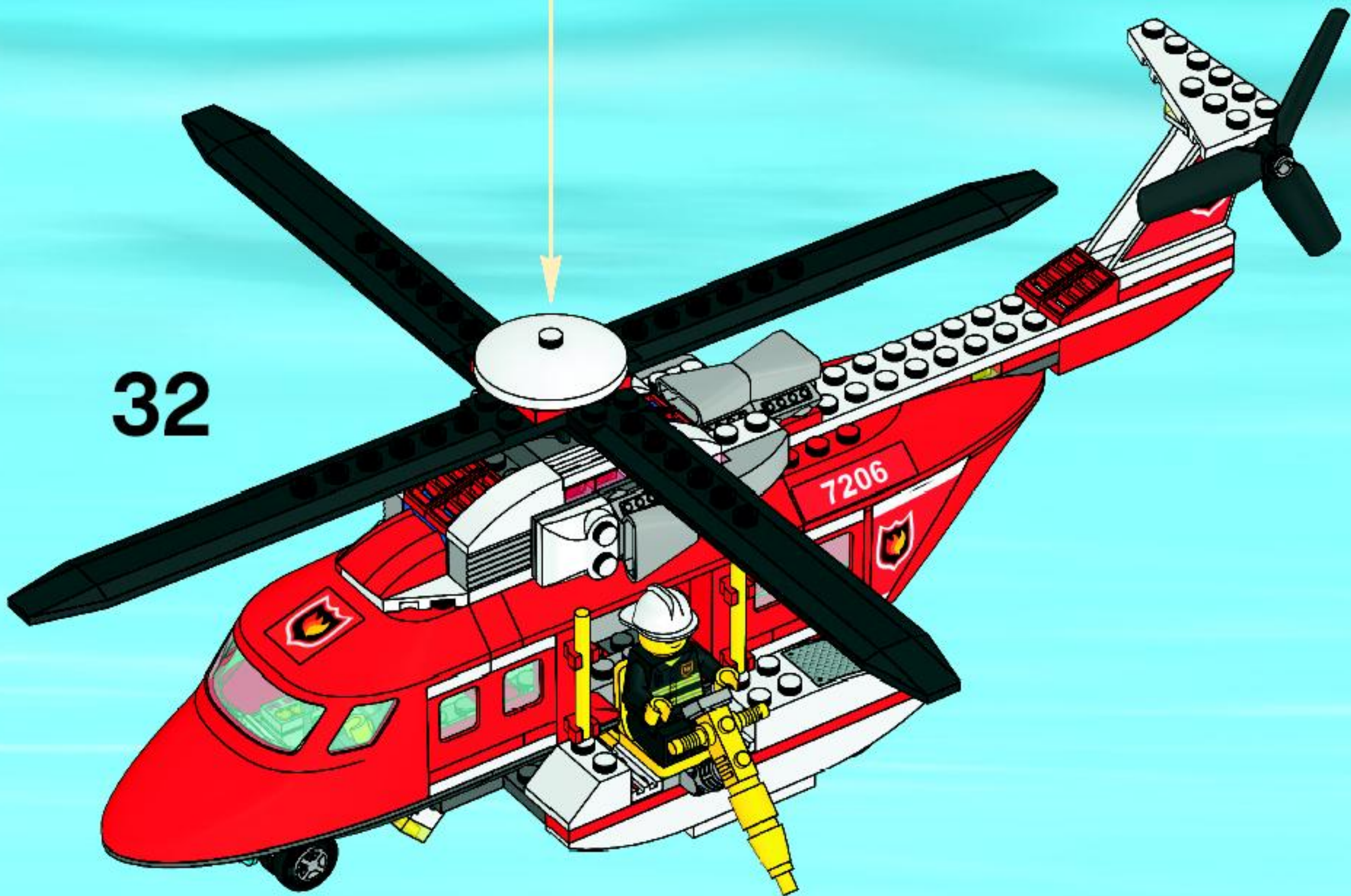



1

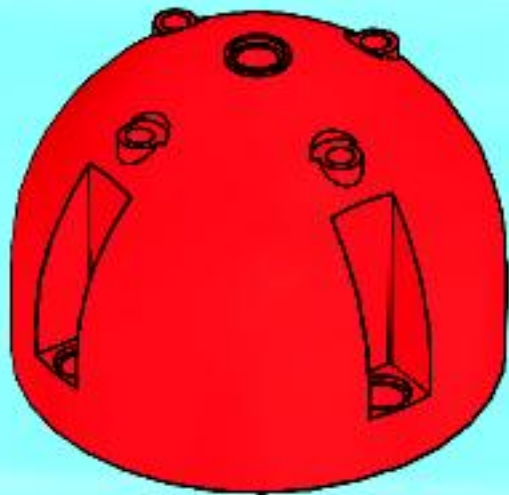

2

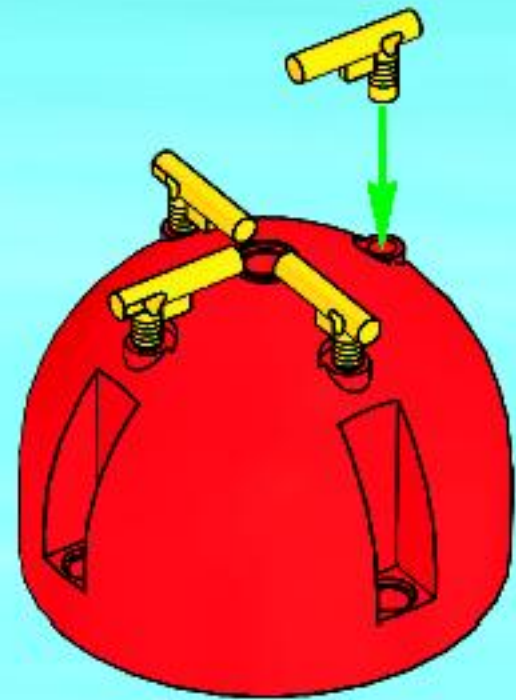

3

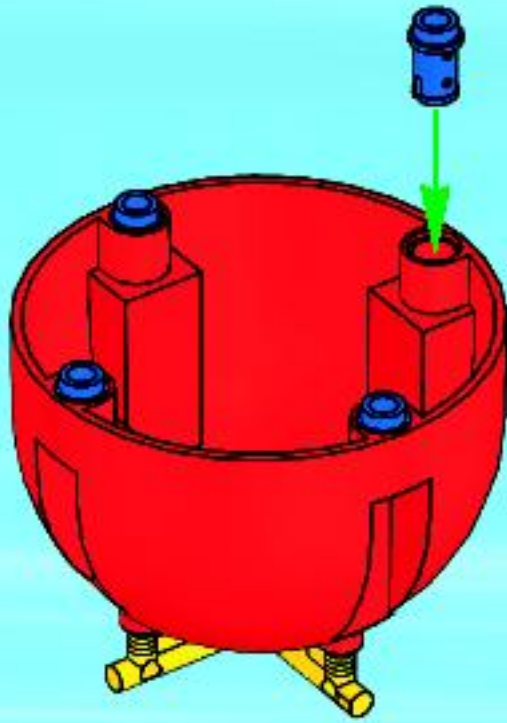

4

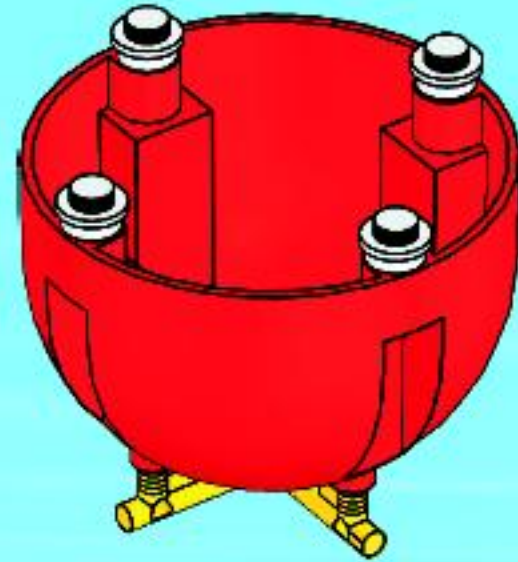

5

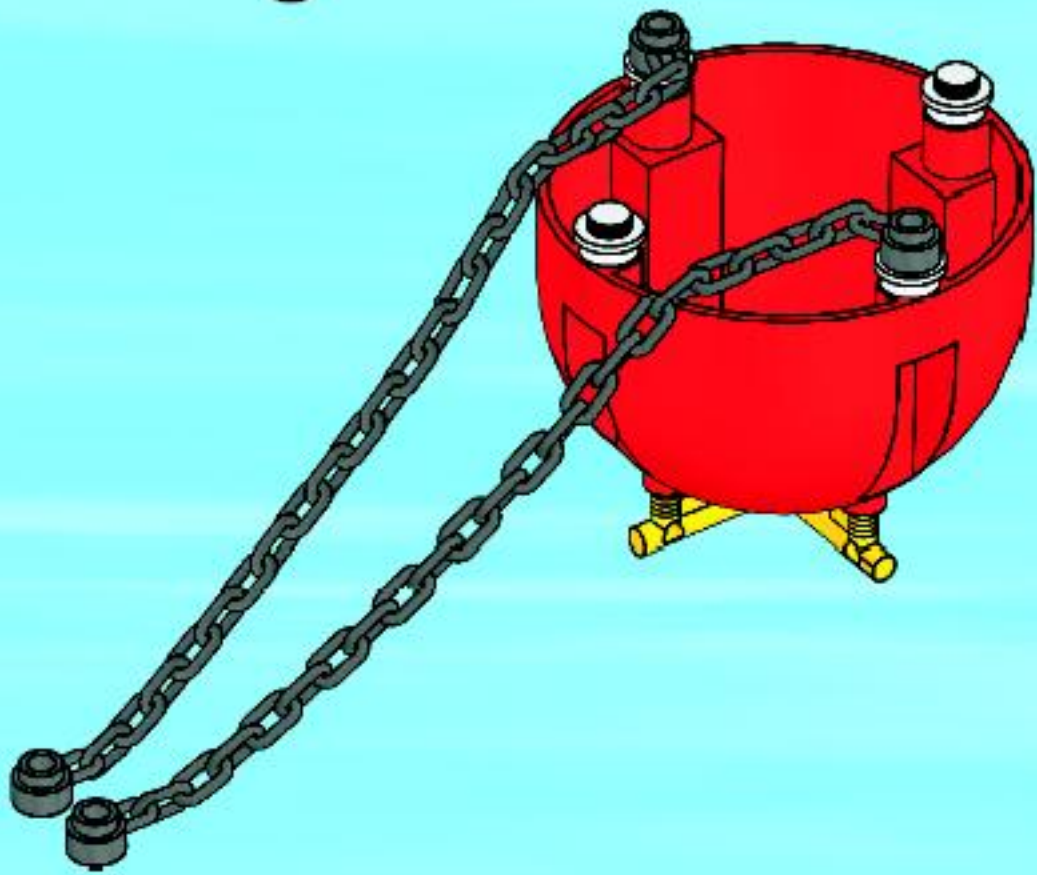

6

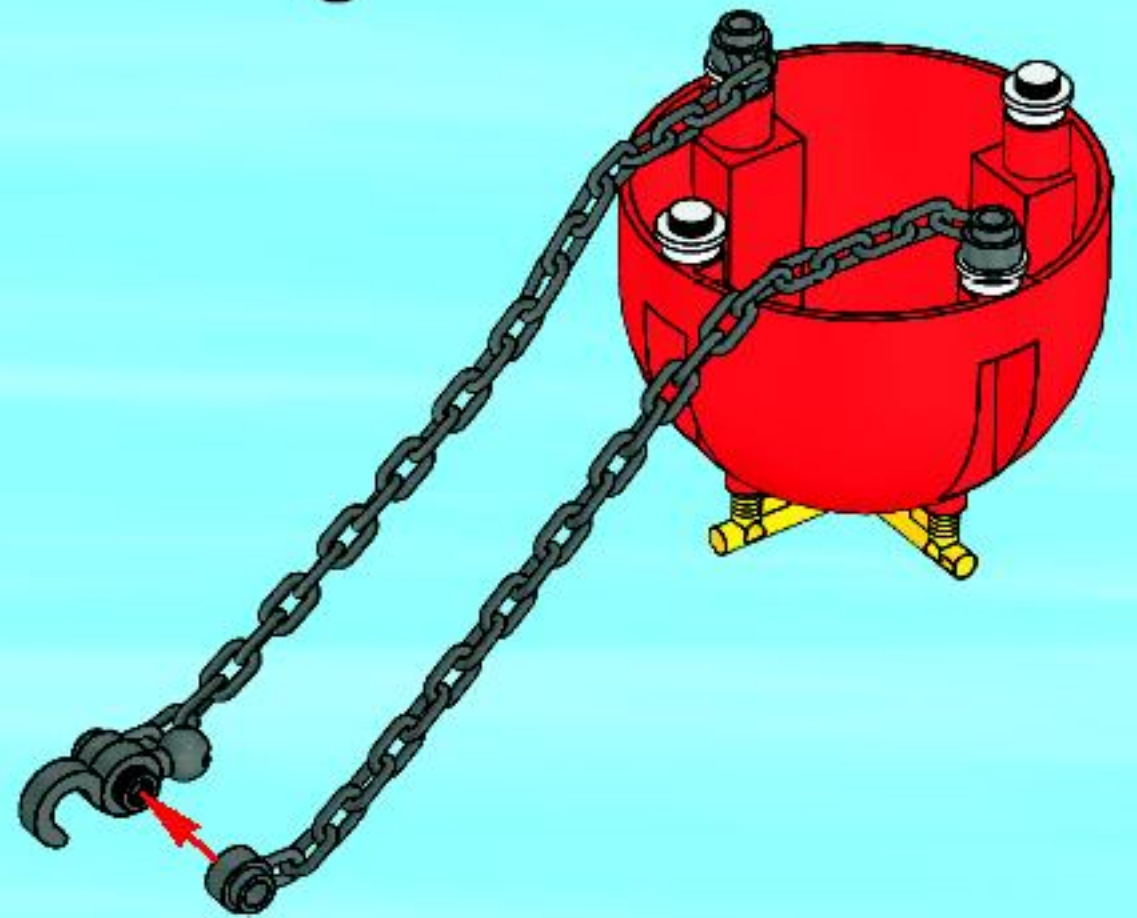

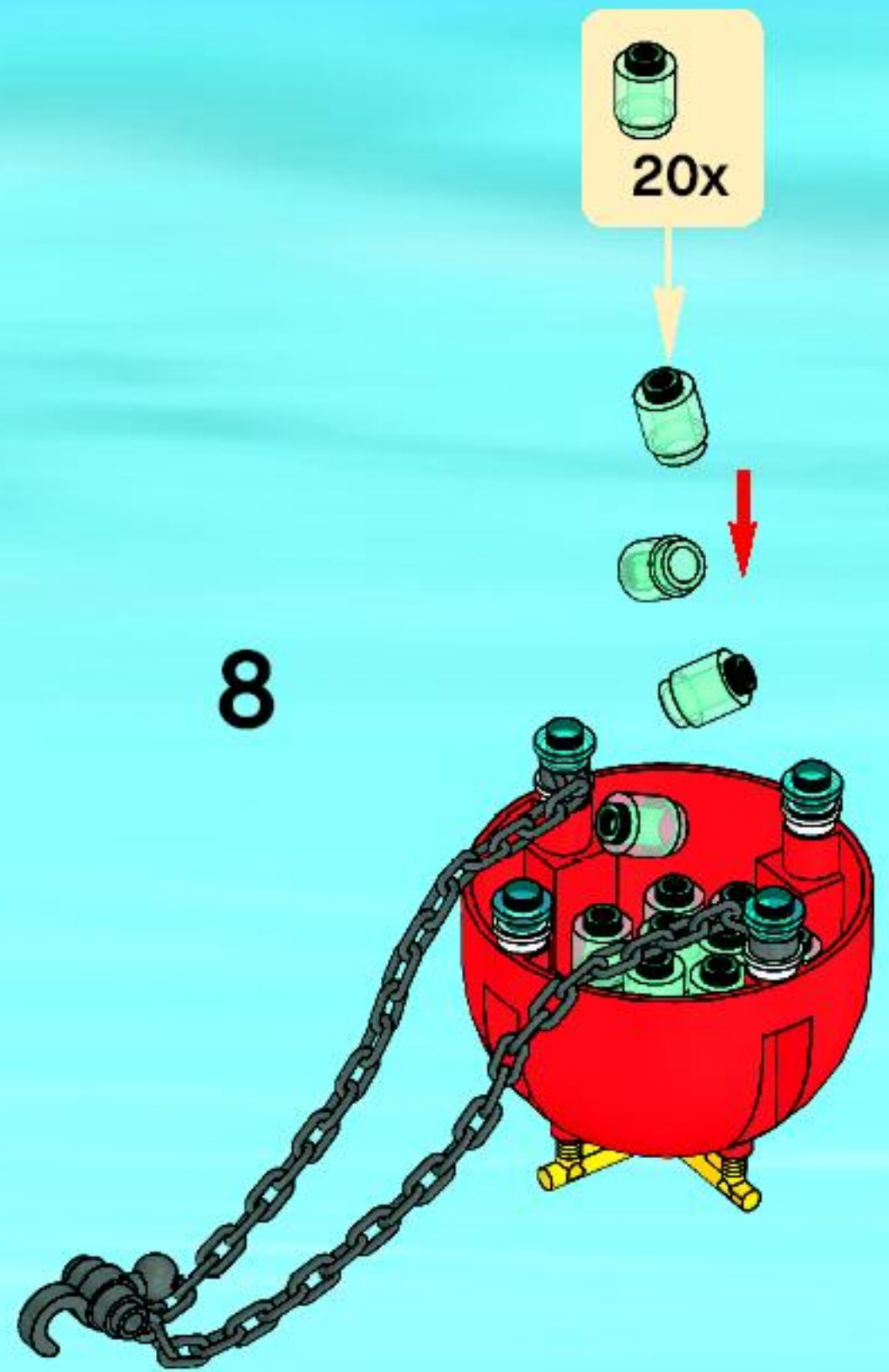
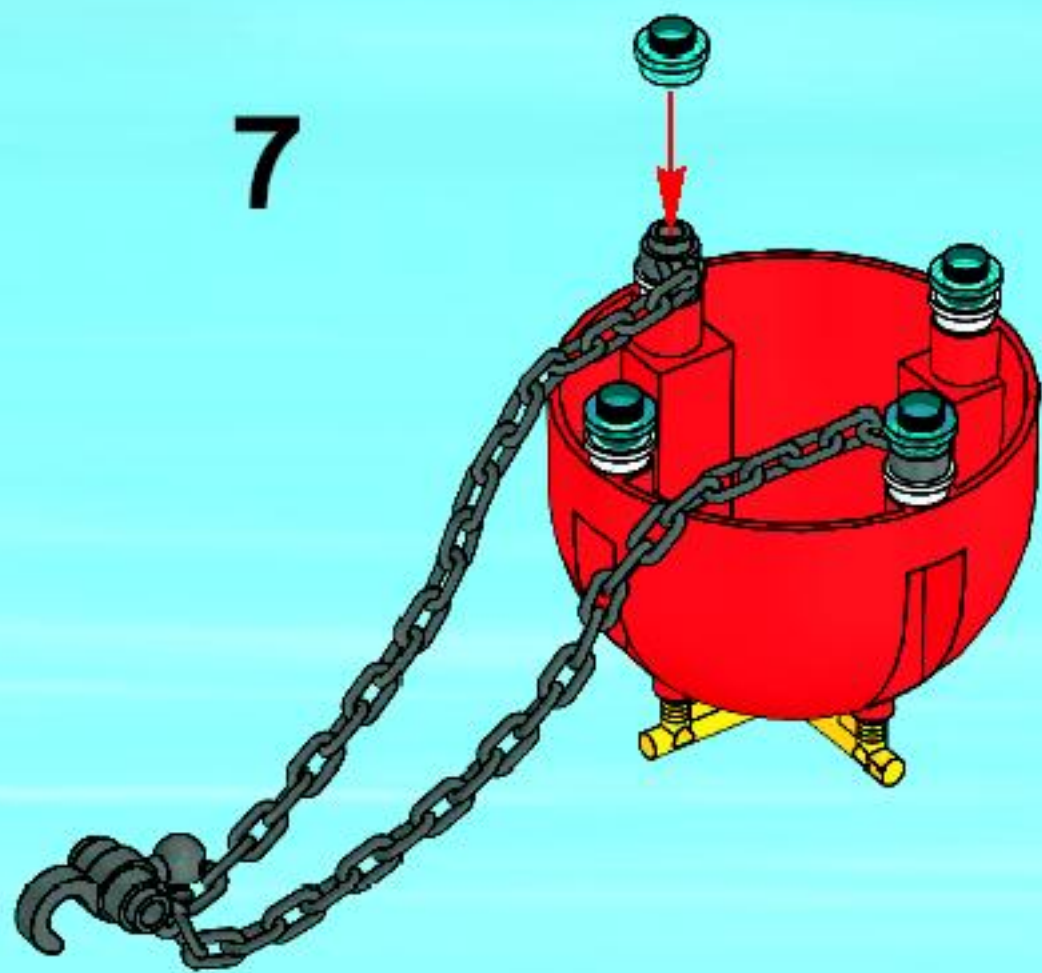

33



Functions

(Box photos)

LEGO CITY



3177



3178



3179



3180



3181



3182

ATLANTIS.LEGO.COM



8057

8058



8056

8060



8075



8061



8059



ATLANTIS

FREE! GRATIS! GRATUIT!



club
MAGAZINE™

www.LEGOclub.com



00800 5346 5555*

1-866-534-6258 • 1-877-518-5346

US & Canada only

Canada seulement



VISIT THE WORLD'S
BIGGEST LEGO® SHOP!

www.LEGOshop.com

* Free phone. Mobile charges may apply. * Numéro sans frais. Des frais peuvent s'appliquer avec les téléphones cellulaires. * Gebührenfrei, Kosten für Anrufer aus Mobilfunknetzen können anfallen.

* Gratis telefonnummer van PostNet lijn. * Det er et gratis nummer, når du ringer fra Fasttelefon. * Det är gratis, när du ringer från Fast telefon.

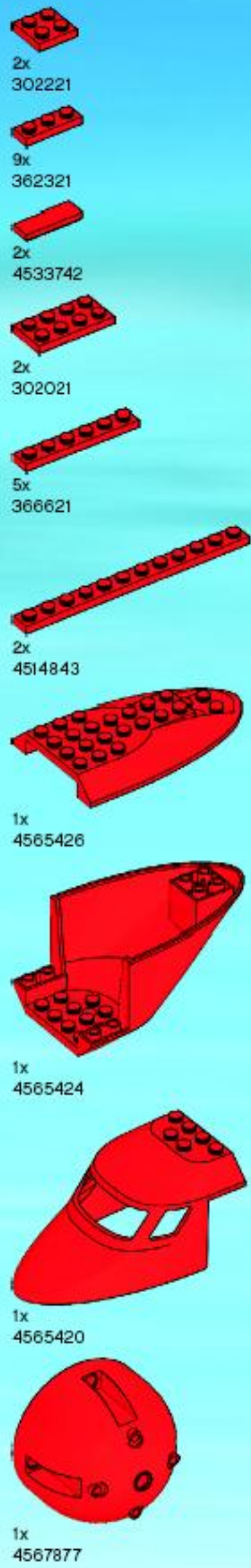
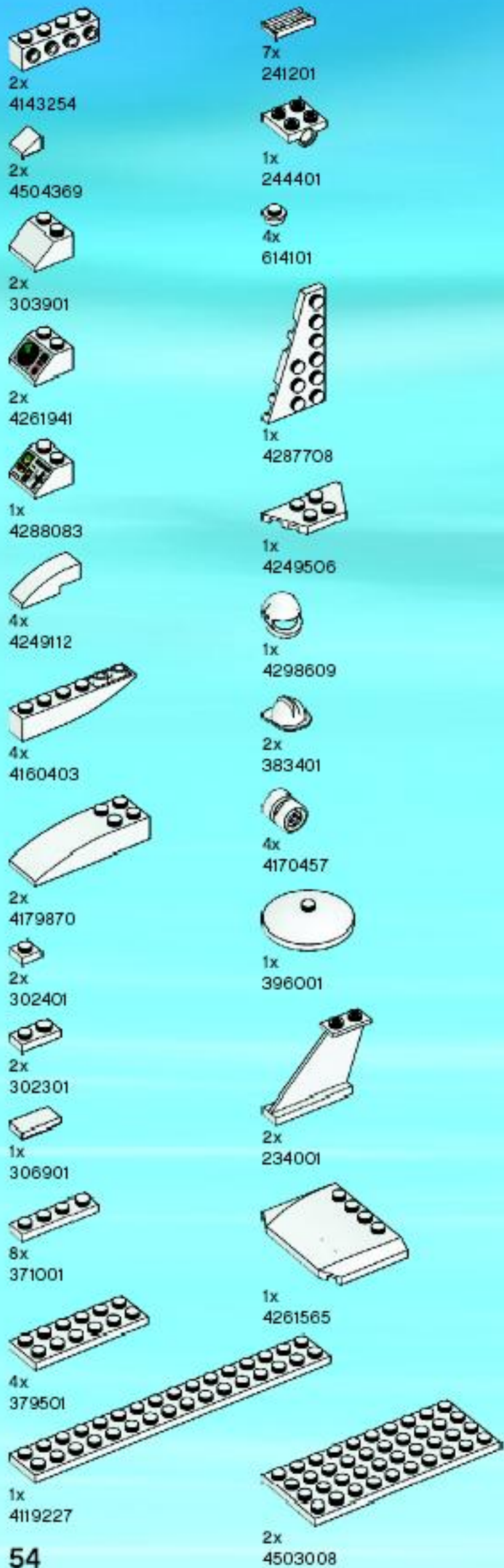



WIN!

Go to www.nielsen.com/LEGO to fill out a survey for a chance to win a cool LEGO® Product.

No purchase necessary.

Open to all residents where not prohibited.



www.nielsen.com/LEGO

GEWINNE! WIN!

Nimm an der Umfrage auf www.nielsen.com/LEGO teil und hab die Chance ein cooles LEGO® Produkt zu gewinnen!

Die Teilnahme am Gewinnspiel führt zu keinerlei Kaufverpflichtungen. Teilnahme in allen nicht ausgeschlossenen Ländern möglich.

Ga naar www.nielsen.com/LEGO, vul een enquêteformulier in en maak kans op een cool LEGO® product.

Geen aankoopverplichting. Iedereen mag deelnemen, uitgezonderd ingezetenden van landen waar een enquêteverbod geldt.

GAGNE! 当てよう!

Visite www.nielsen.com/LEGO pour répondre à un questionnaire et avoir une chance de gagner un produit LEGO® très cool!

Aucune obligation d'achat. Ouvert à tous les résidents des pays autorisés.

www.nielsen.com/LEGOにアクセスして、アンケートにご記入ください。当選者にはレゴ製品を差し上げます。

お買い上げの必要はありません。

禁止されていない限り、すべての情報にご利用いただけます。