



7245

CITY



**WARNING: CHOKING HAZARD.**  
Small parts. Not for children under 3 years.

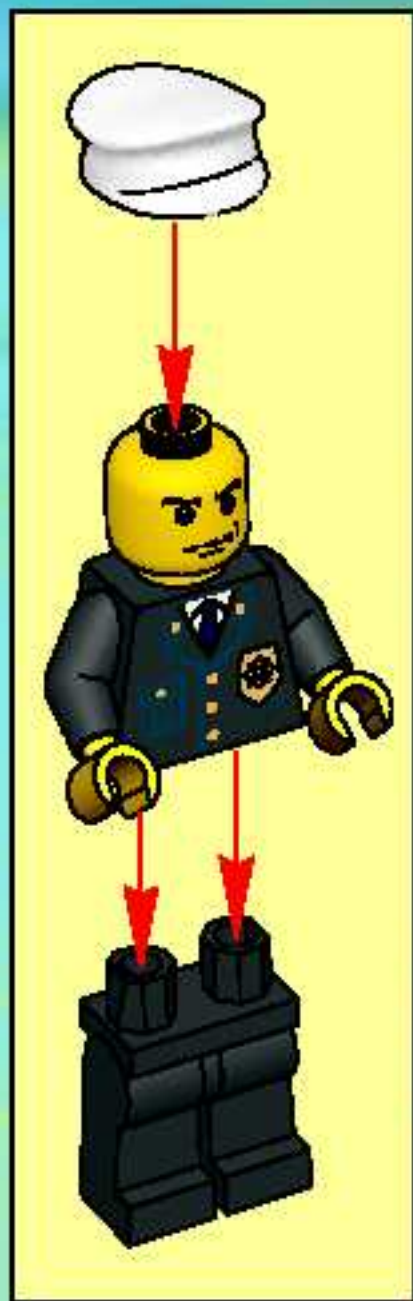

**AVERTISSEMENT : RISQUE D'ÉTOUFFEMENT.**

Contient des petites pièces. Ne convient pas aux enfants de moins de 3 ans.



**ADVERTENCIA: PELIGRO DE ASFIXIA.**

No recomendado para niños menores de 3 años. Contiene piezas pequeñas.





1

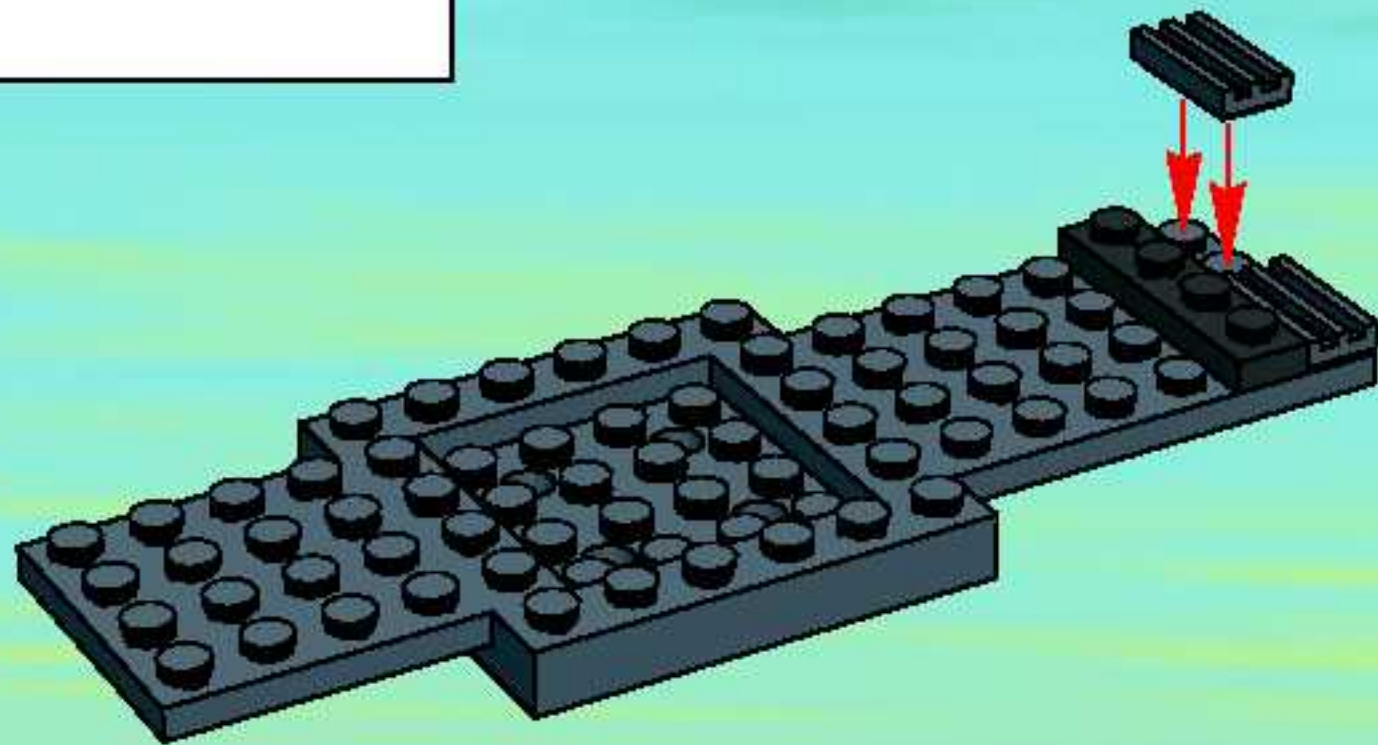

2

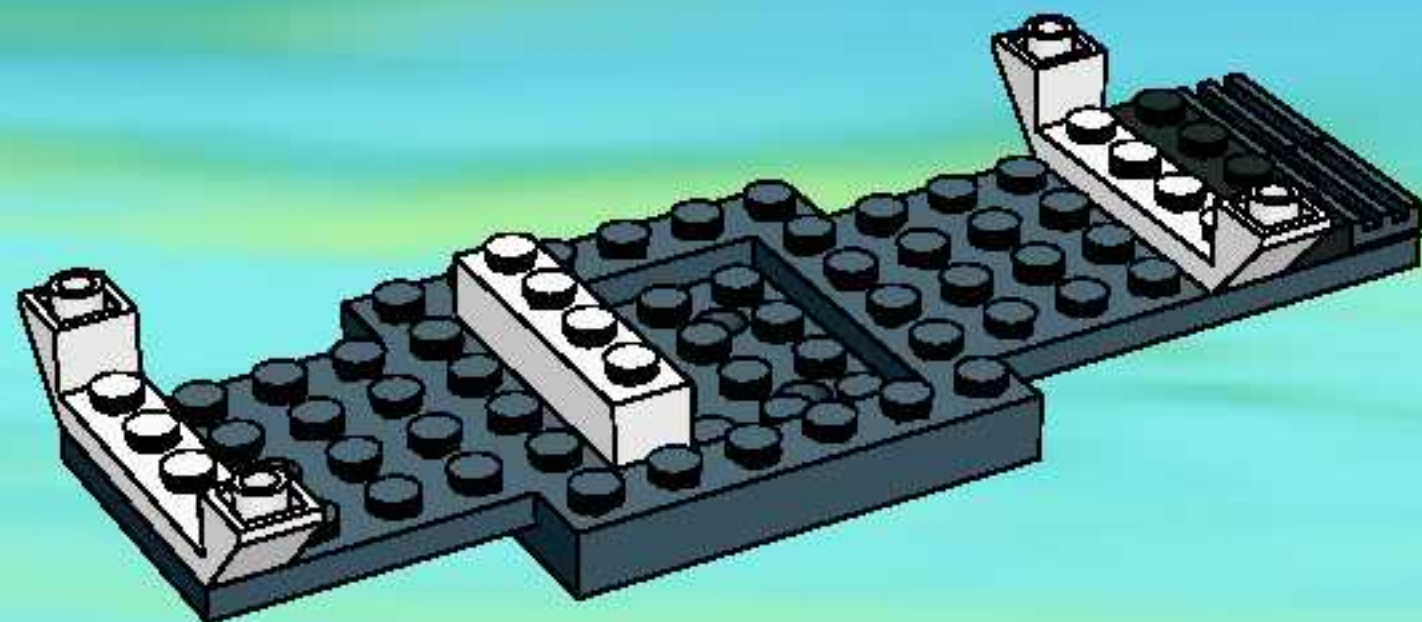

3

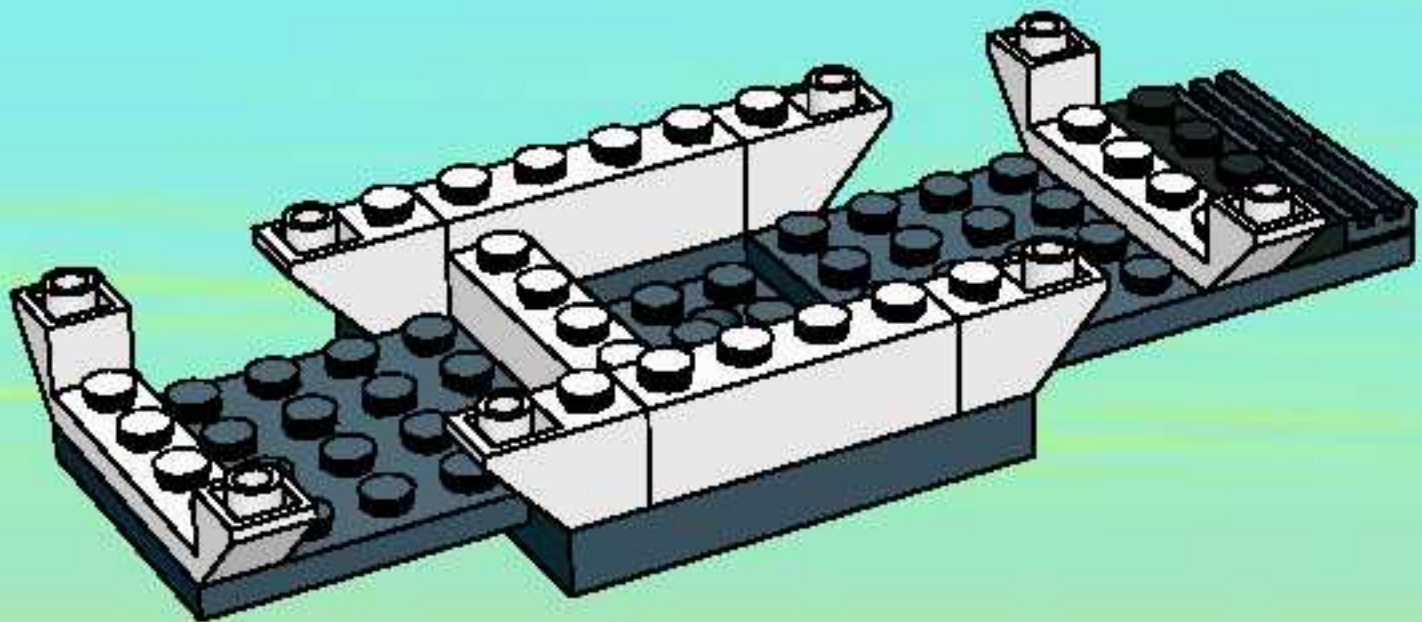

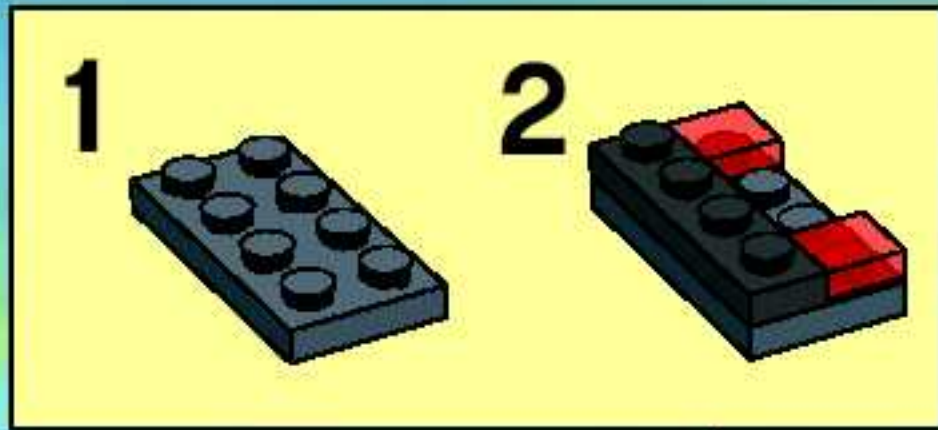

4

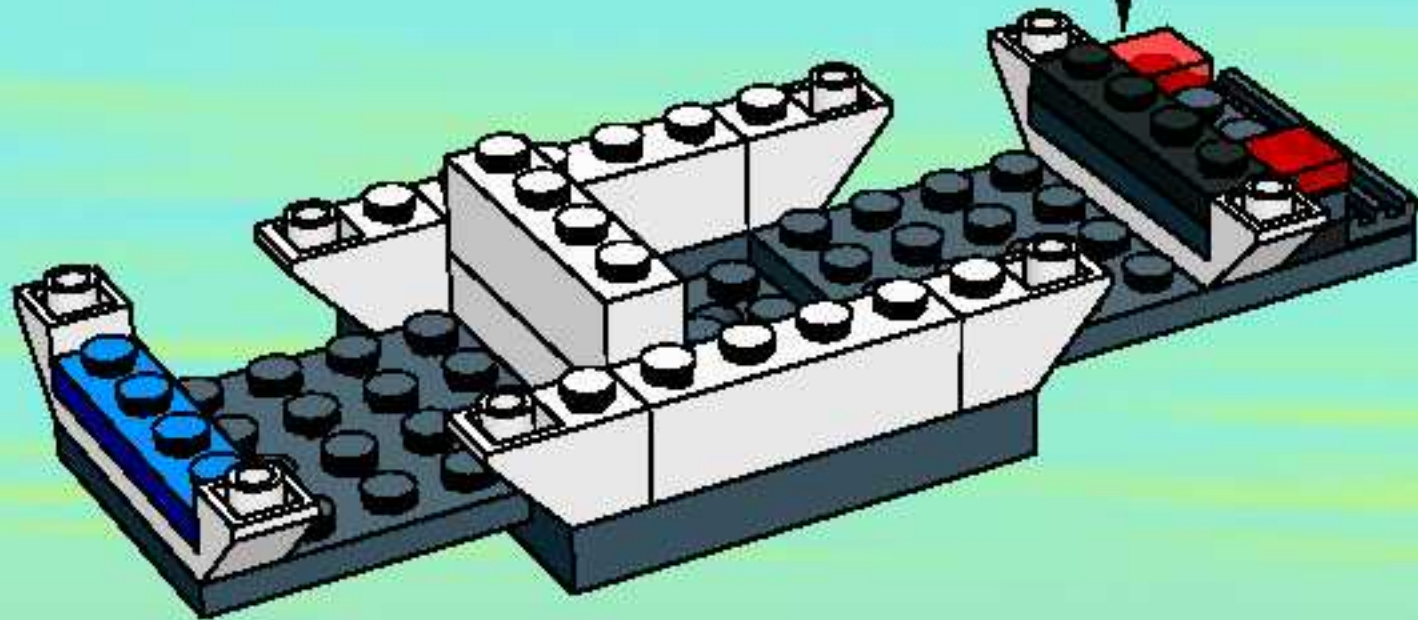

5

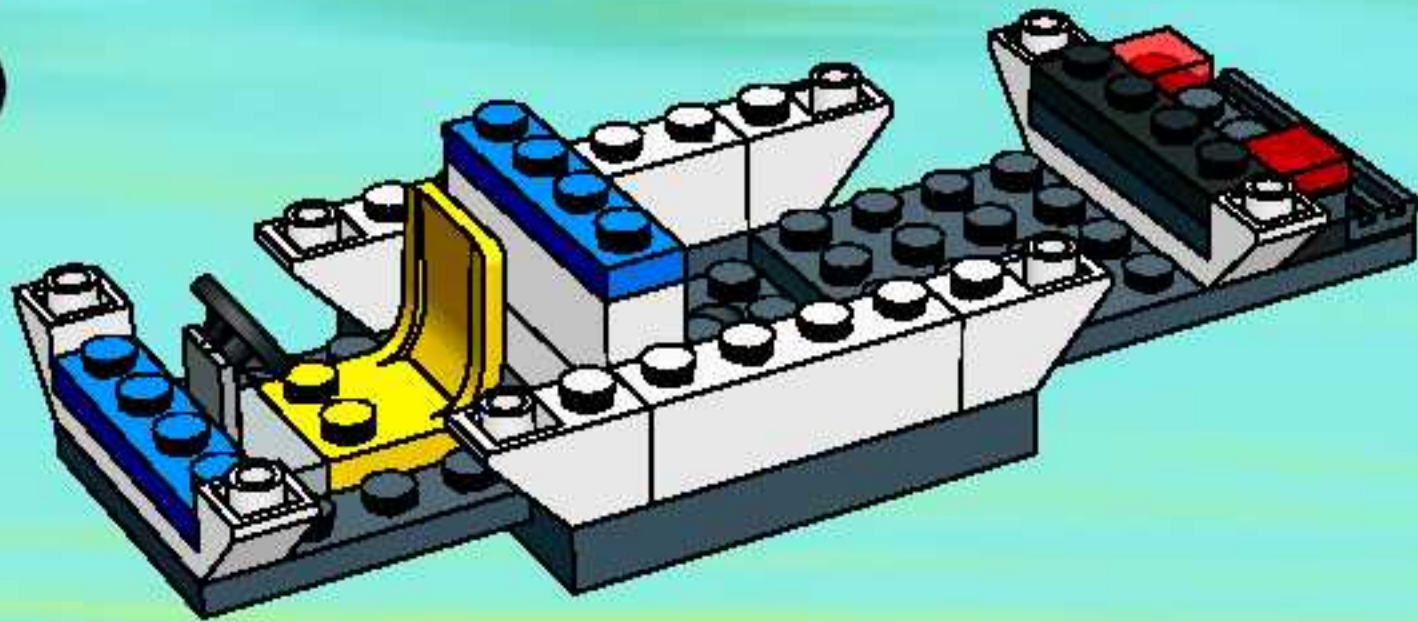

6

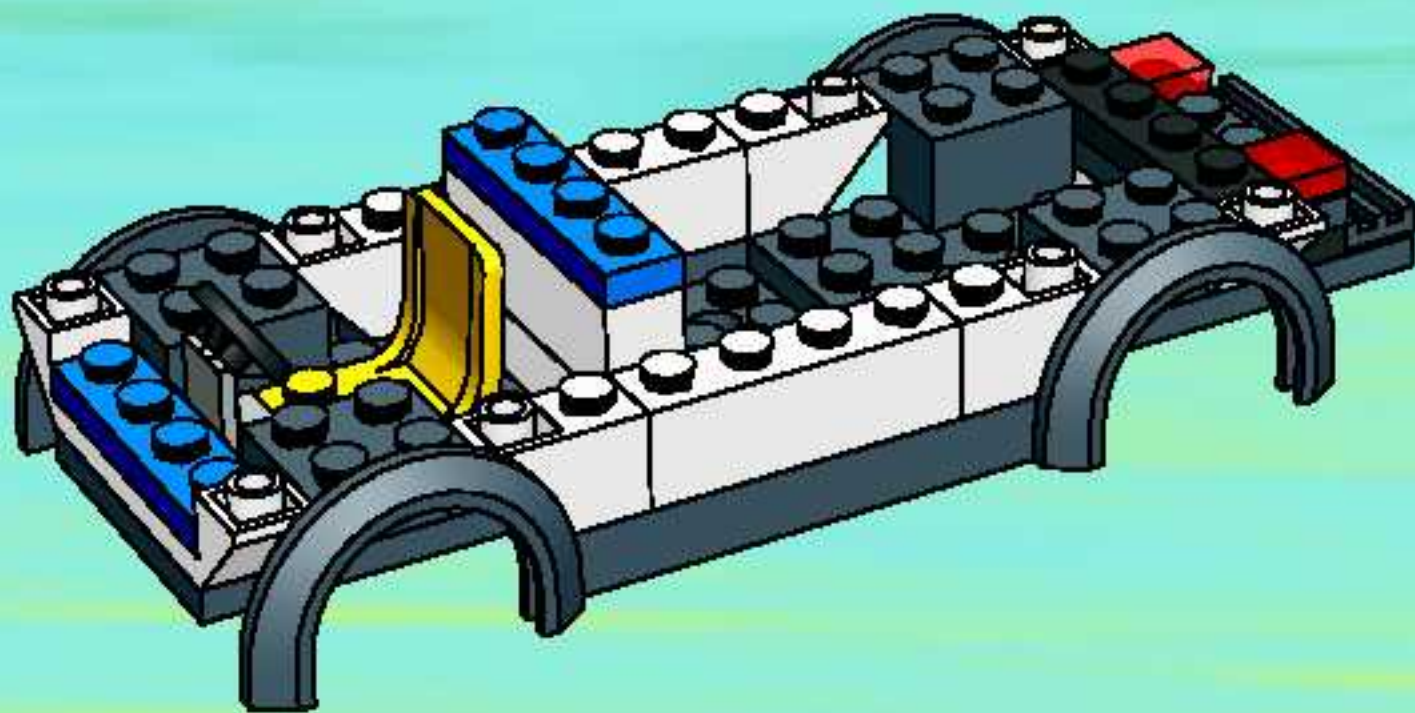

7

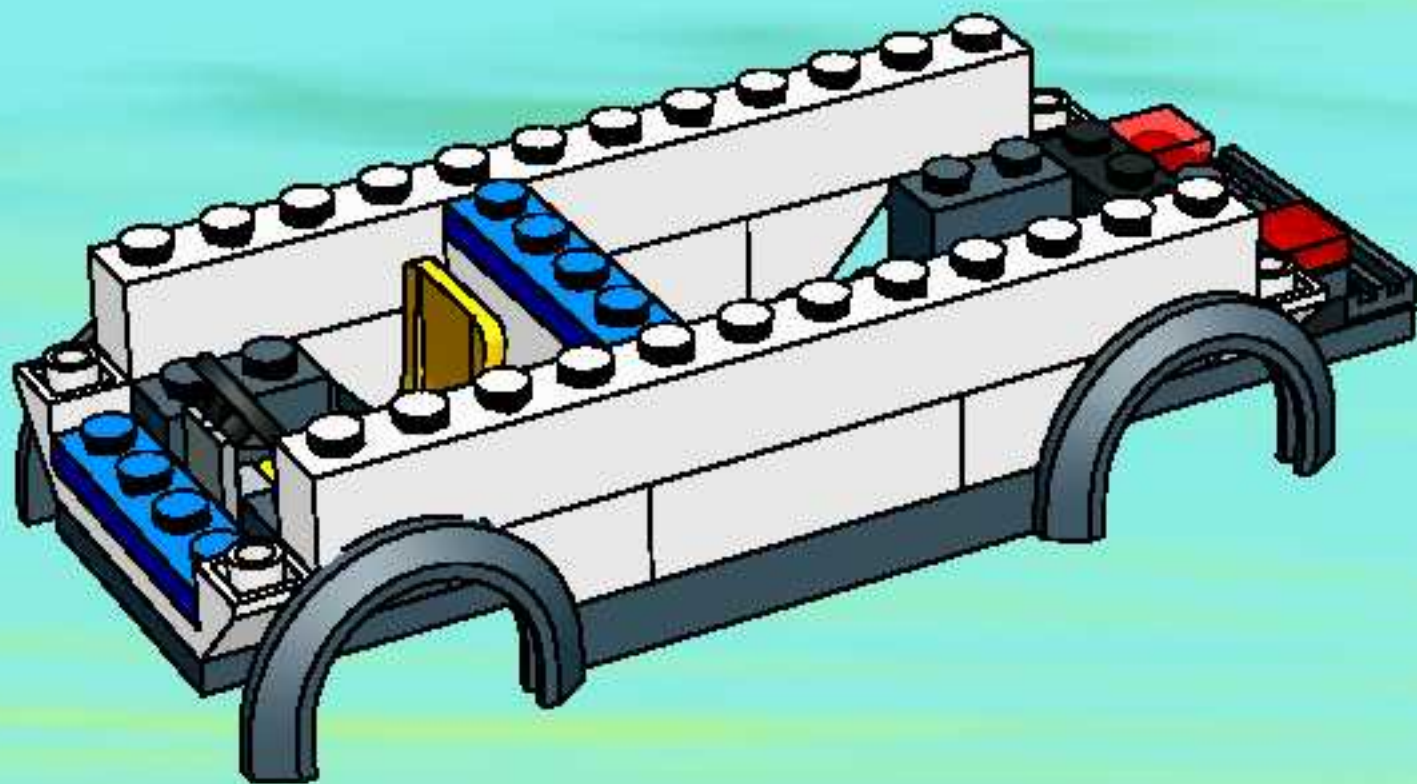



8

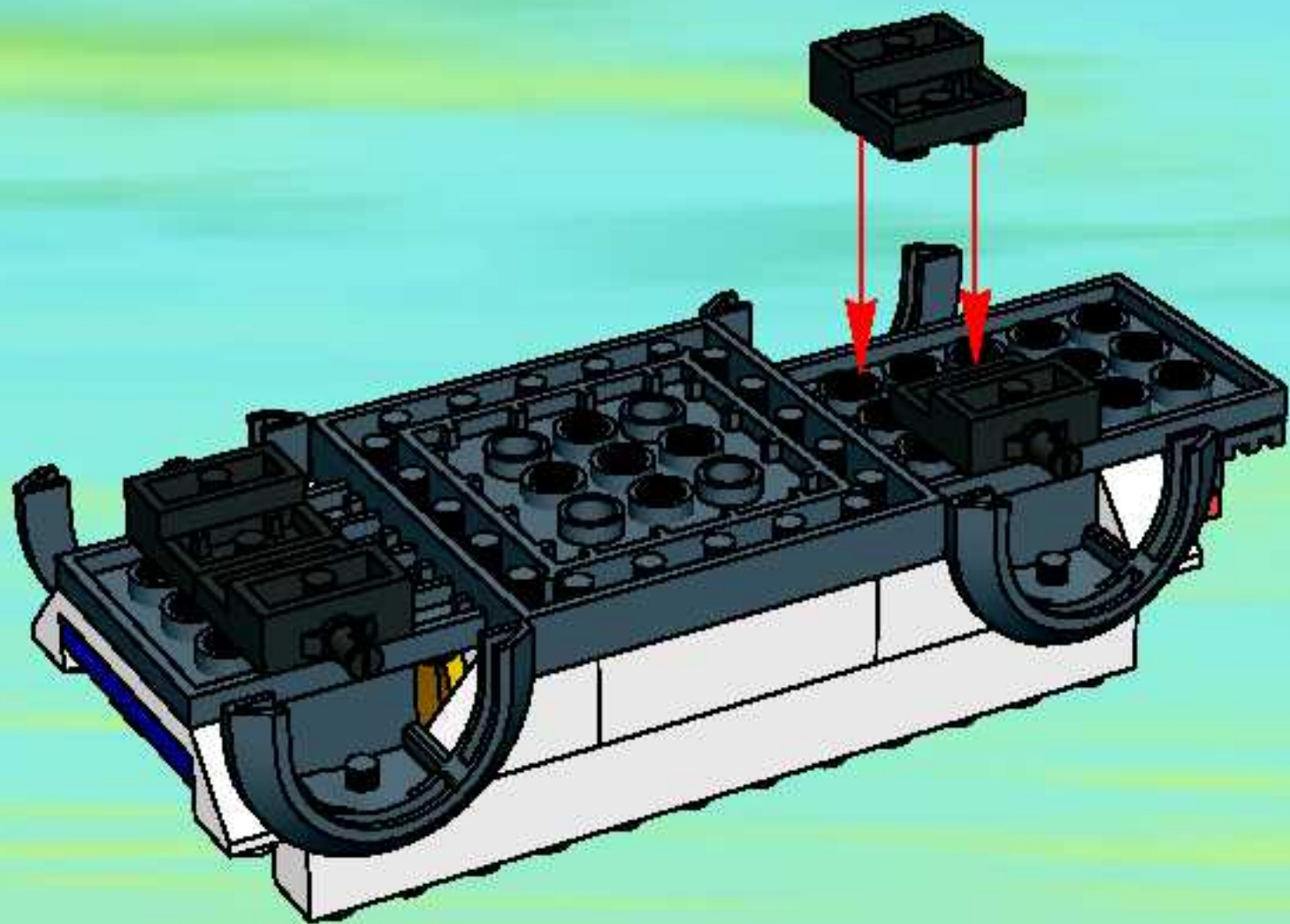

9

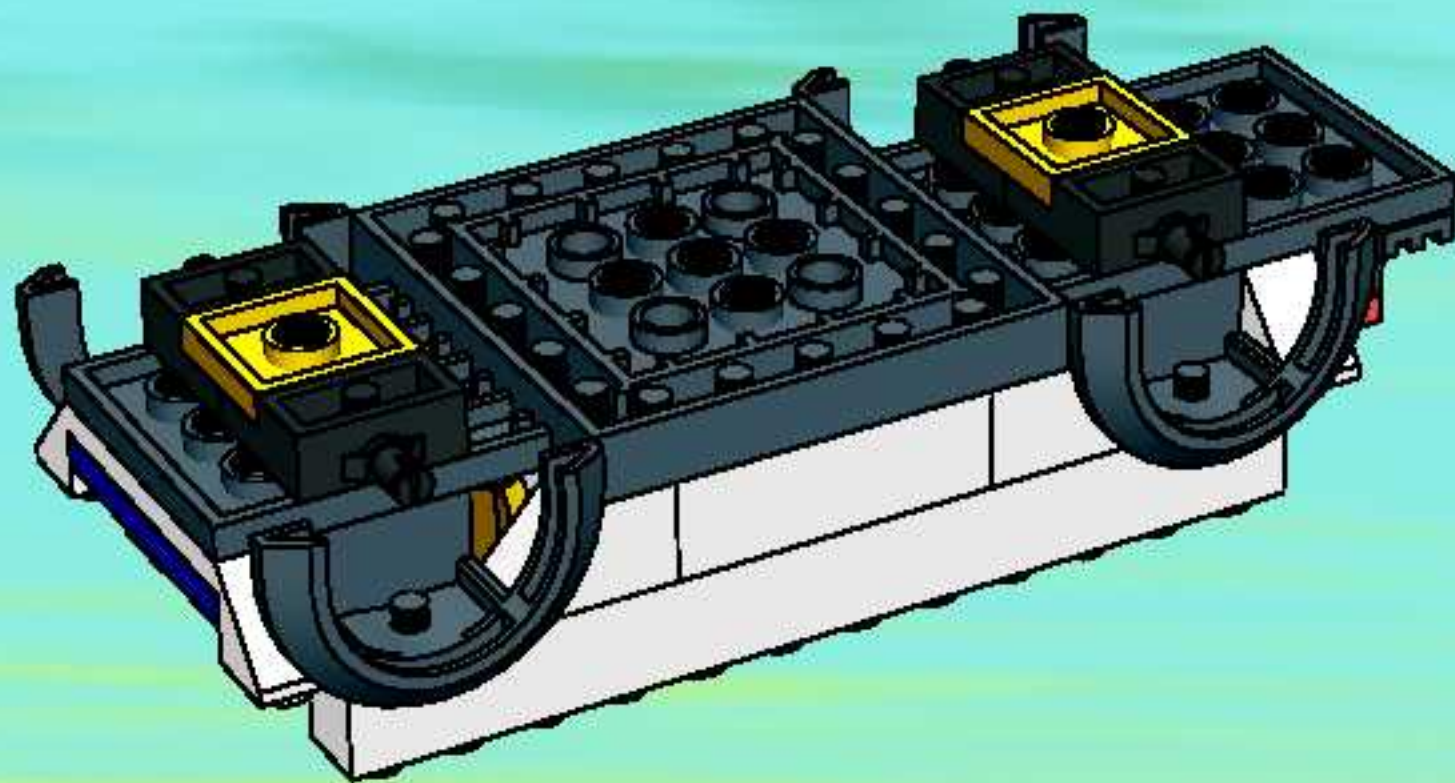

10

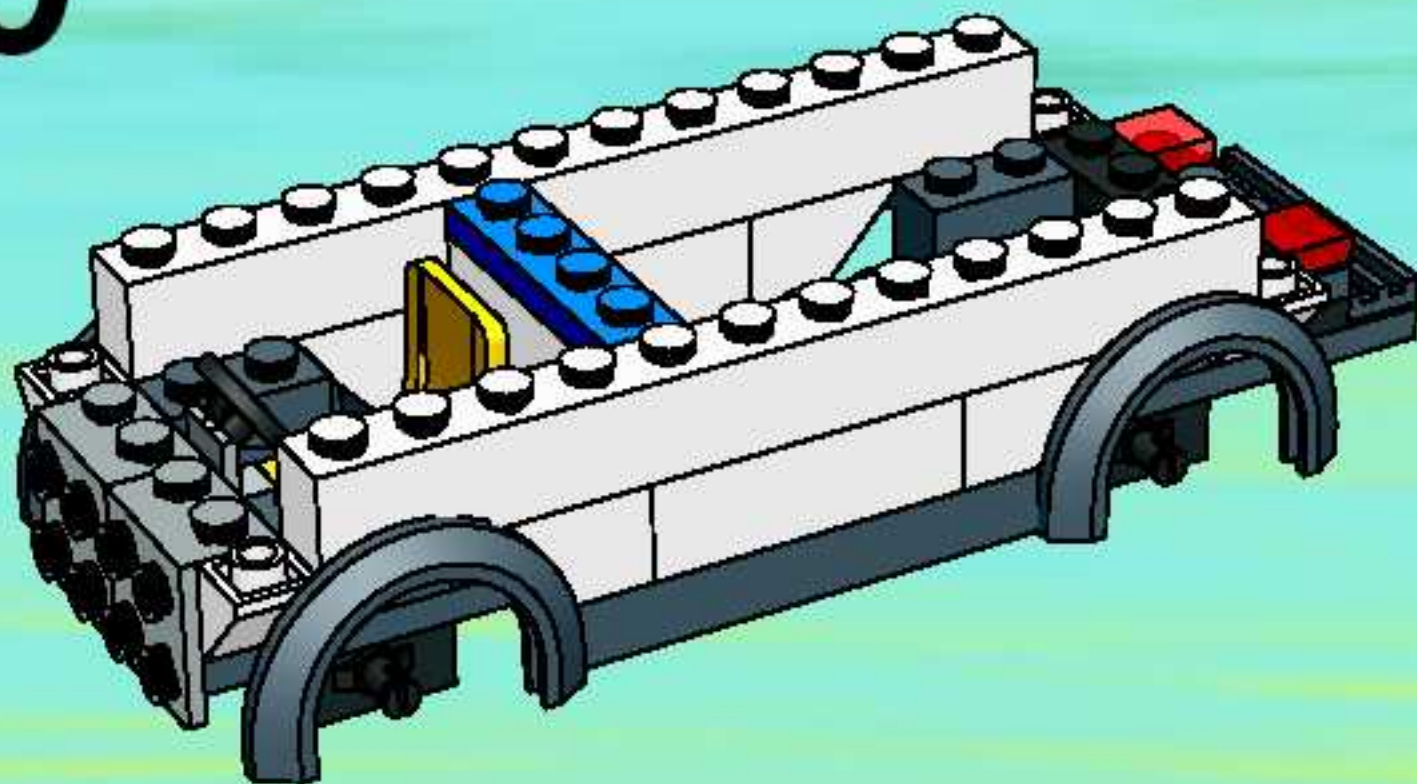

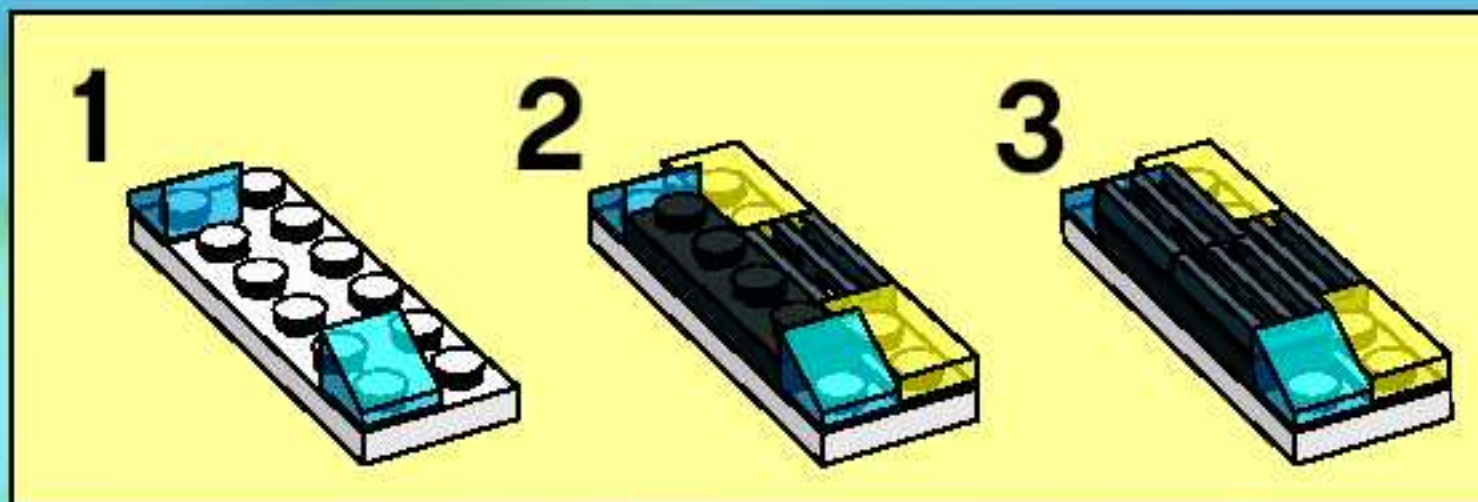

11

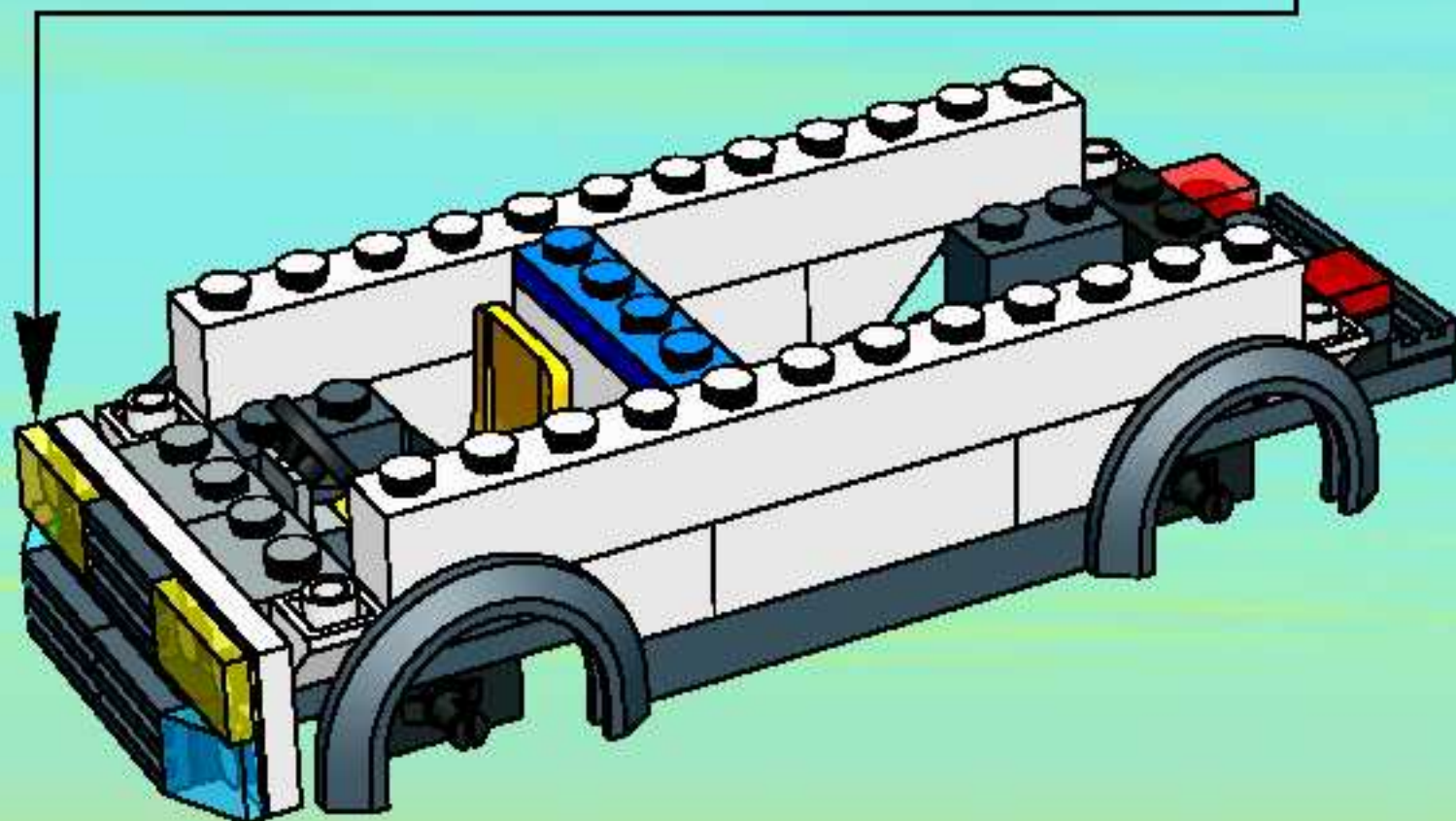

12

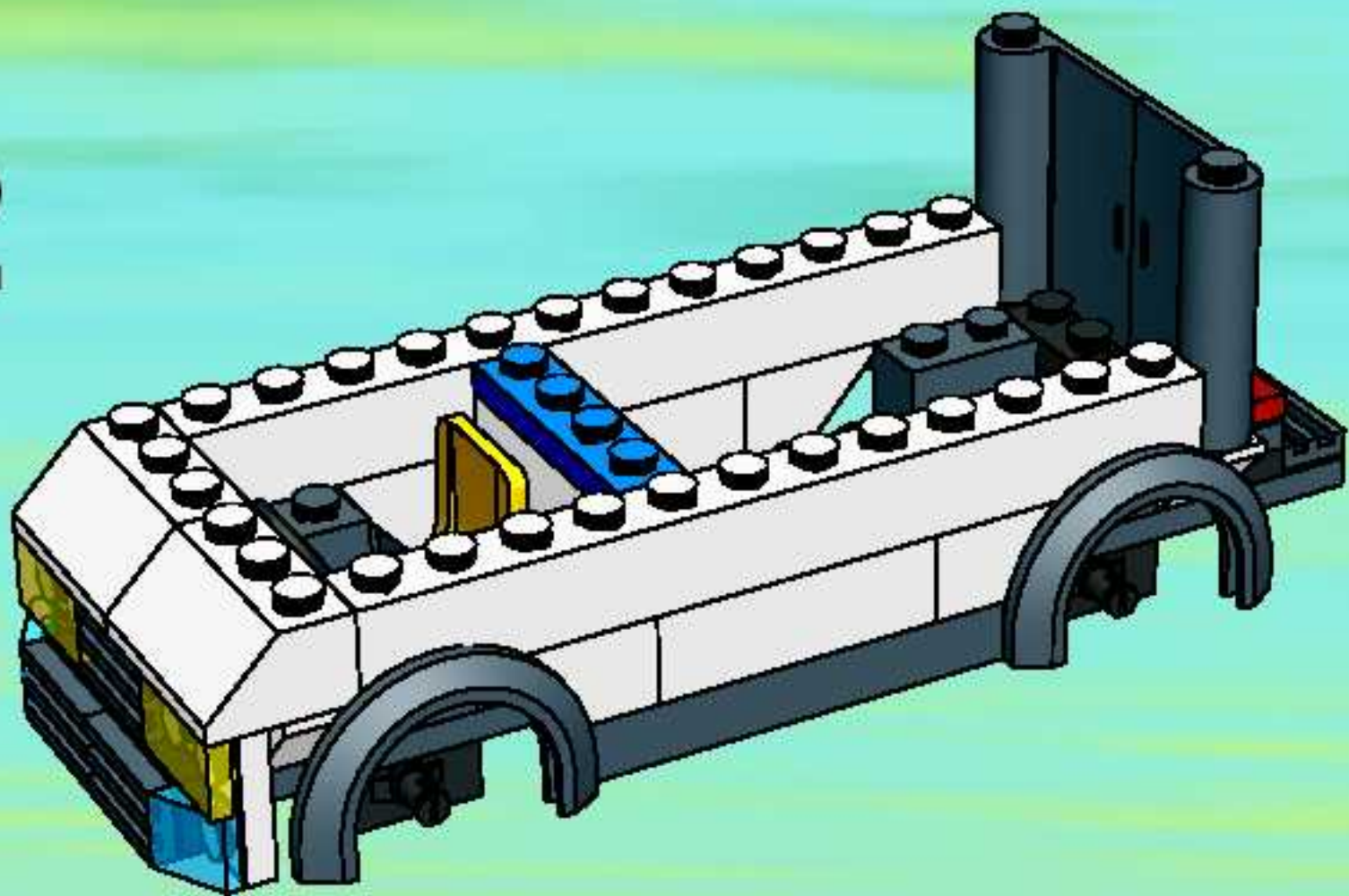

13

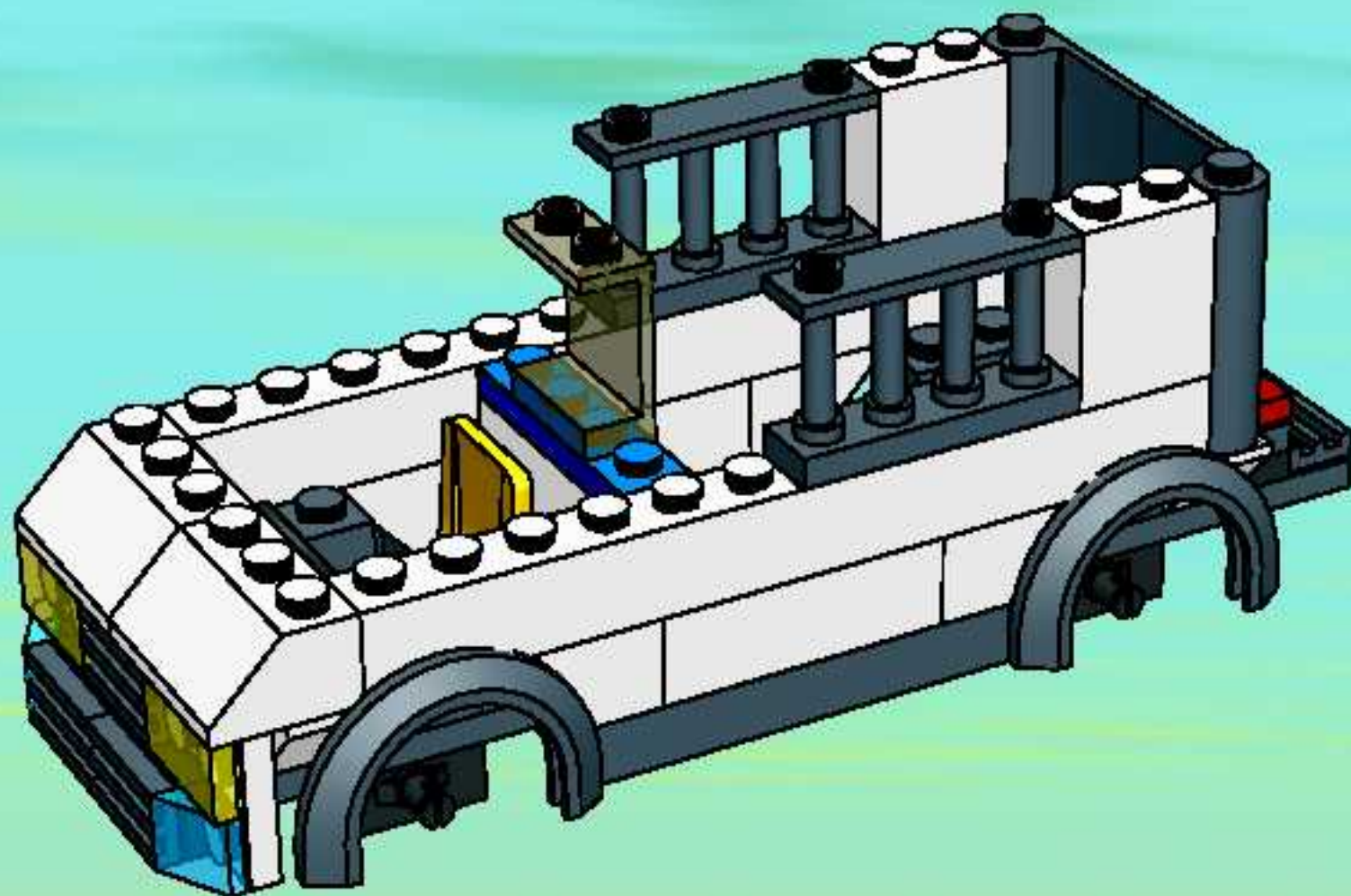

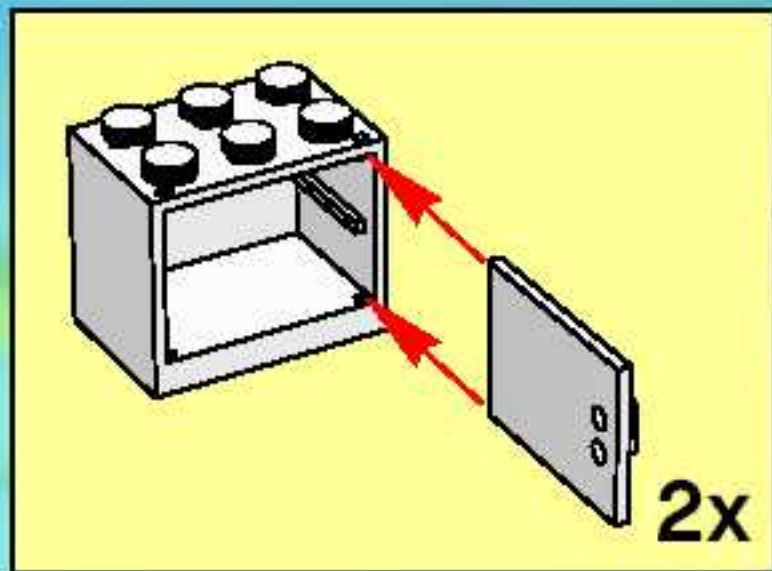

14

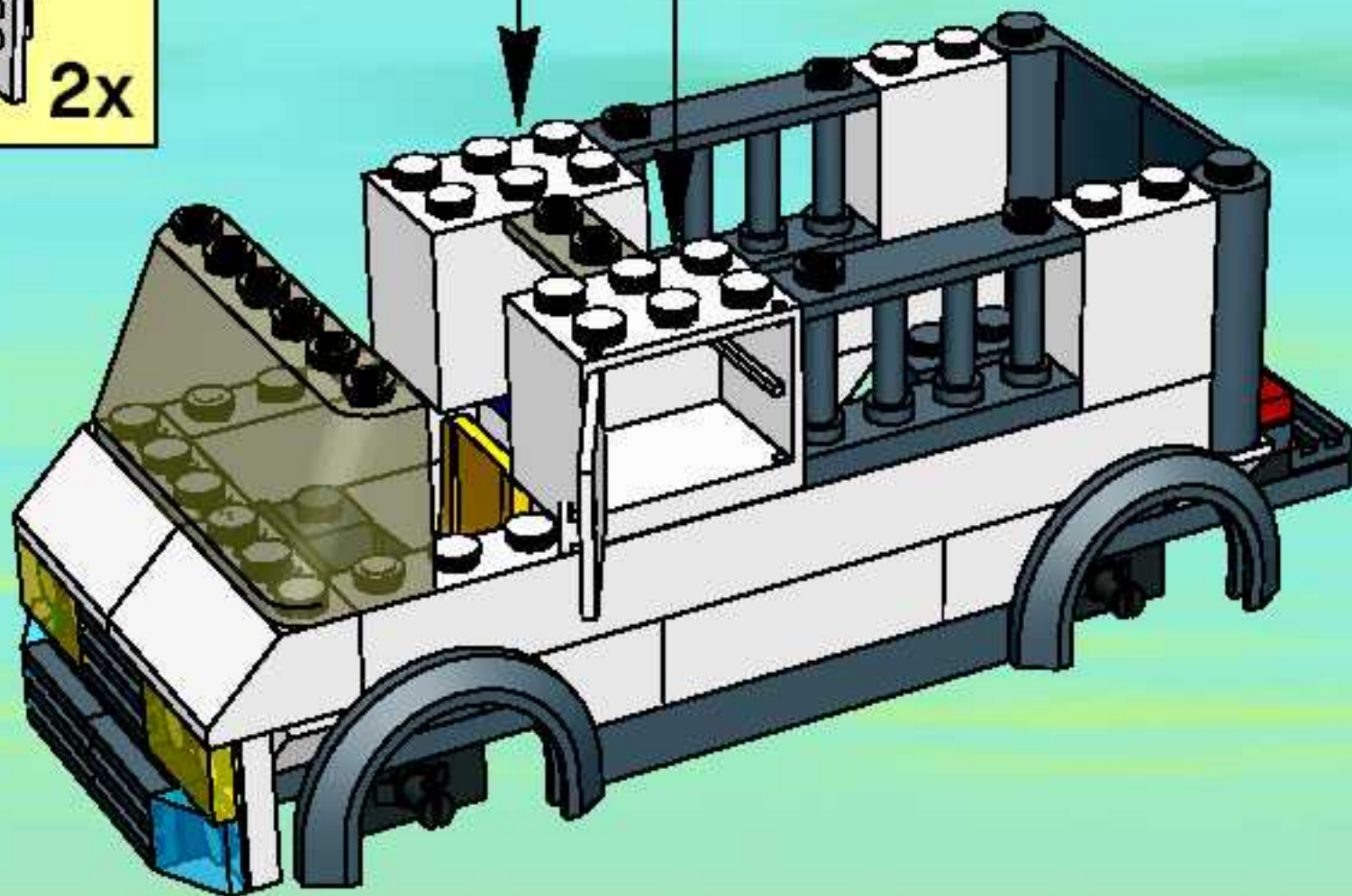

15

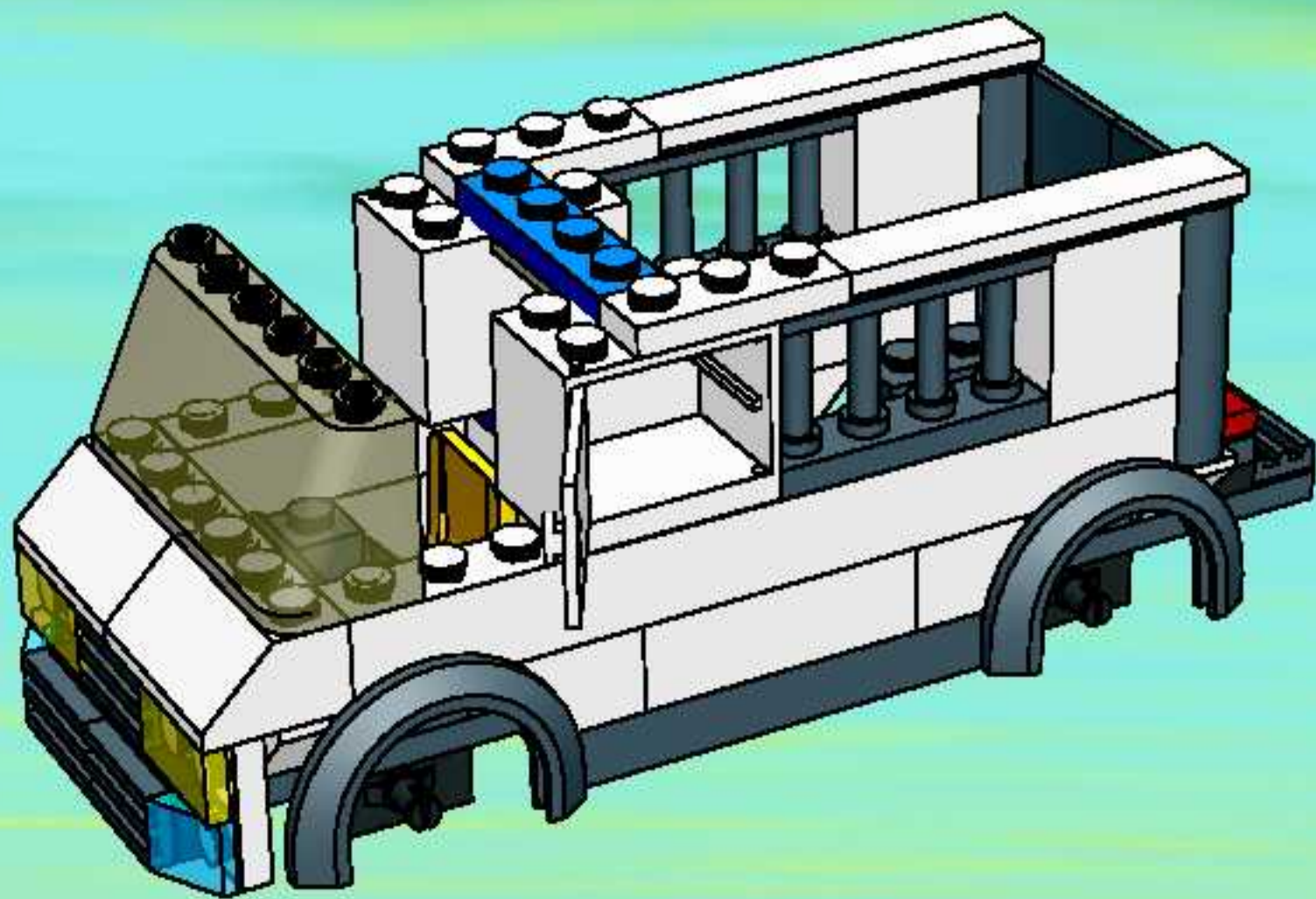



16

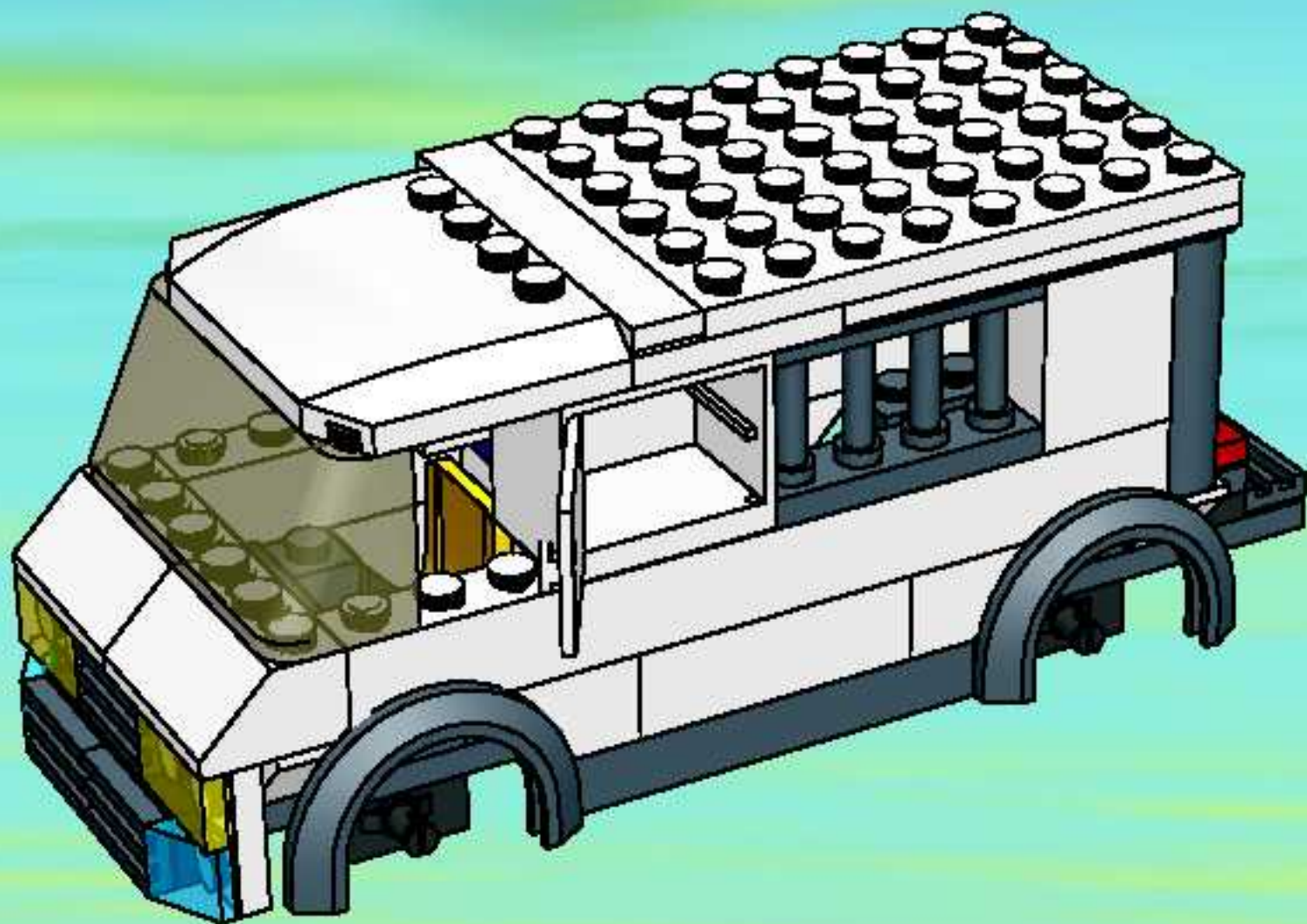

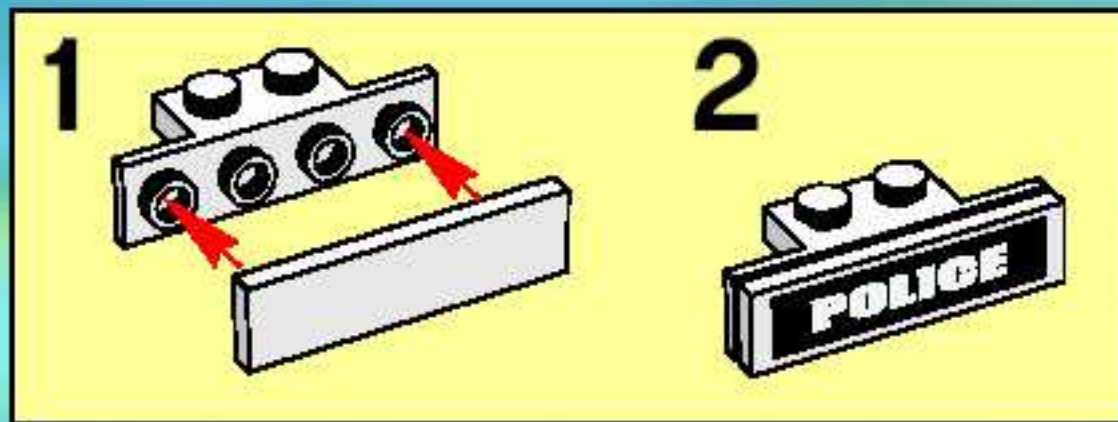

17

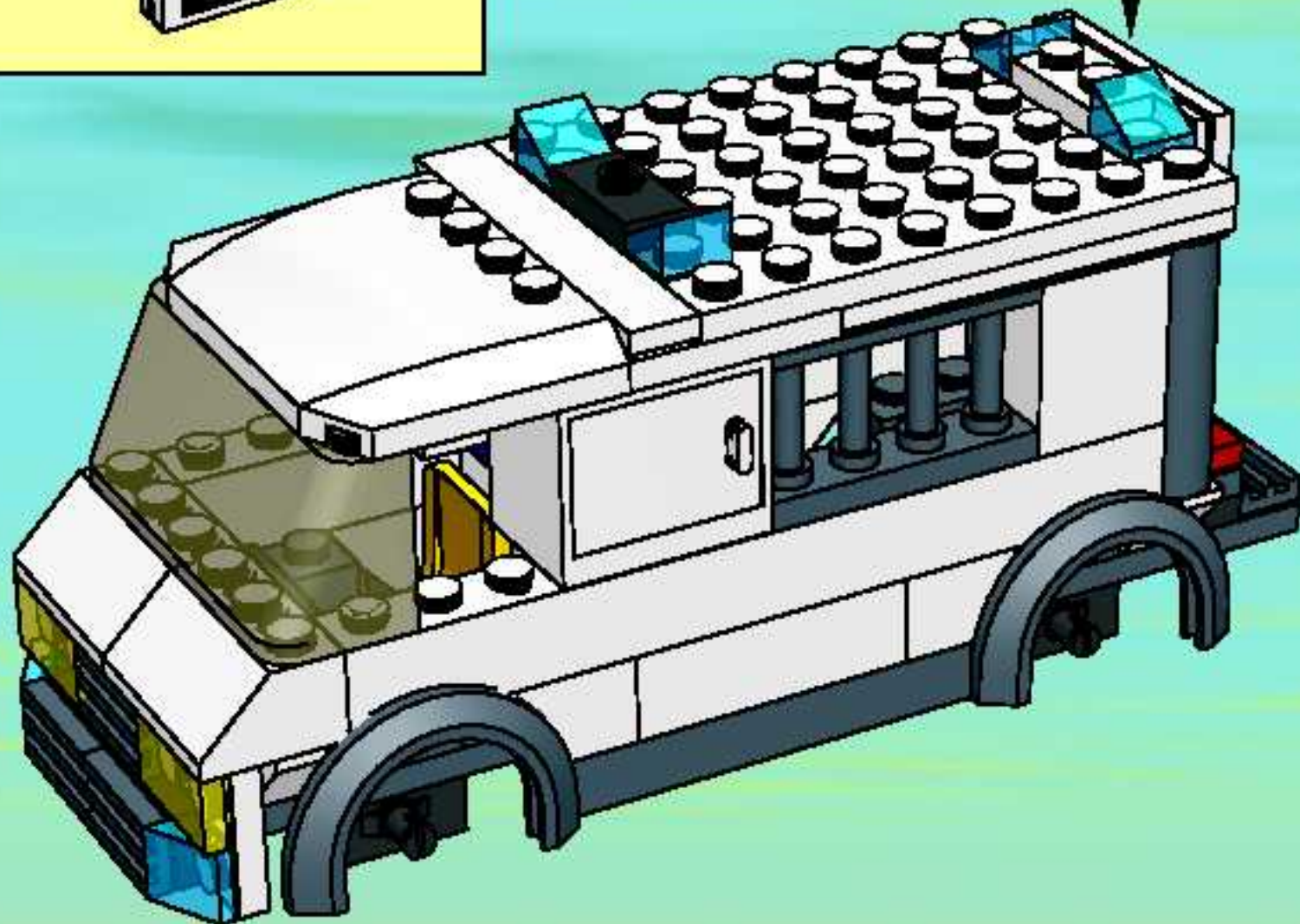

18

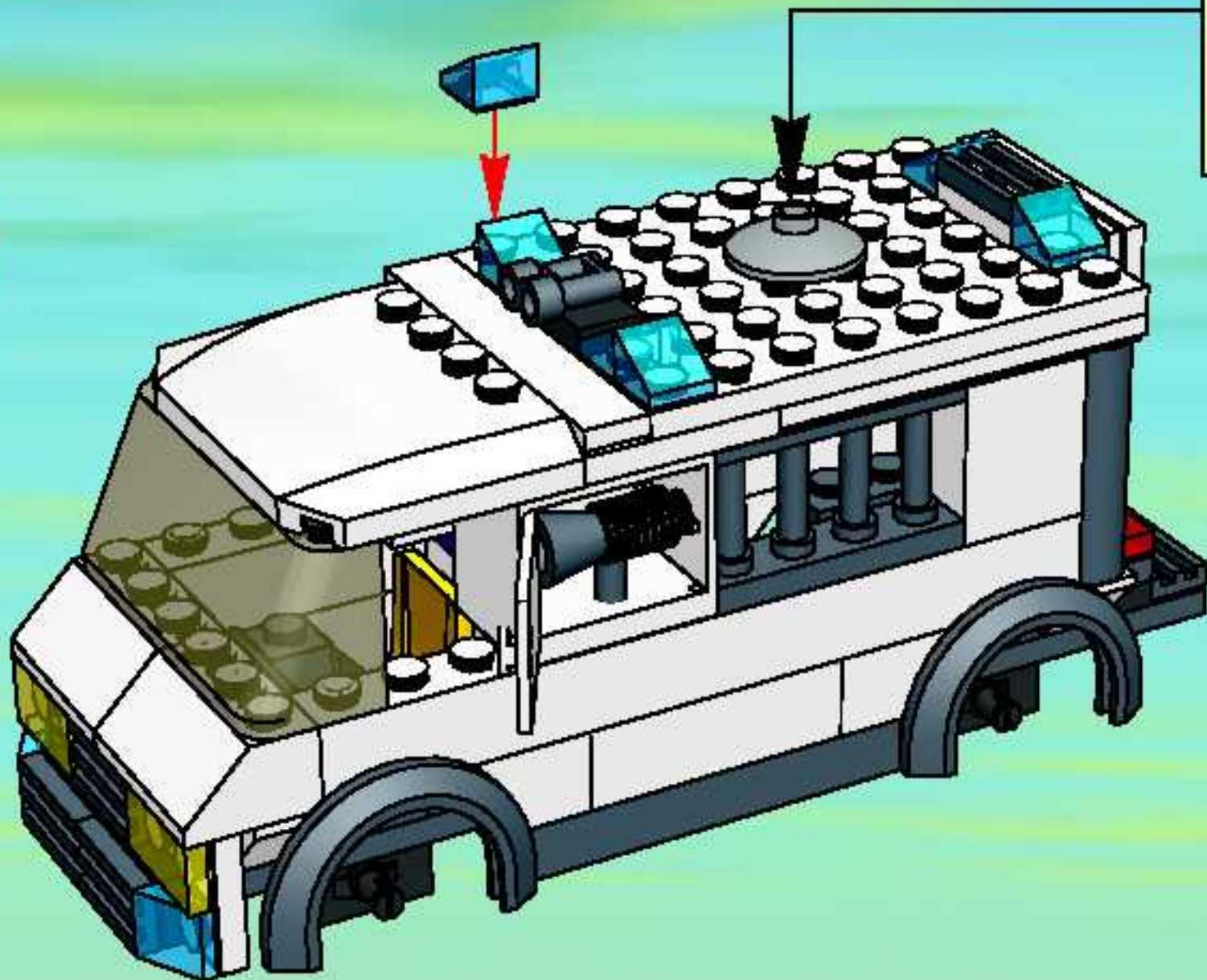

19







7237



7235



7236



7245



7238



7246



7240



7239



7241

# Win! Gagne! Gewinne! 当たります



## WIN LEGO® PRODUCTS

We would like to know what you think about our new LEGO® product.

Log on to the web address below for further instructions.

## GAGNE DES PRODUITS LEGO®

Nous aimerions savoir ce que tu penses de ton nouveau produit LEGO®.

Tu obtiendras davantage d'informations en visitant le site Internet indiqué ci-dessous.

## GEWINNE LEGO® PRODUKTE

Wir sind sehr an deiner Meinung über dein neues LEGO® Produkt interessiert.

Gehe einfach zu der unten angegebenen Webadresse - dort findest du weitere Informationen.

## 日本でレゴ®製品が当たります

詳しくは、以下のウェブアドレスまでアクセスしてください。

## ESTIMADO USUARIO LEGO®

Al contestar algunas preguntas en Inglés, francés, alemán o japonés en el sitio [www.acnielsen.aim.dk/lego](http://www.acnielsen.aim.dk/lego), podrás participar en el sorteo de algunos valiosos premios LEGO®.

## CARO CONSUMIDOR DA LEGO®

Ao responder a algumas perguntas em Inglês, Francês, Alemão ou Japonês no endereço [www.acnielsen.aim.dk/lego](http://www.acnielsen.aim.dk/lego) irá participar num concurso para ganhar valiosos prémios de LEGO®.

## KEDVES IFJÚ LEGO® VÁSÁRLÓ

Ha ellágotasz a [www.acnielsen.aim.dk/lego](http://www.acnielsen.aim.dk/lego) honlapra és ott angol, francia, német vagy japán nyelven megválaszolsz néhány kérdést, akkor részt veszel egy versenyben, amelyben értékes LEGO® díjakat nyerhetsz.

[www.acnielsen.aim.dk/LEGO](http://www.acnielsen.aim.dk/LEGO)

LEGO, the LEGO logo, the CLIFTS logo and BIONICLE are trademarks of the LEGO Group. ©2004 The LEGO Group.  
Ferrari, all associated logos and the distinctive designs are trademarks of Ferrari SpA.  
The body of the Ferrari car is protected as Ferrari property under trade dress and/or design regulations.