



PHARAOH'S QUEST



7326



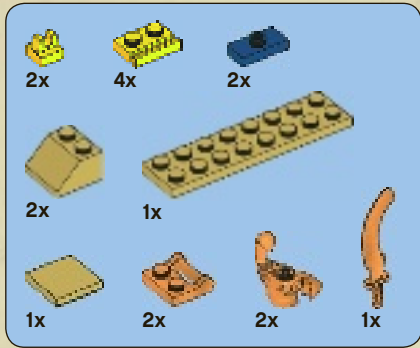
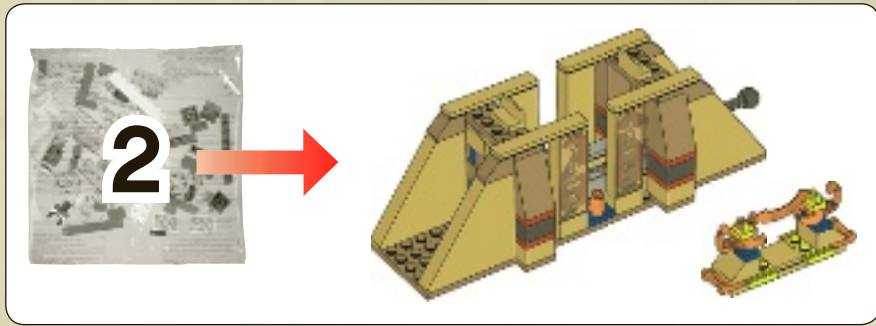

1

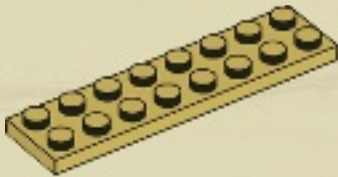

2

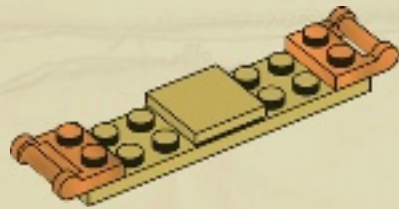

3

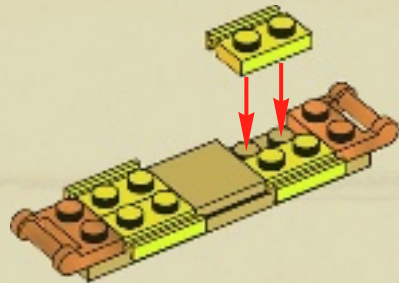

4

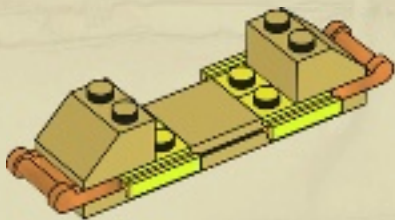

5

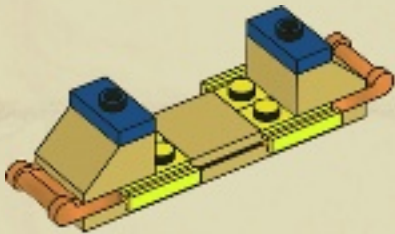

6

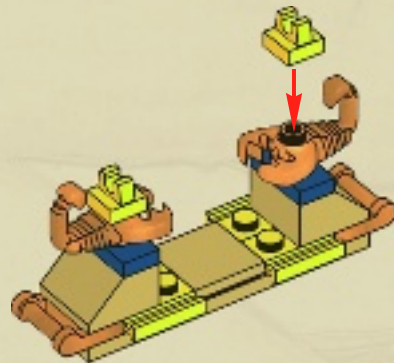

7

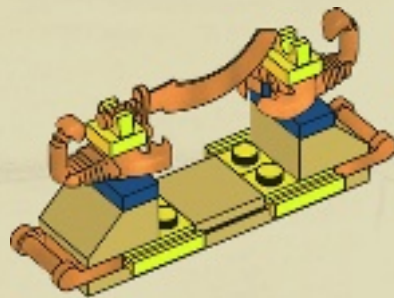

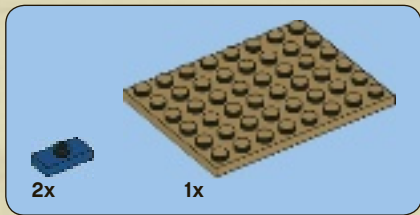
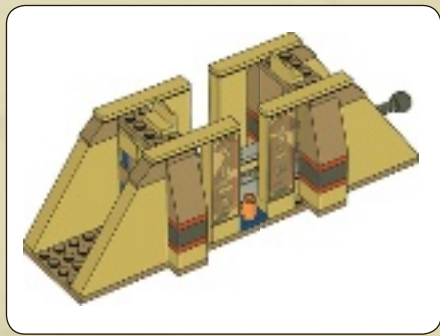

1

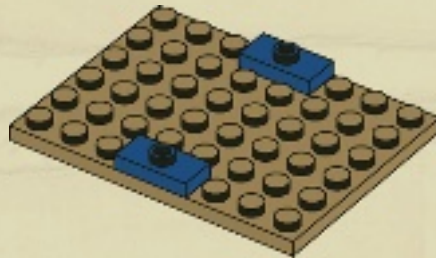

2

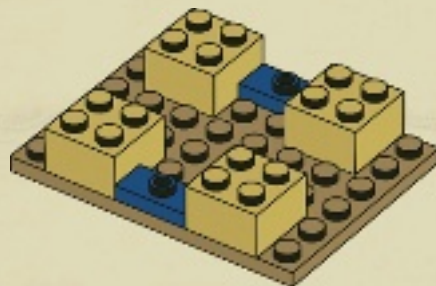



2x

3

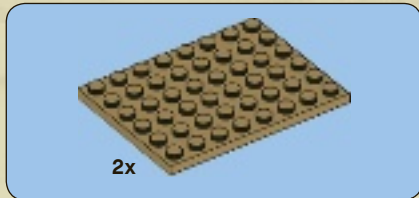
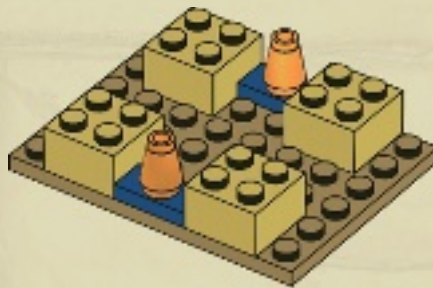

2x

4

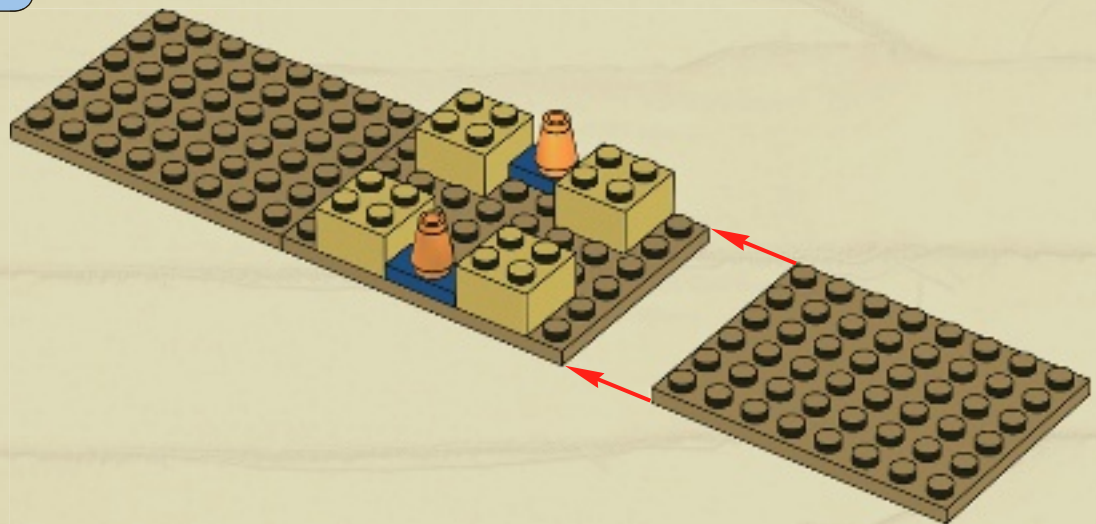



2x

5

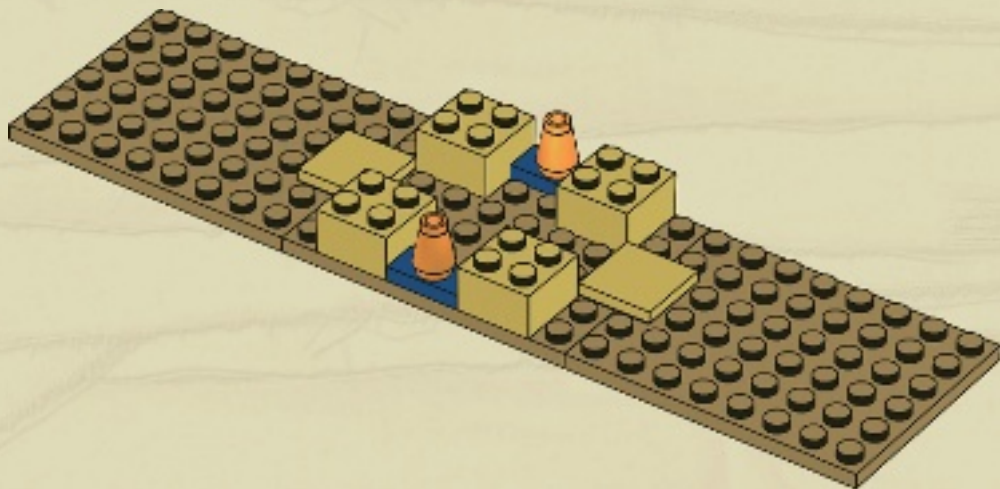

4x

6

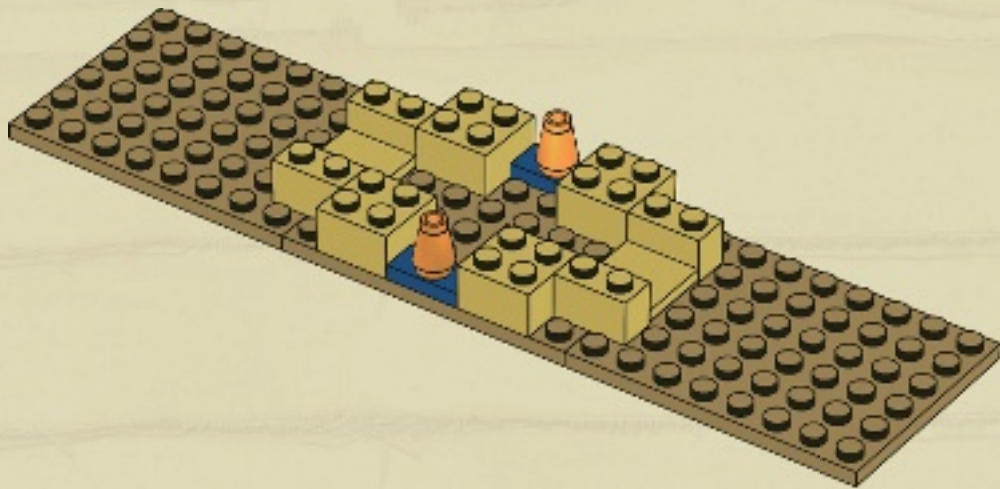

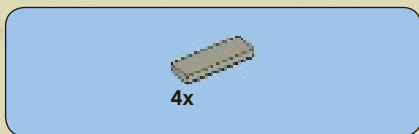

7

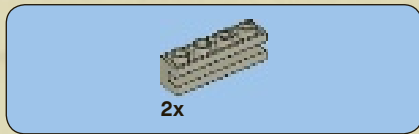
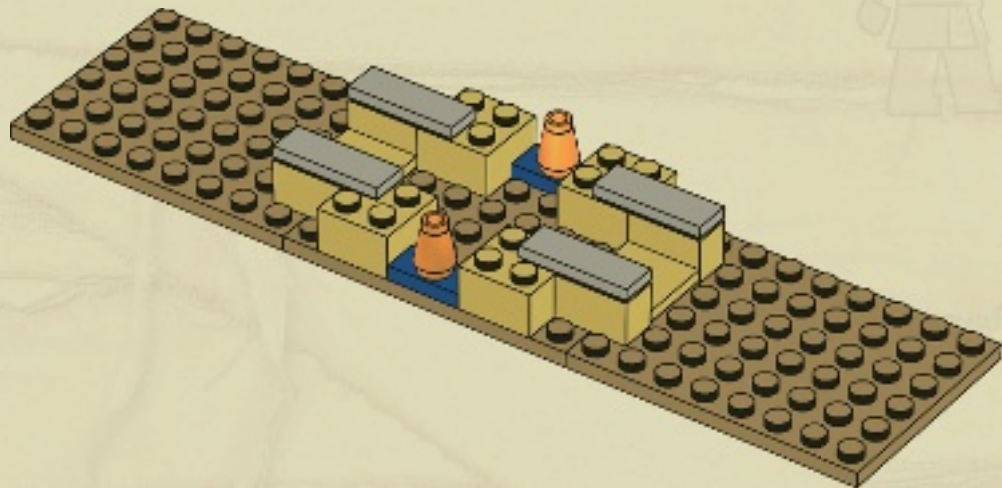

8

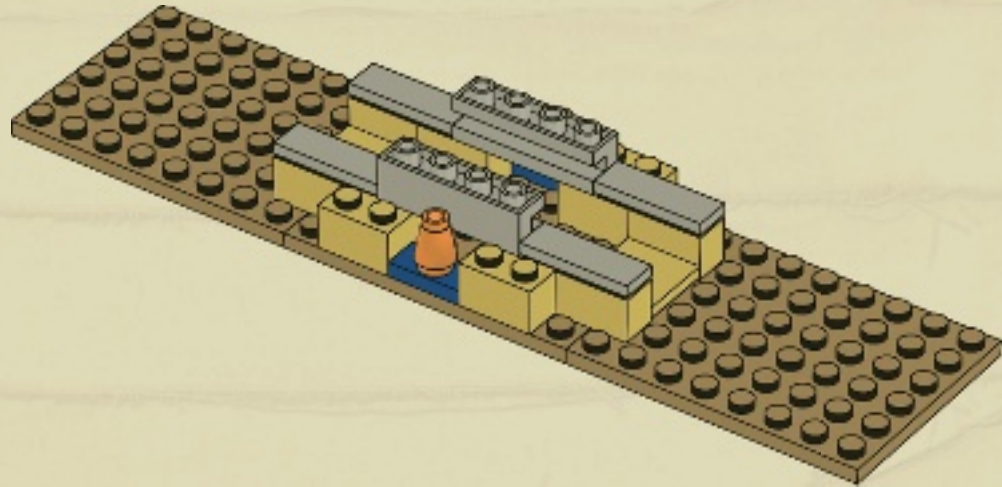

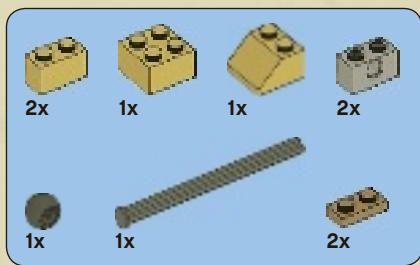

9

1

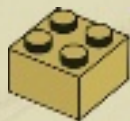

2

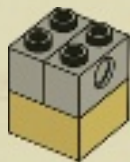

3

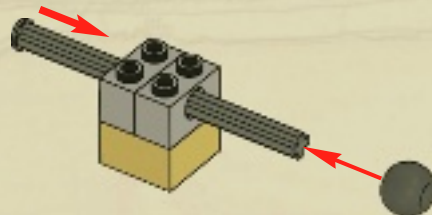

4

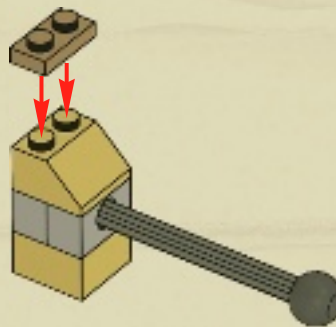



5

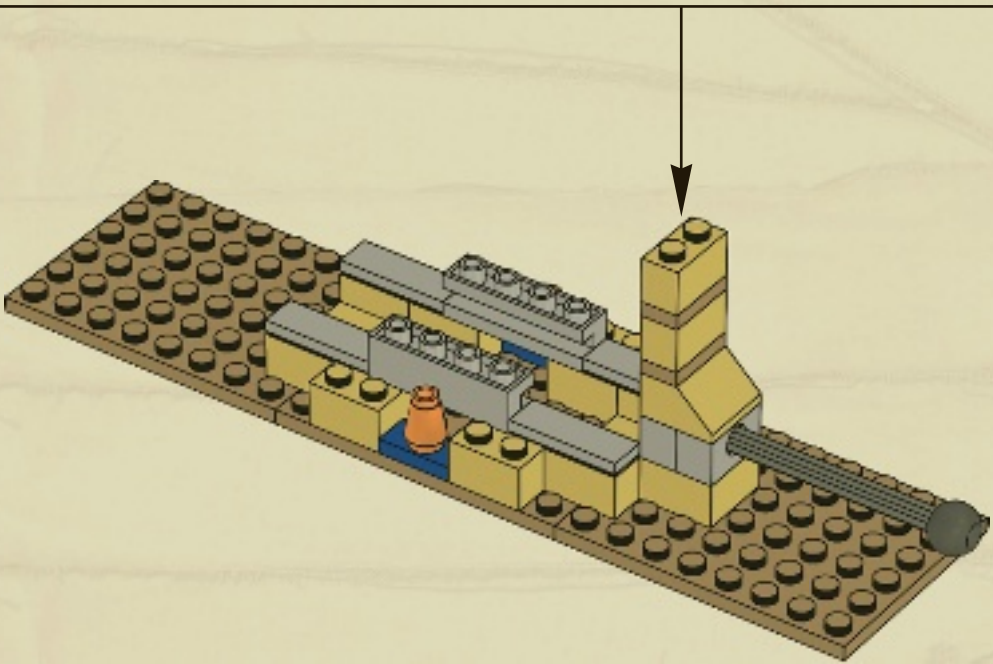
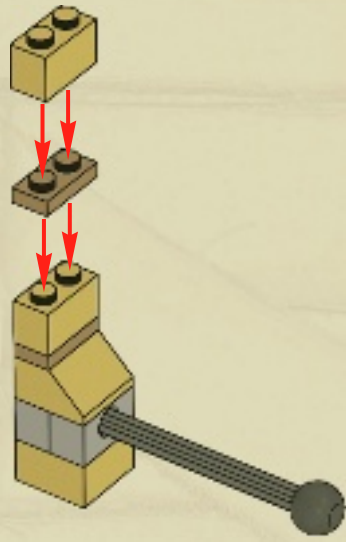

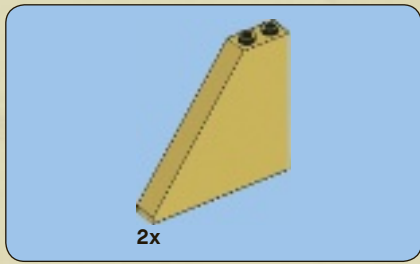

10

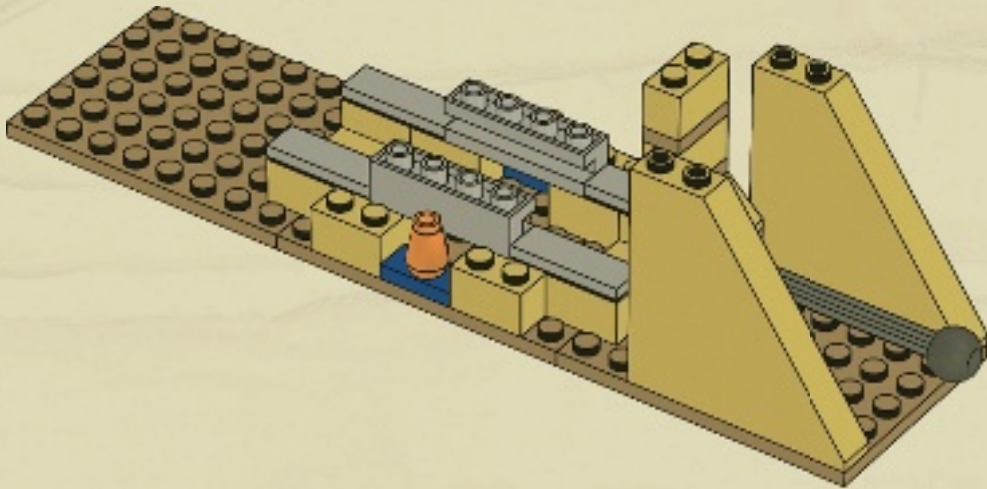



2x

11

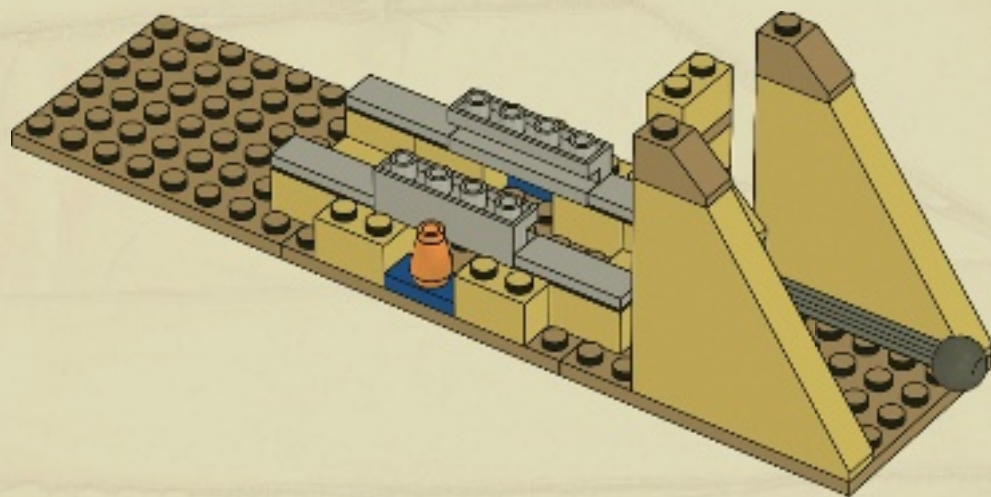



2x

12

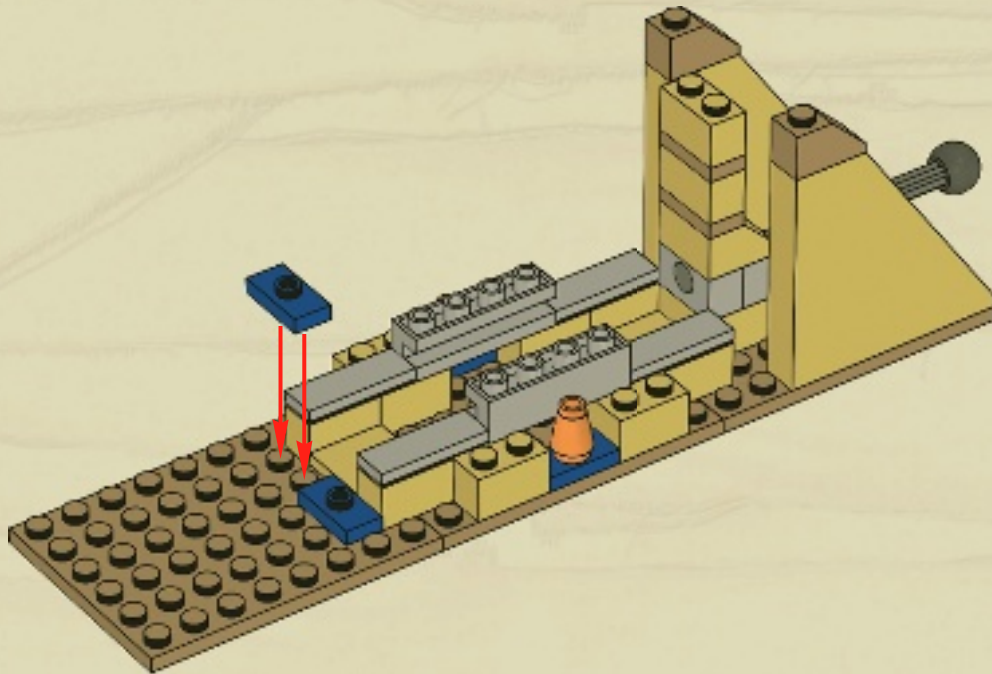



13

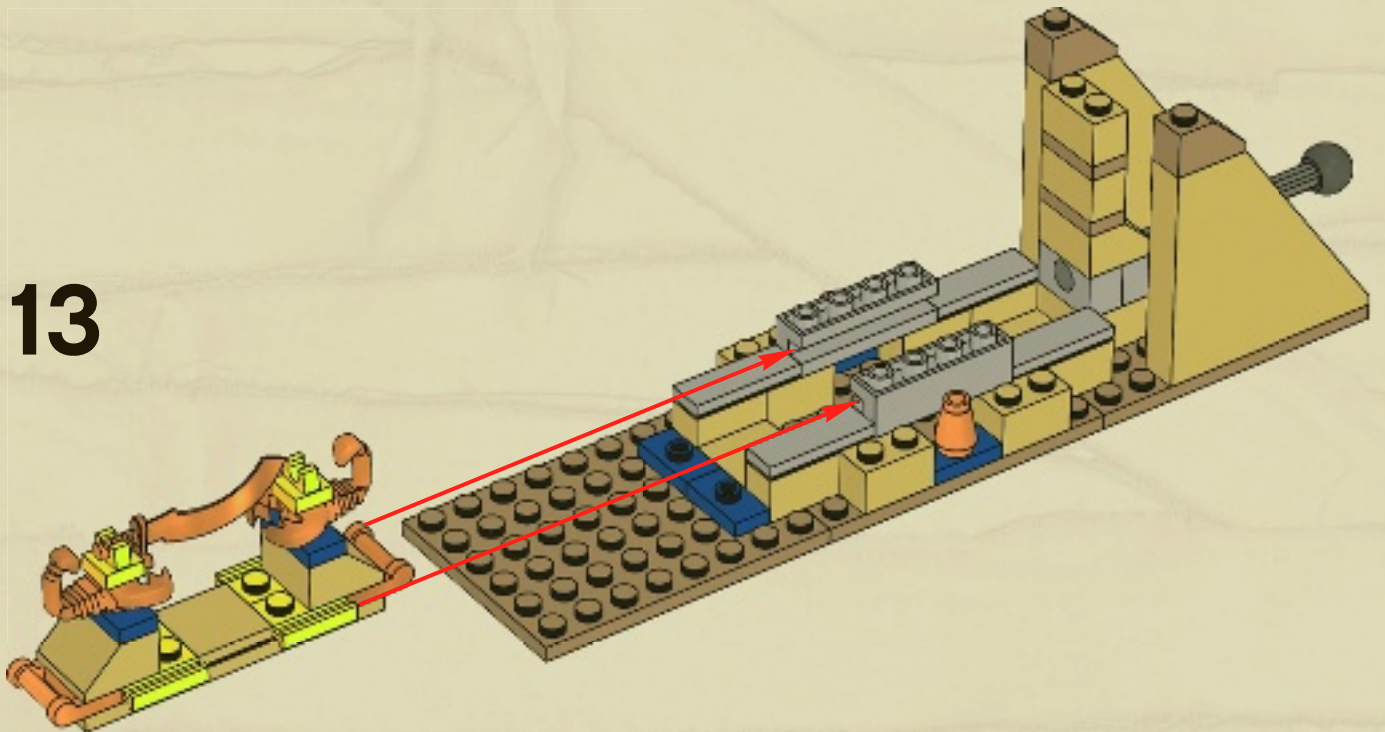

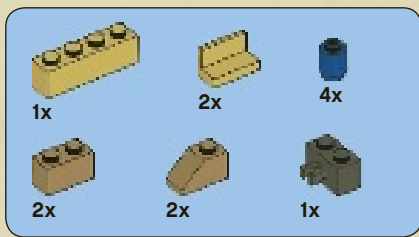

14

1

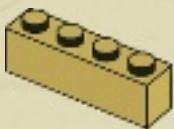

2

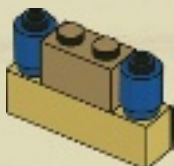

3

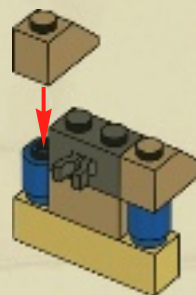

4

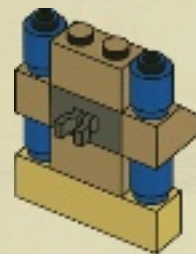

5

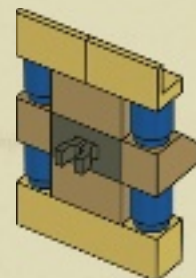

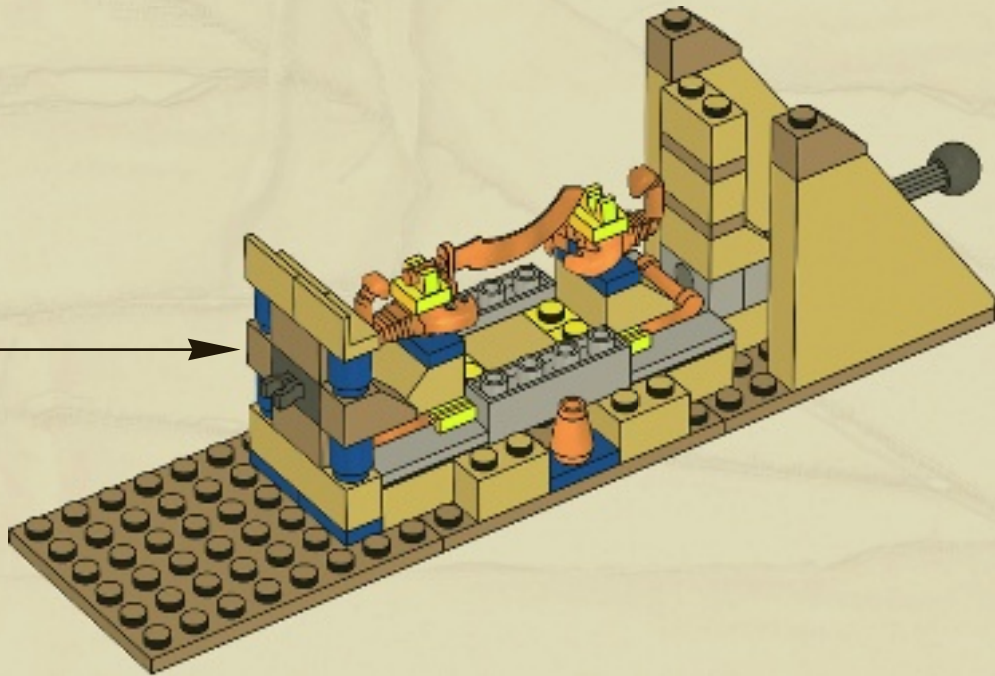

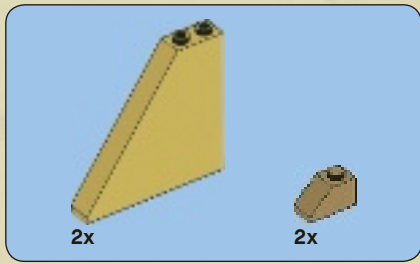

15

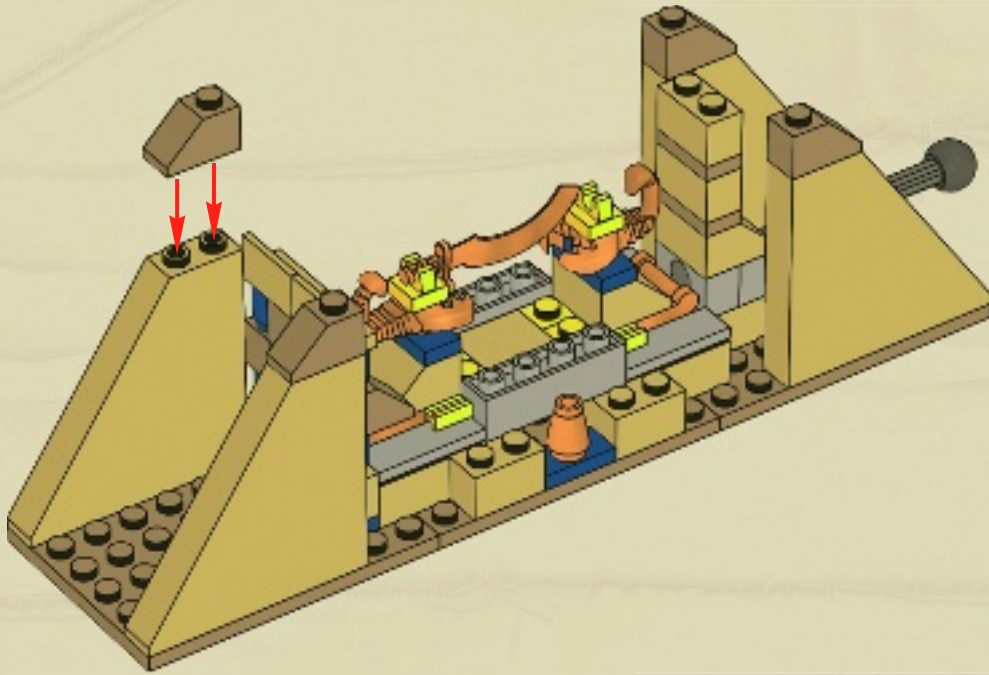

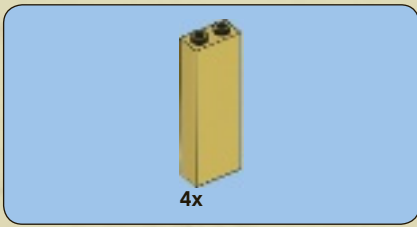

16

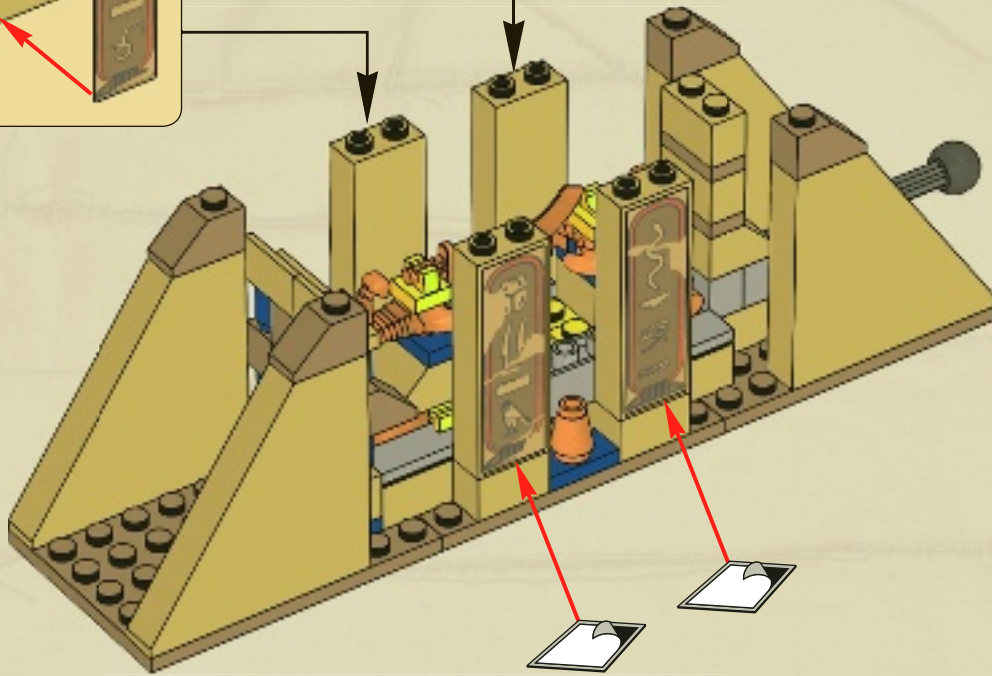
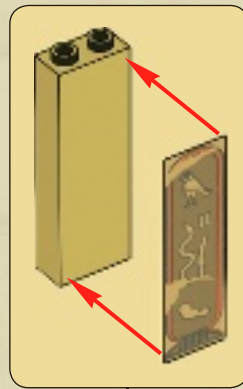
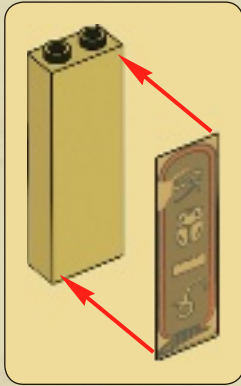

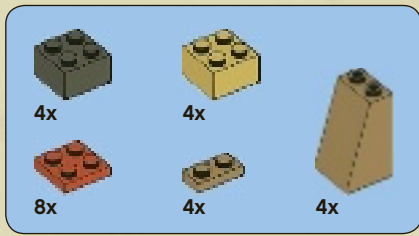

17

1

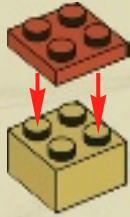

2

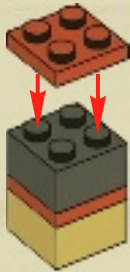

3

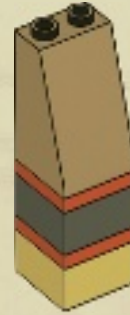

4



4x

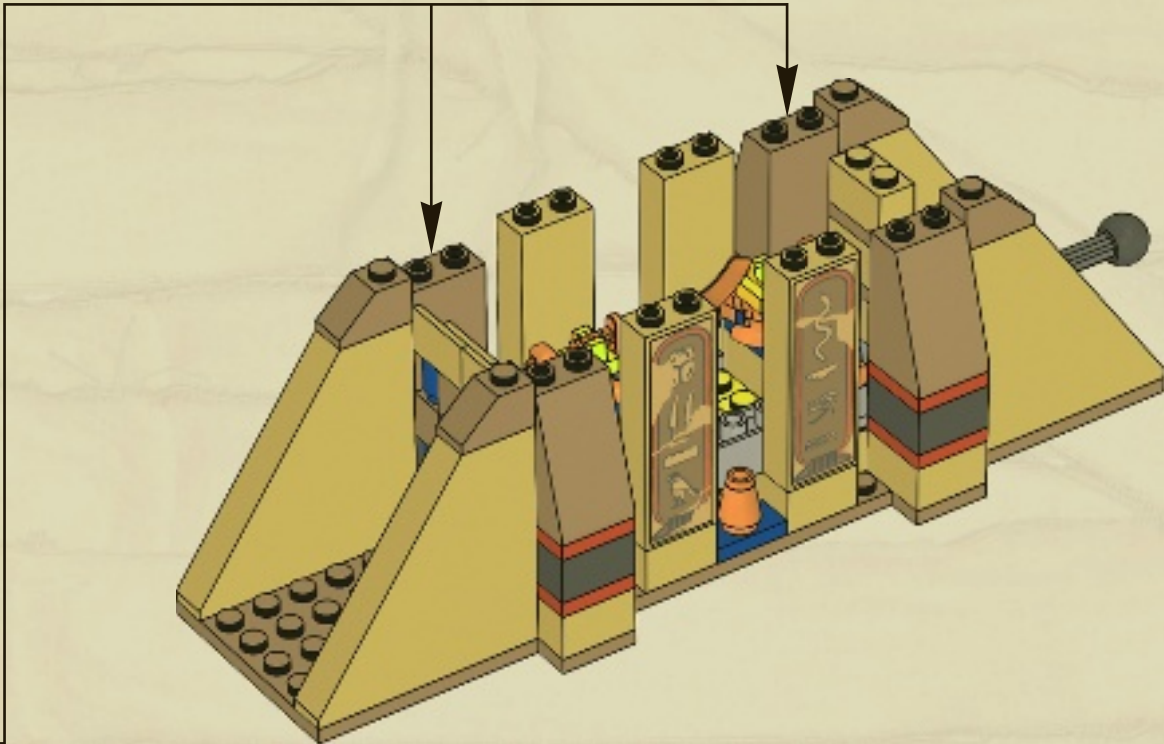



2x

18

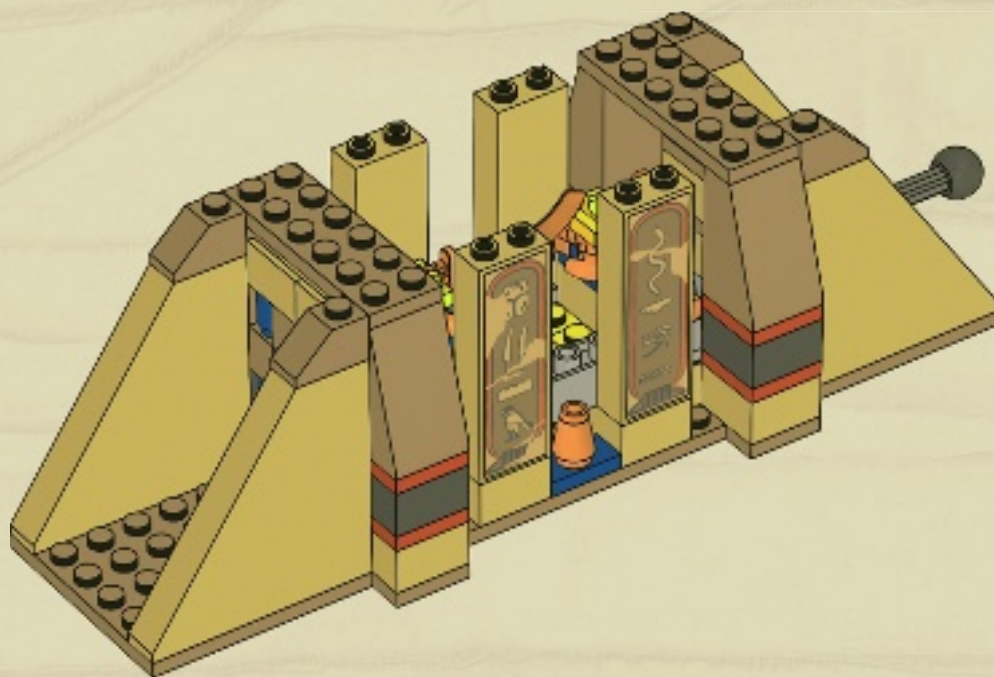



2x



4x

19

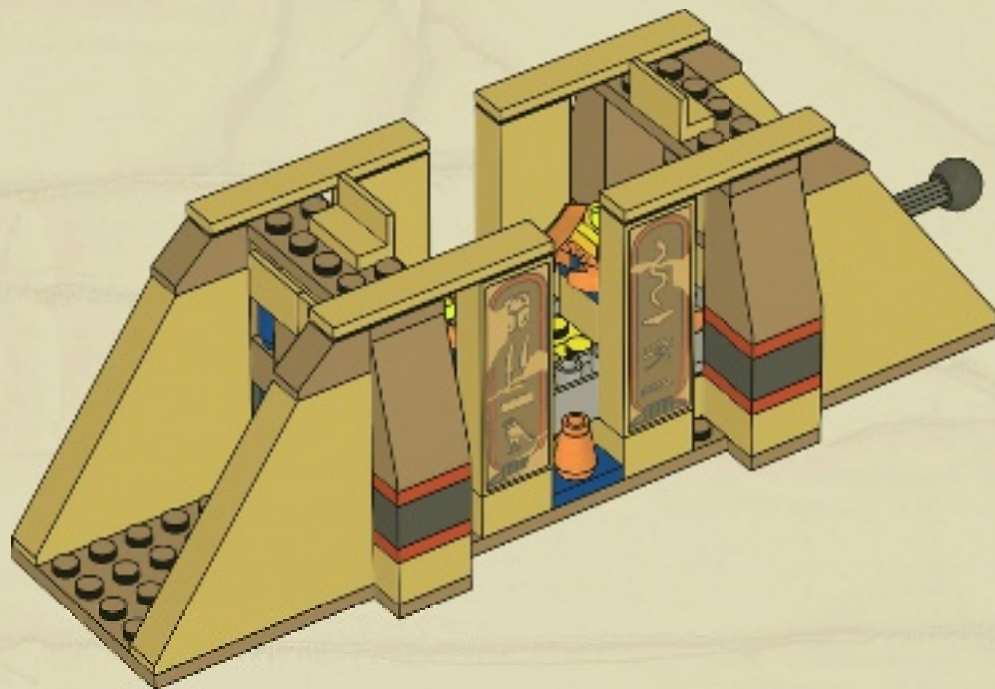

1

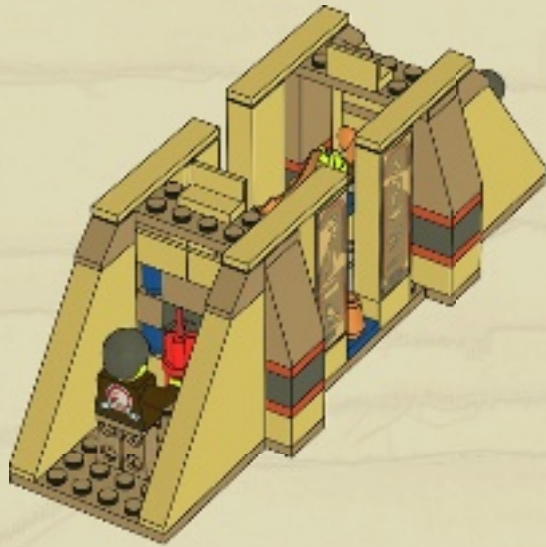

2

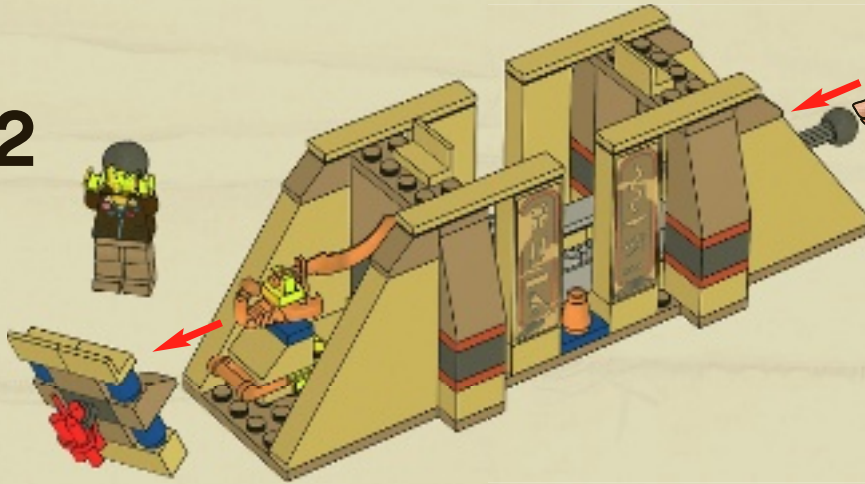

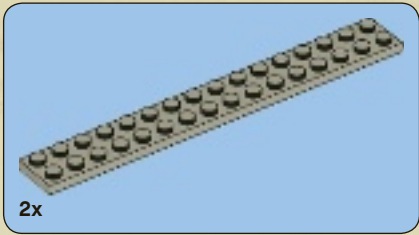
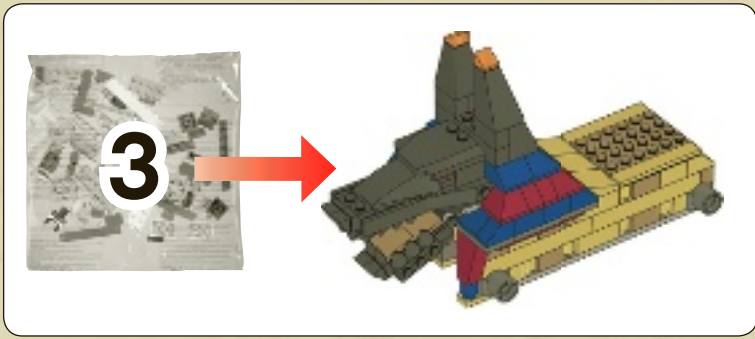

1

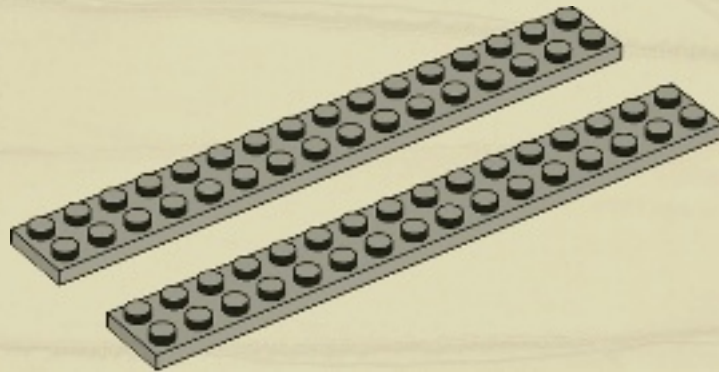



2

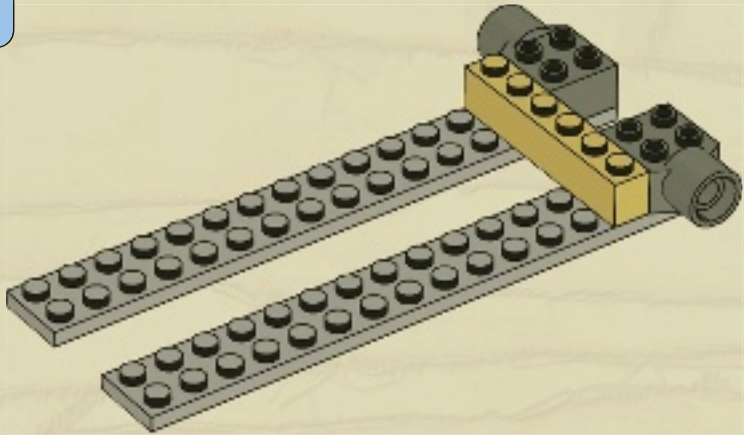

3

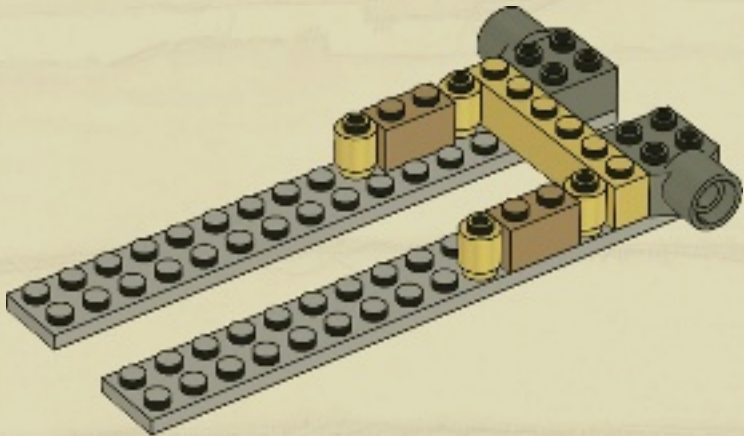



4

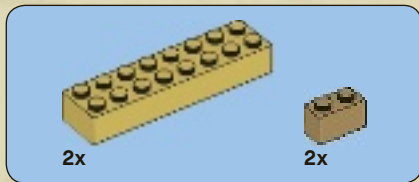
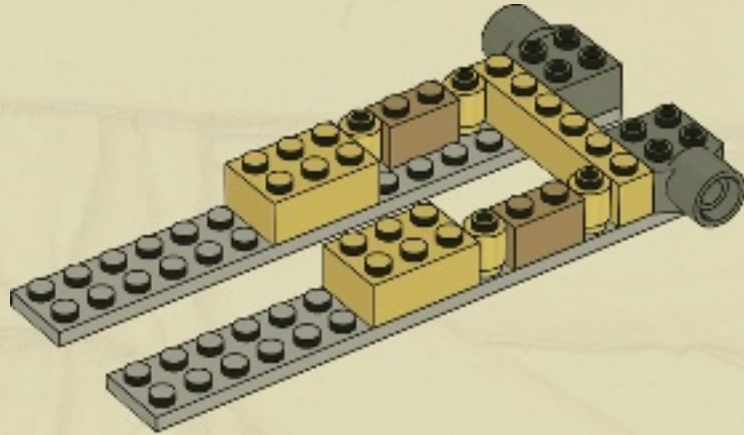

5

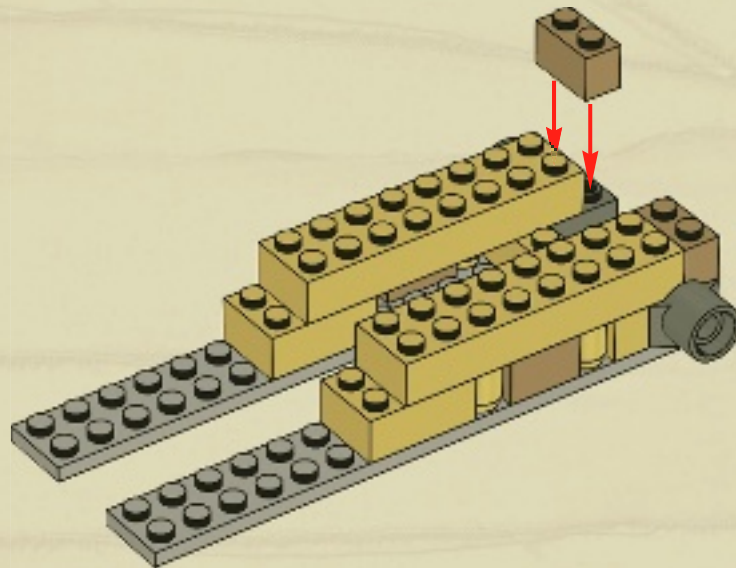



6

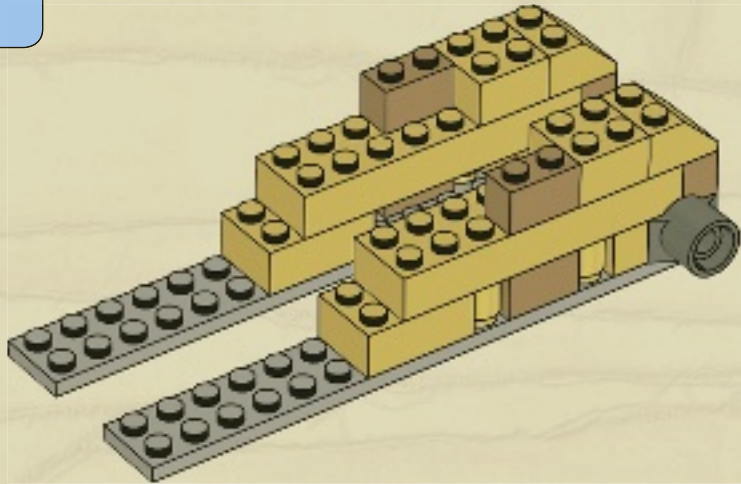

7

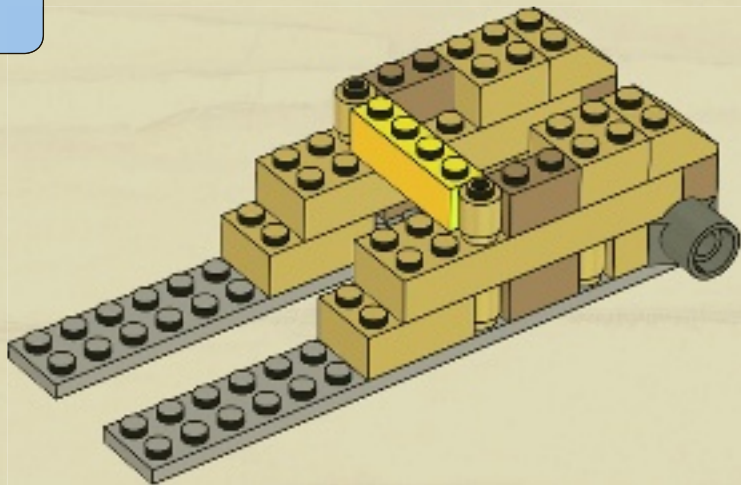

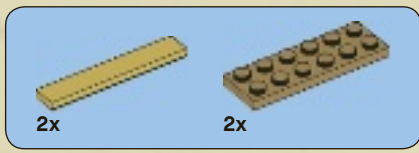

8

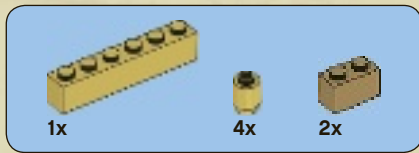
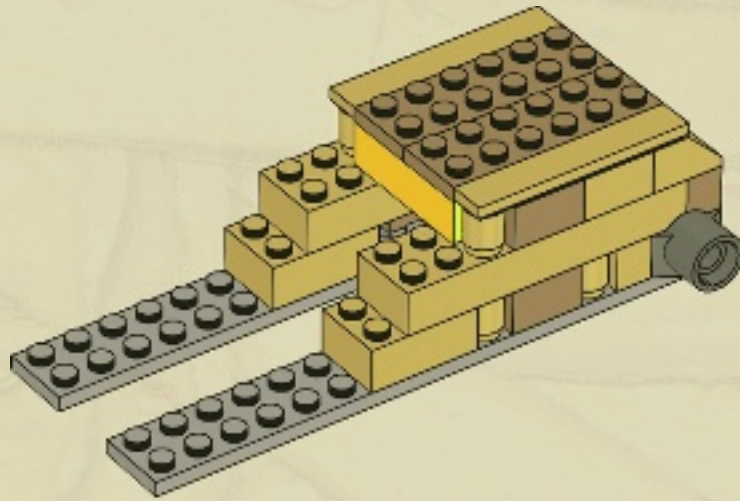

9

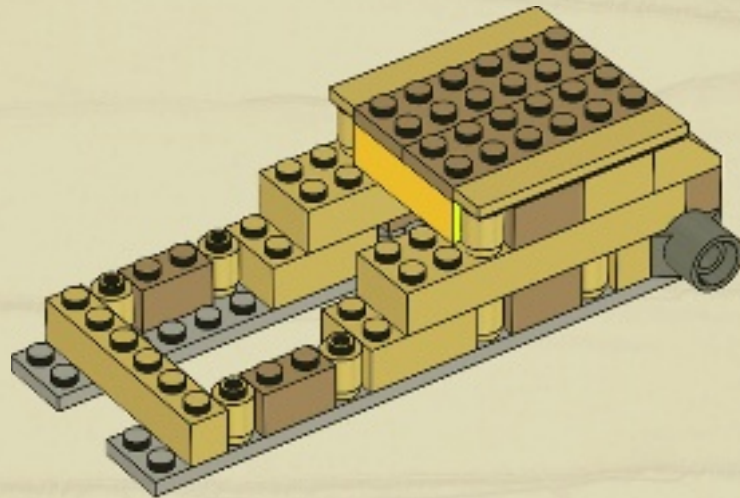



2x

10

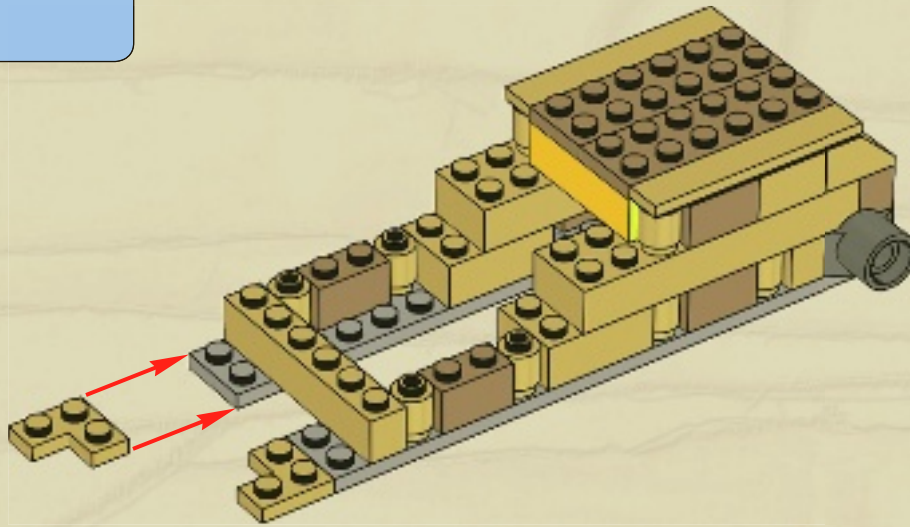

2x

11

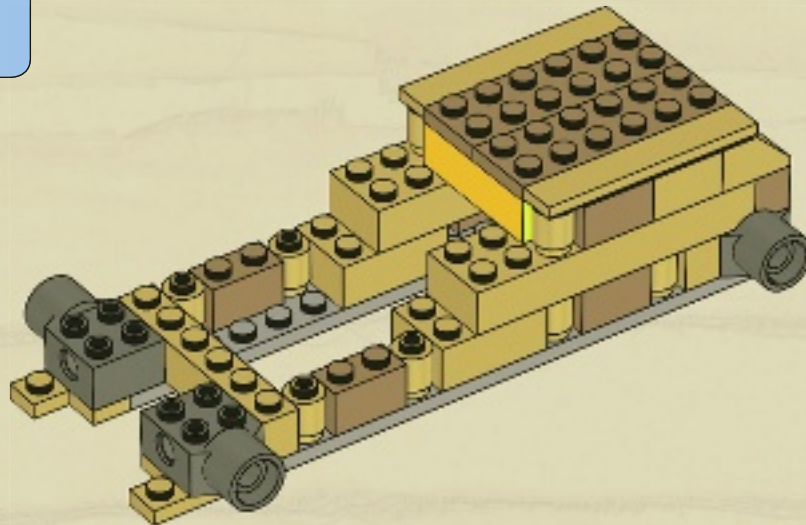

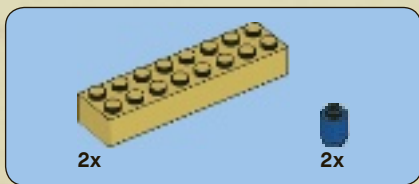

12

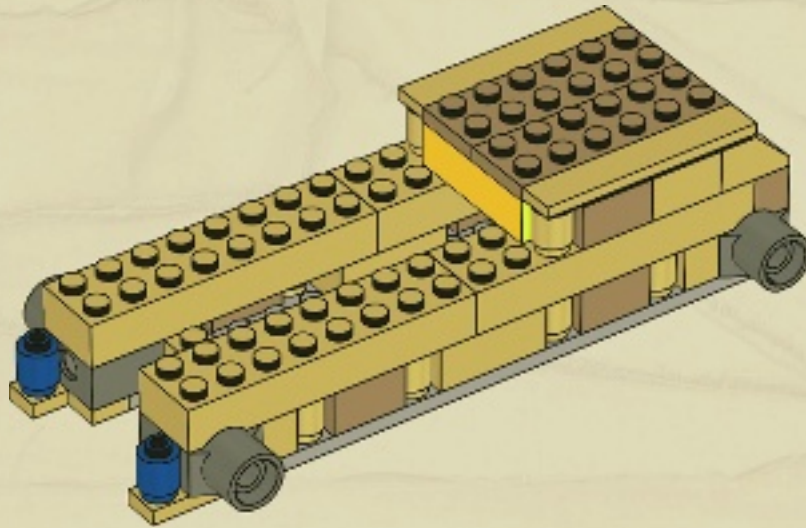

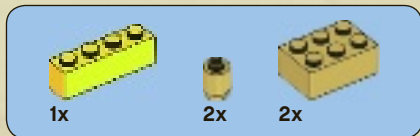

13

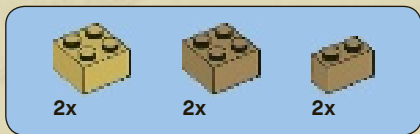
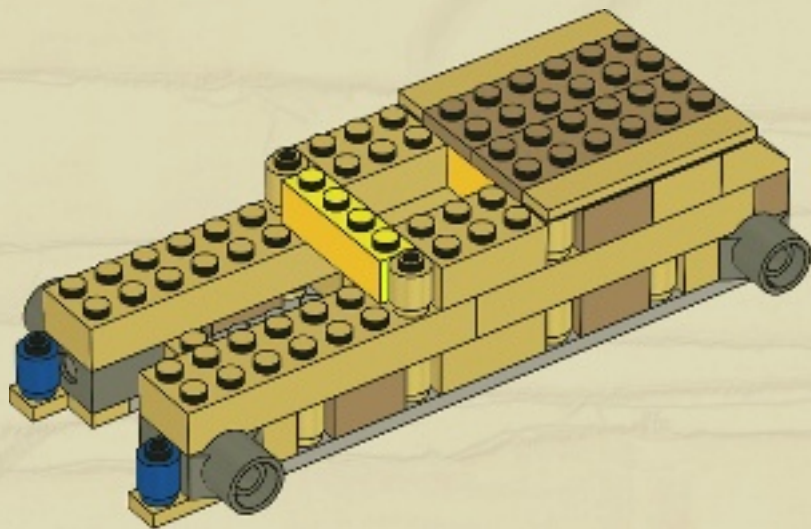

14

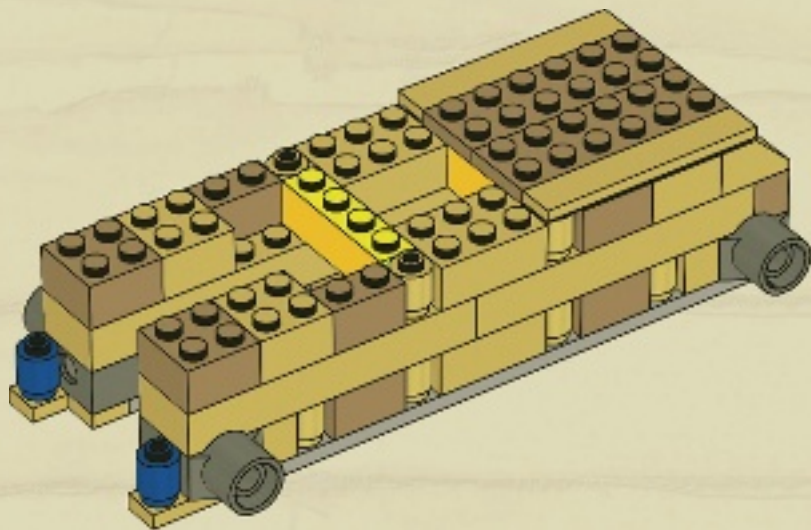



15

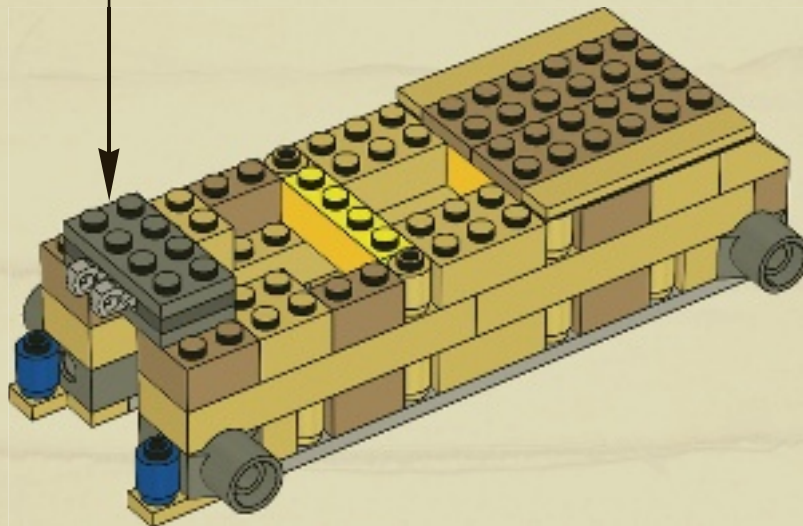
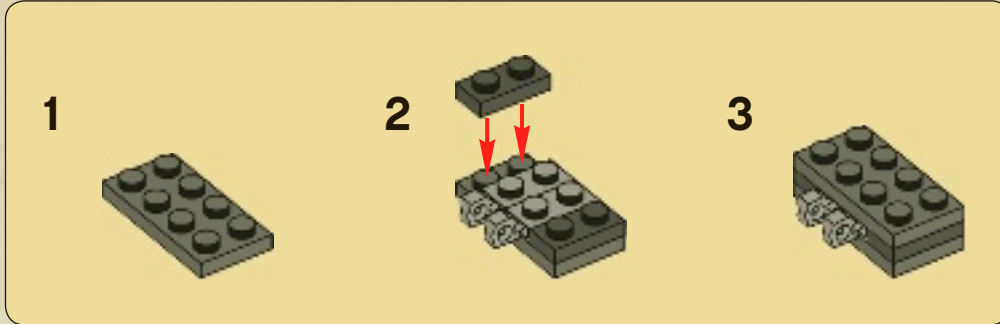



6x

16

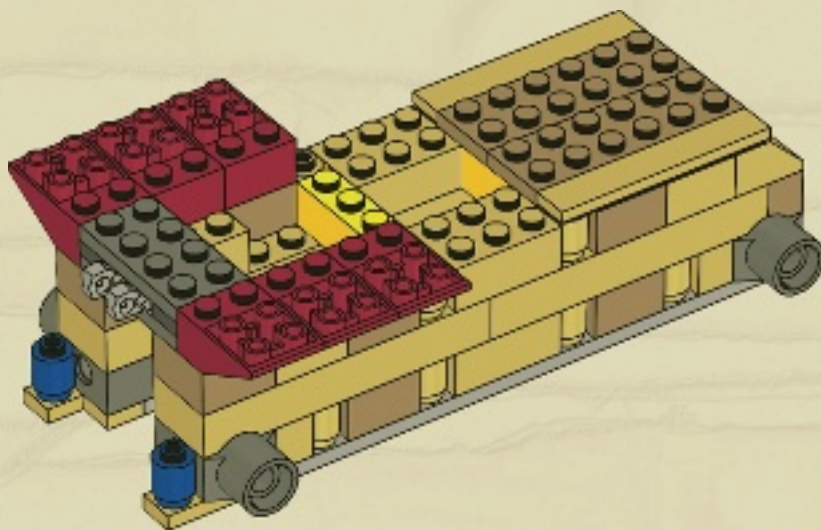

3x

17

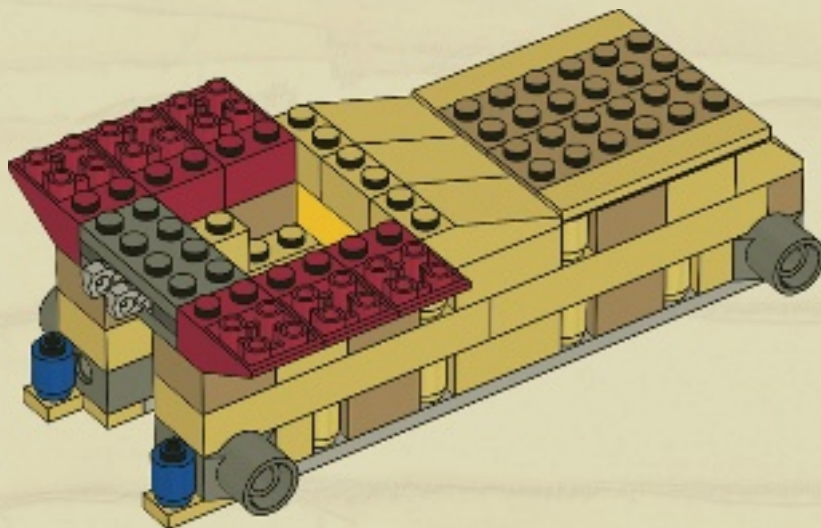

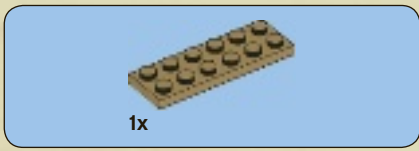

18

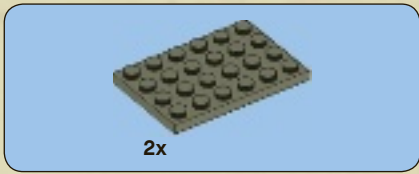
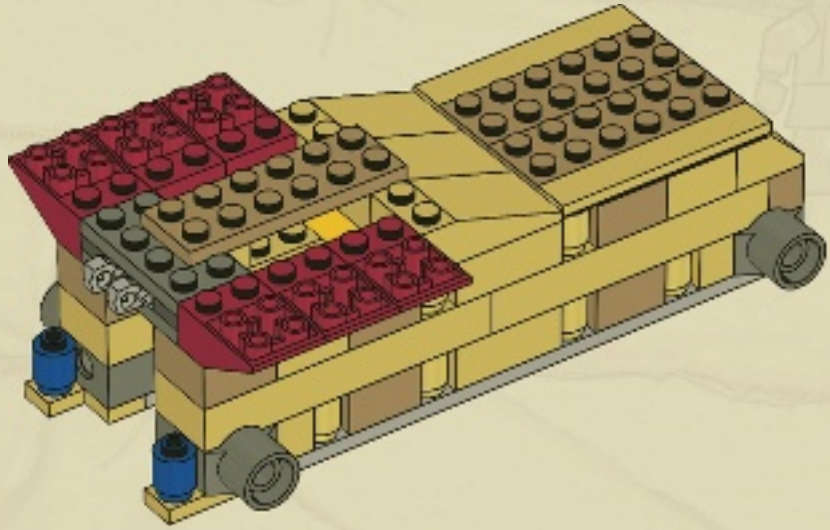

19

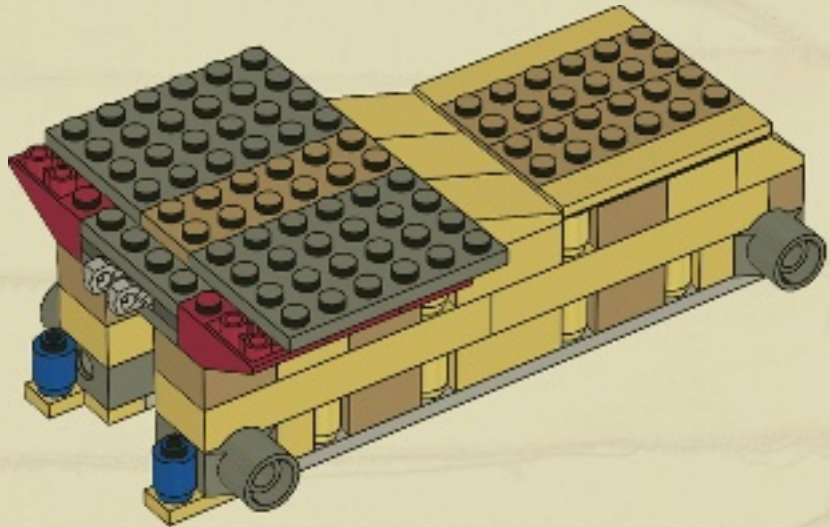

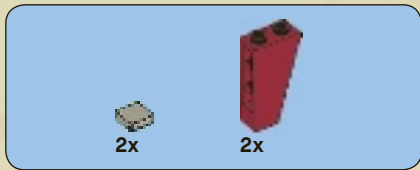

20

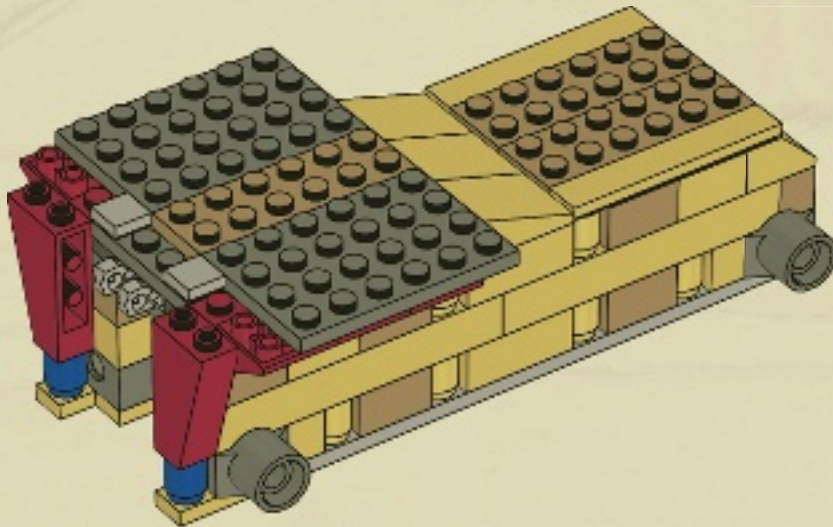



21

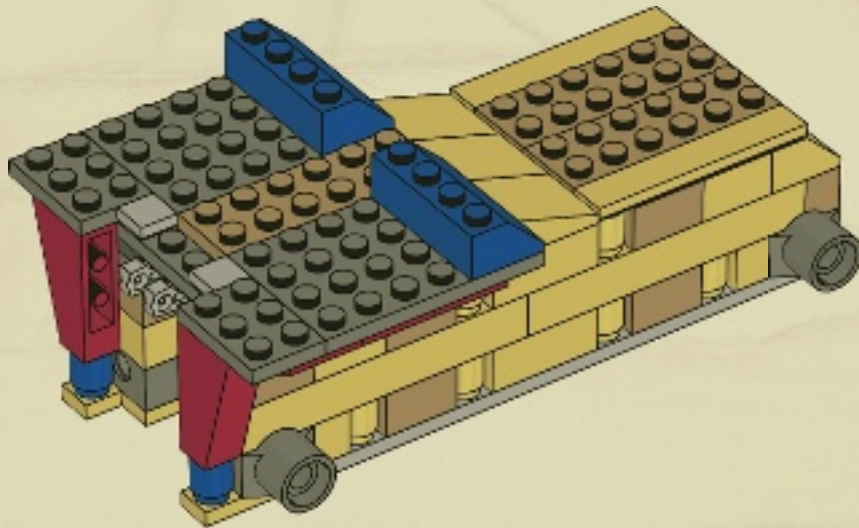



1x



4x

22

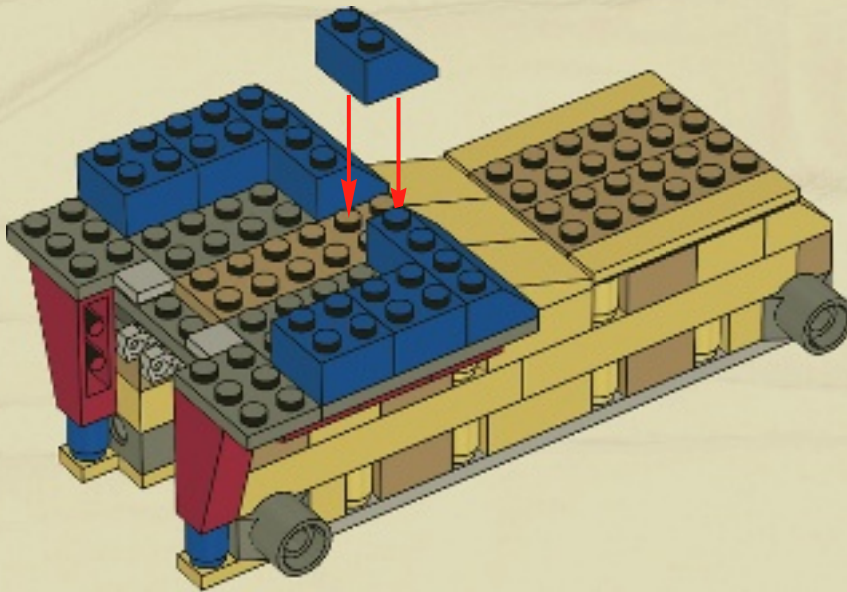

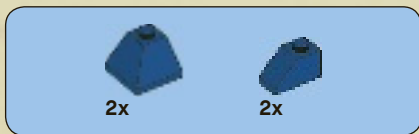

23

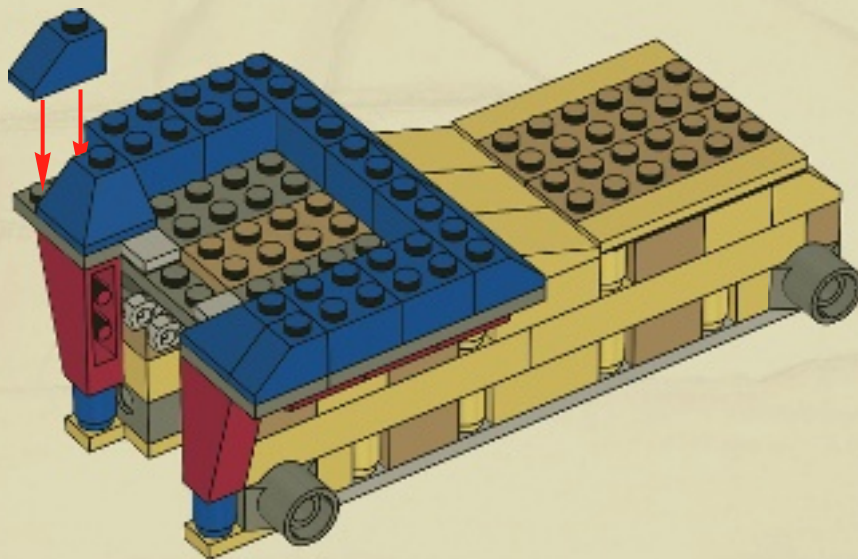



24

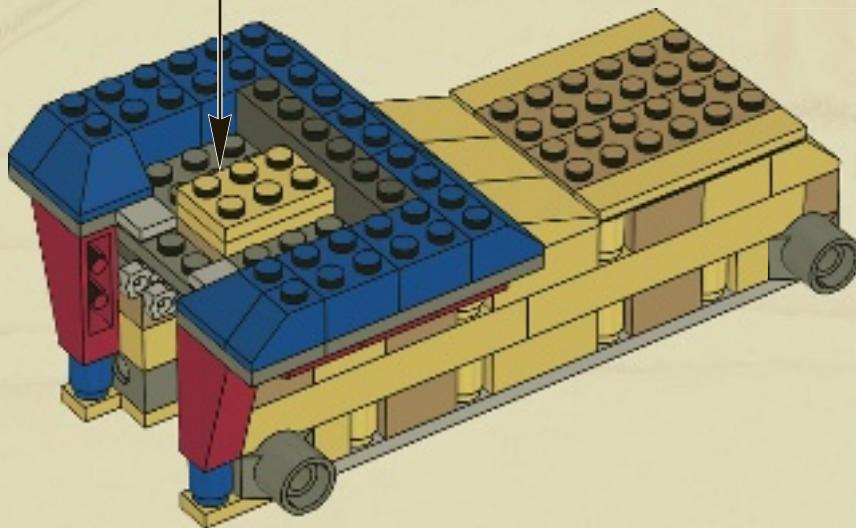
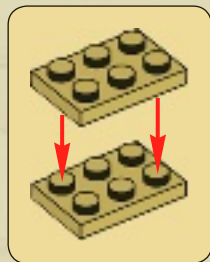

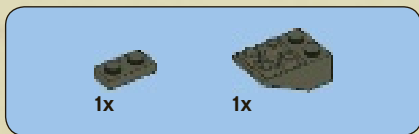

25

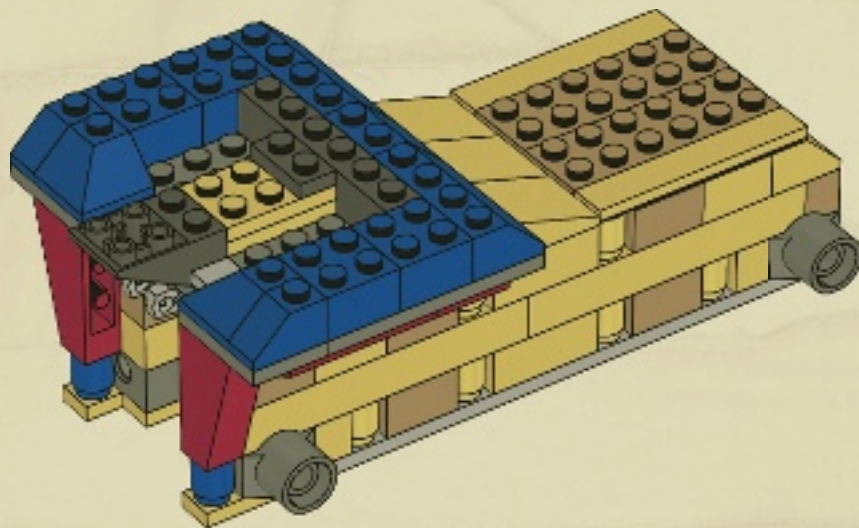



4x



4x

26

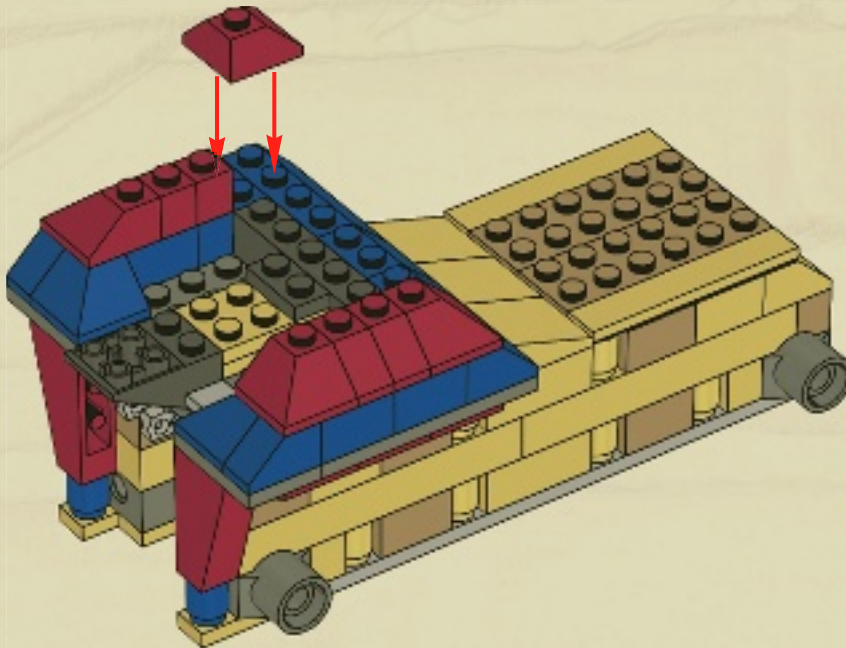

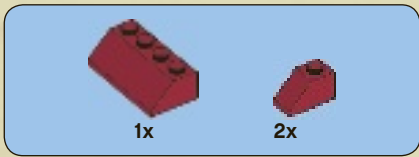

27

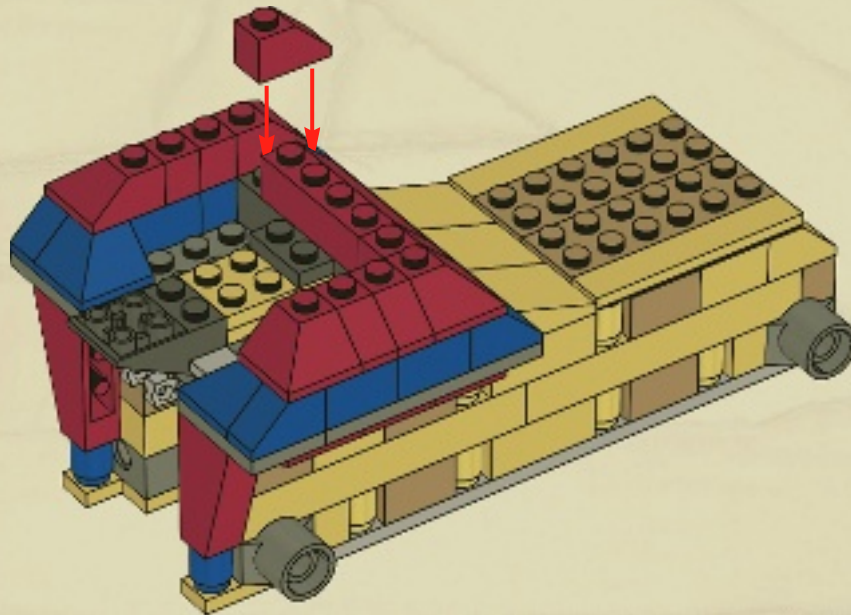

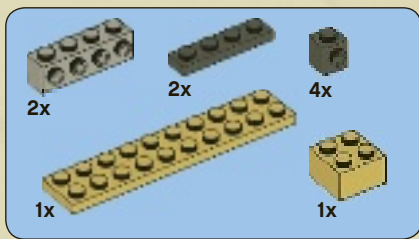

28

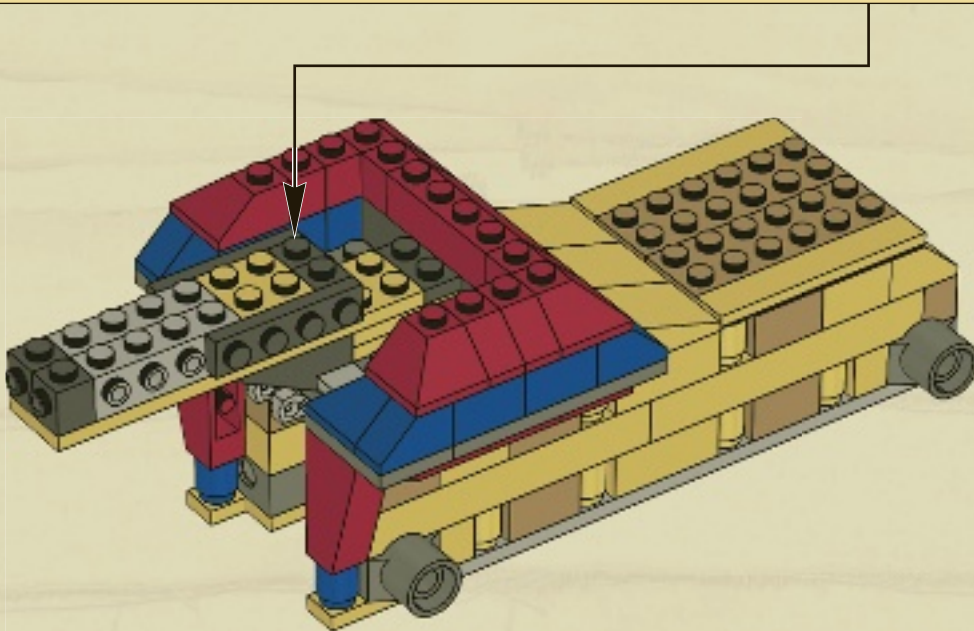
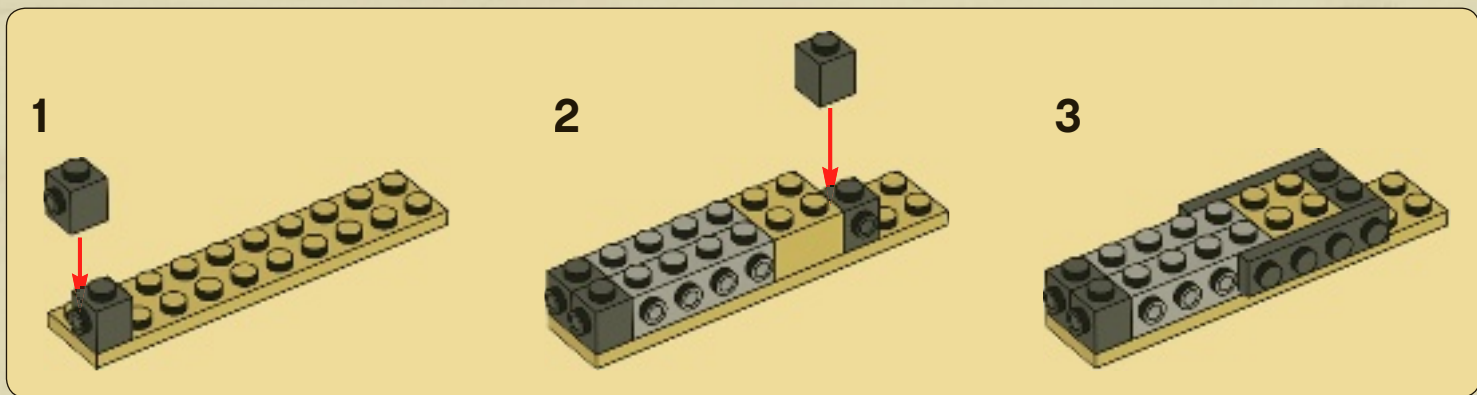

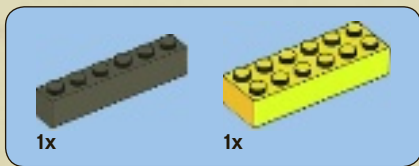

29

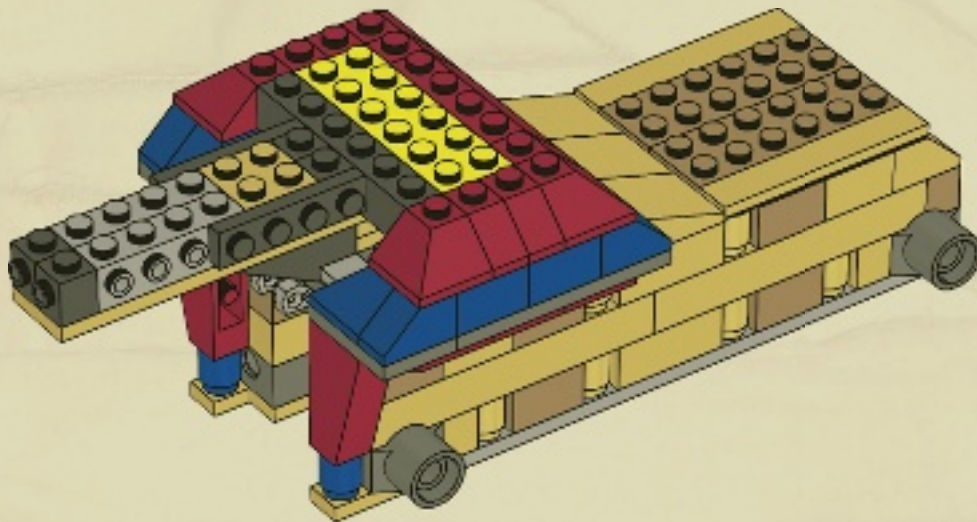

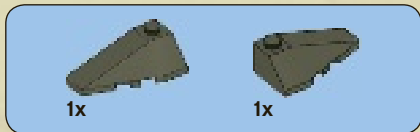

30

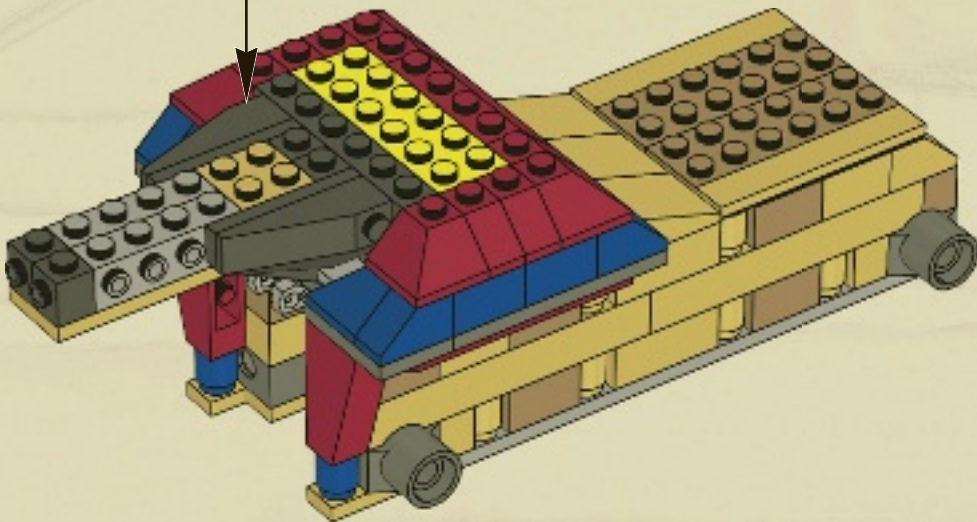



31

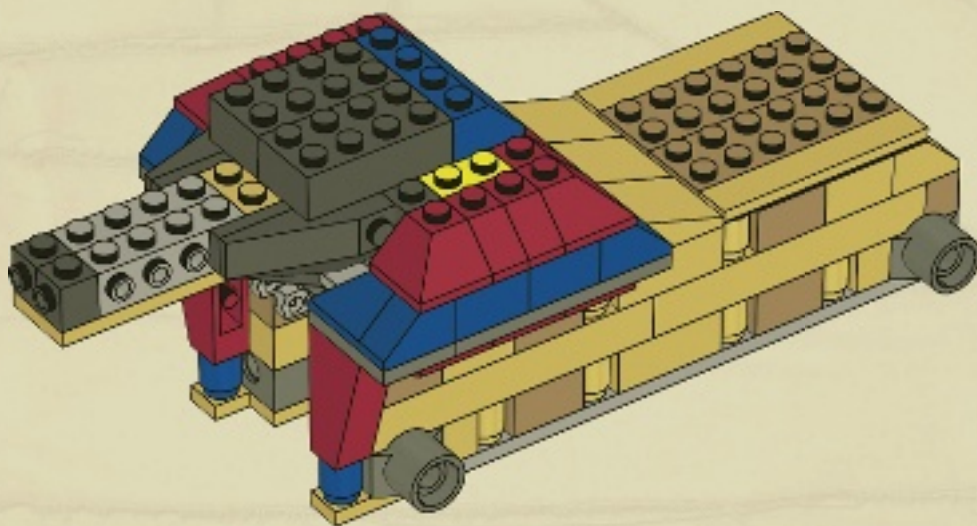



32

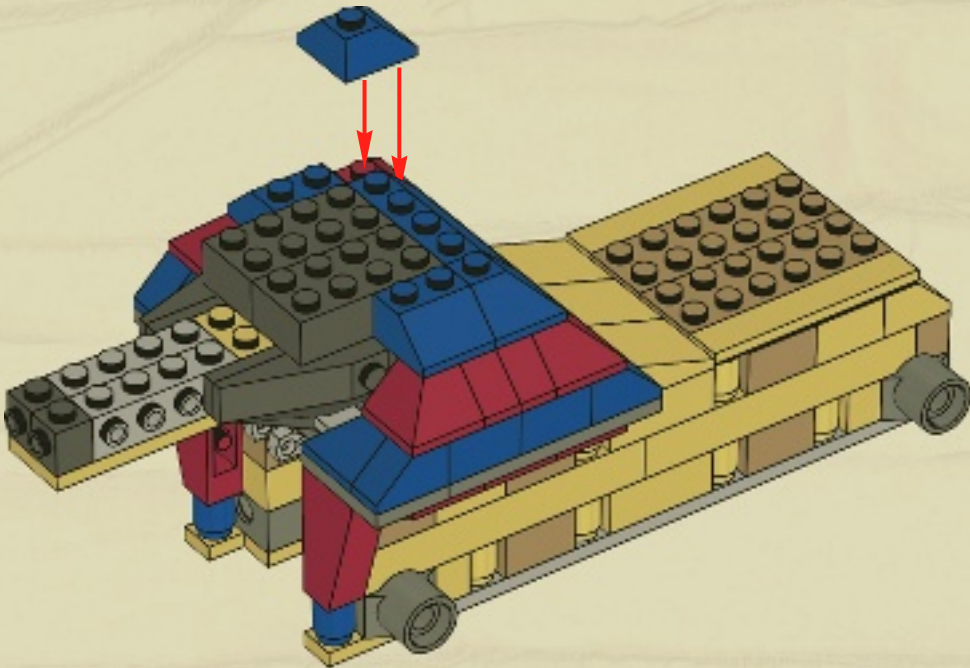



2x



4x

33

1

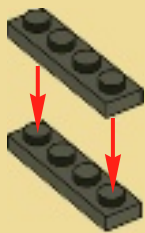

2

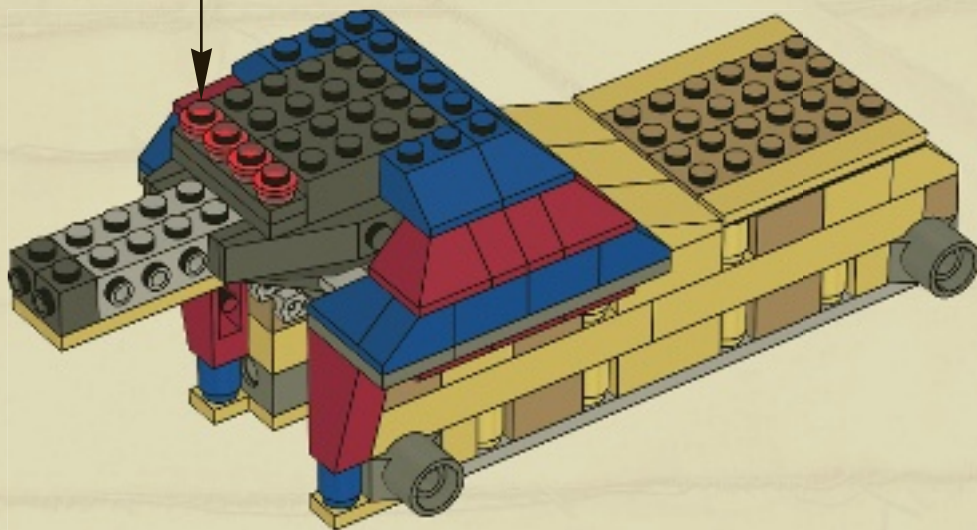

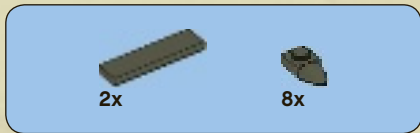

34

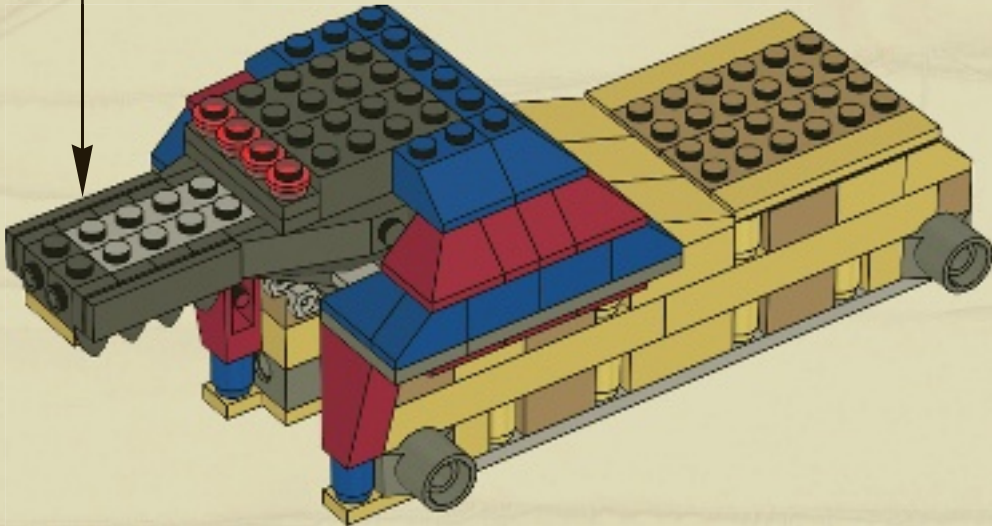
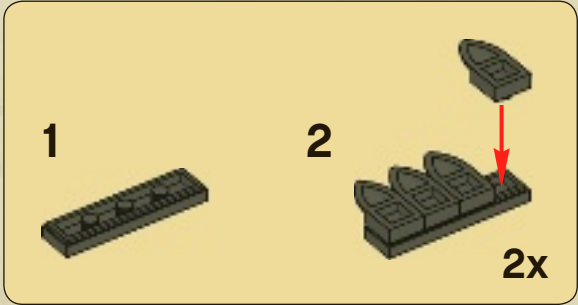



2x



2x

35

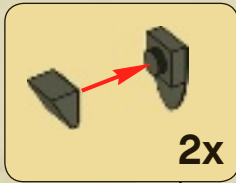

2x

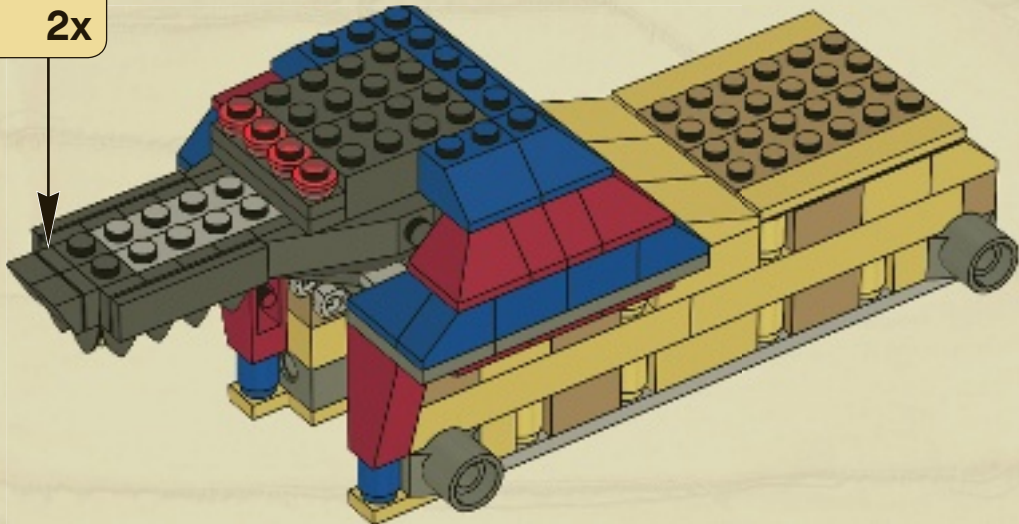



1x

36

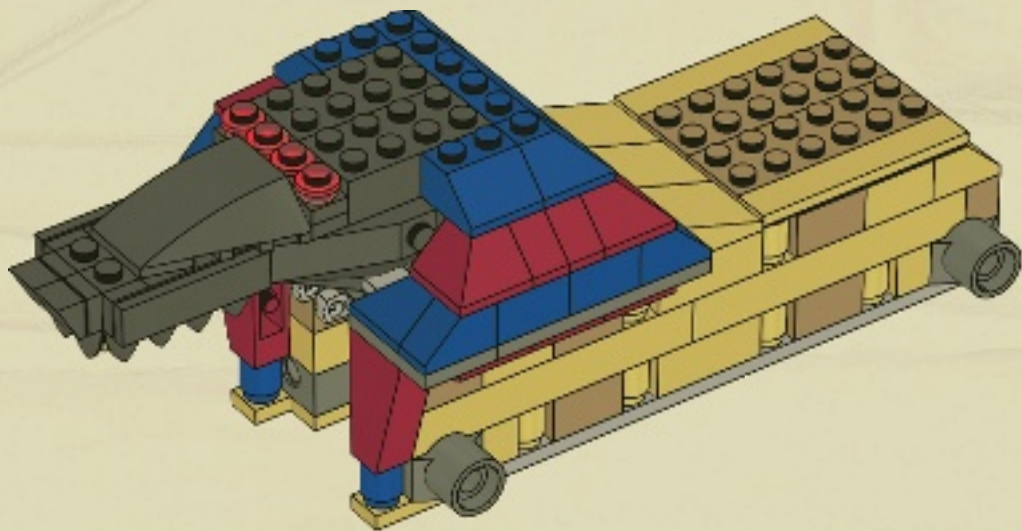



37

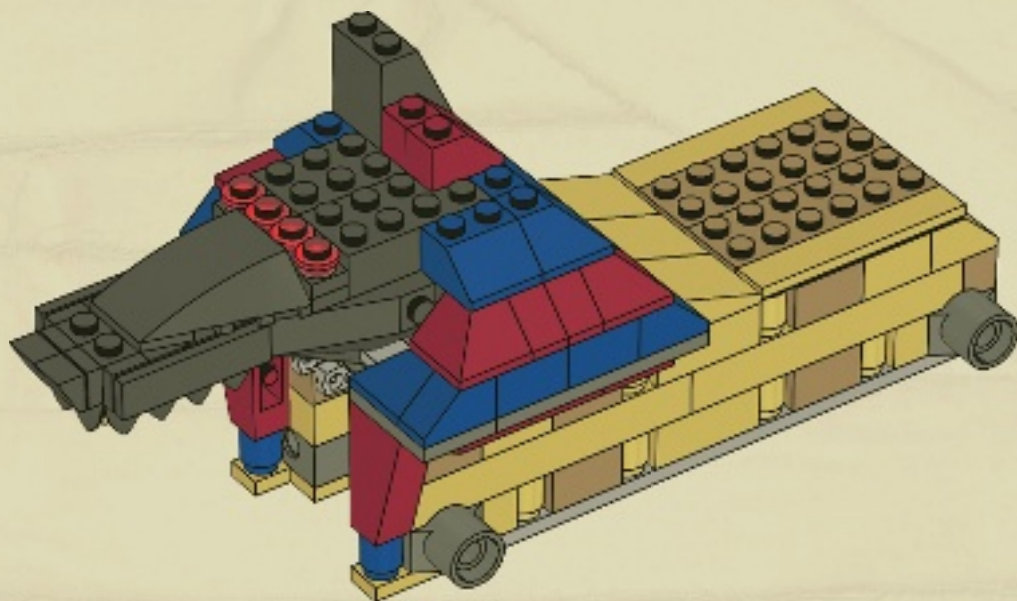

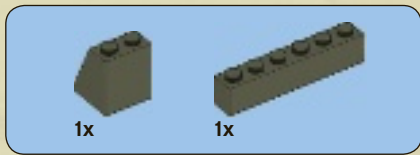

38

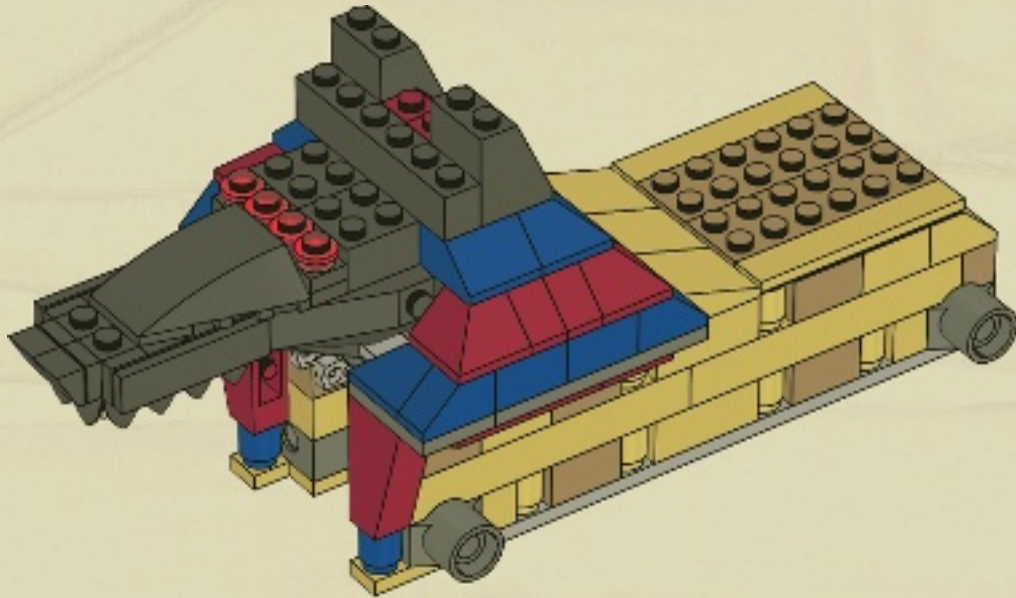

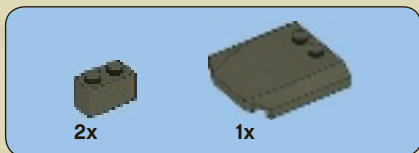

39

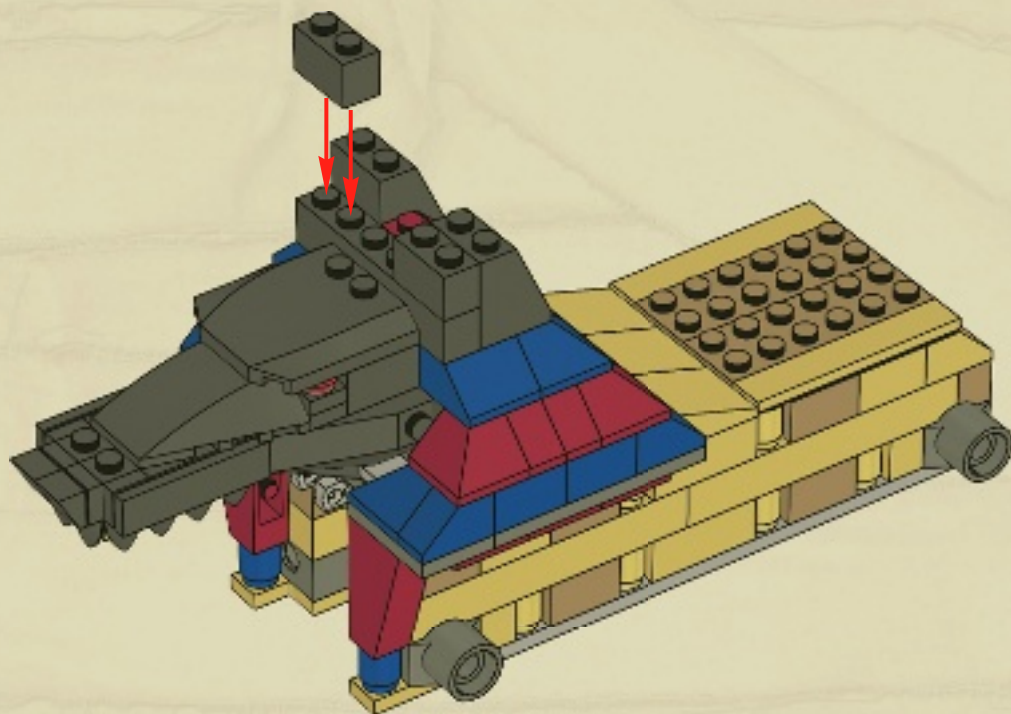



40

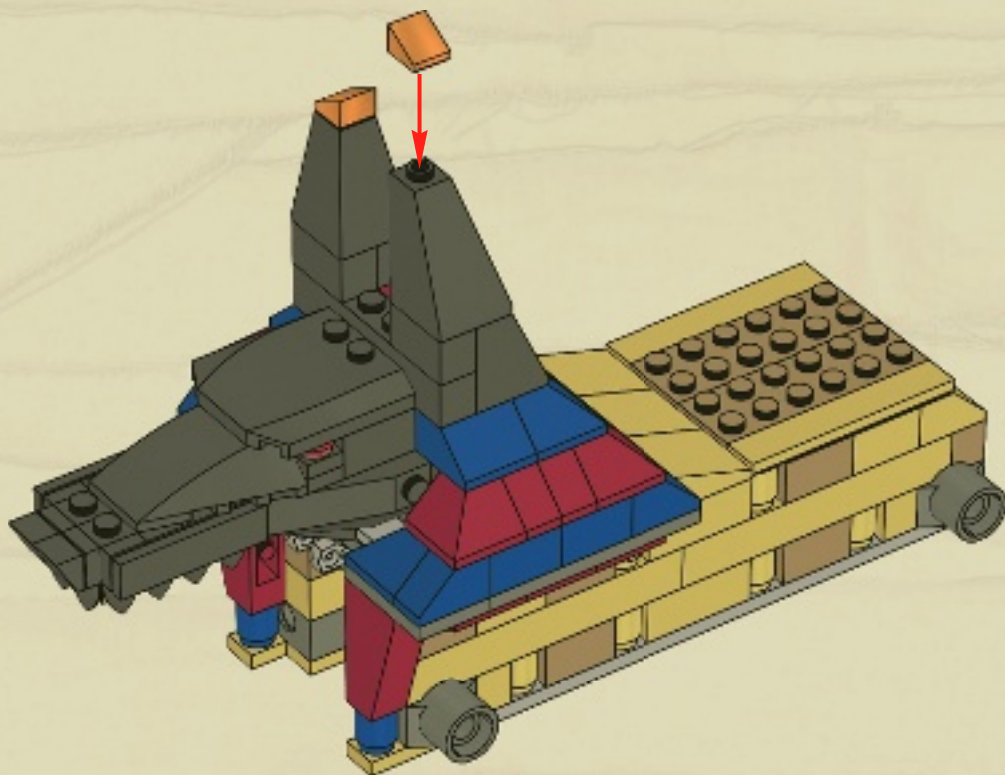

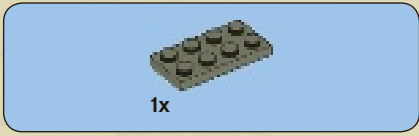

1

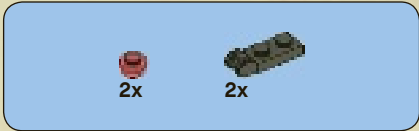

2

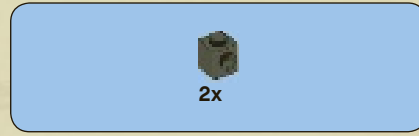

3

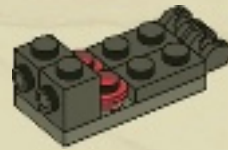

4

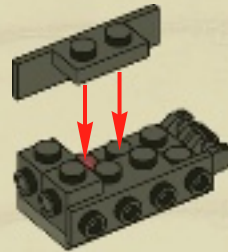



2x



2x

5



1x



1x

6

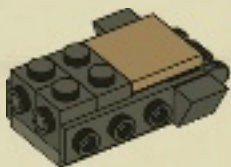

8x

7



2x



1x

8





41

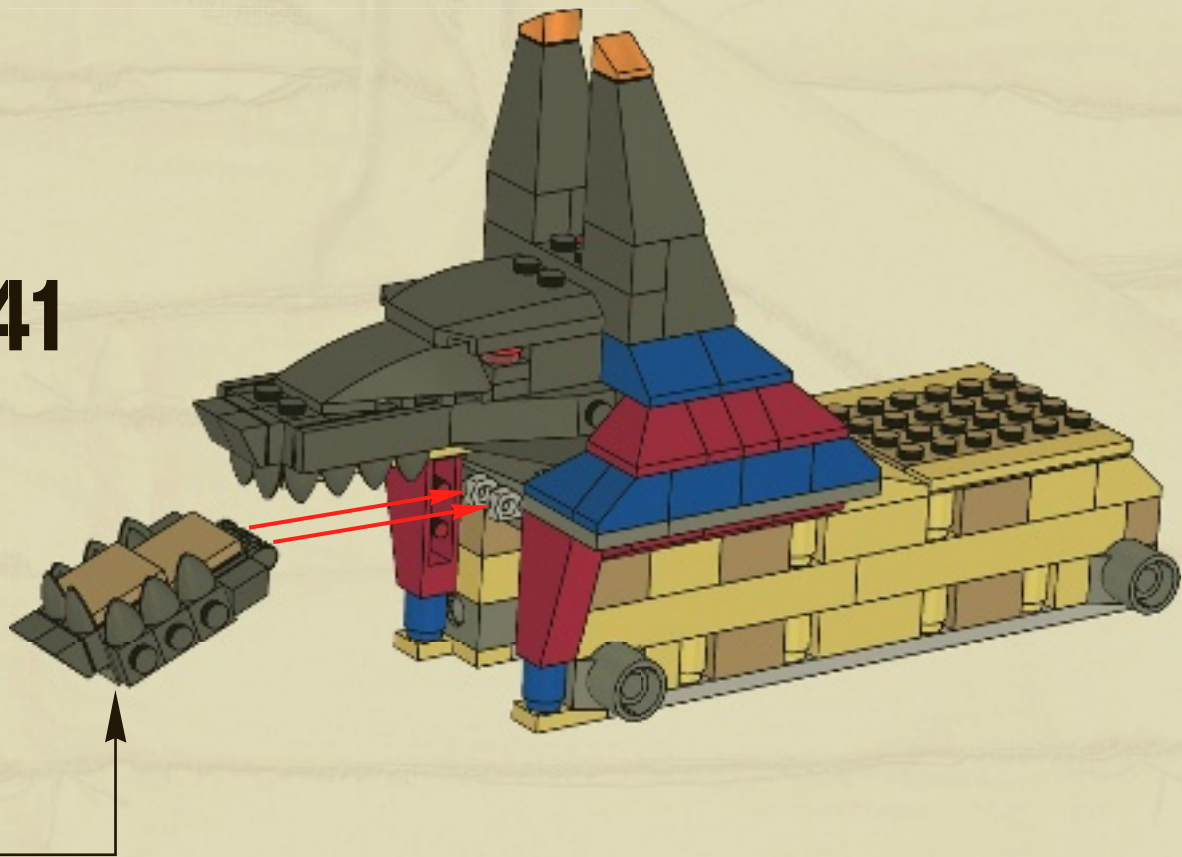

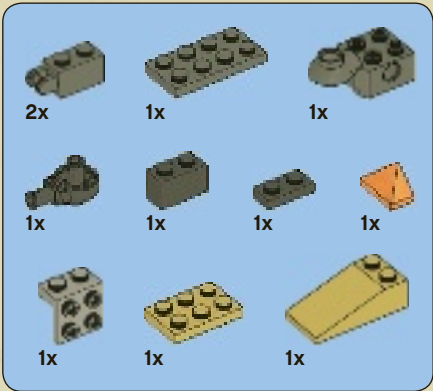

1

1

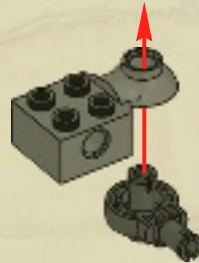

2

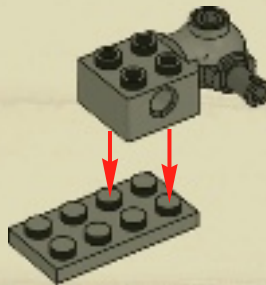

3

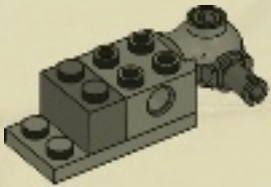

4

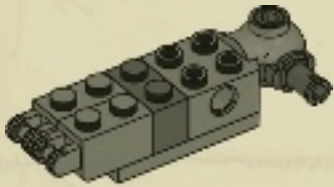

5

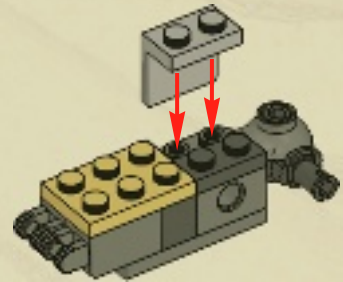

6

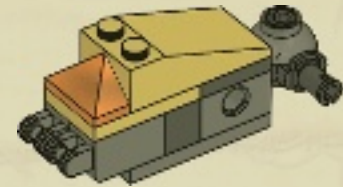

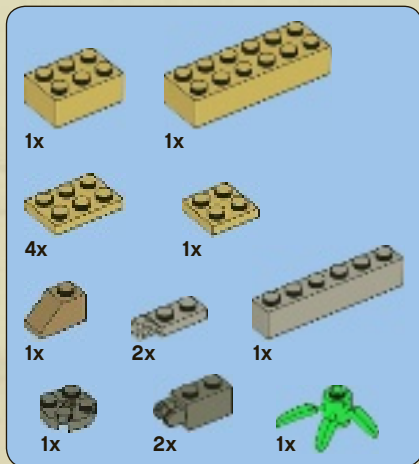

2

1

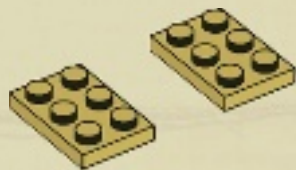

2

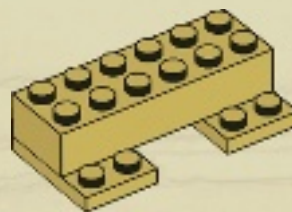

3

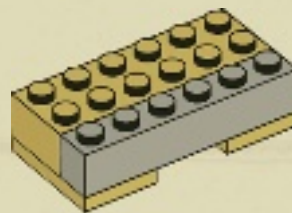

4

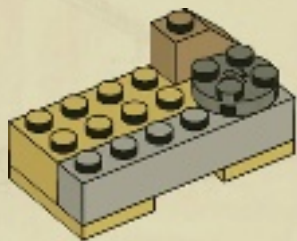

5

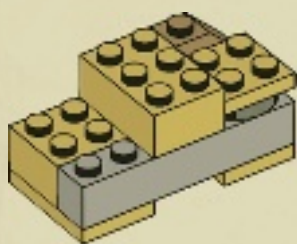

6

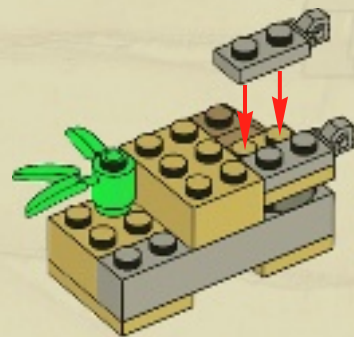

7

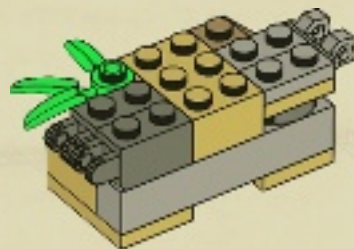

8

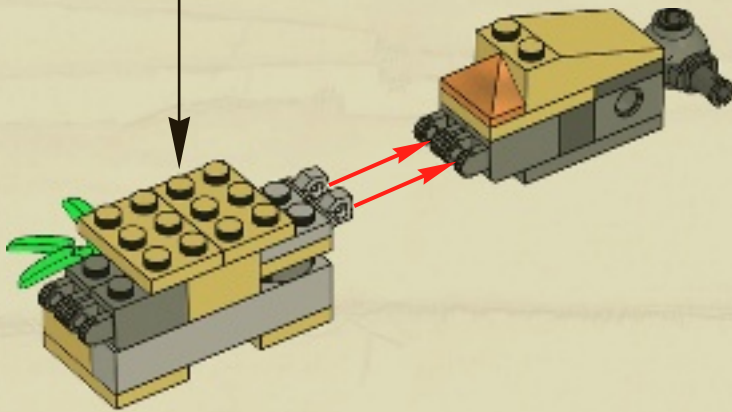
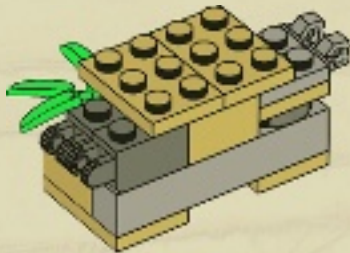

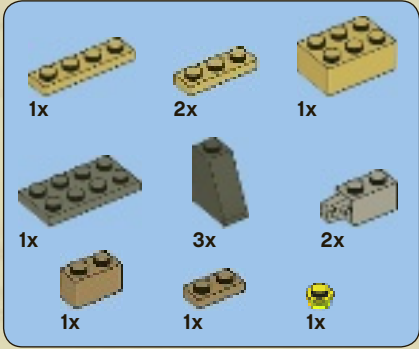

3

1

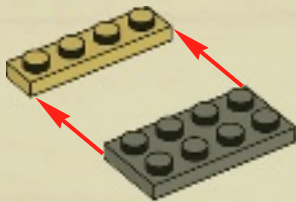

2

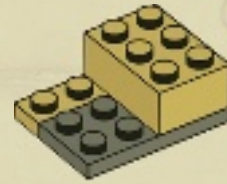

3

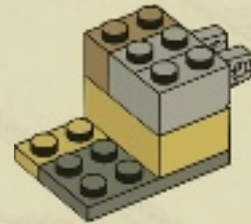

4

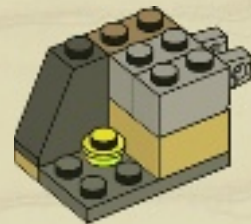

5



6

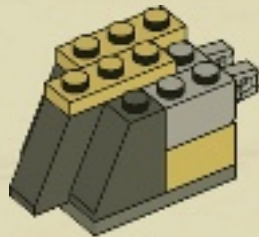

7





8

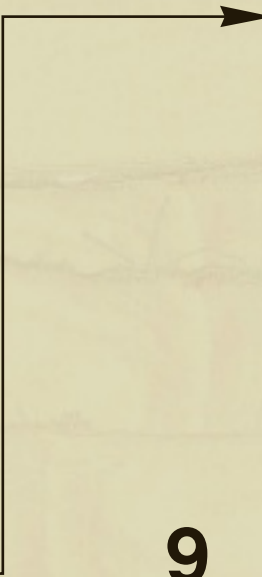
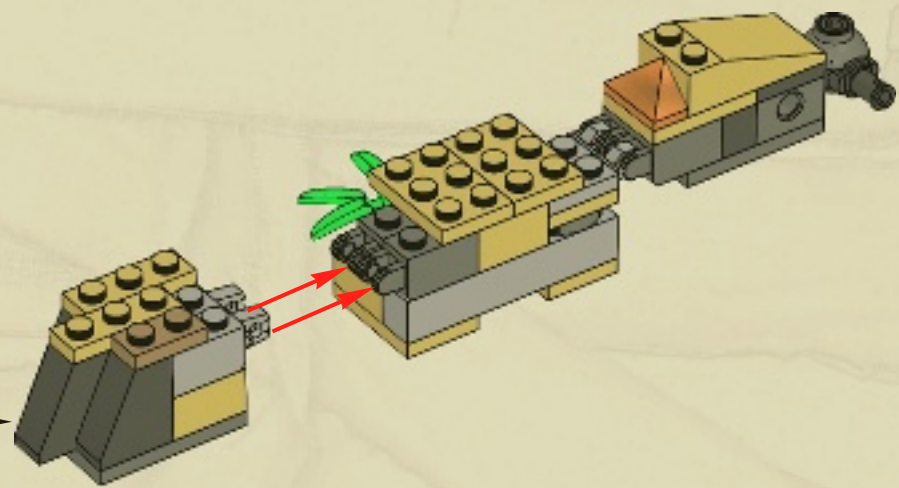

9

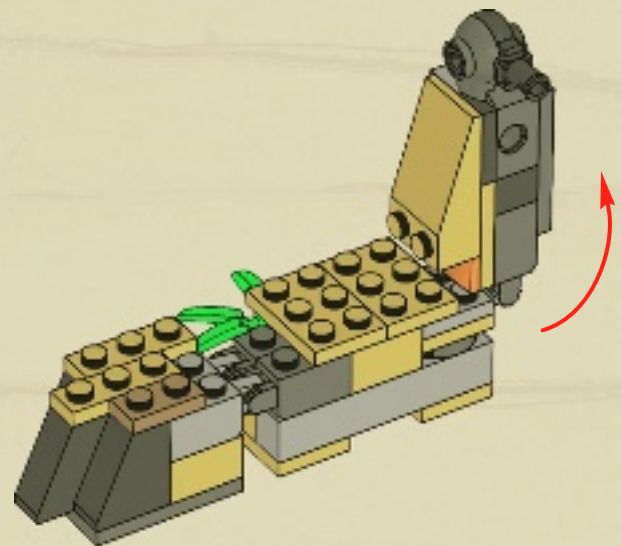

2x

42

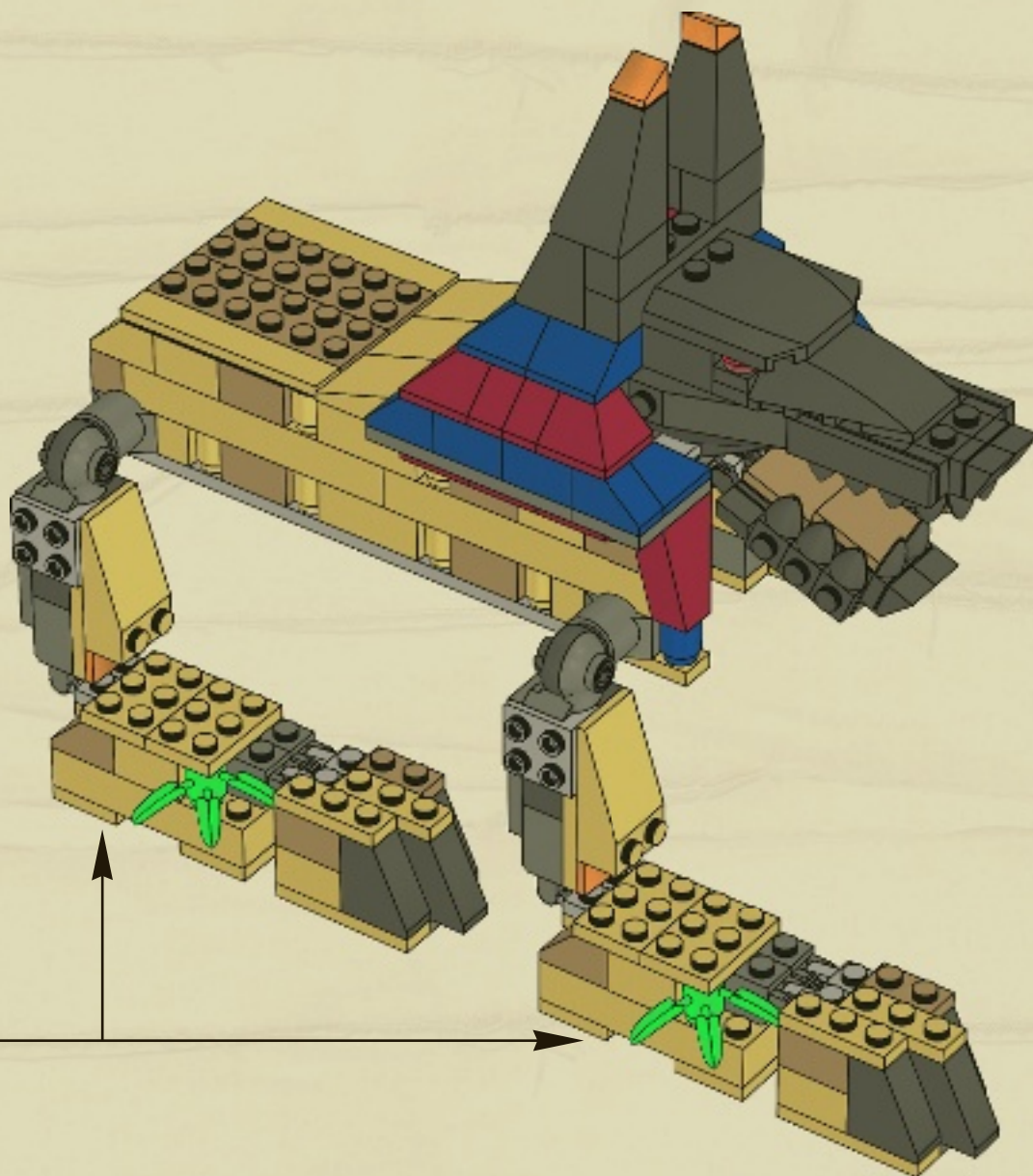

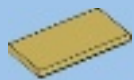

2x

43

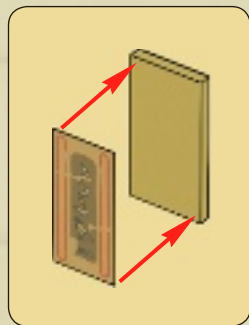
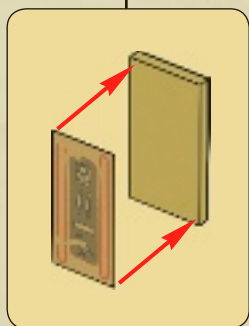
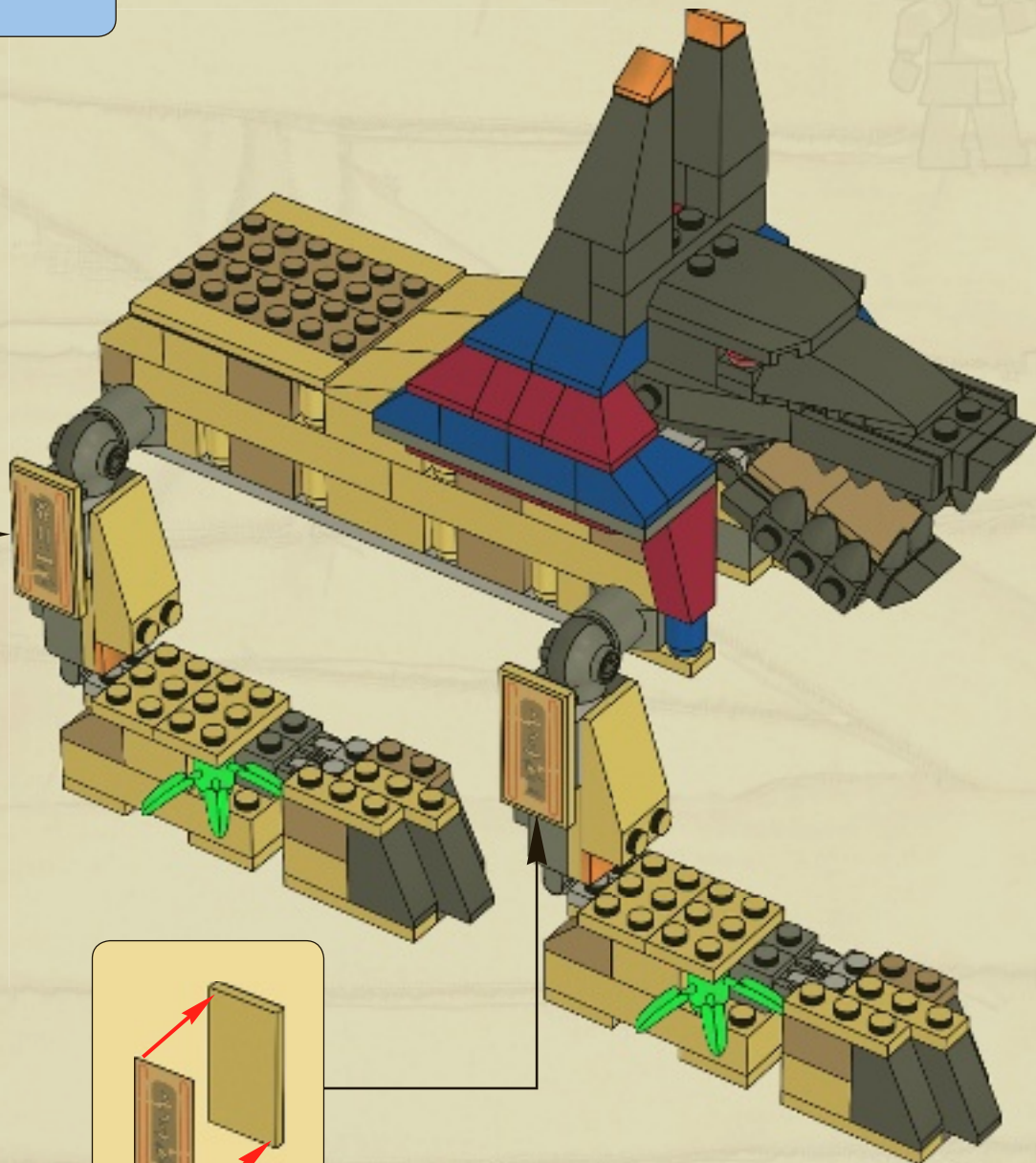

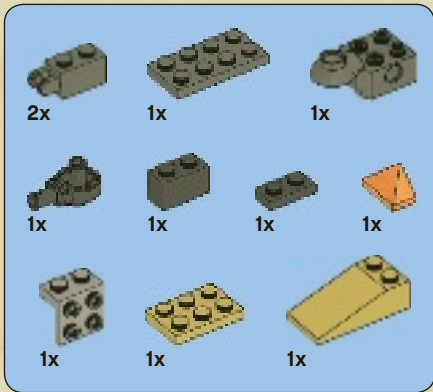
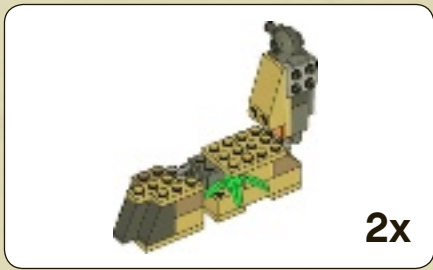

1

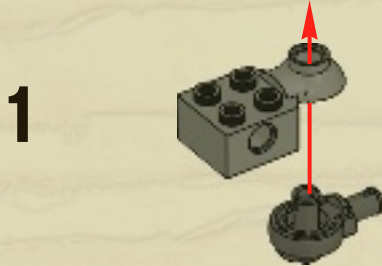

2

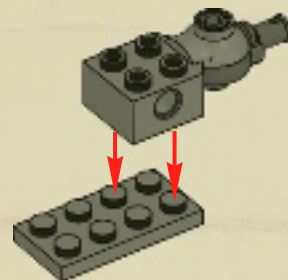

3

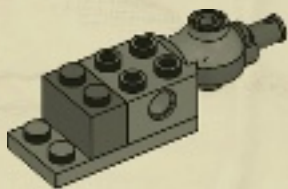

4

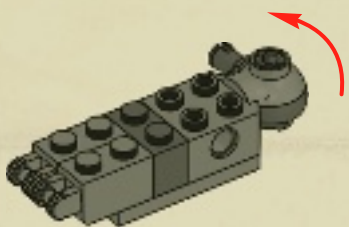

5

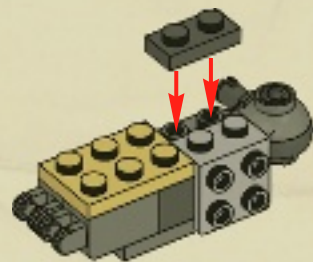

6

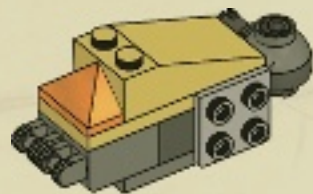

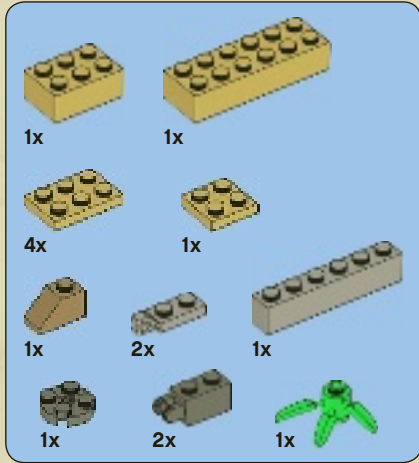

2

1

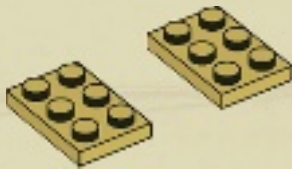

2

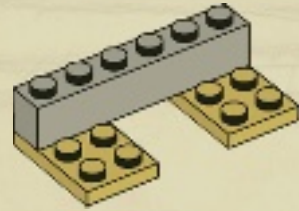

3

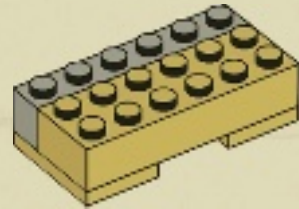

4

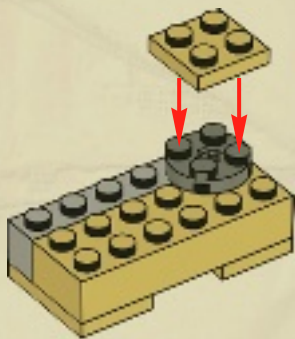

5

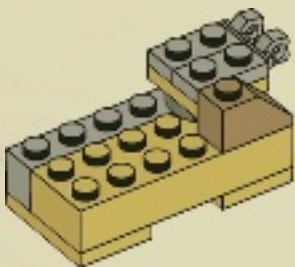

6

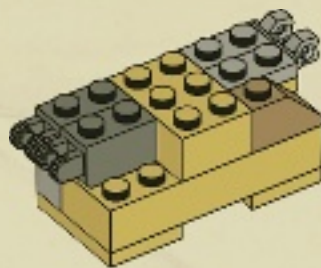

7

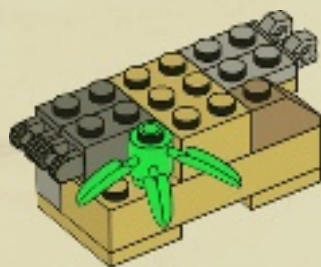

8

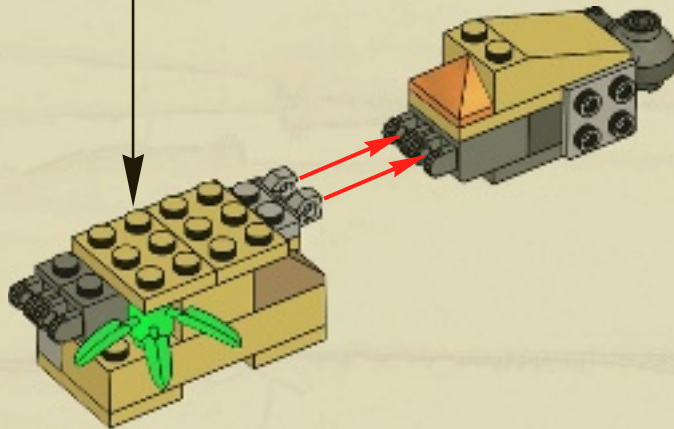
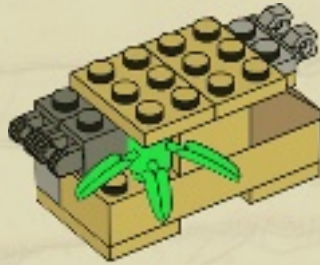

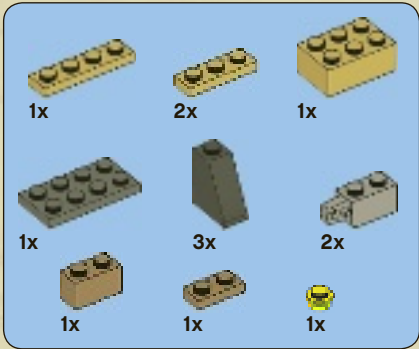

3

1

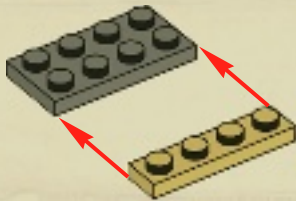

2

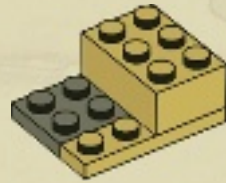

3

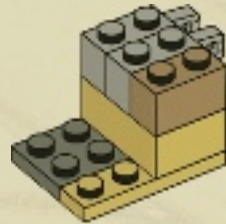

4

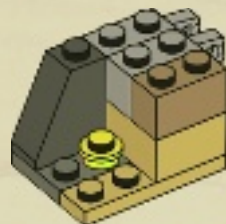

5

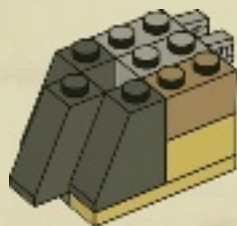

6

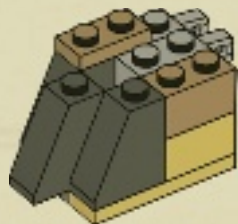

7

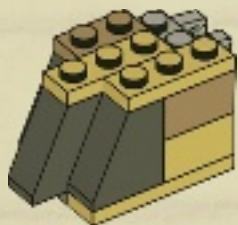



8

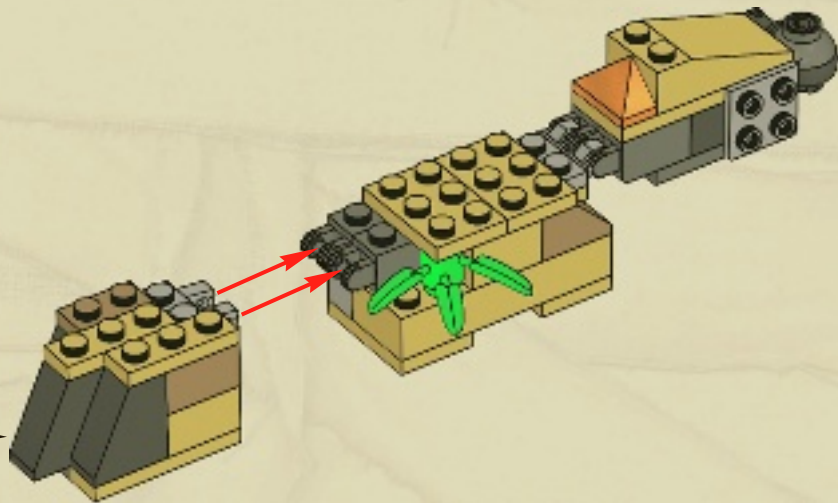

9

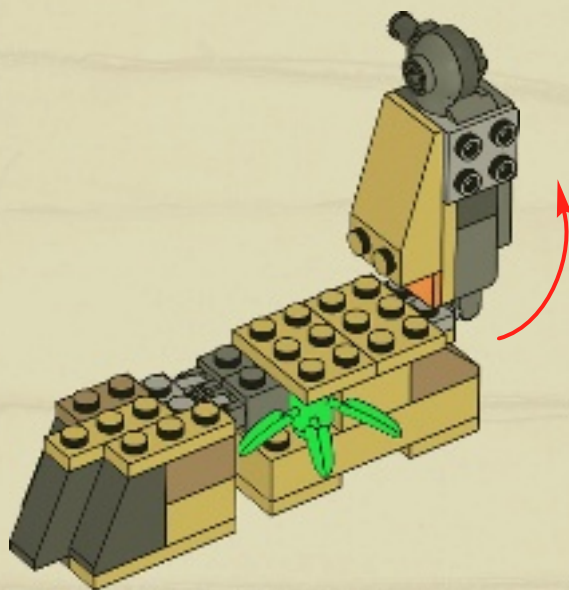

2x

44

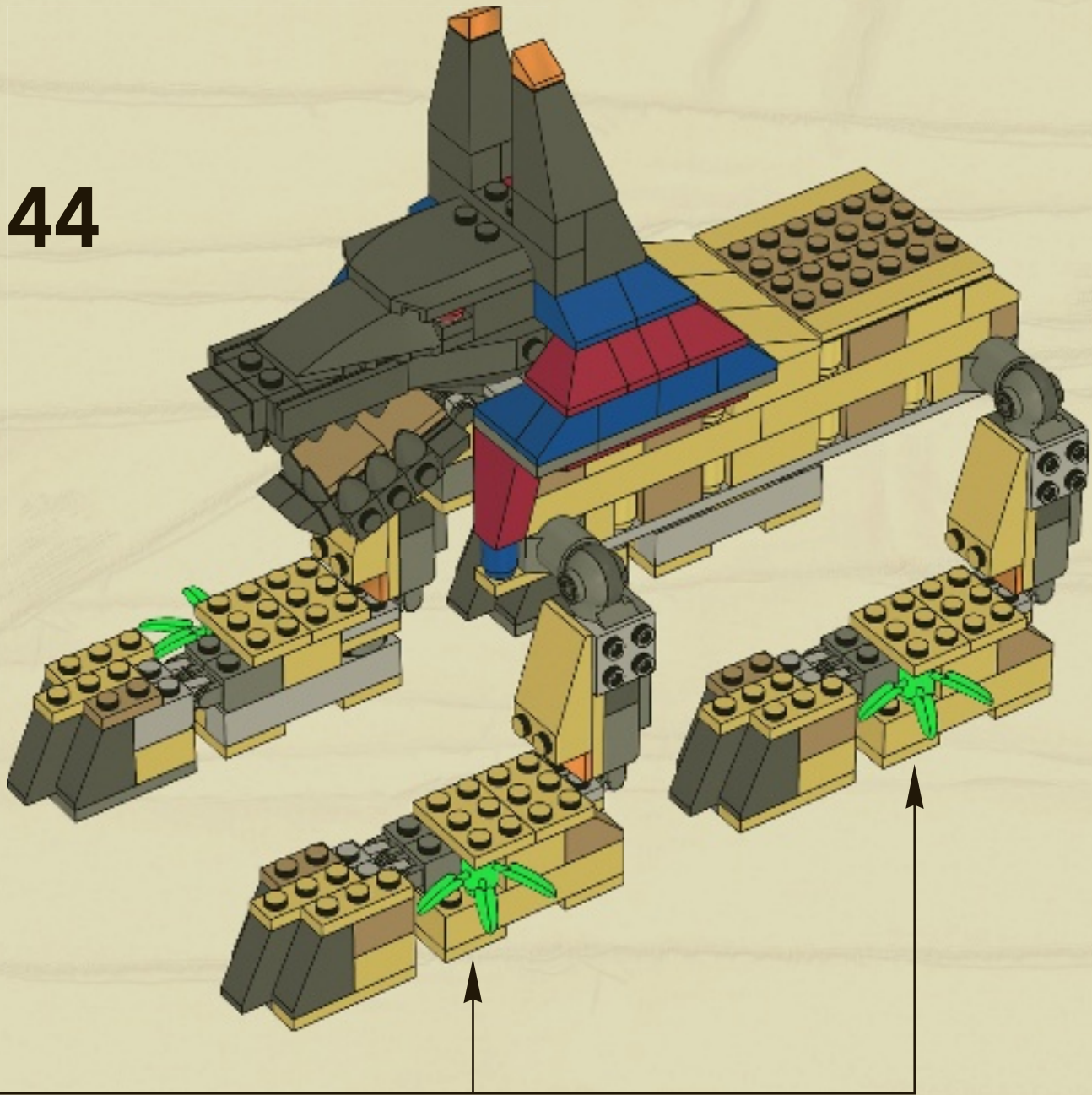

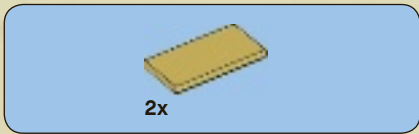

45

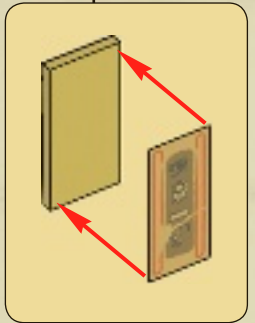
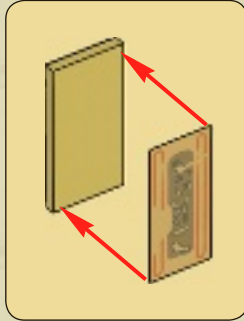
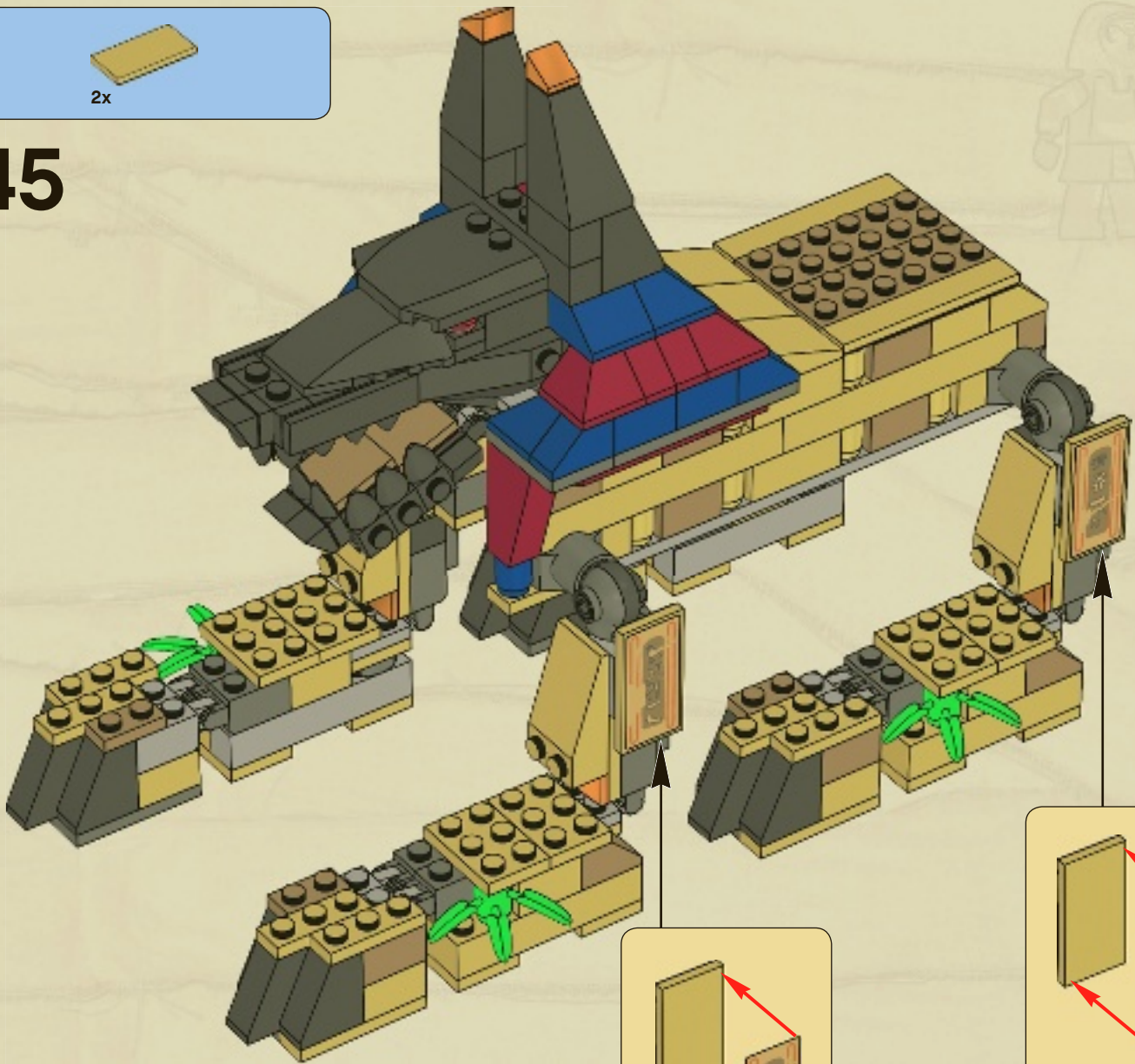

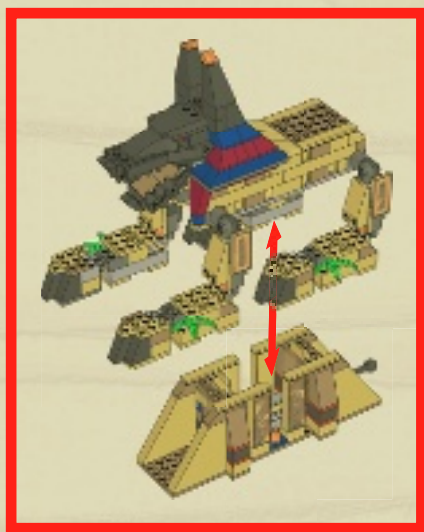

7307



7327



7325



7306



7326



7305





4x
4114064



14x
4114306



12x
4159739



6x
4109995



1x
4113916



2x
4112982

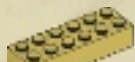

4x
4181134

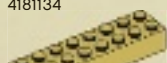

4x
4141533

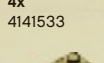

7x
4530709



5x
4114322



12x
4117070



80



4x
4243911



2x
4114077



4x
4114084



8x
4121921



4x
4113233



3x
4185177



4x
4610209

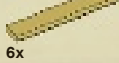

6x
4157277



4x
4124460



22x
4118790



1x
4113988



1x
4249019



6x
4504382



12x
4515373



2x
4273703



2x
4614804



1x
374726



1x
4180423



1x
4180413



1x
4219107



2x
243126



3x
379426



2x
4183060



8x
302326



4x
371026



2x
4550017



2x
4556158



2x
4282746



1x
3004626



2x
459926



1x
4526110



2x
4613404



4x
4541455



1x
73081



18x
4273590



1x
4191191



4x
4213374



1x
4290713



6x
4558954



1x
4118624



4x
300326



2x
300126



7x
300426



1x
301026



3x
300926



1x
449726



16x
4521914



2x
4255416



10x
4530678



4x
4613790



2x
4507045



1x
4524098



10x
4528604



5x
4550329



3x
4251796



4x
4211393



8x
4211693



2x
4211636



2x
4211613



2x
4211440



2x
4211415



4x
4558169



2x
4211369



1x
4211350



4x
4277927



10x
4211803



2x
4494475

2x
4211486



1x
4523353



2x
4595836



4x
4499259



2x
4613425



2x
4613454



2x
4613494



2x
301024



1x
4181143



2x
4164060



4x
4141630



4x
614124



1x
4613411



1x
4211007



1x
4523773



1x
4499858



2x
4558955



16x
4210724



4x
4225973



4x
4227395



2x
4504378



4x
4211042



3x
4211043



11x
4211065



2x
4211115

1x
4211067



2x
4529247



2x
4587002



4x
4295174



2x
4585493



2x
4557385



1x
4610763



2x
4615996



4x
4196736



3x
4153653



3x
4578094



6x
4186627



4x
4296785



6x
4177741



1x
4613269



8x
4541526



2x
4539103



4x
4600467



6x
4615998



1x
4541380



2x
4539082



4x
4629912



2x
4613761



2x
4549992



1x
4538780



2x
302321



8x
4615606



1x
4613755



1x
4610904



2x
3005740



1x
4113106



10x
3005741



4x
4114348

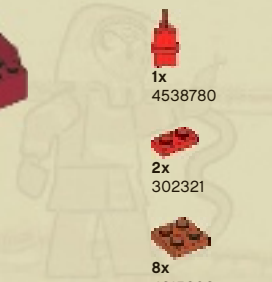

Customer Service

Kundenservice

Service Consommateurs

Servicio Al Consumidor

www.lego.com/service or dial

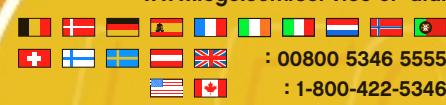

: 00800 5346 5555

: 1-800-422-5346

LEGO® Glyphs

 A	 B	 C	 D	 E	
 F	 G	 H	 I	 J	 K
 L	 M	 N	 O	 P	
 Q	 R	 S	 T	 U	
 V	 W	 X	 Y	 Z	



Solve the code above and enter pharaohsquest.LEGO.com
 Déchiffre le code ci-dessus et viens sur pharaohsquest.LEGO.com
 Entschlüssel den Code und gib das Lösungswort auf PharaohsQuest.LEGO.de ein.
 Déchiffre le code ci-dessus et entre dans pharaohsquest.LEGO.com
 Resuelve el jeroglífico y visita pharaohsquest.LEGO.com
 Decifra o código acima e entra em pharaohsquest.LEGO.com
 Fejtsd meg a fenti kódot, és lépj be a pharaohsquest.LEGO.com oldalra.



pharaohsquest.LEGO.com



www.LEGOclub.com



LEGO® Club Email

LEGO club™

FREE! GRATIS! GRATUIT!



LEGO® Club Magazine

SIGN UP ONLINE!

www.LEGOclub.com



00800 5346 5555*



1-866-534-6258 • 1-877-518-5346

US & Canada only

Canada seulement

* Freephone. Mobile charges may apply.
* Numéro sans frais. Des frais peuvent s'appliquer avec les téléphones cellulaires.
* Gebührenfrei, Kosten für Anrufe aus Mobilfunknetzen können abweichen.
* Gratis telefonnummer vanaf vaste lijn.
* Det er et gratis nummer, når du ringer fra fasttelefon.
* Det är gratis, när du ringer från en fast telefon.
* Numéro sans frais. Des frais peuvent s'appliquer avec les téléphones portables.



WIN!

Go to www.LEGOsurvey.com/product to fill out a survey for a chance to win a cool LEGO® Product.

No purchase necessary.

Open to all residents where not prohibited.



www.LEGO.com



www.LEGOsurvey.com/product

GEWINNE! WIN!

Nimm an der Umfrage auf www.LEGOsurvey.com/product teil und hab die Chance ein cooles LEGO® Produkt zu gewinnen!

Die Teilnahme am Gewinnspiel führt zu keinerlei Kaufverpflichtungen. Teilnahme in allen nicht ausgeschlossenen Ländern möglich.

Ga naar www.LEGOsurvey.com/product, vul een enquêteformulier in en maak kans op een cool LEGO® product.

Geen aankoopverplichting. Iedereen mag deelnemen, uitgezonderd ingezetenden van landen waar een enquêteverbod geldt.

GAGNE! 当てよう!

Visite www.LEGOsurvey.com/product pour répondre à un questionnaire et avoir une chance de gagner un produit LEGO® très cool!

Aucune obligation d'achat. Ouvert à tous les résidents des pays autorisés.

www.LEGOsurvey.com/product にアクセスして、アンケートにご記入ください。当選者にはレゴ®製品を差し上げます。

お買い上げの必要はありません。

禁止されていない限り、すべての皆様にご利用いただけます。