



# PHARAOH'S QUEST



7326



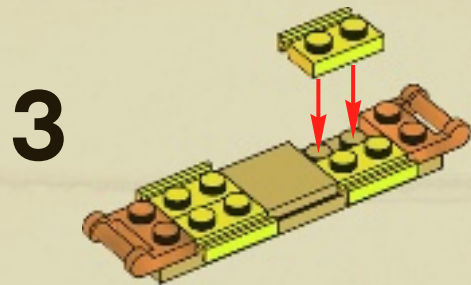
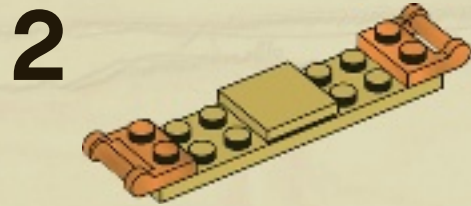
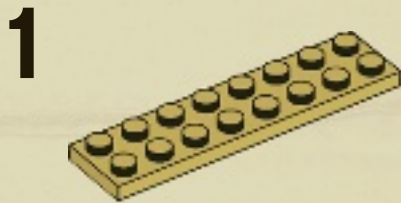
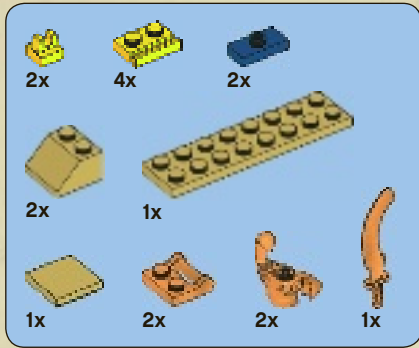
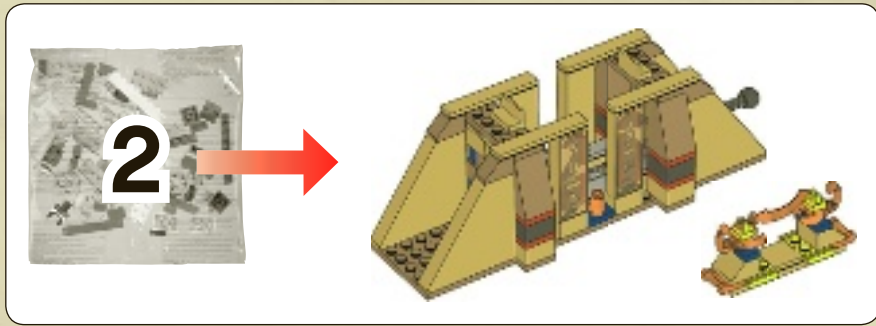

4

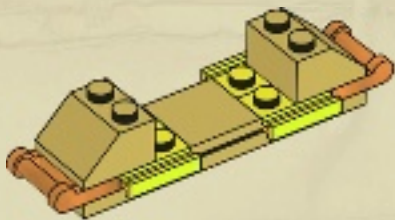

6

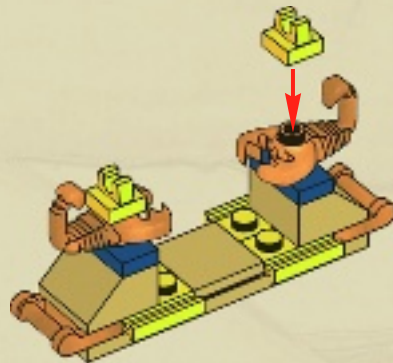

5

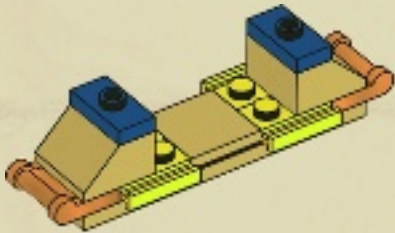

7

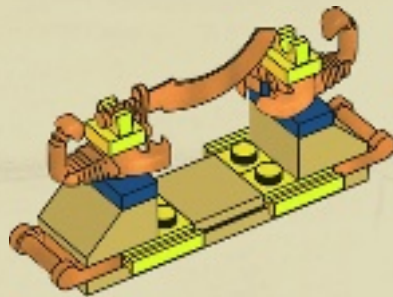

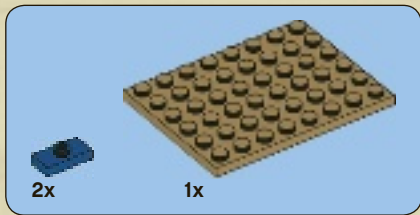
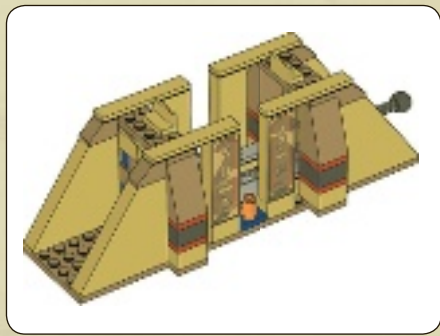

1

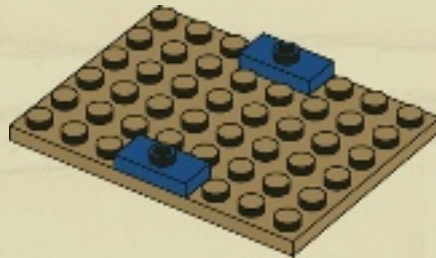

2

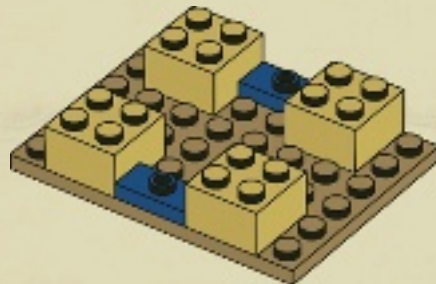



2x

3

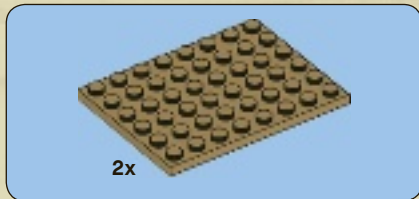
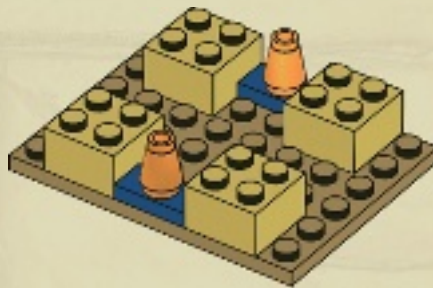

4

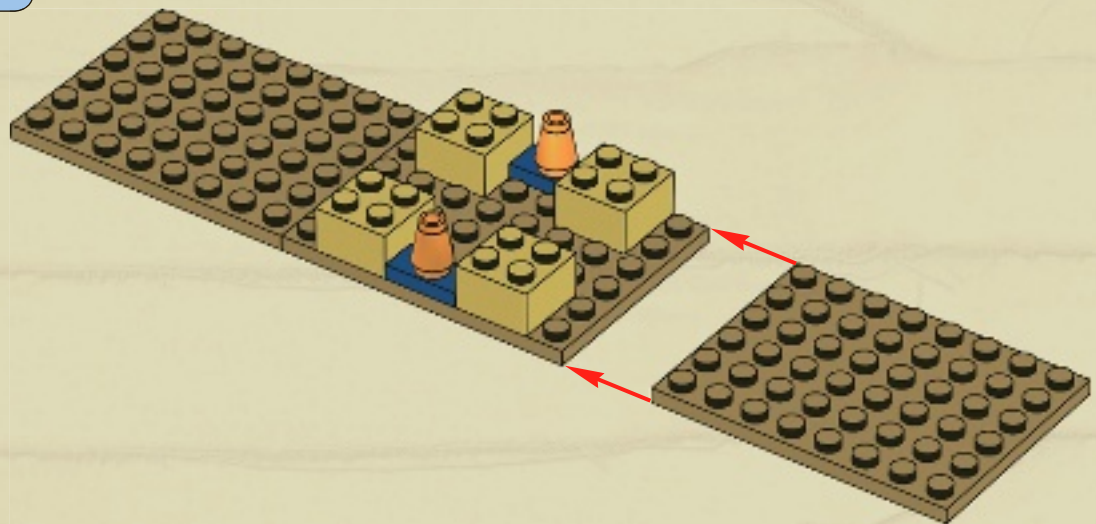



2x

5

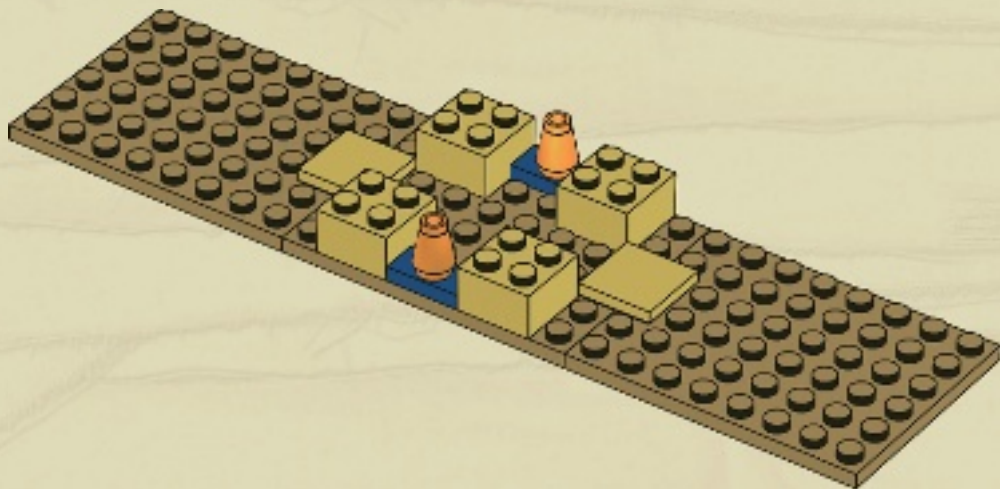

4x

6

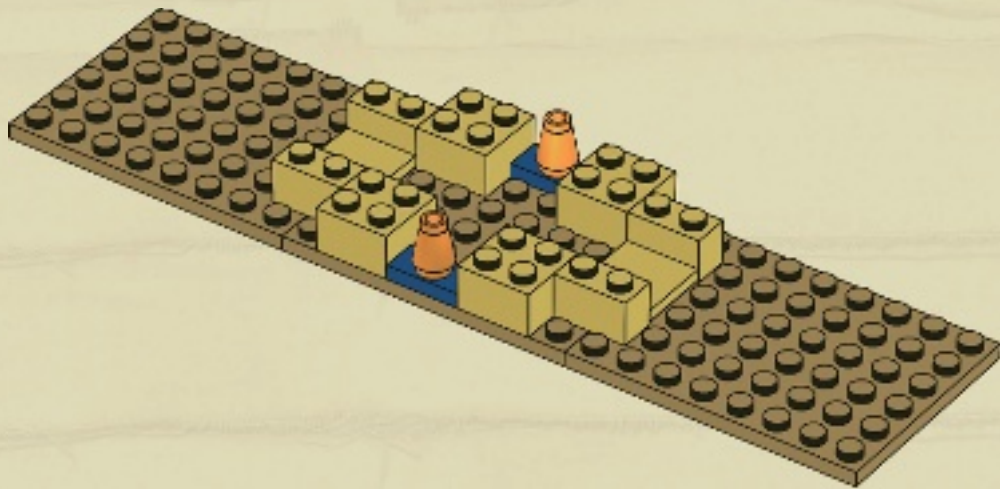

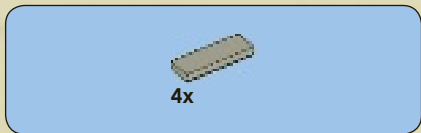

7

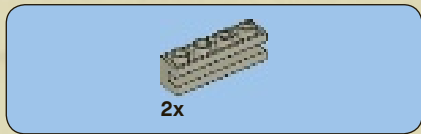
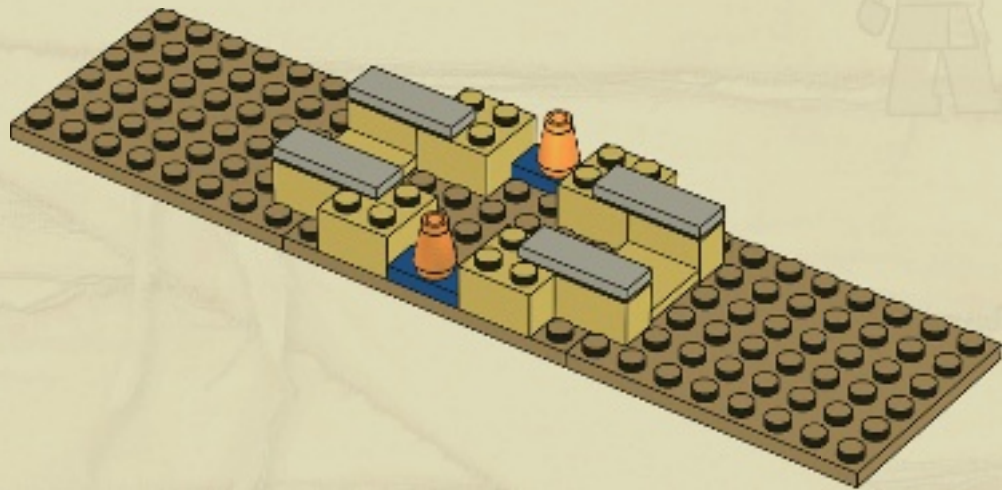

8

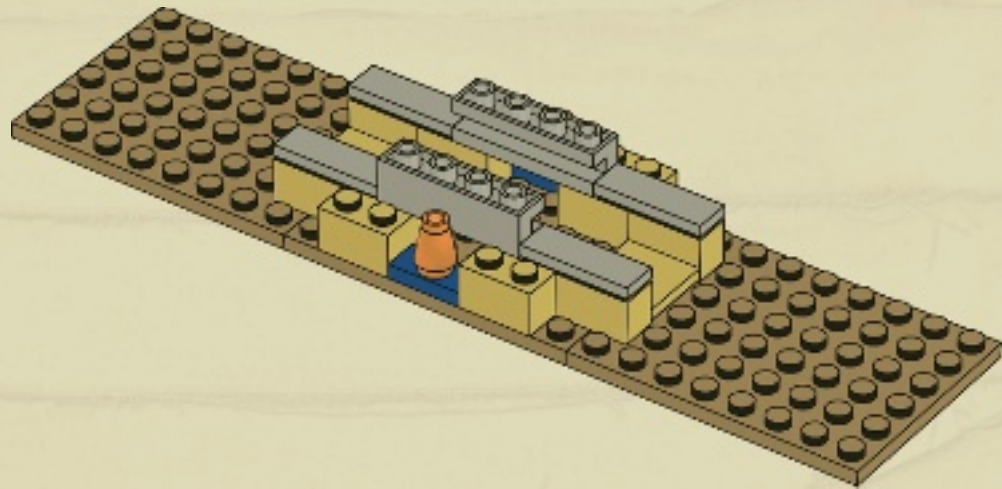

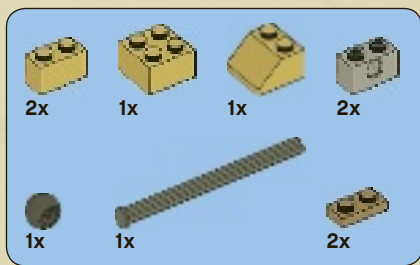

# 9

1



2

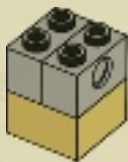

3

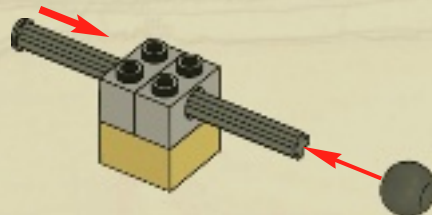

4

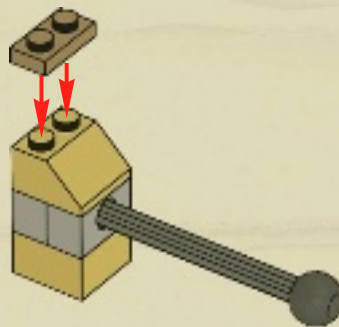





5

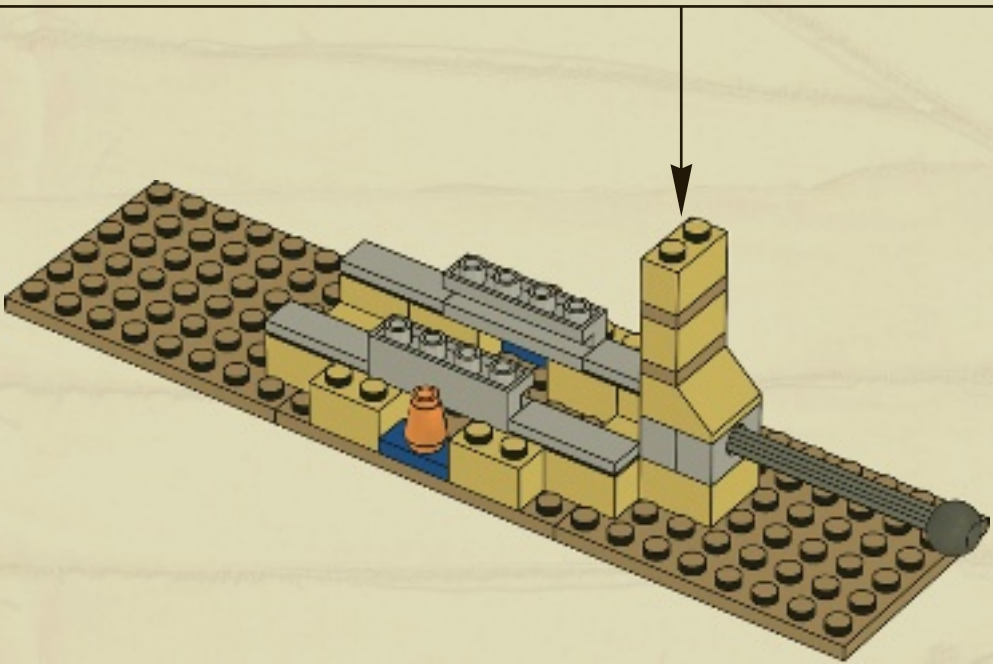
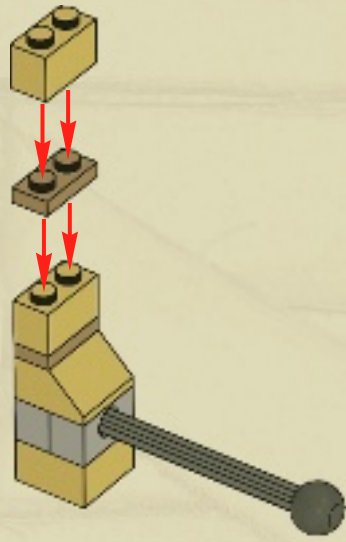

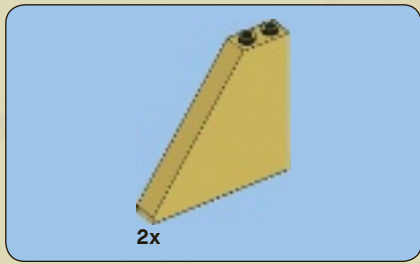

10

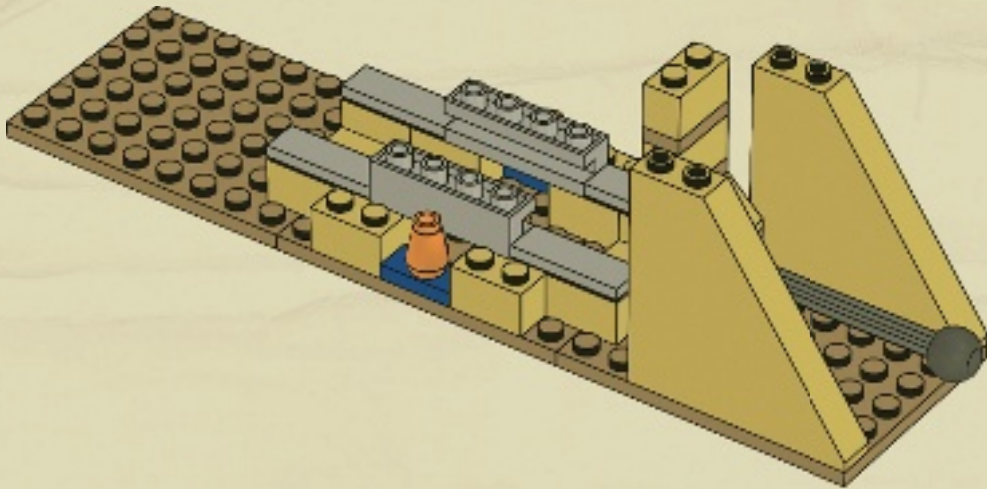





2x

# 12

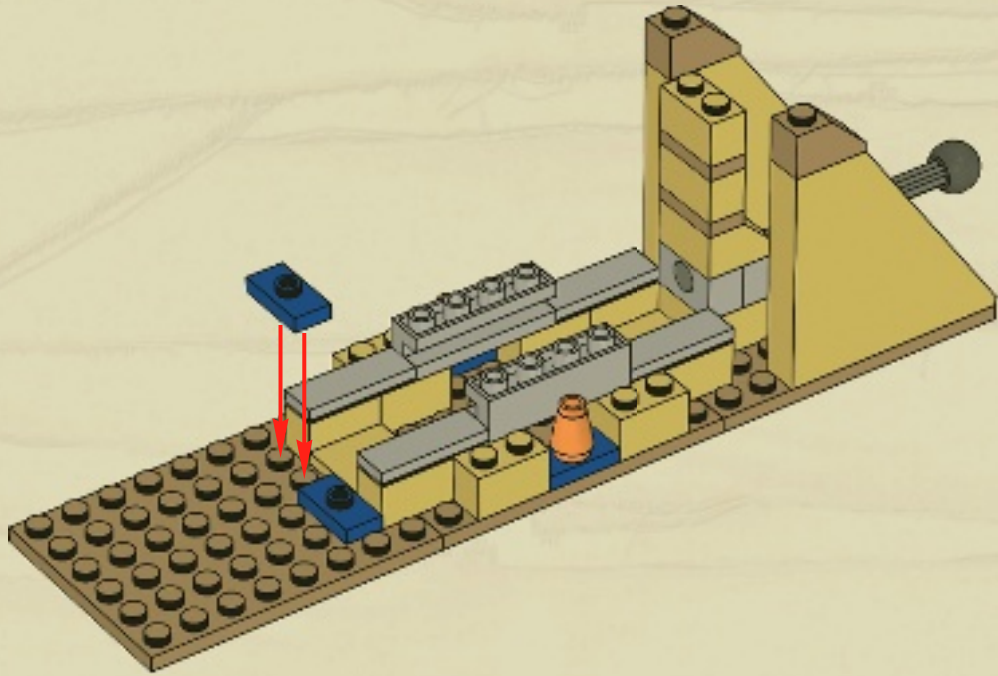



13

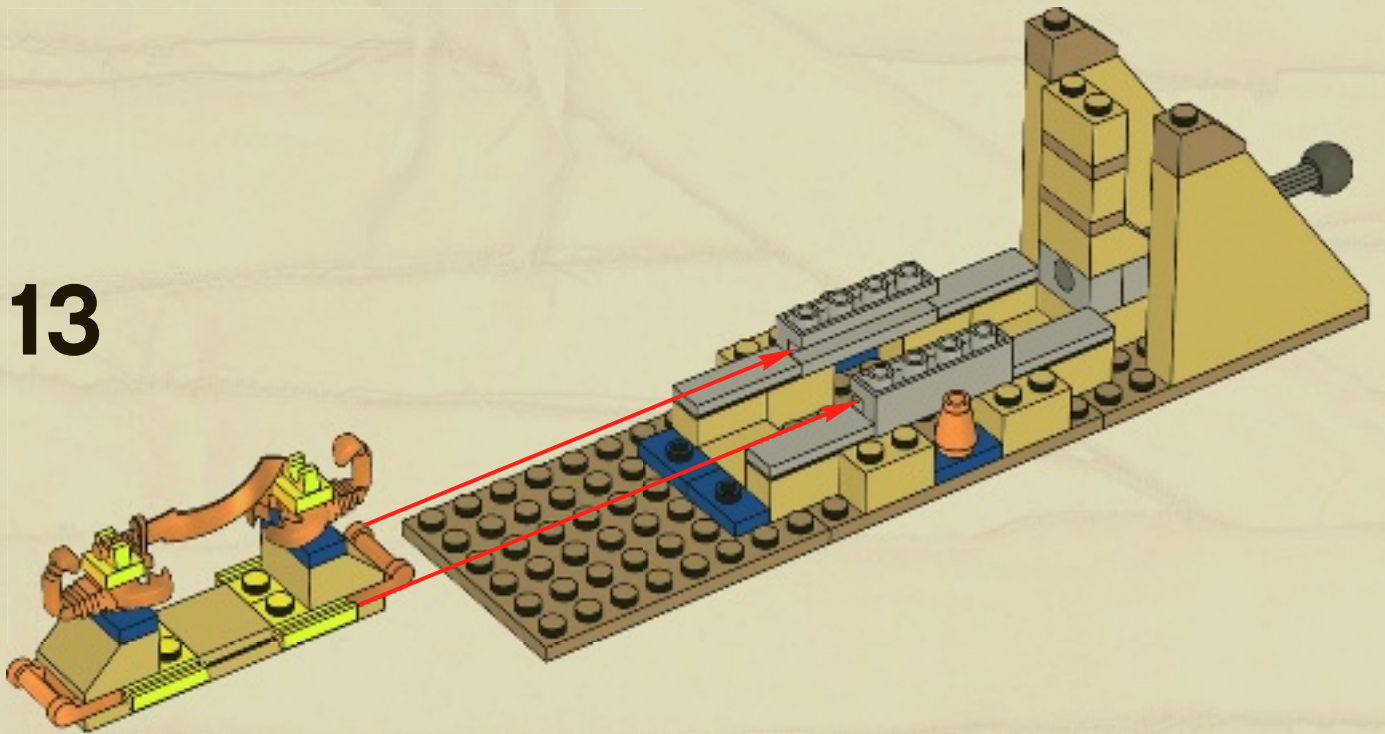

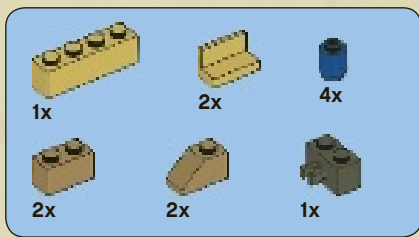

14

1

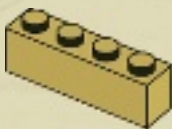

2

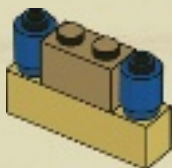

3

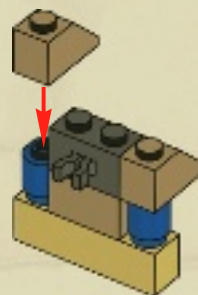

4

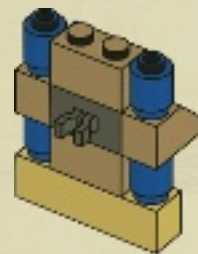

5

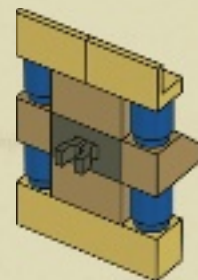

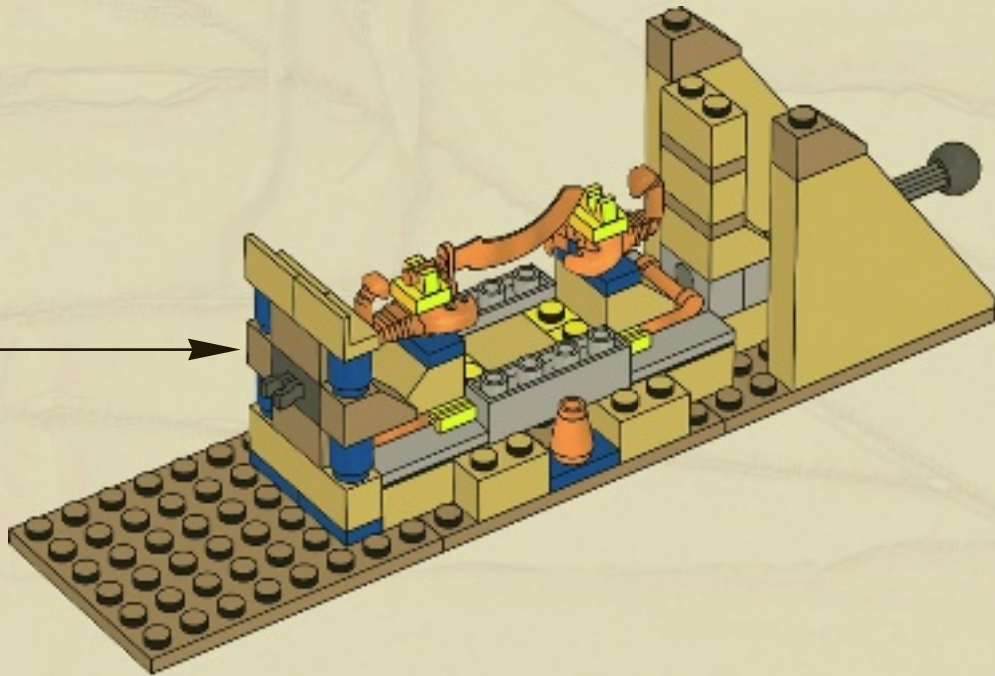

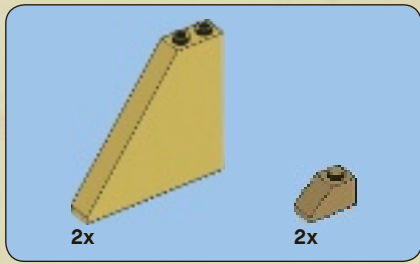

15

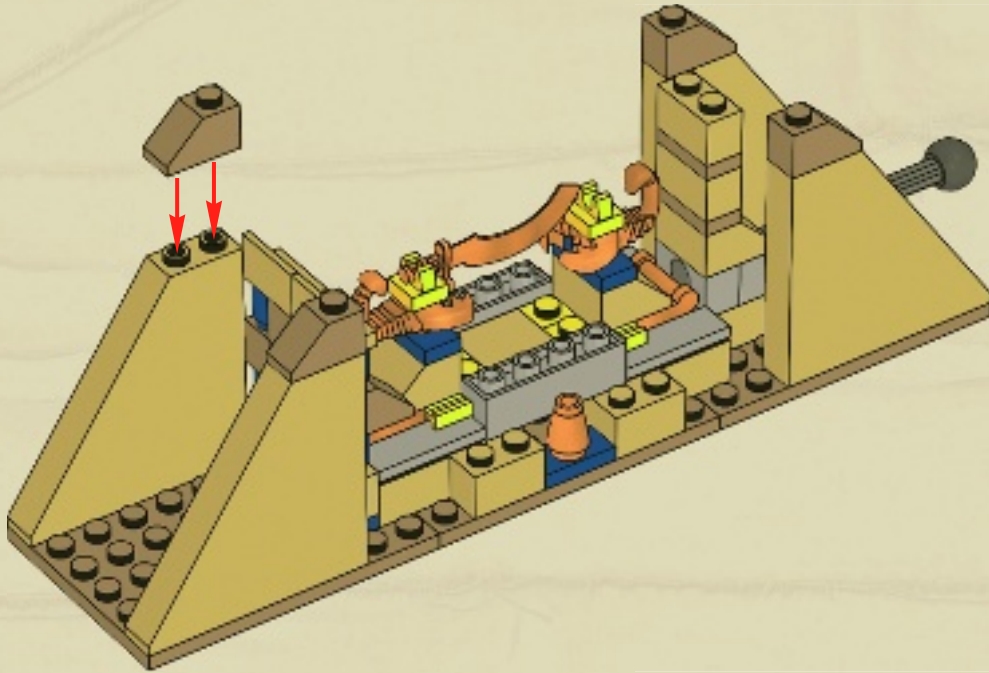



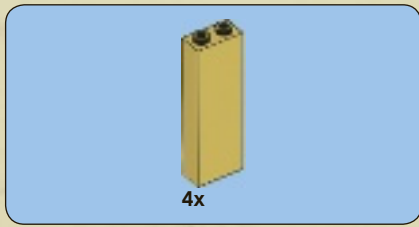

16

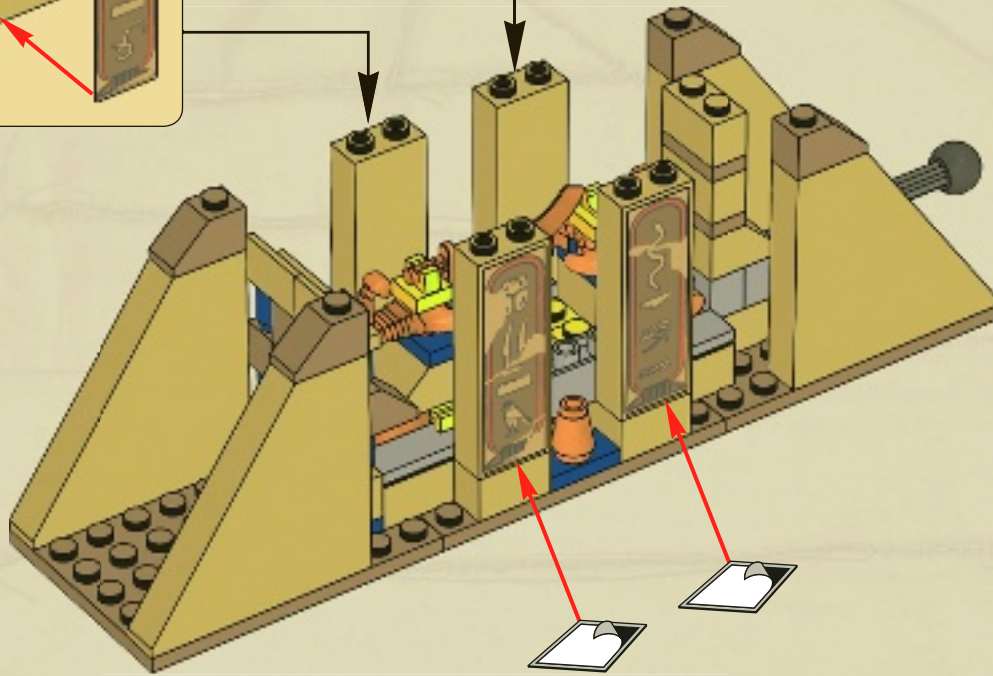
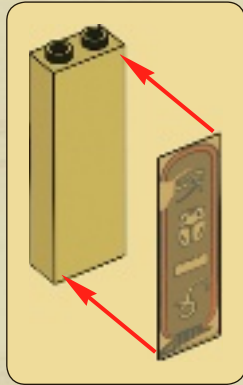
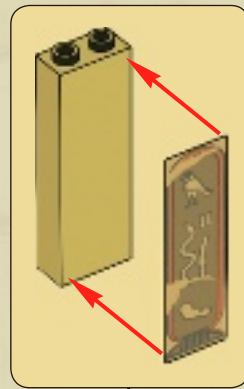

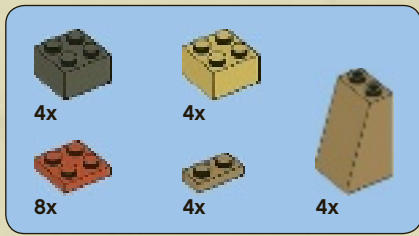

# 17

1

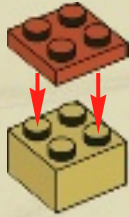

2

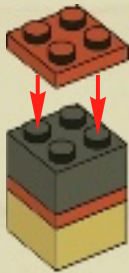

3

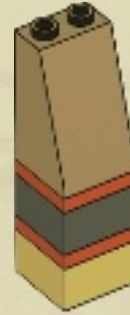

4

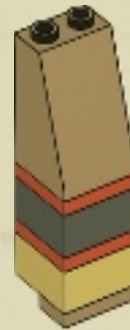

4x

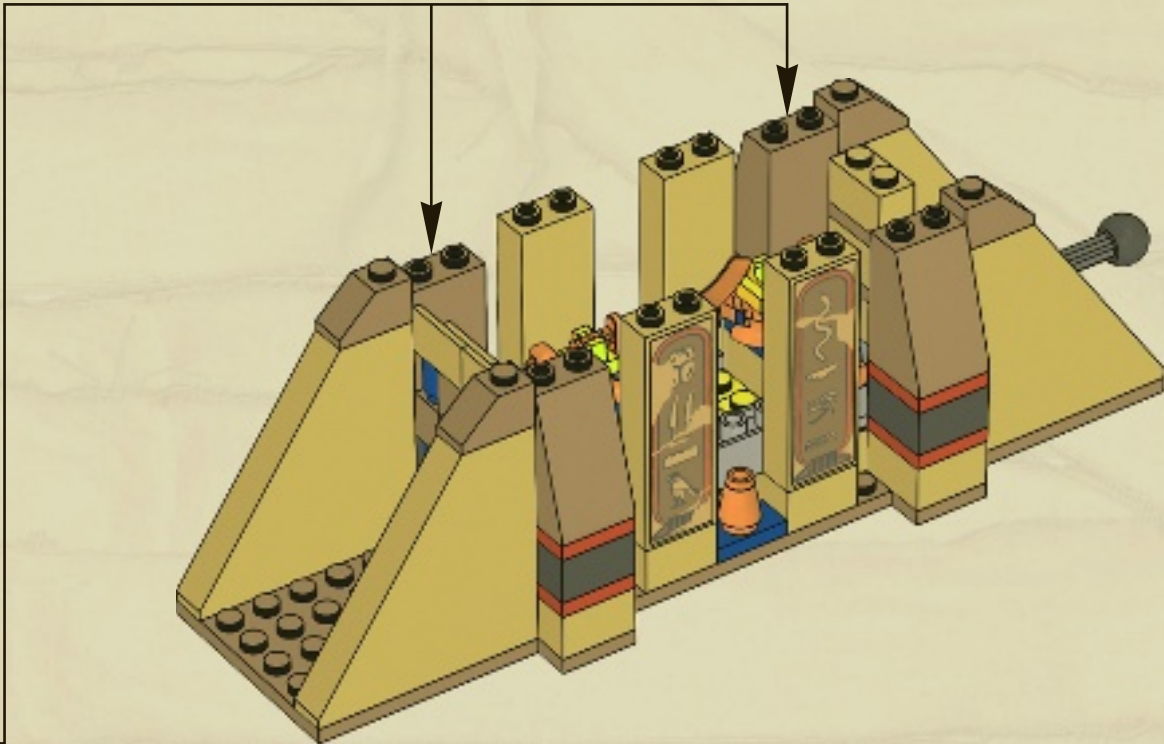



2x

# 18

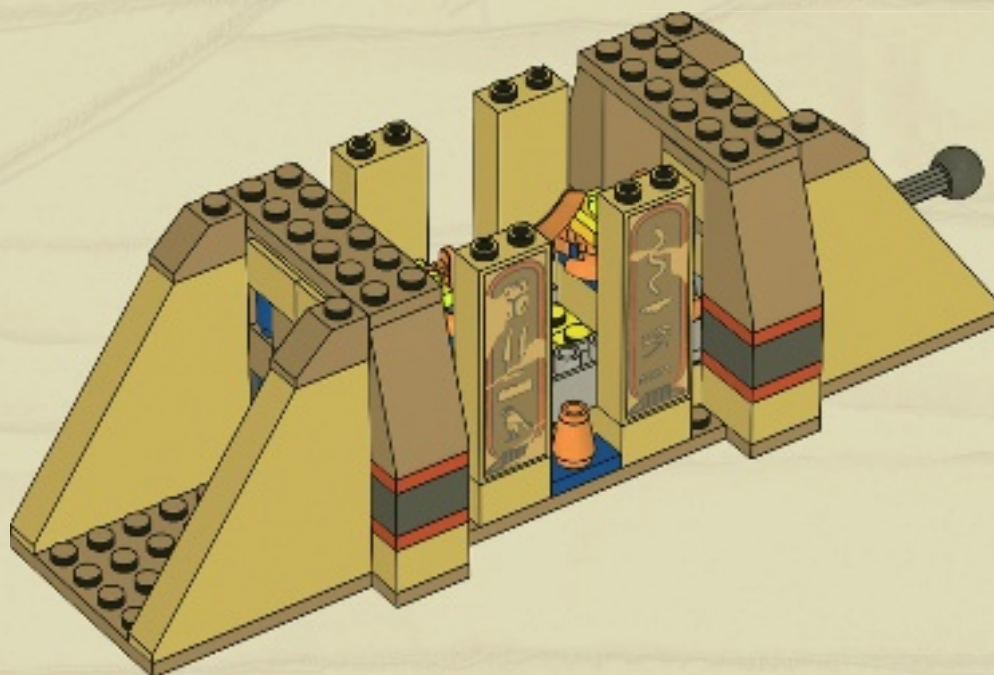



2x



4x

# 19

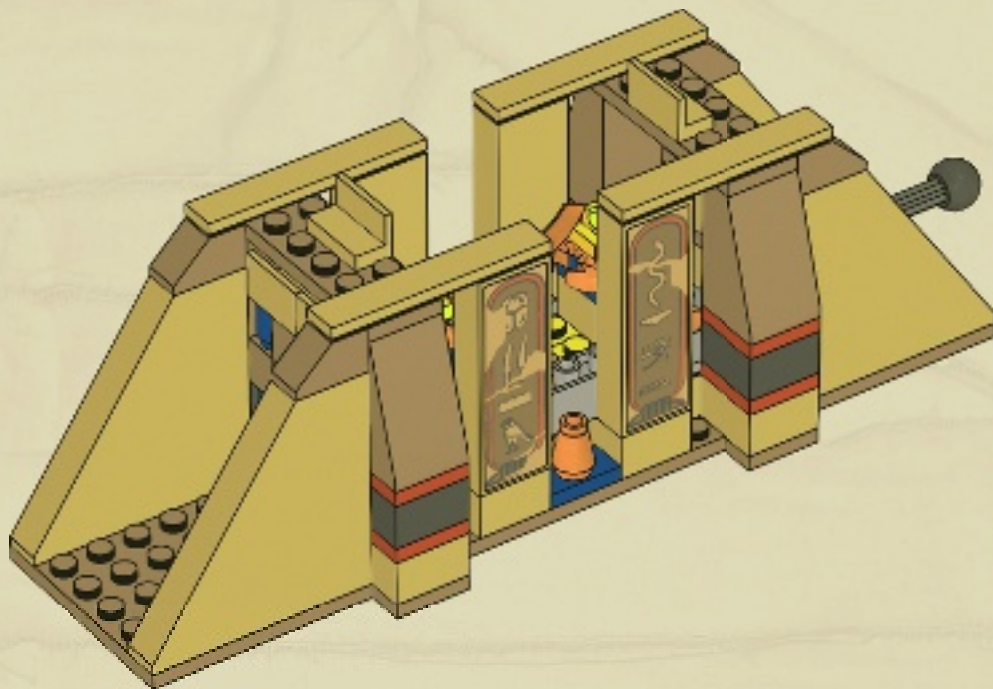

1

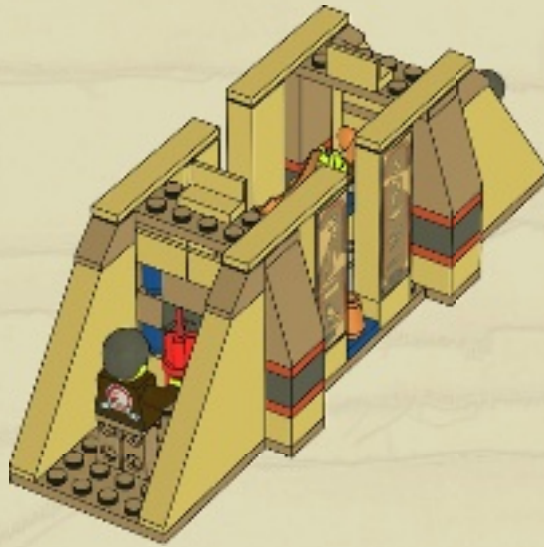

2

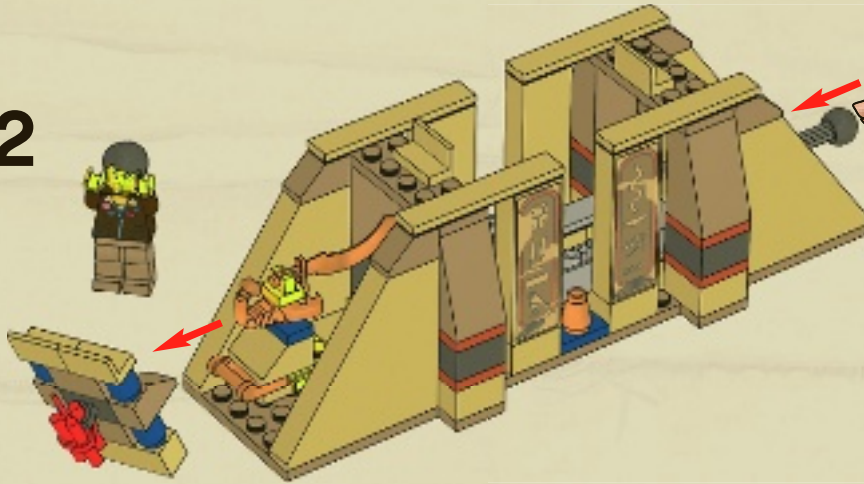

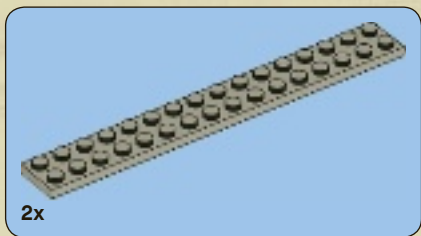
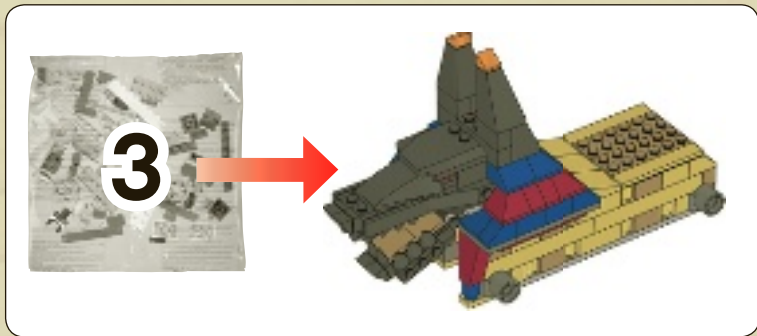

1

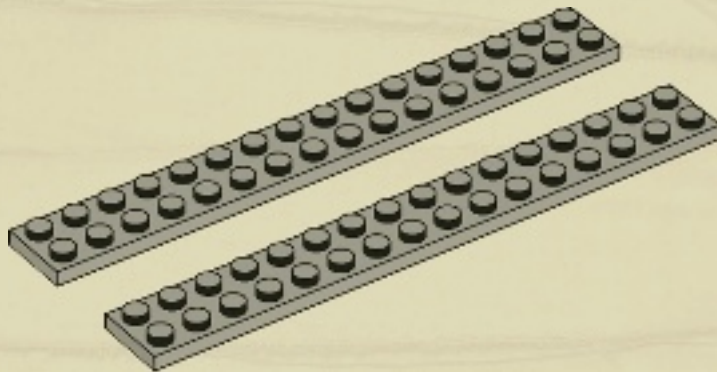



2

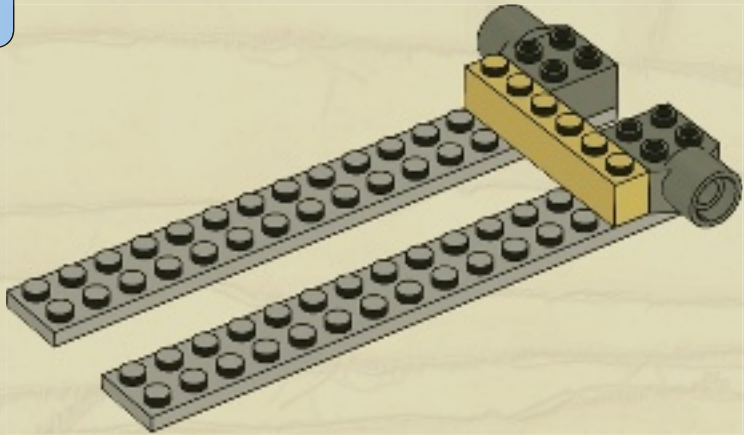

3

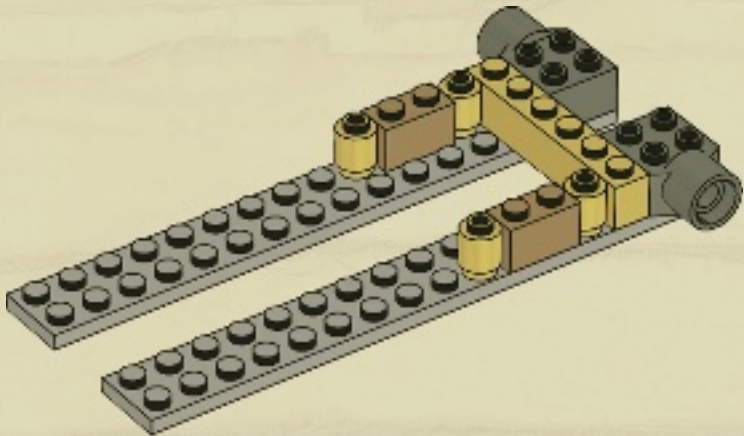





4

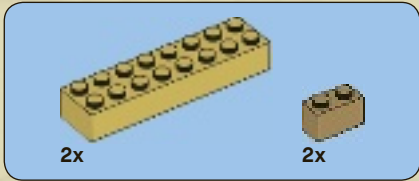
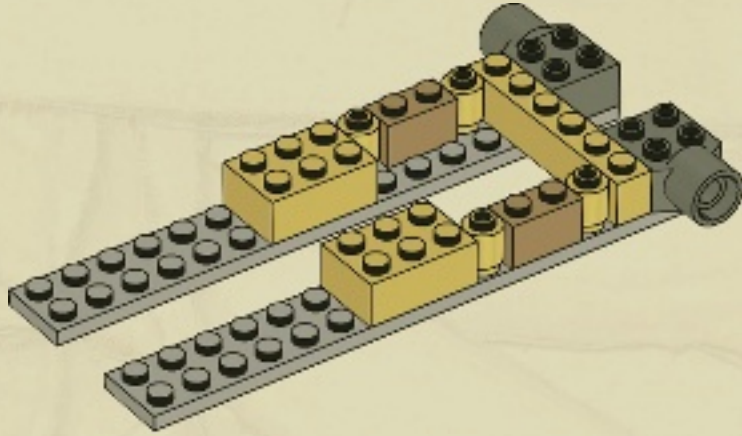

5

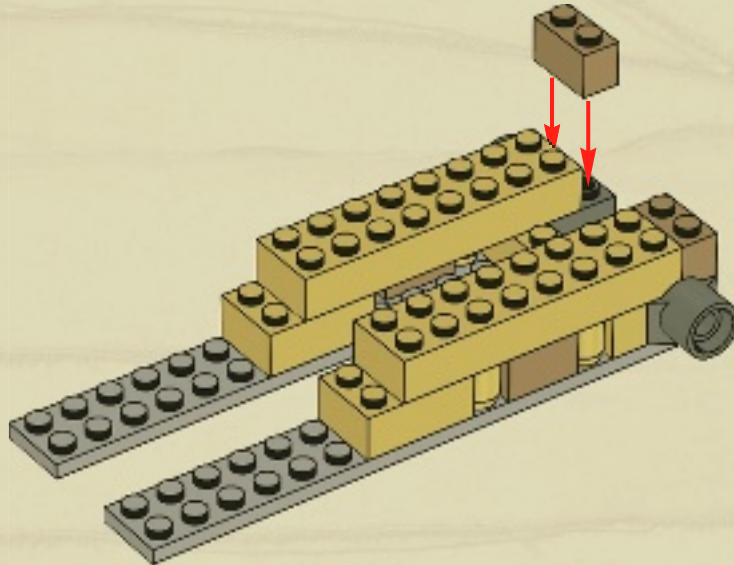



6

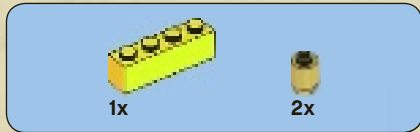
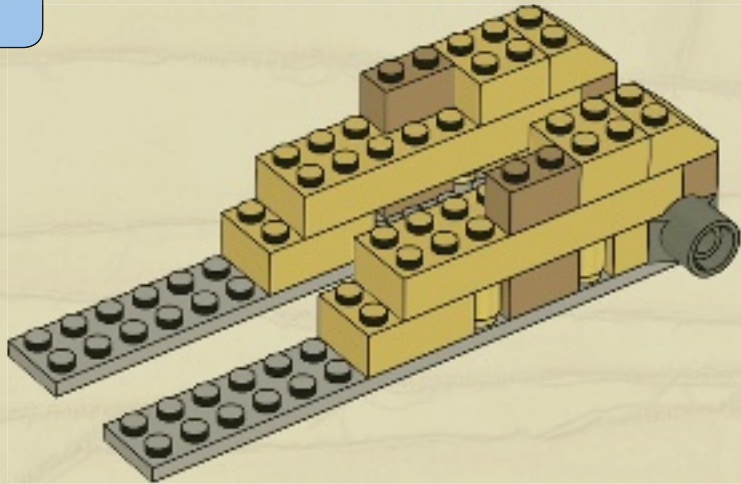

7

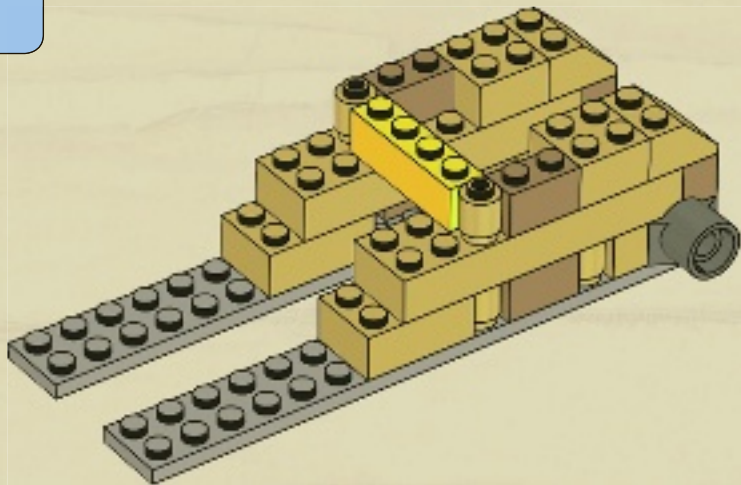

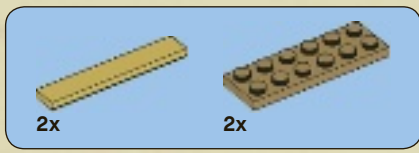

8

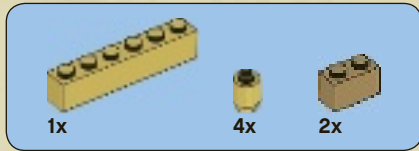
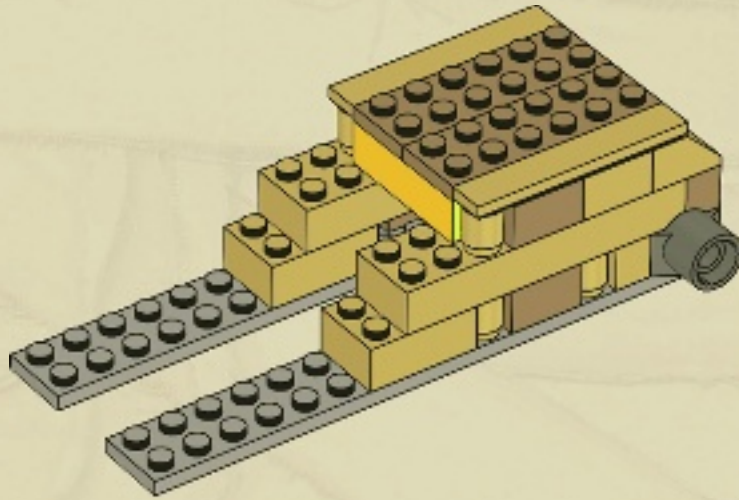

9

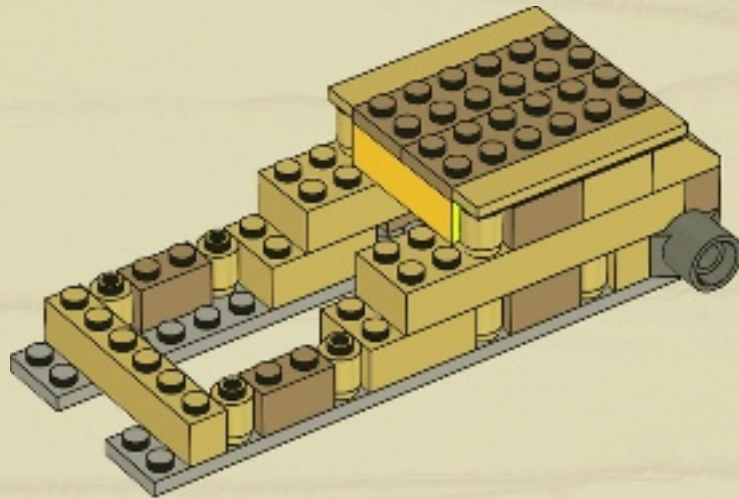



2x

# 10

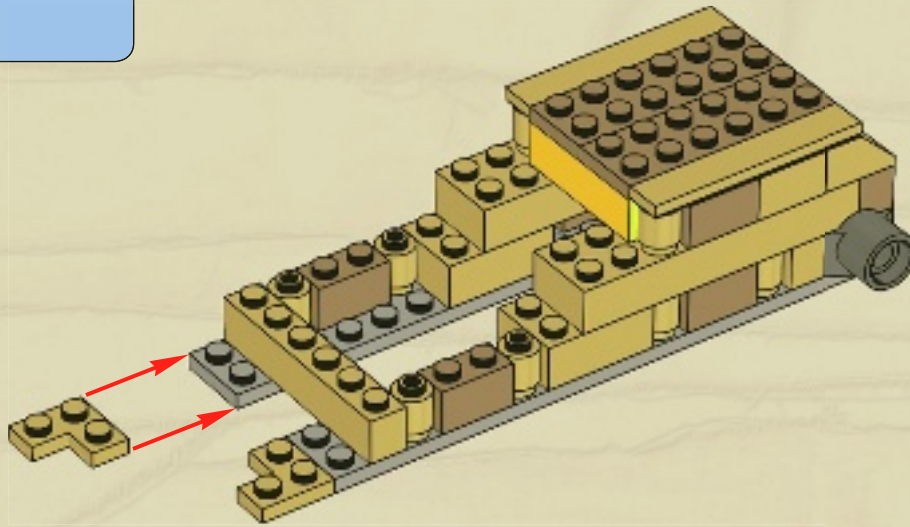

2x

# 11

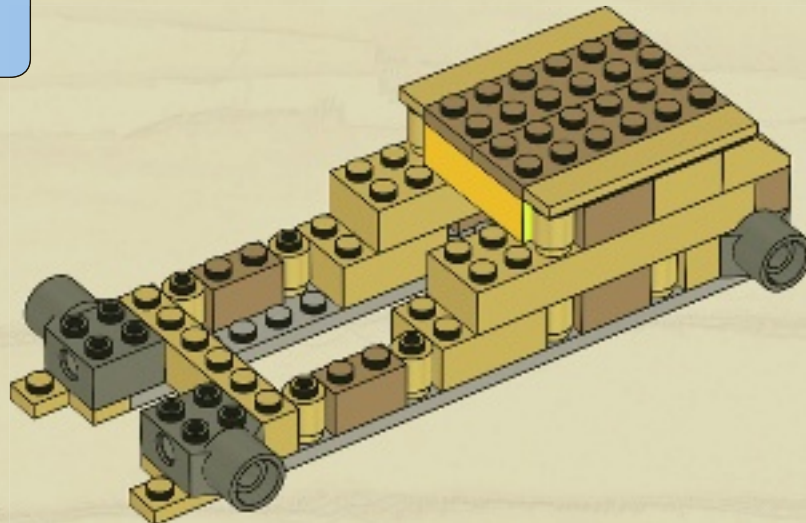

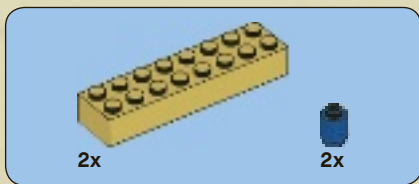

12

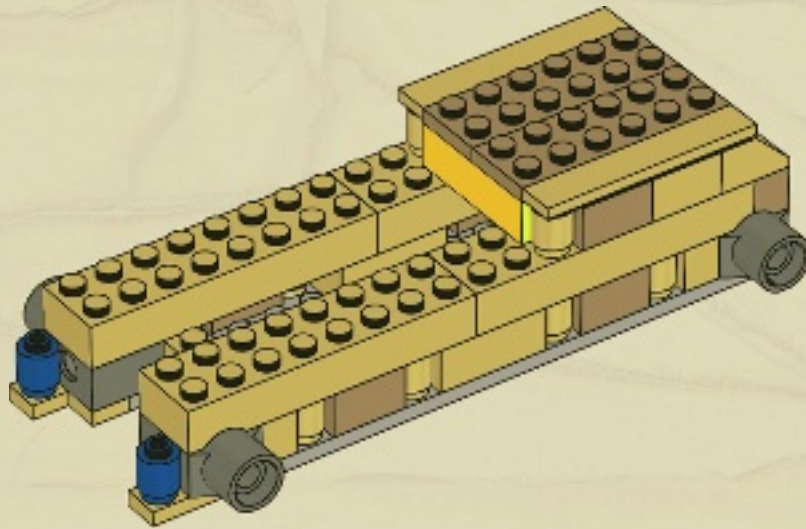

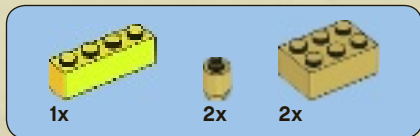

13

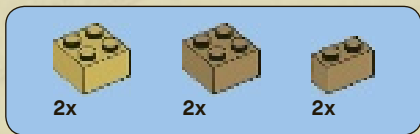
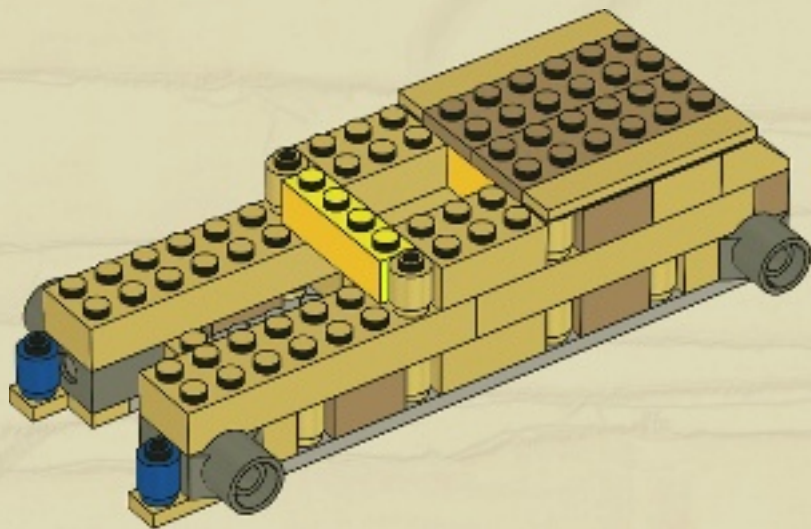

14

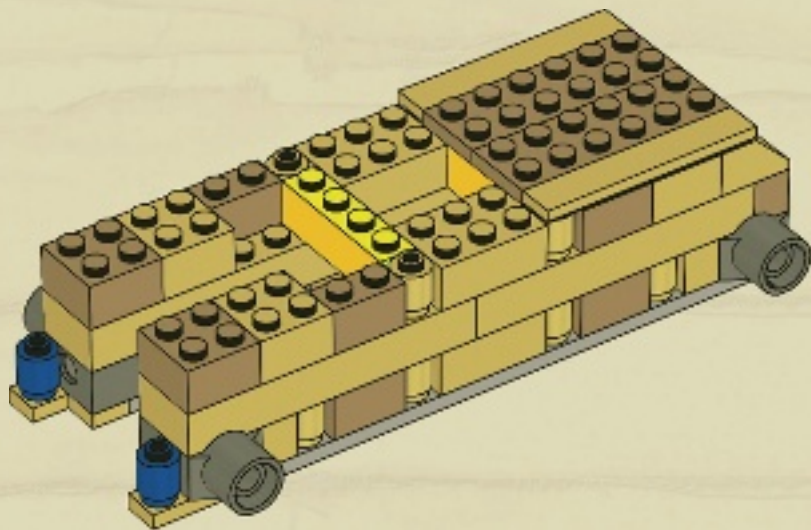



# 15

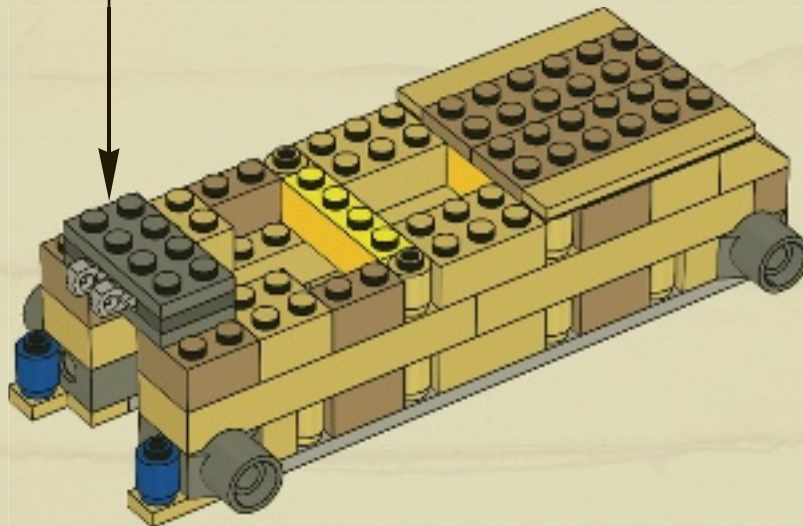
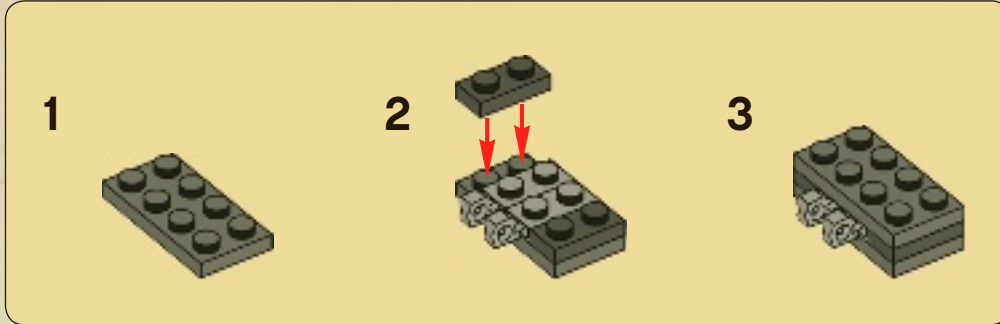



6x

16

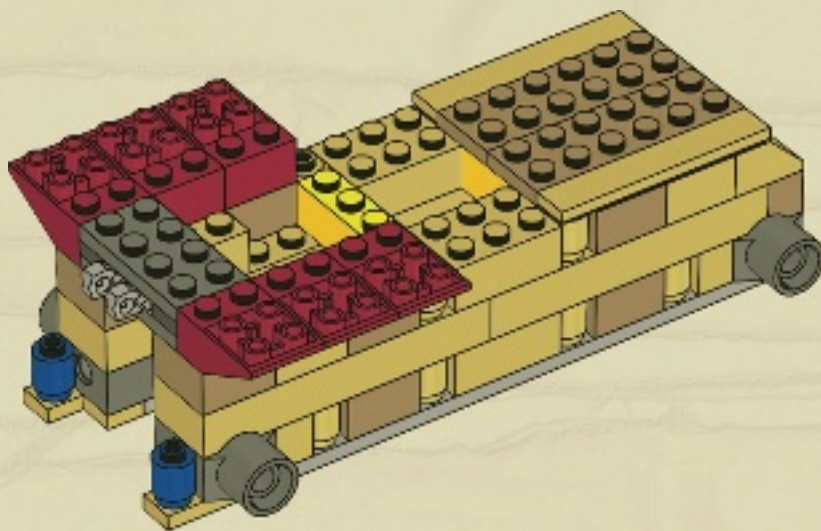

3x

17

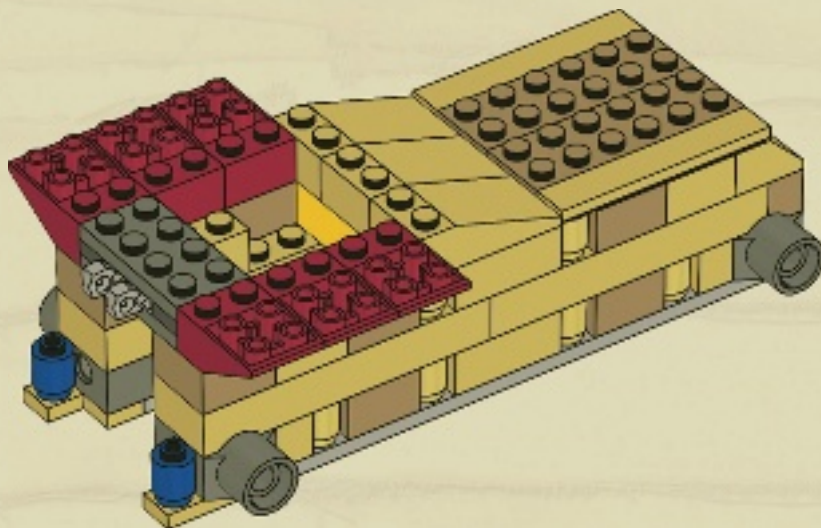





18

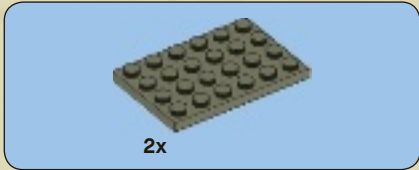
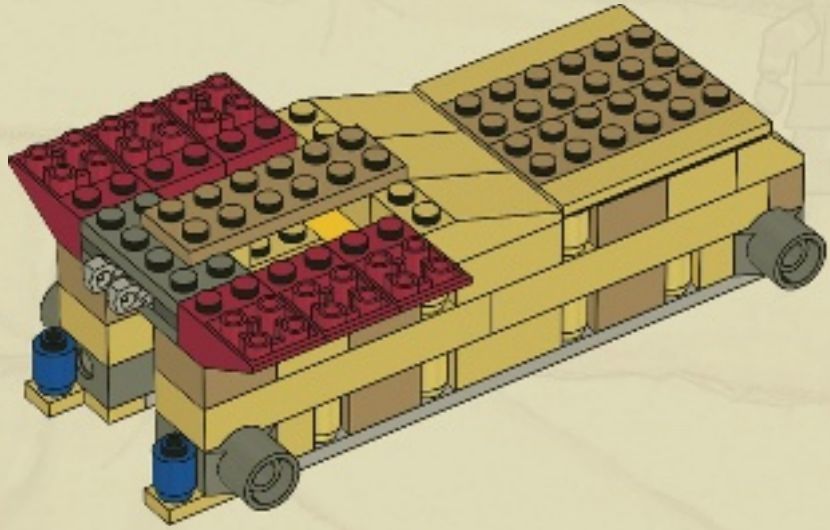

19

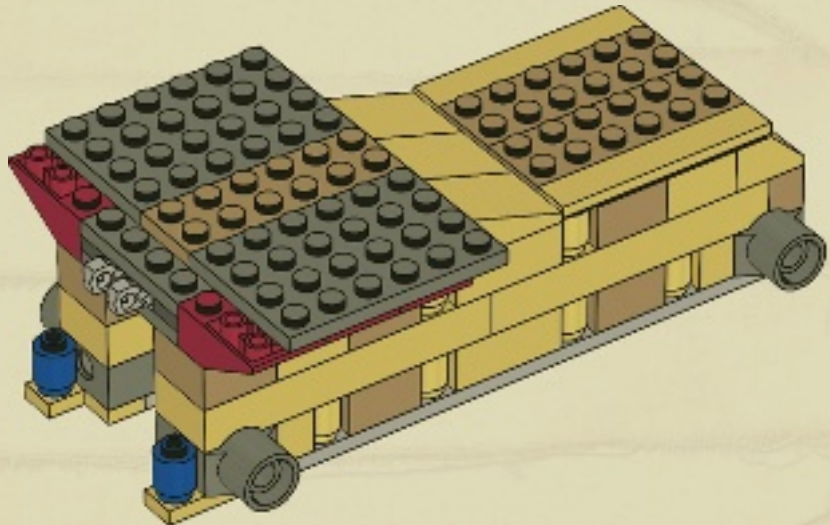

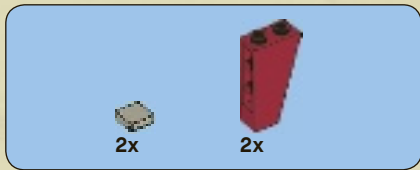

20

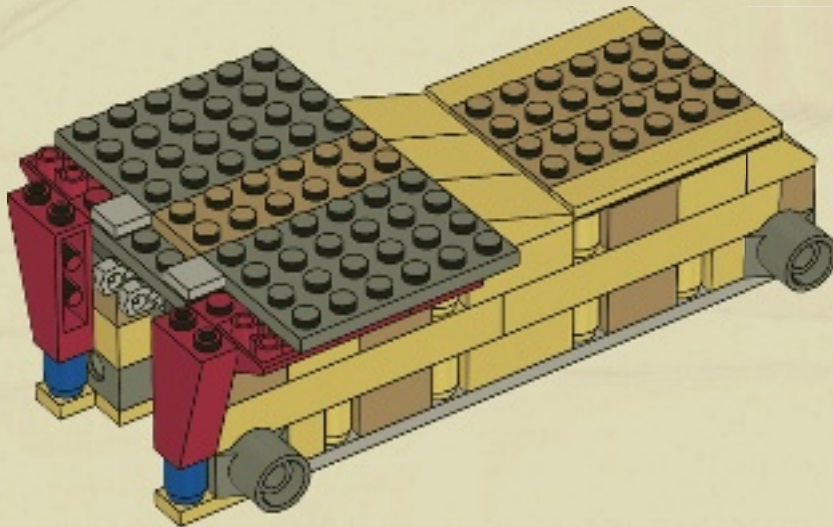



21

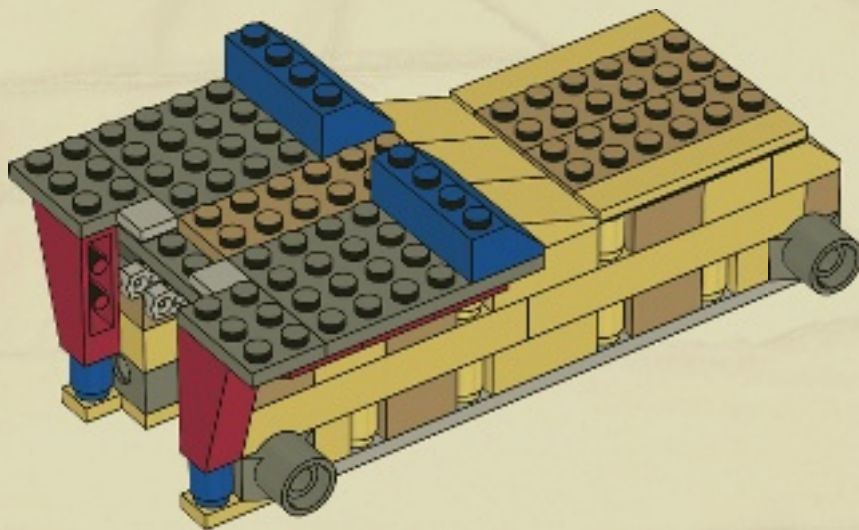



1x



4x

# 22

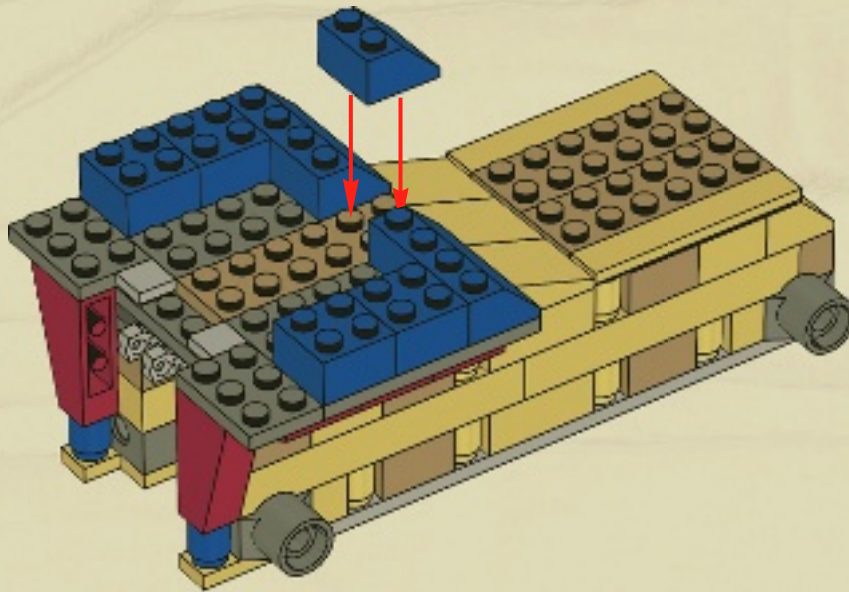



23

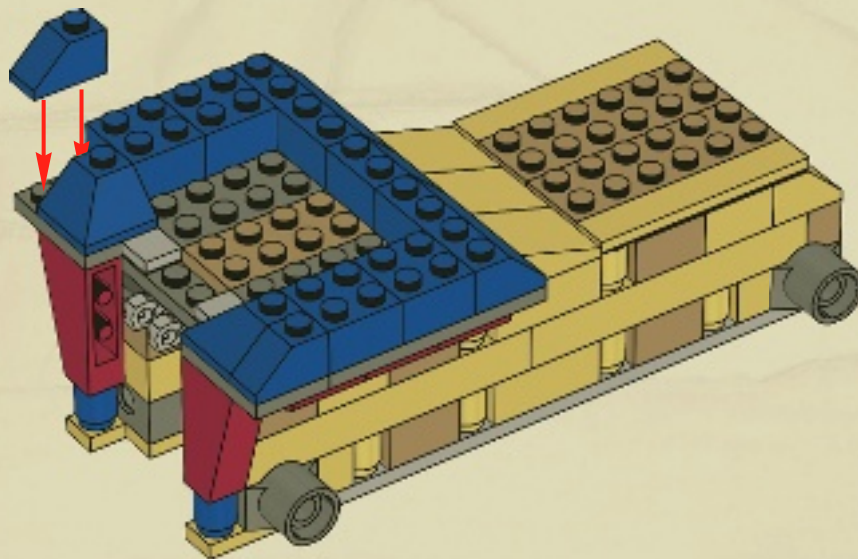



24

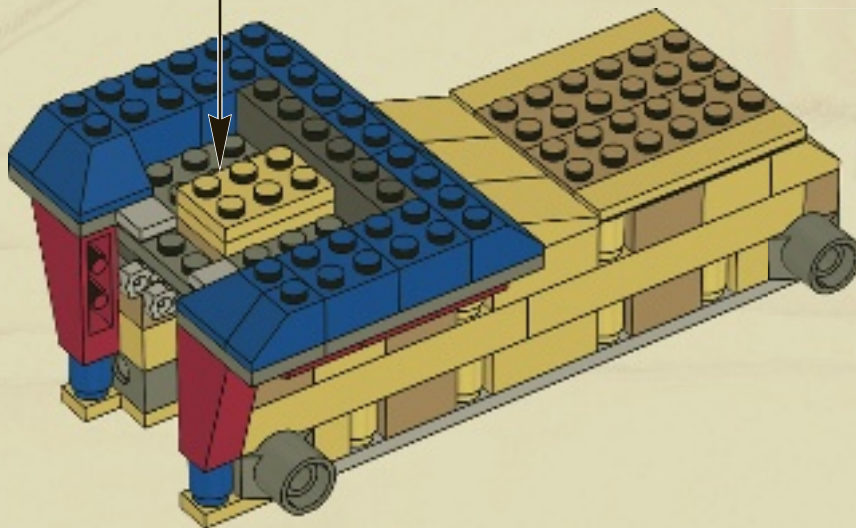
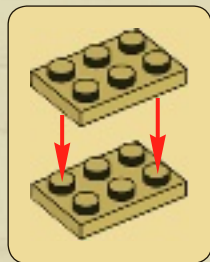

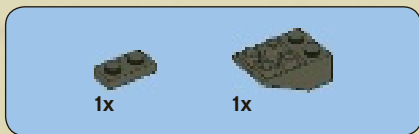

25

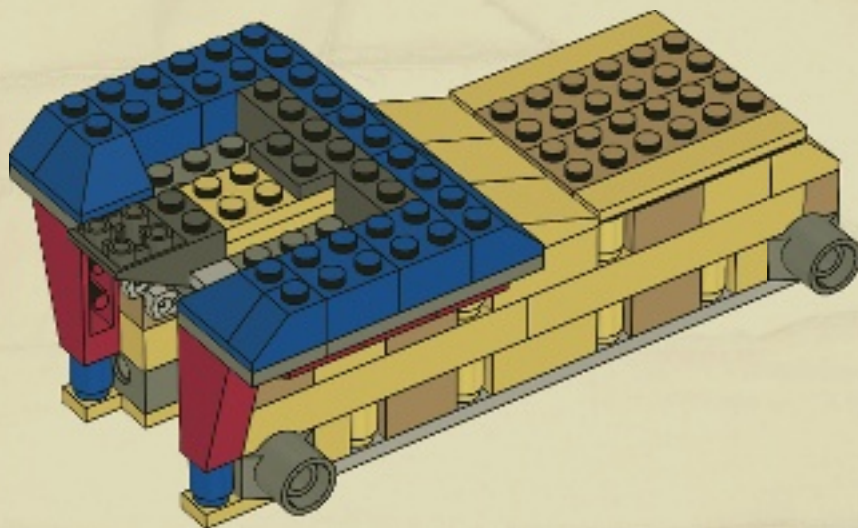



4x



4x

# 26

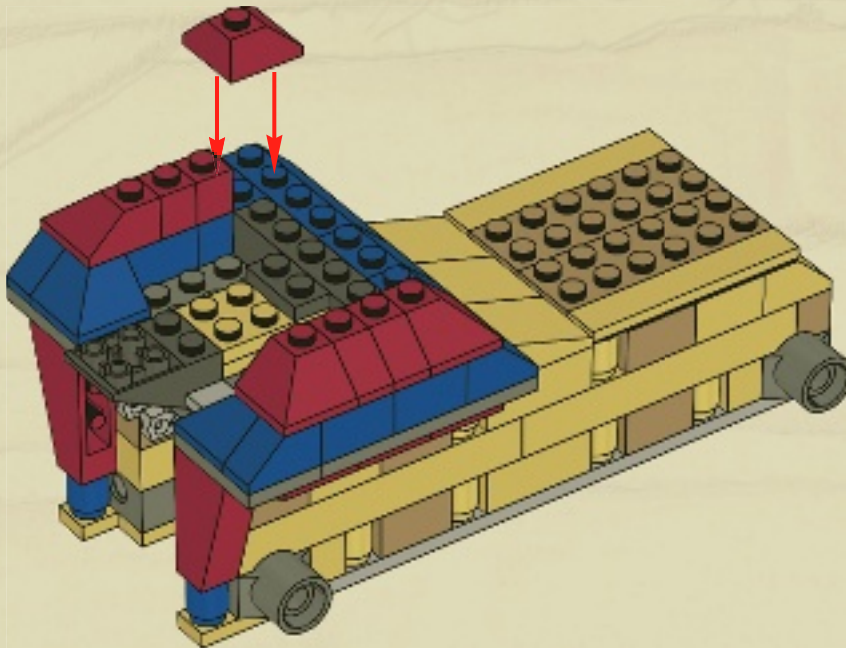



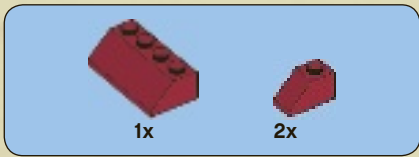

27

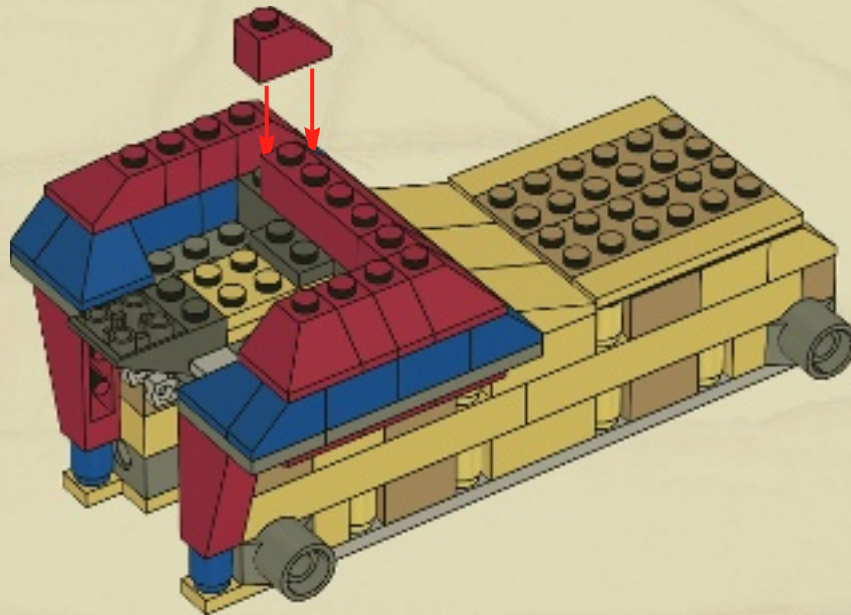

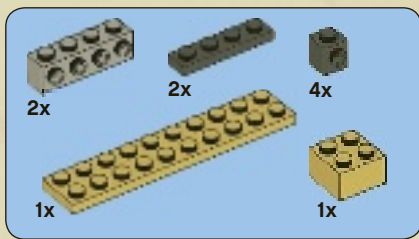

# 28

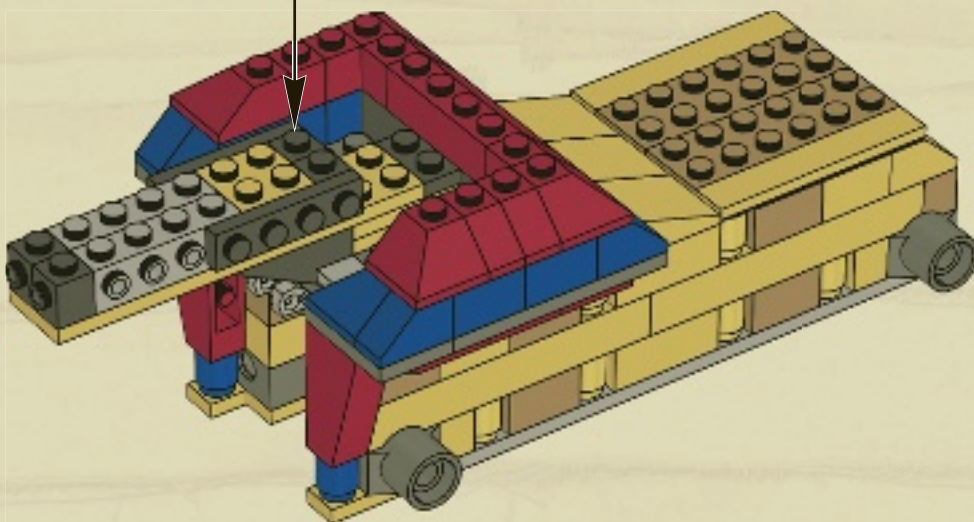
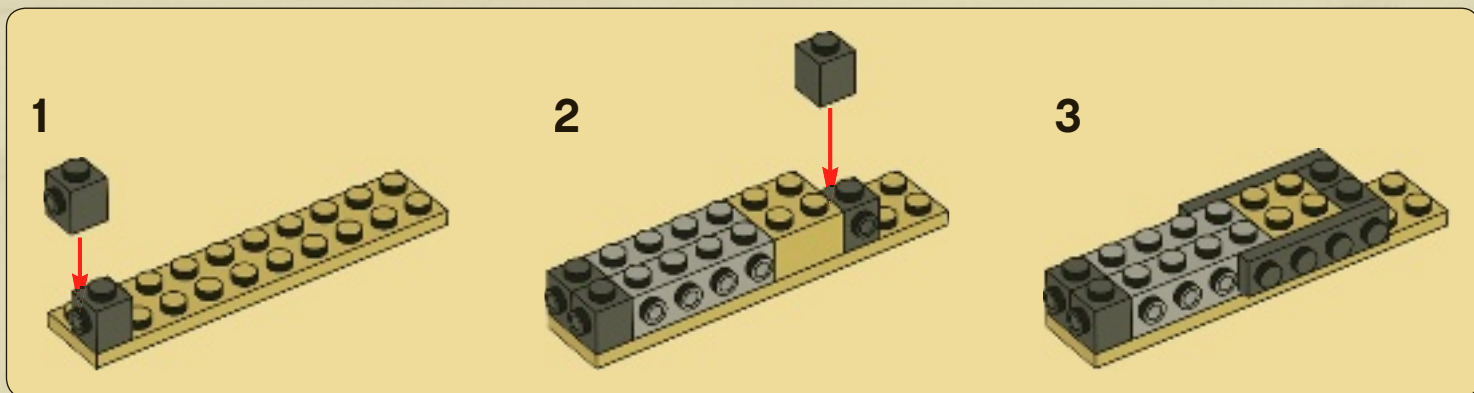

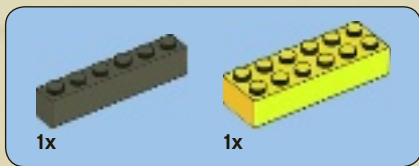

29

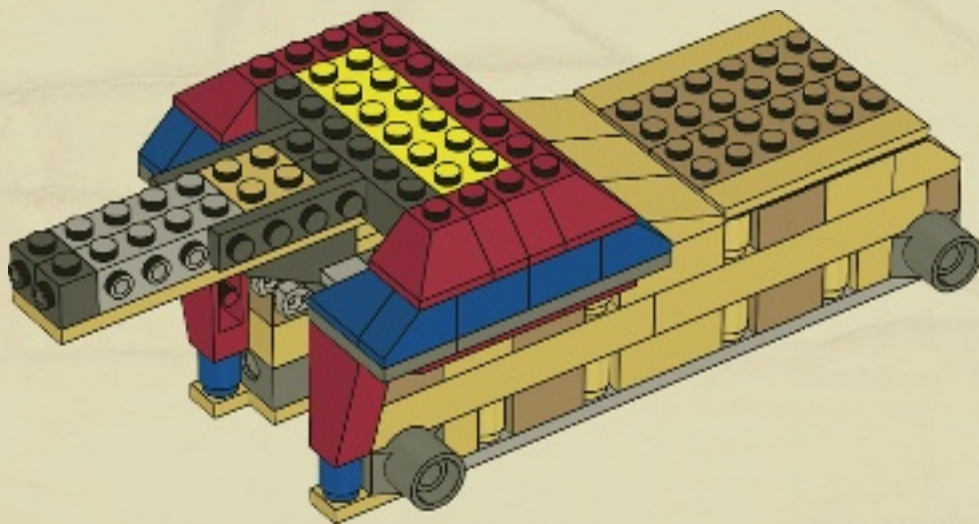

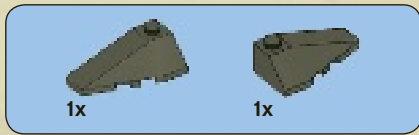

# 30

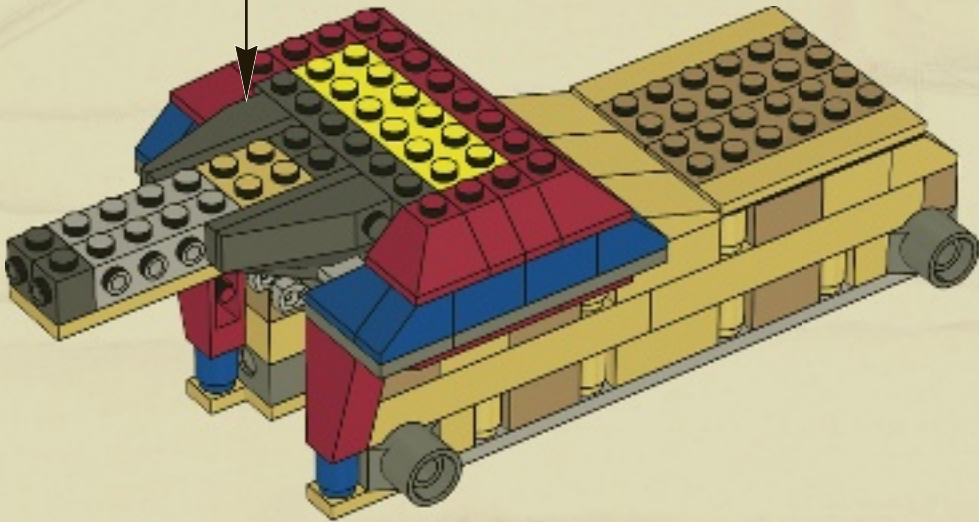



31

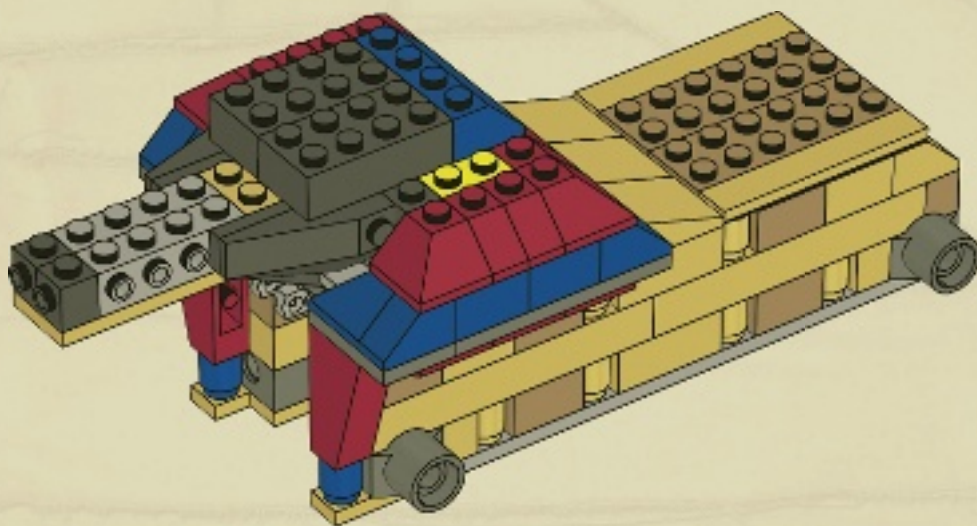



# 32

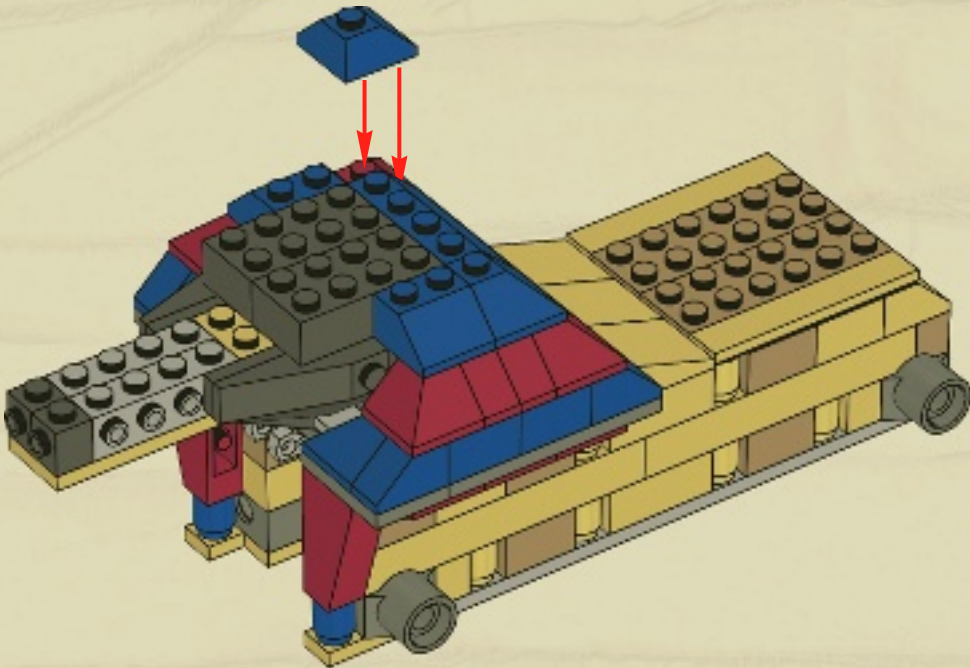



# 33

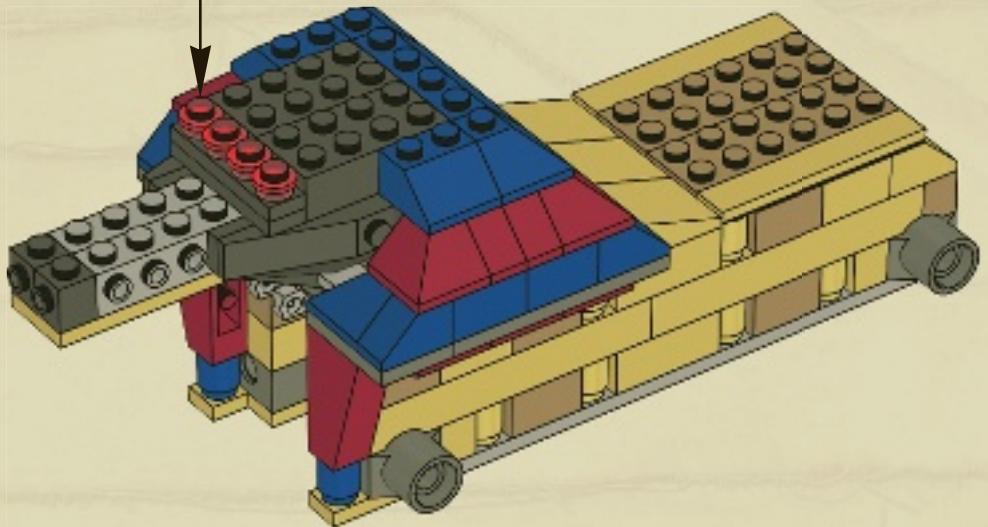
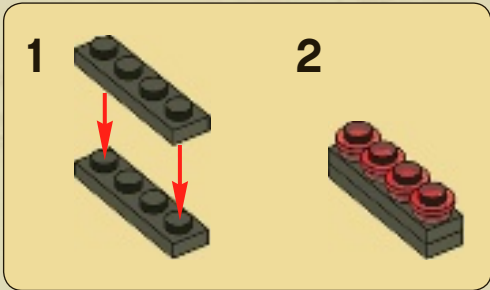

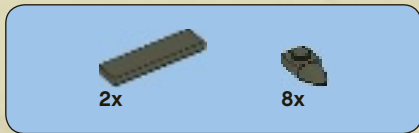

# 34

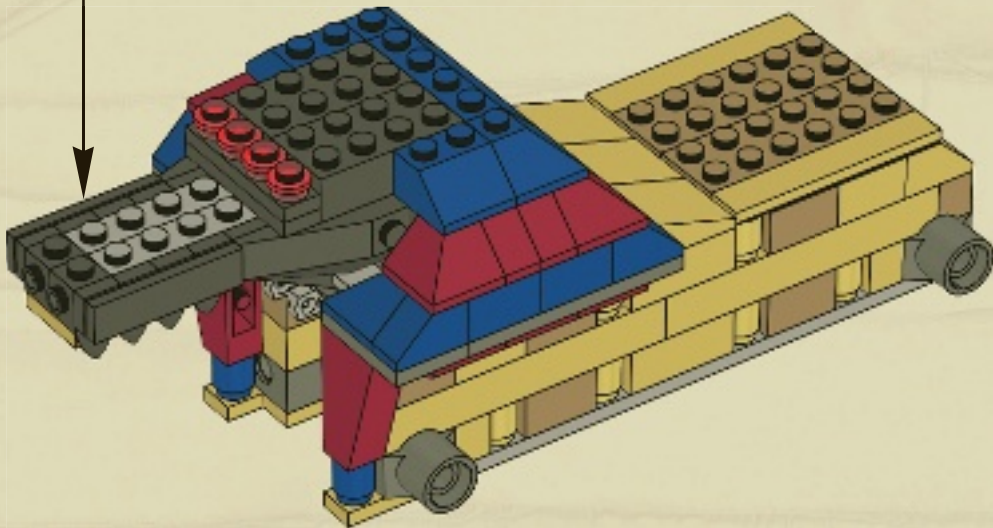
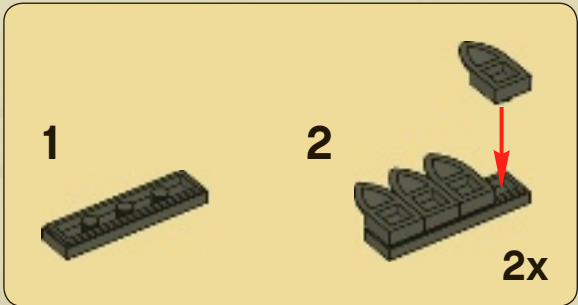





35

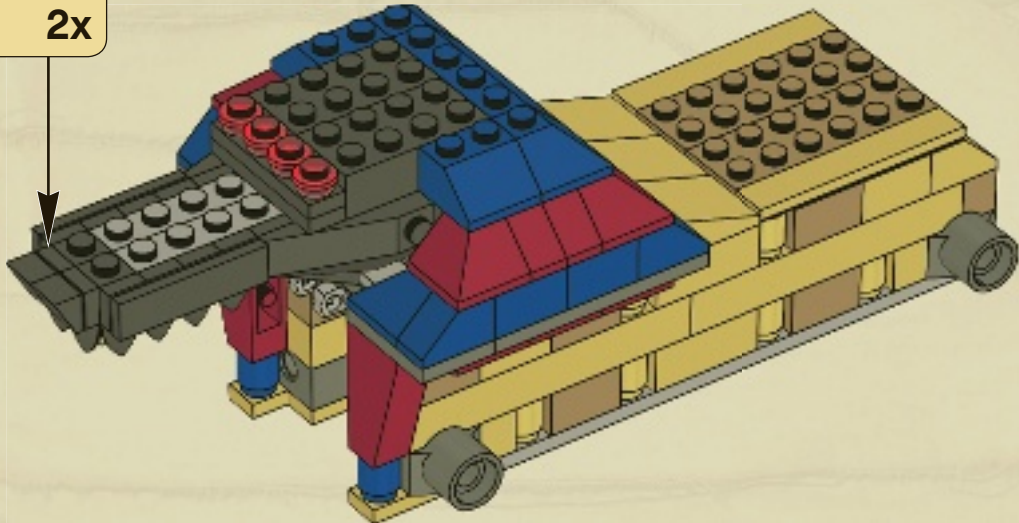
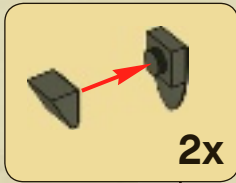



1x

# 36

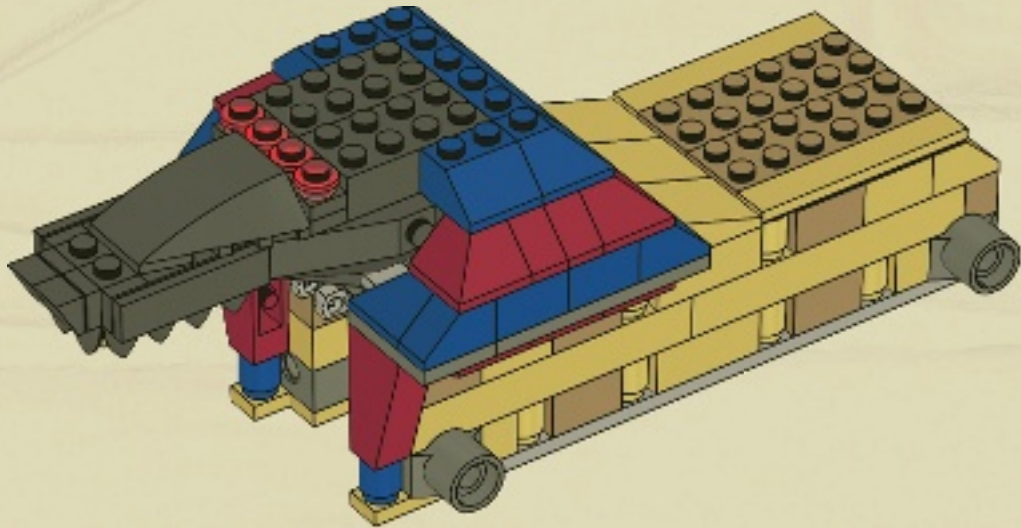



37

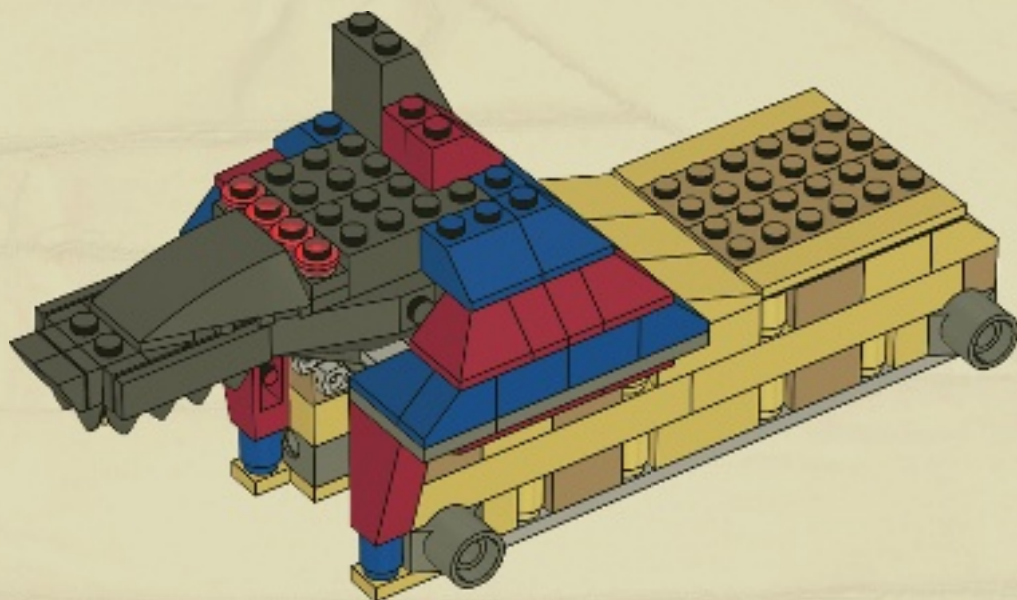

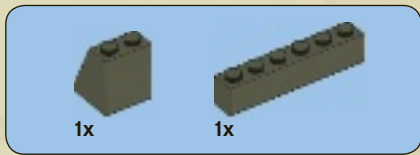

38

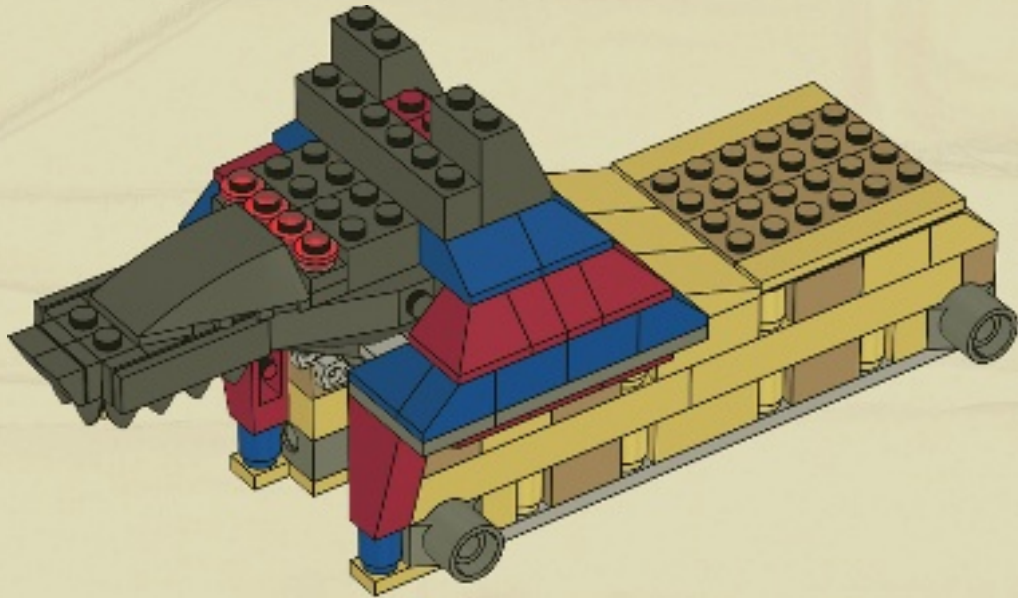

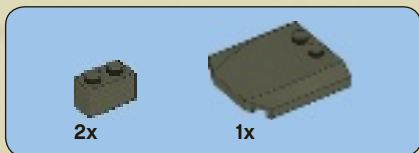

# 39

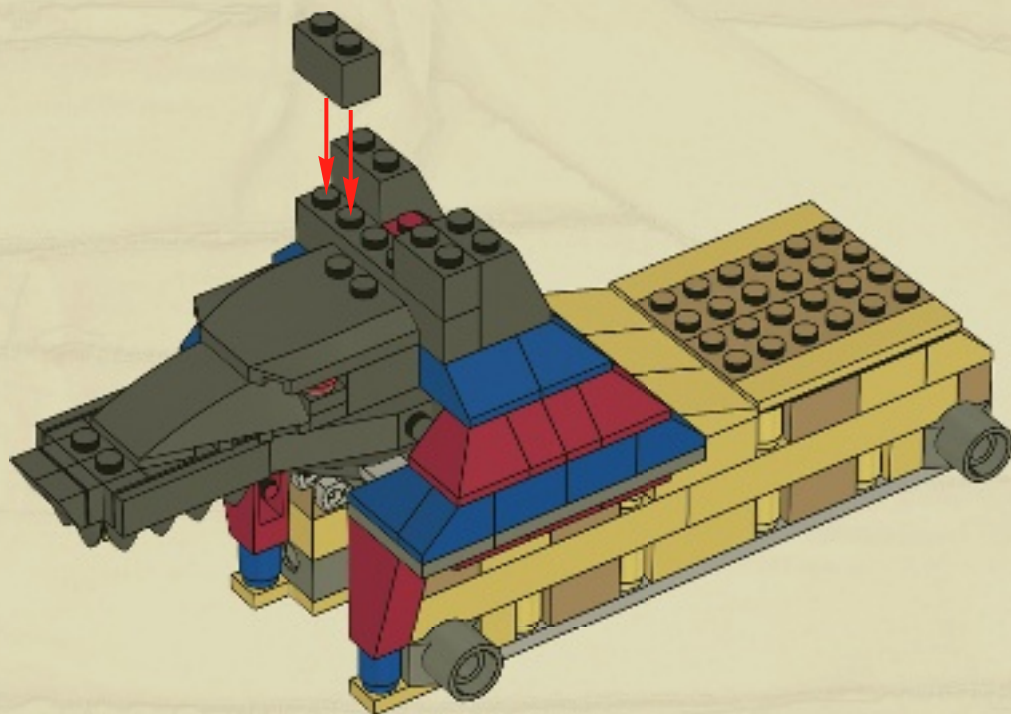



40

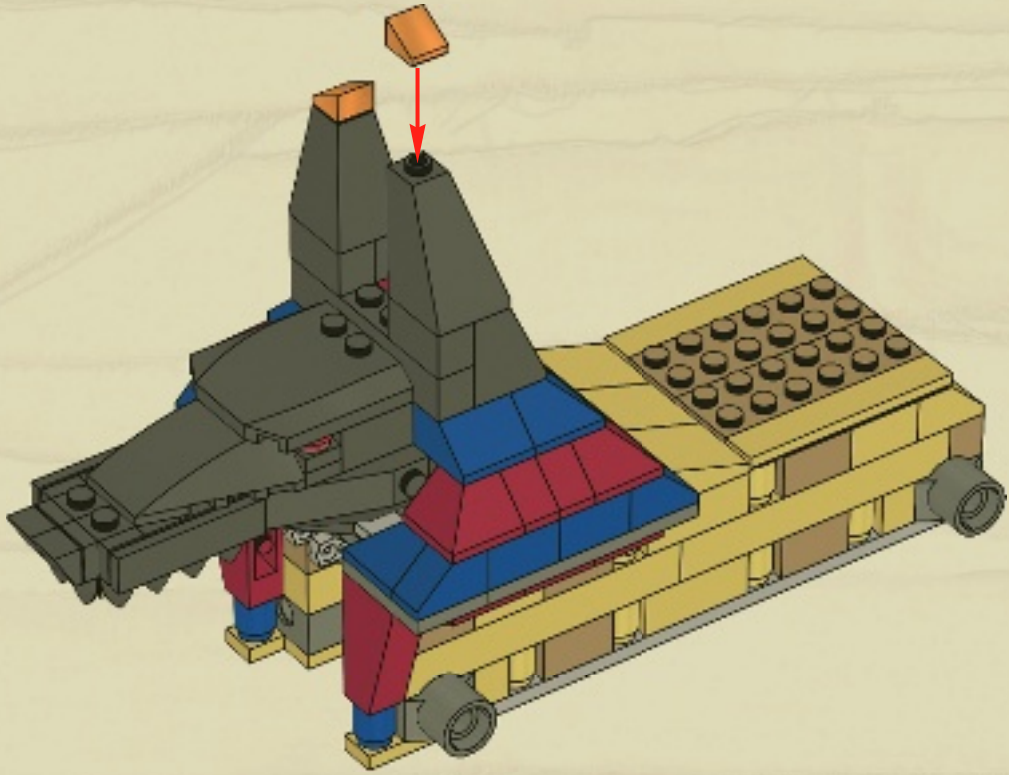

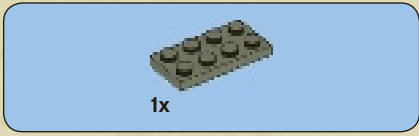

1x

1

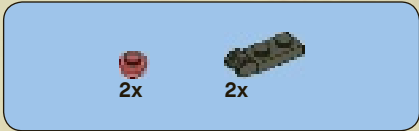

2x

2x

2

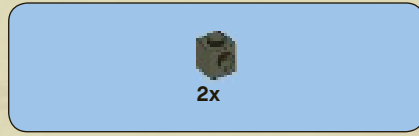

2x

3

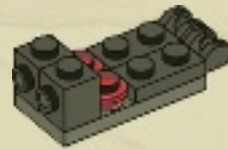

2x

4

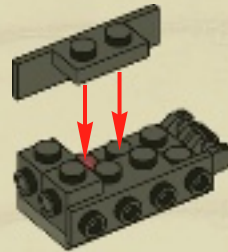



2x



2x

5



1x



1x

6

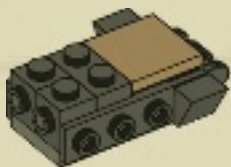

8x

7



2x



1x

8







41

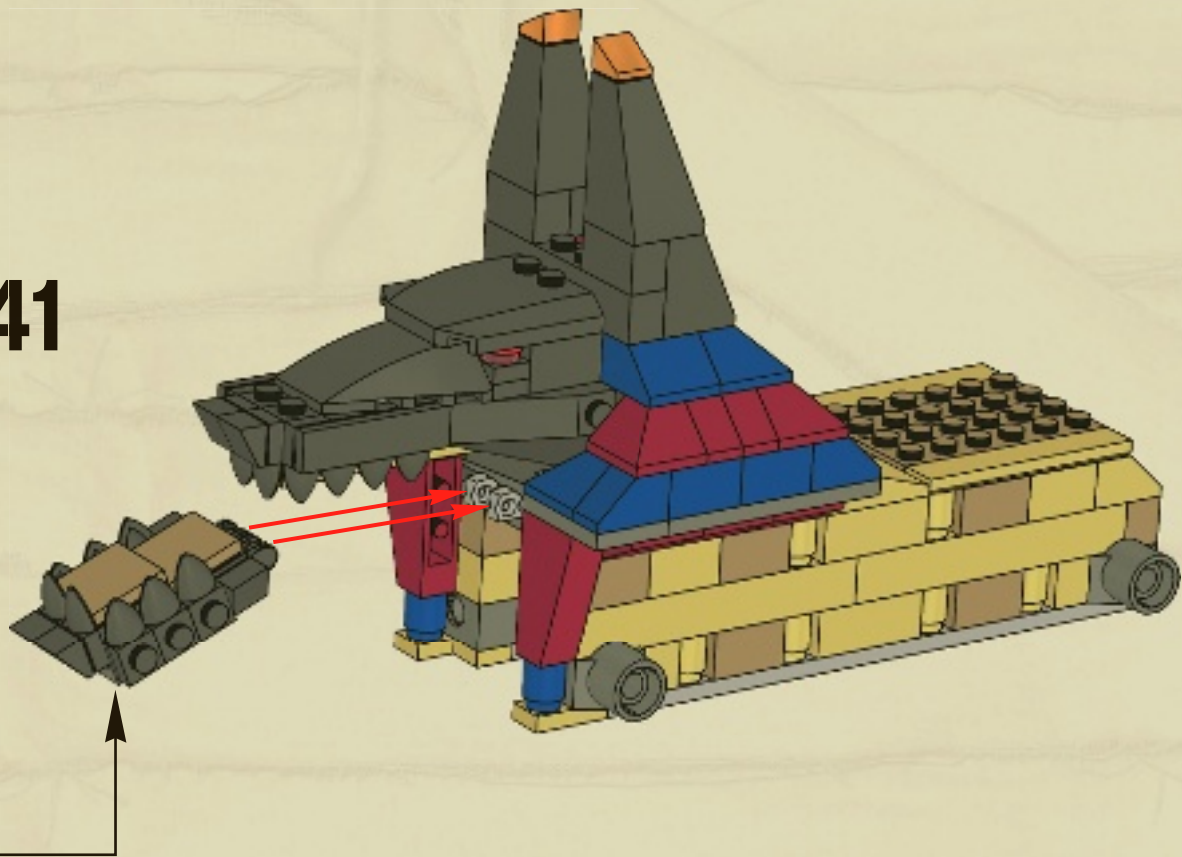

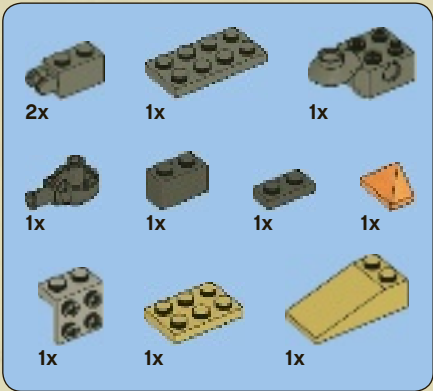

1

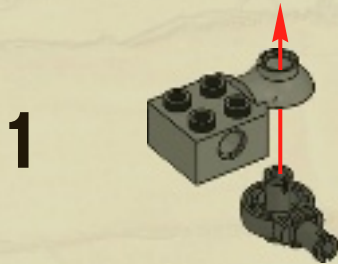

2

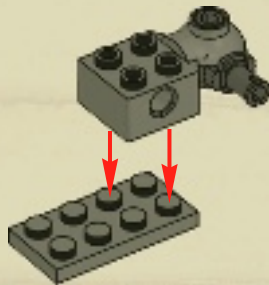

3

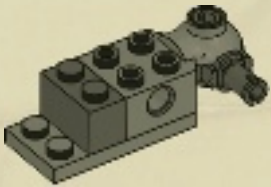

5

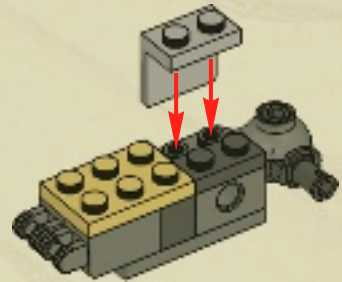

4

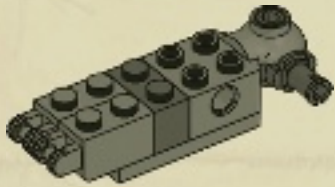

6

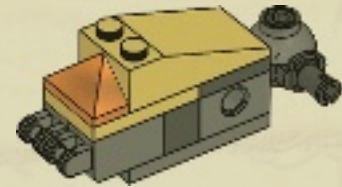

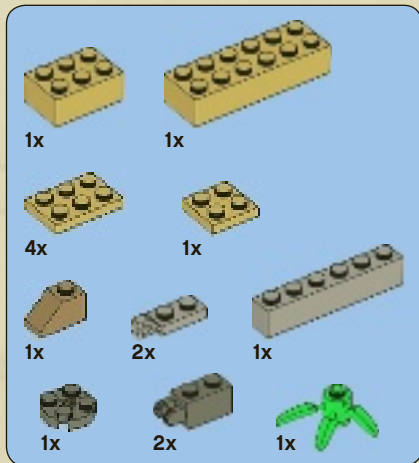

**2**

**1**

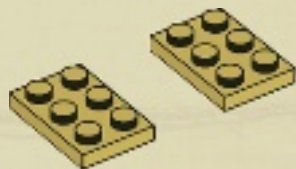

**2**

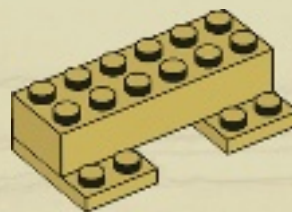

**3**

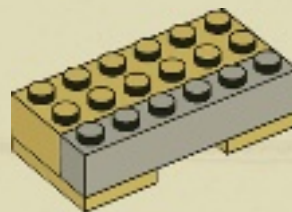

4

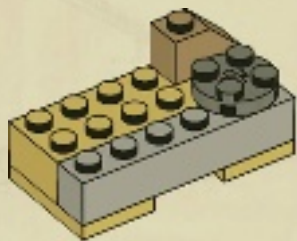

6

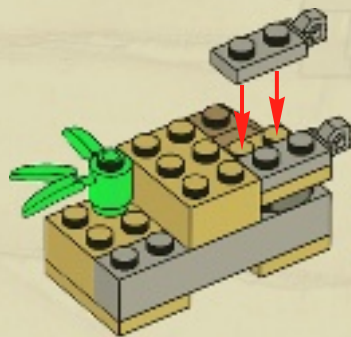

5

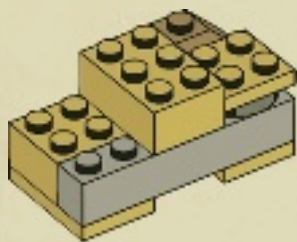

7

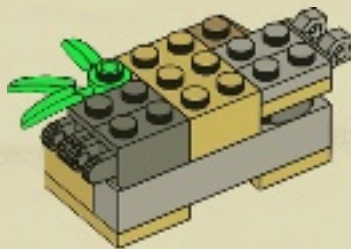

8

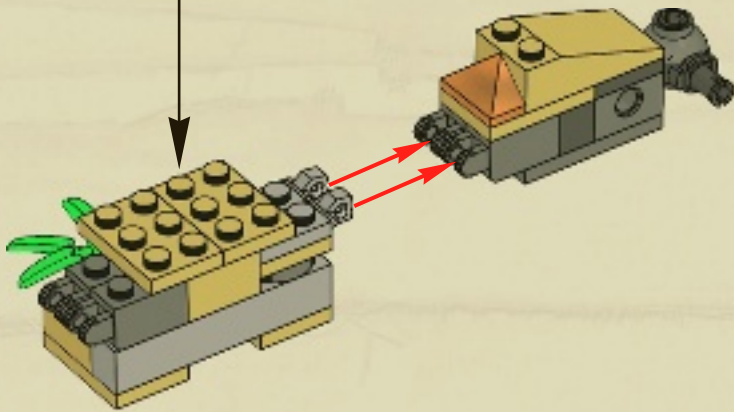
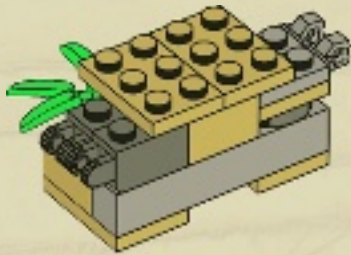

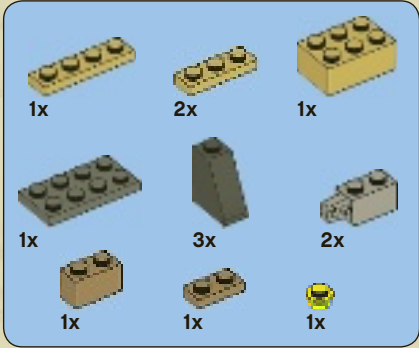

**3**

**1**

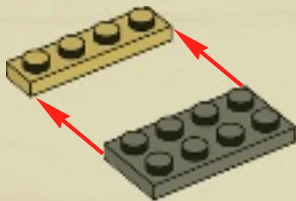

**2**

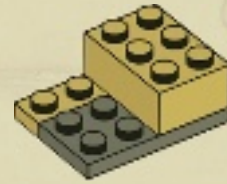

**3**

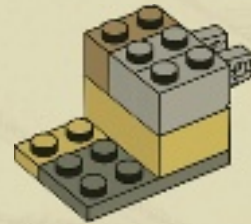

**4**

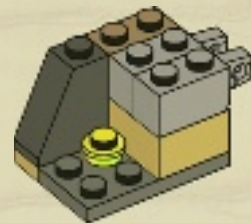

5



6

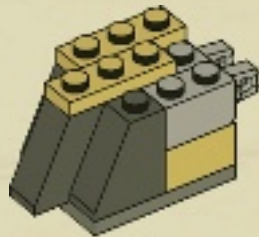

7

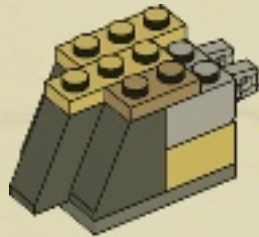



8

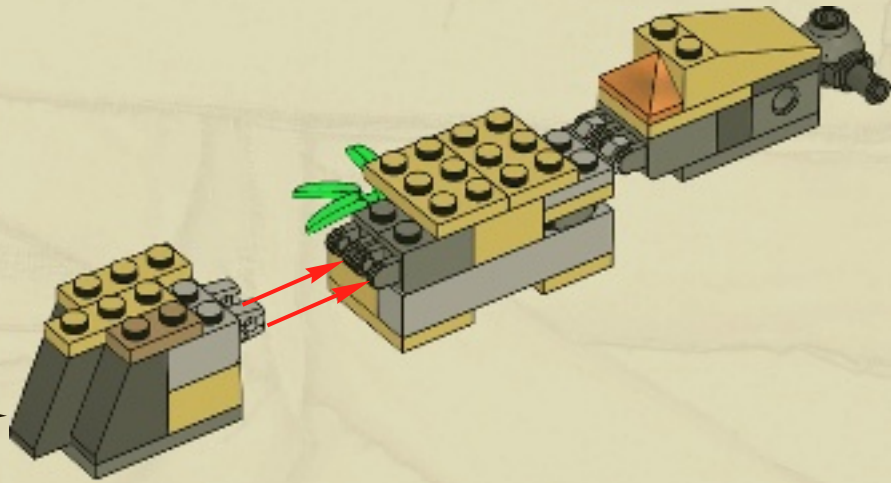

9

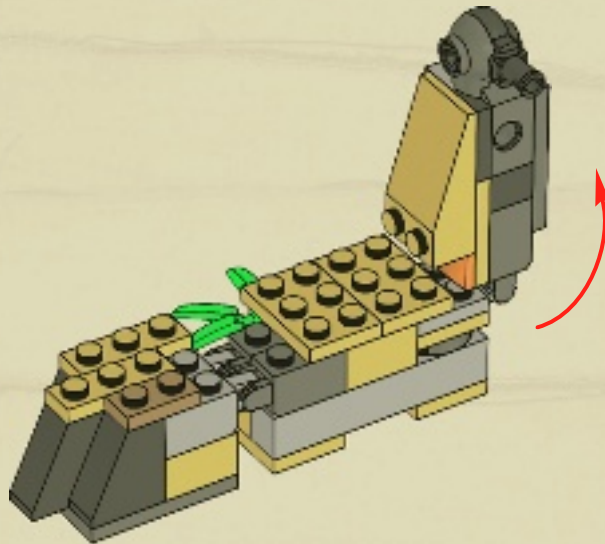

2x

42

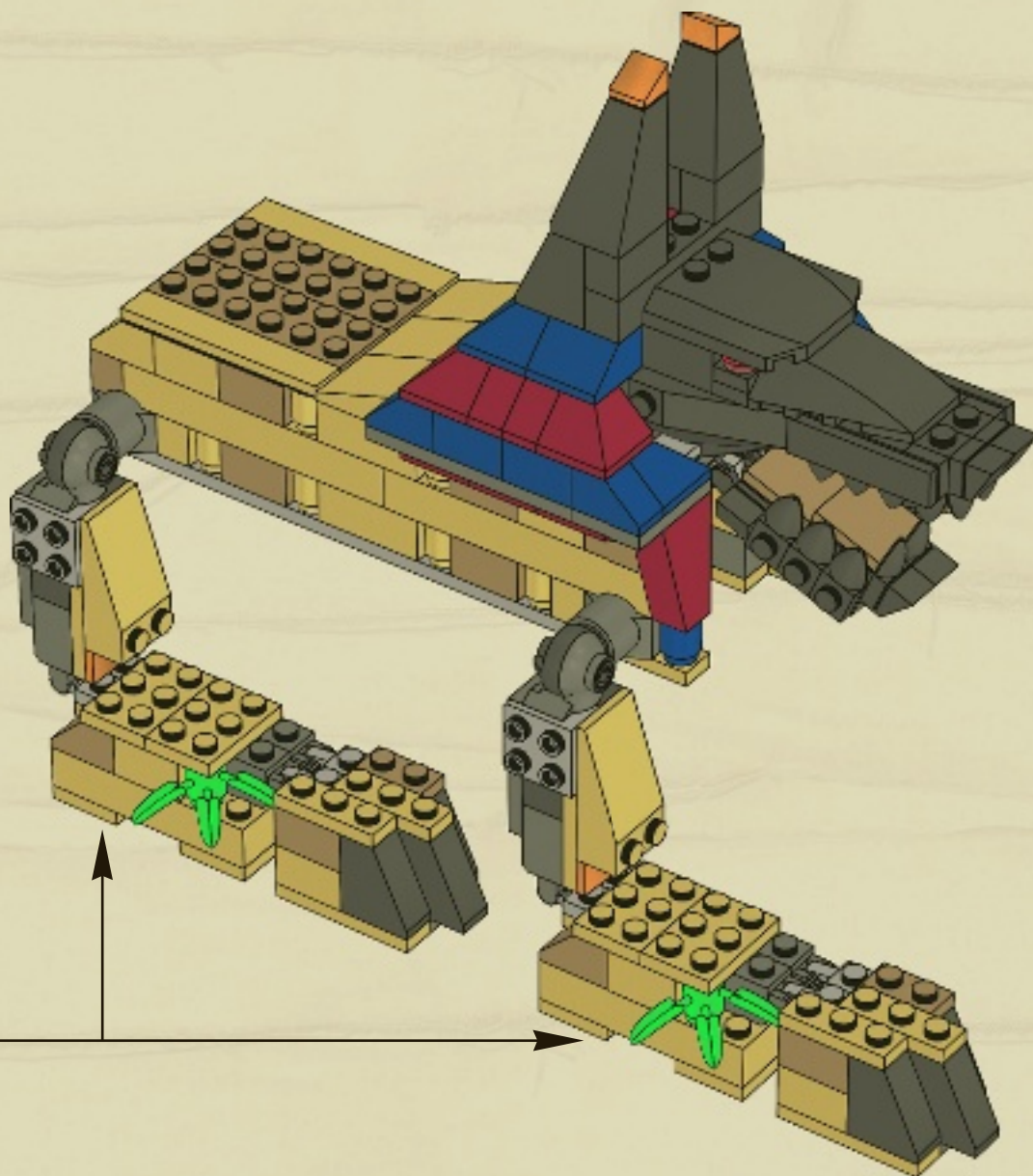

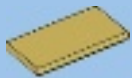

2x

# 43

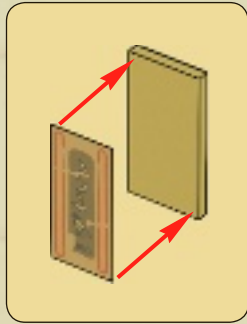
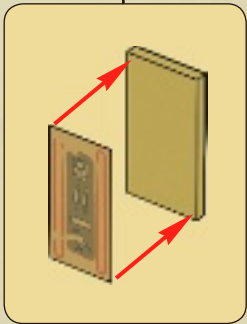
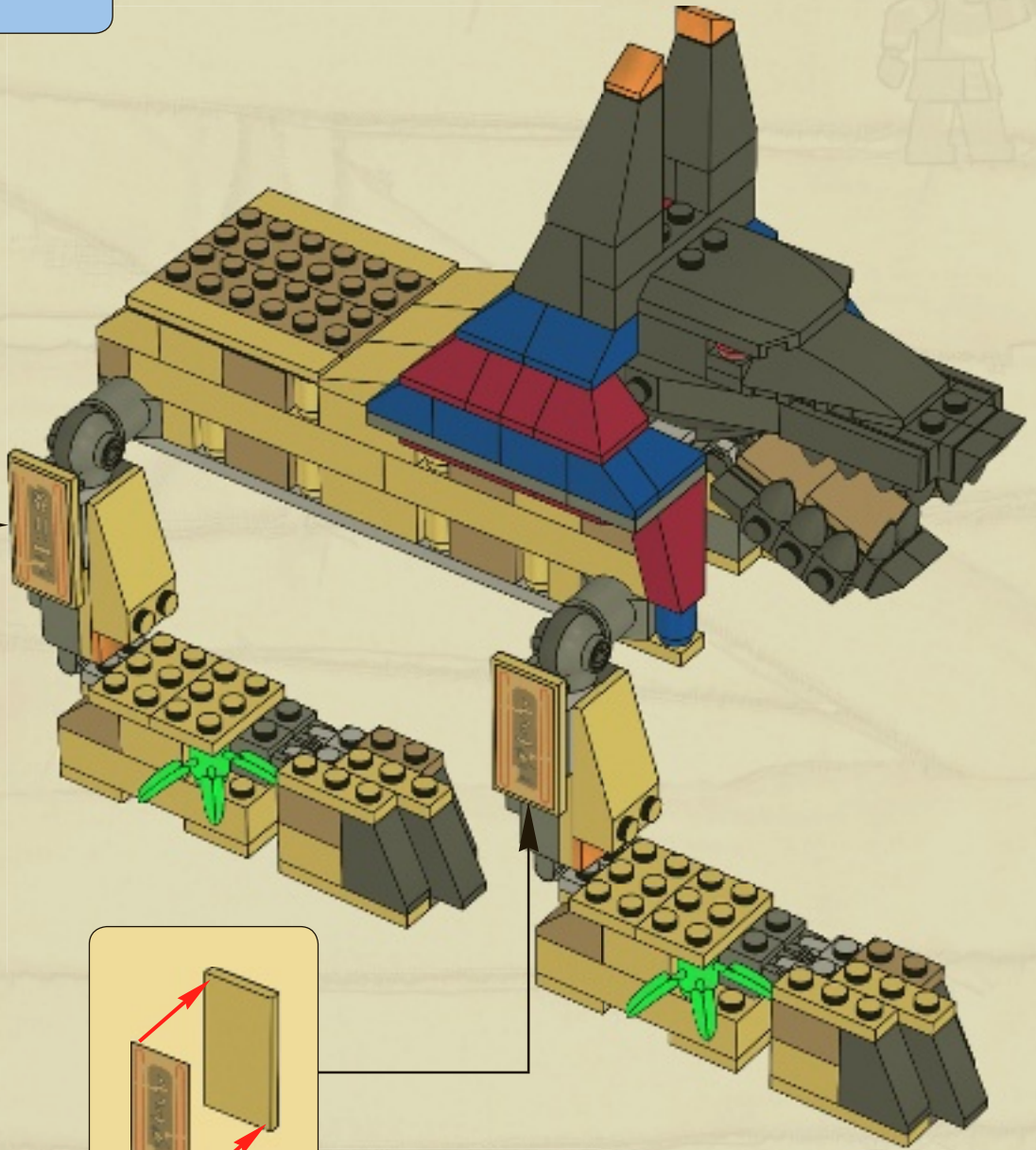

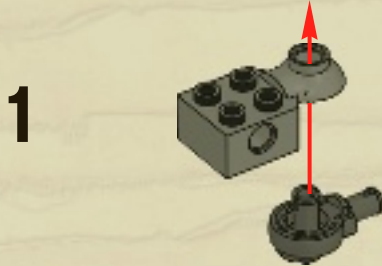
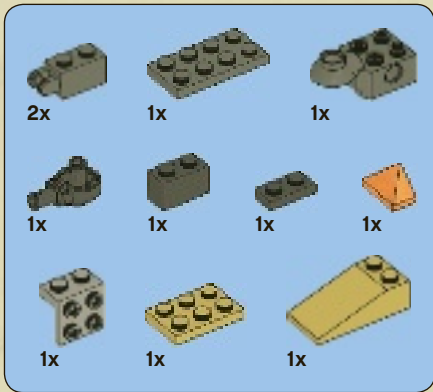
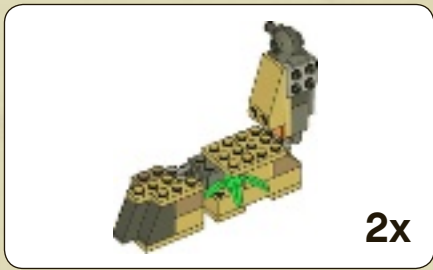

1

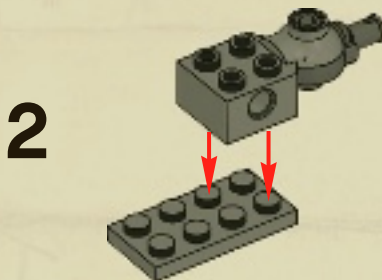

3

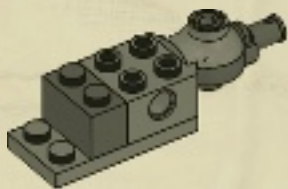

4

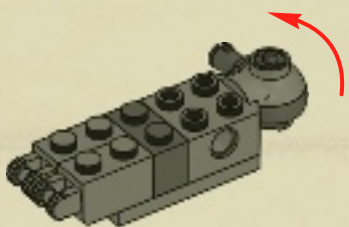

5

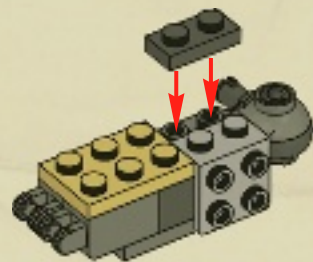

6

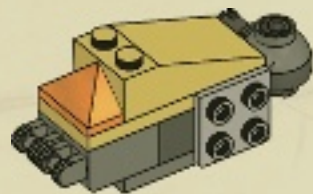

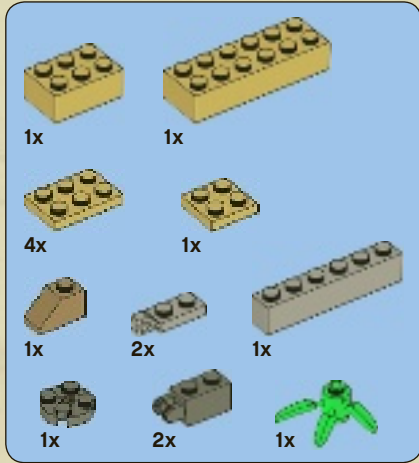

2

1

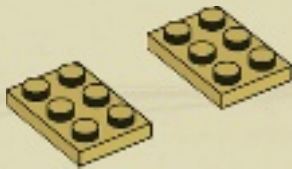

2

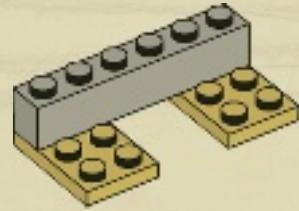

3

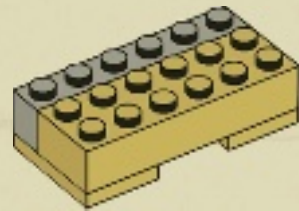

4

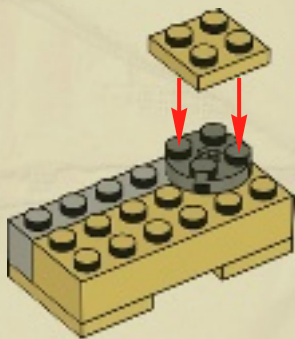

6

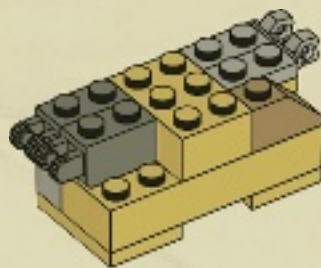

5

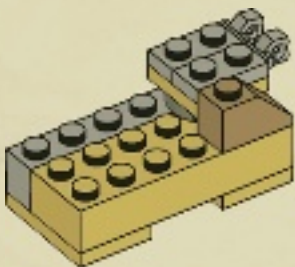

7

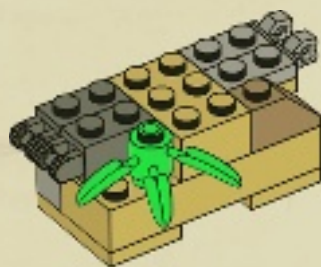

8

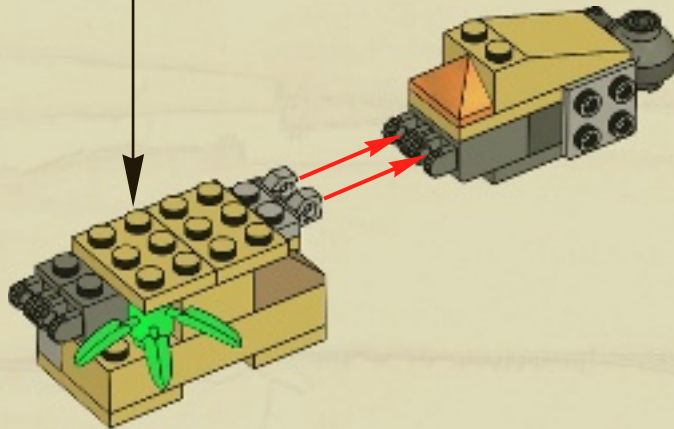
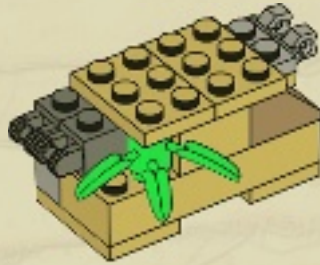



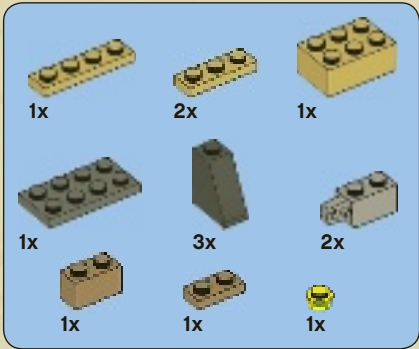

**3**

**1**

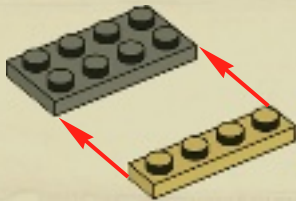

**2**

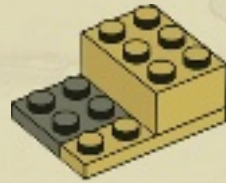

**3**

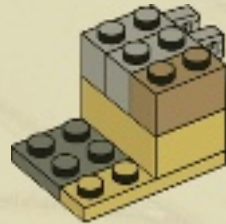

**4**

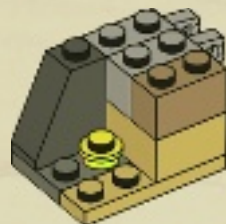

5

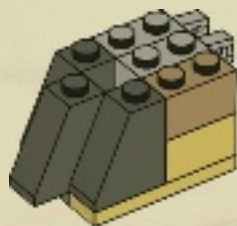

6

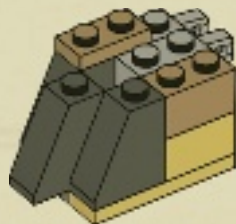

7

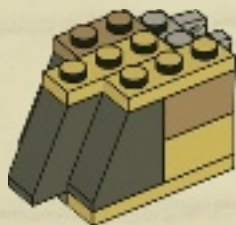

8

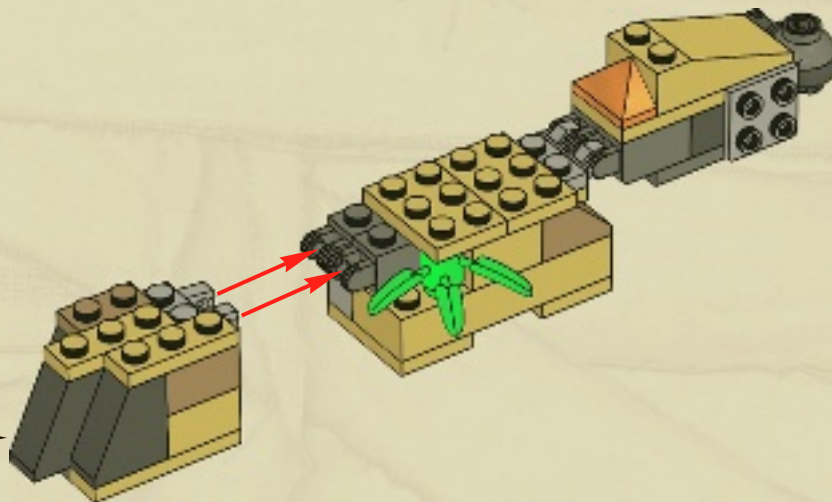

9

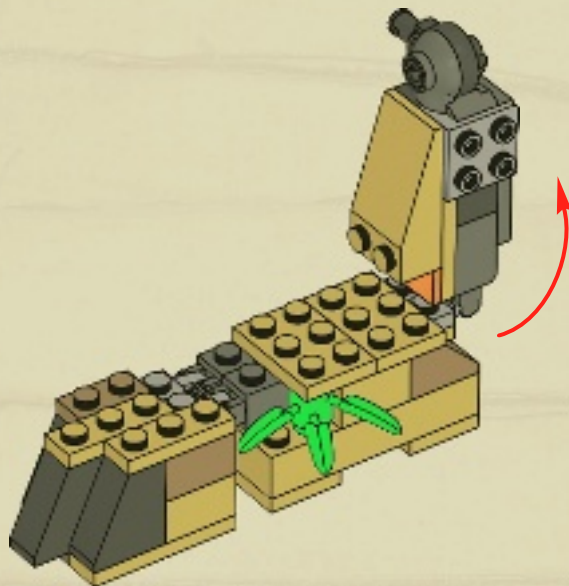

2x

44

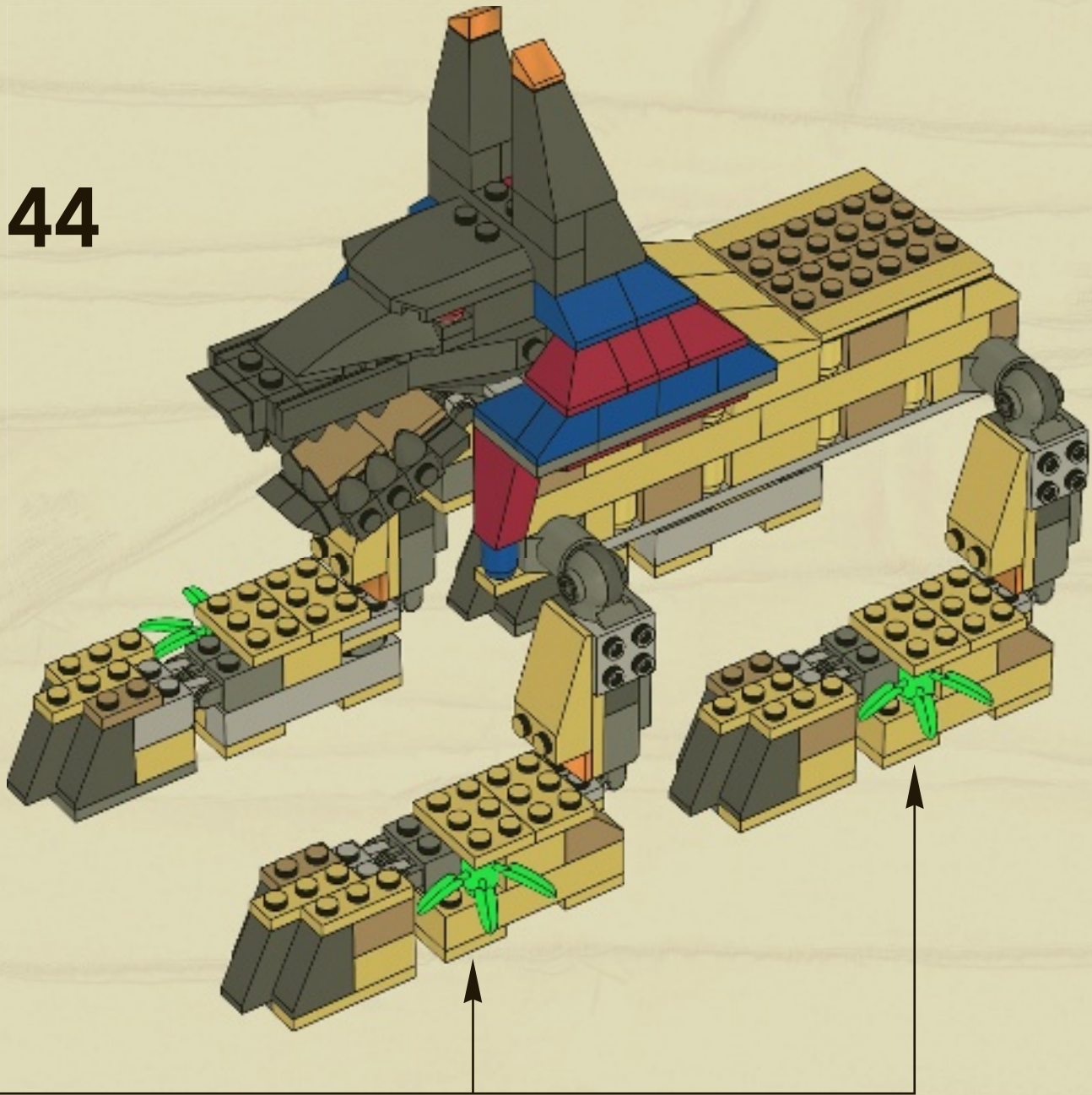

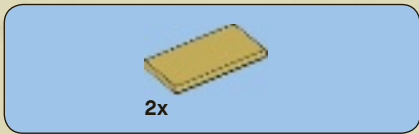

45

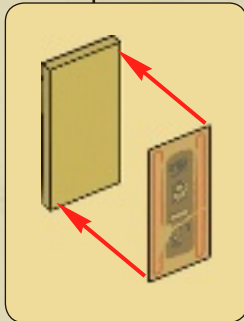
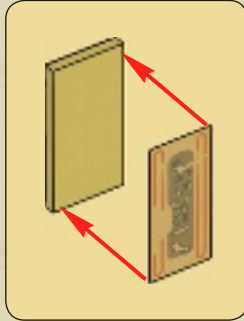
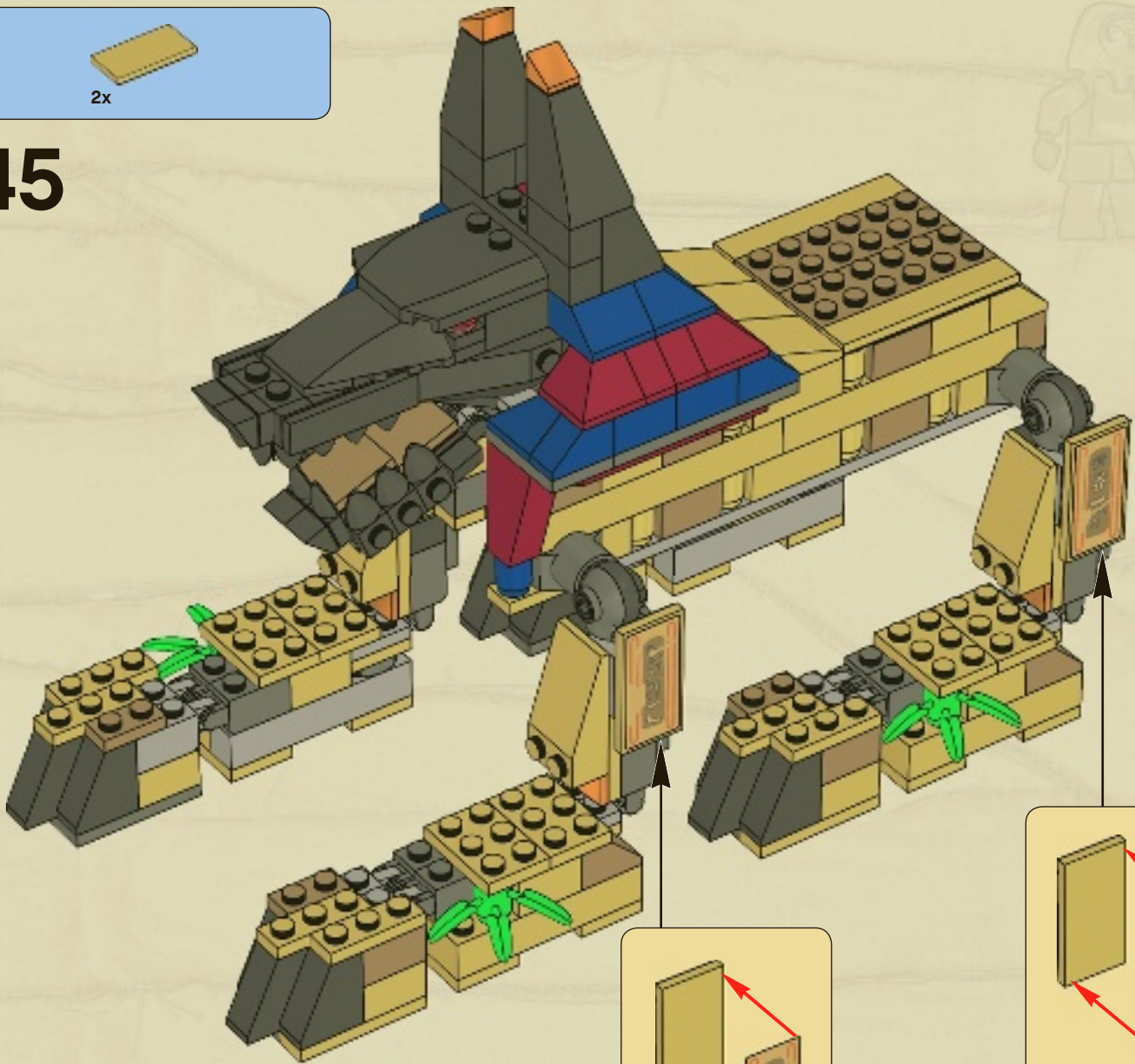

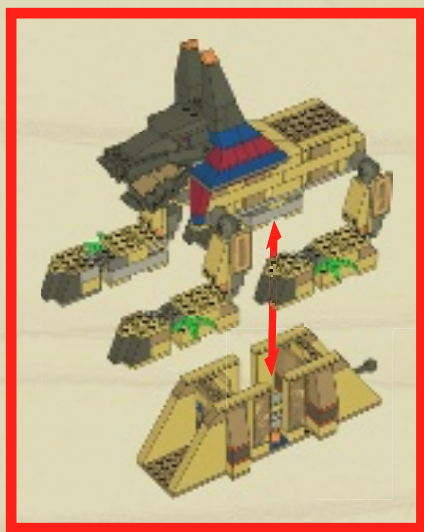

7307



7327



7325



7306



7326



7305





4x  
4114064



14x  
4114306



12x  
4159739



6x  
4109995



1x  
4113916



2x  
4112982



4x  
4181134

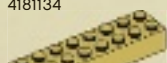

4x  
4141533

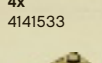

7x  
4530709



5x  
4114322



12x  
4117070



12x  
4117070

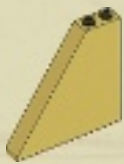

4x  
4243911



2x  
4114077



4x  
4114084



8x  
4121921



4x  
4113233



3x  
4185177



4x  
4610209

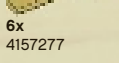

6x  
4157277



4x  
4124460



22x  
4118790



1x  
4113988

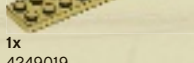

1x  
4249019



6x  
4504382



12x  
4515373



2x  
4273703



2x  
4614804



1x  
374726



1x  
4180423



1x  
4180413



1x  
4219107



2x  
243126



3x  
379426



2x  
4183060



8x  
302326



4x  
371026



2x  
4550017



2x  
4556158



2x  
4282746



1x  
3004626



2x  
459926



1x  
4526110



2x  
4613404



4x  
4541455



1x  
73081



18x  
4273590



1x  
4191191



4x  
4213374



1x  
4290713



6x  
4558954



1x  
4118624



4x  
300326



2x  
300126



7x  
300426



1x  
301026



3x  
300926



1x  
449726



16x  
4521914



2x  
4255416



10x  
4530678



4x  
4613790



2x  
4507045



1x  
4524098



10x  
4528604



5x  
4550329



3x  
4251796



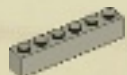

4x  
4211393



8x  
4211693



2x  
4211636



2x  
4211613



2x  
4211440



2x  
4211415



4x  
4558169



2x  
4211369



1x  
4211350



4x  
4277927



10x  
4211803



2x  
4529120



1x  
4494475



2x  
4211486



1x  
4523353



2x  
4595836



4x  
4499259



2x  
4613425



2x  
4613454



2x  
4613494



2x  
301024



1x  
4181143



2x  
4164060



4x  
4141630



4x  
614124



1x  
4613411



1x  
4211007



1x  
4523773



1x  
4499858



2x  
4558955



16x  
4210724



4x  
4225973



4x  
4227395



2x  
4504378



4x  
4211042



3x  
4211043



11x  
4211065



2x  
4211115



1x  
4211067



2x  
4529247



2x  
4587002



4x  
4295174



2x  
4585493



2x  
4557385



1x  
4610763



2x  
4615996



4x  
4196736



3x  
4153653



3x  
4578094



6x  
4186627



4x  
4296785



6x  
4177741



1x  
4613269



8x  
4541526



2x  
4539103



4x  
4600467



6x  
4615998



1x  
4541380



2x  
4539082



4x  
4629912



2x  
4613761



2x  
4549992



1x  
4538780



2x  
302321



8x  
4615606



1x  
4613755



1x  
4610904



2x  
3005740



1x  
4113106



10x  
3005741



4x  
4114348

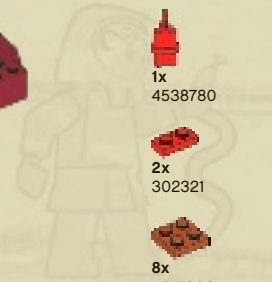

**Customer Service**  
**Kundenservice**  
**Service Consommateurs**  
**Servicio Al Consumidor**

[www.lego.com/service](http://www.lego.com/service) or dial



: 00800 5346 5555

: 1-800-422-5346

# LEGO® Glyphs

 A	 B	 C	 D	 E	
 F	 G	 H	 I	 J	 K
 L	 M	 N	 O	 P	
 Q	 R	 S	 T	 U	
 V	 W	 X	 Y	 Z	



Solve the code above and enter [pharaohsquest.LEGO.com](http://pharaohsquest.LEGO.com)  
 Déchiffre le code ci-dessus et viens sur [pharaohsquest.LEGO.com](http://pharaohsquest.LEGO.com)  
 Entschlüssel den Code und gib das Lösungswort auf [PharaohsQuest.LEGO.de](http://PharaohsQuest.LEGO.de) ein.  
 Déchiffre le code ci-dessus et entre dans [pharaohsquest.LEGO.com](http://pharaohsquest.LEGO.com)  
 Resuelve el jeroglífico y visita [pharaohsquest.LEGO.com](http://pharaohsquest.LEGO.com)  
 Decifra o código acima e entra em [pharaohsquest.LEGO.com](http://pharaohsquest.LEGO.com)  
 Fejtsd meg a fenti kódot, és lépj be a [pharaohsquest.LEGO.com](http://pharaohsquest.LEGO.com) oldalra.



# pharaohsquest.LEGO.com



[www.LEGOclub.com](http://www.LEGOclub.com)



LEGO® Club Email

**LEGO club™**

**FREE! GRATIS! GRATUIT!**



LEGO® Club Magazine

**SIGN UP ONLINE!**

**[www.LEGOclub.com](http://www.LEGOclub.com)**



**00800 5346 5555\***



**1-866-534-6258 • 1-877-518-5346**

US & Canada only

Canada seulement

- \* Freephone. Mobile charges may apply.
- \* Numéro sans frais. Des frais peuvent s'appliquer avec les téléphones cellulaires.
- \* Gebührenfrei, Kosten für Anrufe aus Mobilfunknetzen können abweichen.
- \* Gratis telefonnummer vanaf vaste lijn.
- \* Det er et gratis nummer, når du ringer fra fasttelefon.
- \* Det är gratis, när du ringer från en fast telefon.
- \* Numéro sans frais. Des frais peuvent s'appliquer avec les téléphones portables.



# WIN!

Go to [www.LEGOsurvey.com/product](http://www.LEGOsurvey.com/product) to fill out a survey for a chance to win a cool LEGO® Product.

No purchase necessary.

Open to all residents where not prohibited.



[www.LEGO.com](http://www.LEGO.com)



## [www.LEGOsurvey.com/product](http://www.LEGOsurvey.com/product)

### GEWINNE! WIN!

Nimm an der Umfrage auf [www.LEGOsurvey.com/product](http://www.LEGOsurvey.com/product) teil und hab die Chance ein cooles LEGO® Produkt zu gewinnen!

Die Teilnahme am Gewinnspiel führt zu keinerlei Kaufverpflichtungen. Teilnahme in allen nicht ausgeschlossenen Ländern möglich.

Ga naar [www.LEGOsurvey.com/product](http://www.LEGOsurvey.com/product), vul een enquêteformulier in en maak kans op een cool LEGO® product.

Geen aankoopverplichting. Iedereen mag deelnemen, uitgezonderd ingezetenden van landen waar een enquêteverbod geldt.

### GAGNE! 当てよう!

Visite [www.LEGOsurvey.com/product](http://www.LEGOsurvey.com/product) pour répondre à un questionnaire et avoir une chance de gagner un produit LEGO® très cool!

Aucune obligation d'achat. Ouvert à tous les résidents des pays autorisés.

[www.LEGOsurvey.com/product](http://www.LEGOsurvey.com/product) にアクセスして、アンケートにご記入ください。当選者にはレゴ®製品を差し上げます。

お買い上げの必要はありません。

禁止されていない限り、すべての皆様にご利用いただけます。