

7471

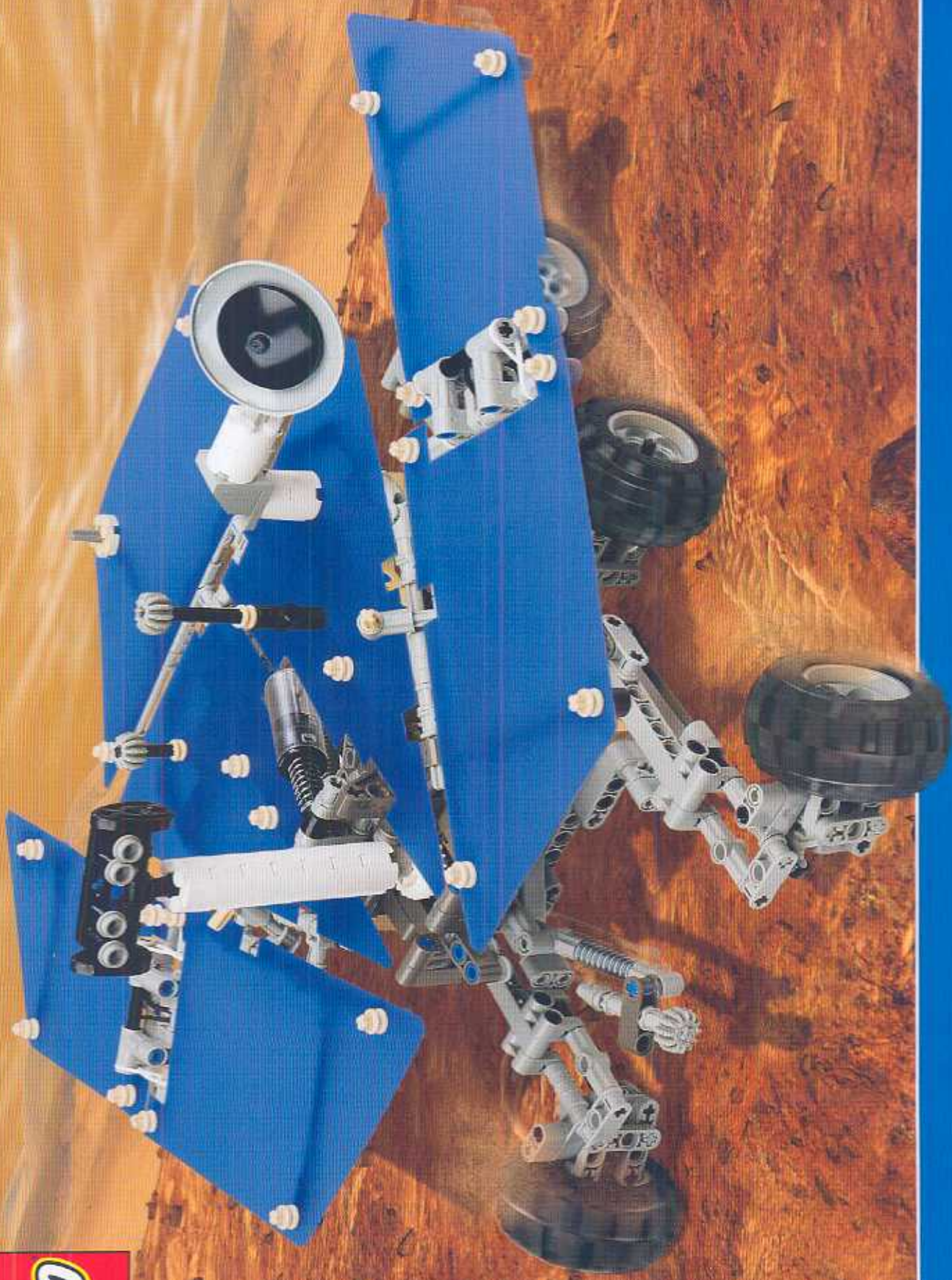

4210576

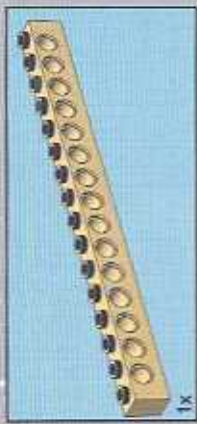

2

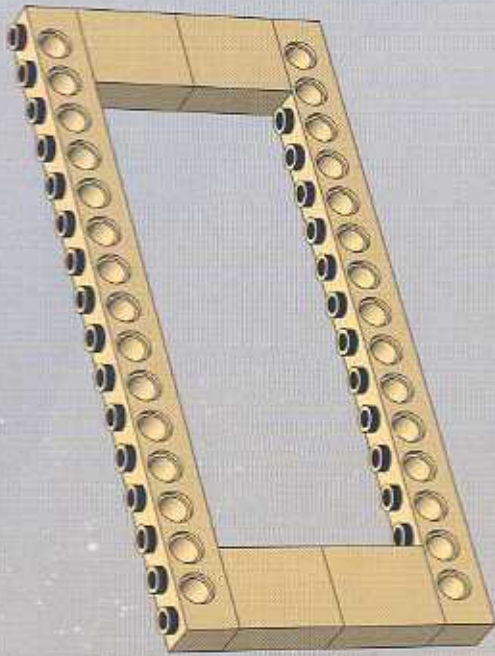

4113884

4121715

655826

4125313

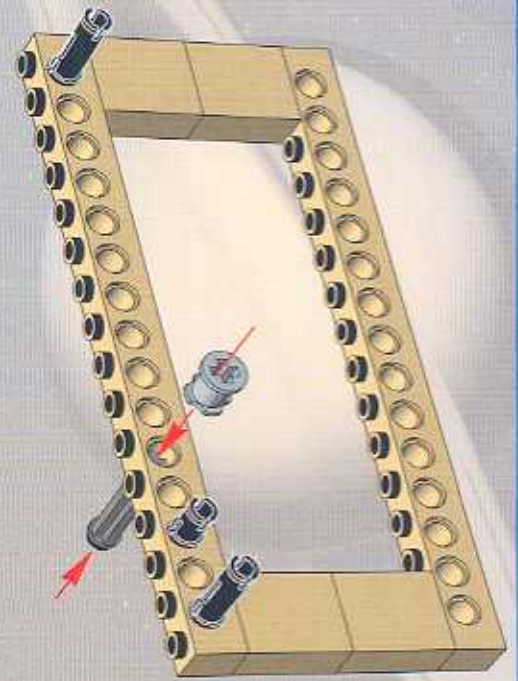

3

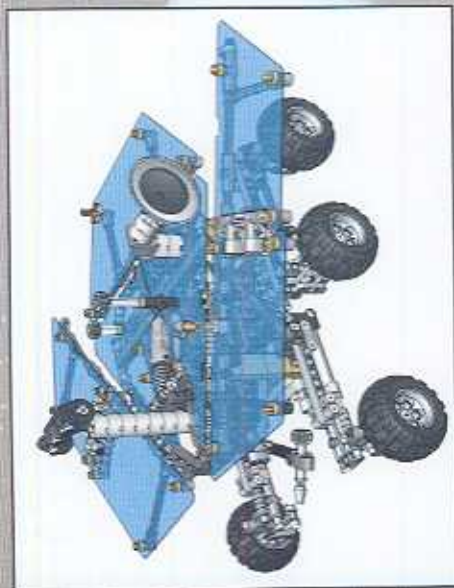

4206923

4159279

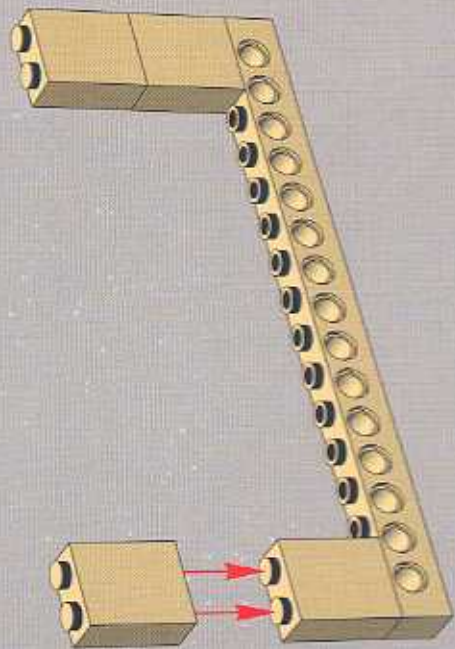

4154760



4

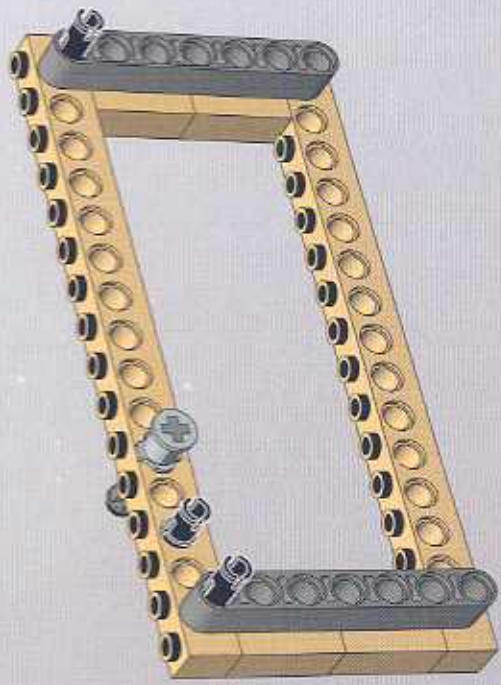

4124443



370626

5

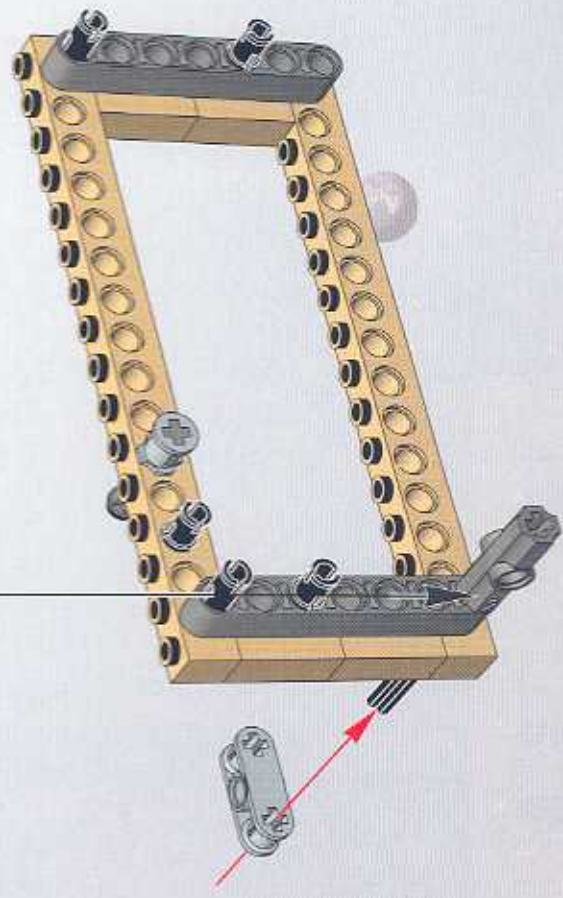
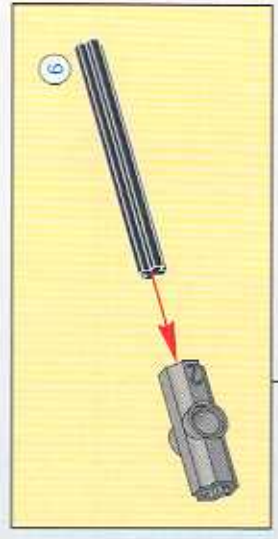

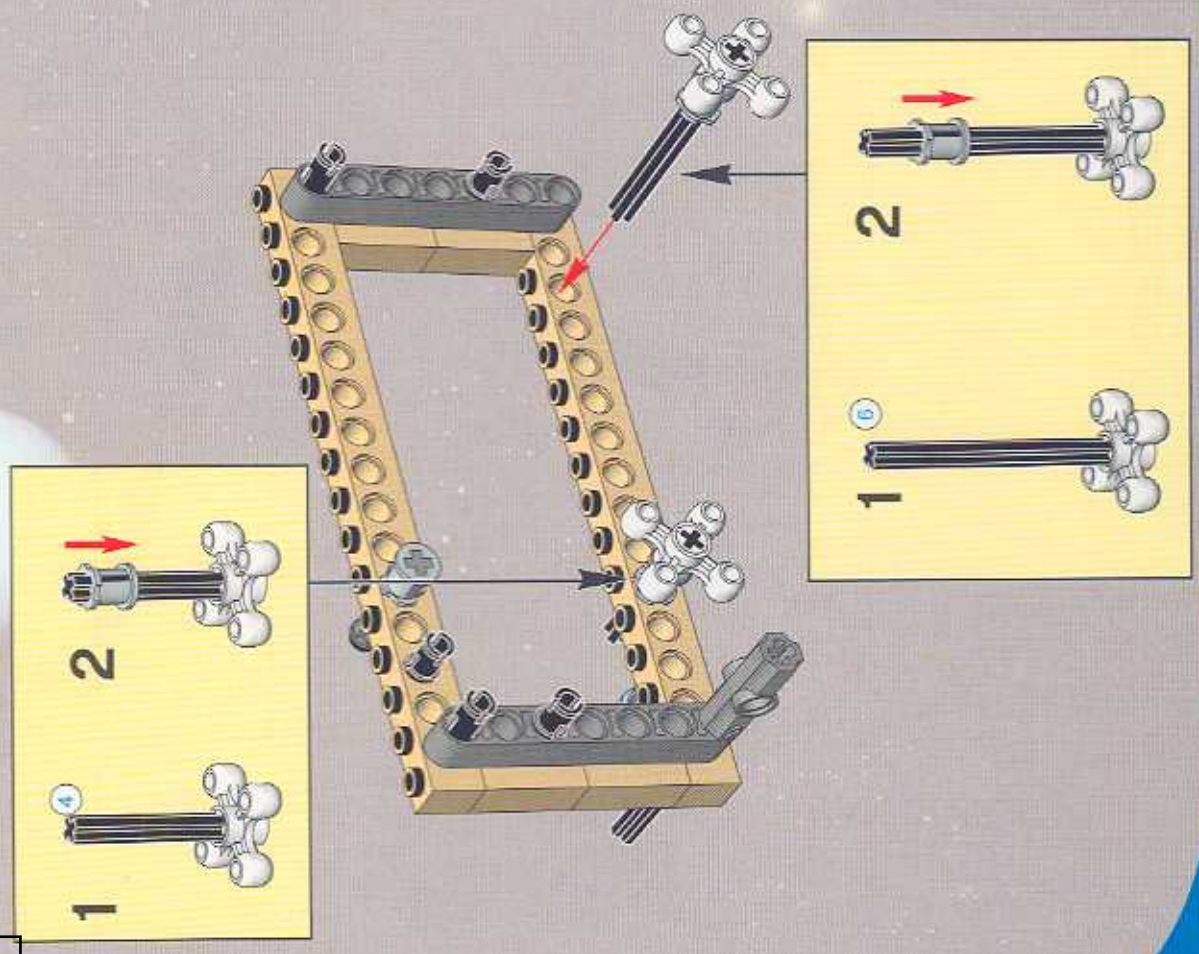
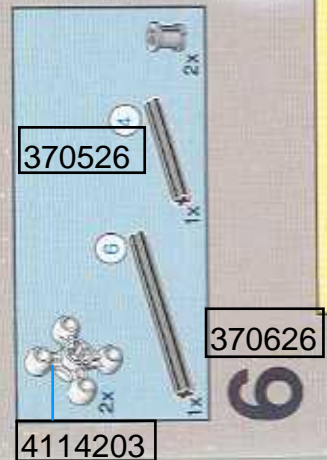
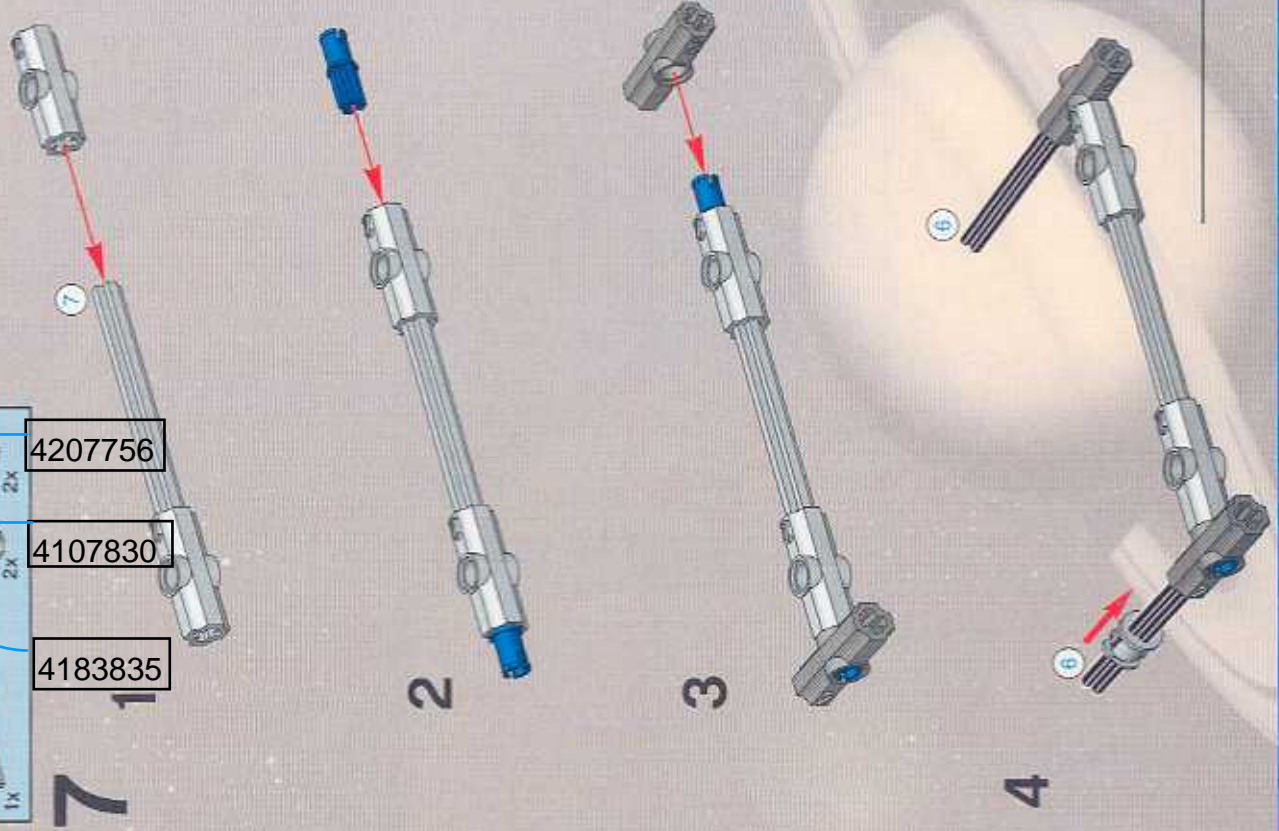
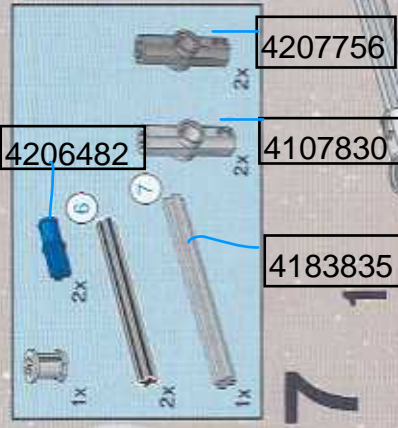

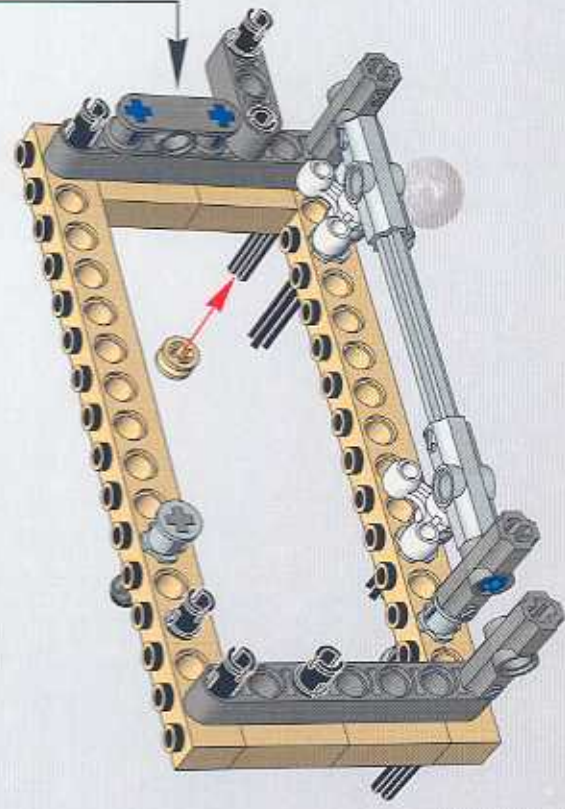
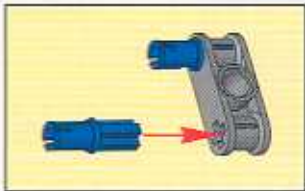

- 1x
- 2x
- 1x
- 4124443
- 1x
- 4154759
- 1x
- 1x
- 4206210
-

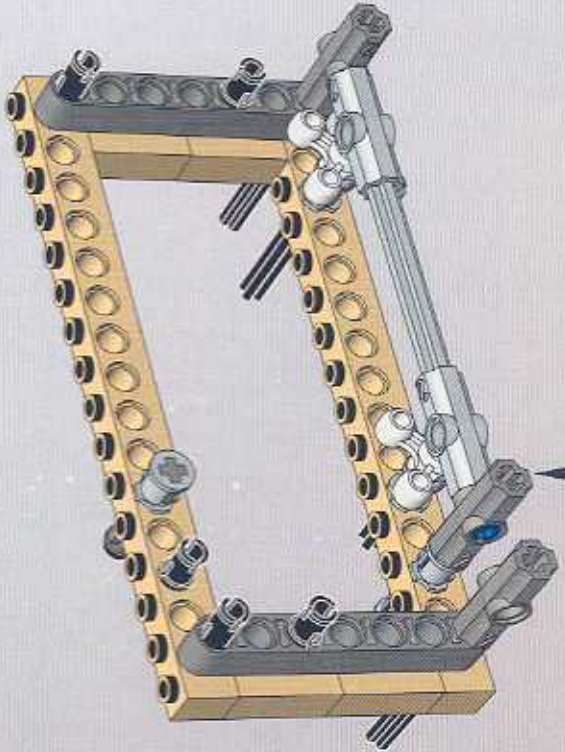

-
-
-
- 1:1



9

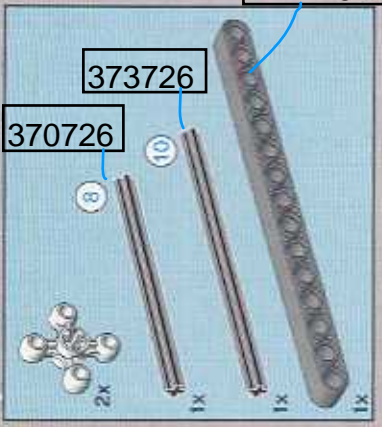
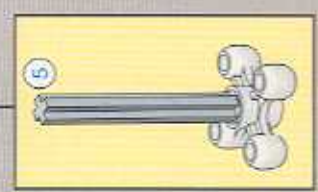
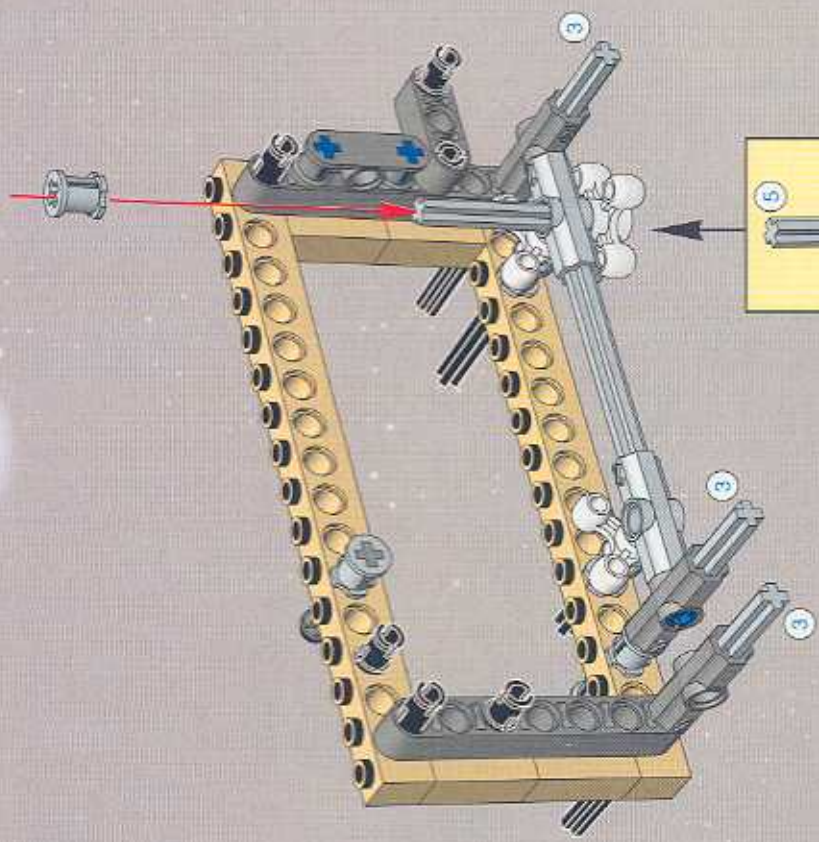

10

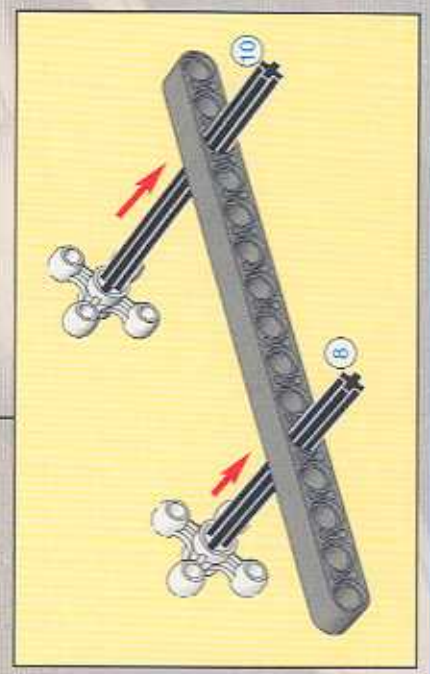
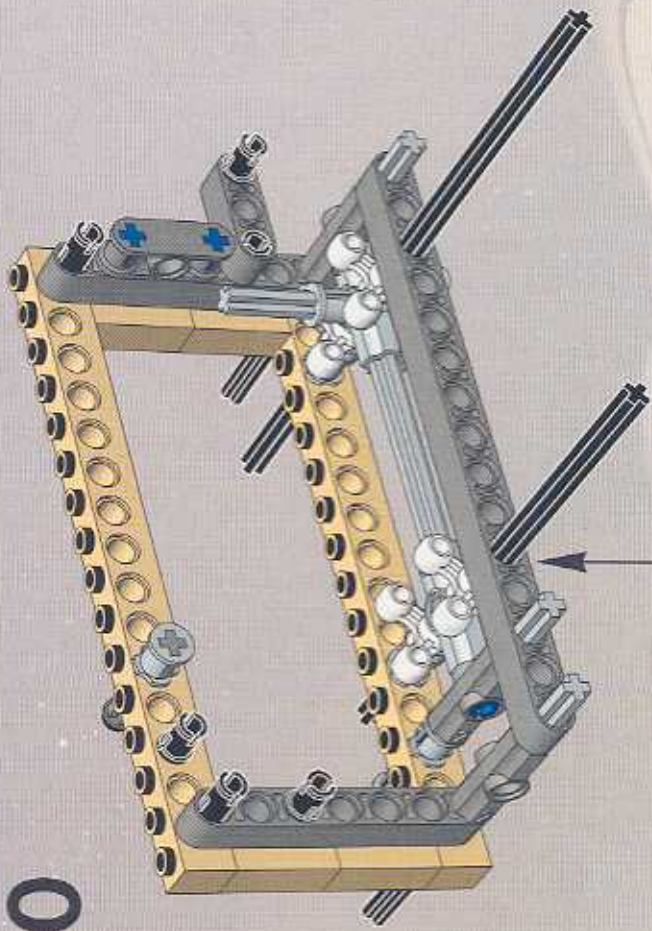



11

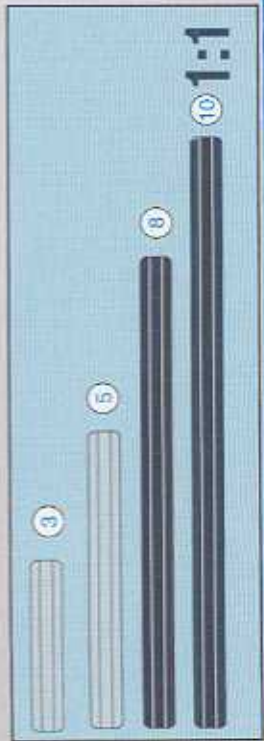
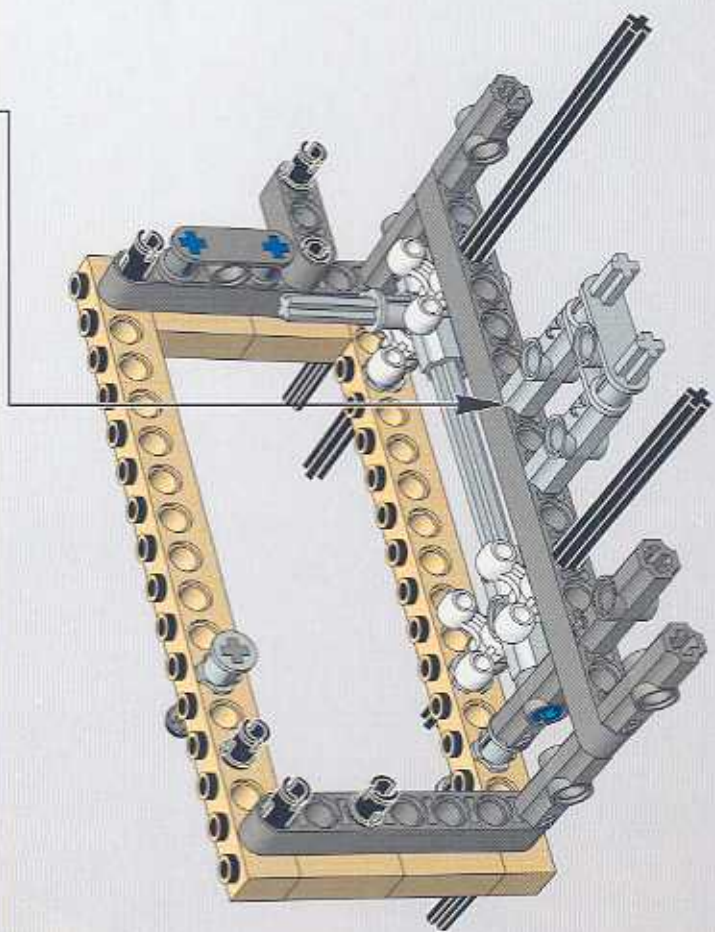
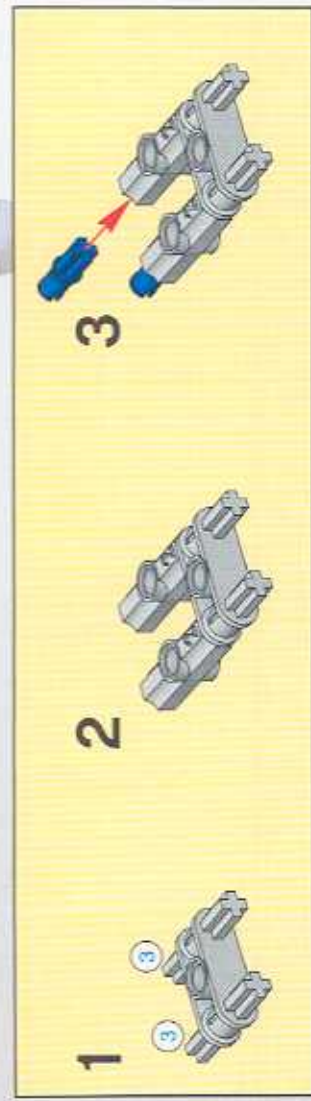

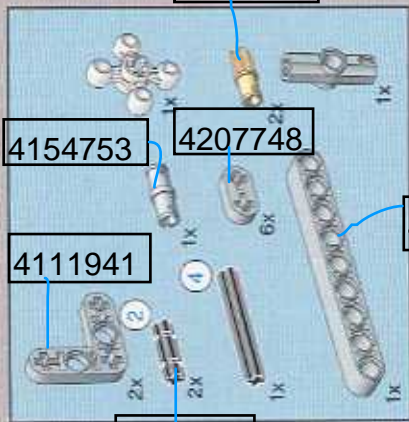

12

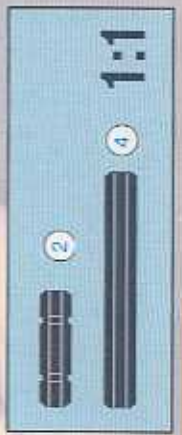
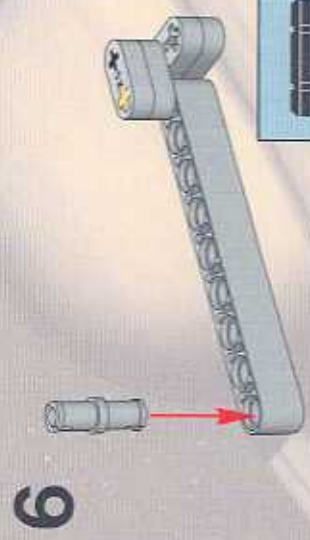
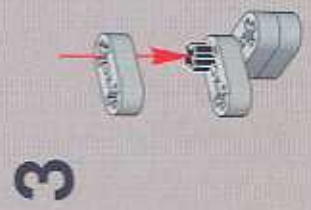

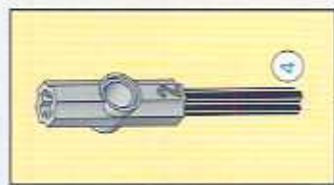

8

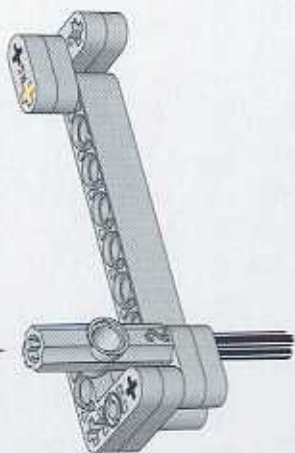

9

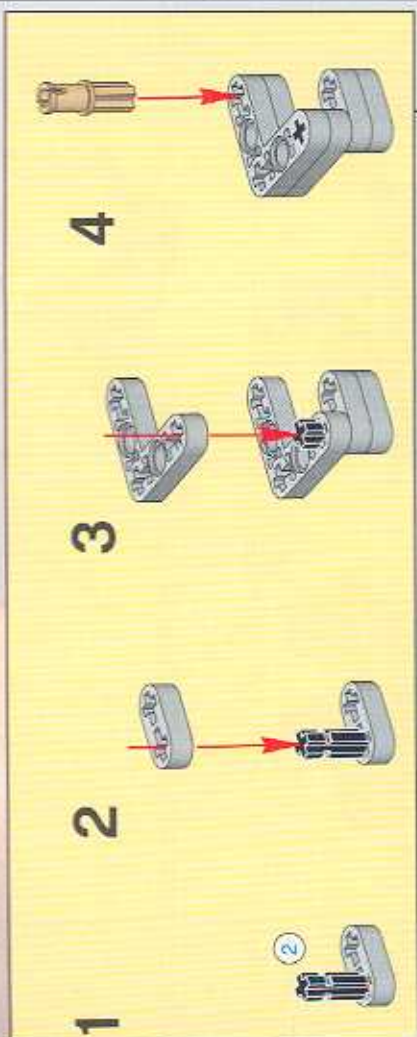
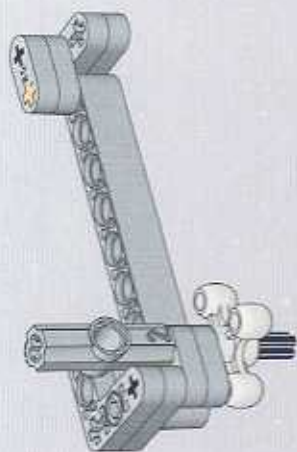

7

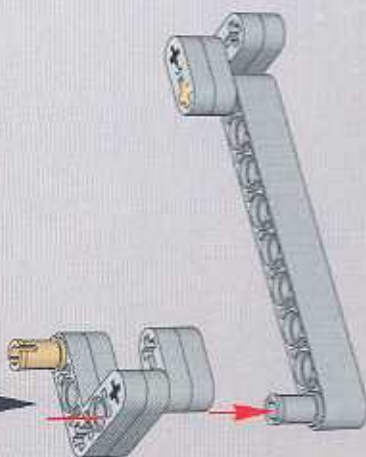



13

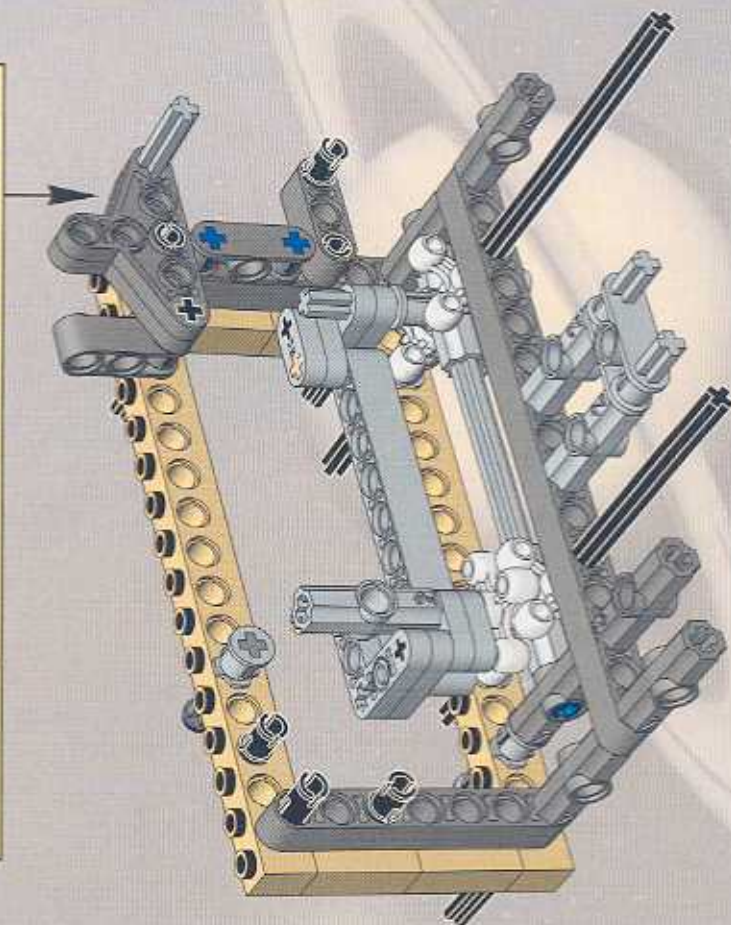
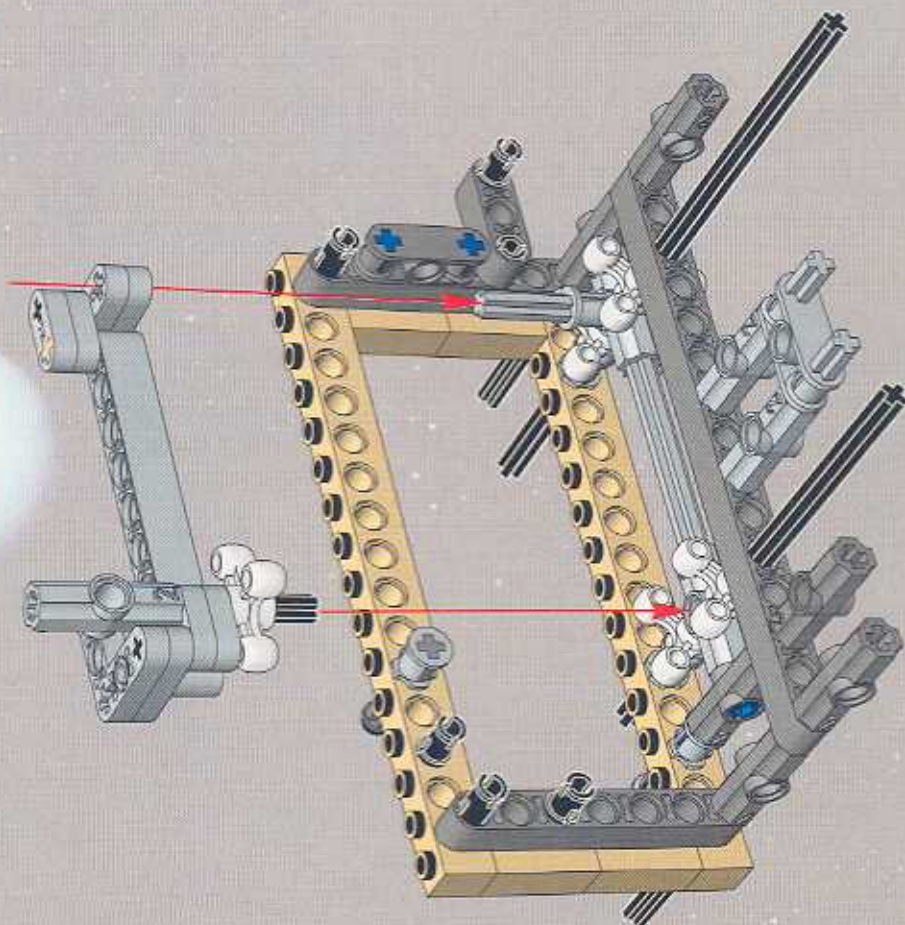
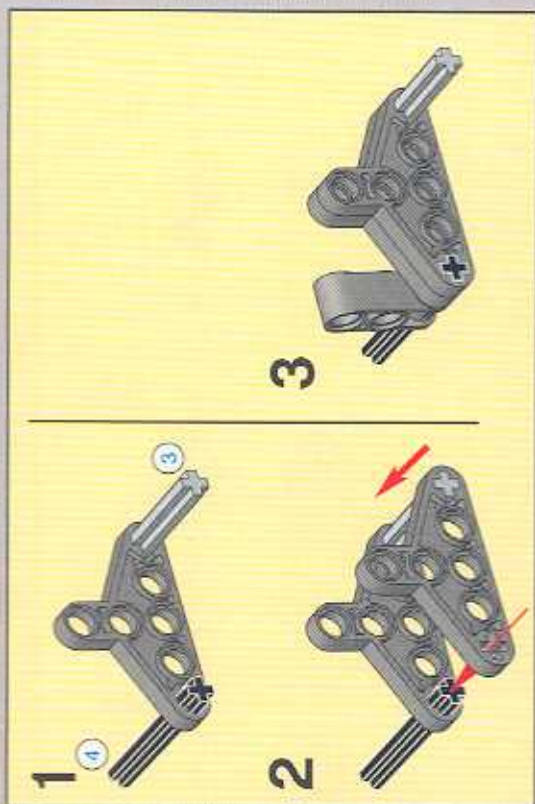

- 4205111 1x
- 4124045 1x
- 9244 1x

15

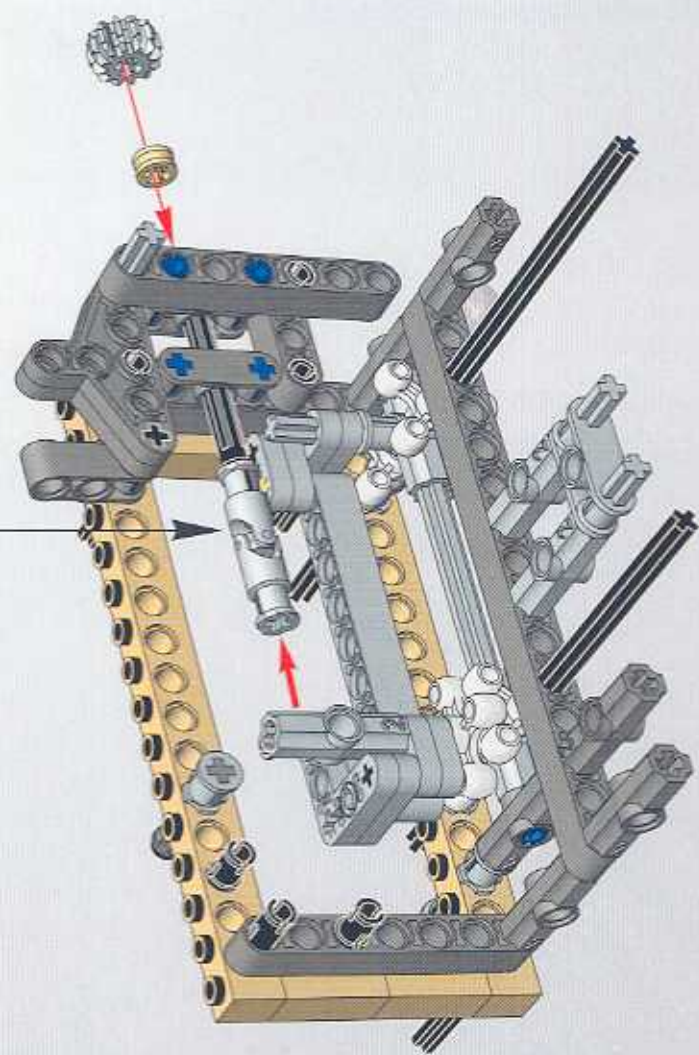
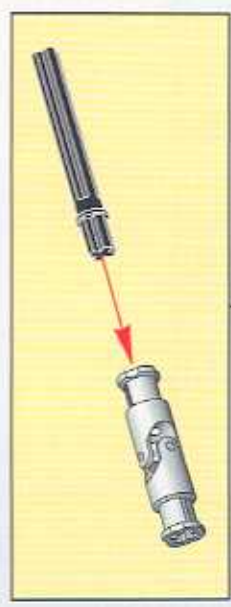

- 4154760 1x
- 2x
- 1x

4154760

14

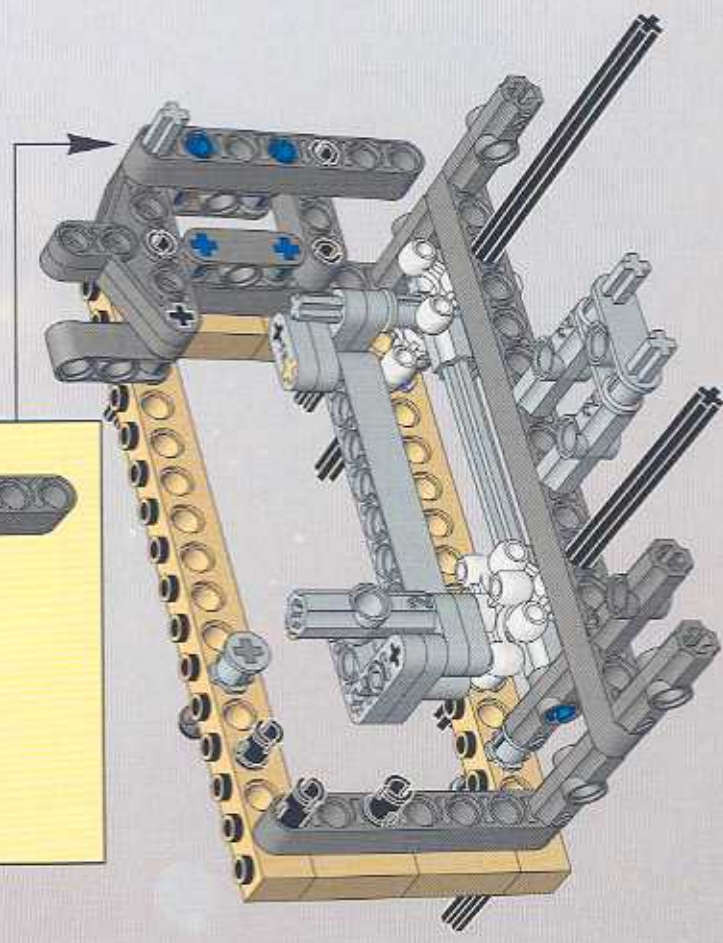
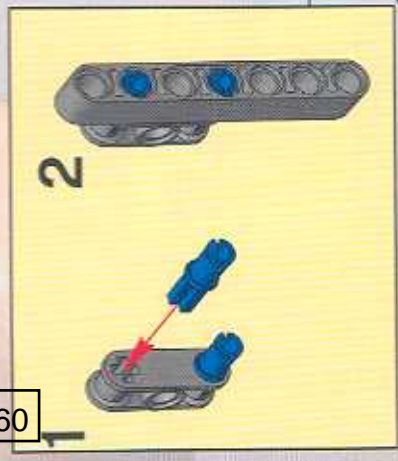

9 4 1:1

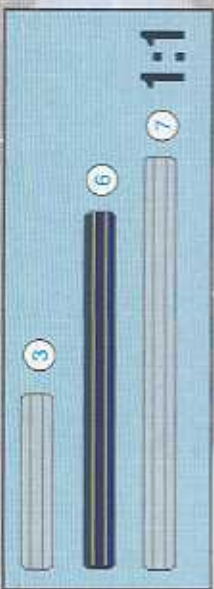

16

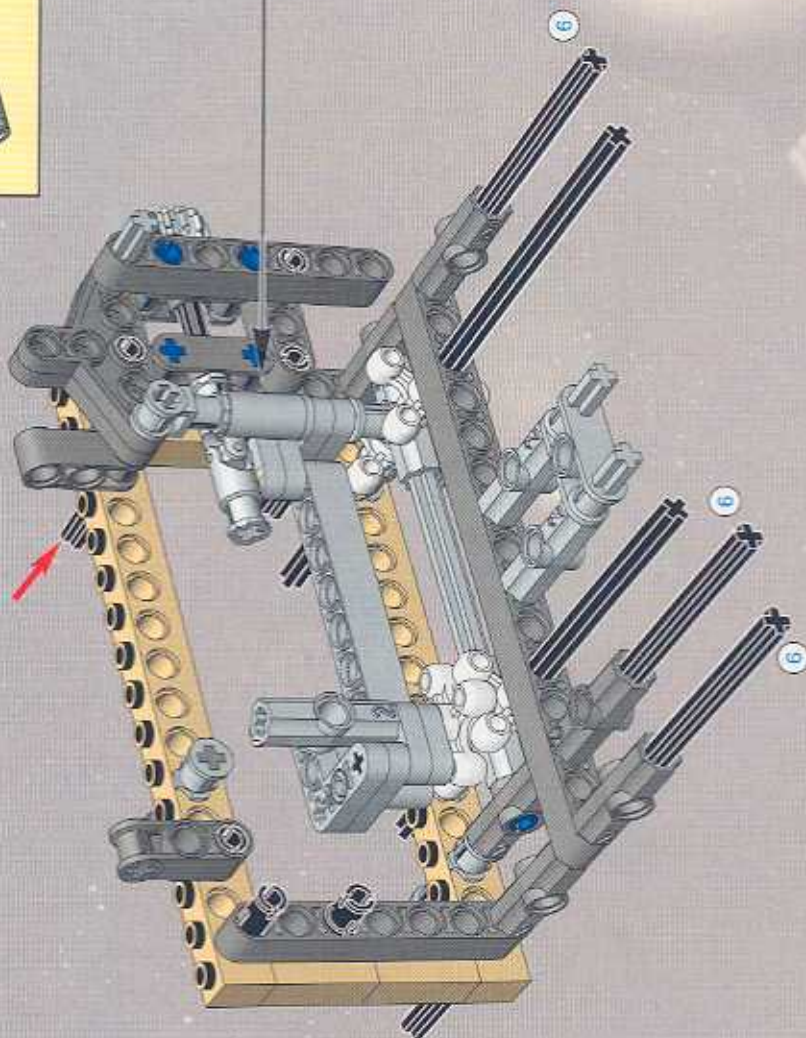
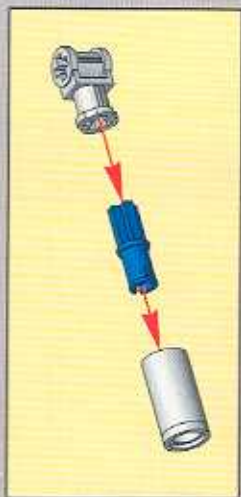

4141506

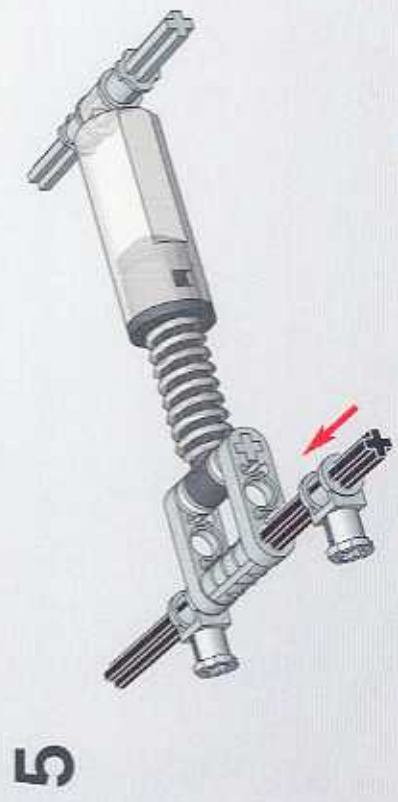

17 1



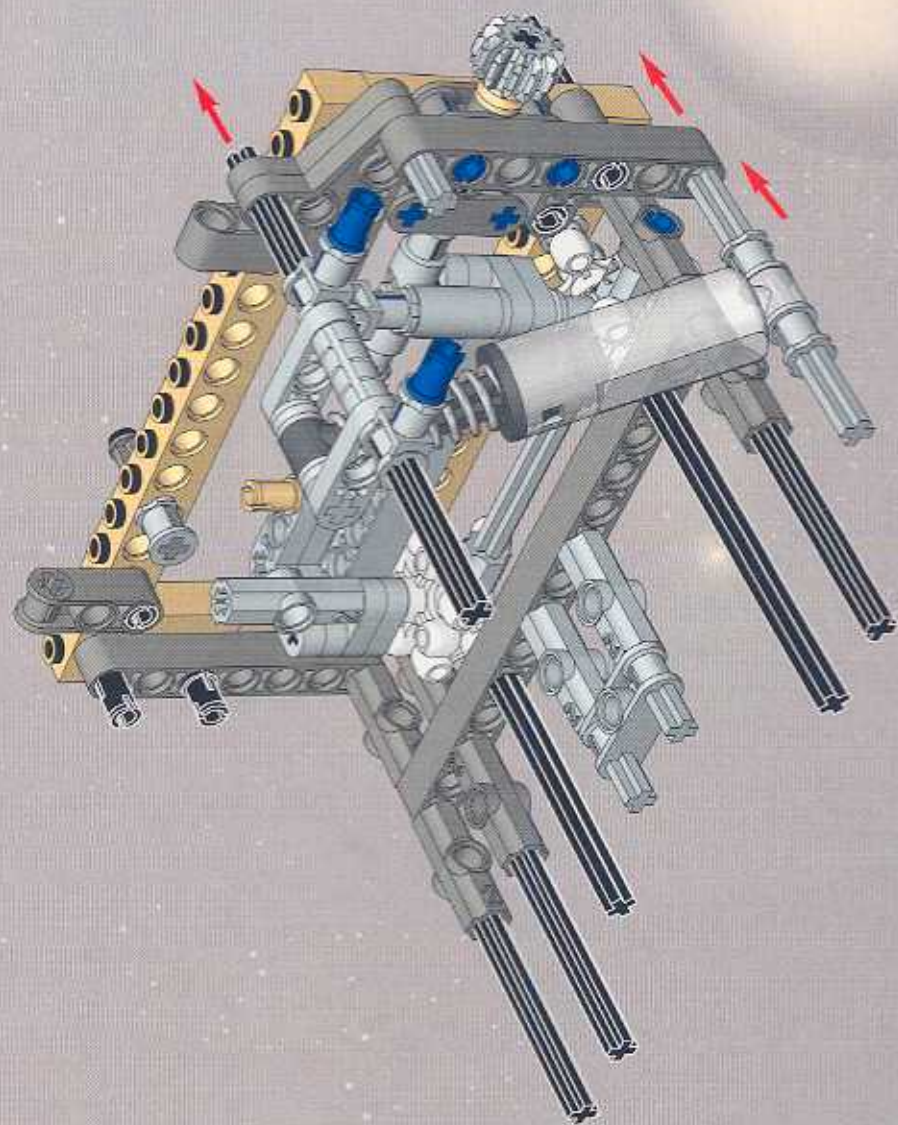

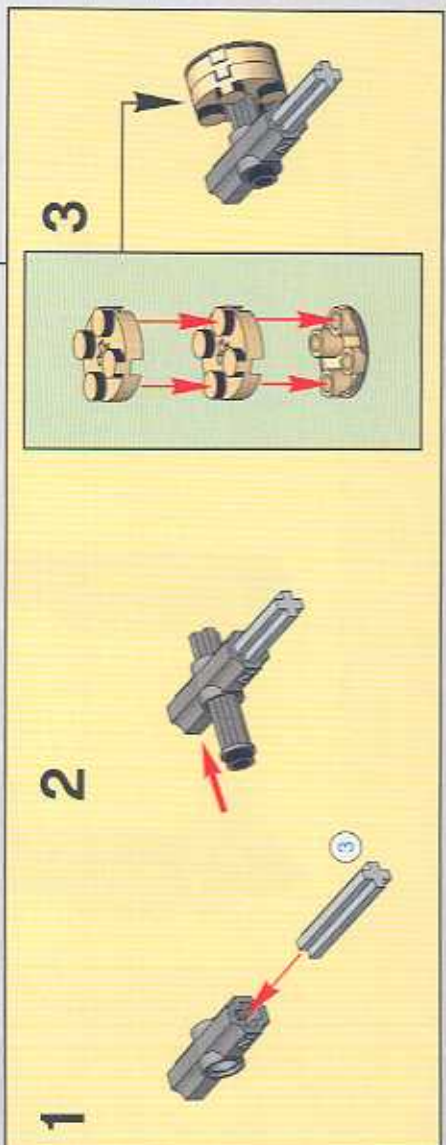
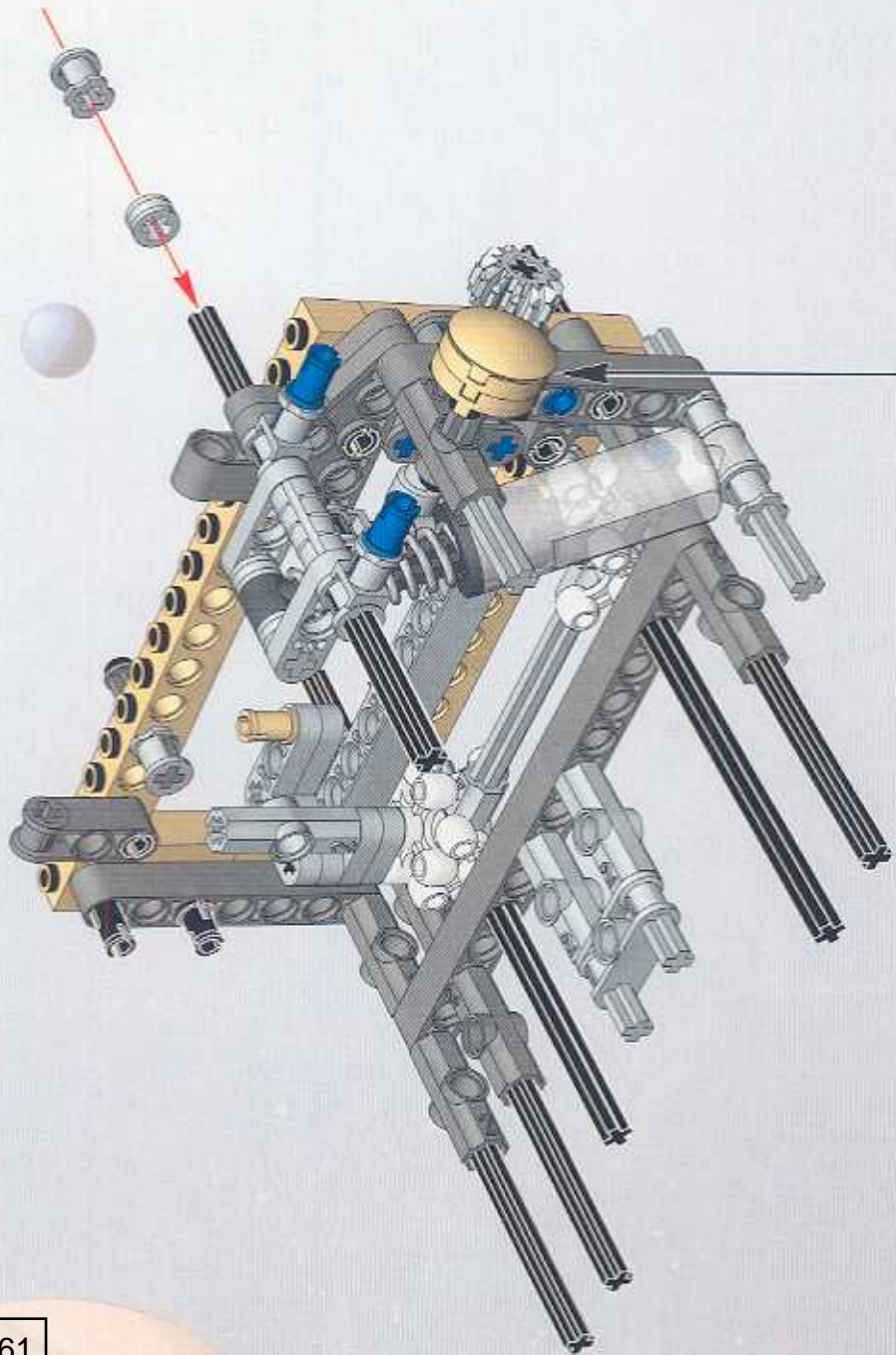

4140561

4140562

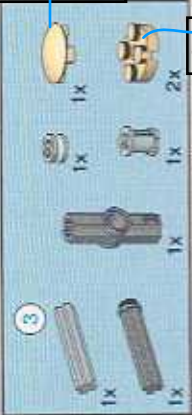

18

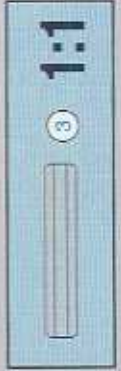

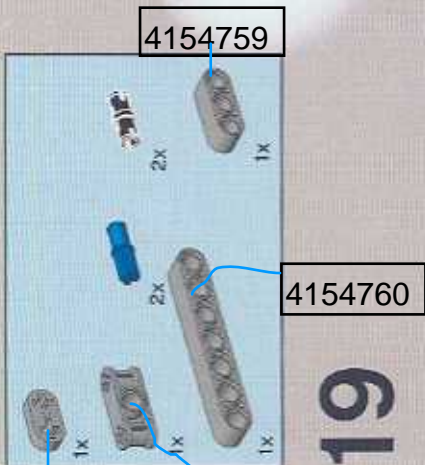
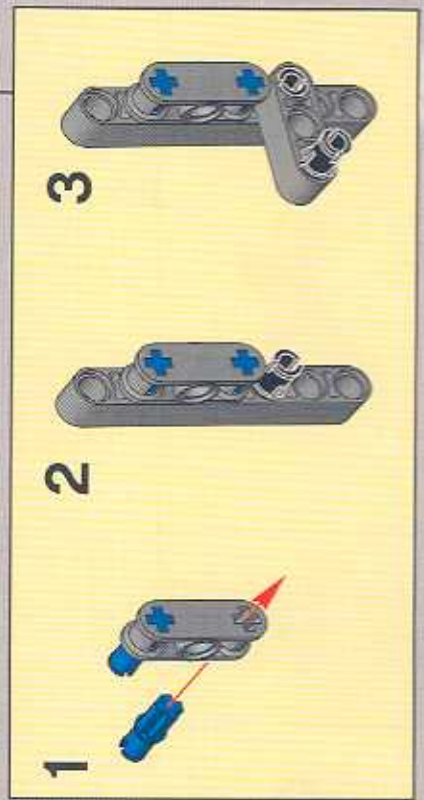
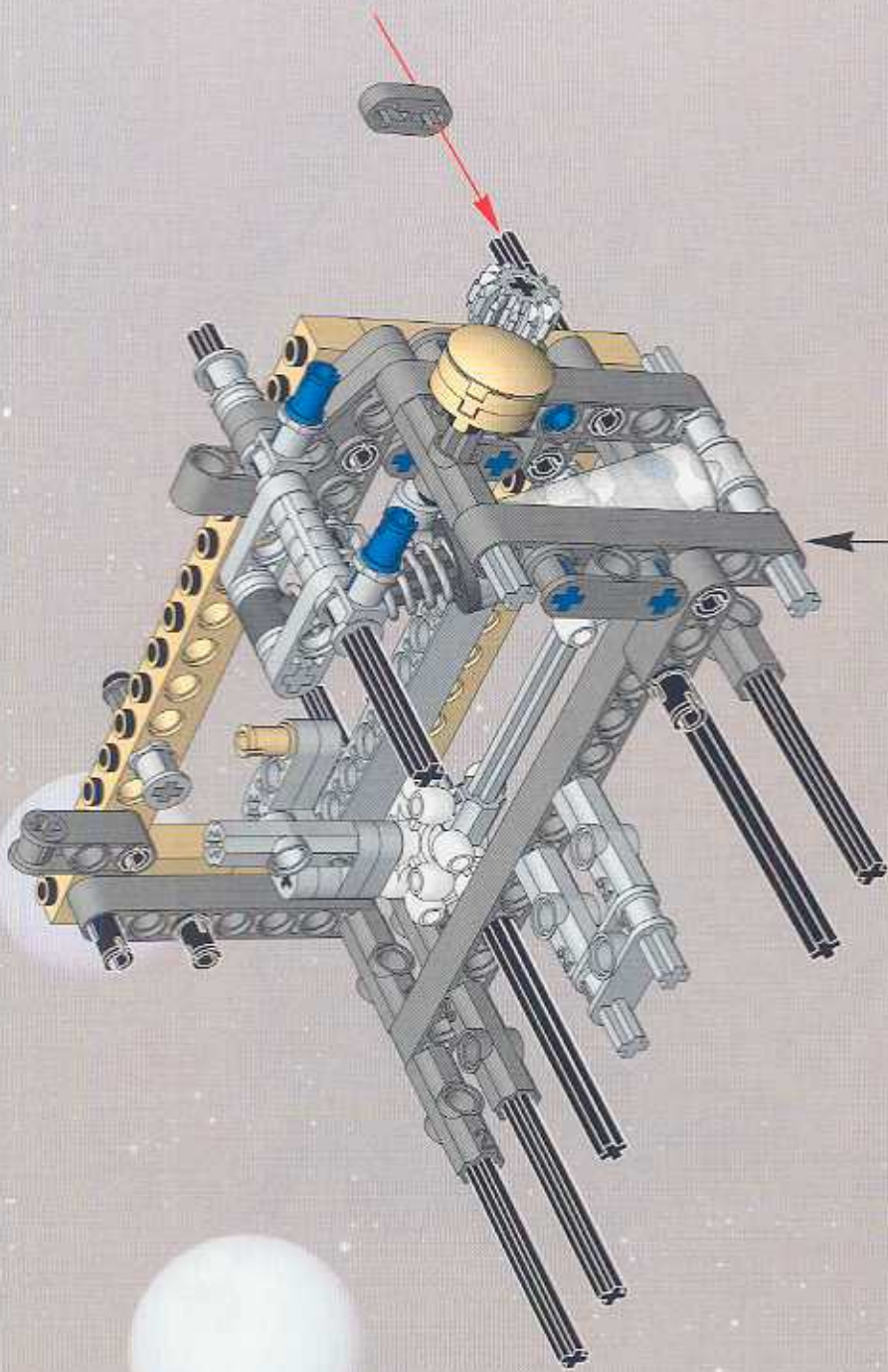

4154759

2x

1x

4154760

2x

1x

19

4207748

4163707

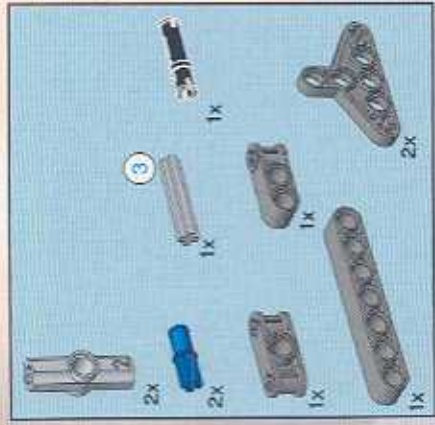

20

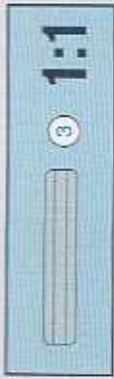
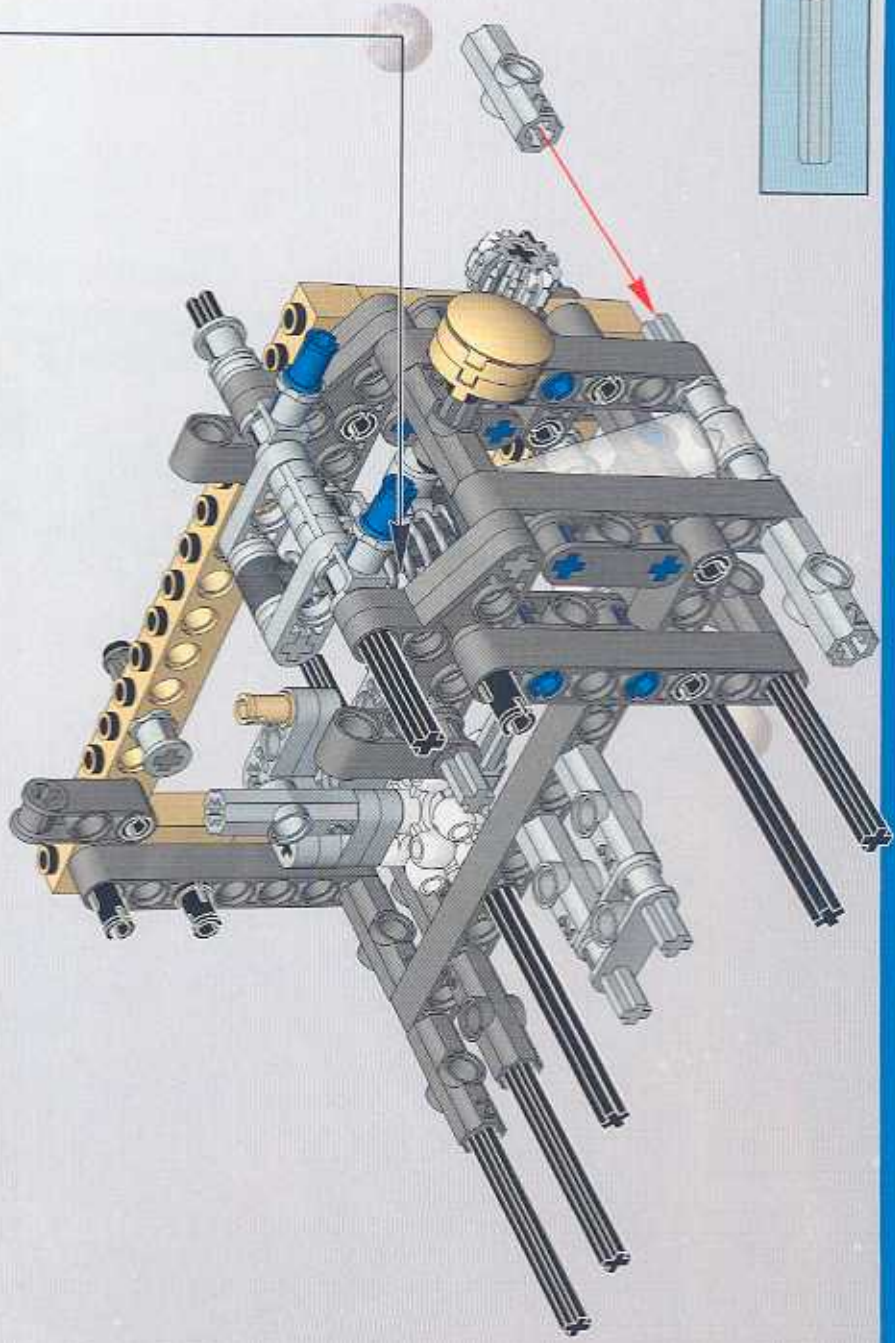
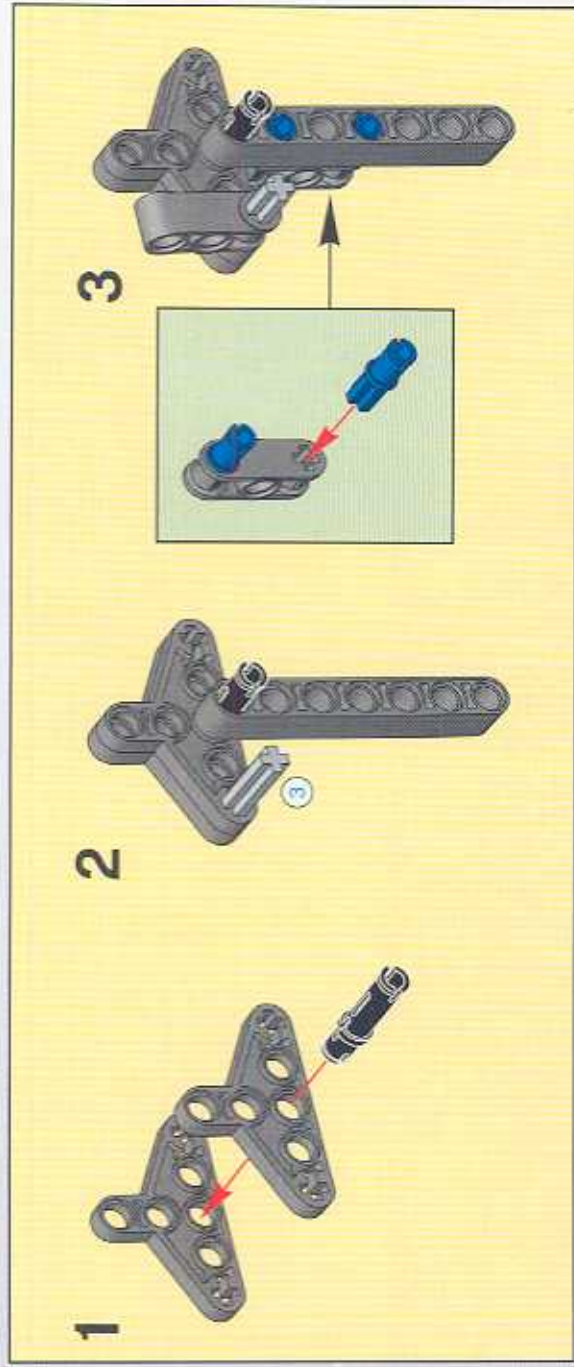



21

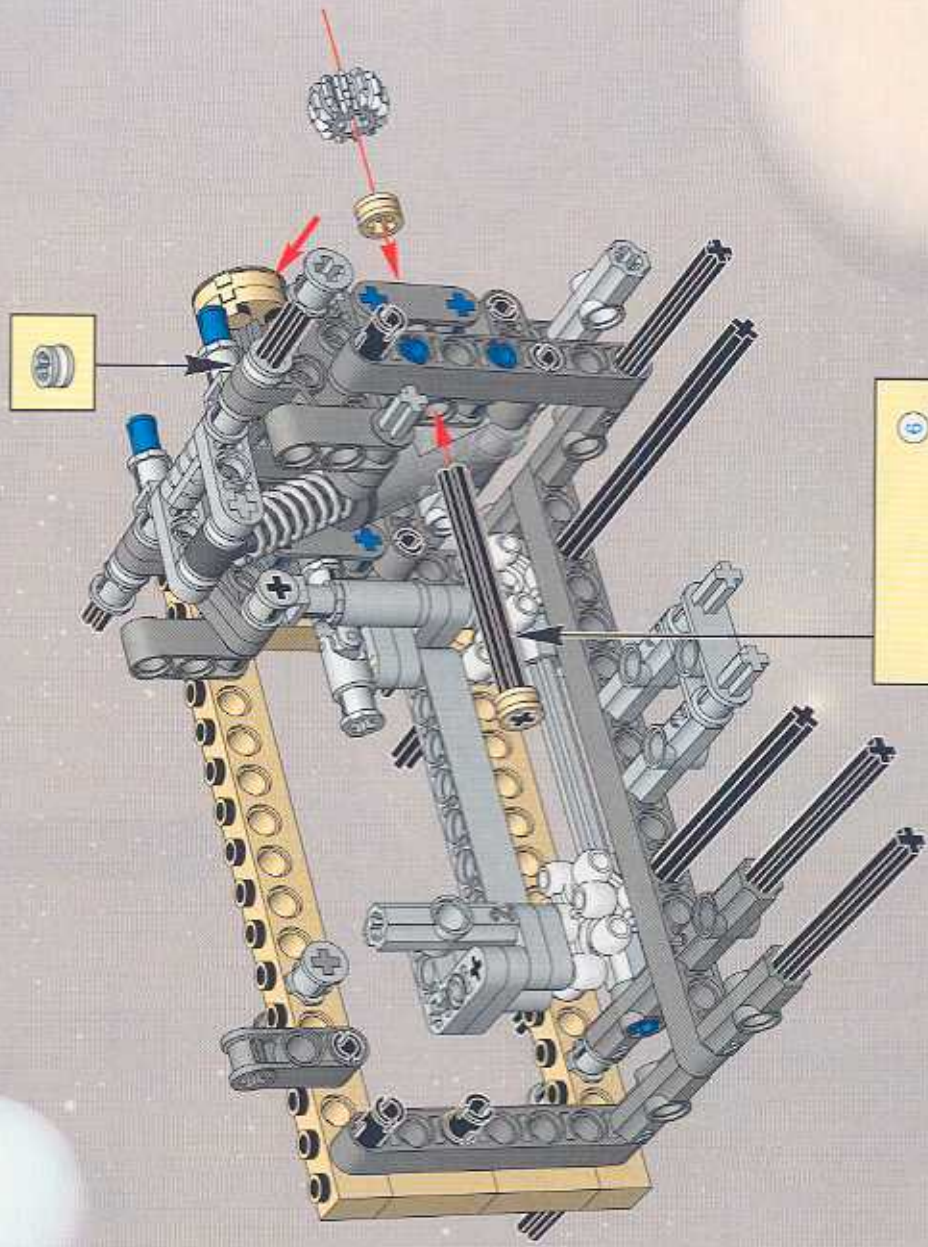

4113804

4141603

4121620



22

1

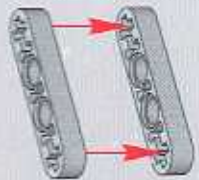

2



3

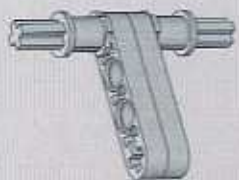

4

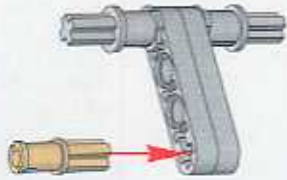

5

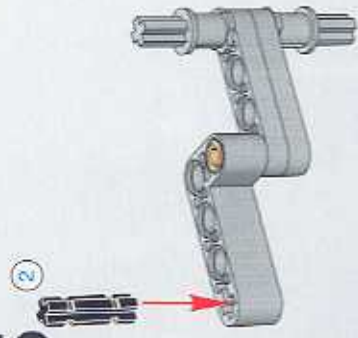

6

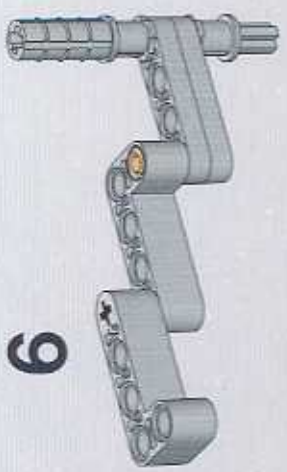

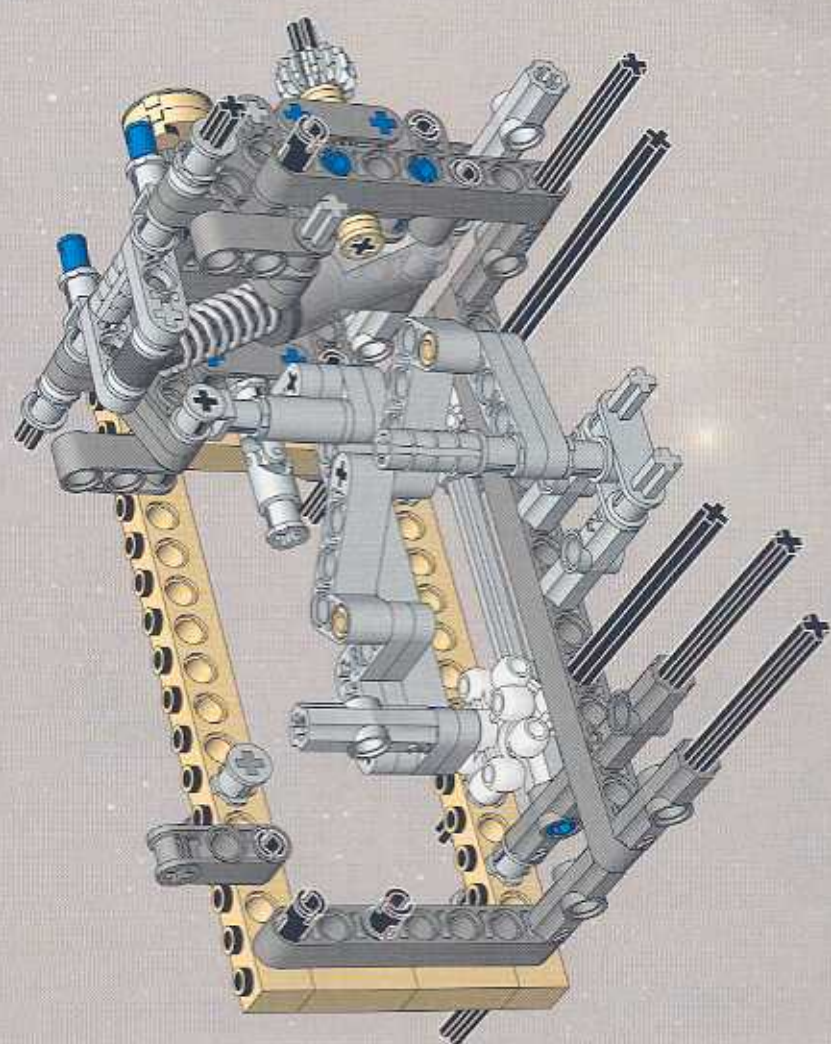



23

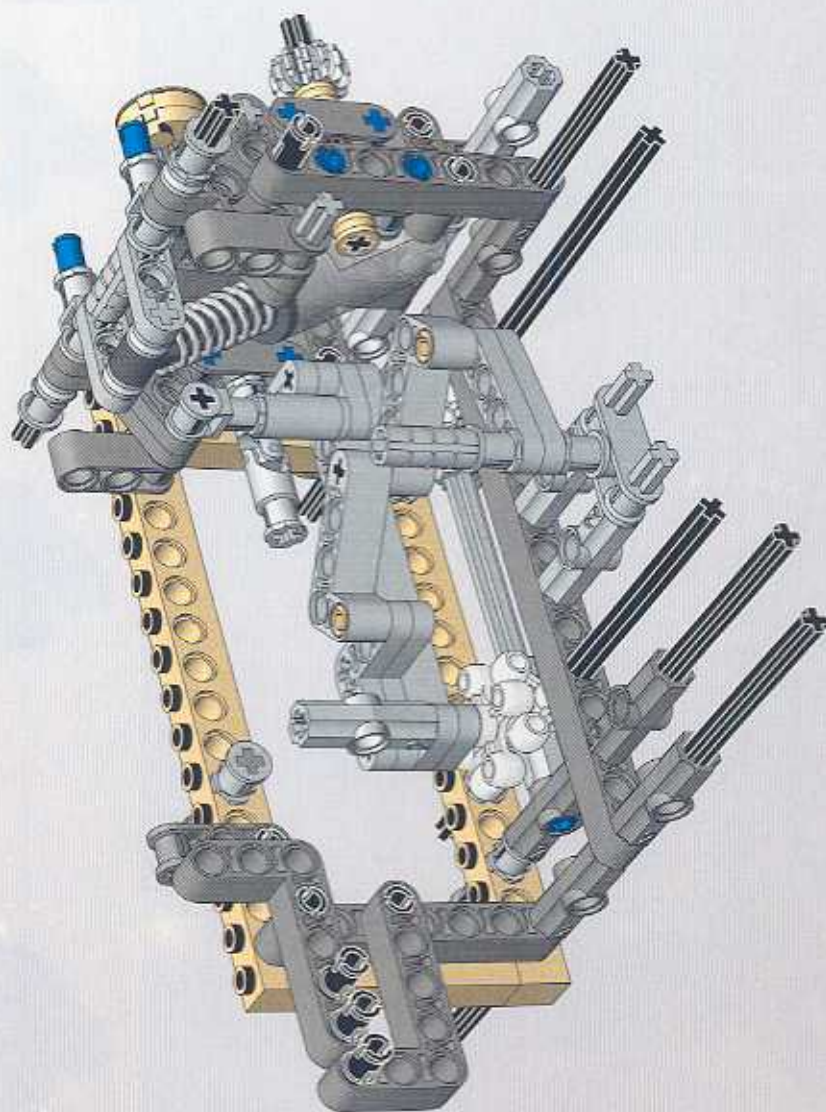

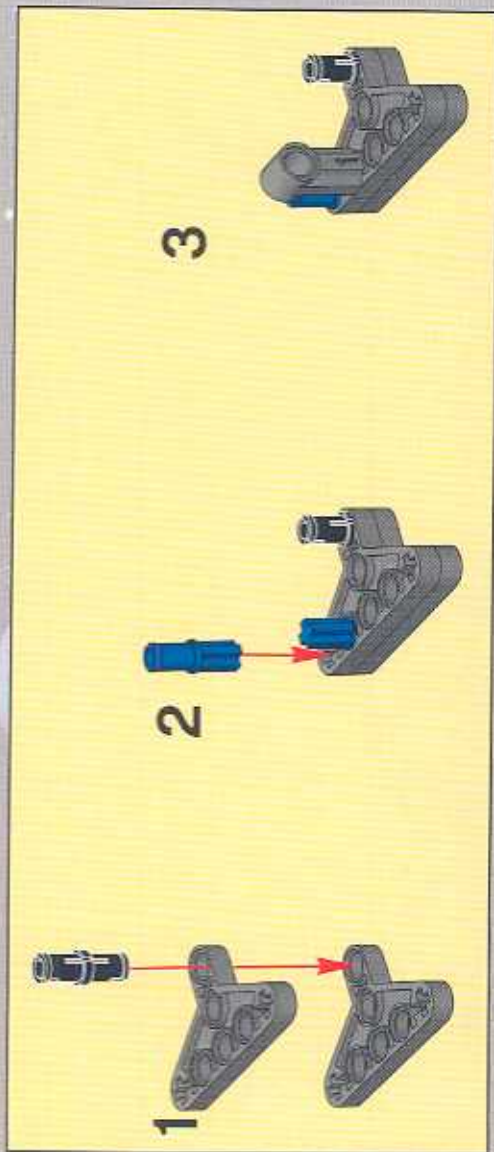
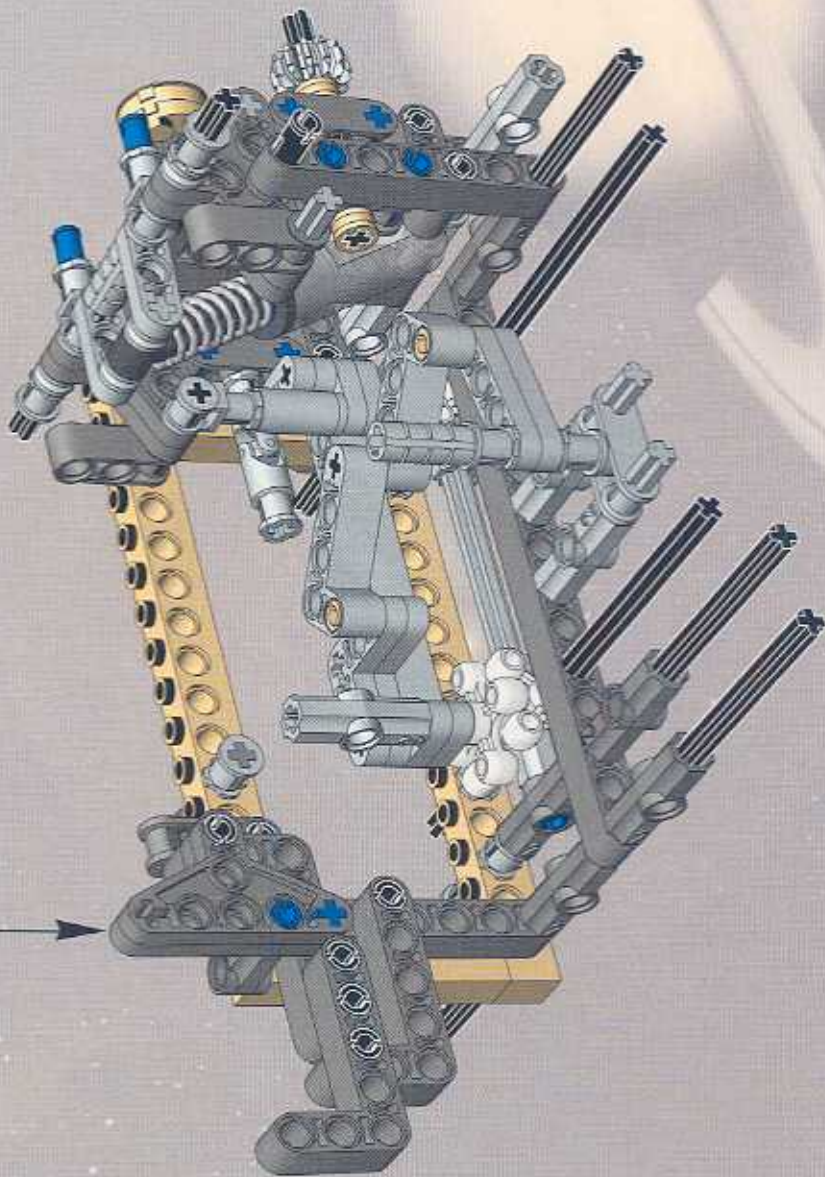

4140503



24

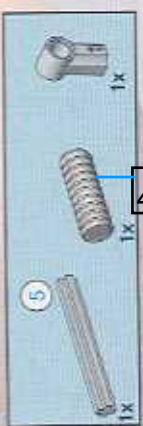

4141670

1



2

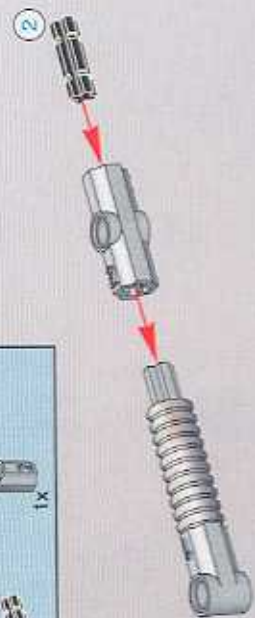

3

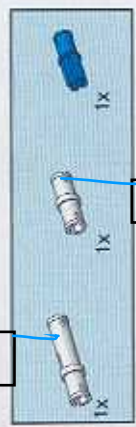

4184166

4154753

4

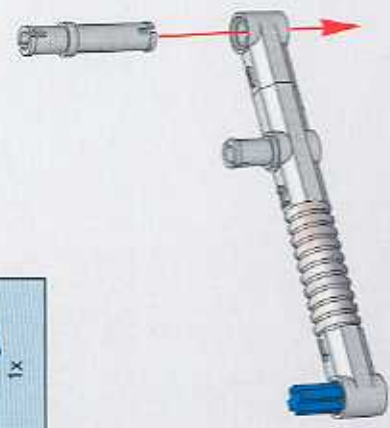

4175439

4195406

5



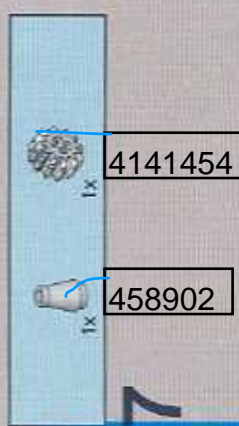
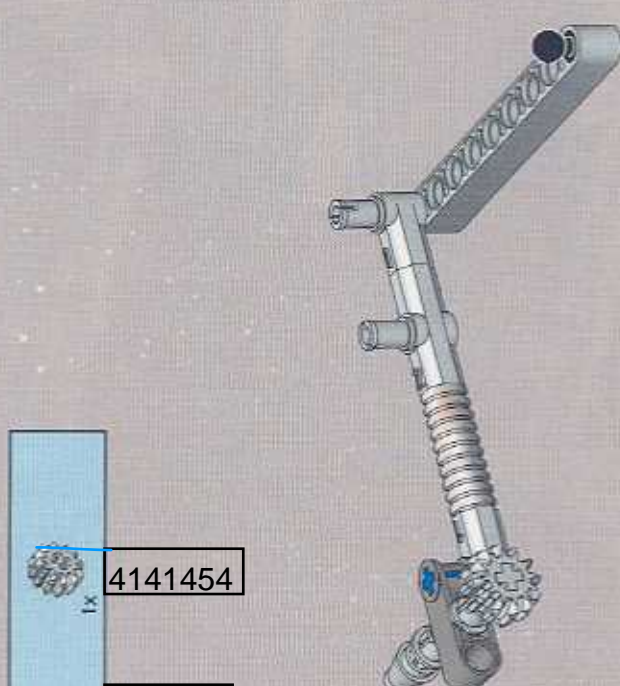
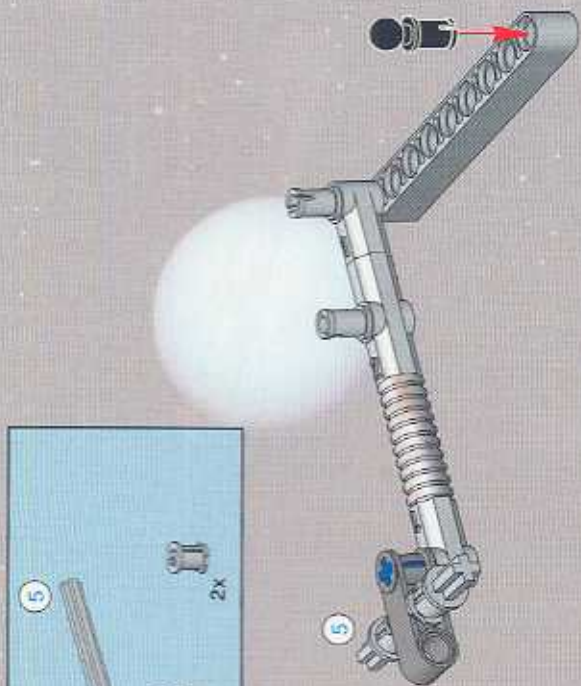
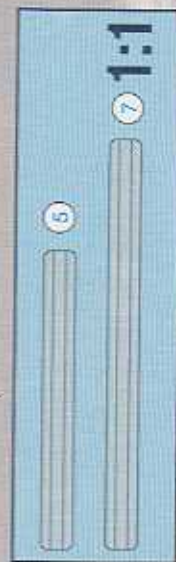
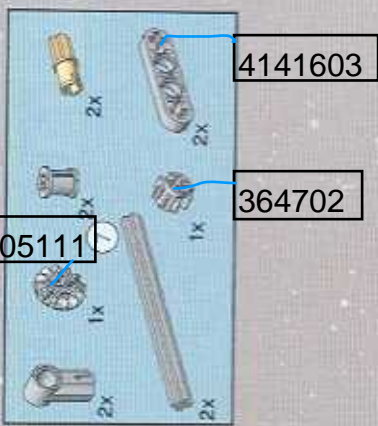
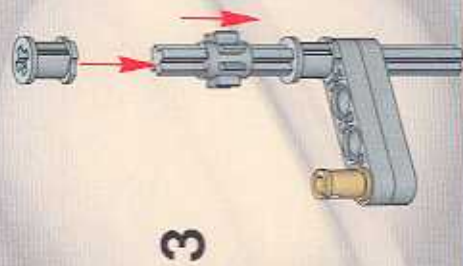
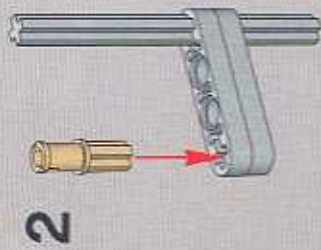
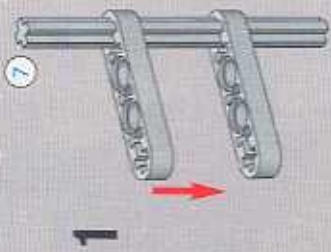



25

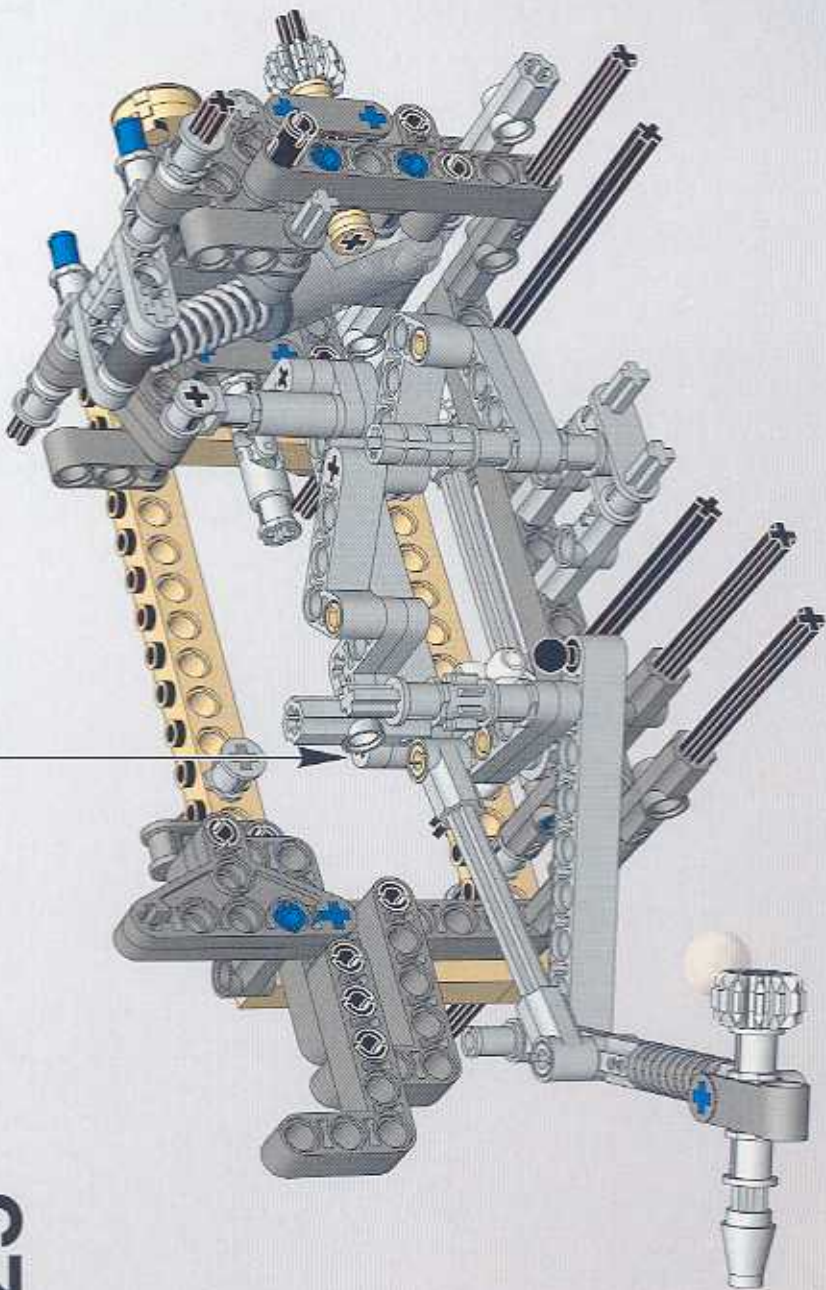

4

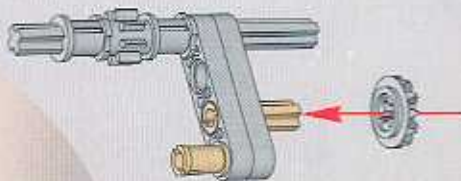

5



5

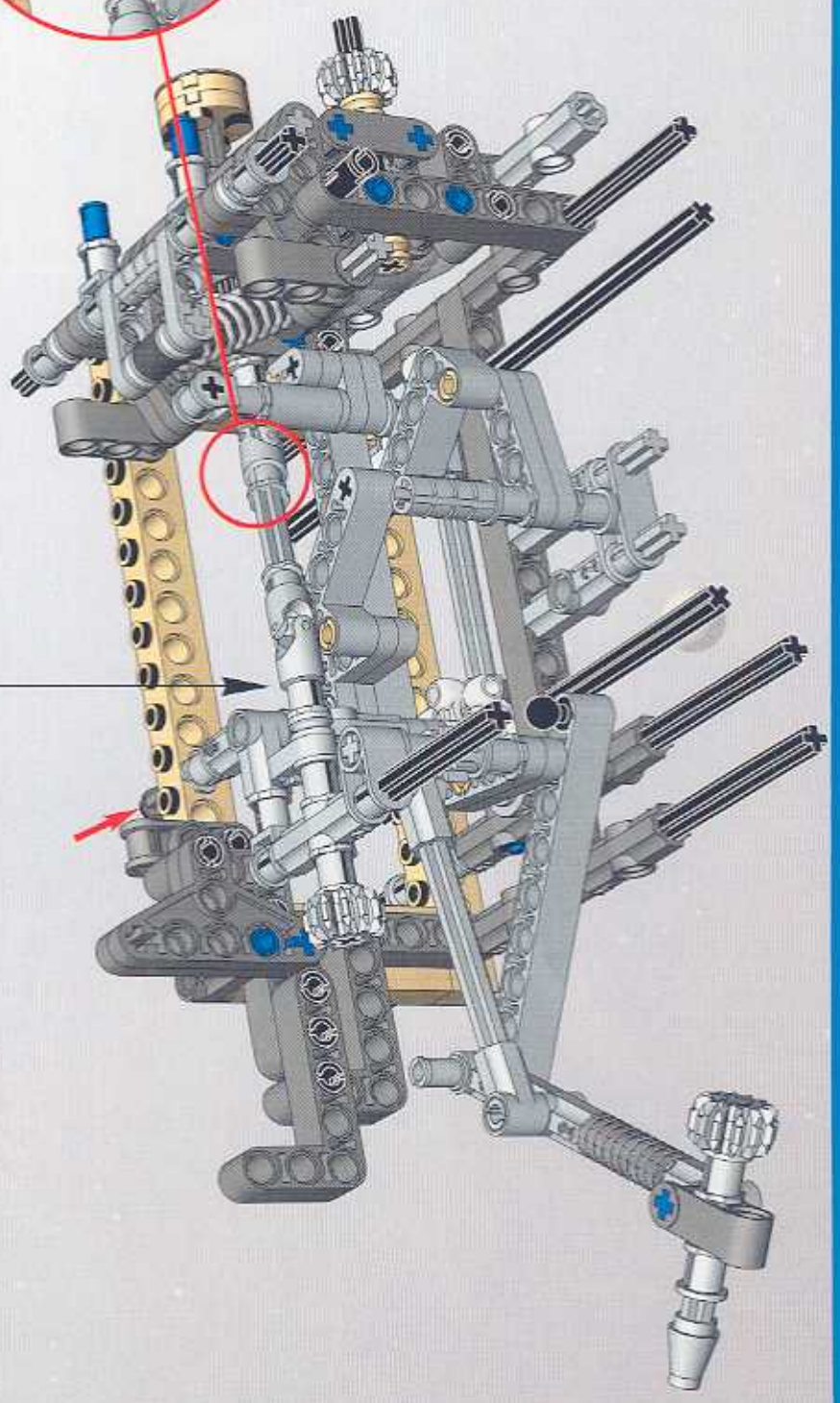
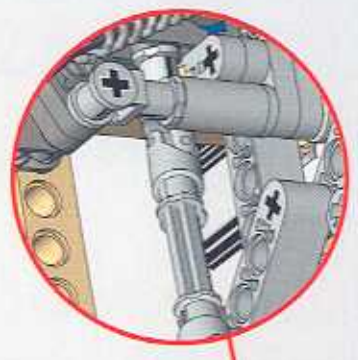
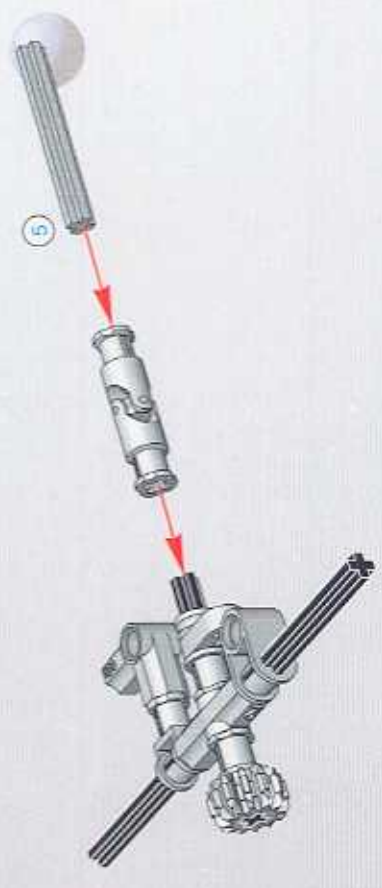

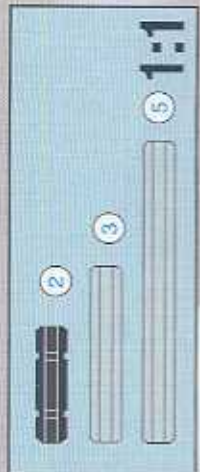

4141426

27

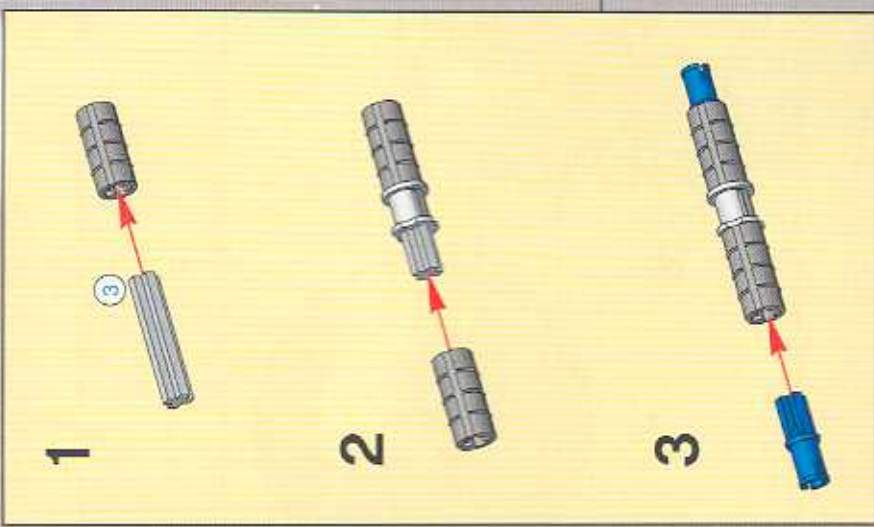

2

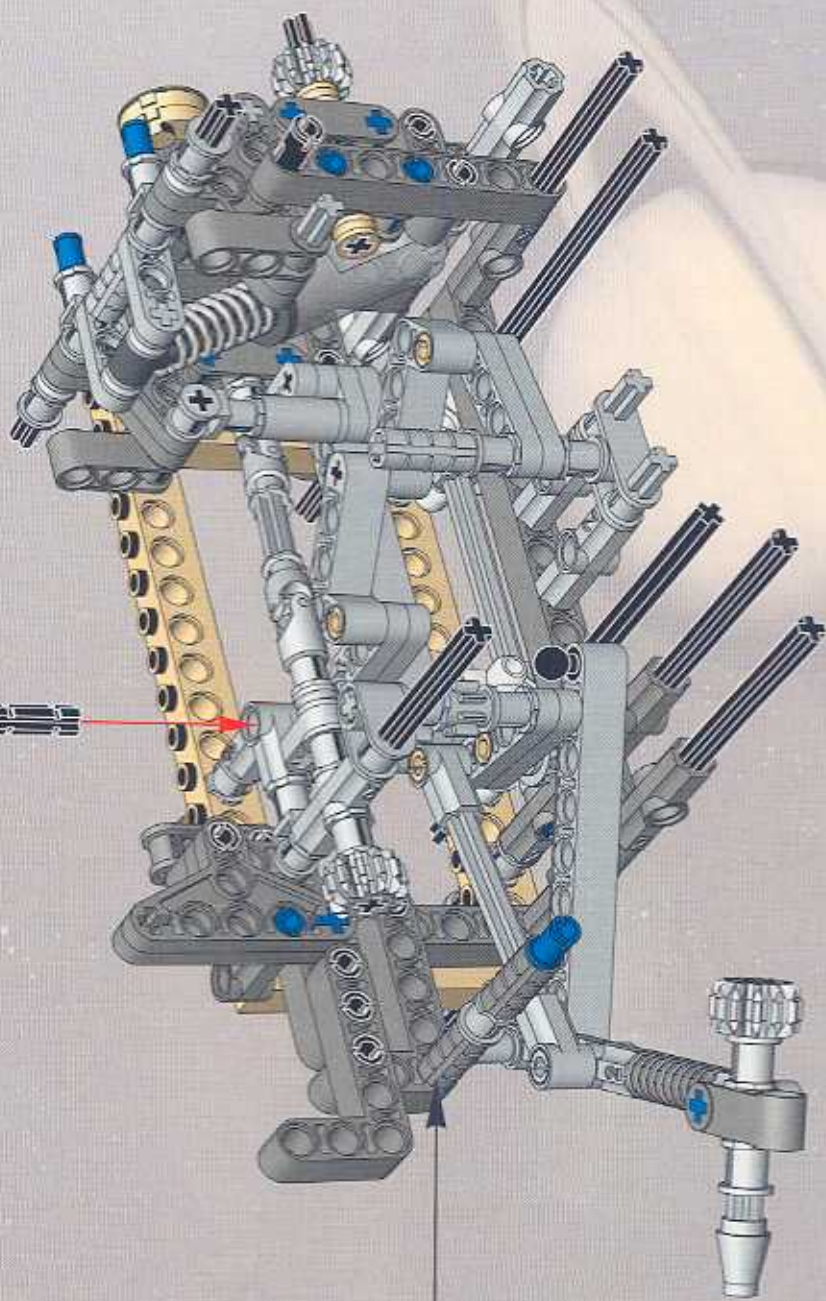



28

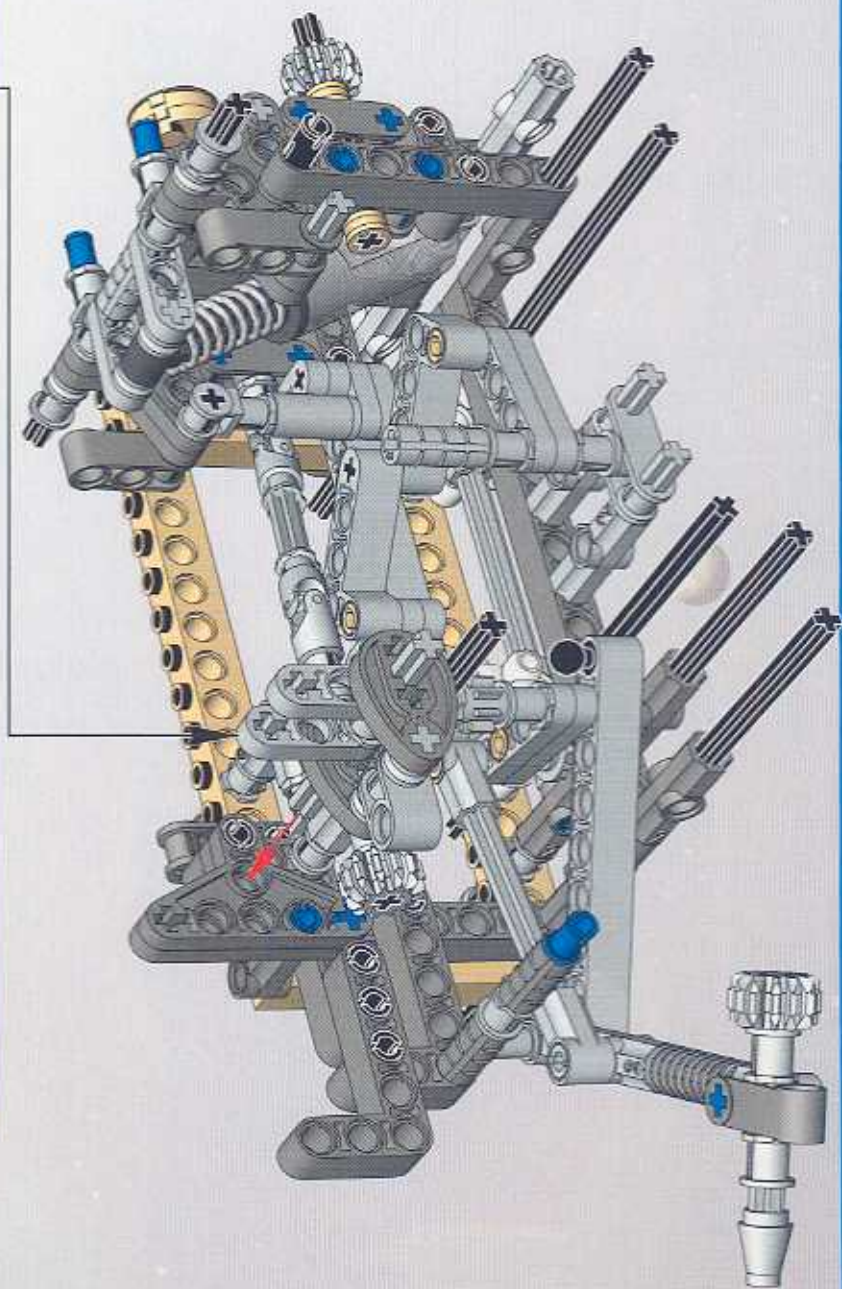
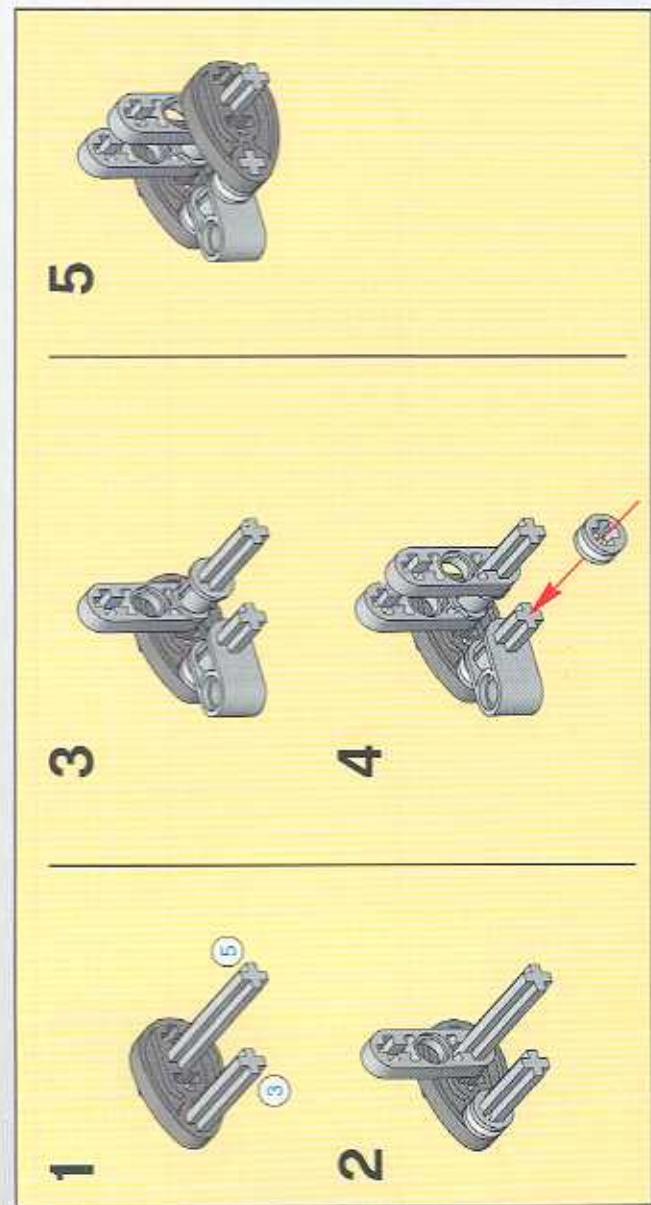

4143187

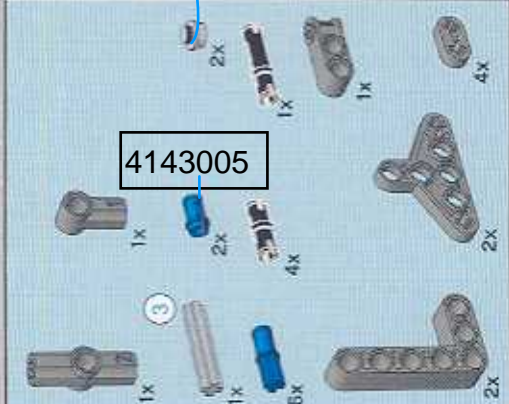
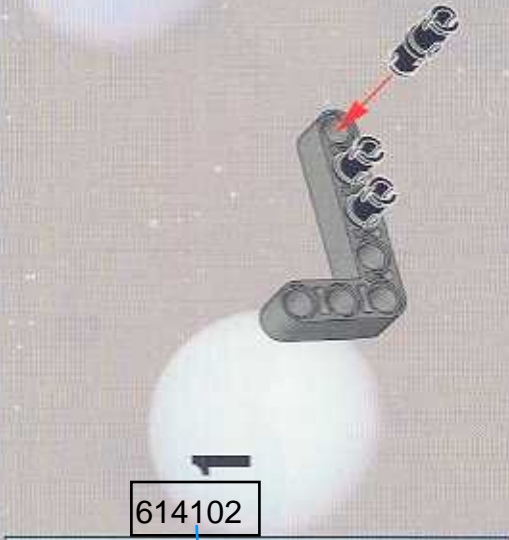
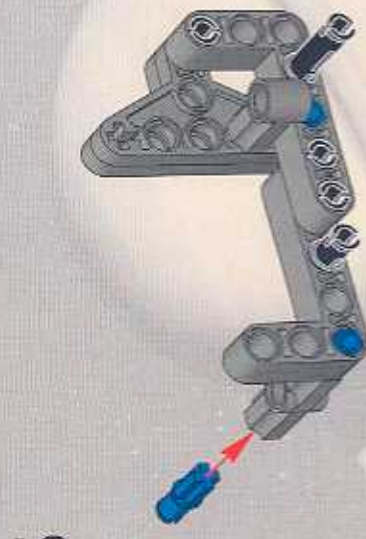
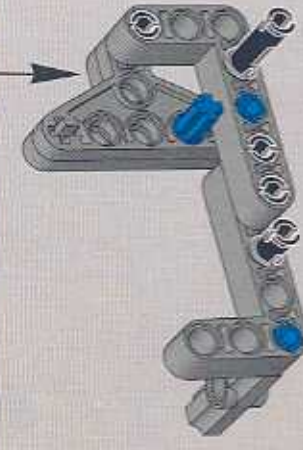
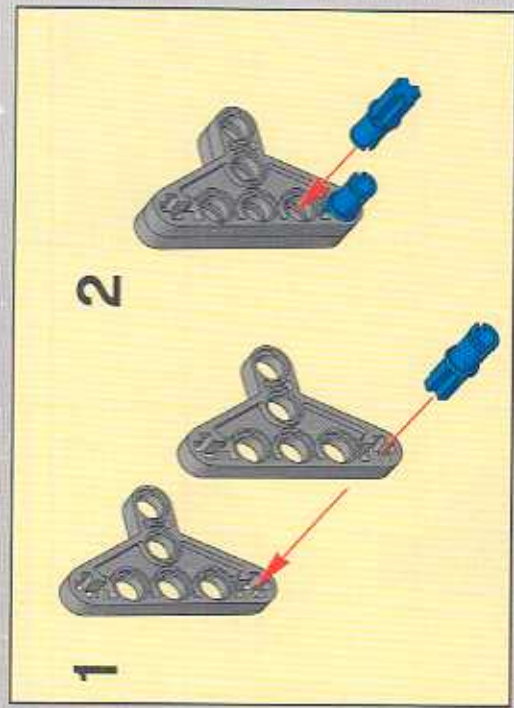

29

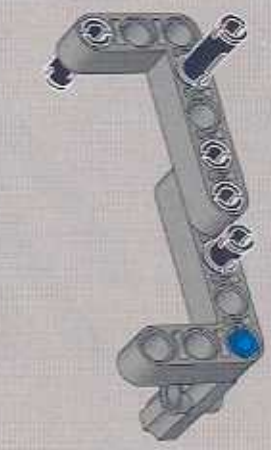
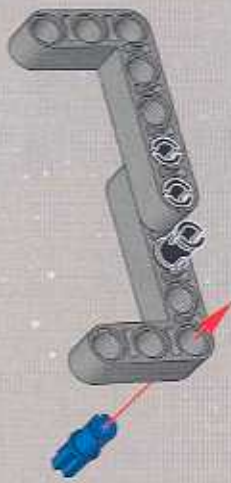

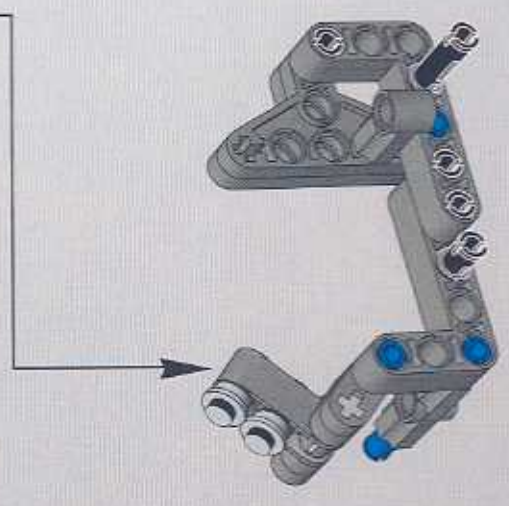
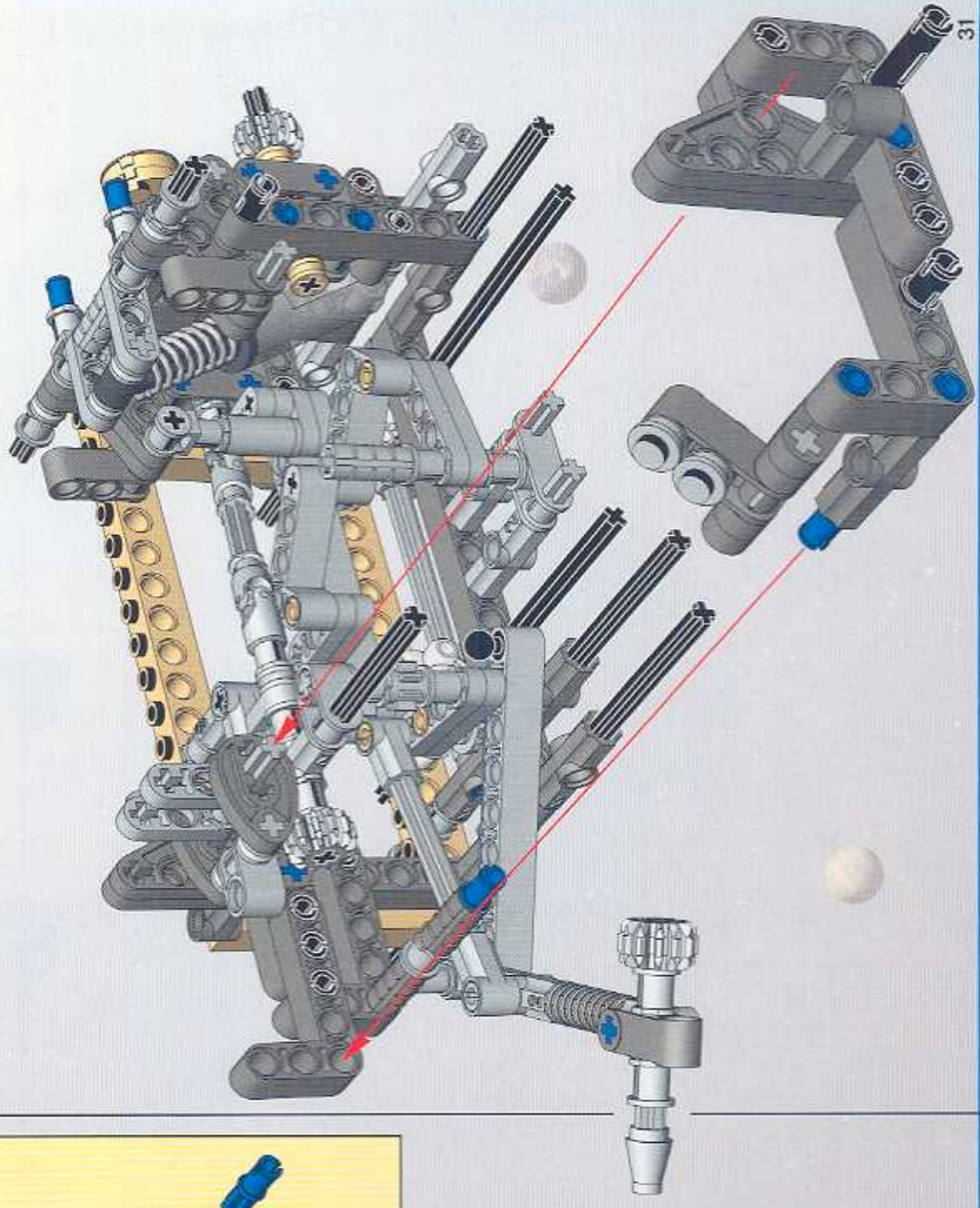
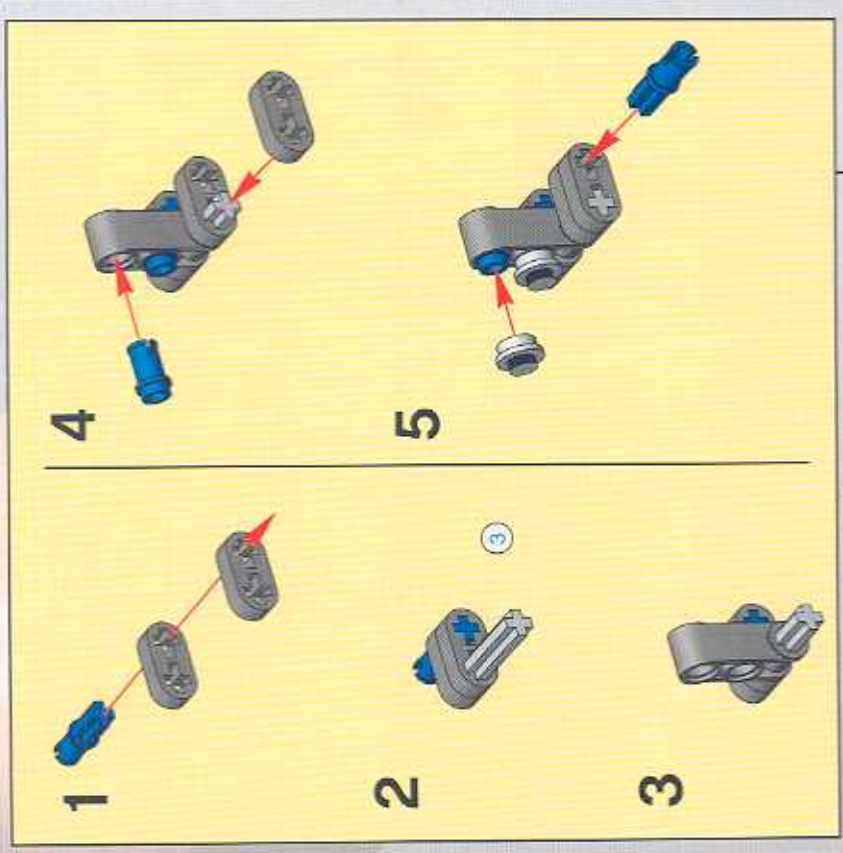

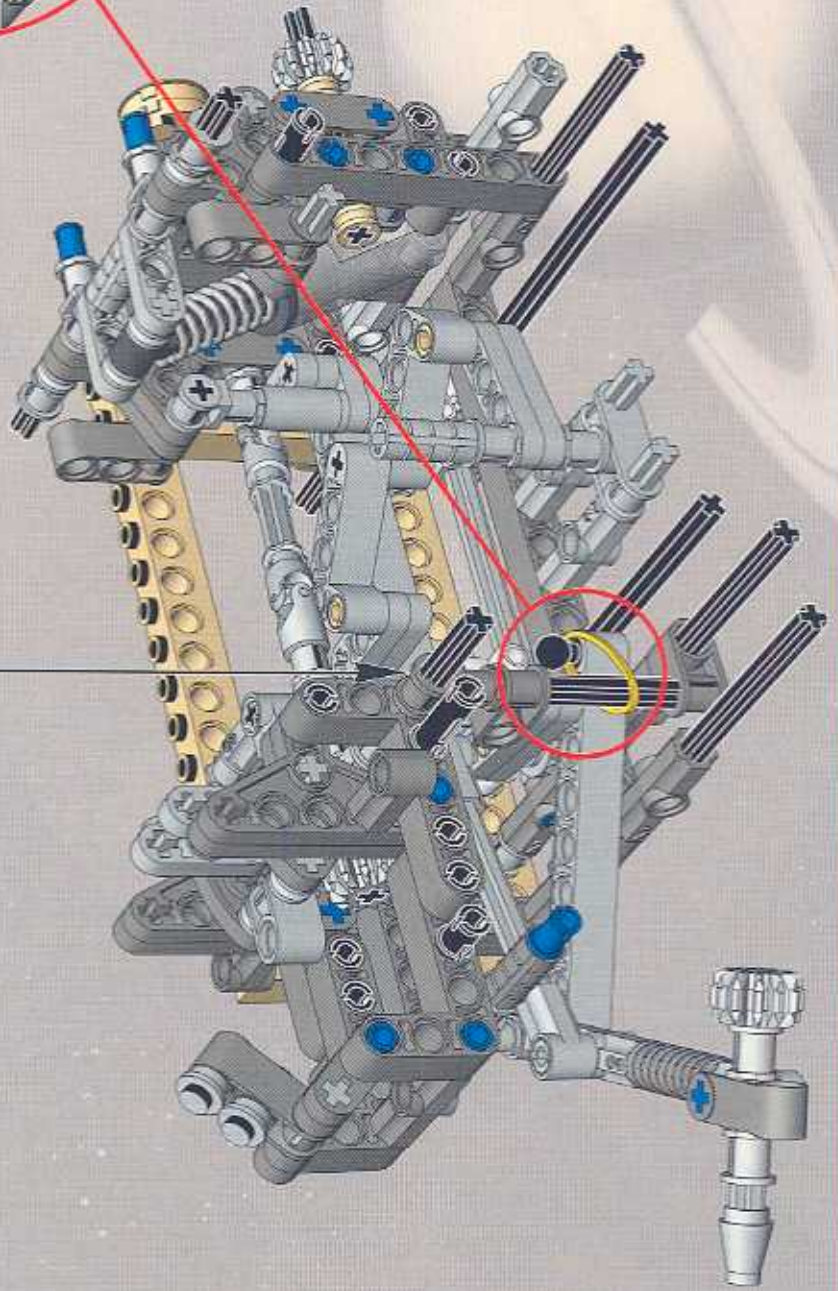
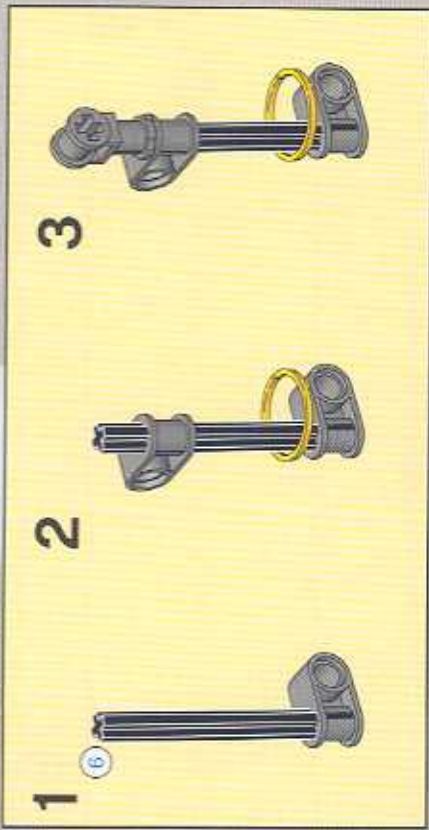
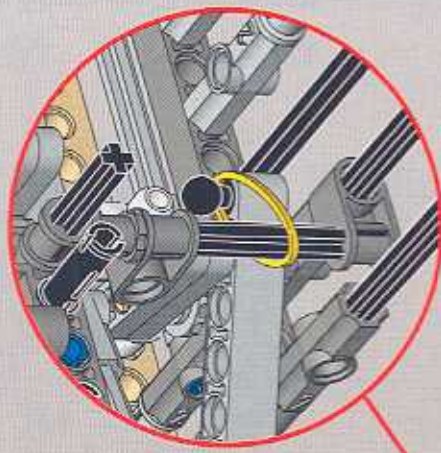

4124335



30



4124045



471602

31

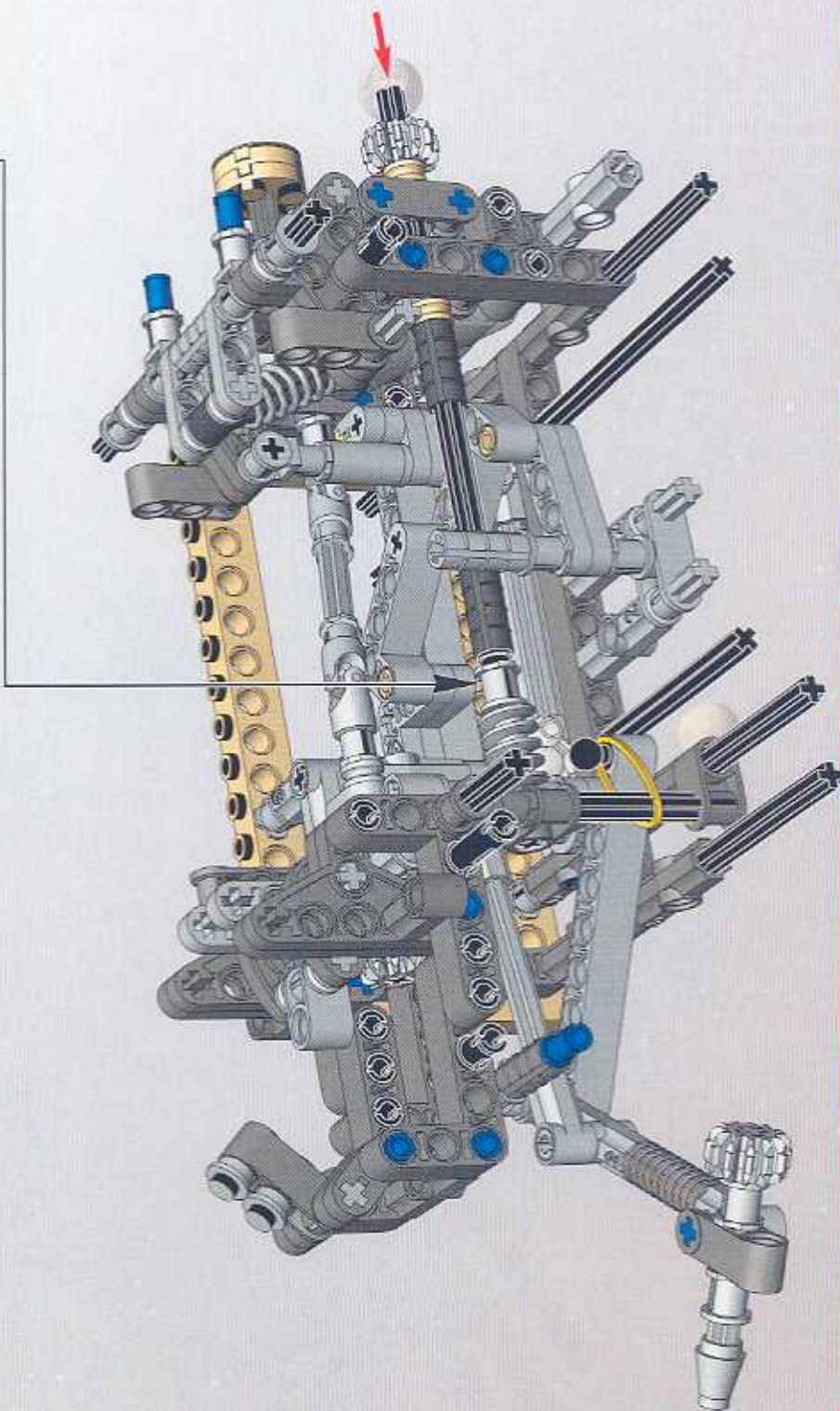
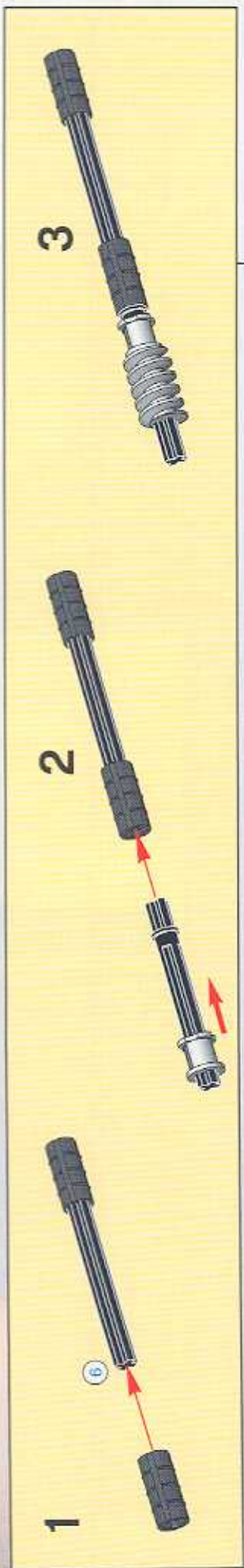

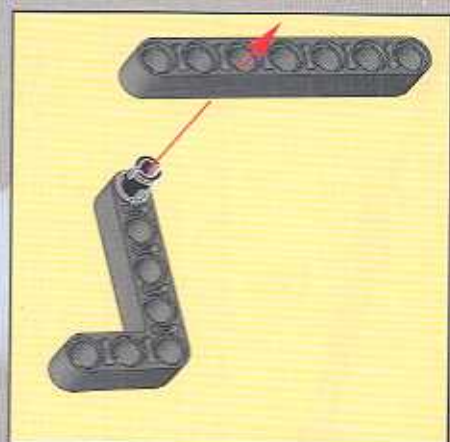
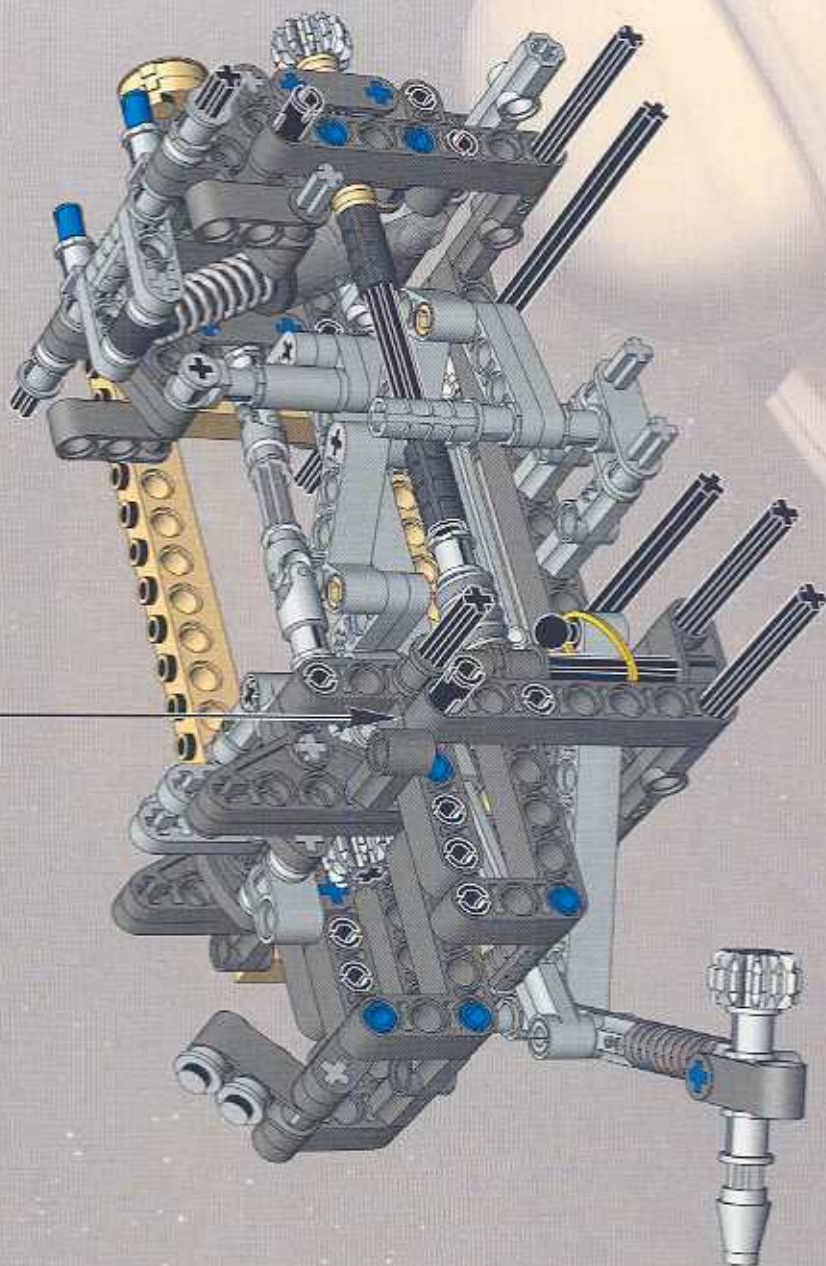

32



4141455



1:1

33

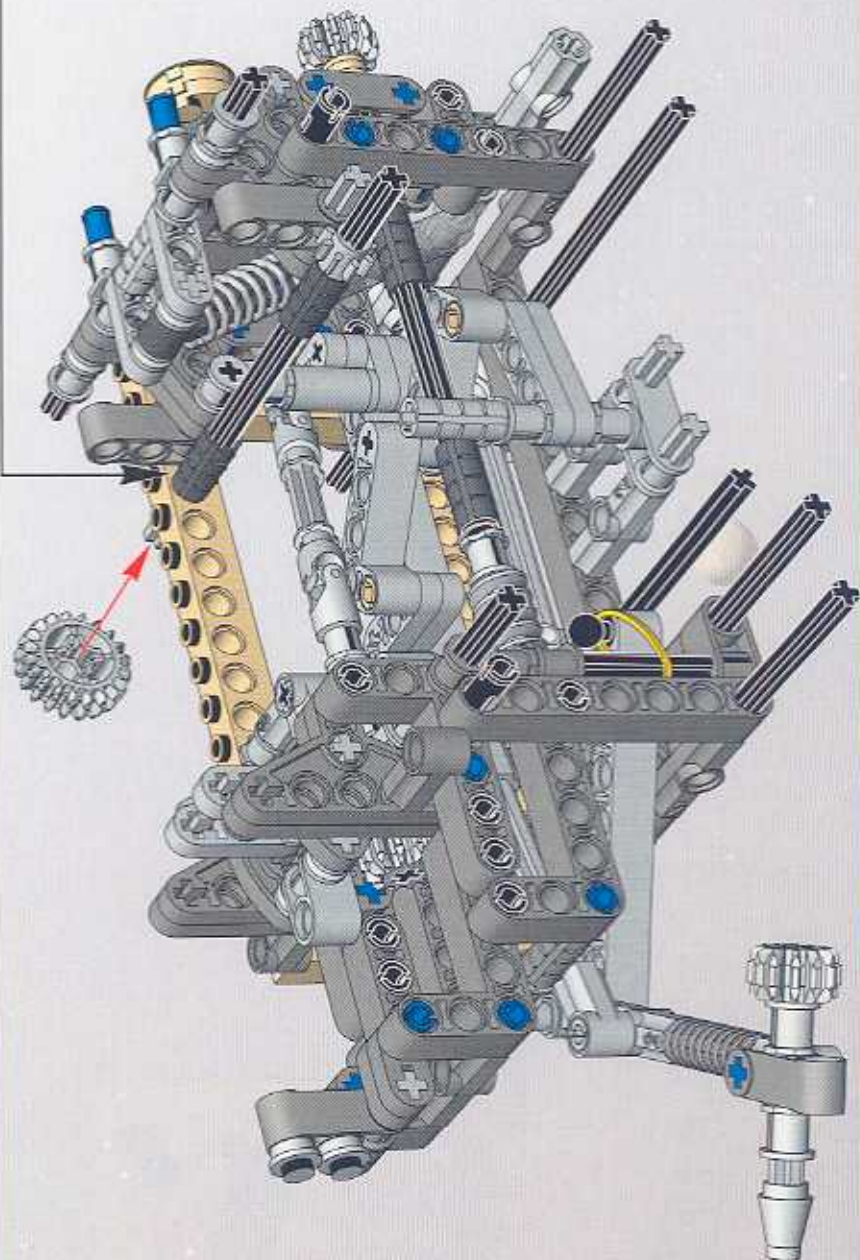
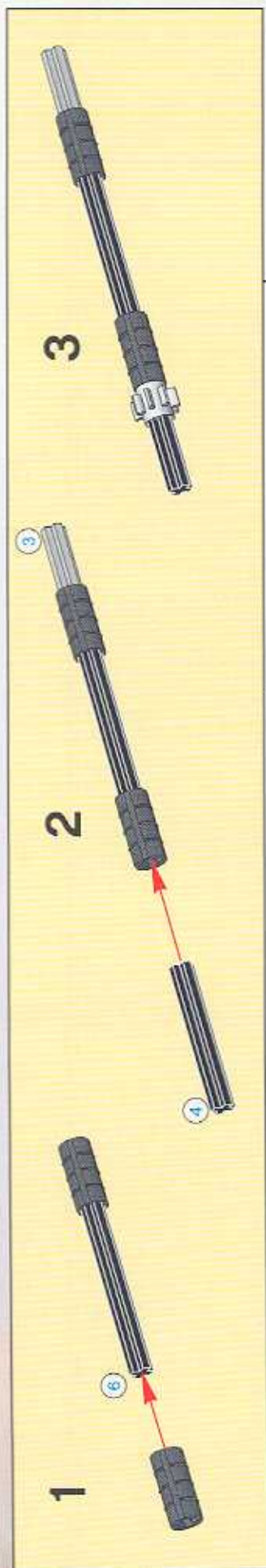

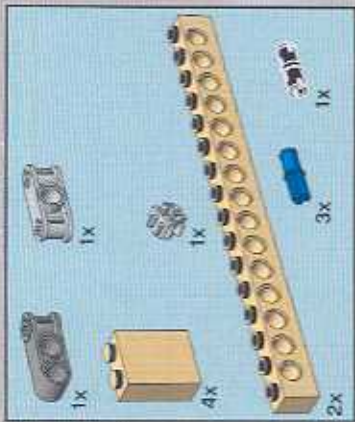

34

1

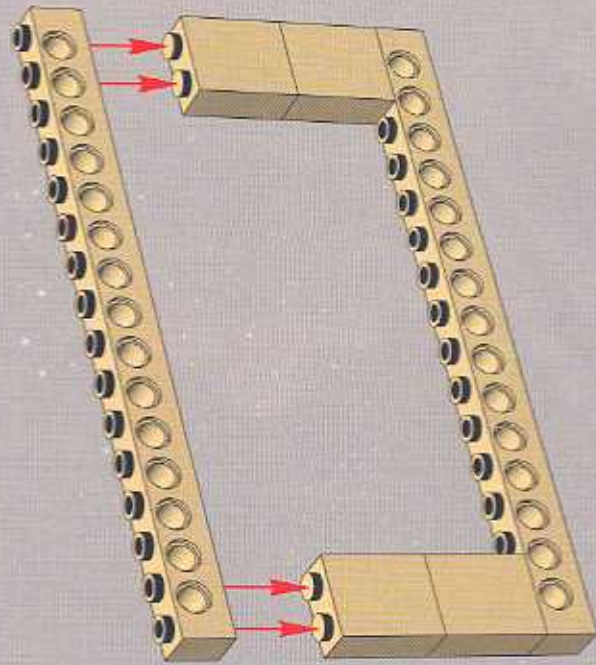

2

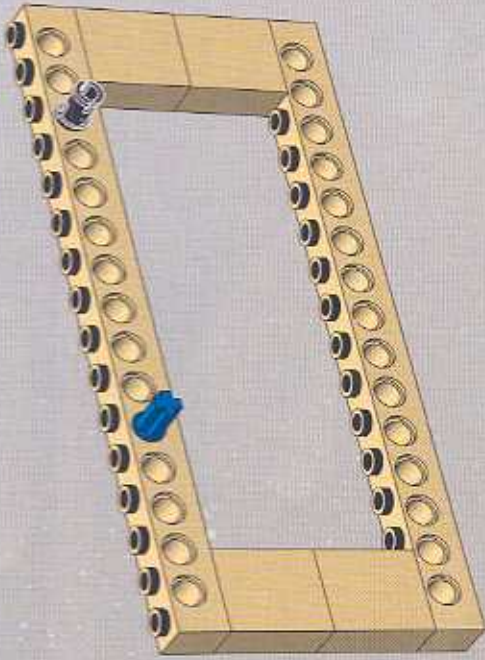

3

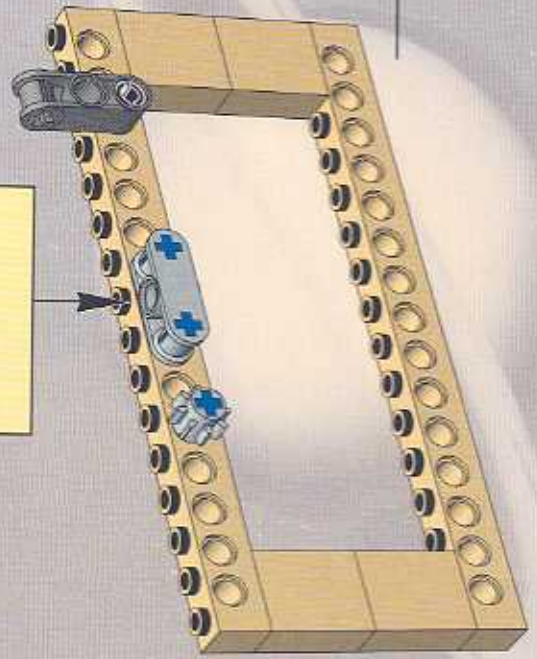

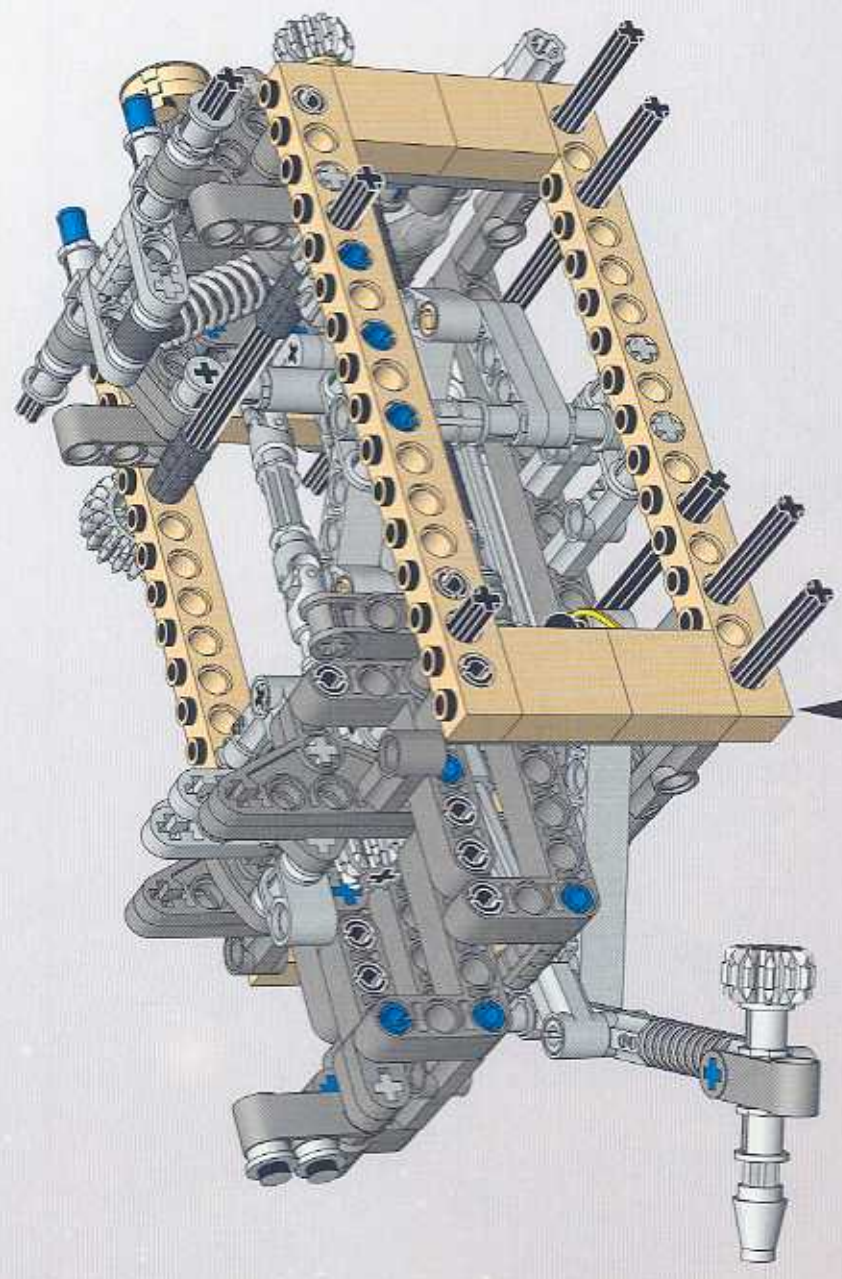

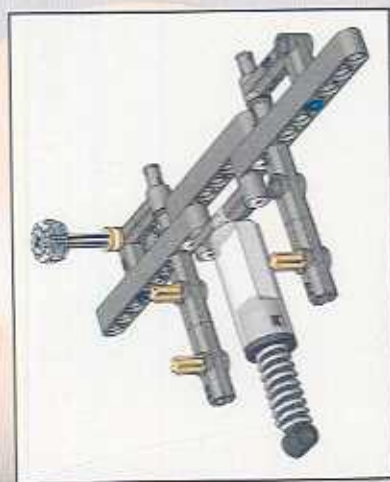

1



2

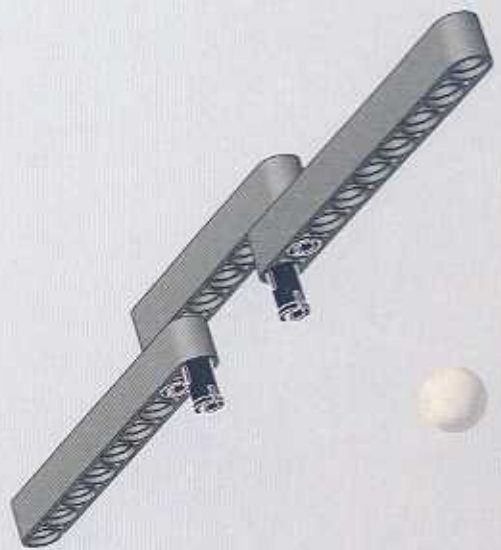
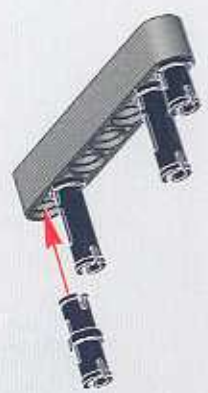

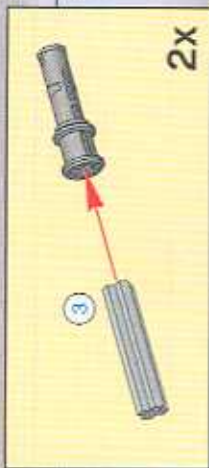
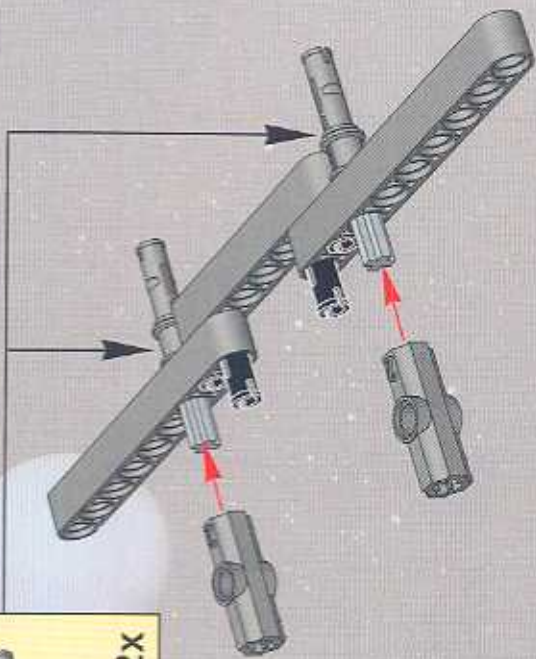
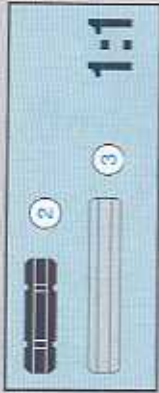

655826

3

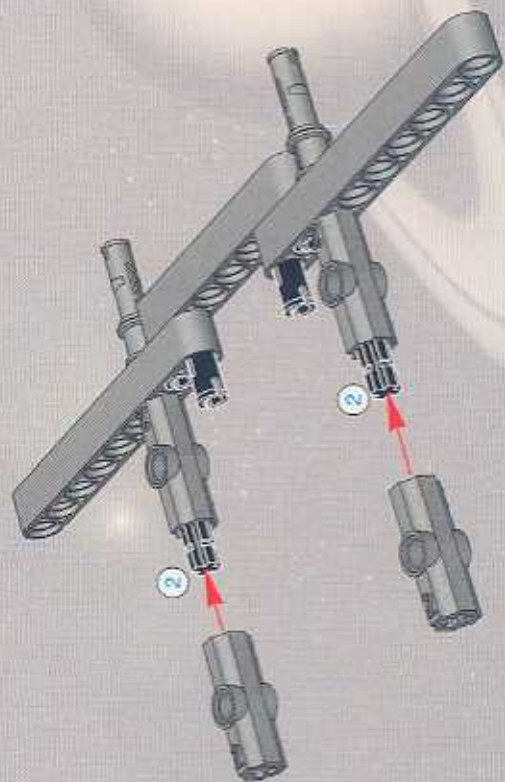

4

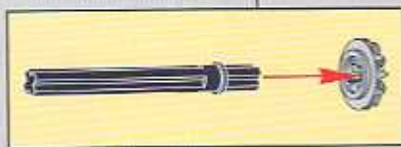
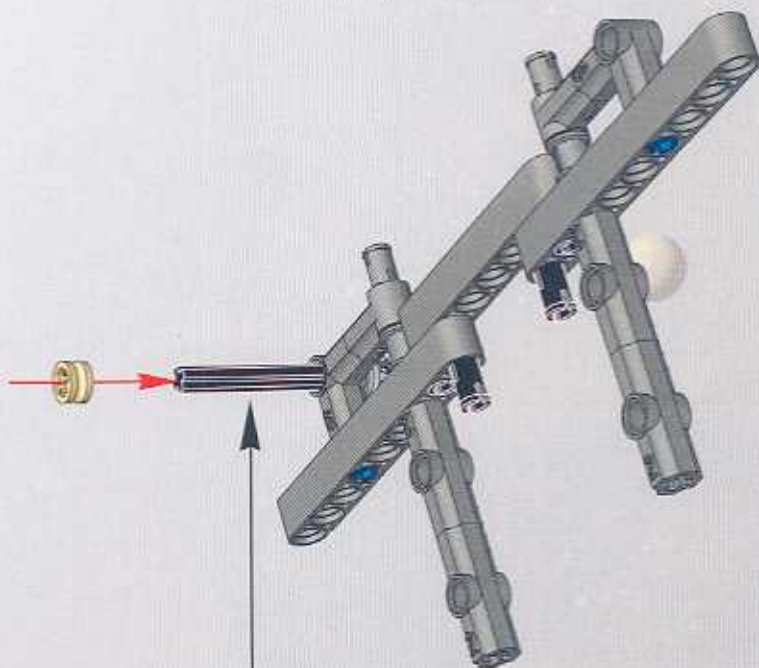
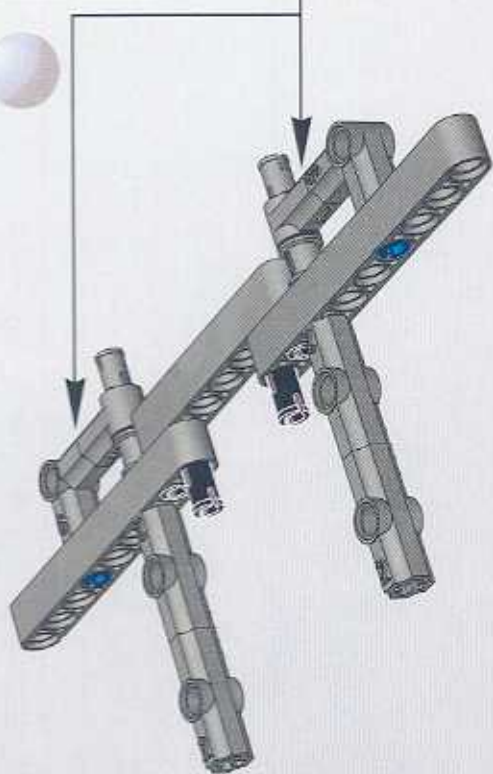
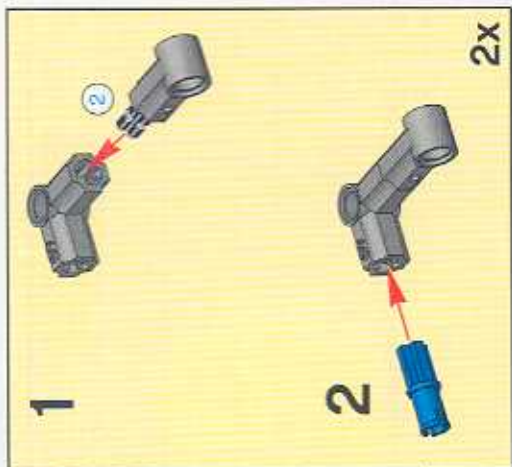

5



4205111

6



1:1

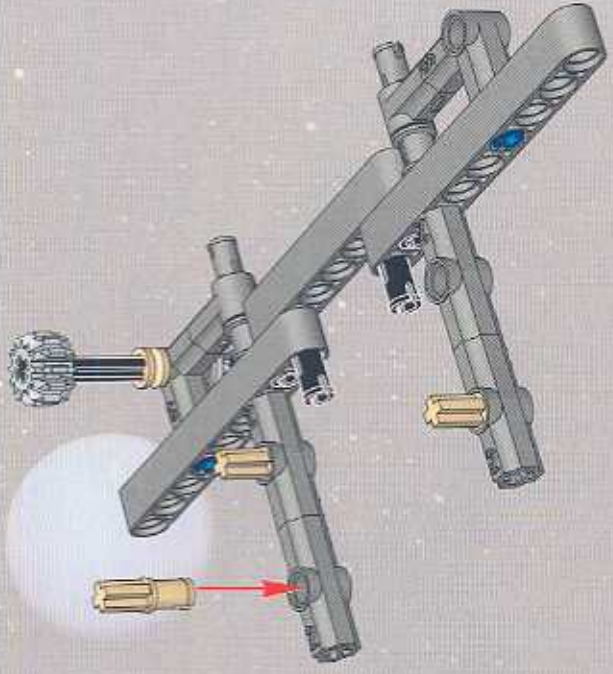

4186017

7

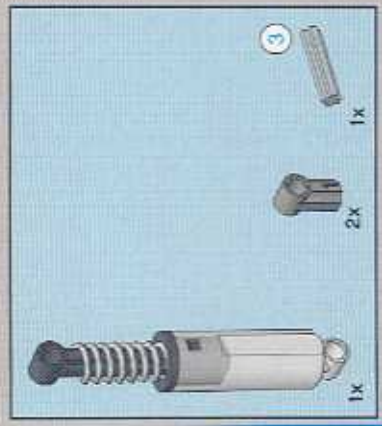

8

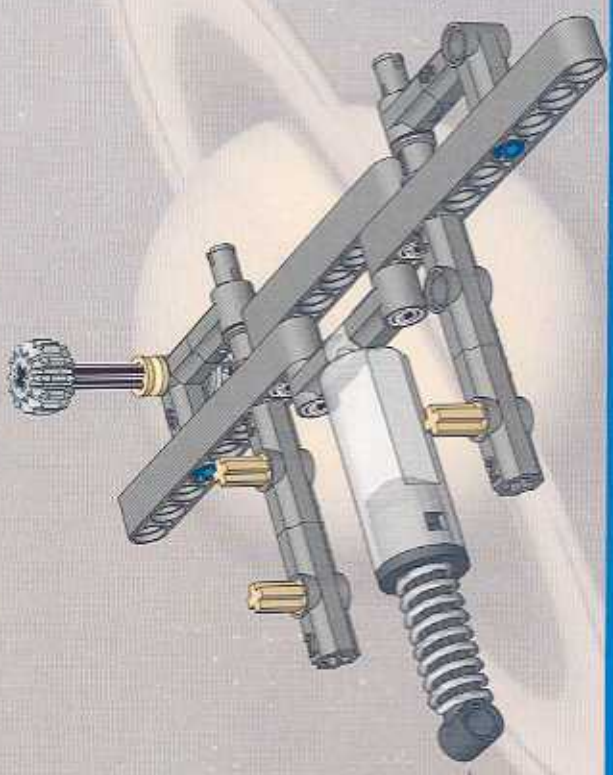
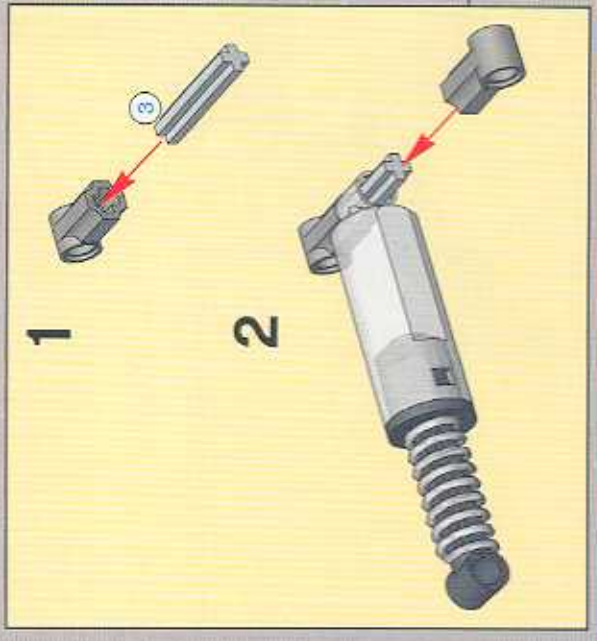

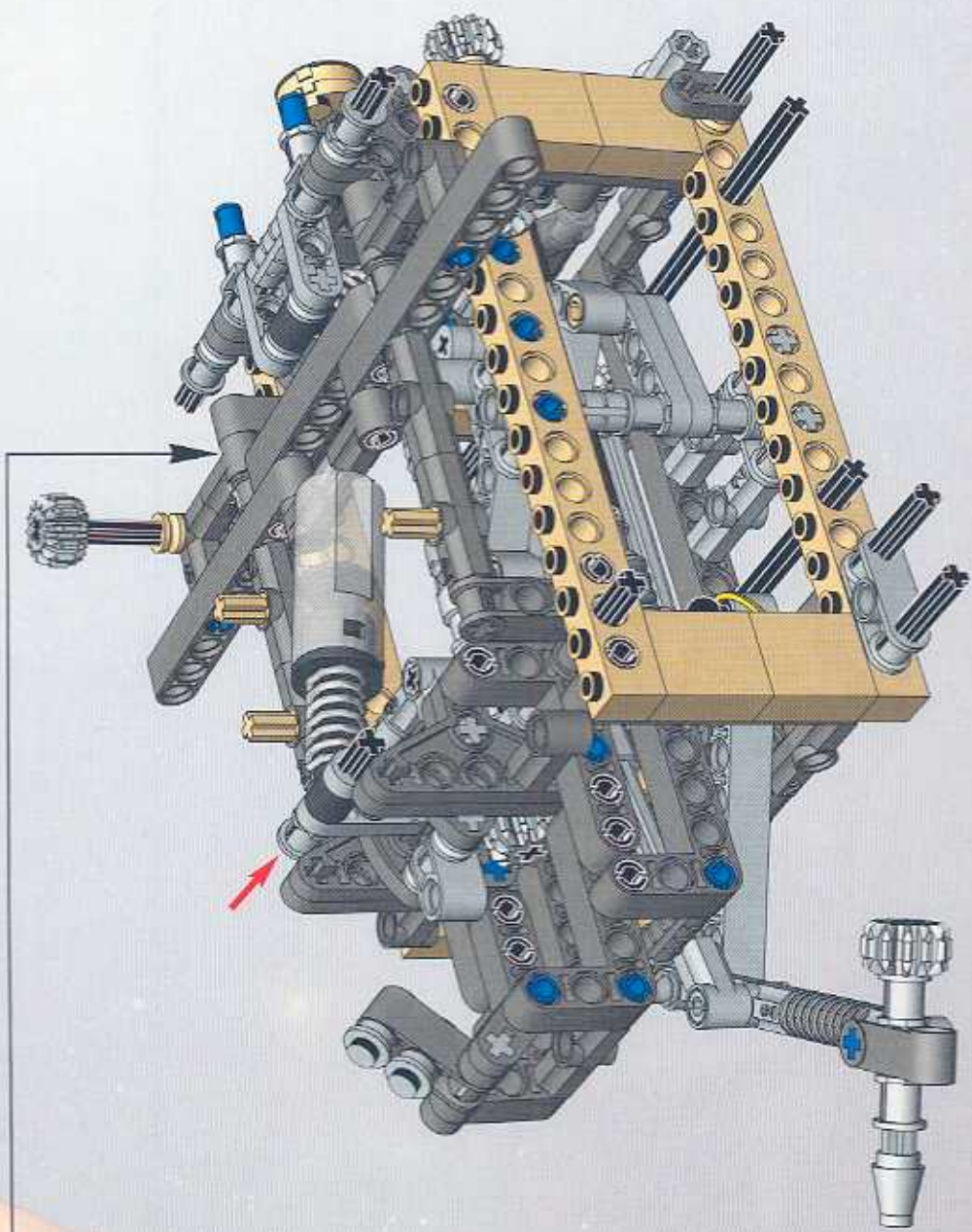



37

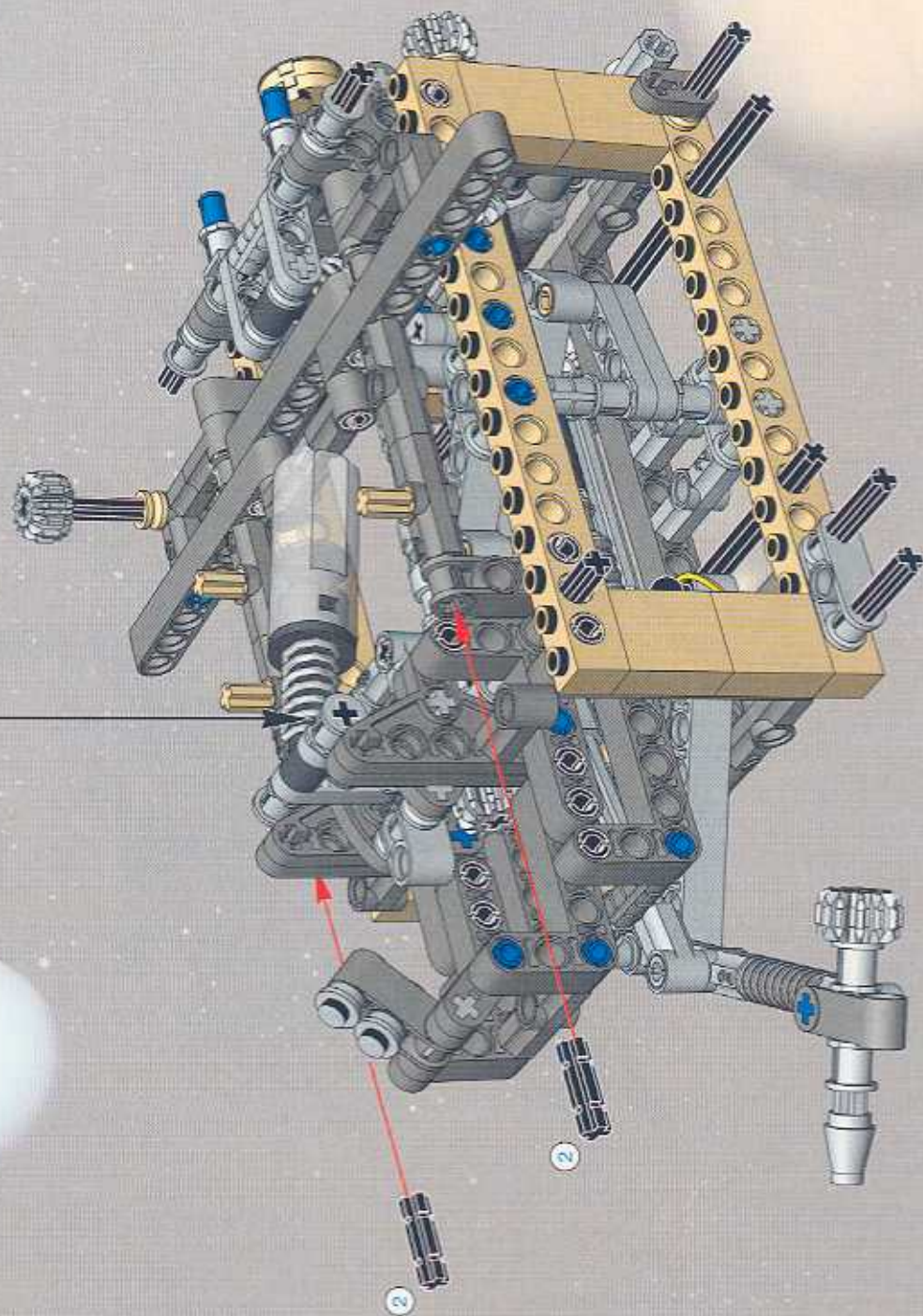

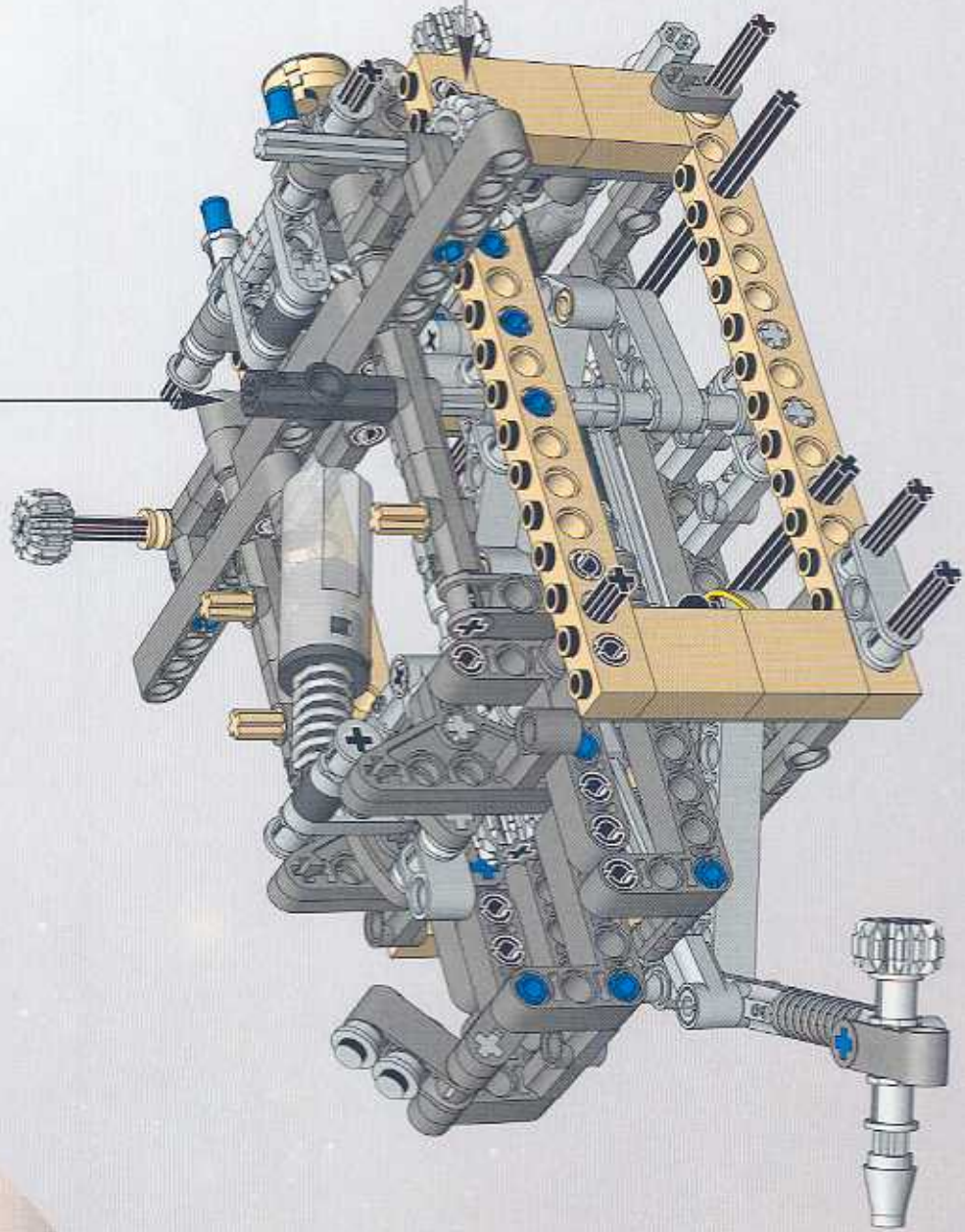
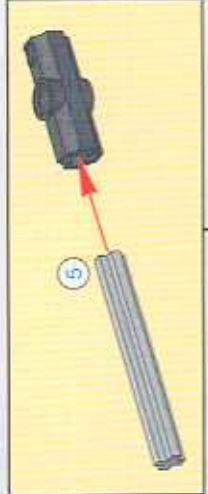
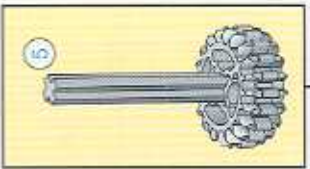

38

4207743



39



1



2

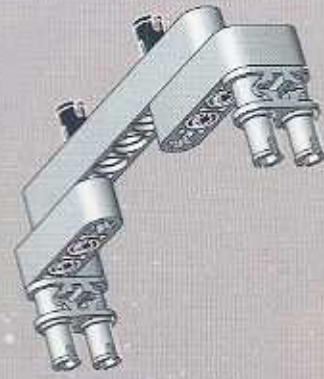

3

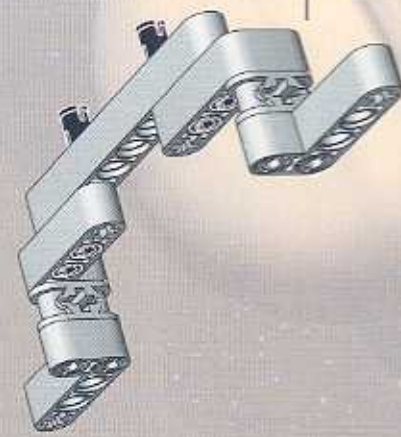

4

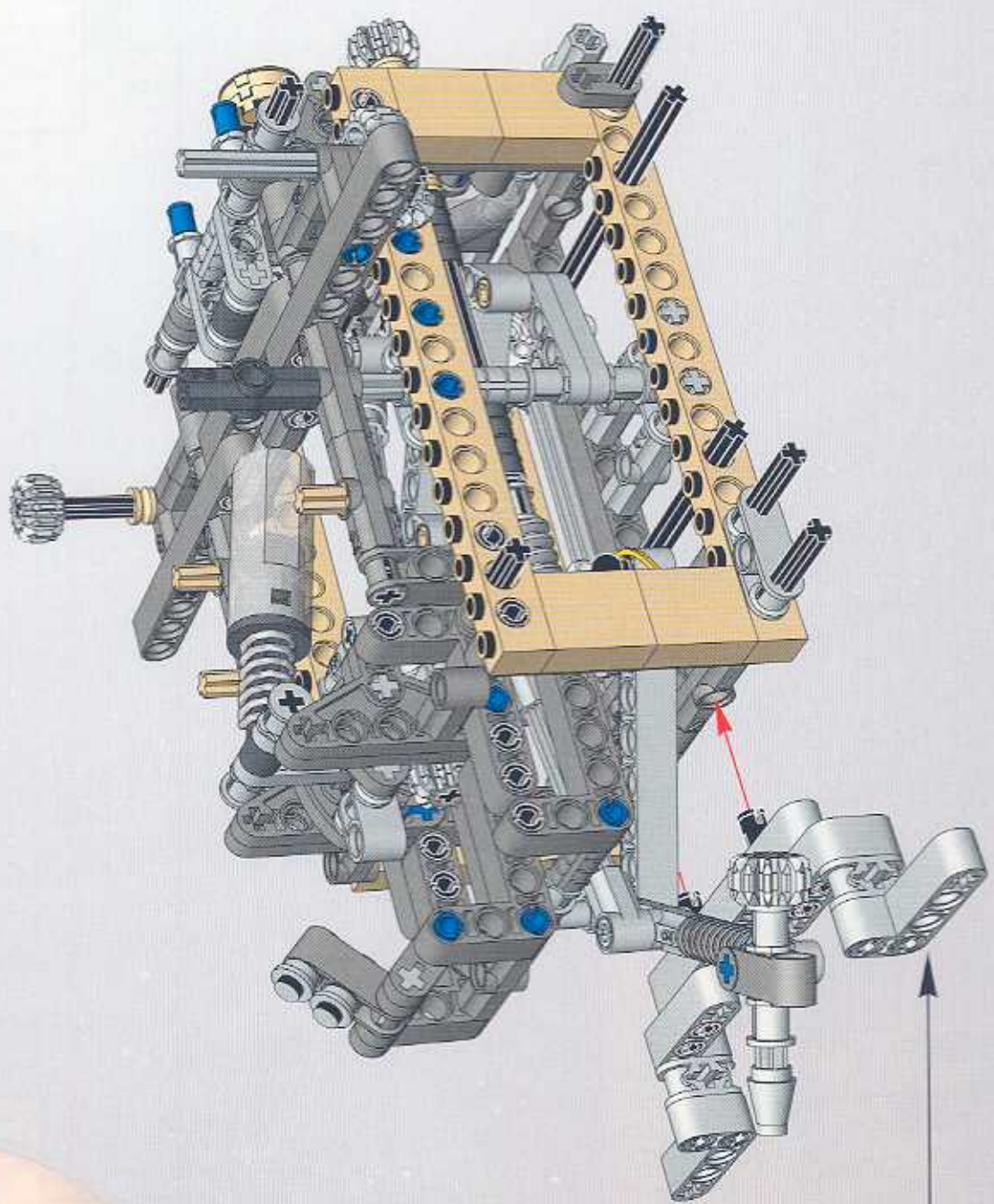

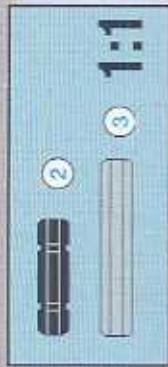
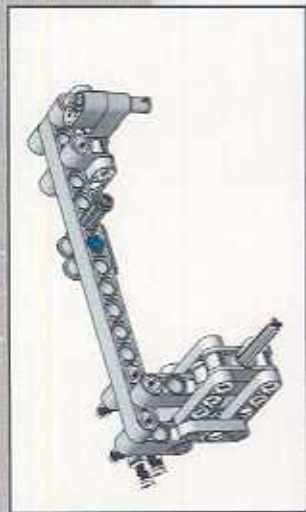

1

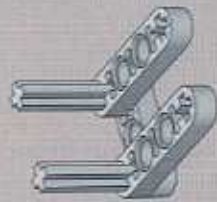

2



3

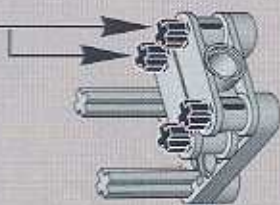
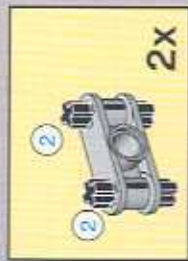

4





5

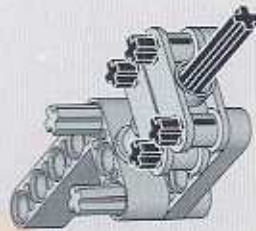

7

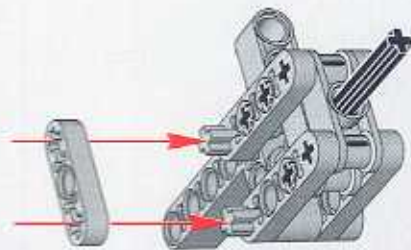

6

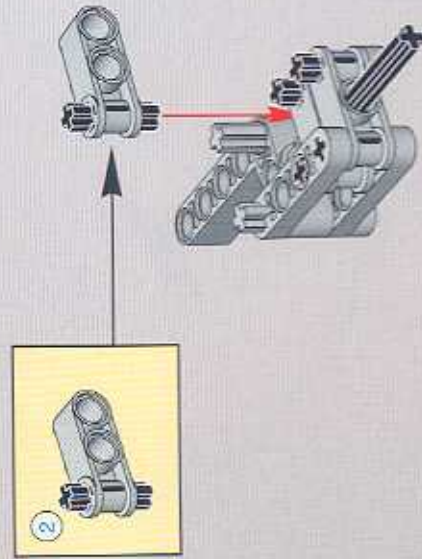

8

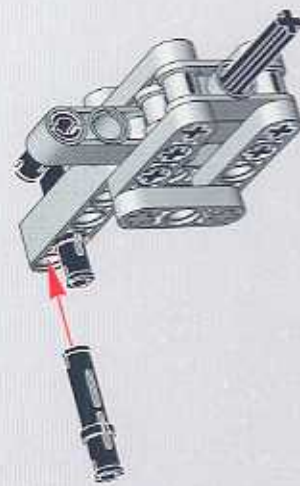



9

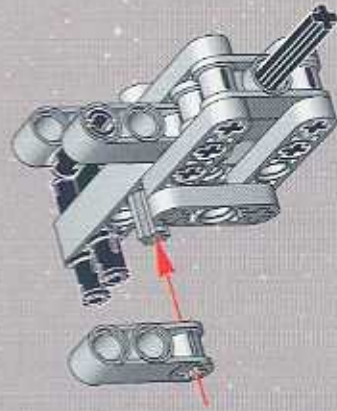

10

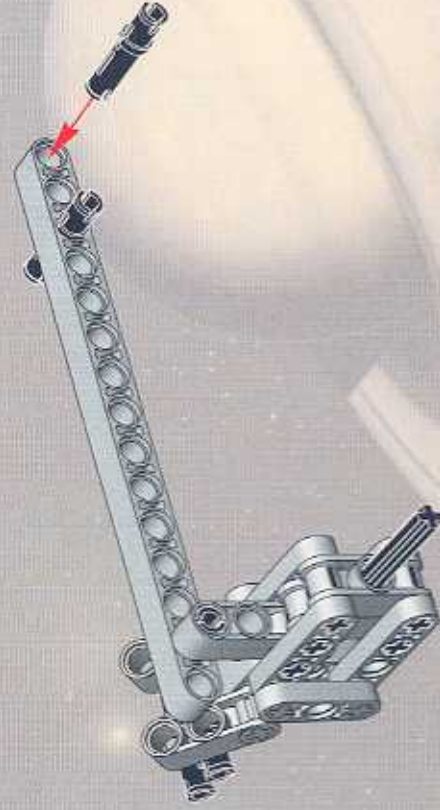

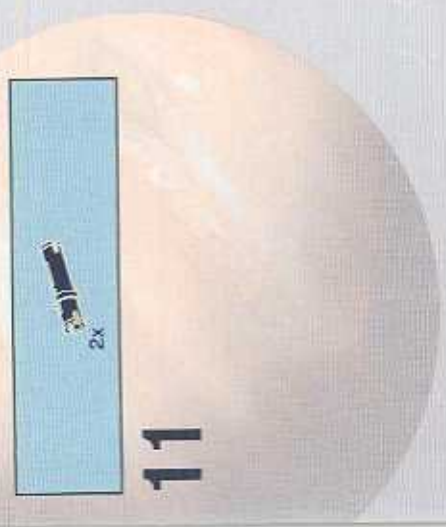
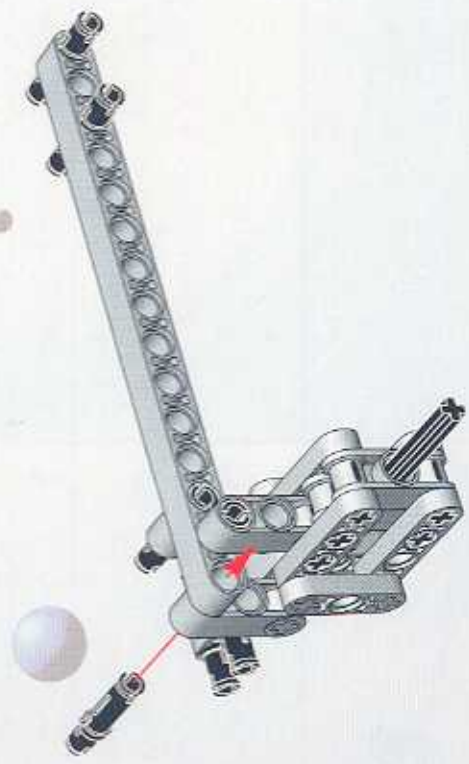

11



4173667

4195303

4107825

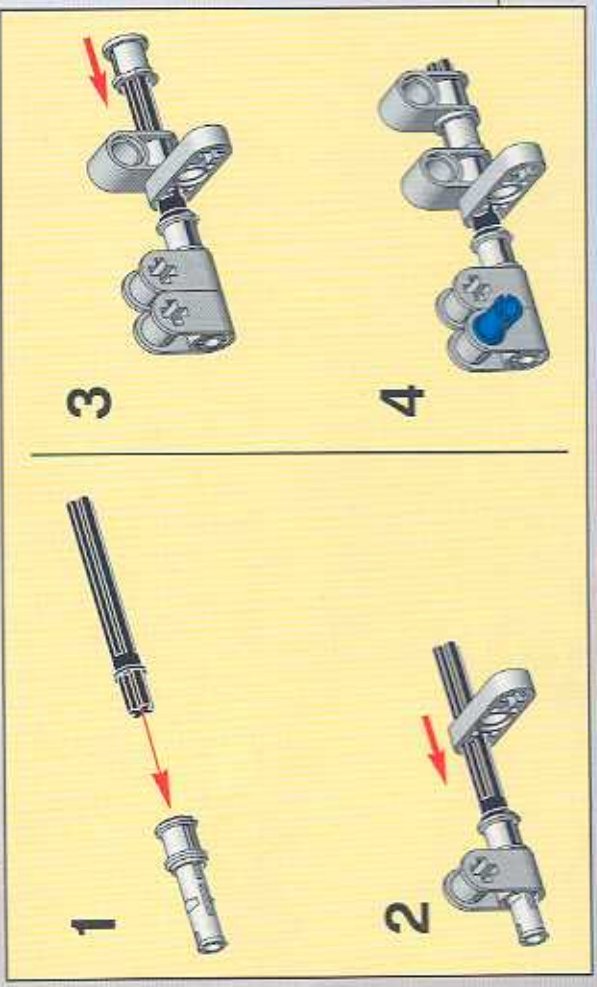

3

4

1

2

12

4195272



13

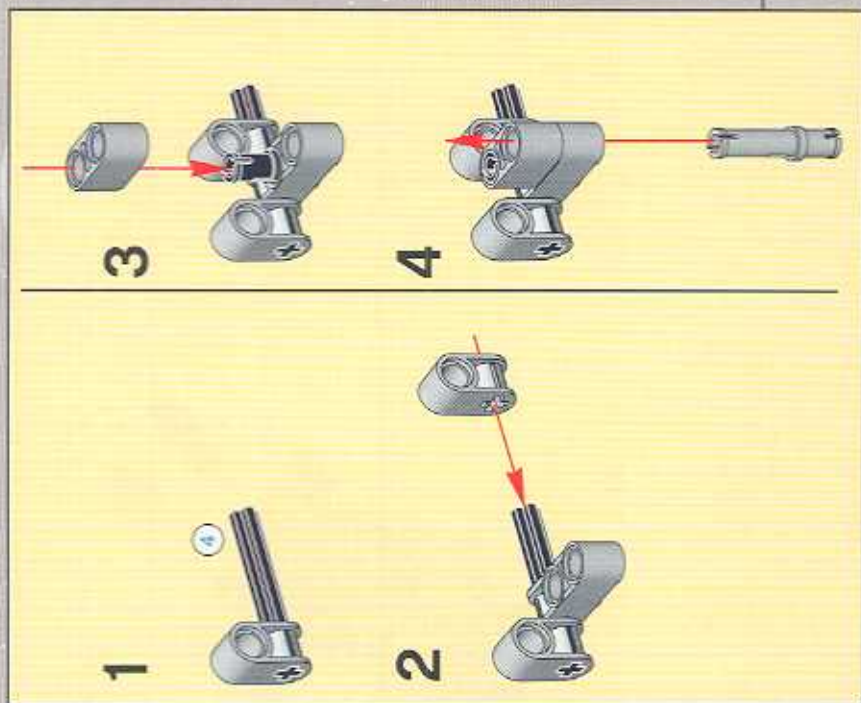

1:1



14

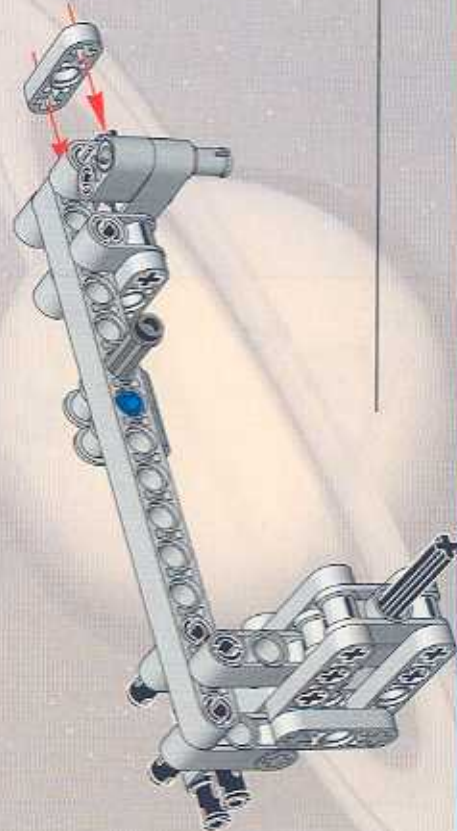

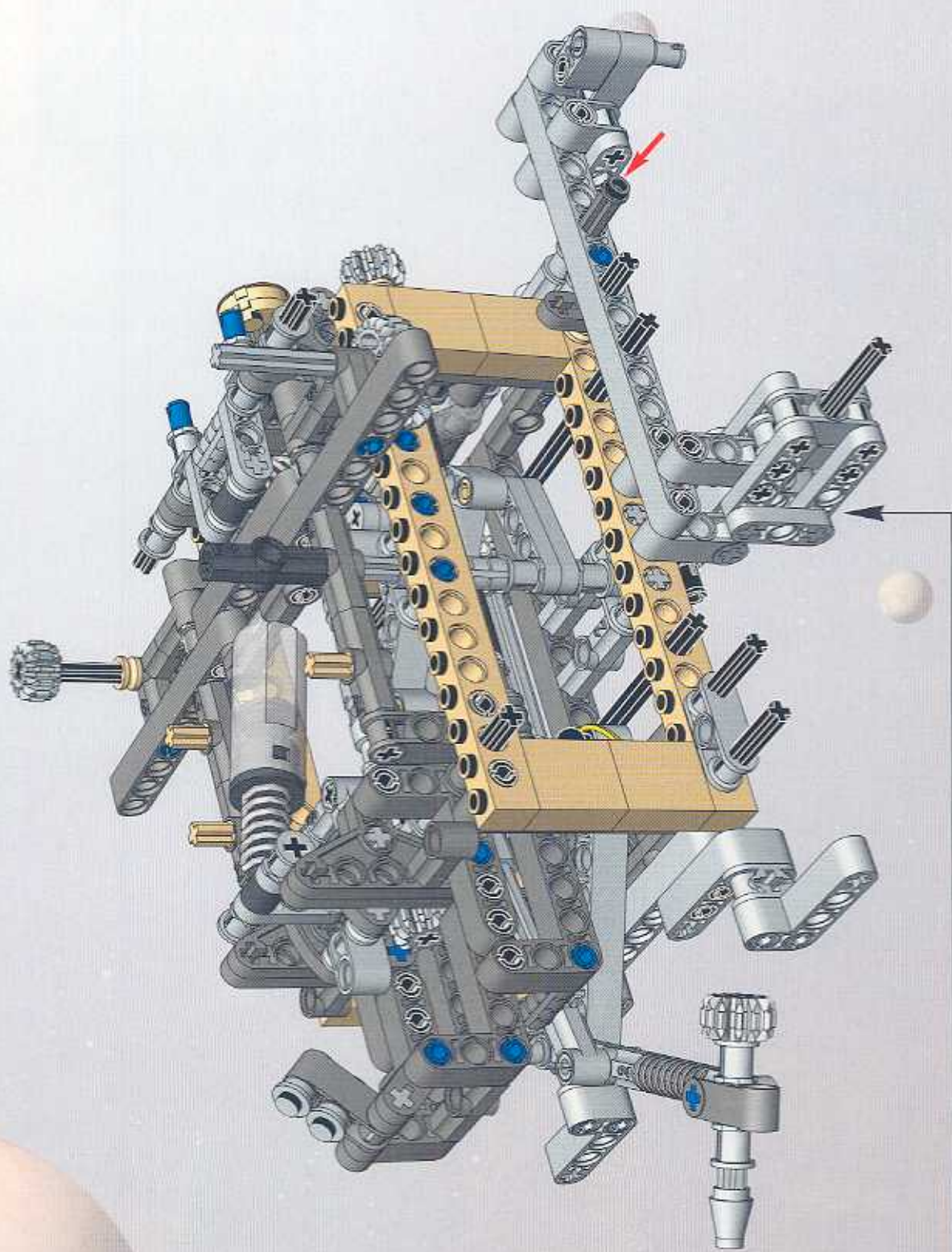

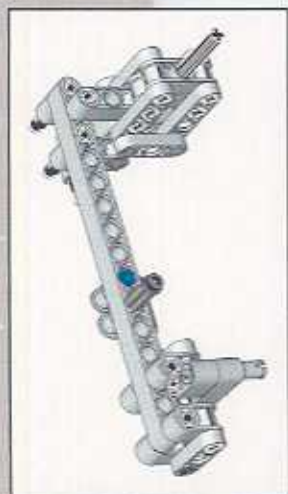

1

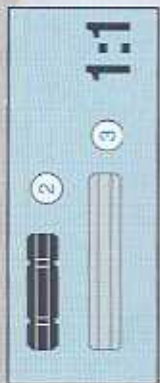

2



3

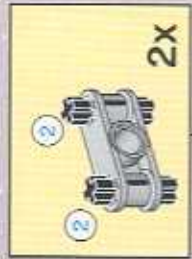

4

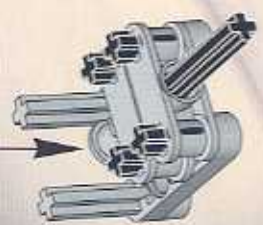



5

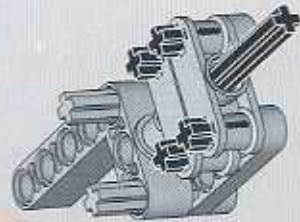

7

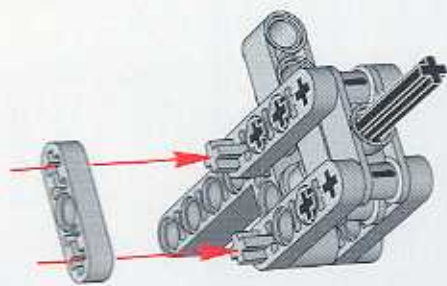

6

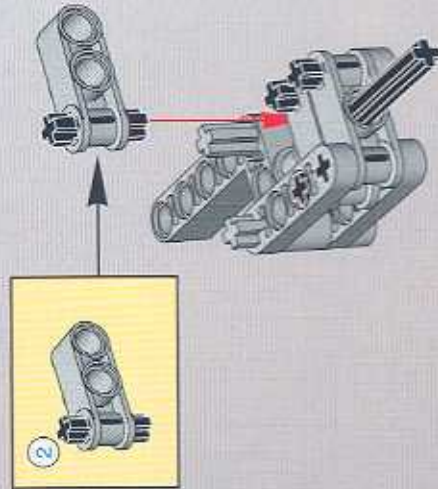

8





9

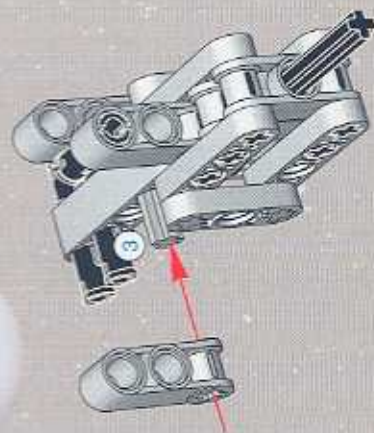

10

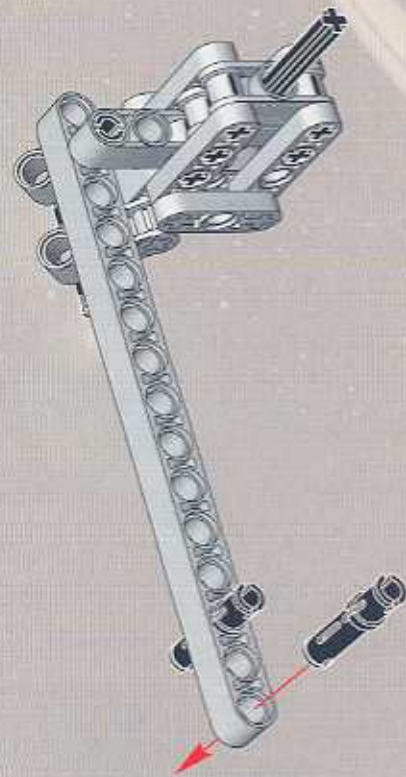



11

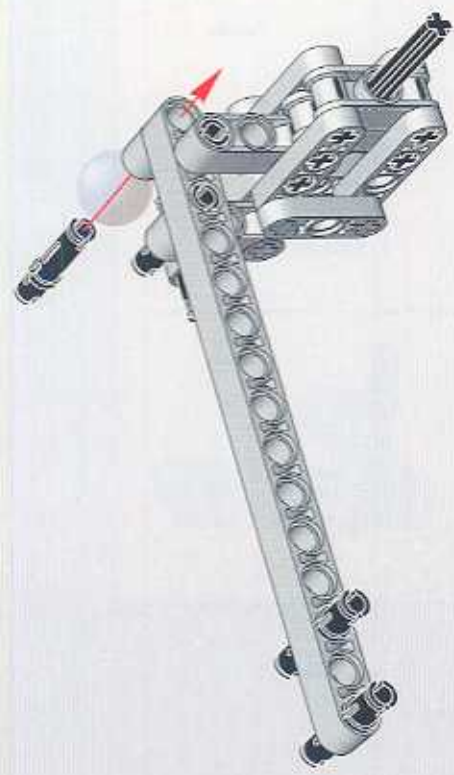

12

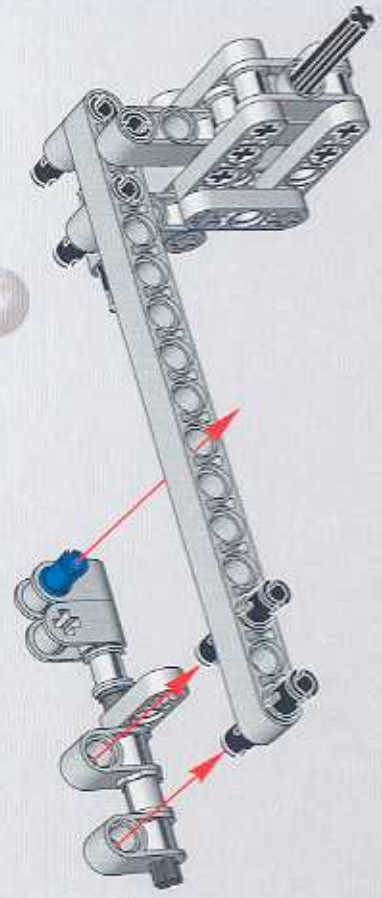
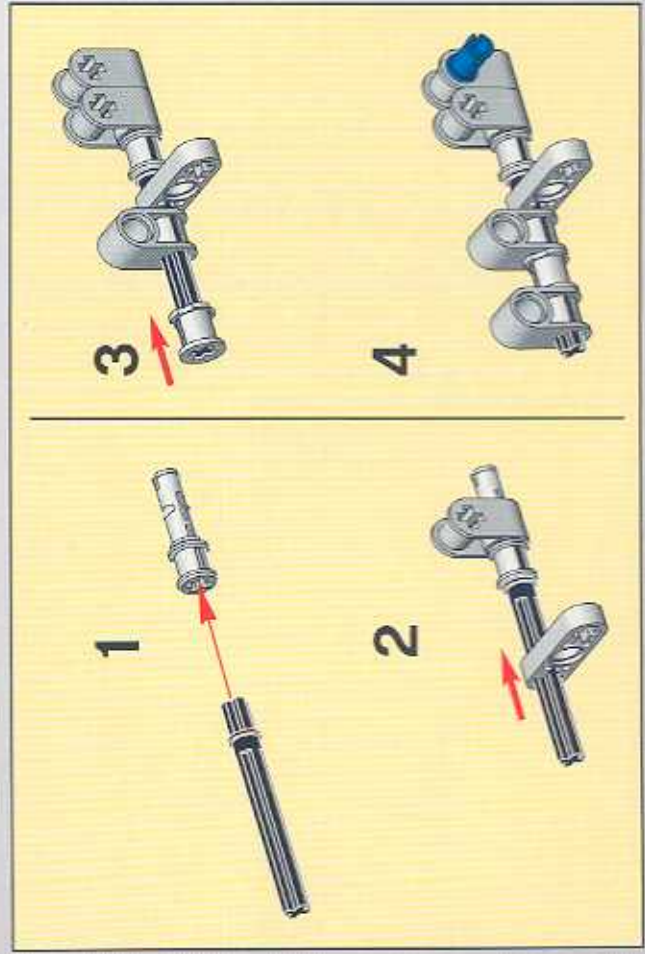



13

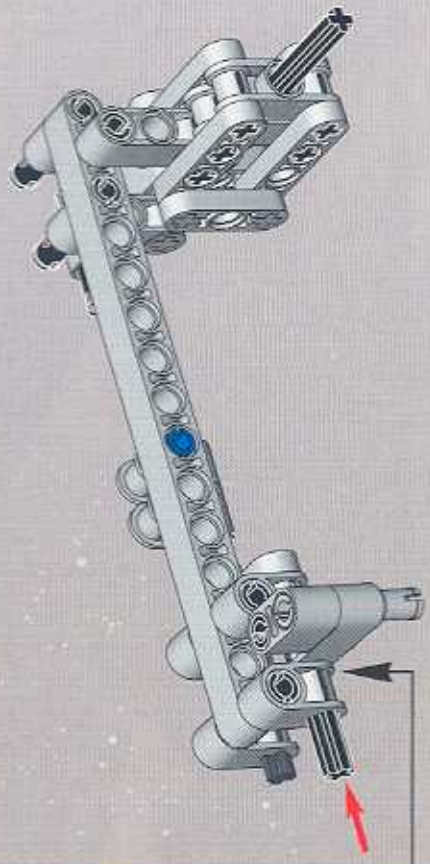
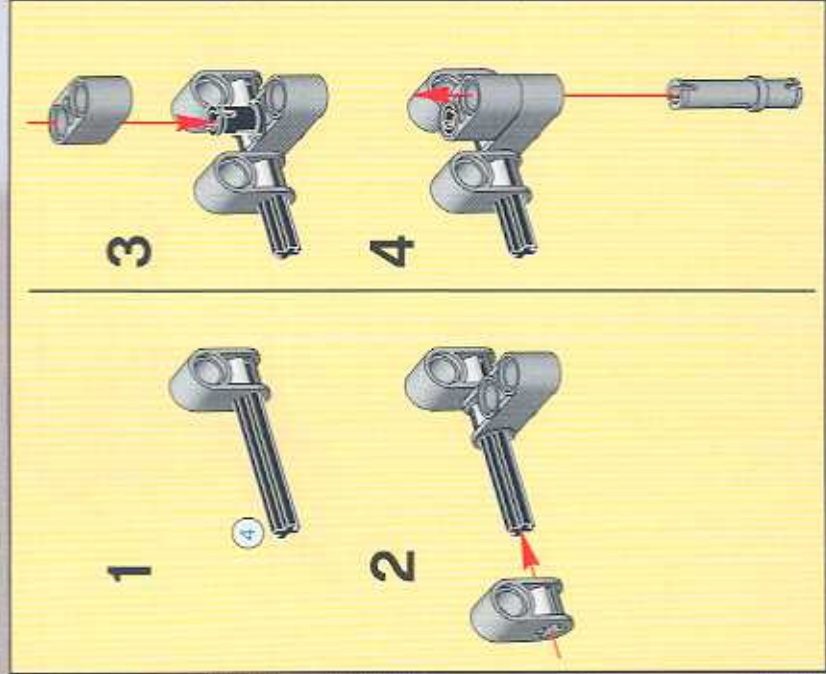

4113884

14



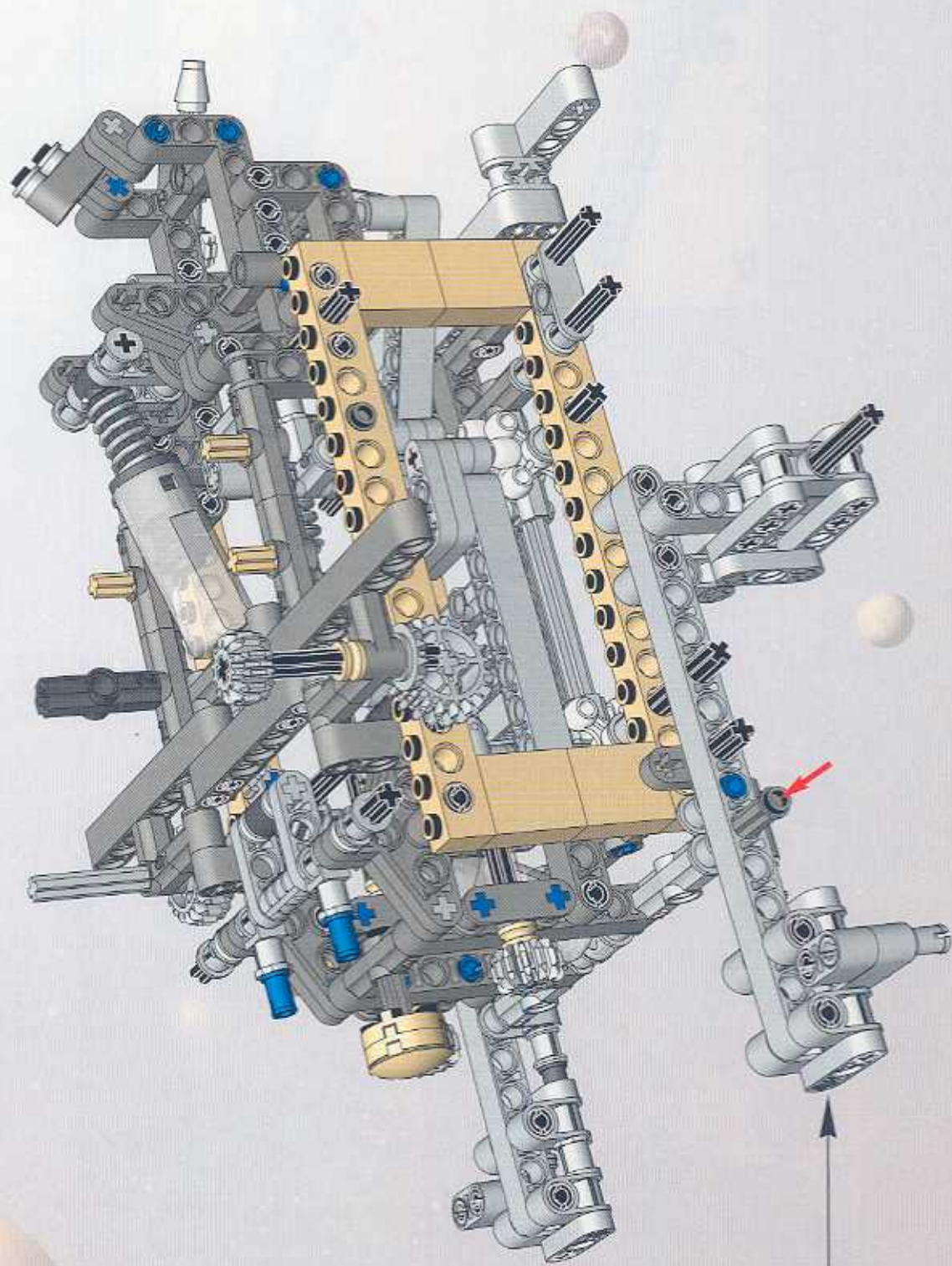

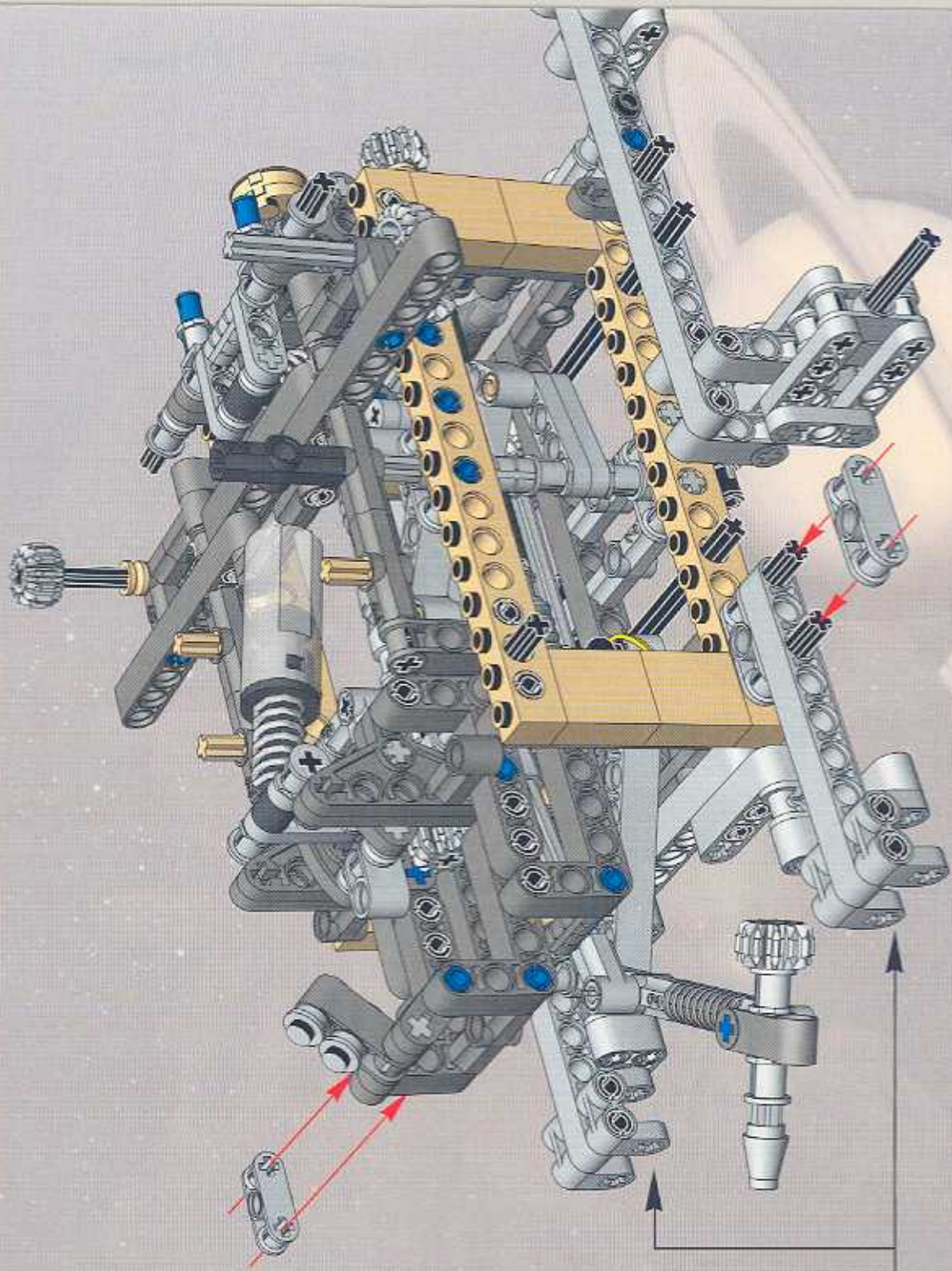

4208067

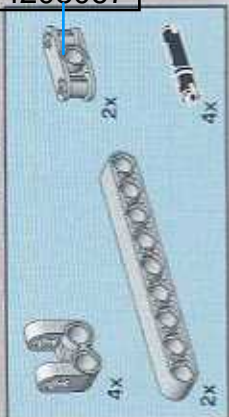

42

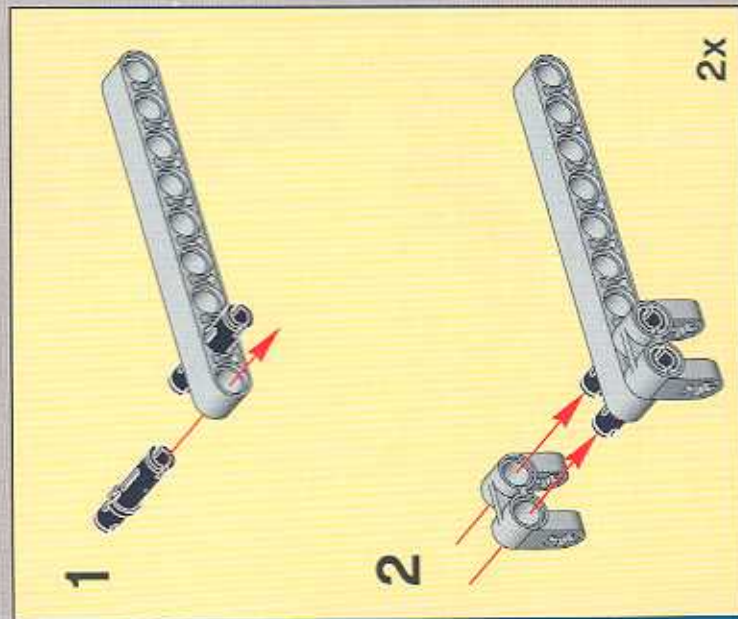

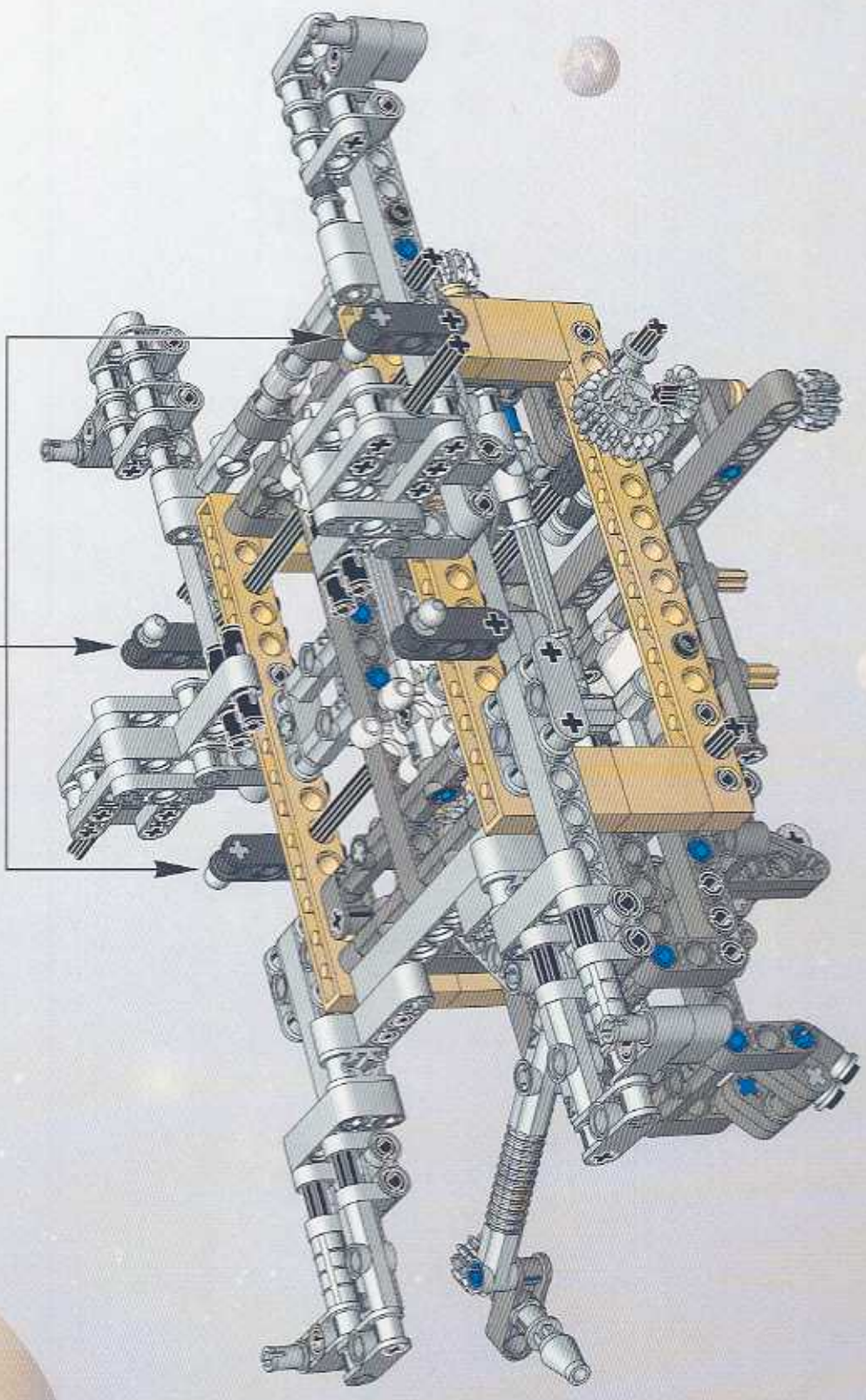

273602



45

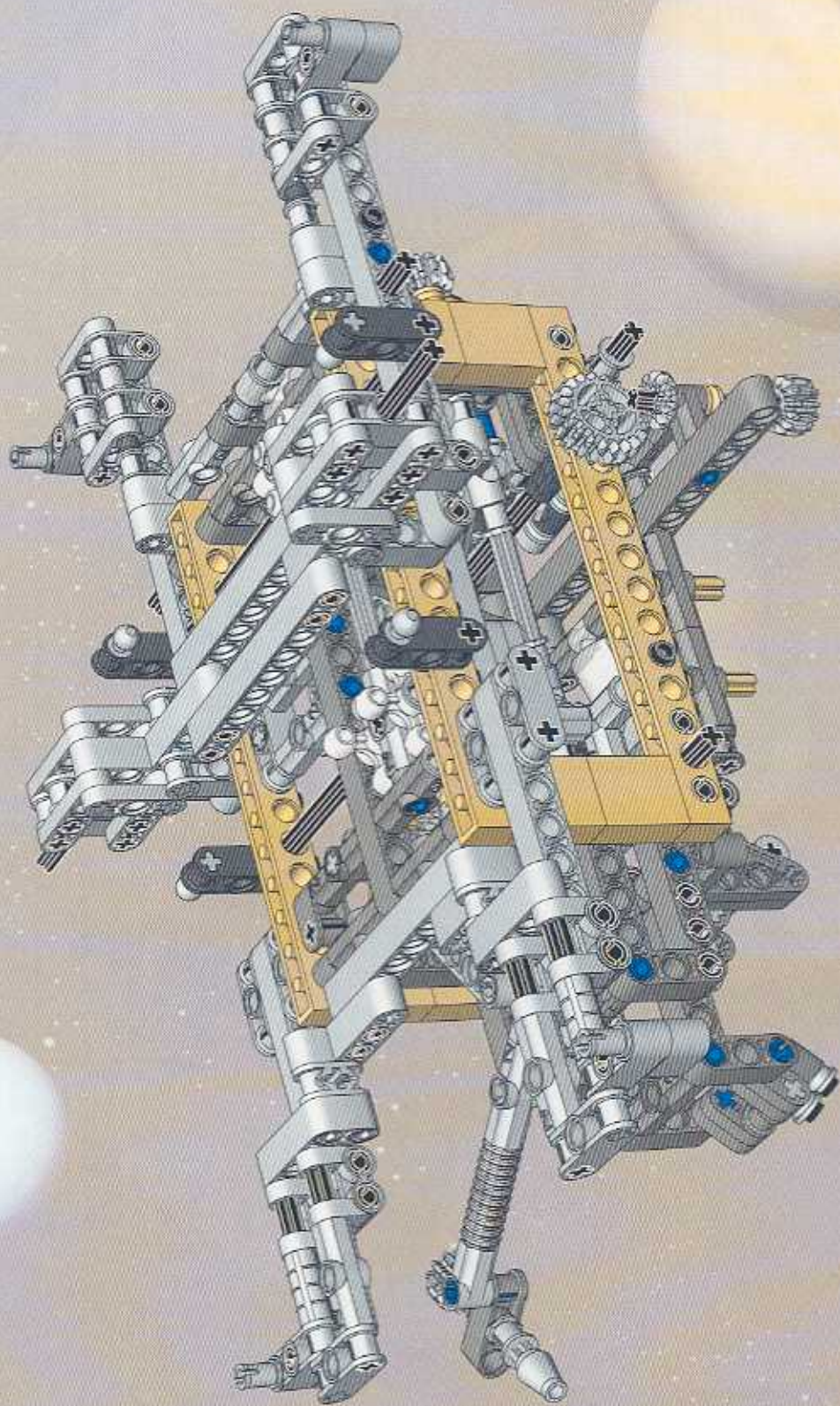
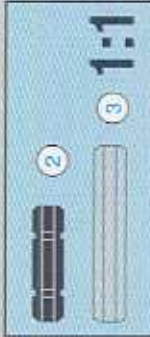

46



47

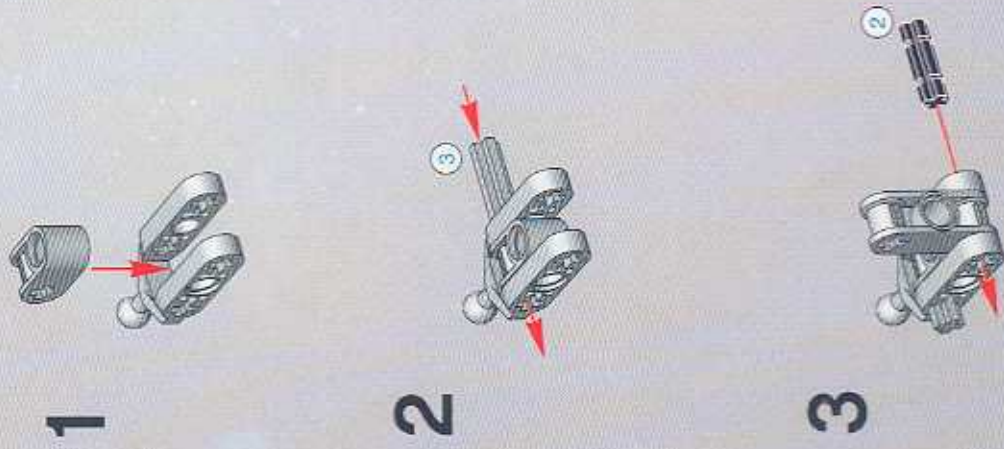

4



5

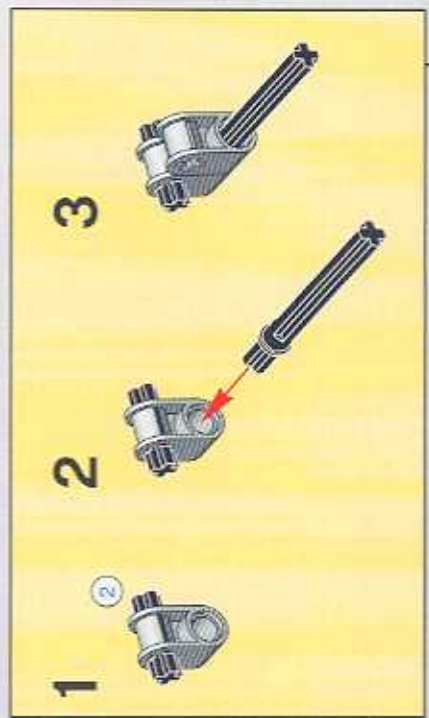
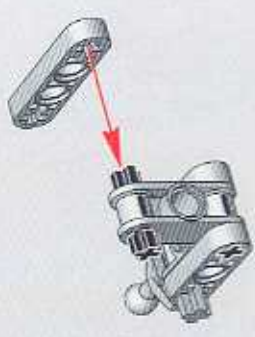

6

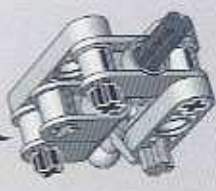

7



8

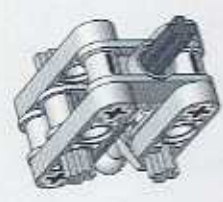

9

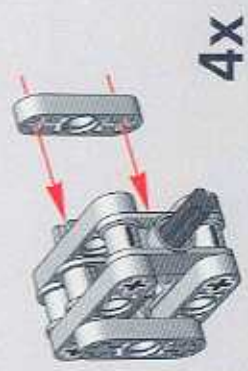

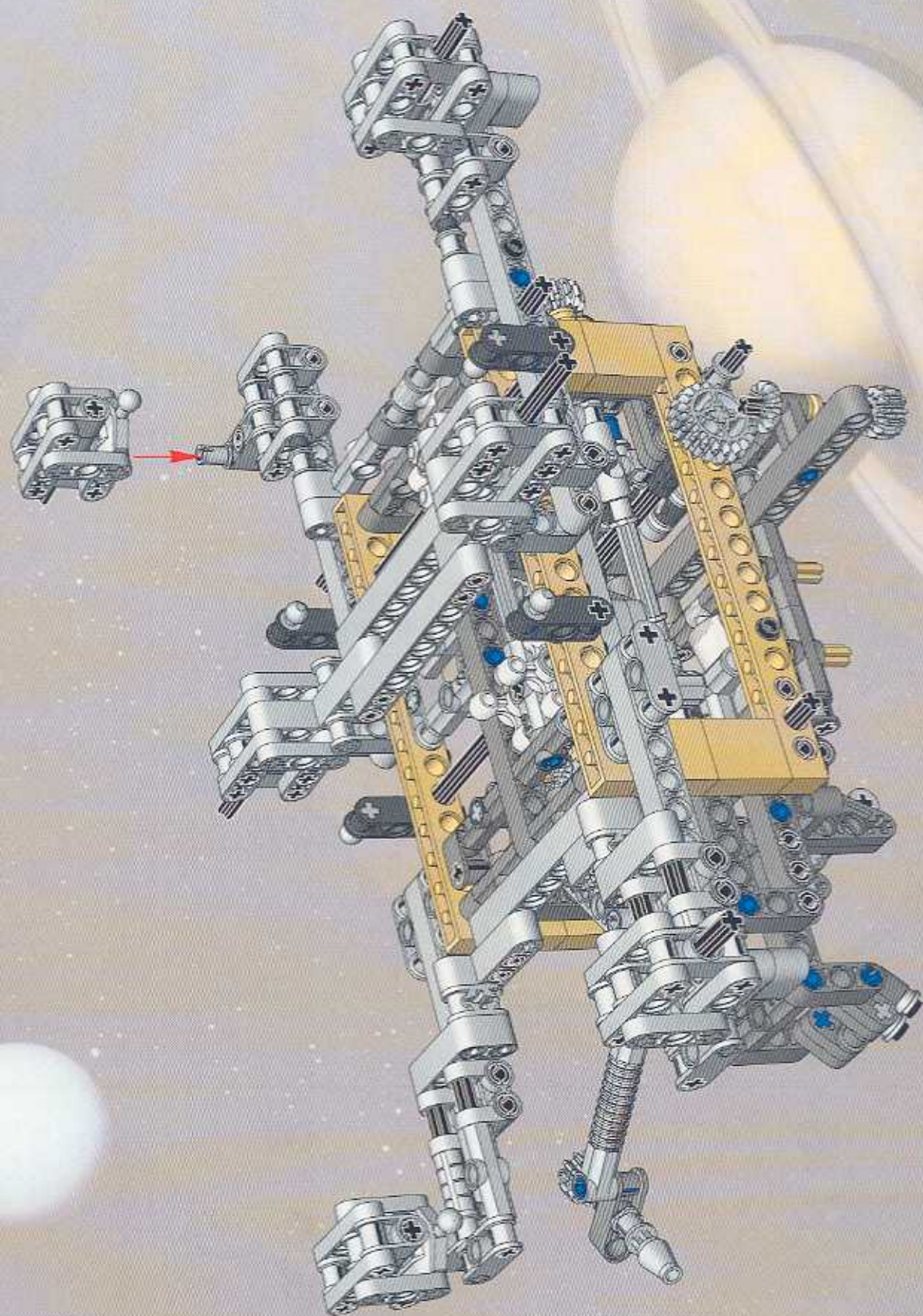

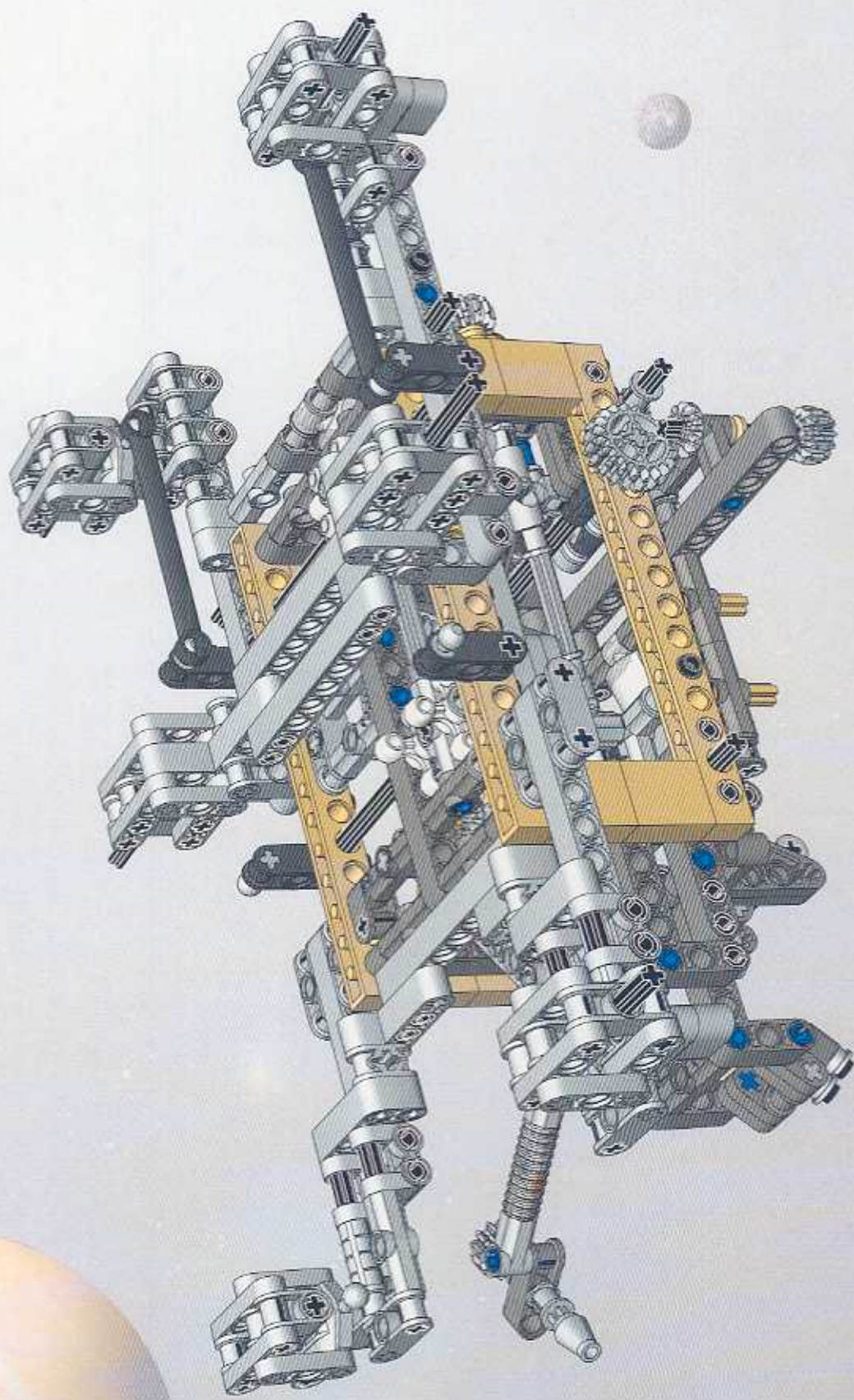

4141300



2x

48



664426

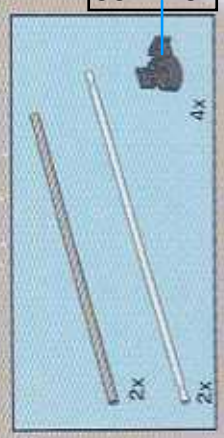

49

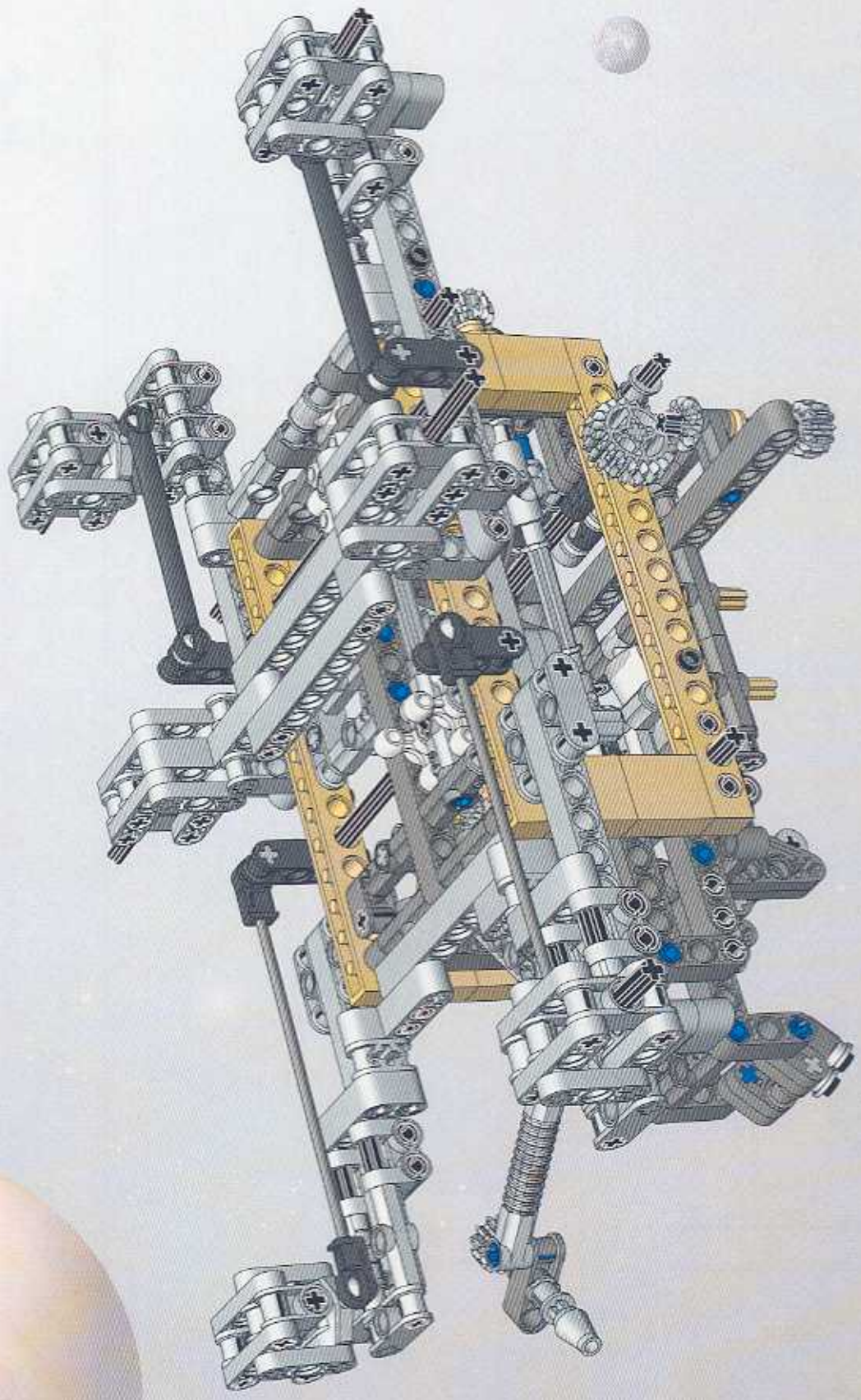

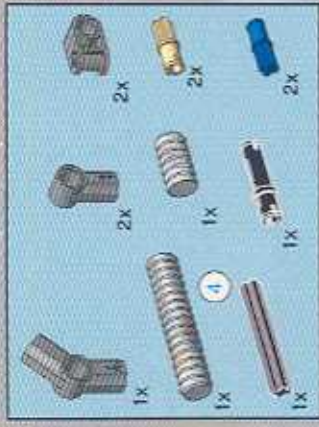

50



4

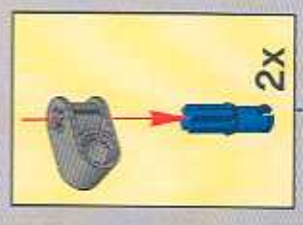
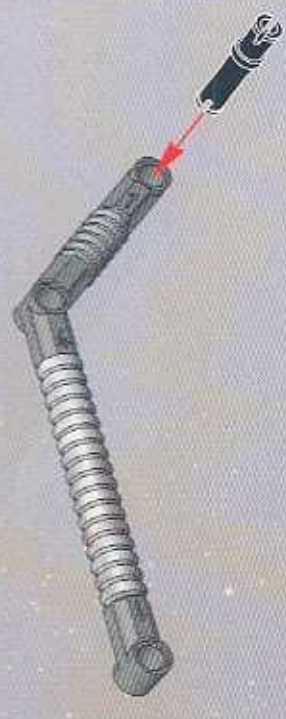

5

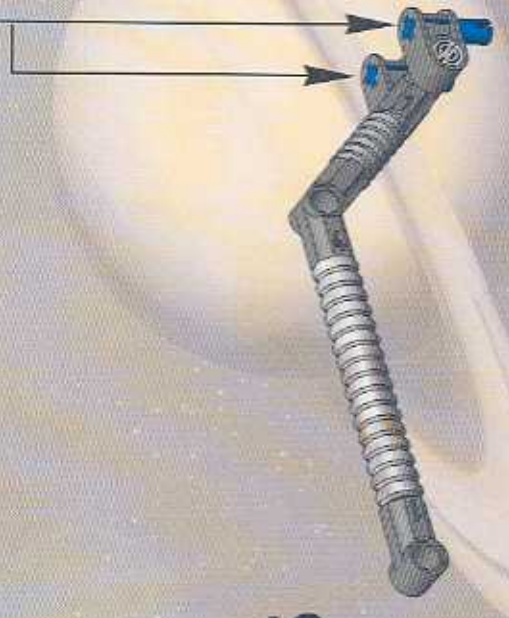

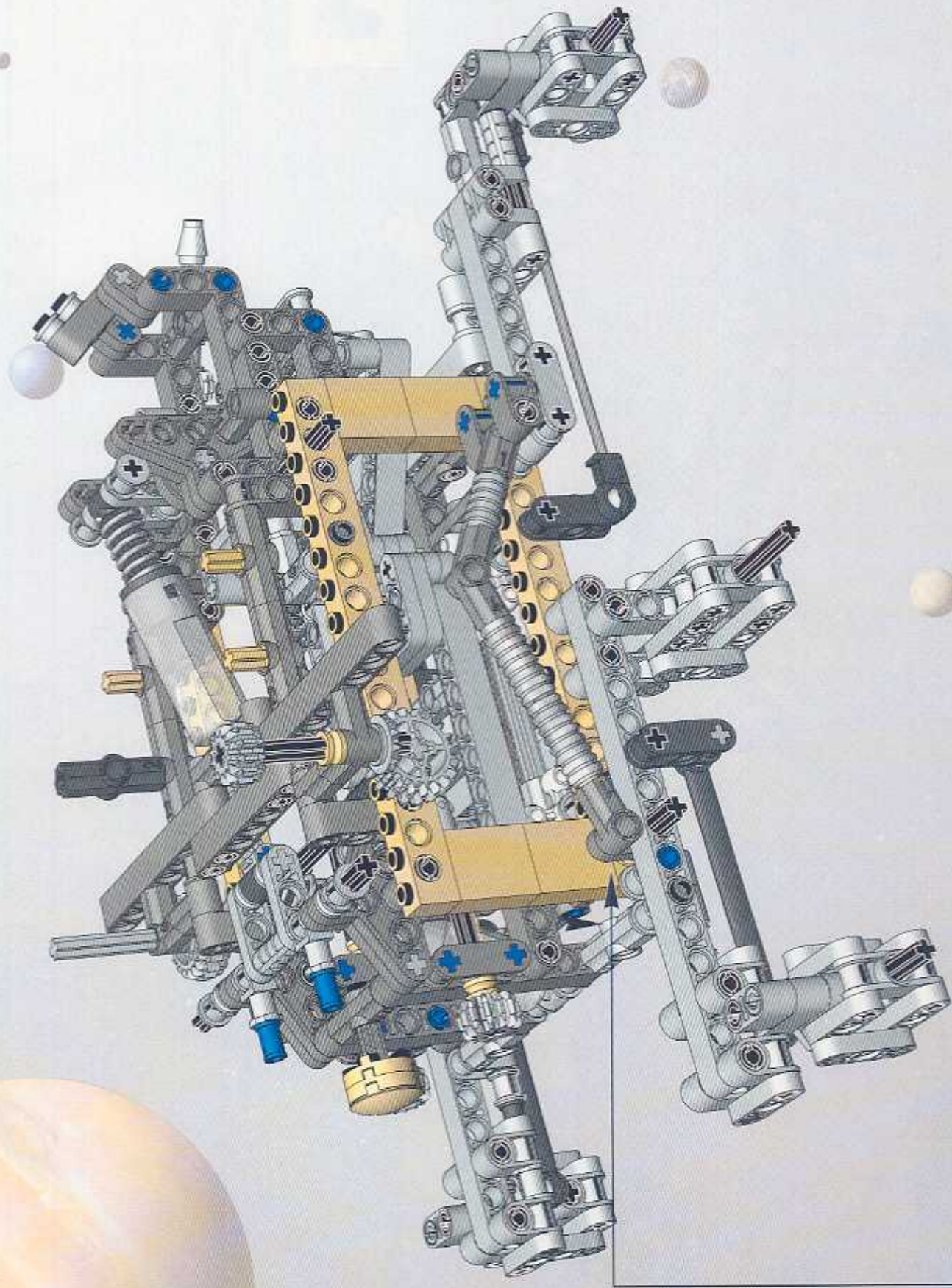



51



4

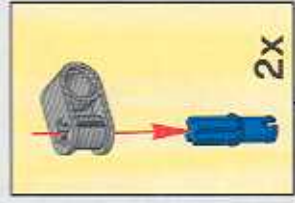
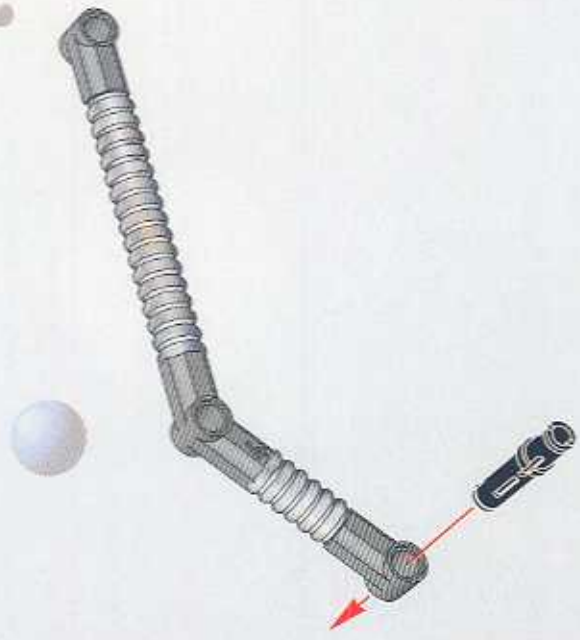

5

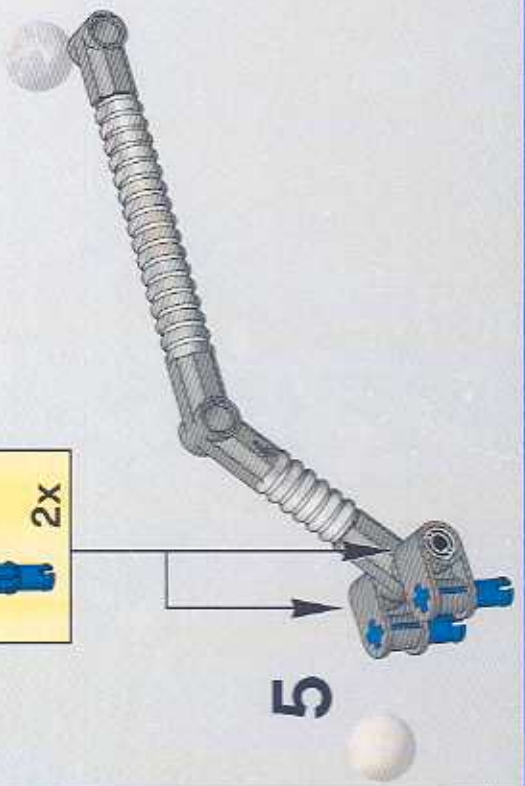

1

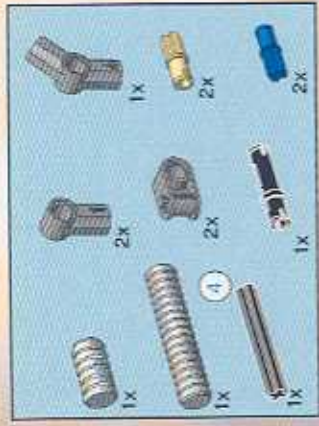

52

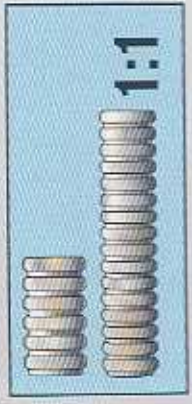

2

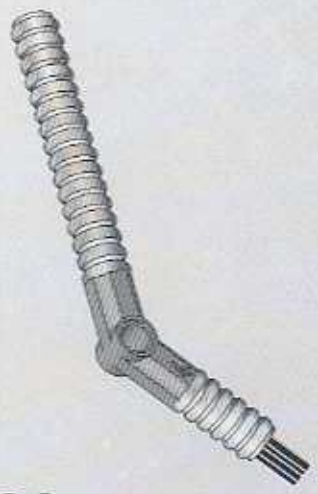

3

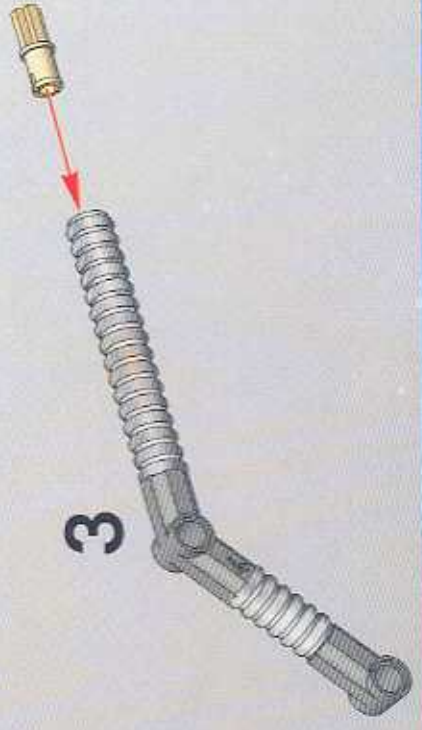



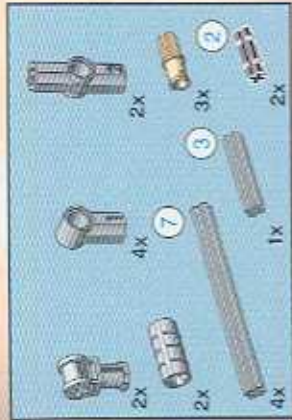

55

1



2

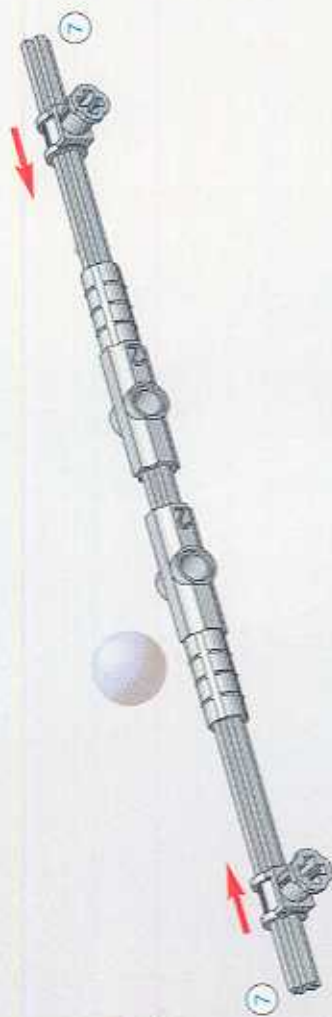
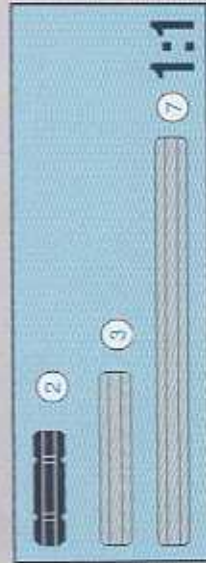
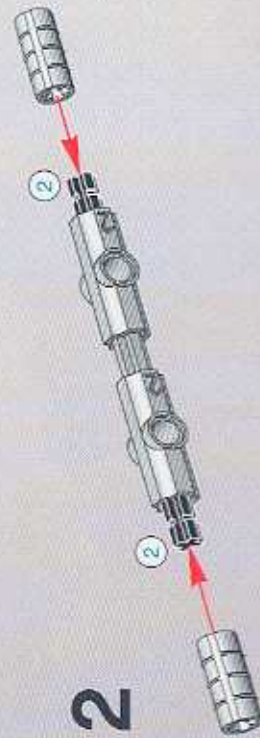

3

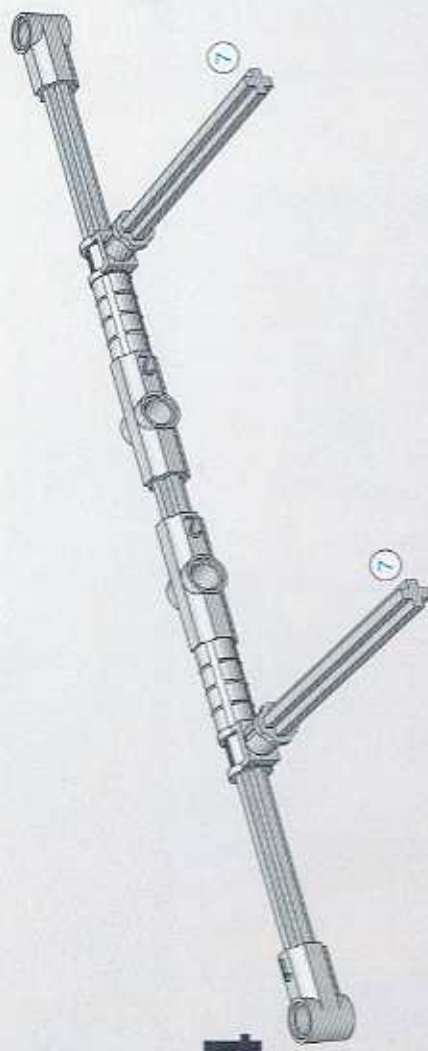

4

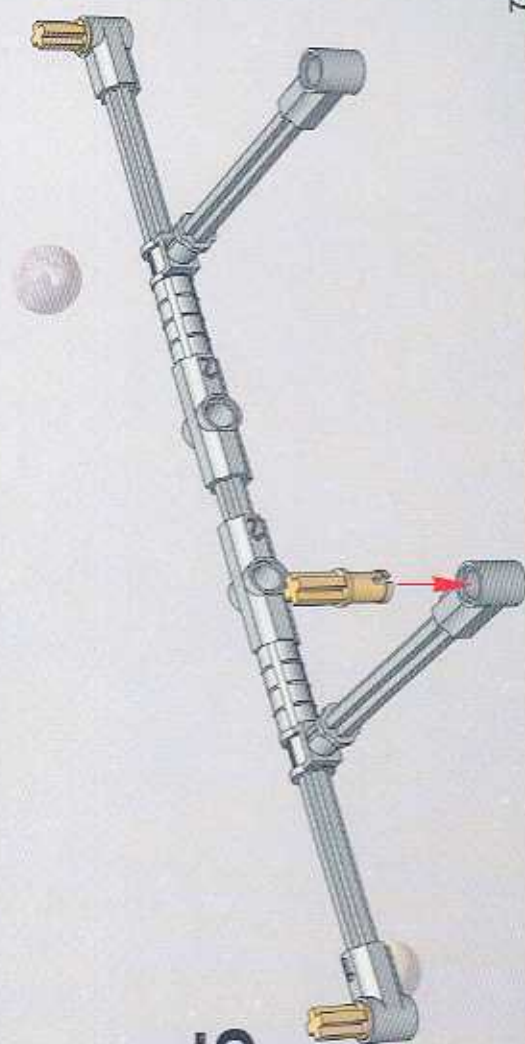

5

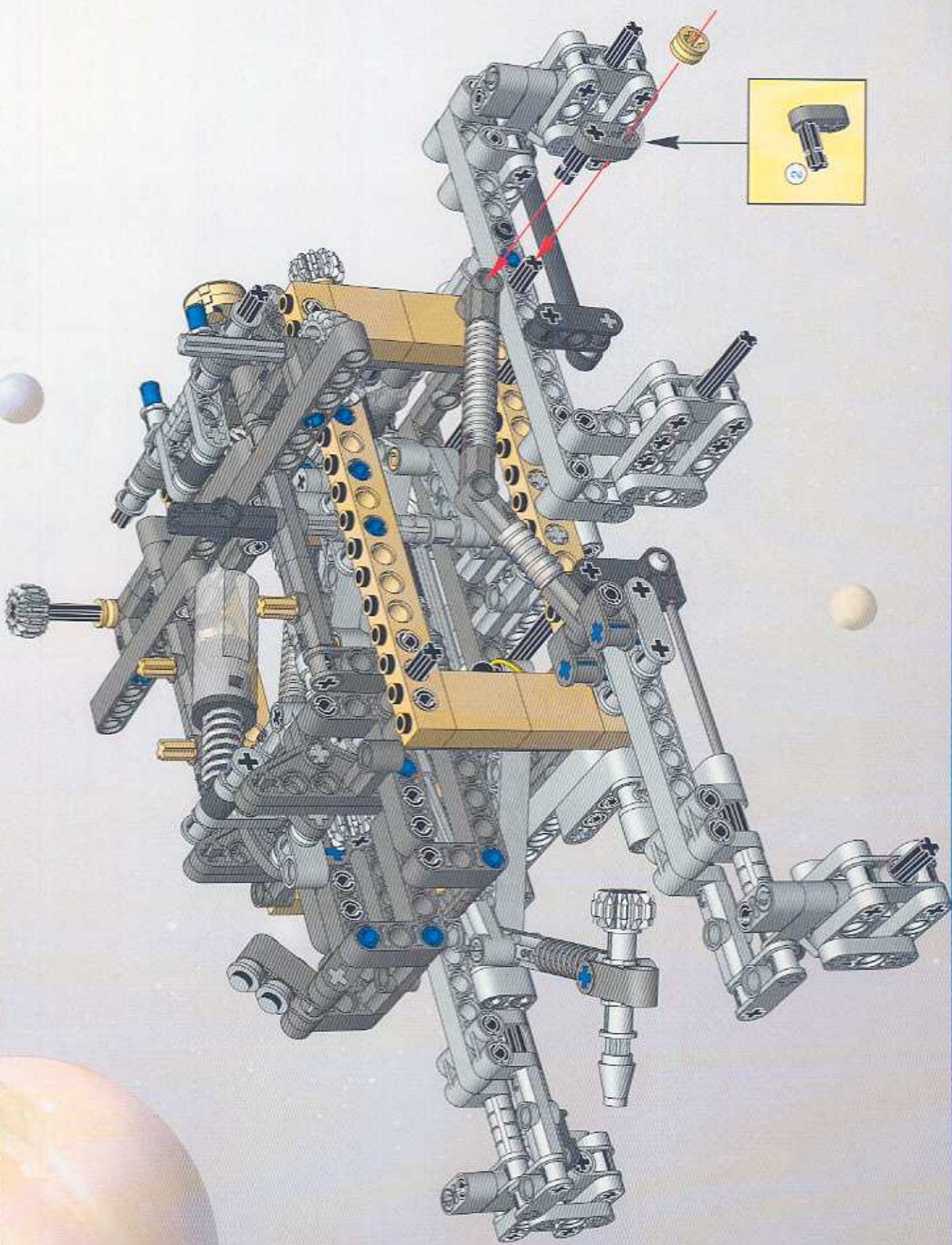

1:1



53

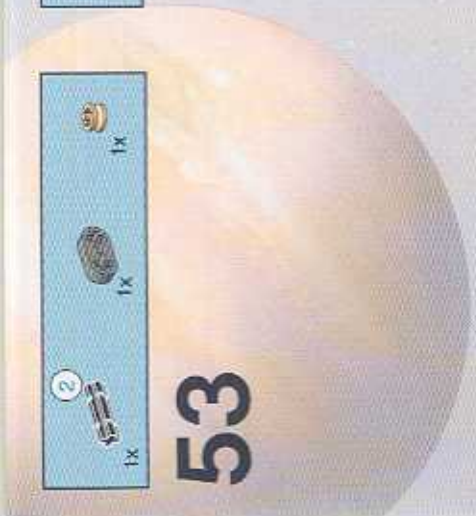



54

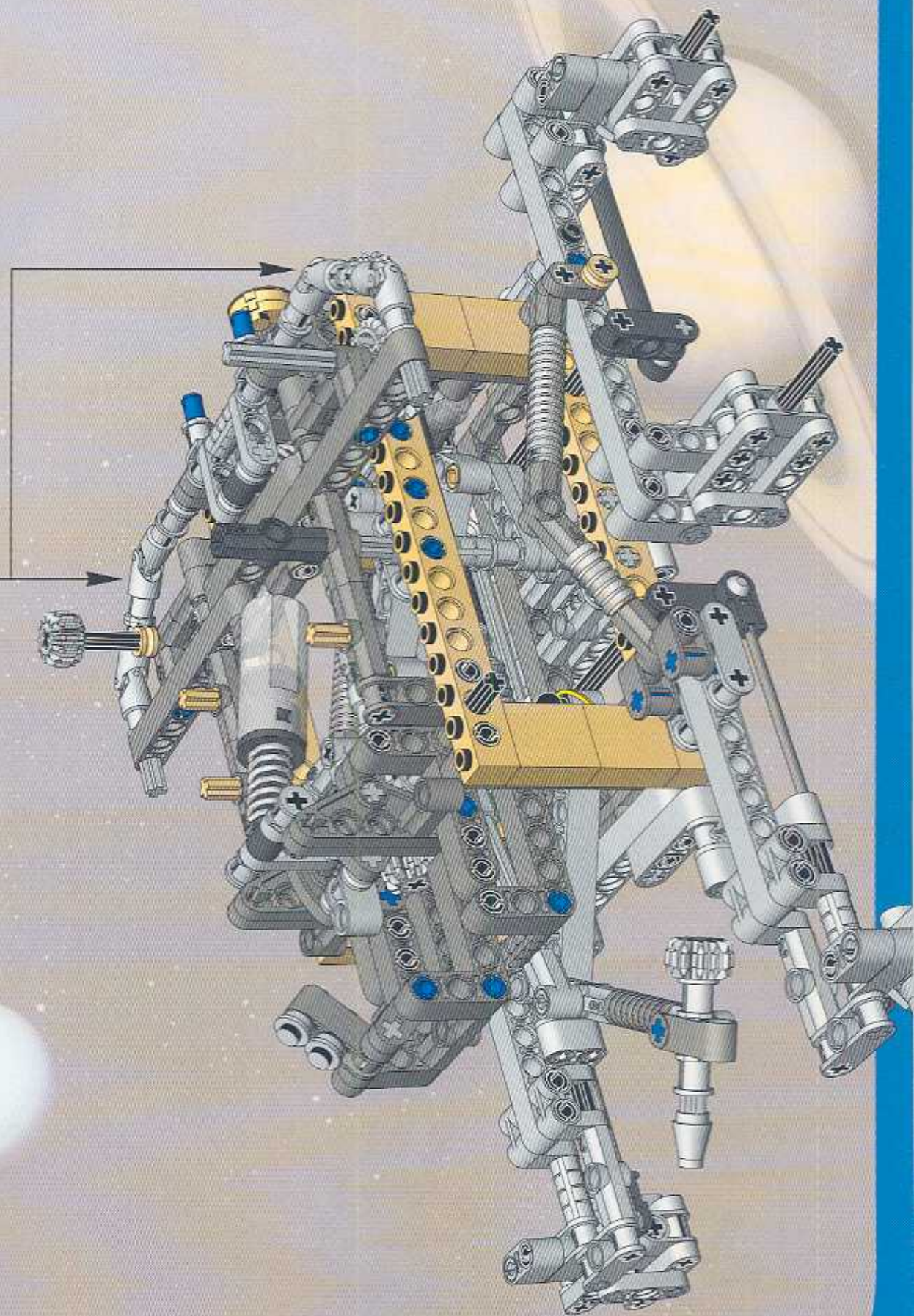
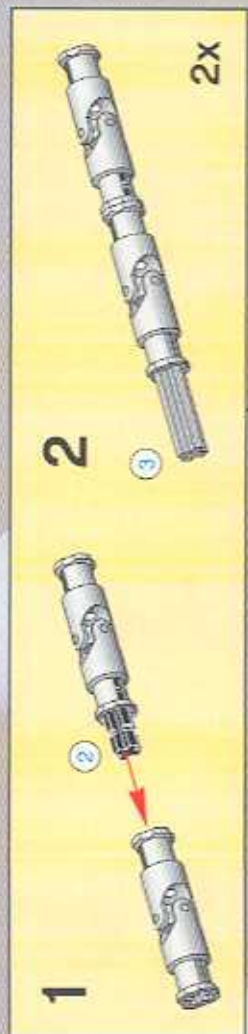

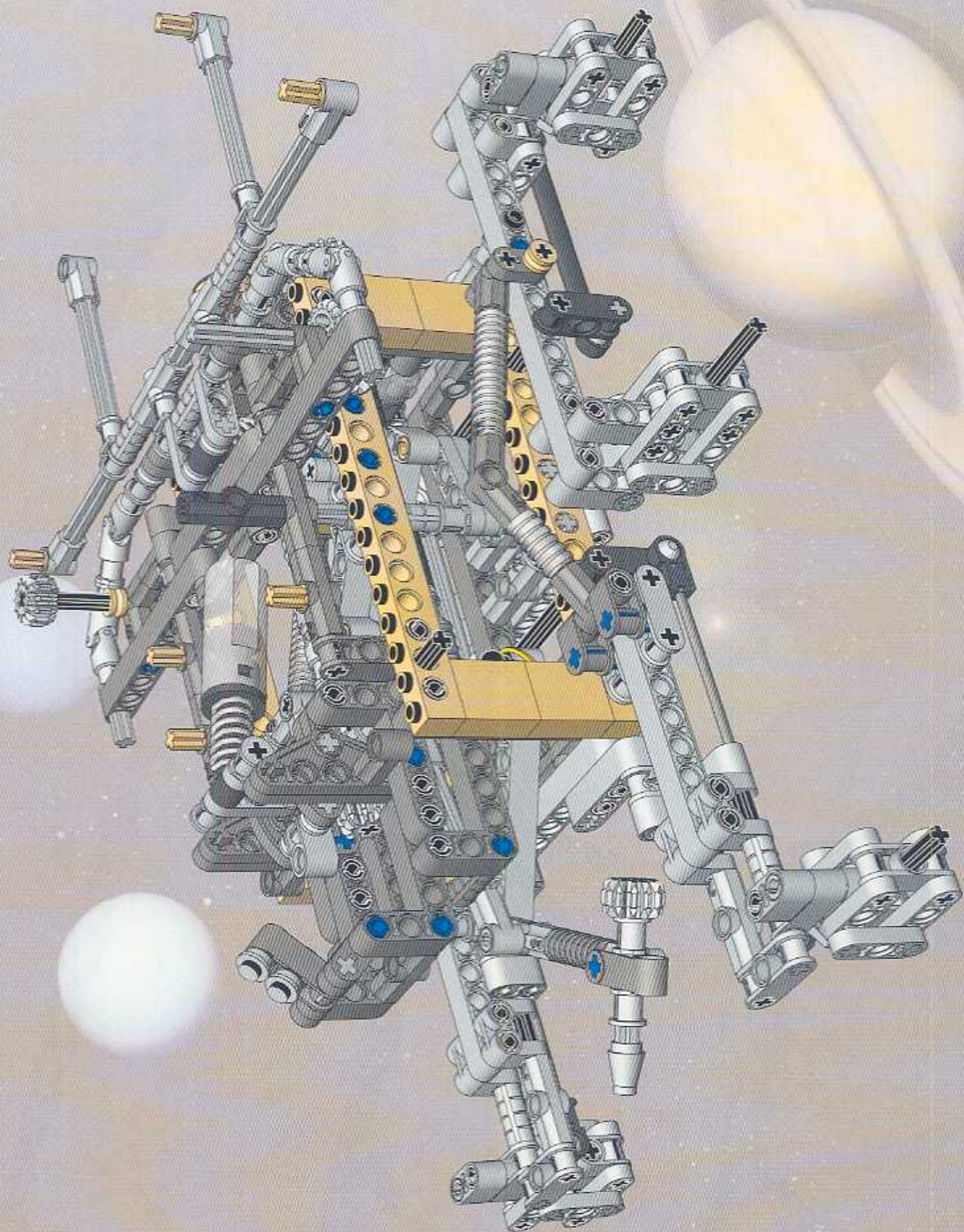

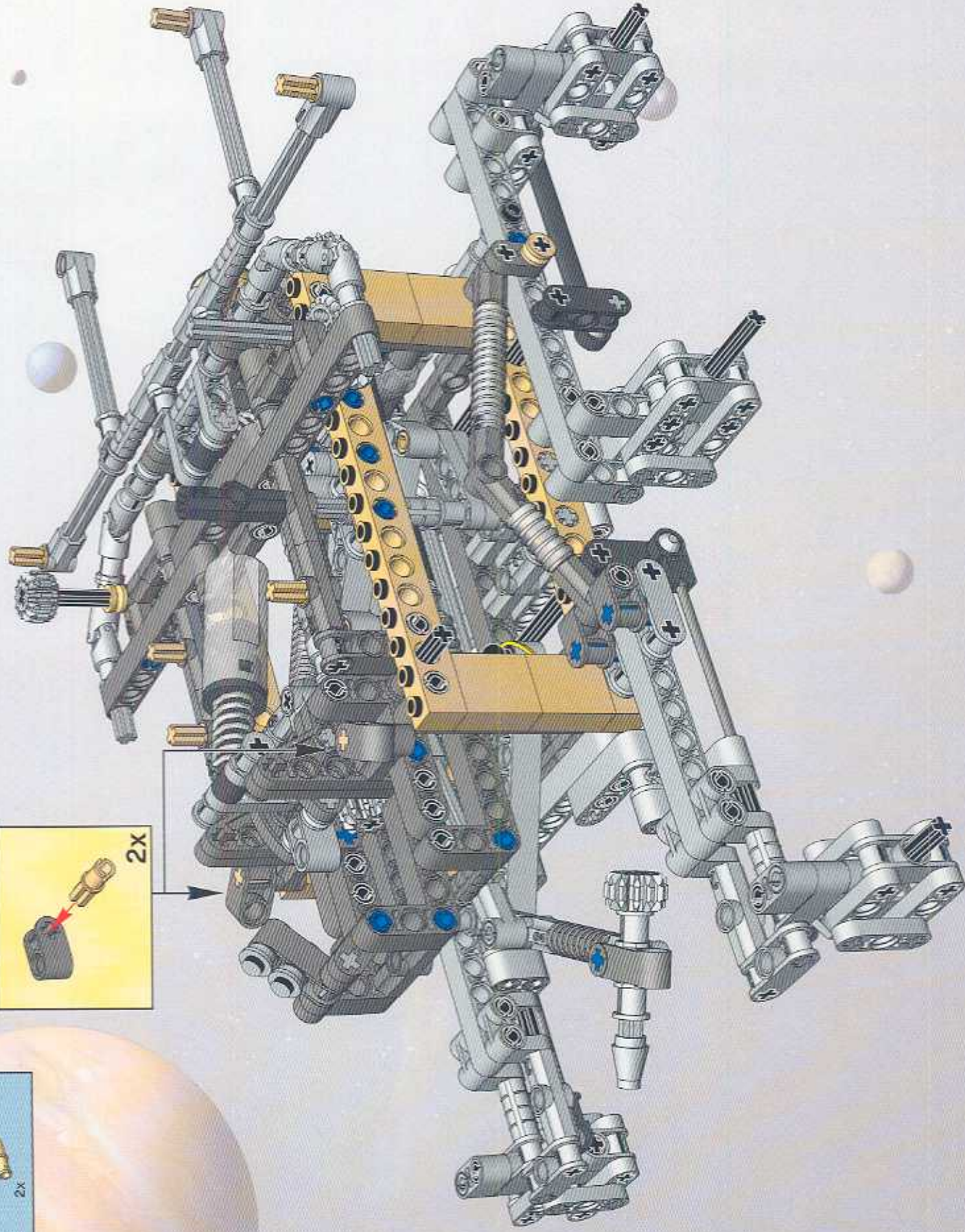

56

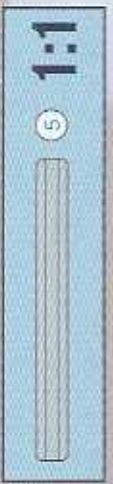

1:1

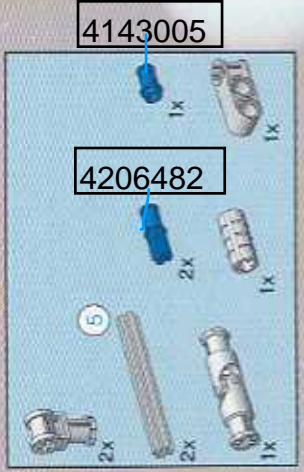

4143005

4206482

57

1



2



3



4



5

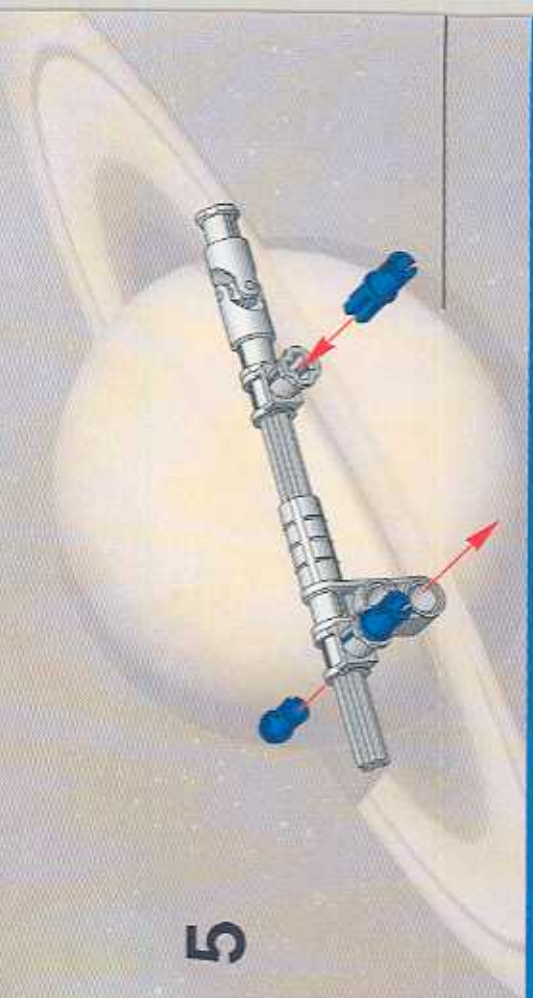

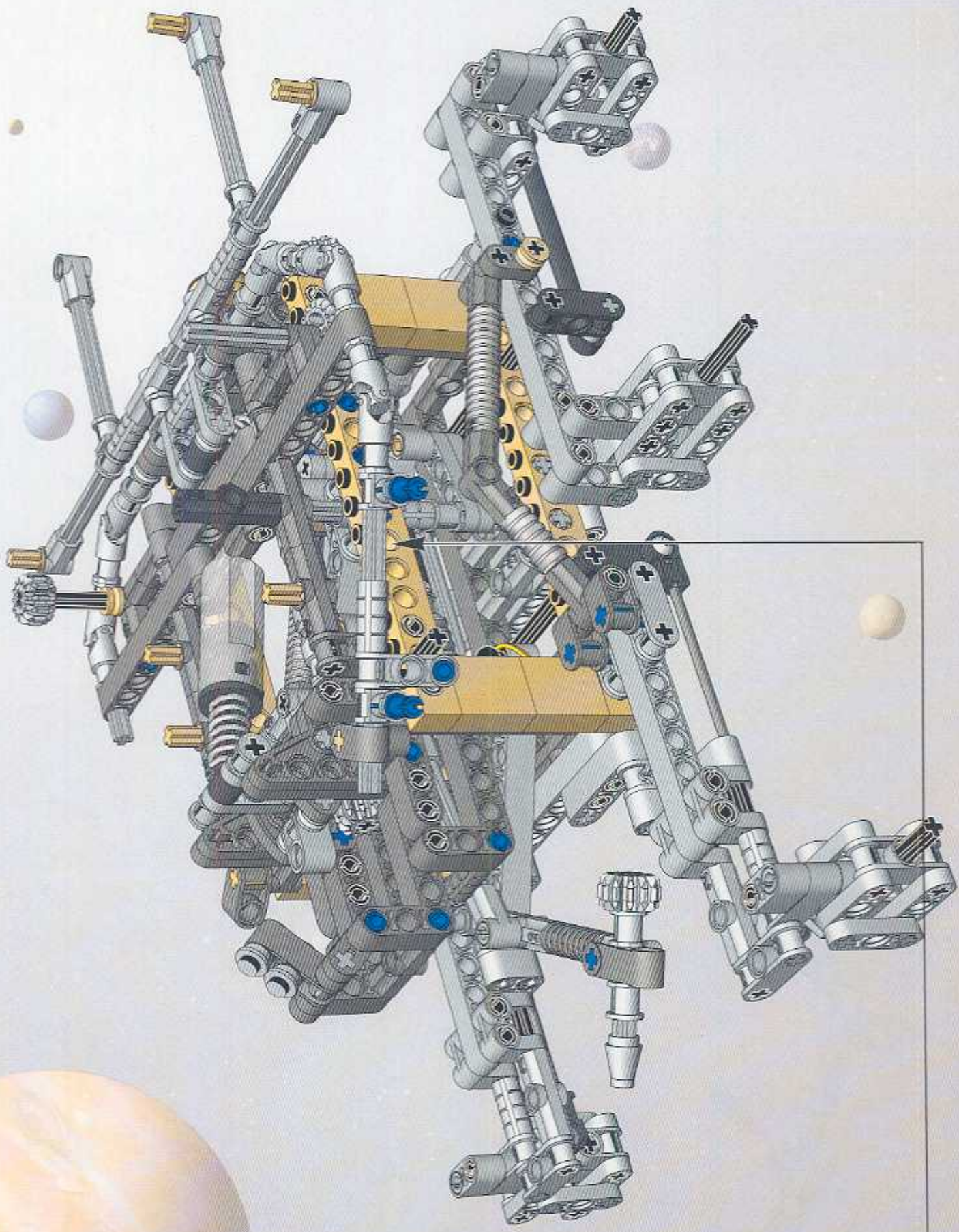

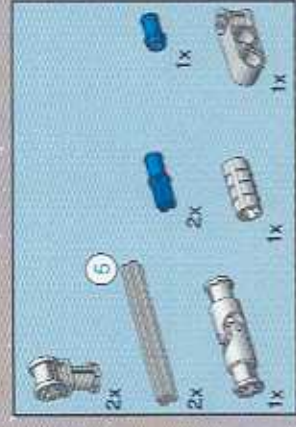

58



1



2



3



4

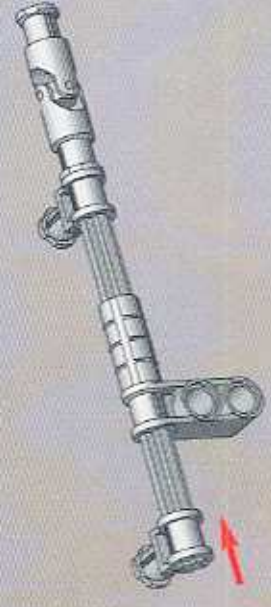

5

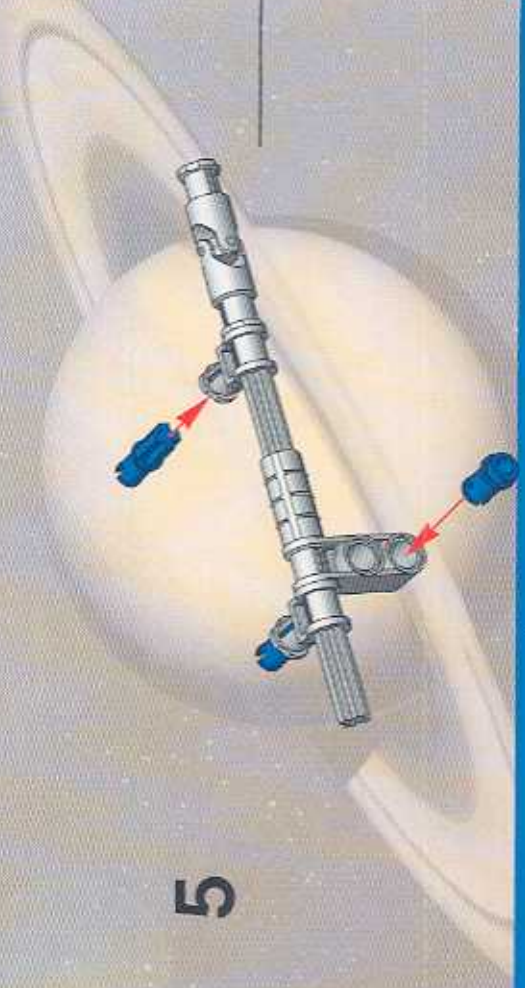

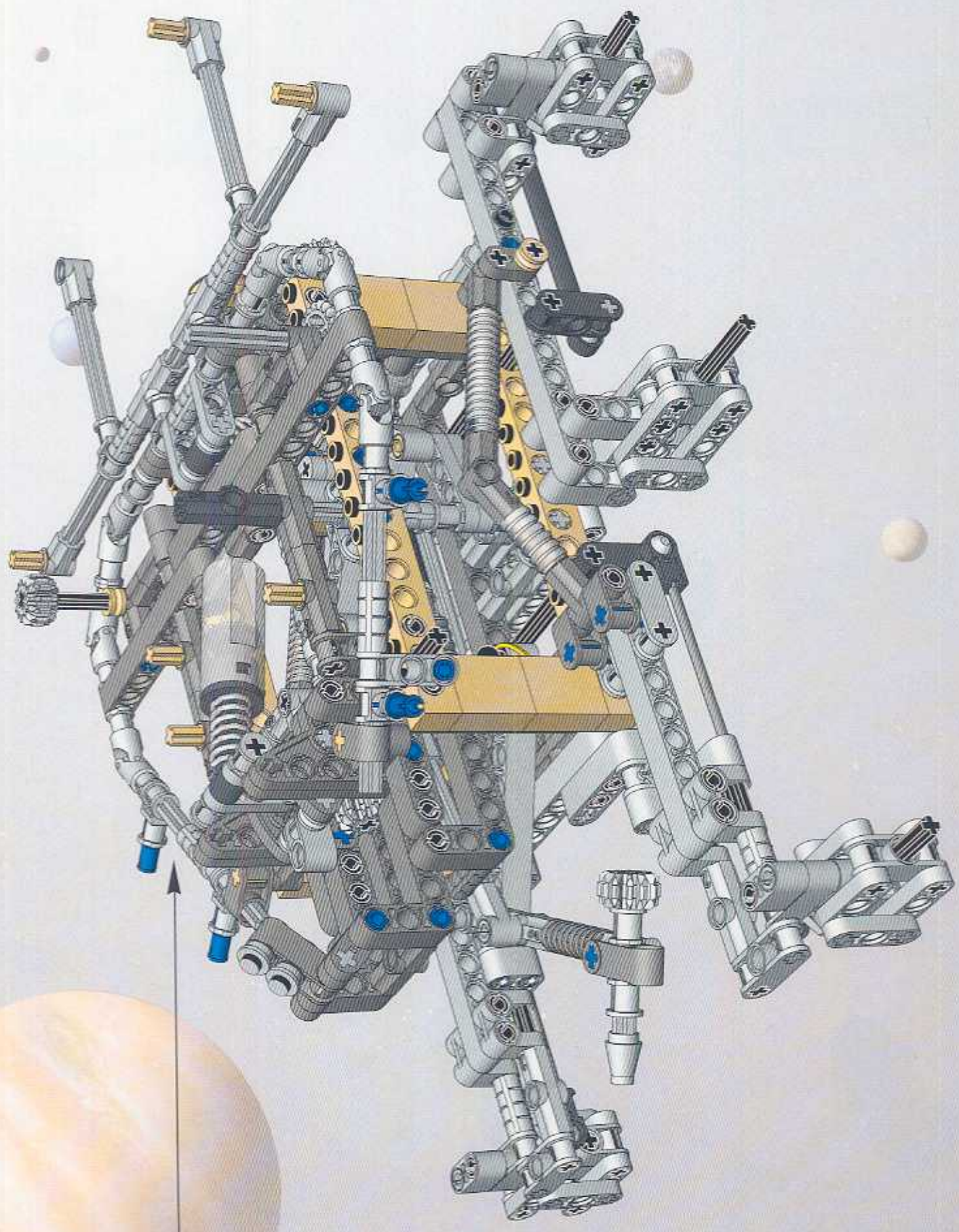

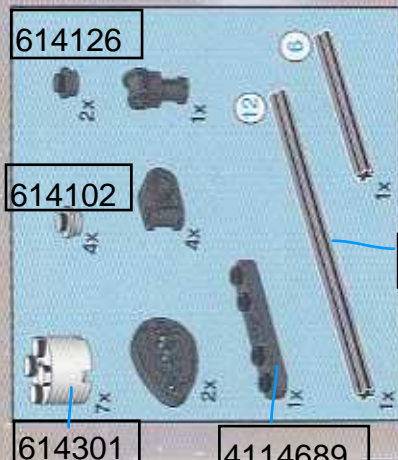

59

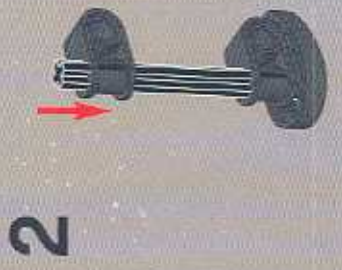
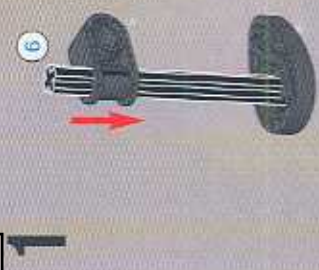
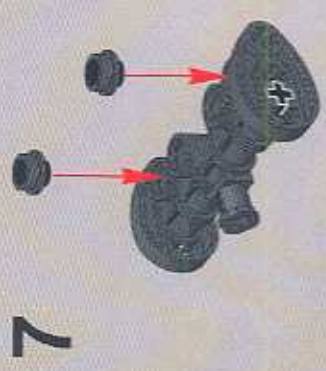
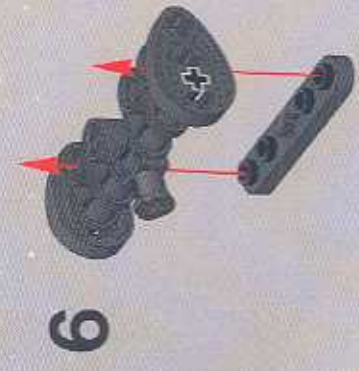
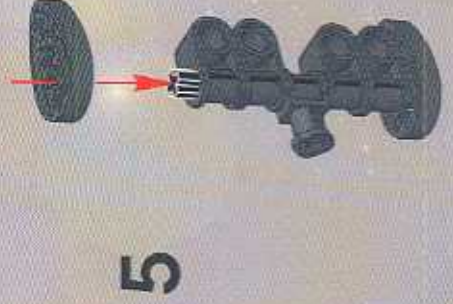
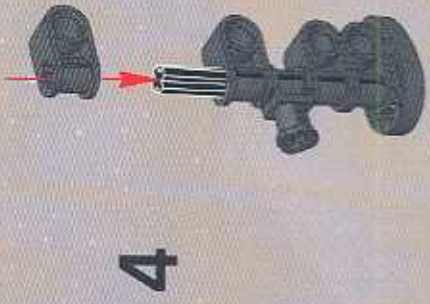

6
12 1:1

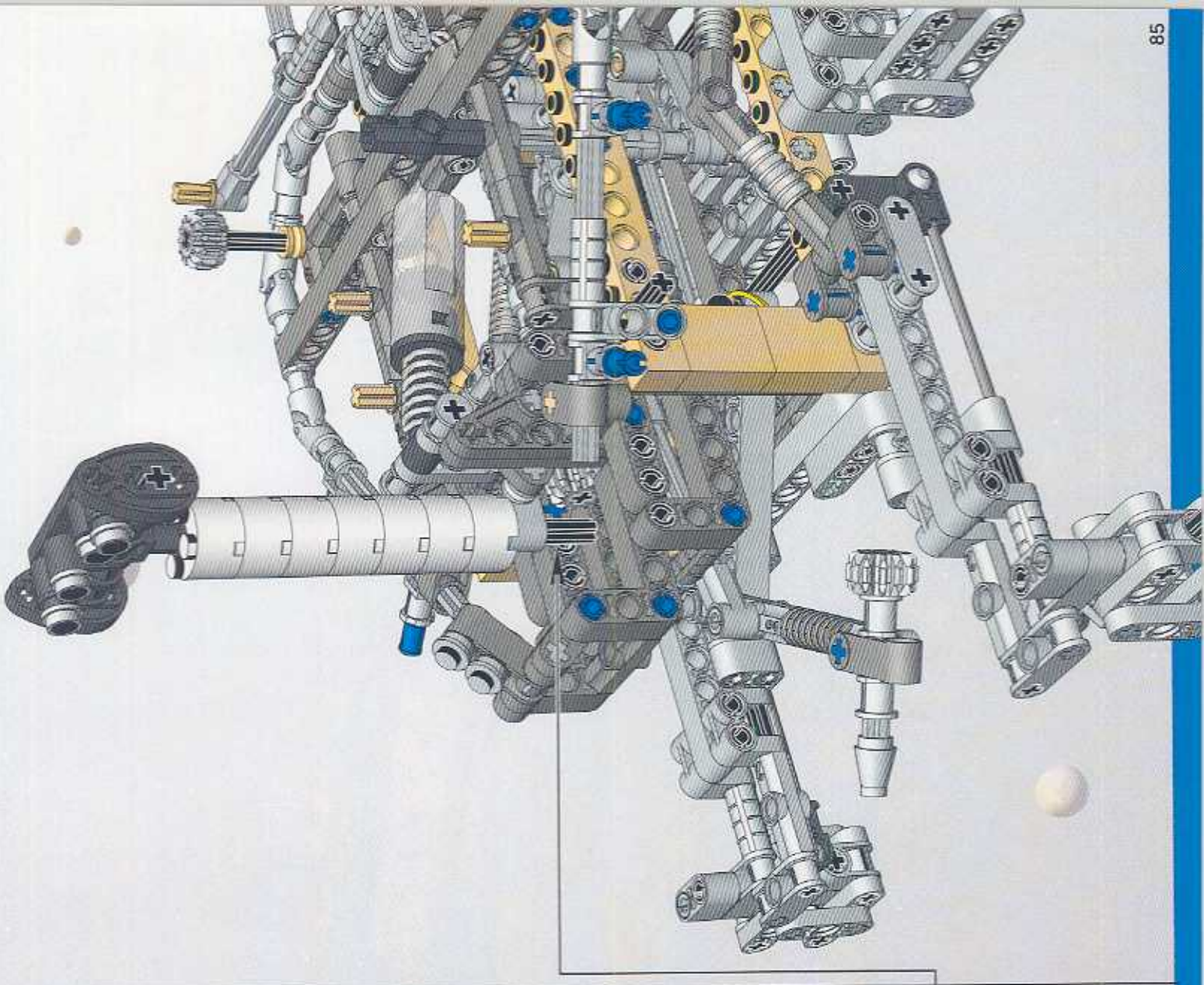
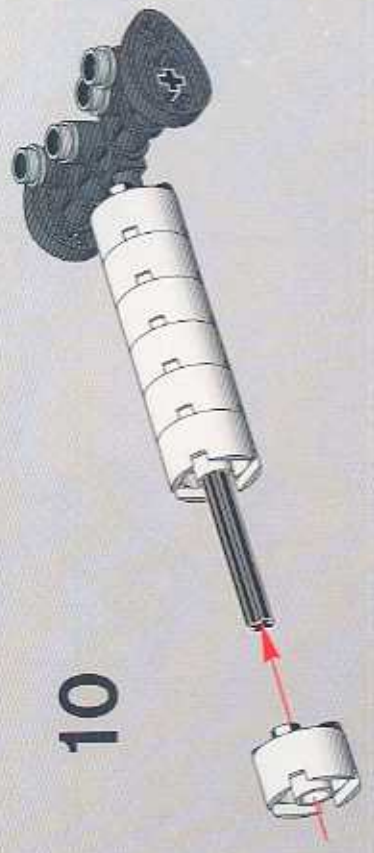

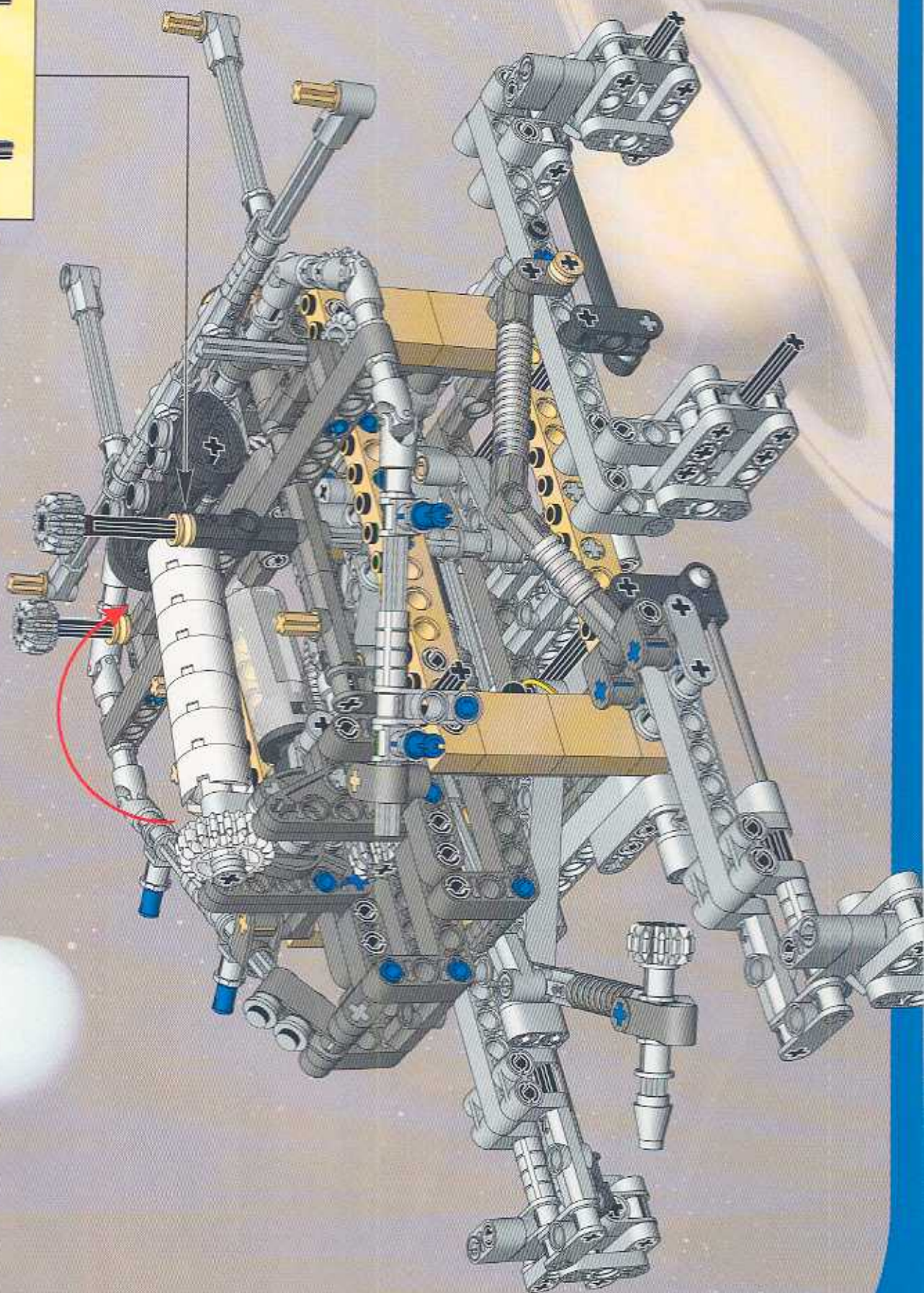
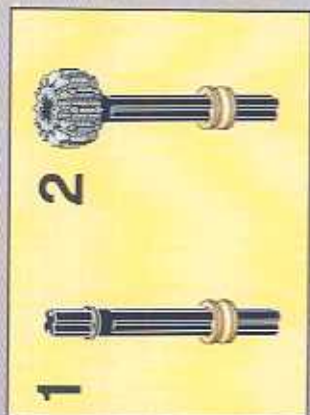

60

4206210

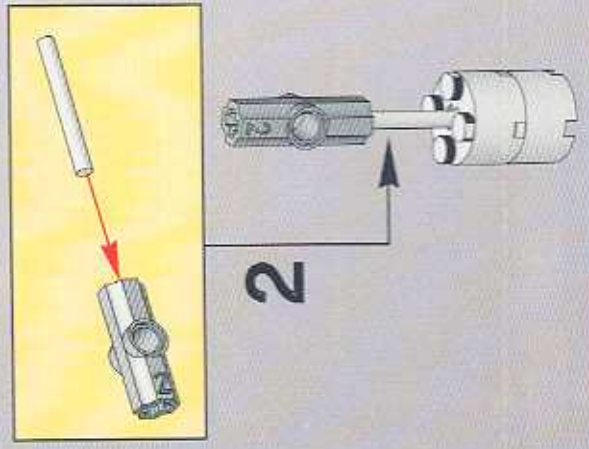
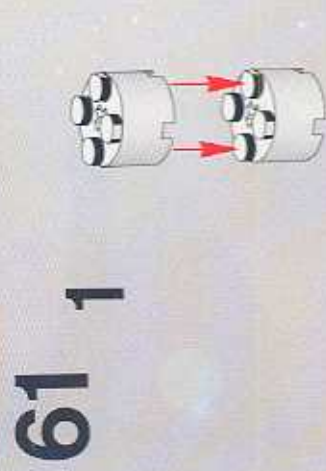
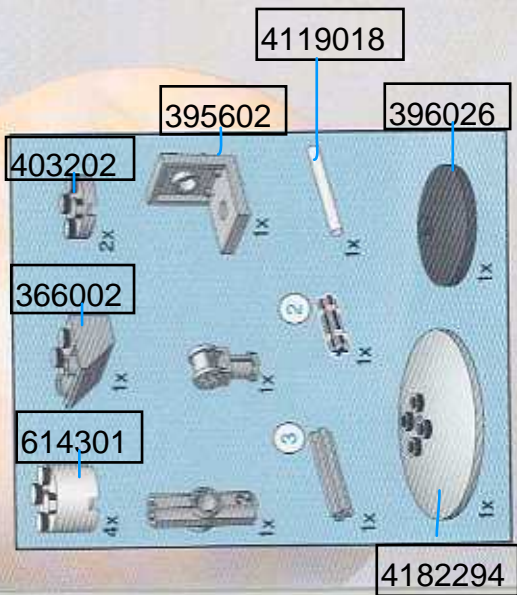
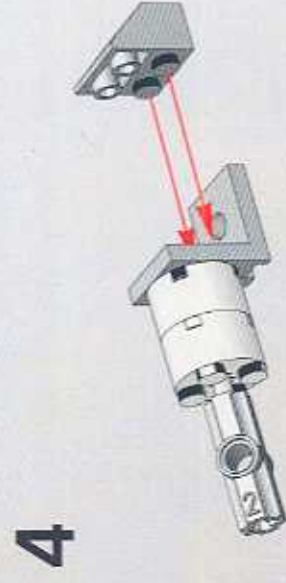
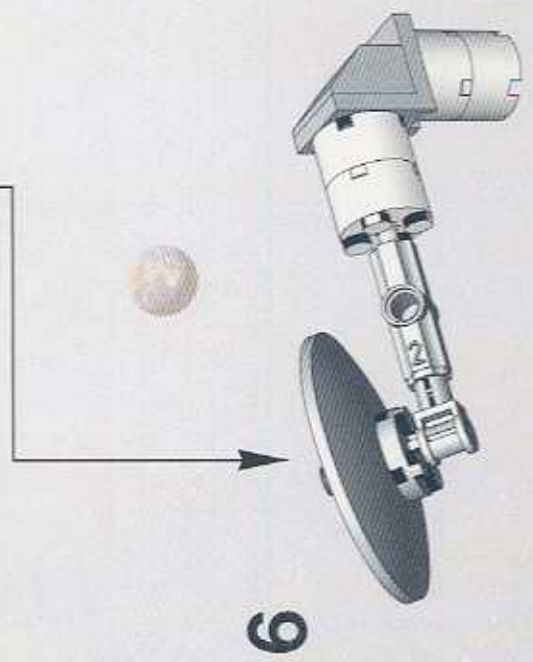
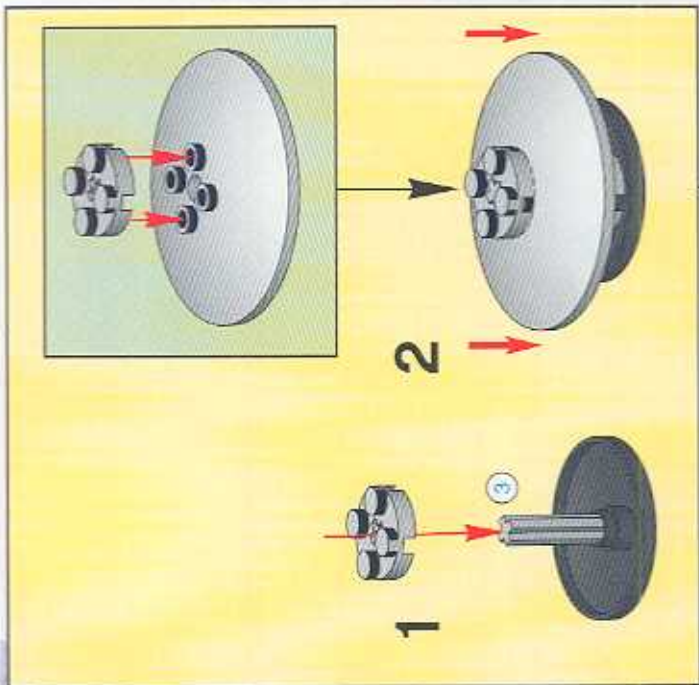
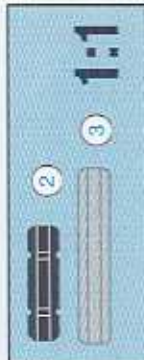

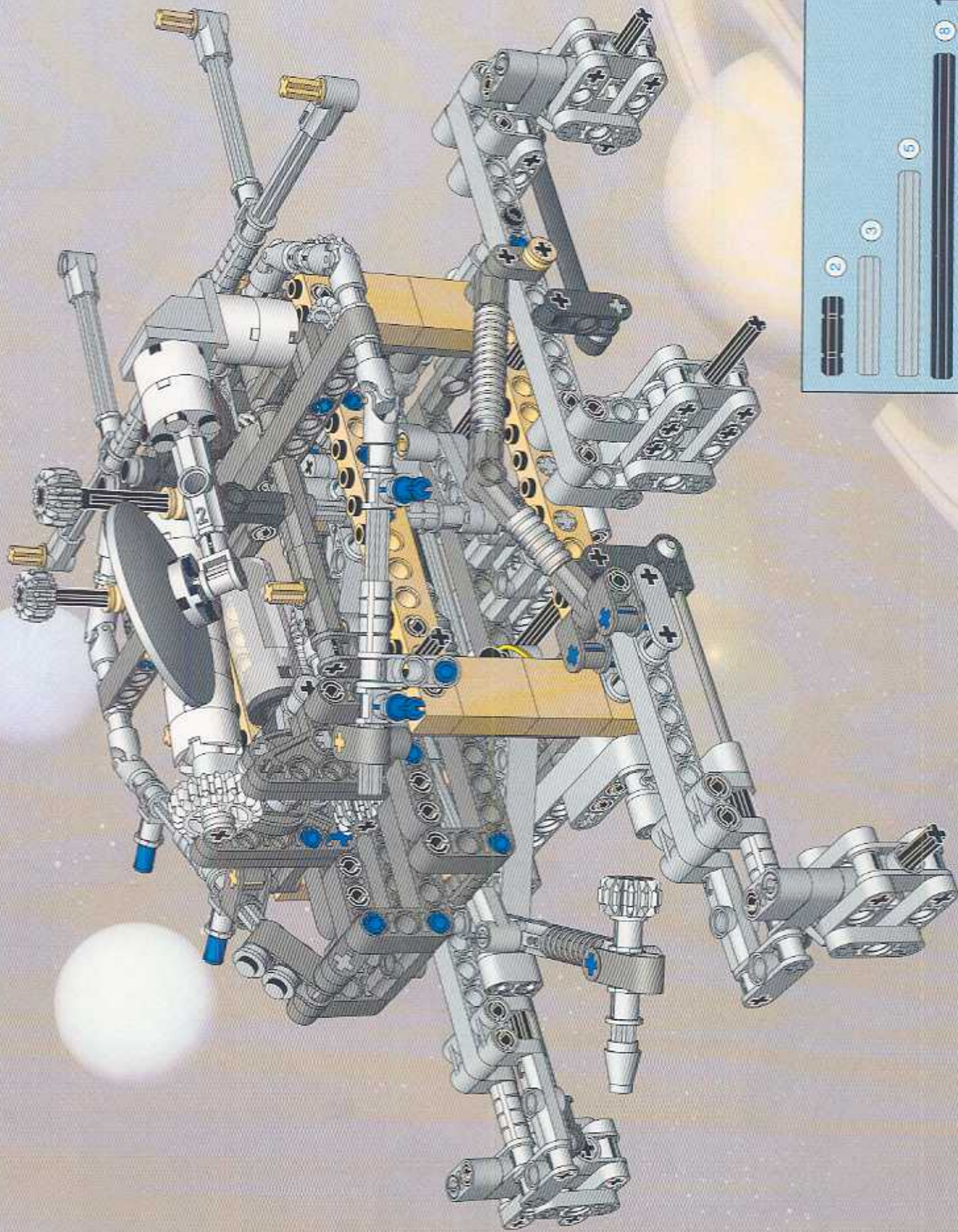

	2		9		5		8	1:1
--	---	--	---	--	---	--	---	-----

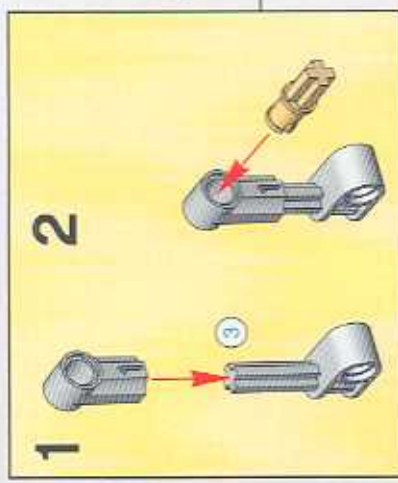

1

2

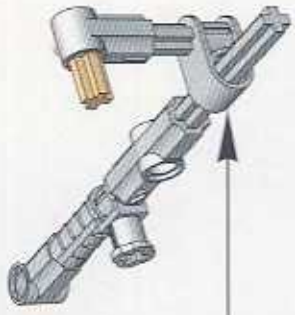

5

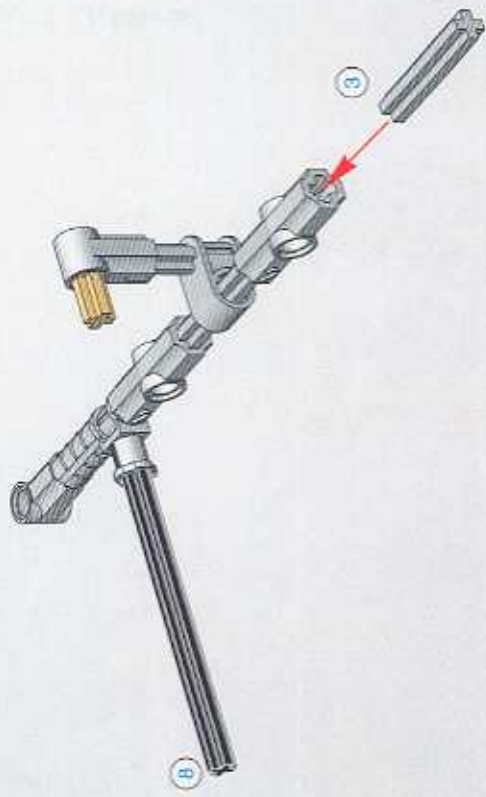

6

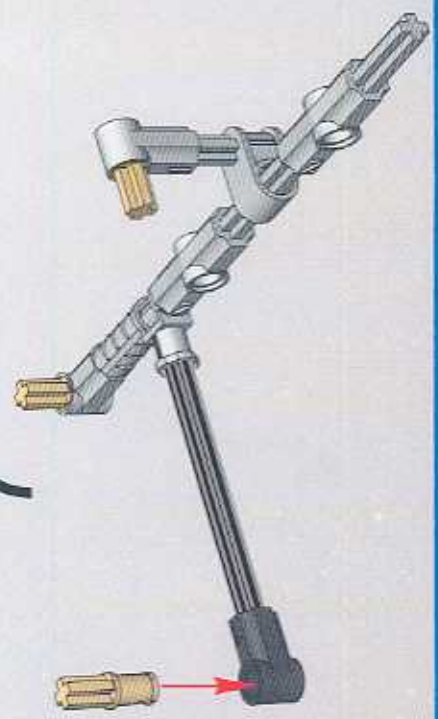

7

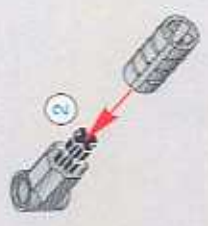

1



2

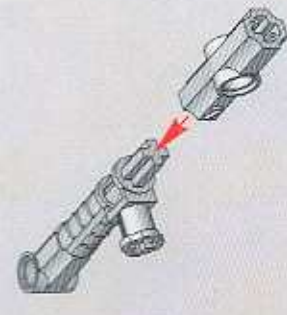

3



4

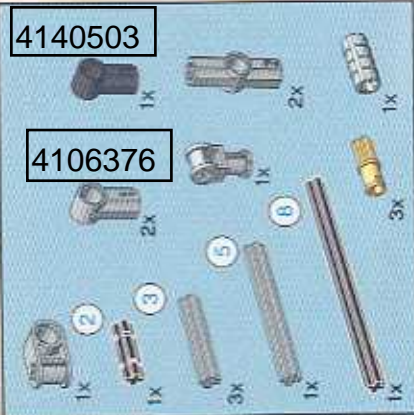

62

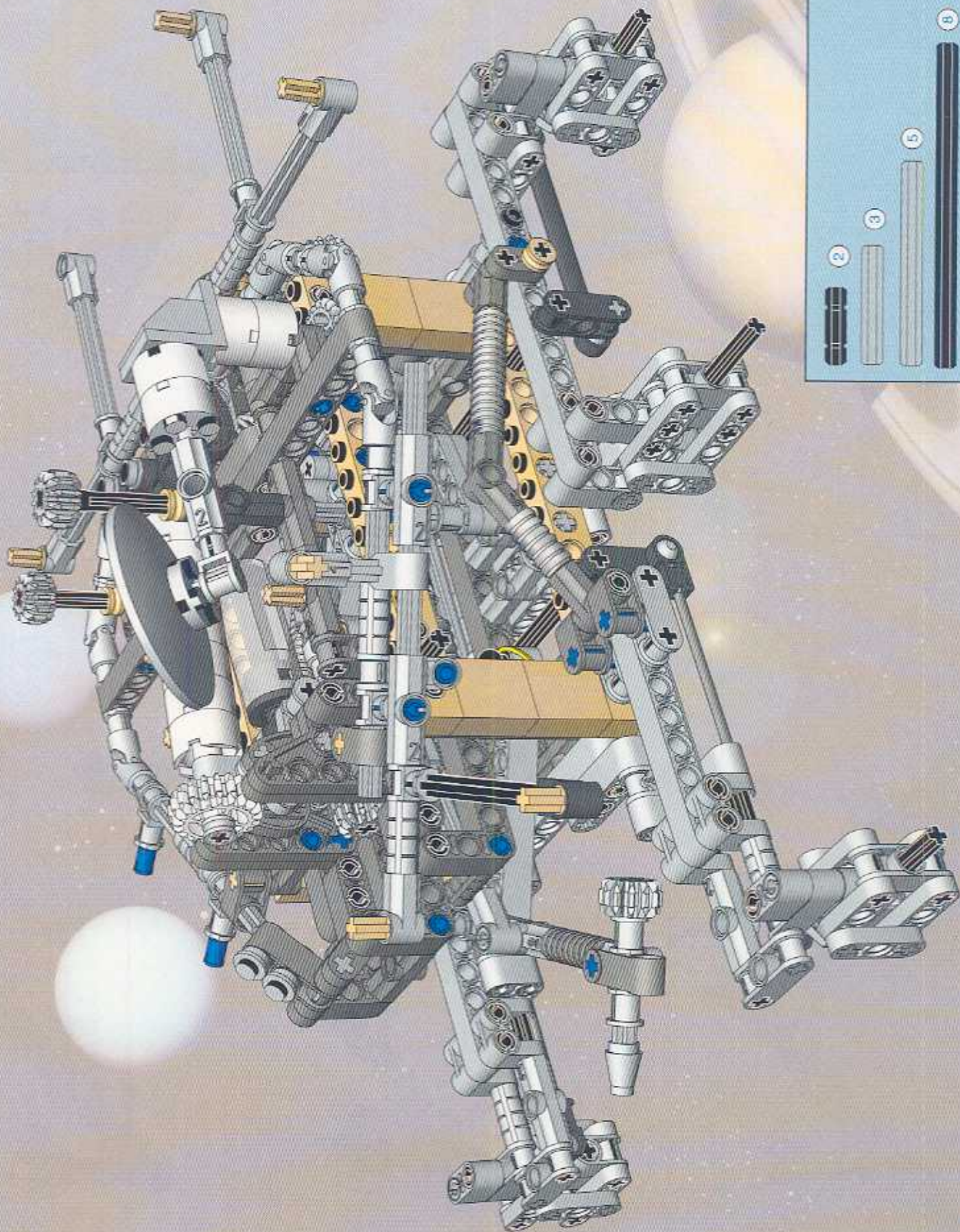

2
3
5
8 1:1

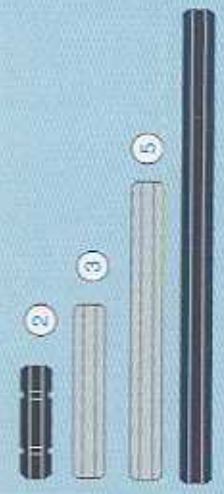

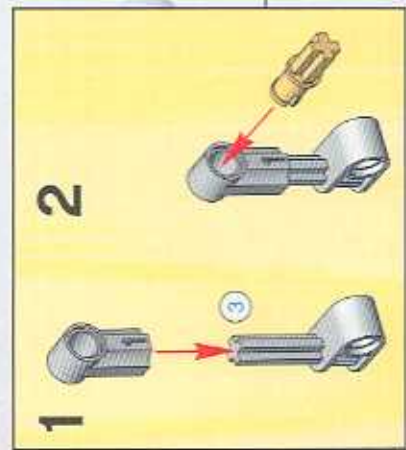

2

1

5

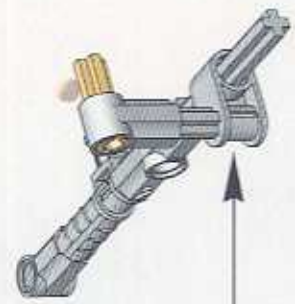

6

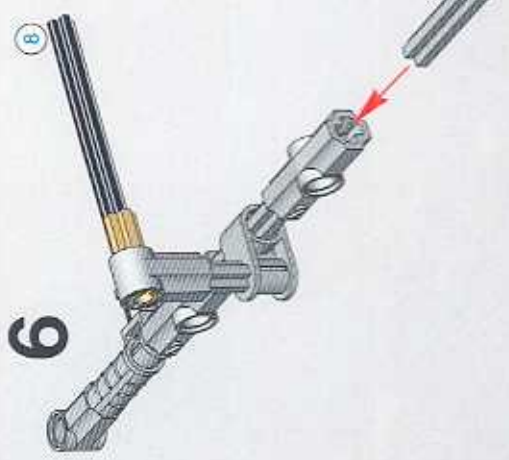

7

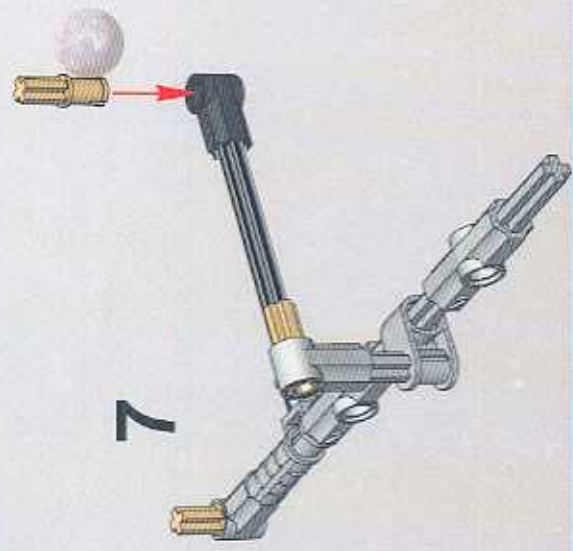

1

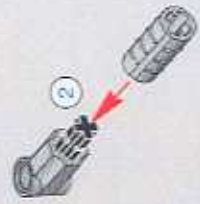

2

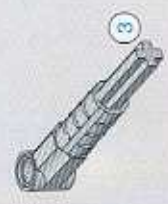

3

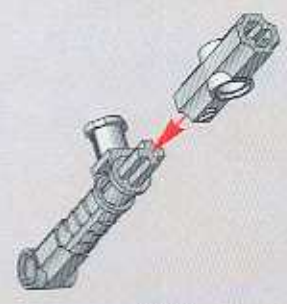

4

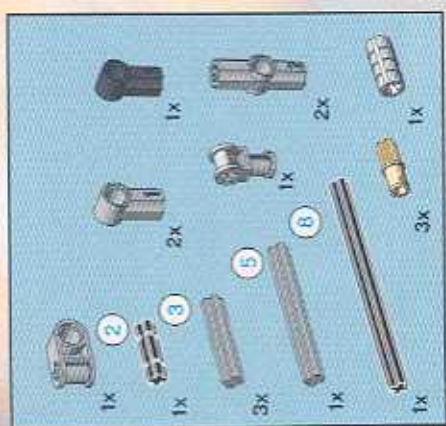

63

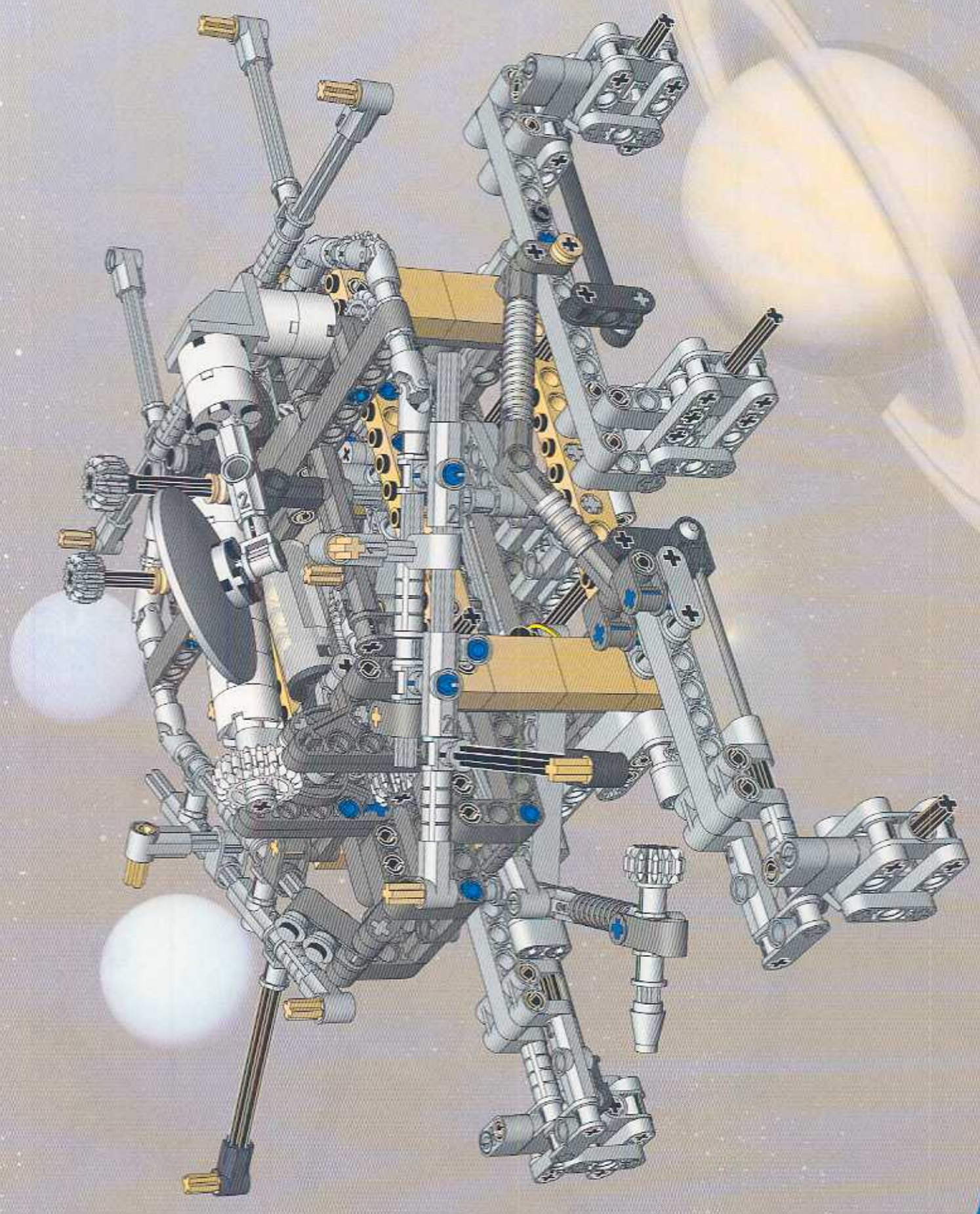

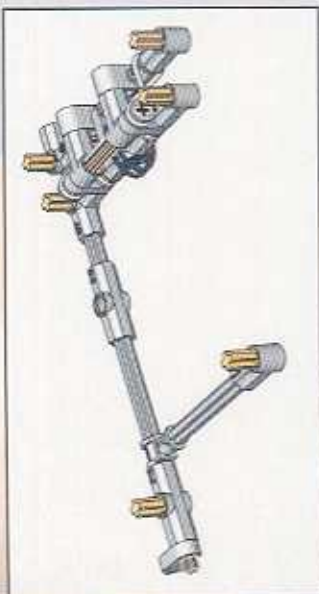

1



2



3



4



5



6

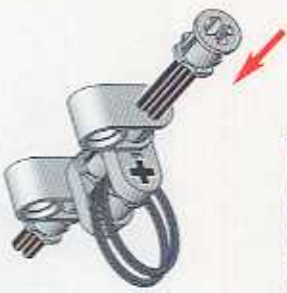

7



8



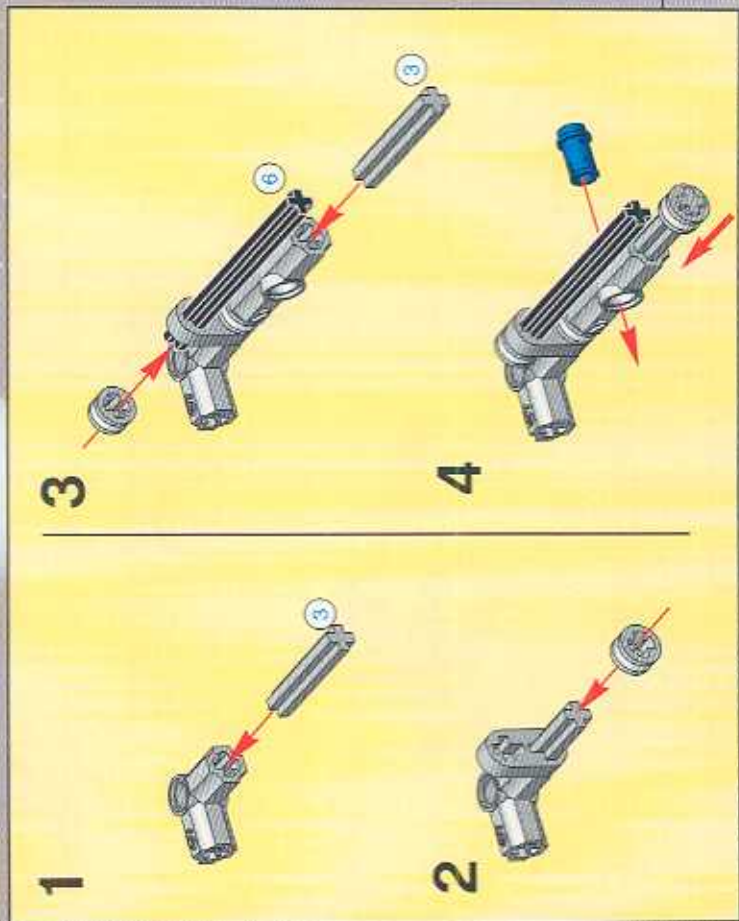
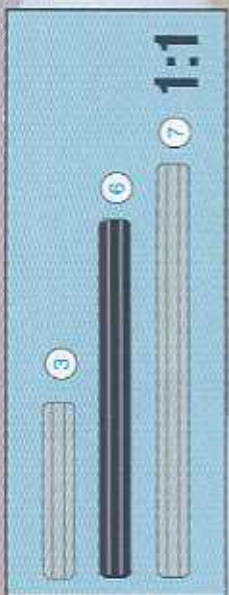
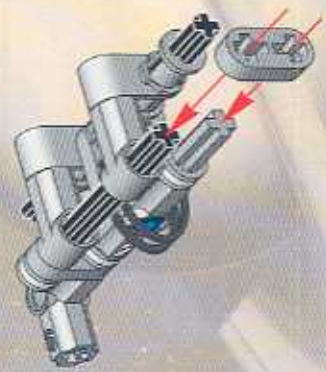
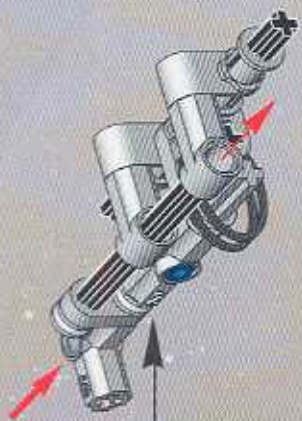

9

10



11

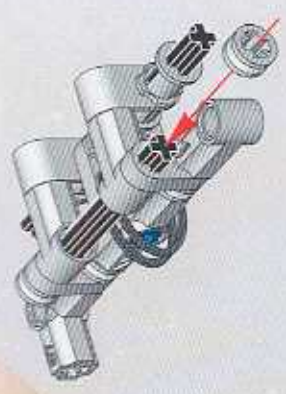

12

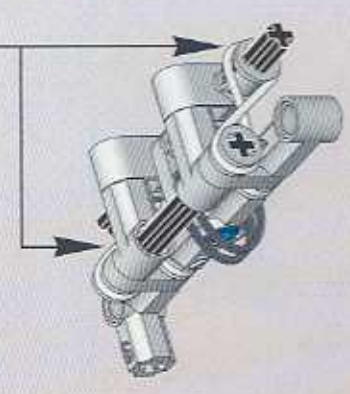
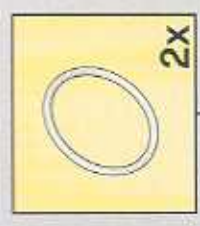

13

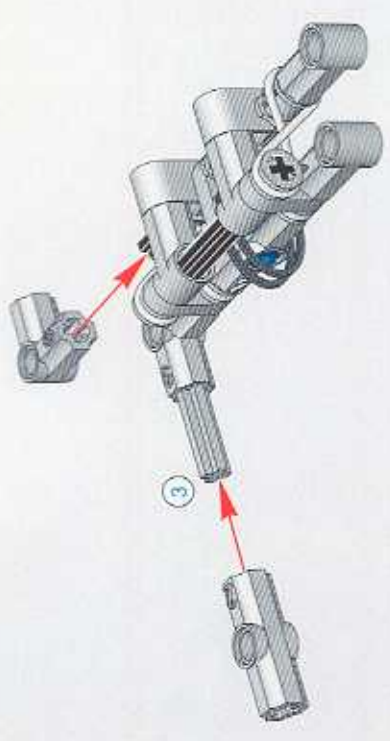

14

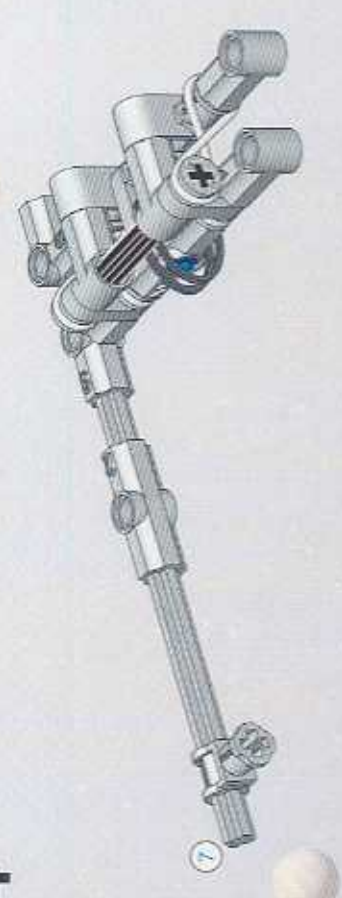



15



16

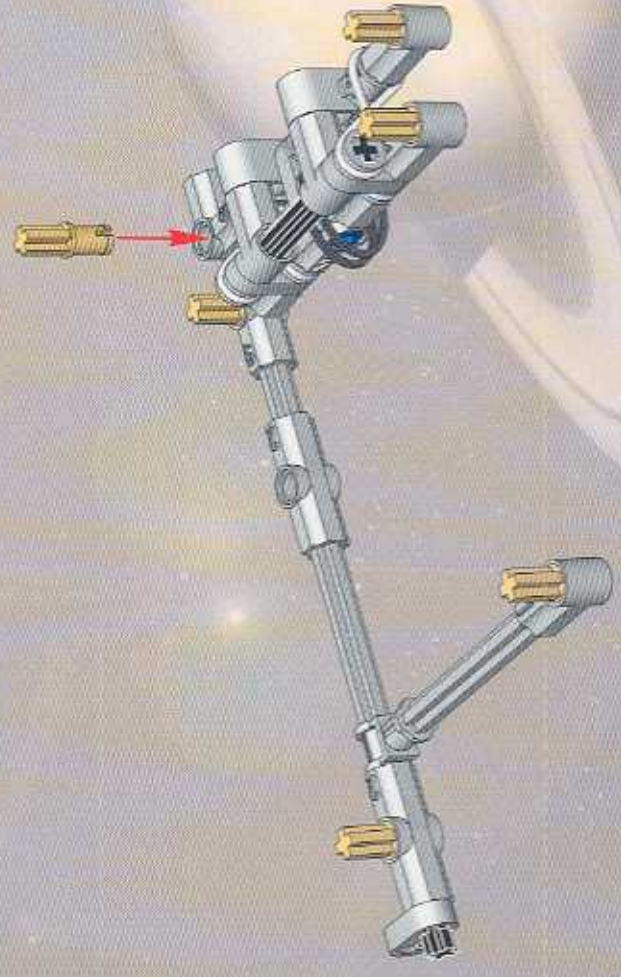
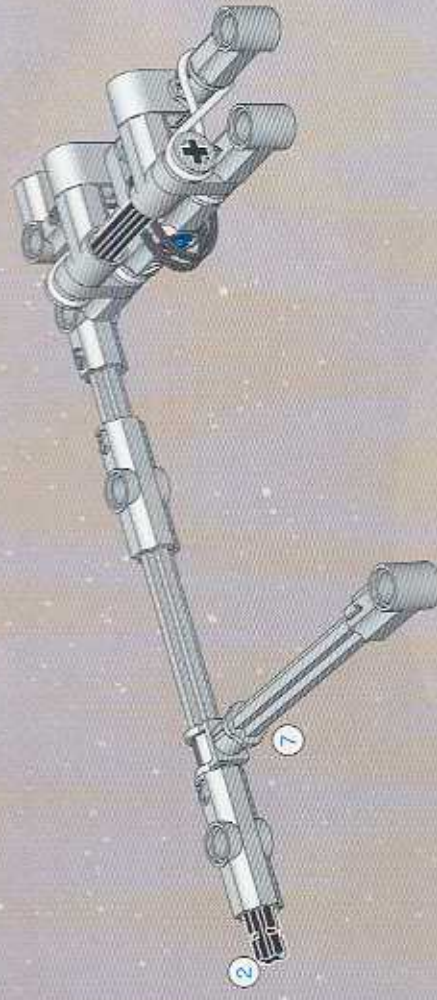

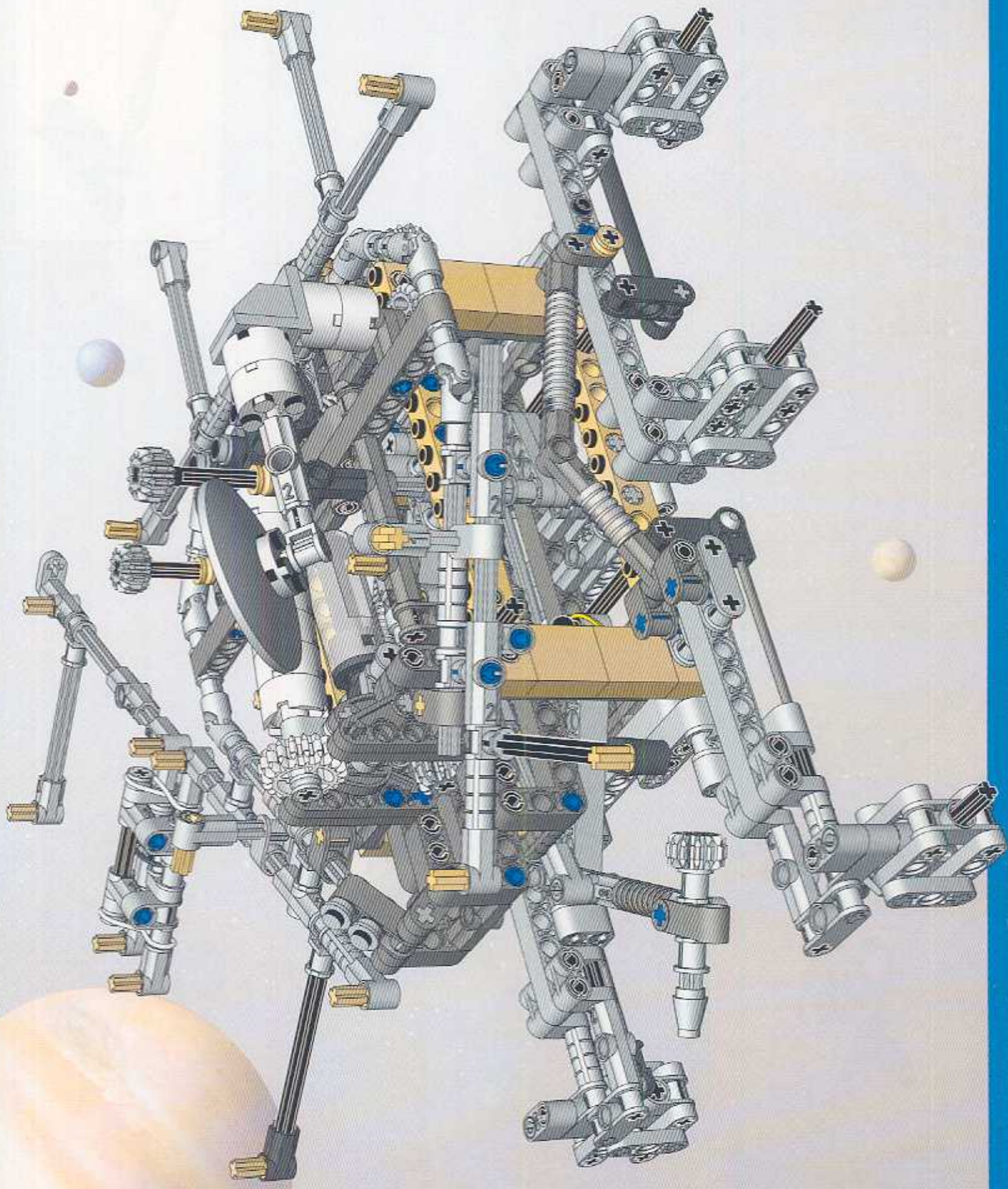

64

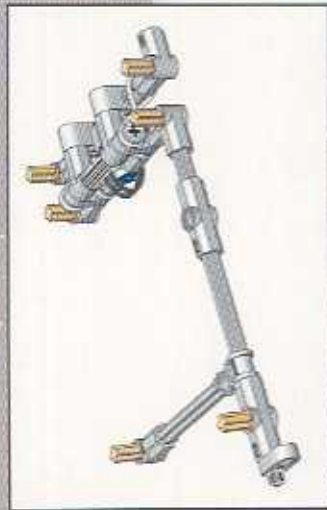

1



2



3



4



5



6



7



8





9

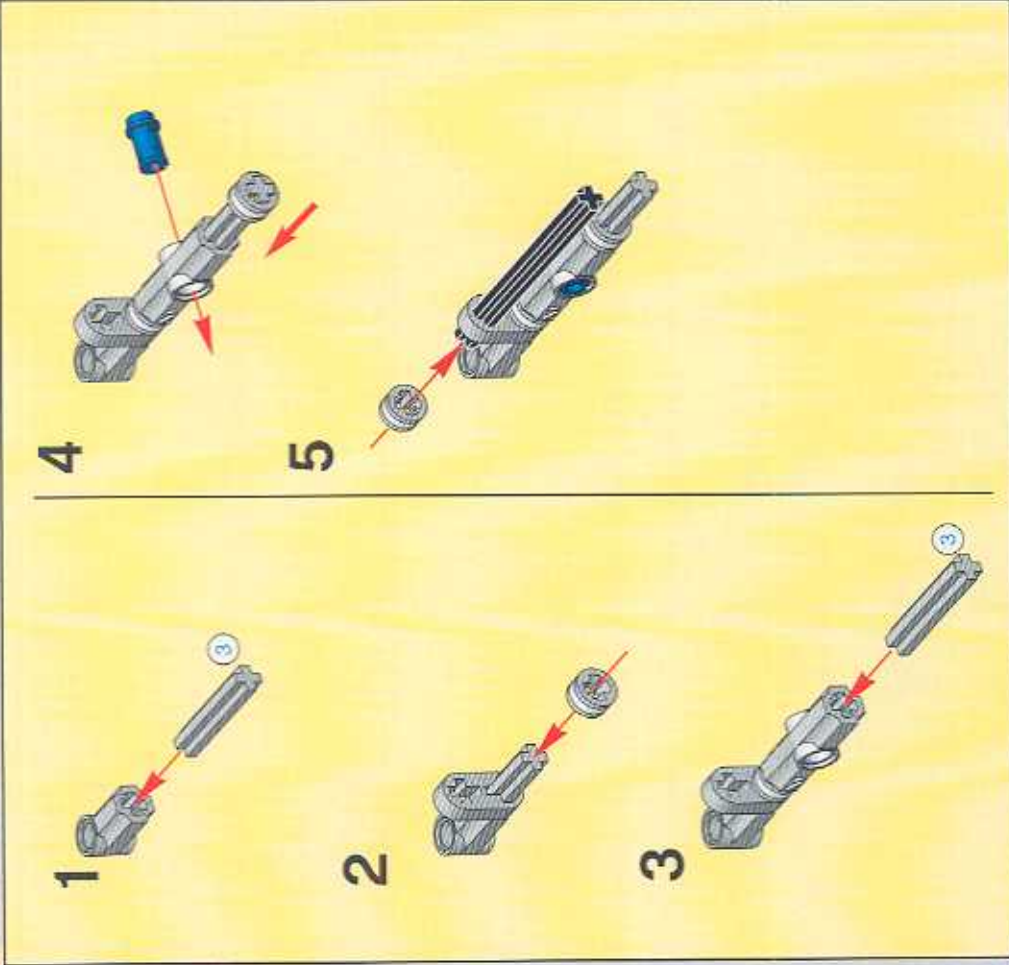

10

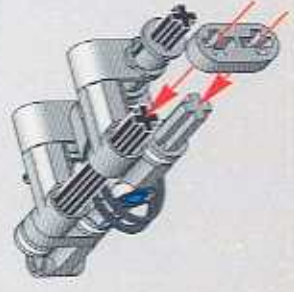
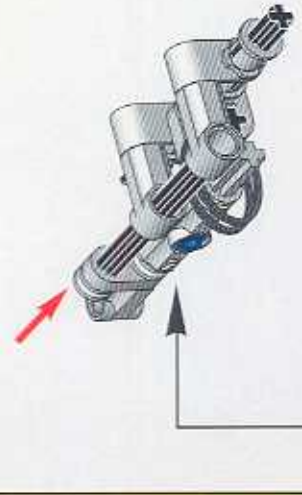
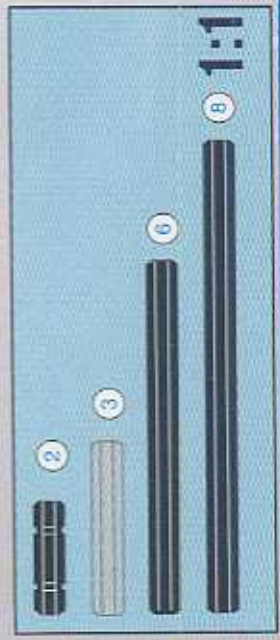



11

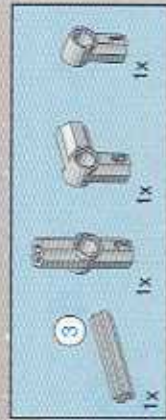

13

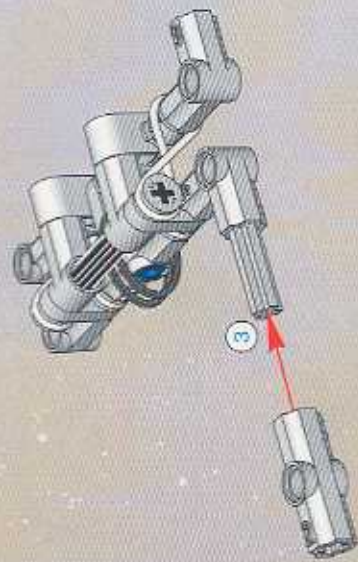

12

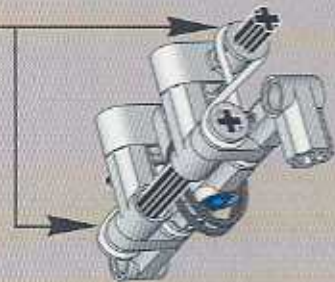
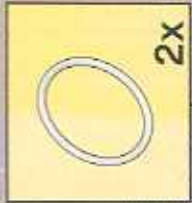

14

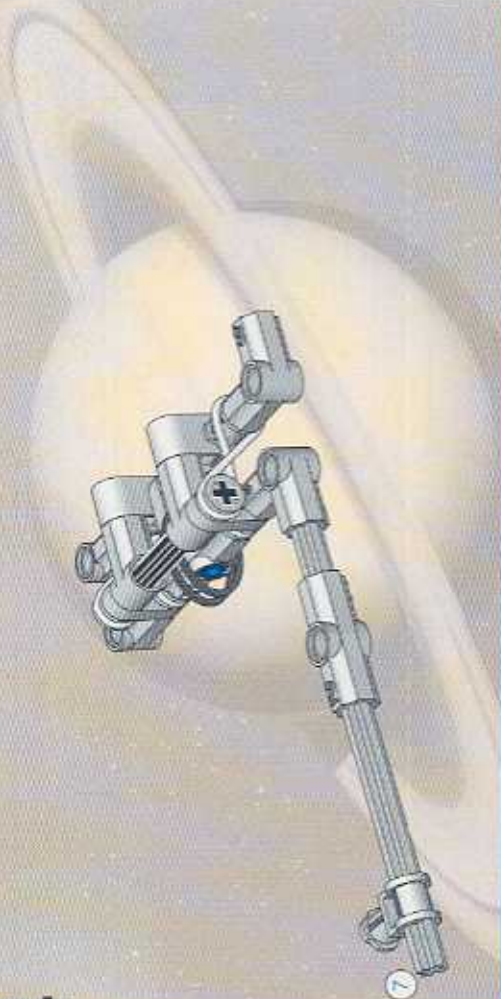



15

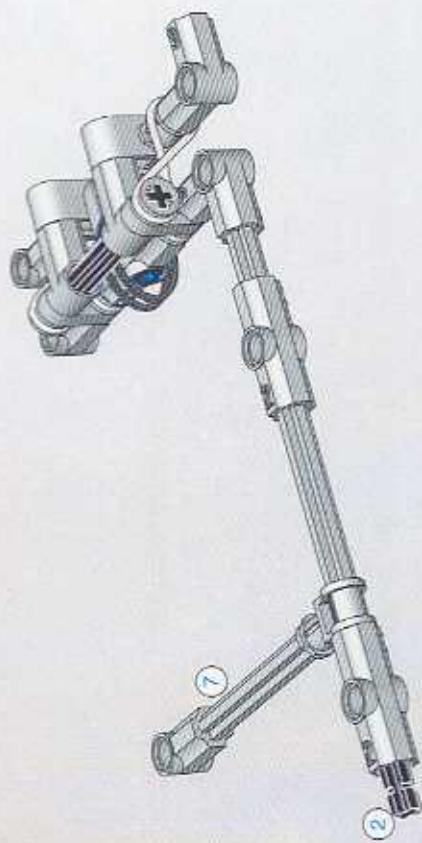

16

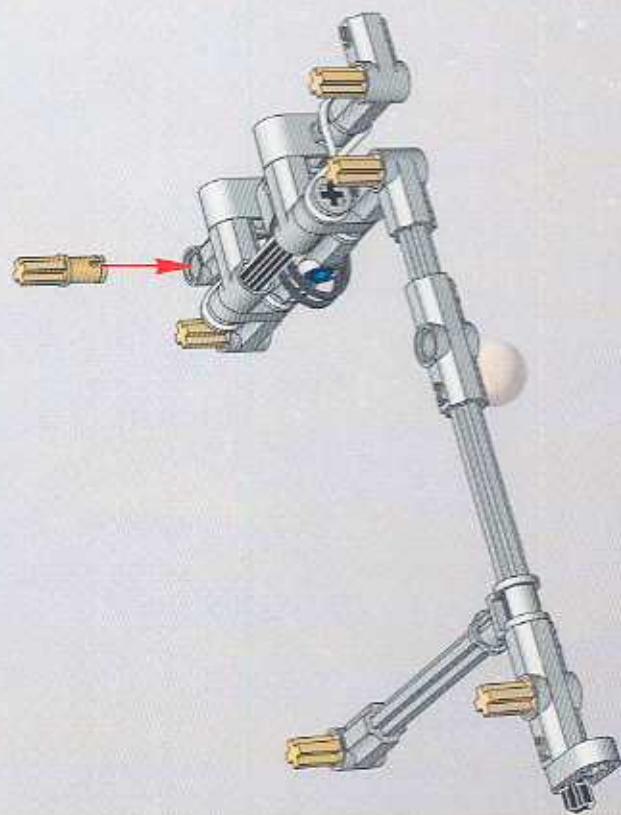

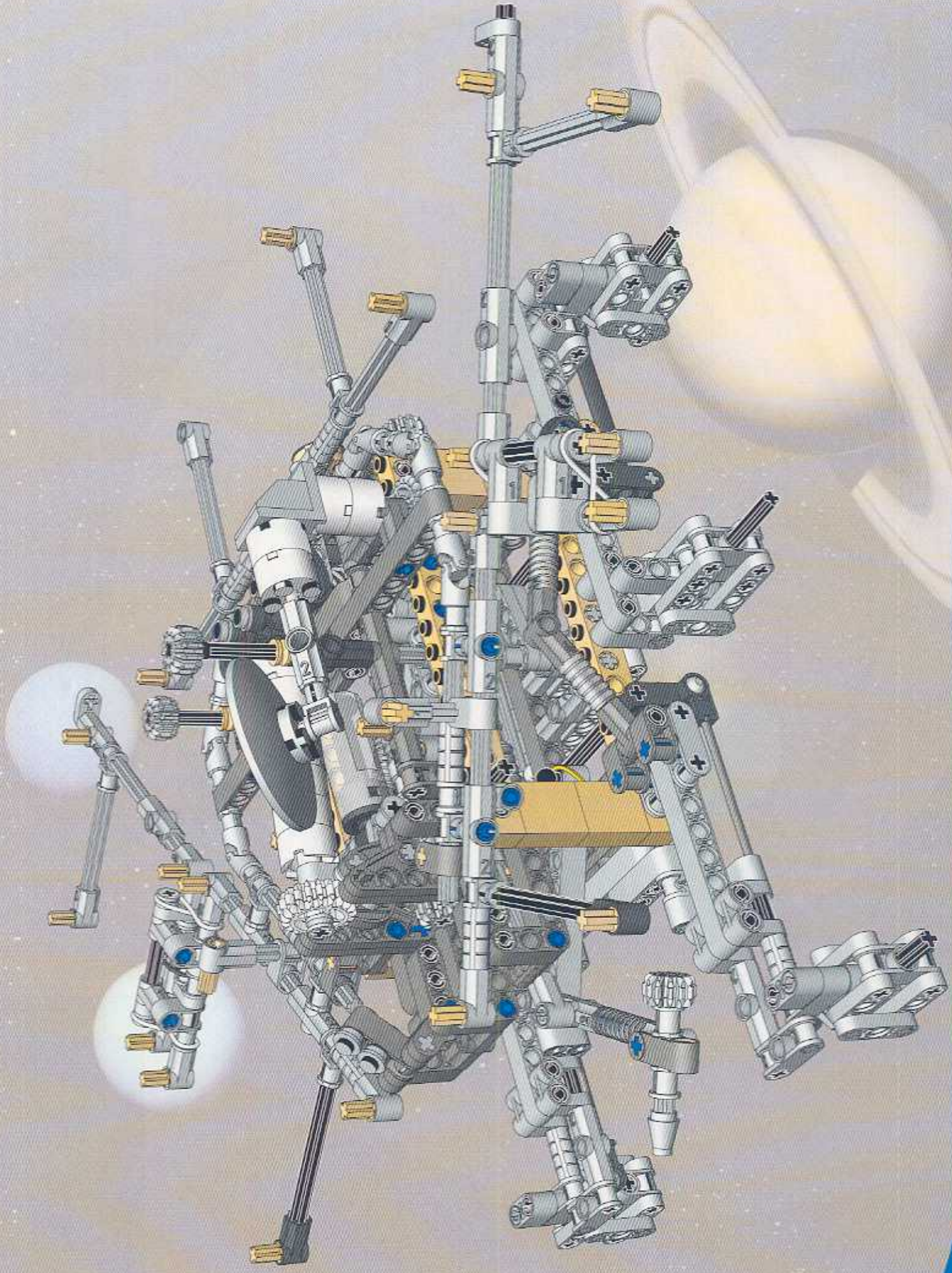

65

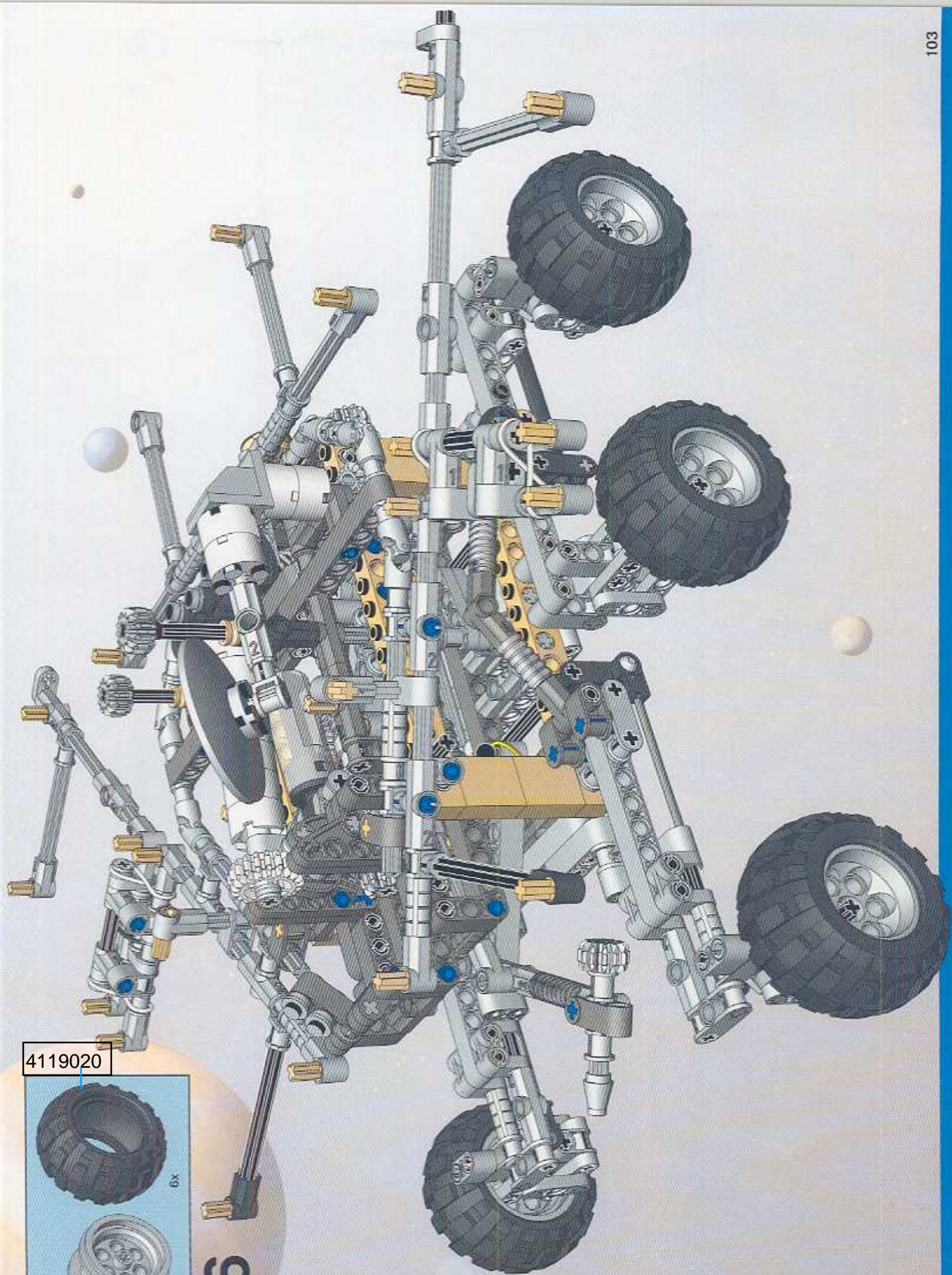

4119020



4163403

66

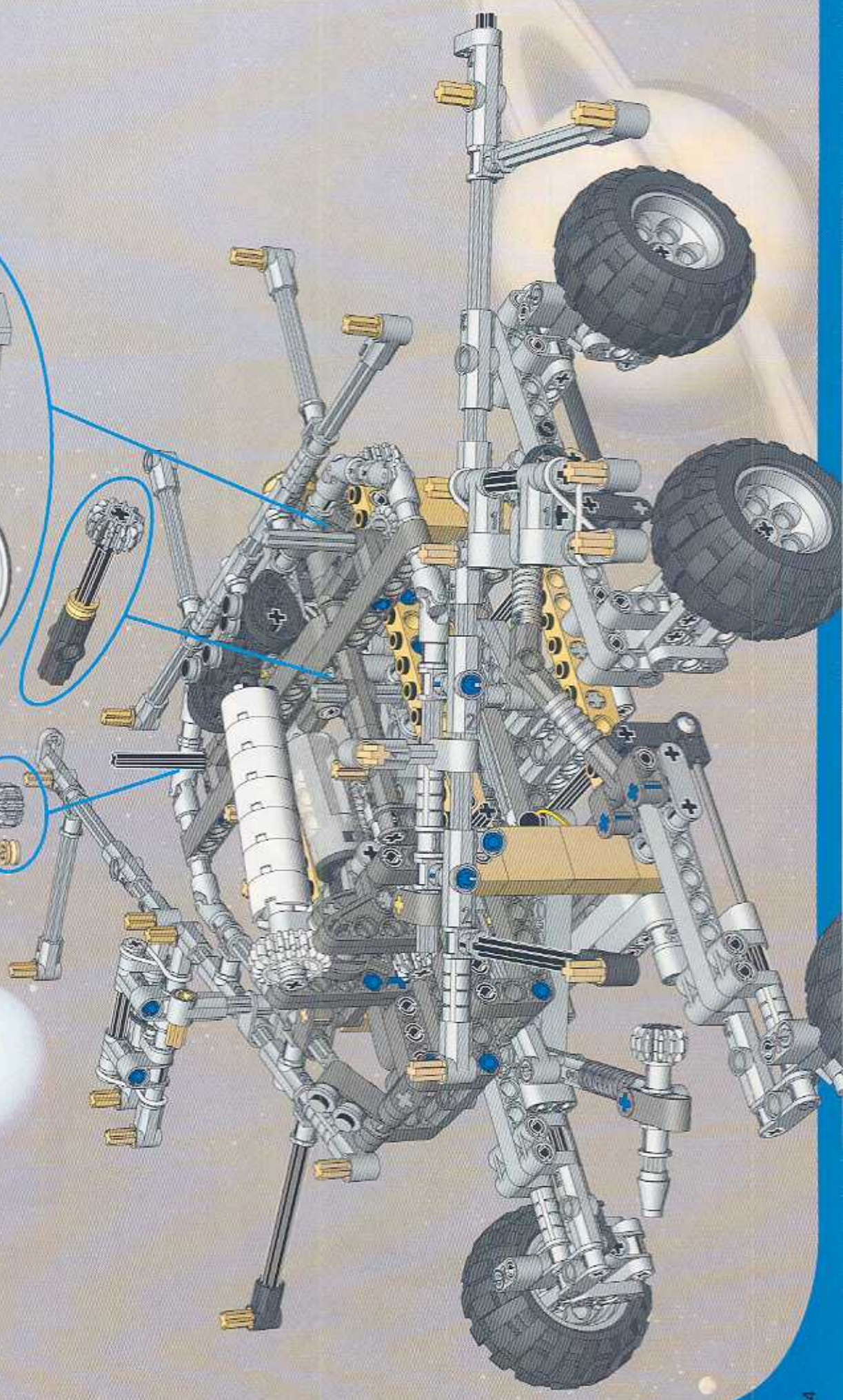

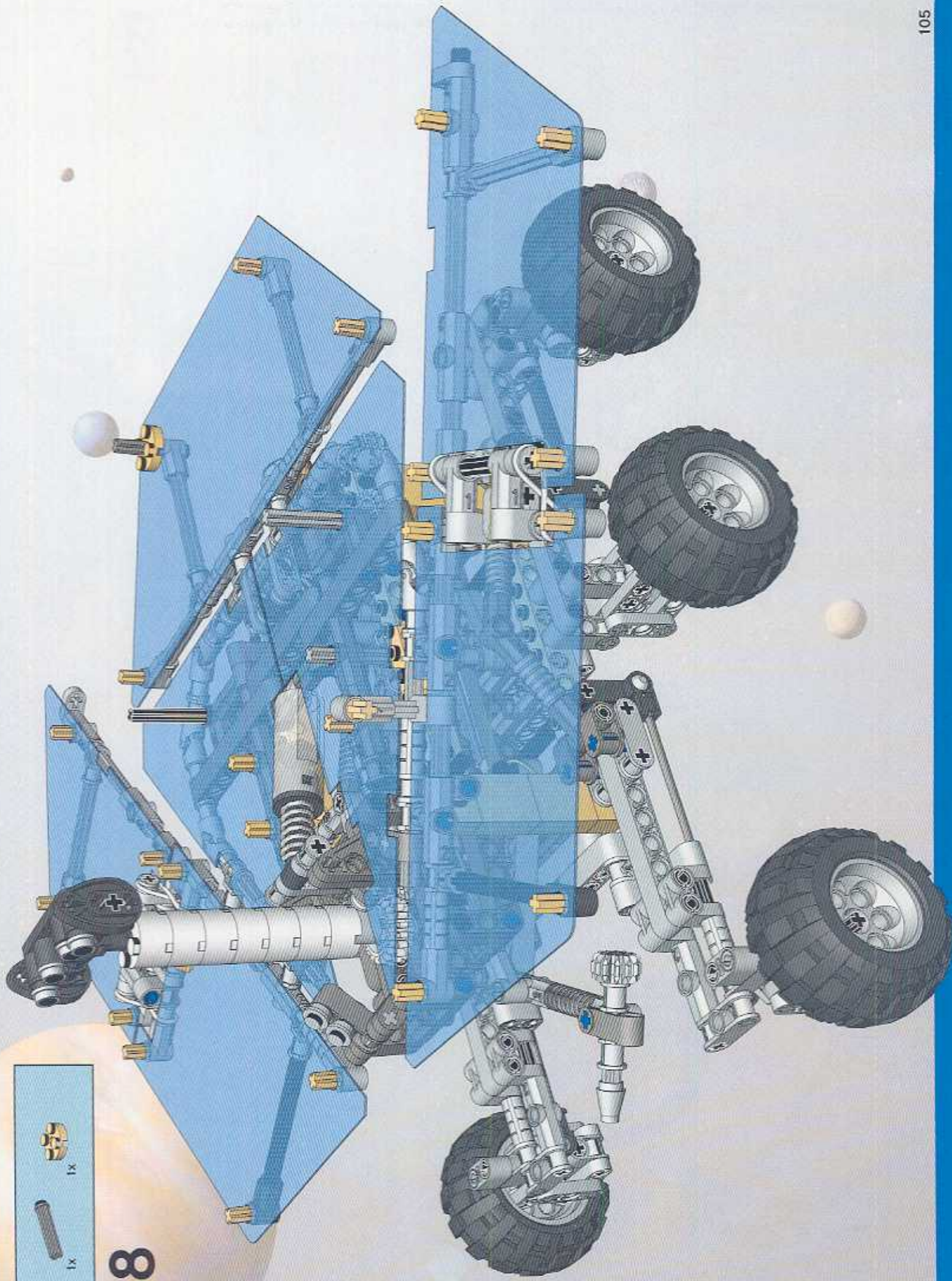

1x  1x 

68

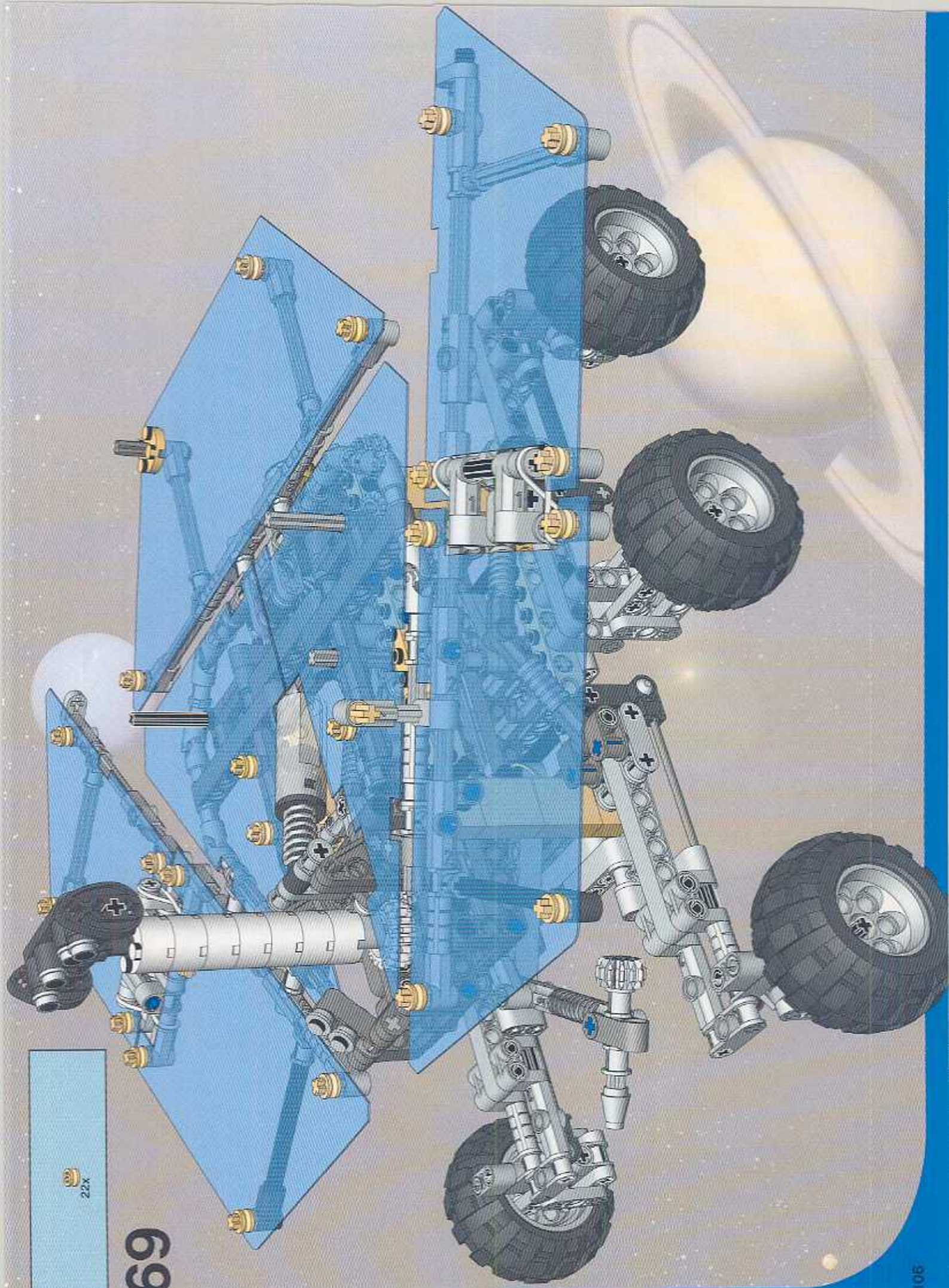

22x

69

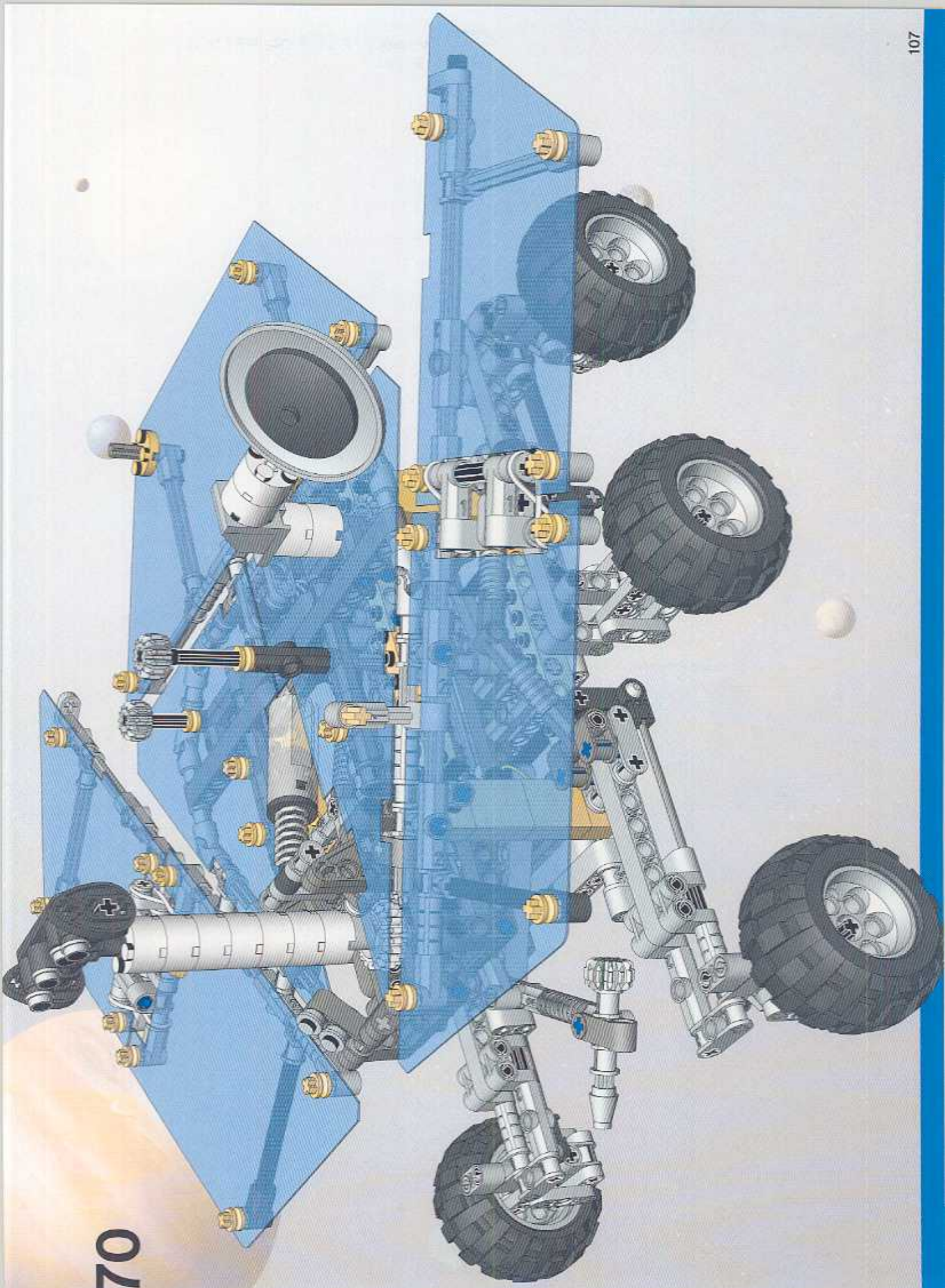

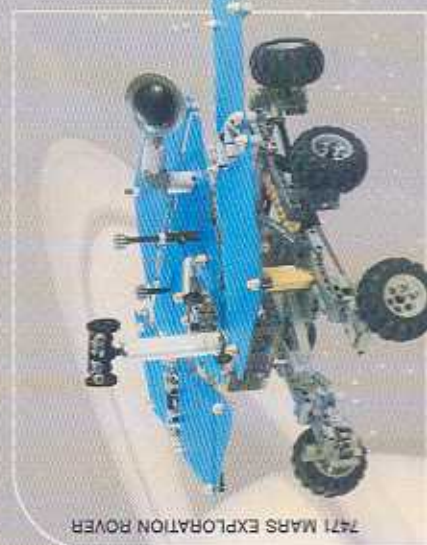

7471 MARS EXPLORATION ROVER



7469 MISSION TO MARS



7468 SATURN V MOON MISSION

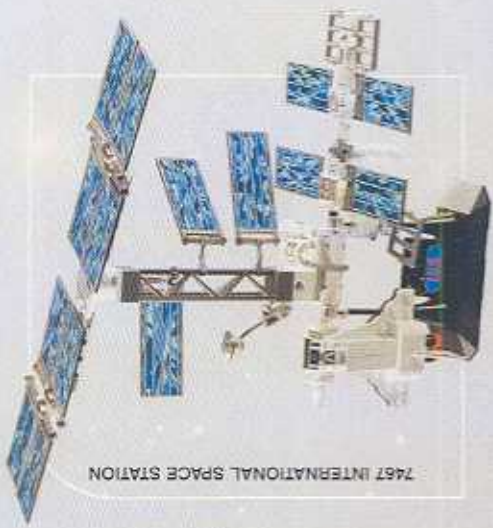

7467 INTERNATIONAL SPACE STATION



7470 SPACE SHUTTLE DISCOVERY

Win! Gagne! Gewinne! 当たります



Win LEGO® products

We would really like to know what you think about your new LEGO® product.

If you could help us by answering a few questions at www.acnielsen.aim.dk/lego then you are in with a chance of winning an exciting LEGO® prize.

It will only take you about 3 minutes!



Estimado usuario LEGO®

Al contestar algunas preguntas en inglés, francés, alemán o japonés, en el sitio www.acnielsen.aim.dk/lego, podrás participar en el sorteo de algunos valiosos premios LEGO®.



Gagne des produits LEGO®

Nous aimerions beaucoup savoir ce que tu penses de ton nouveau produit LEGO®.

Si tu veux bien nous aider en répondant à quelques questions sur www.acnielsen.aim.dk/lego, tu recevras peut-être bientôt l'un des nombreux super-prix offerts par LEGO aux participants.

Et cela ne te prendra que 3 minutes environ !



Kedves Ifjú LEGO® Vásárló

Ha ellátogat az www.acnielsen.aim.dk/lego honlapra és ott angol, francia, német vagy japán nyelven megválaszolod néhány kérdést, akkor részt veszel egy versenyben, amelyben értékes LEGO® díjakat nyerhetsz.



Gewinne LEGO® Produkte

Wir sind sehr an deiner Meinung über dein neues LEGO® Produkt interessiert.

Wenn du uns den Gefallen tust und unter www.acnielsen.aim.dk/lego Fragen beantwortest, kannst du einen tollen LEGO Preis gewinnen.

Das Ganze dauert nur etwa 3 Minuten!



Caro Consumidor da LEGO®

Ao responder a algumas perguntas em inglês, francês, alemão ou japonês no endereço www.acnielsen.aim.dk/lego irá participar num concurso para ganhar valiosos prémios da LEGO®.



抽選でレゴ製品が当たります

私たちは、皆さんがレゴ製品についてどんな感想をお持ちか、是非知りたいと思っています。

www.acnielsen.aim.dk/legoにアクセスいただき、質問にご回答いただきますと、抽選で楽しいレゴ製品が当たります。

アンケートのご回答には、ほんの3分ほどしかかかりません!

59640



LEGO and the LEGO logo are trademarks of the LEGO Group.
© 2003 The LEGO Group.

© 2003 Discovery Communications, Inc. All rights reserved. Discovery Channel, logo and Explore Your World are trademarks of Discovery Communications, Inc. Todos los derechos reservados. Discovery Channel y logo son marcas de Discovery Communications, Inc., usadas bajo licencia. Tous droits réservés. Discovery Channel et logo sont des marques de commerce de Discovery Communications, Inc. Utilisées sous licence.