



STAR WARS

TM

75150



 [LEGO.com](https://www.lego.com)



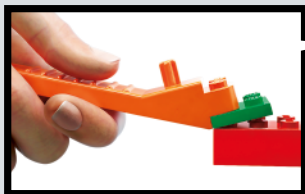
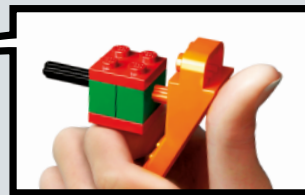
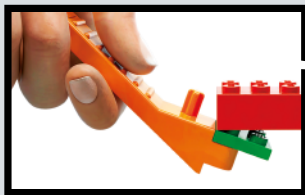

LEGO.com/brickseparator

EN IMPORTANT: Never modify the elements or use other projectiles than provided with this toy.
 DE WICHTIG: Die Elemente dürfen nicht verändert werden. Es dürfen ausschließlich die mit dem Spielzeug mitgelieferten Geschosse verwendet werden.
 FR IMPORTANT : Ne jamais modifier les éléments ni utiliser d'autres projectiles que ceux fournis avec ce jouet.
 IT IMPORTANTE: non modificare gli elementi o utilizzare proiettili non forniti con questo prodotto.
 NL BELANGRIJK: Verander niets aan de elementen en gebruik geen andere projectielen dan de bij het speelgoed geleverde.
 ES IMPORTANTE: No modifique los elementos ni utilice otros proyectiles diferentes a los suministrados junto con este juguete.
 DA VIGTIGT: Elementerne må ikke ændres, og der må ikke bruges andre projektiler end dem, der følger med legetøjet.
 IS MIKILVÆGT: Aldrei skal breyta einungum vörunnar eða nota önnur skot en þau sem fylgja þessu leikfangi.
 FI TÄRKEÄÄ: Älä koskaan tee osiin muutoksia tai käytä lelussa muita kuin sen sisältämiä ammuksia.
 SV VIKTIGT: Modifiera aldrig delarna och använd aldrig andra projektiler än de som medföljer denna leksak.
 NO VIKTIG: Elementene må ikke endres, og det må aldri brukes andre prosjektiler enn dem som følger med leketøyet.
 PT IMPORTANTE: Nunca modifique os elementos nem utilize projecteis que não tenham sido fornecidos com este brinquedo.
 EL ΣΗΜΑΝΤΙΚΟ: Ποτέ μην τροποποιείτε τα στοιχεία του παιχνιδιού και μην χρησιμοποιείτε άλλα βλήματα εκτός από αυτά που συνοδεύουν αυτό το παιχνίδι.
 JA 重要: 部品を改造したり、本製品に付属の発射体以外のもを使用しないでください。
 ZH 重要提示: 切勿更改组件或使用并非由本玩具附带的弹丸。
 KO 중요: 이들 부품을 수정하거나 이 완구와 함께 제공된 것이 아닌 발사체는 결코 사용하지 마십시오.
 RU ВАЖНО: Запрещается вносить изменения в элементы или использовать другие снаряды, отличные от тех, которые поставляются с данной игрушкой.
 PL WAŻNE: Nigdy nie modyfikować elementów ani nie używać innych pocisków niż dostarczonych z zabawką.
 CZ UPOZORNĚNÍ: Nikdy neupravujte součástky a nepoužívejte jiné projektily než ty, které jsou dodávány s touto hračkou.
 SK UPOZORNENIE: Nikdy neupravujte súčiastky a nepoužívajte iné projektily než tie, ktoré sú dodávané s touto hračkou.
 HU FONTOS: Az elemeket nem szabad módosítani, és a játékhöz adott lövedékek helyett sem szabad más használni.
 UA УВАГА: Ніколи не модифікуйте елементи, Використовуйте тільки снаряди, що входять у комплект цієї іграшки.
 HR VAŽNO: Nemojte nikad mijenjati elemente ili koristiti druge projekte osim onih koji bili priloženi uz ovu igračku prilikom kupnje.
 SR VAŽNO: Nemojte da modifikujete elemente i ne koristite druge projekte osim onih koji dolaze uz ovu igračku.
 MK VAŽNO: Nikogash ne menuvajte gi elementite i ne koristete drugi projektili od tie što vi se dadeni so igračkata.
 SL POMEMBNO: Nikoli ne spreminjajte elementov in uporabljajte le izstrelke, ki so bili priloženi tej igrački.
 RO IMPORTANT: Nu modificați niciodată elementele și nu utilizați alte proiectile decât cele furnizate cu această jucărie.
 BG ВАЖНО: В никакъв случай не видоизменяйте елементите и не използвайте други снаряди освен предоставените с тази играчка.
 LV SVARĢIĢ: Nekad nepārveidojiet rotāļietas elementus, vienmēr izmantojiet tikai tas komplektā iekļautās lodītes.
 ET OLULINE: Mänguasja osi ei tohi teistega asendada, kasutada võib ainult kaasasolevat heitkeha.
 LT SVARBU: Niekuomet nekeiskite elementų ir naudokite tik tuos šovinius, kurie yra pridėti prie šio žaislo.
 TR ÖNEMLİ: Hiçbir zaman parçalarıda değışiklik yapmayın veya bu oyuncakla verilenler dışında fırlatıcılar kullanmayın.
 AR ملاحظة مهمة: تجنب تعديل العناصر أو استخدام مقذوفات أخرى خلاف المرفقة مع هذه اللعبة.
 ID PENTING: Jangan pernah memodifikasi elemen atau menggunakan pelet lain selain yang disediakan bersama mainan ini.
 MS PENTING: Jangan ubah suai elemen atau guna peluncur lain selain daripada yang disediakan untuk alat mainan ini.

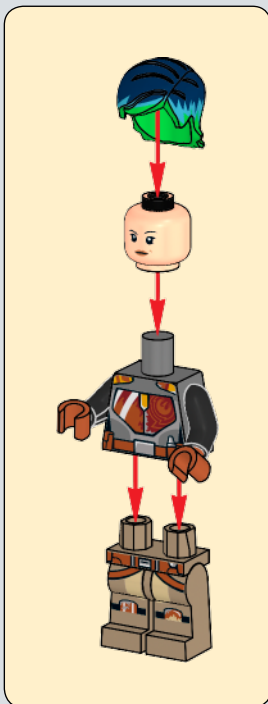
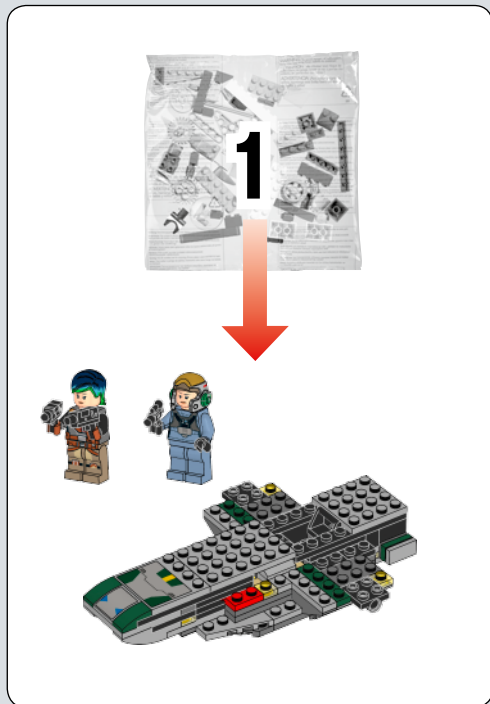

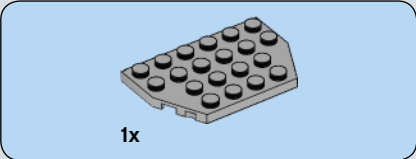
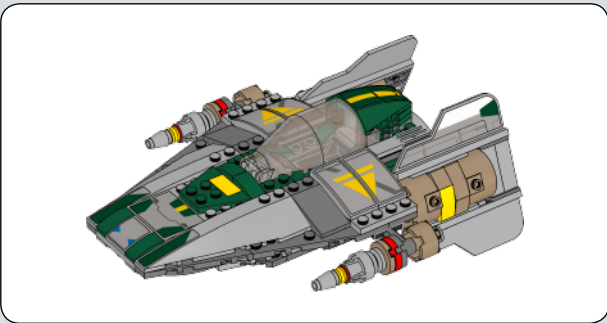

1

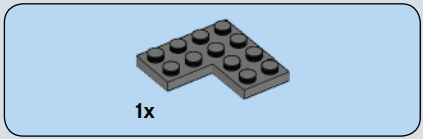
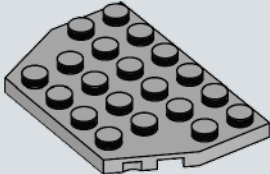

2

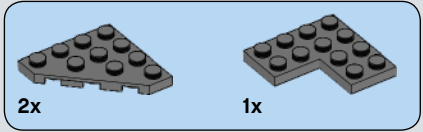
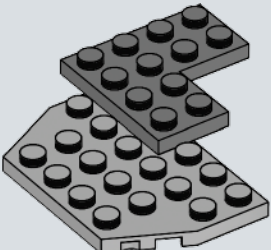

3

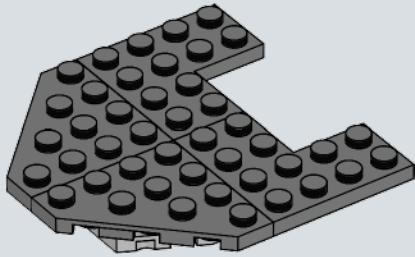

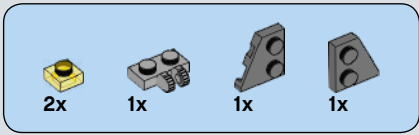

4

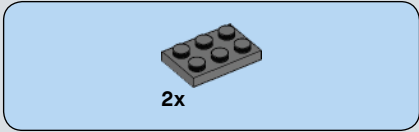
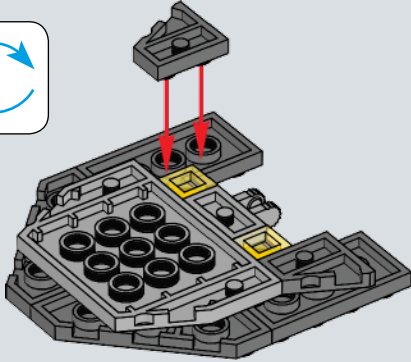

5

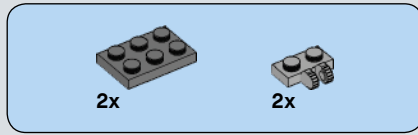
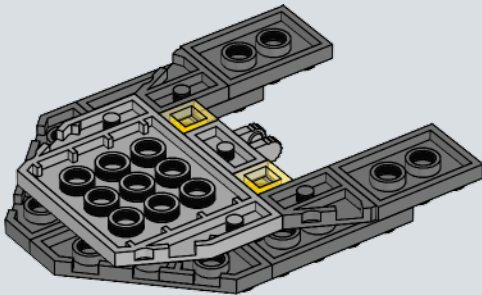

6

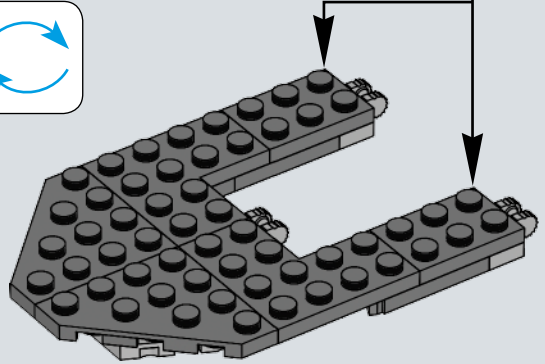
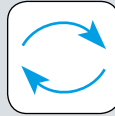
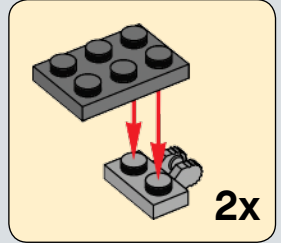

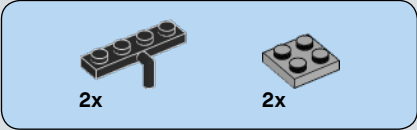

7

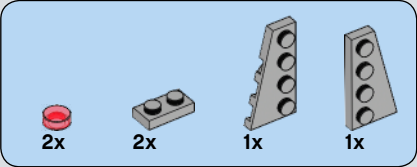
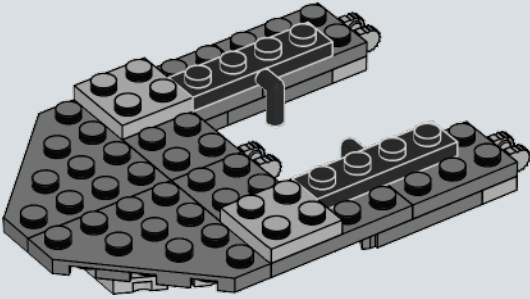

8

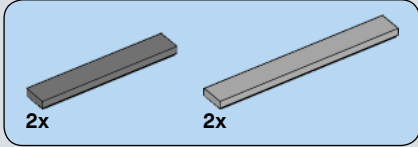
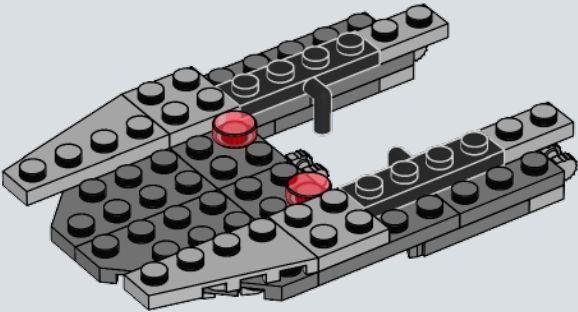

9

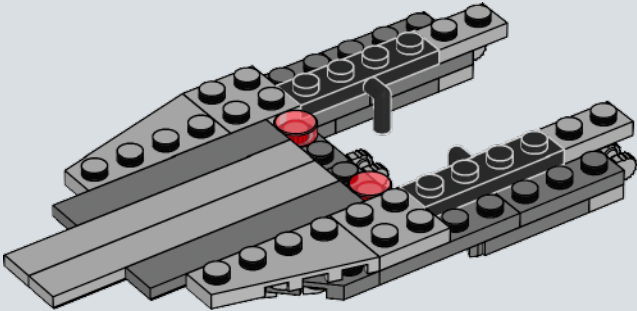

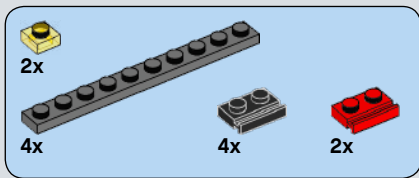

10

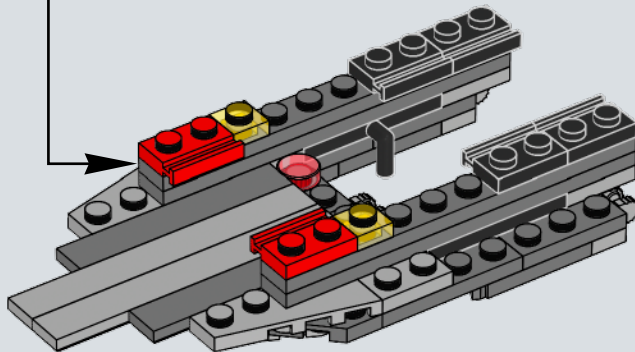
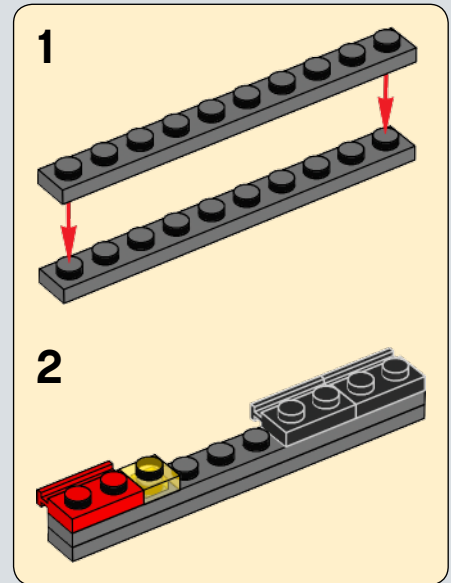
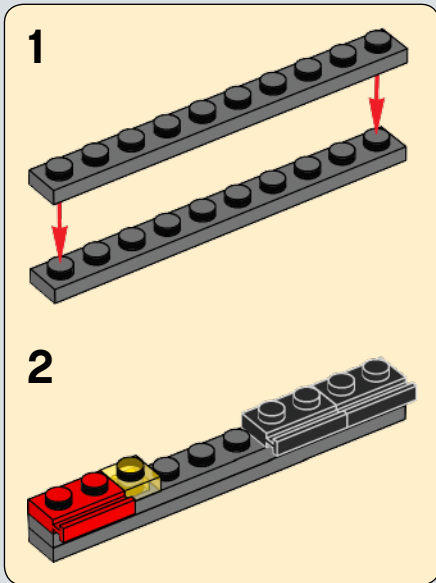

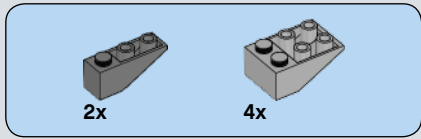

11

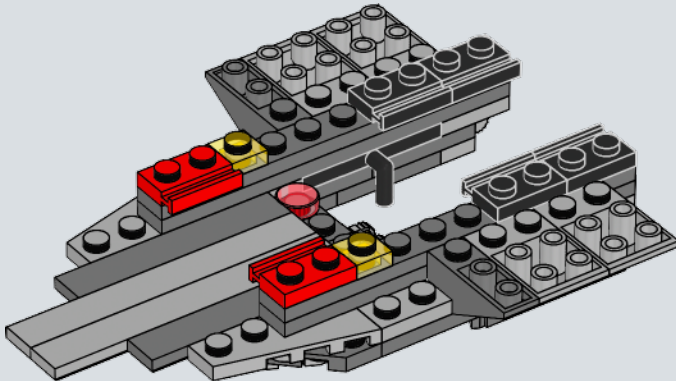

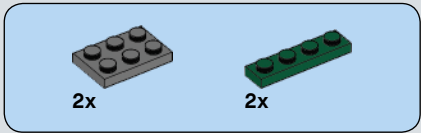

12

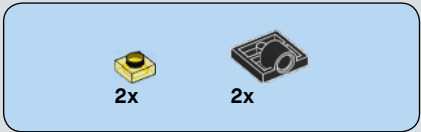
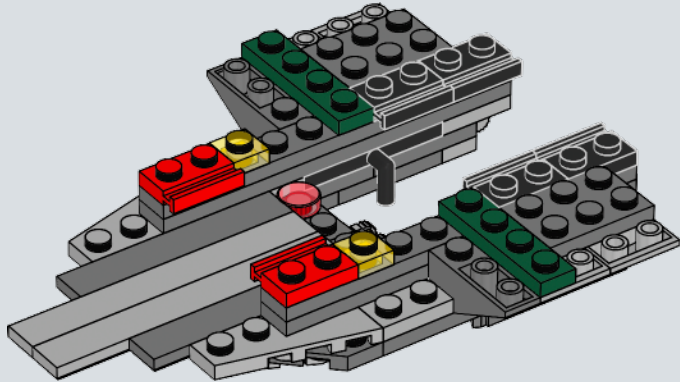

13

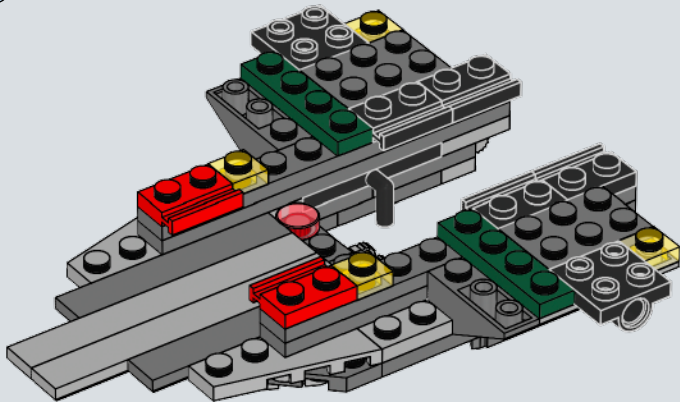

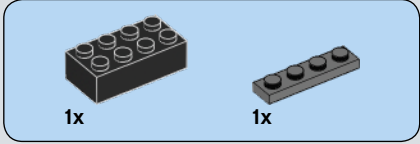
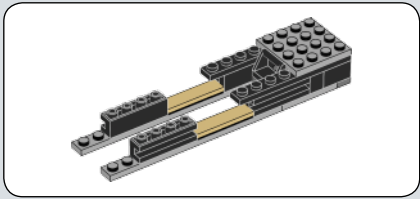

14

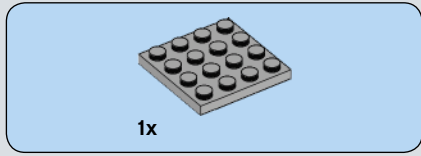
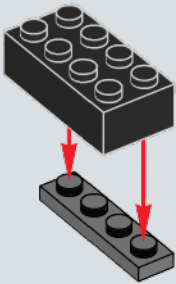

15

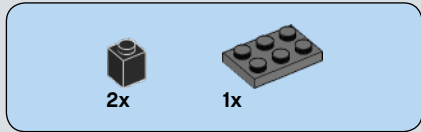
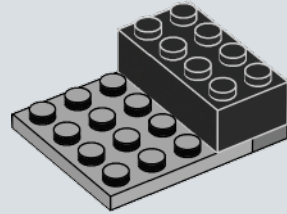

16

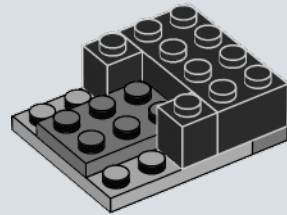

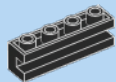

2x

17

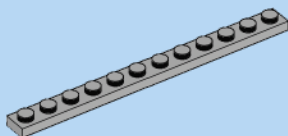
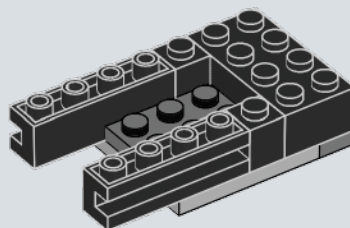

2x



1x

18

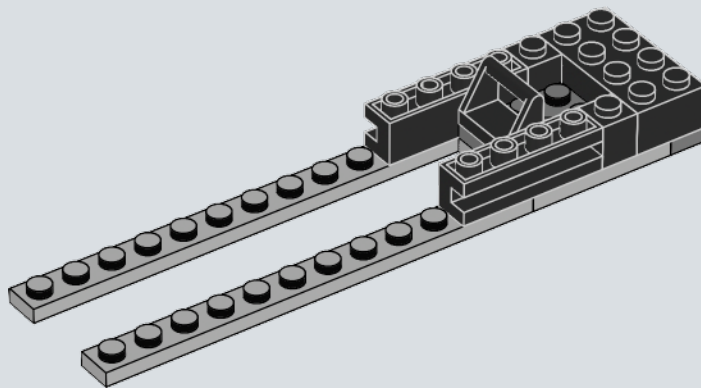

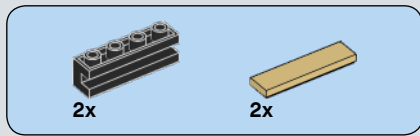

19

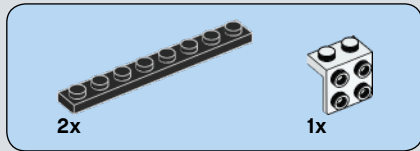
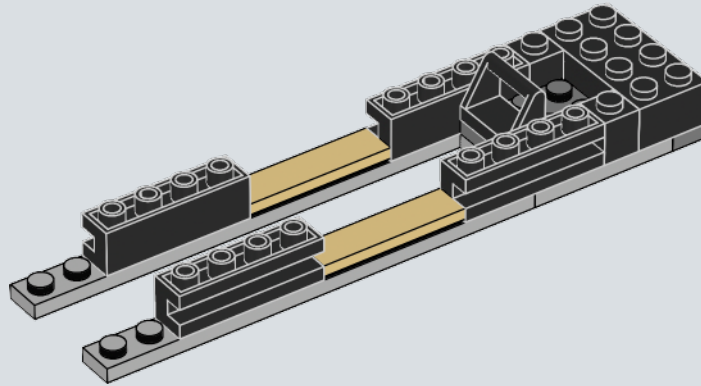

20

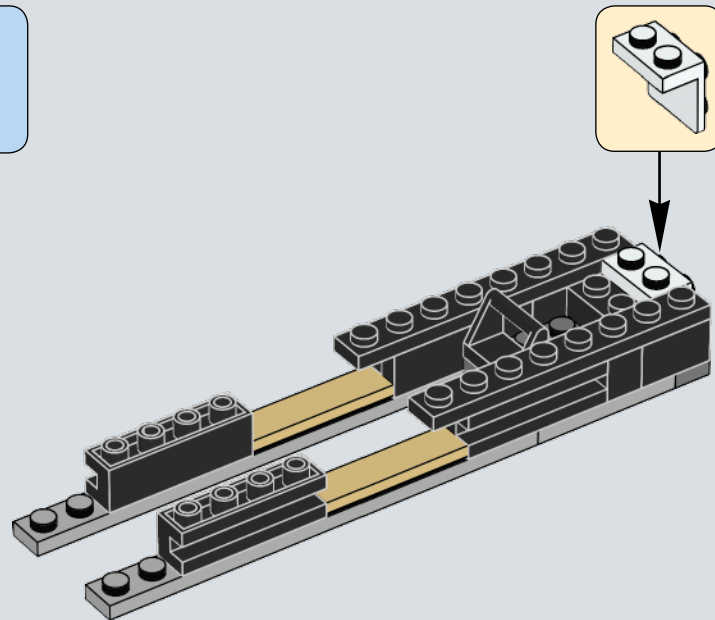

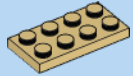

1x

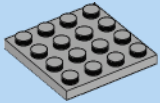

1x

23

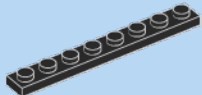
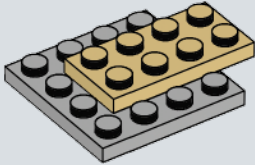

2x

24

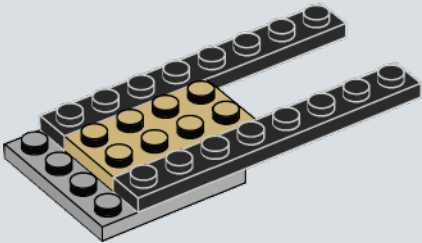

2x



1x

25

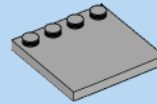
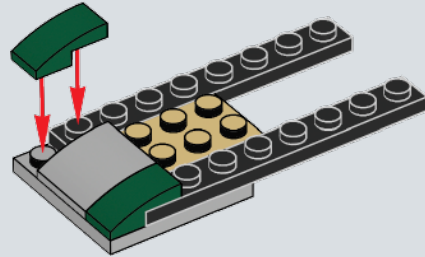

1x

26

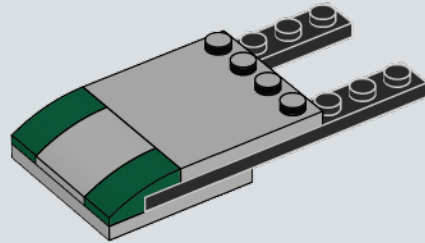

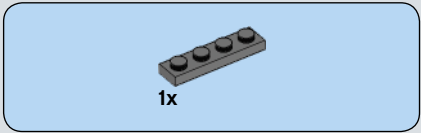

27

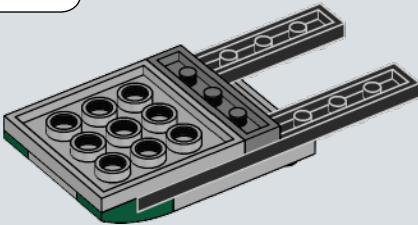

28

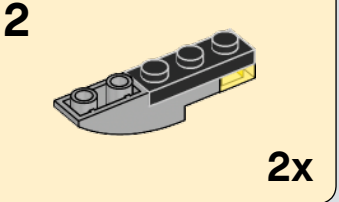
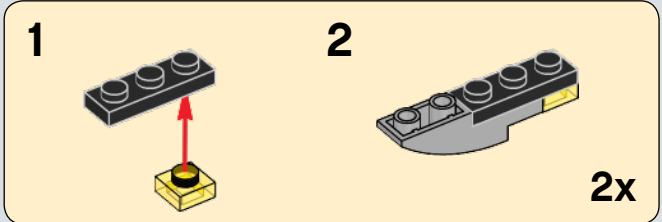

2x

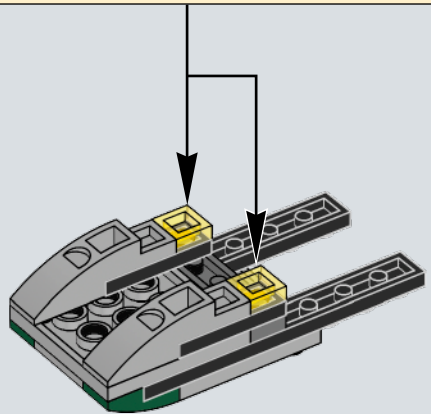

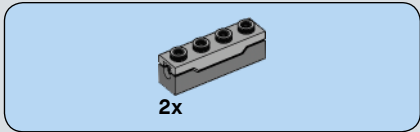

29

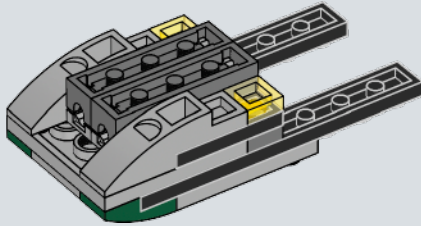

30

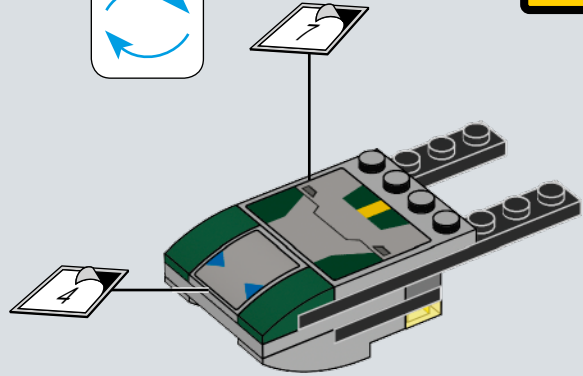
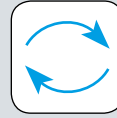

31

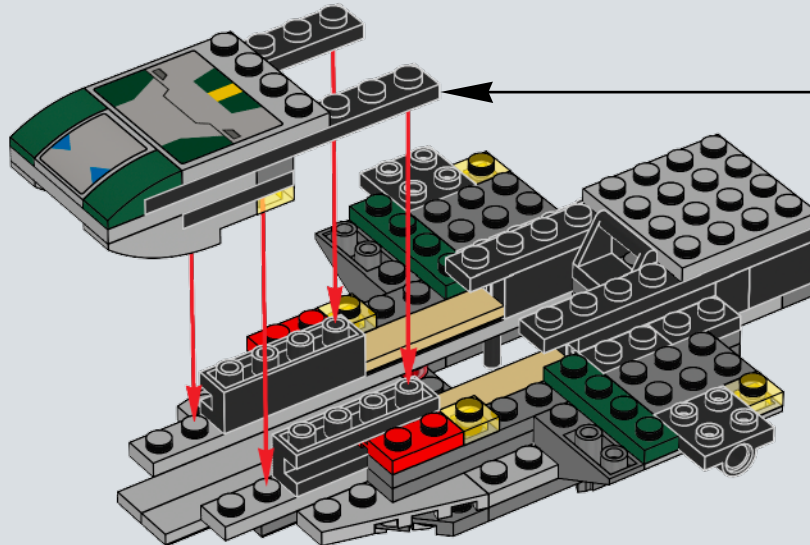

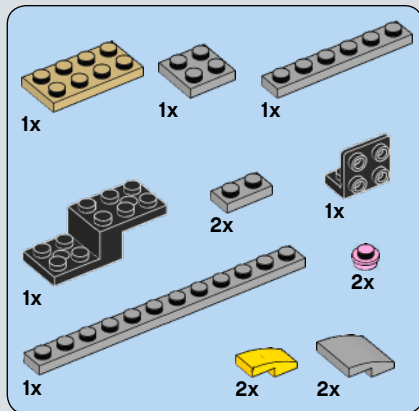

32

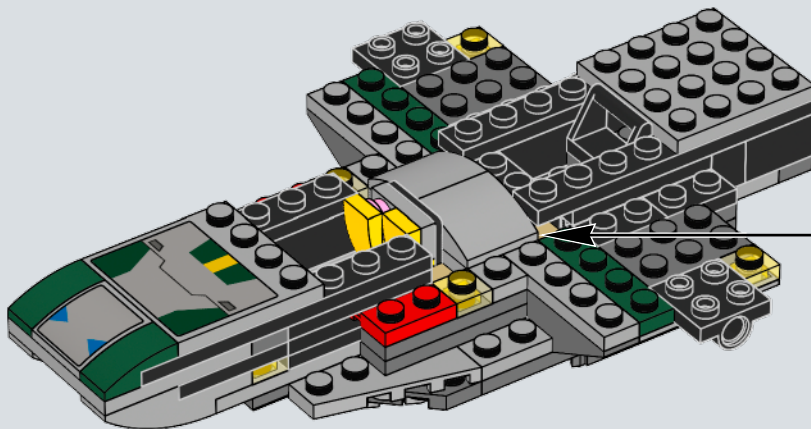
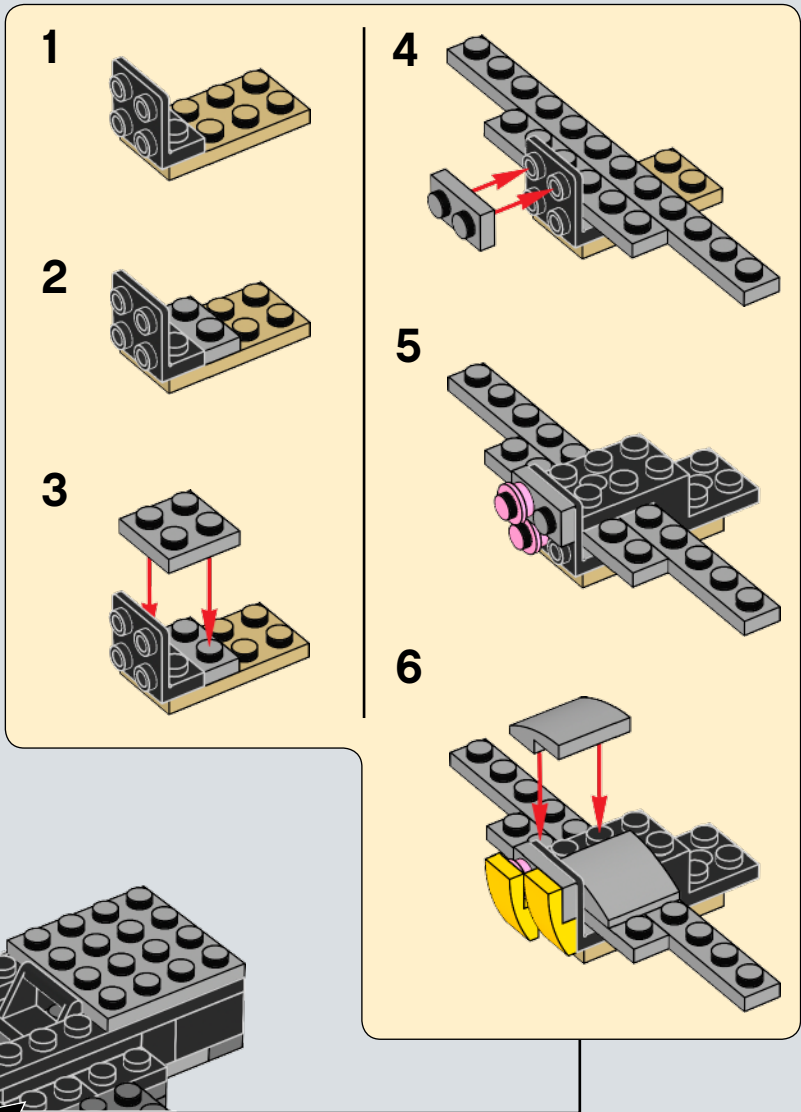

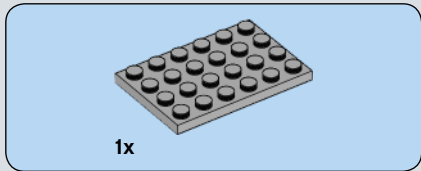

33

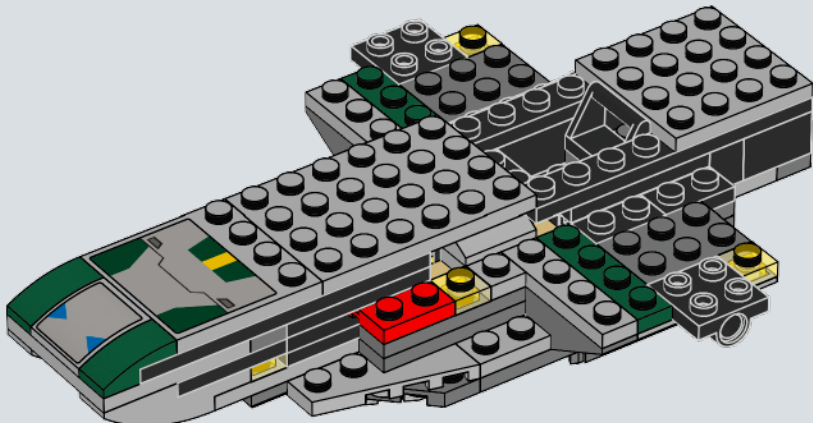

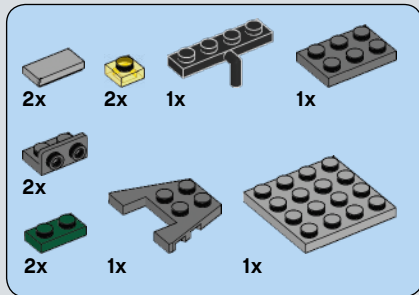

34

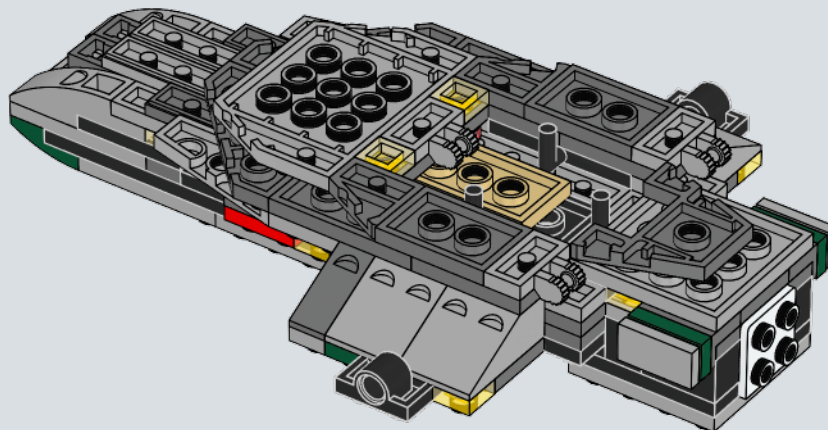
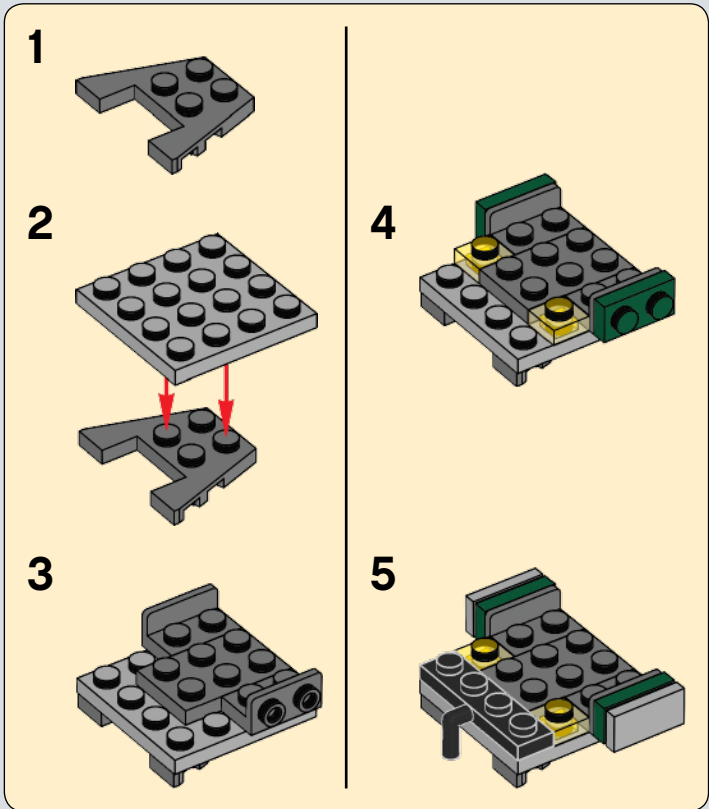
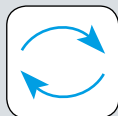



2x

35

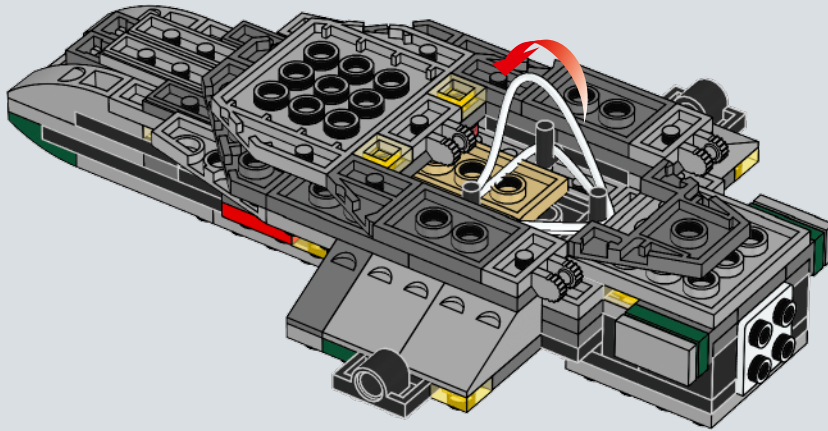

3x

36

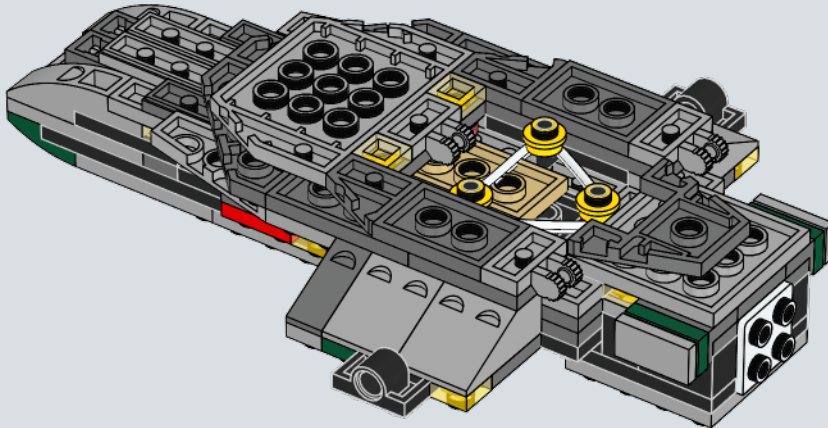

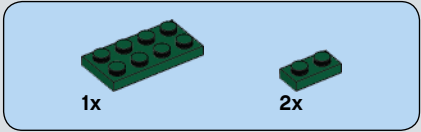
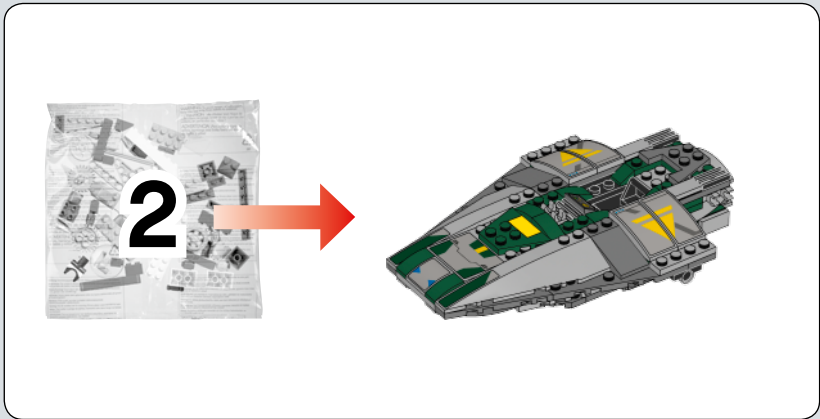

37

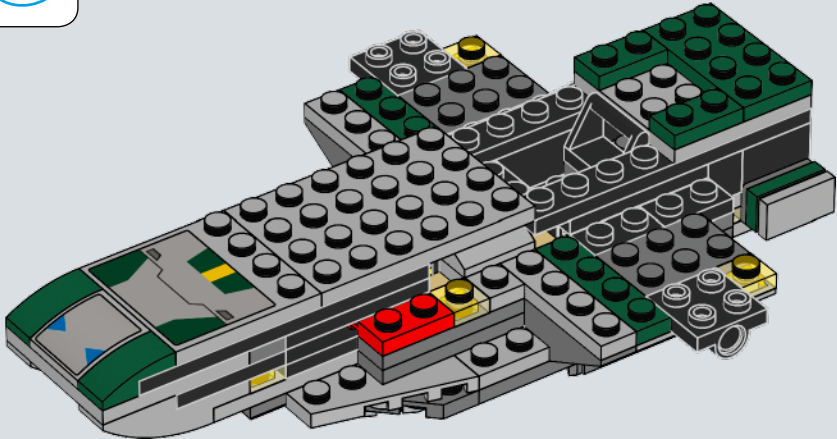

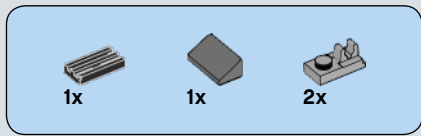

38

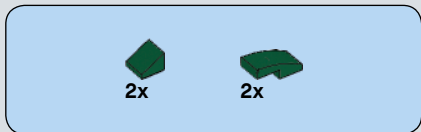
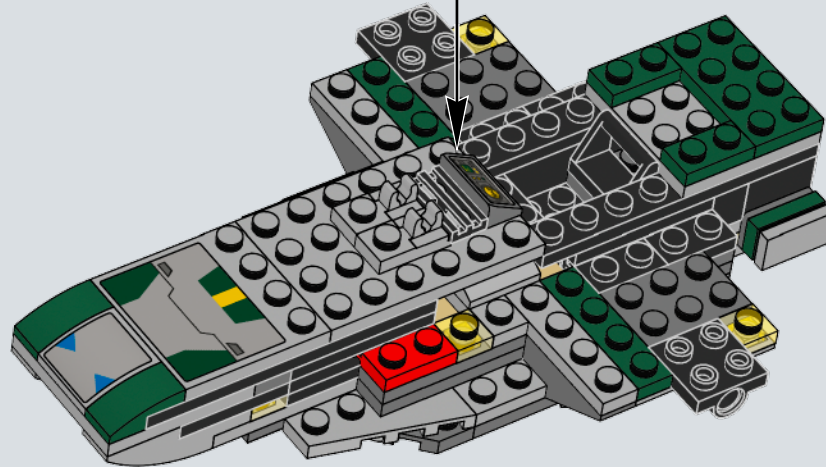

39

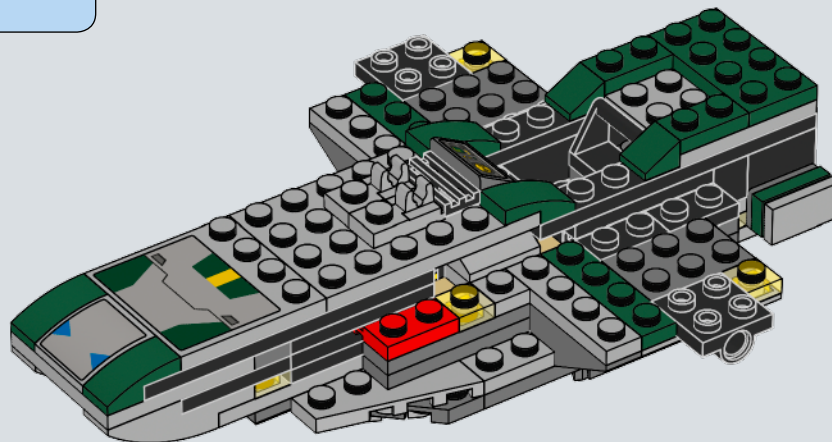



2x



2x

40

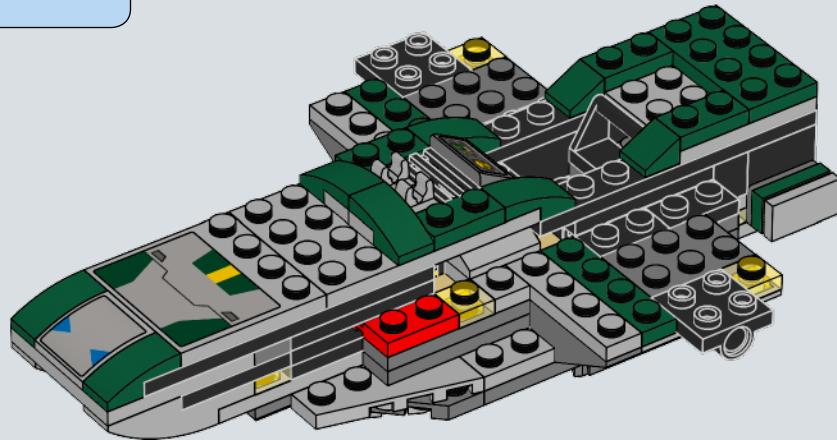

1x

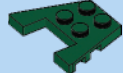

1x

41

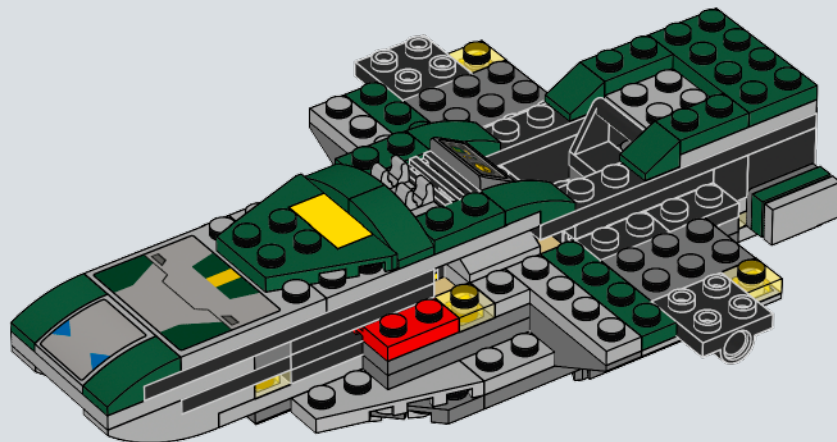



4x

42

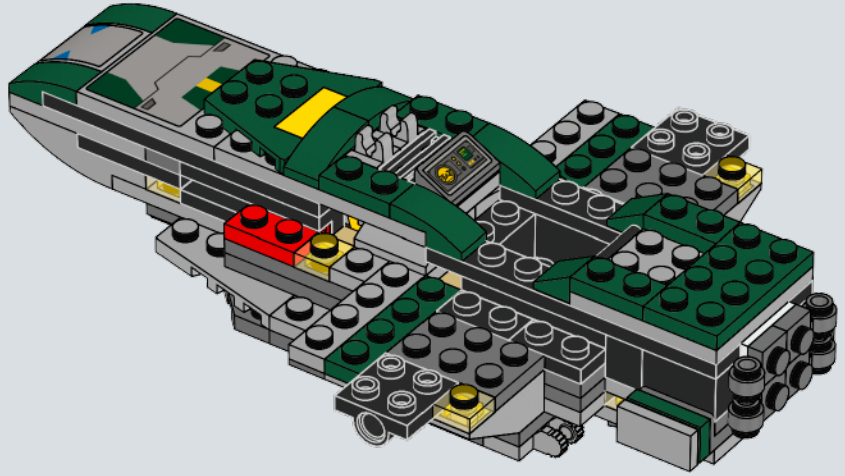

2x



4x

43

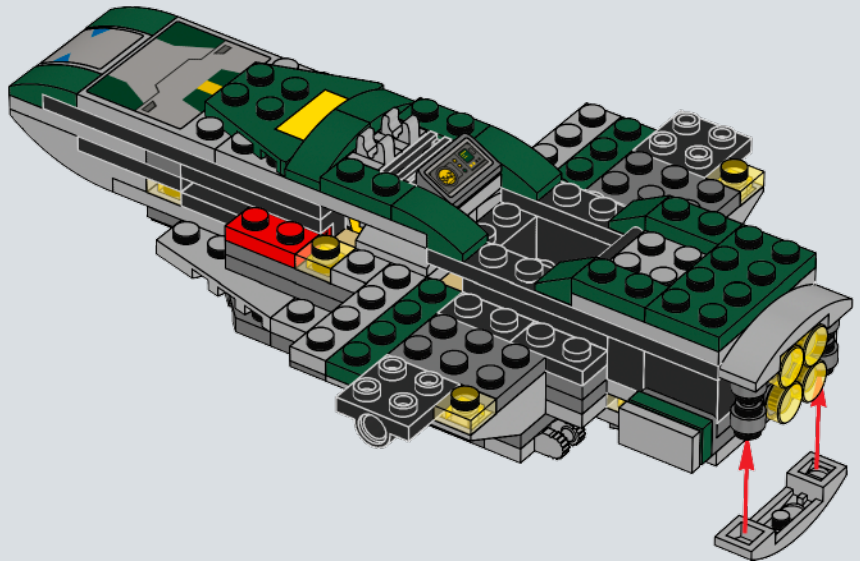

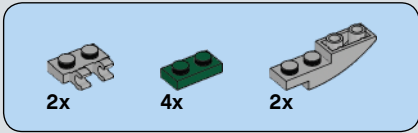

44

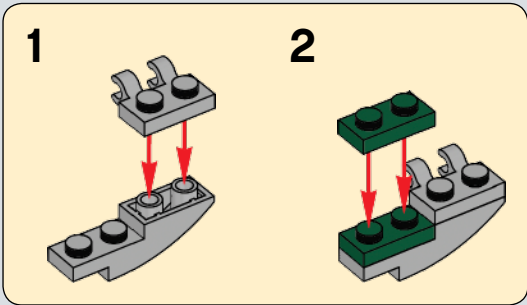

2

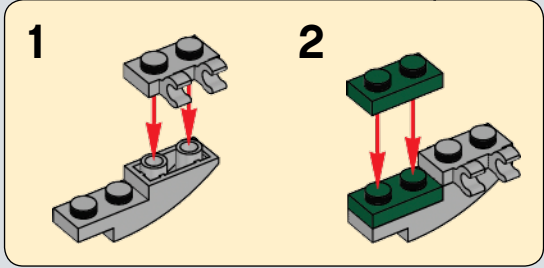
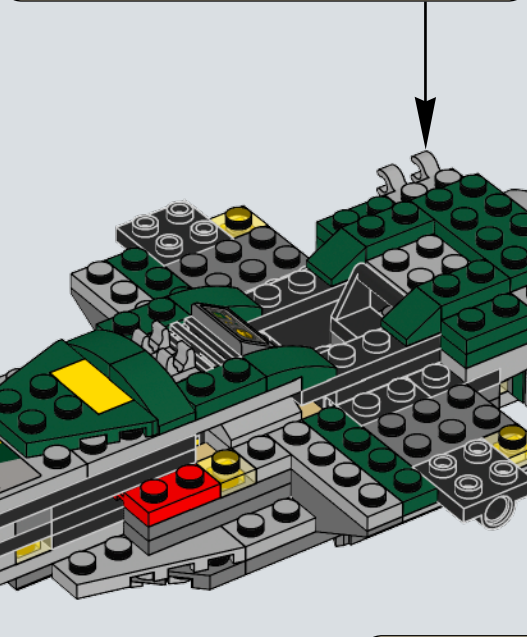

2

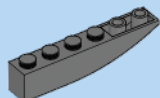

2x

45

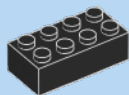
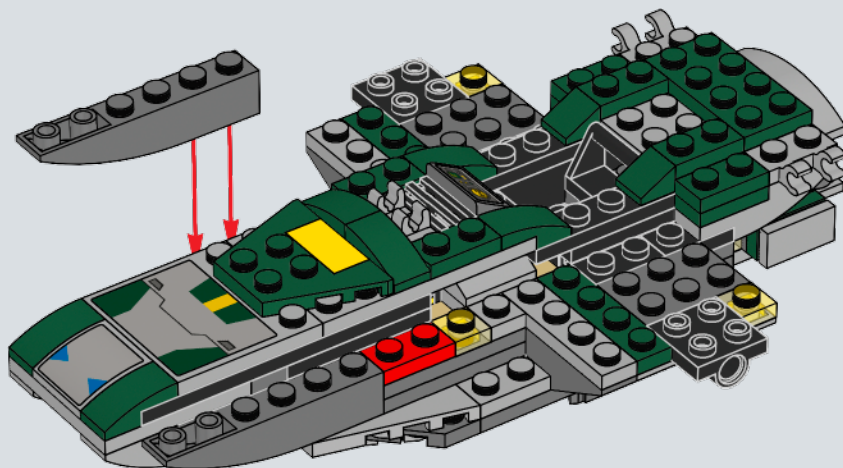

2x

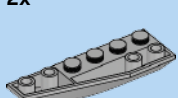

1x

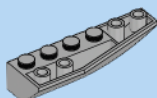

1x

46

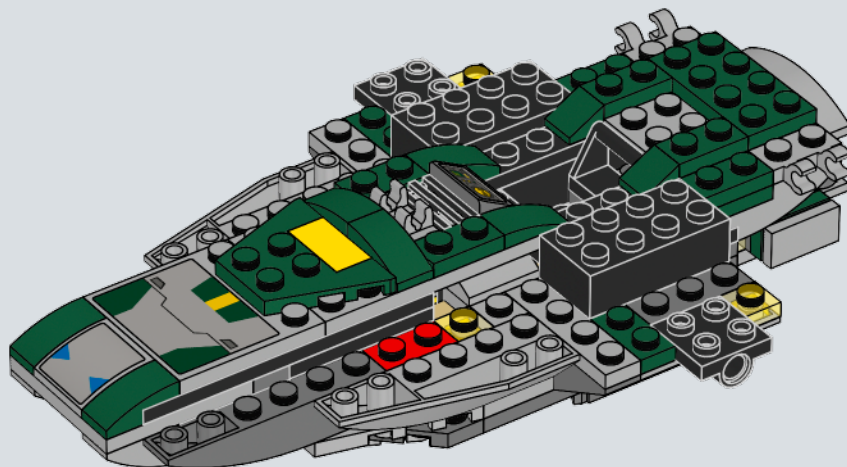

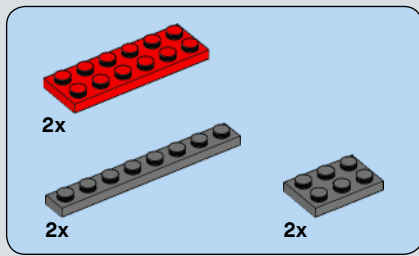

47

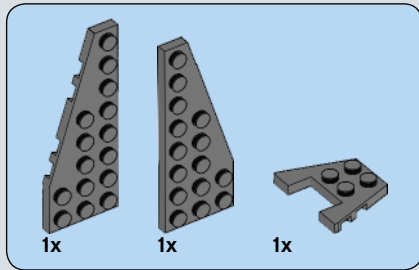
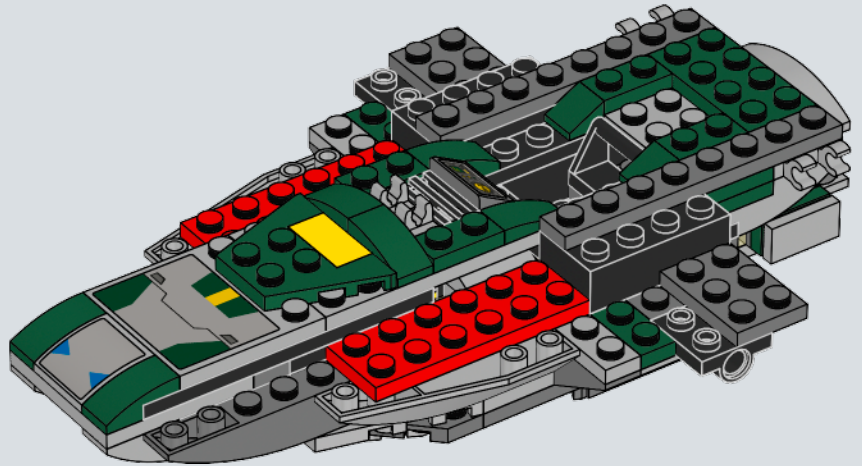

48

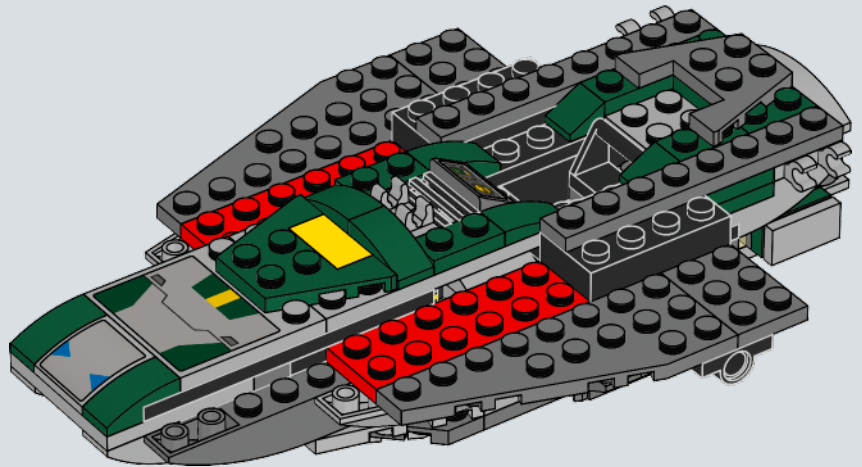

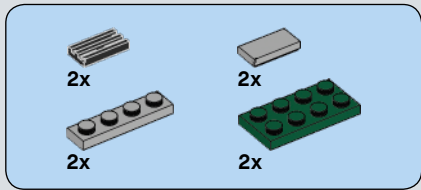

49

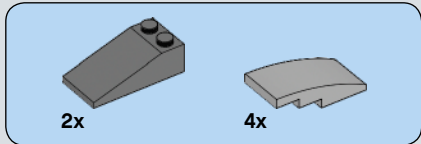
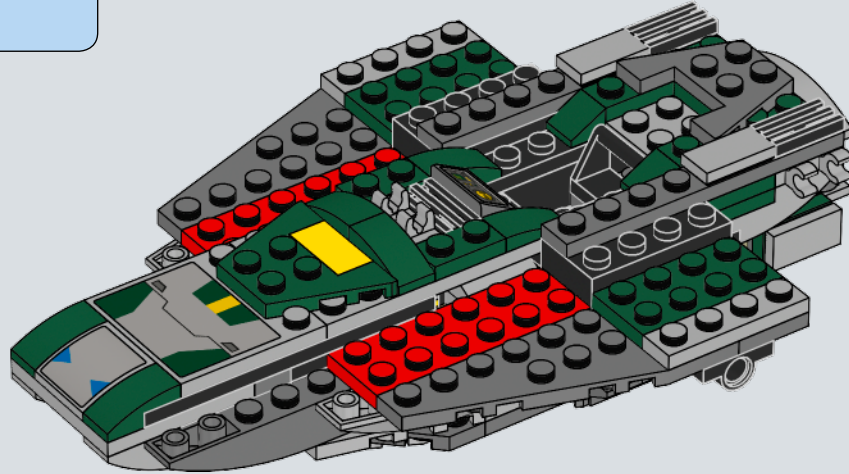

50

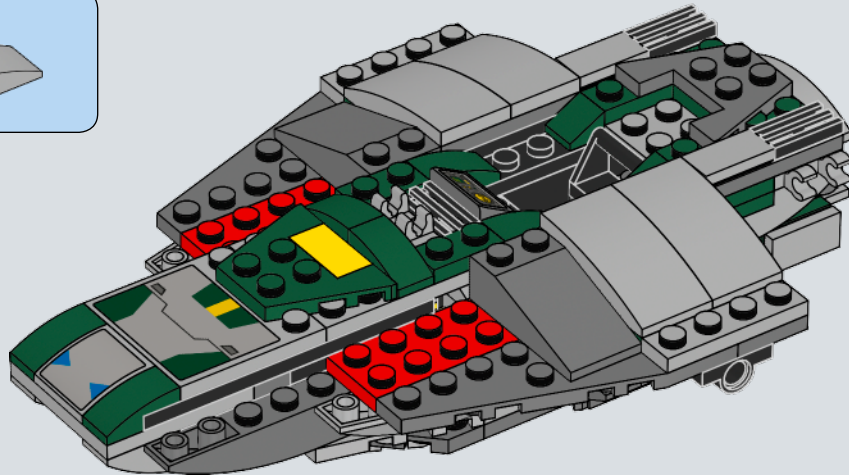

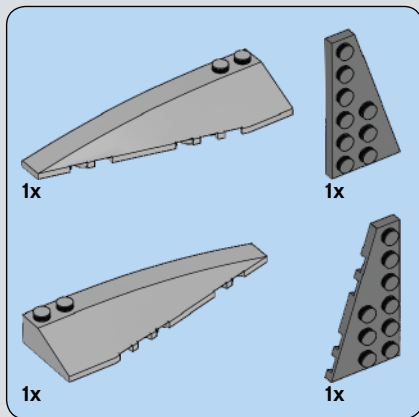

51

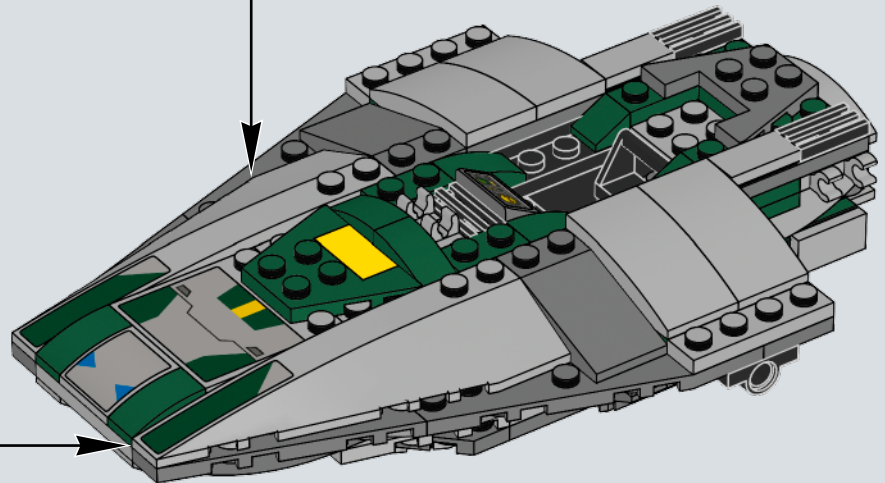
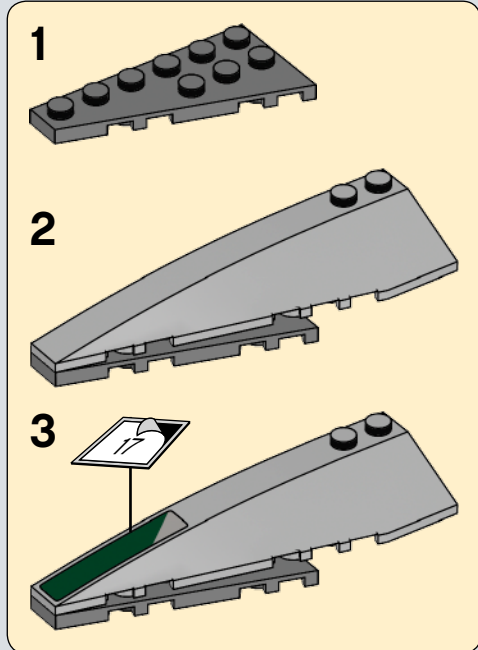
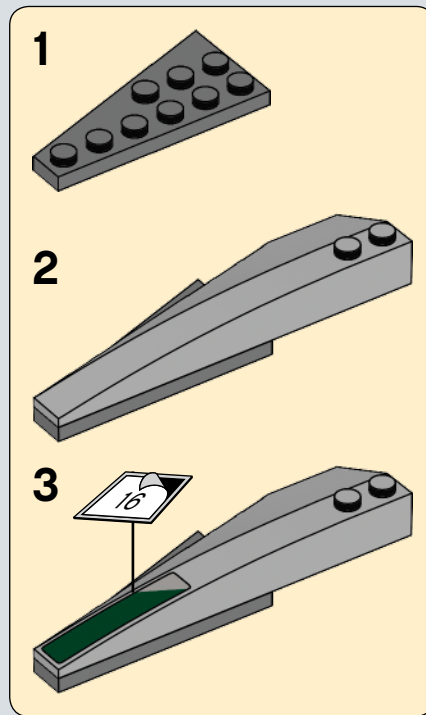

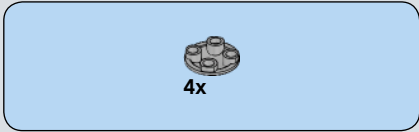
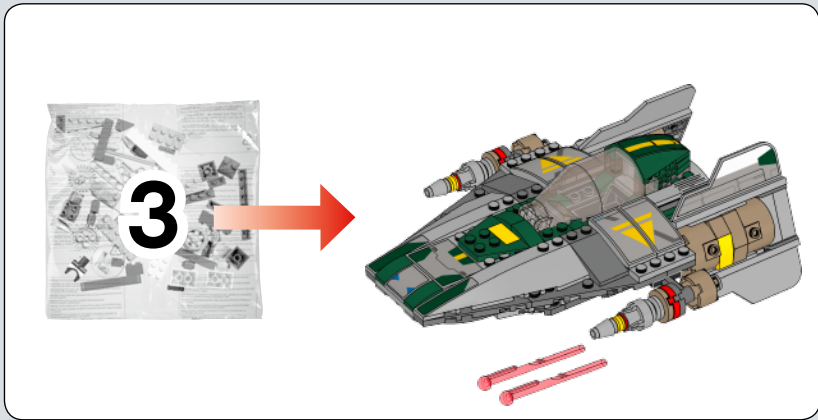

52

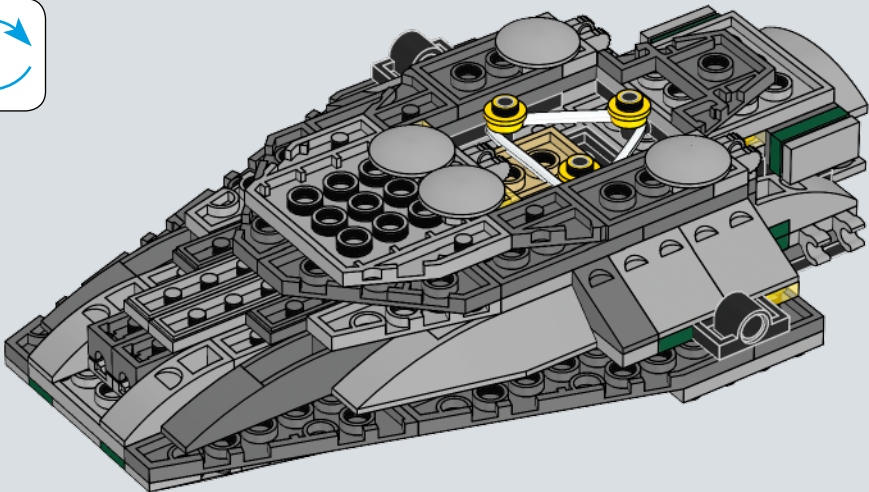

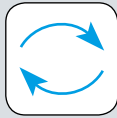

53

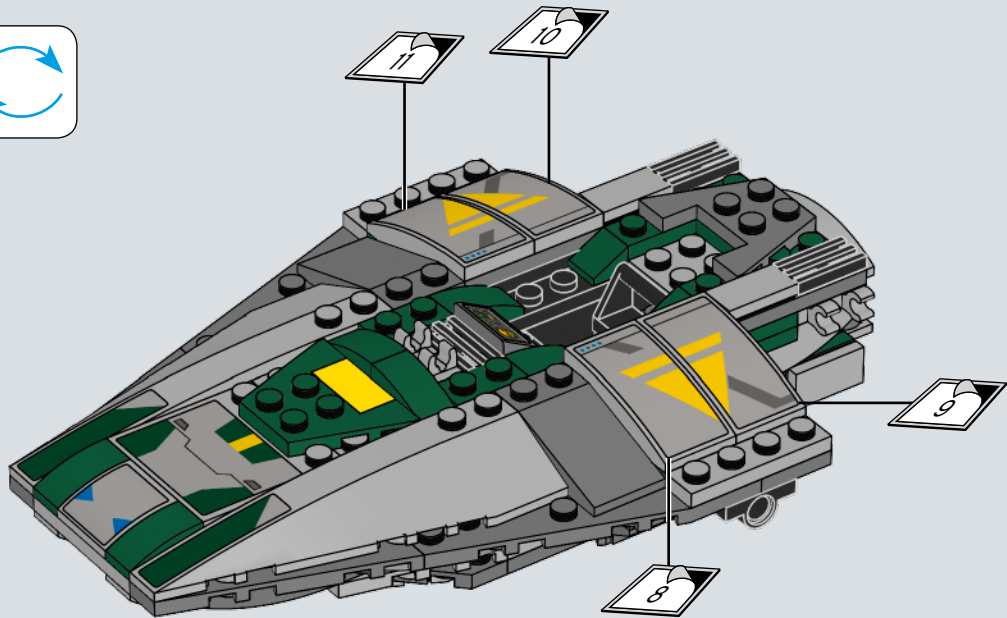

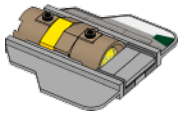

1x

54

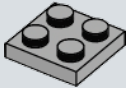

2x

55

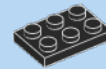
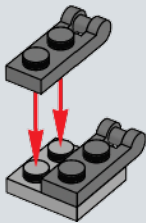

1x

56

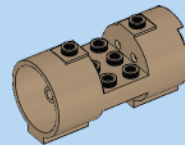
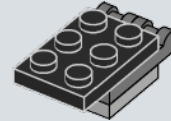

1x

57

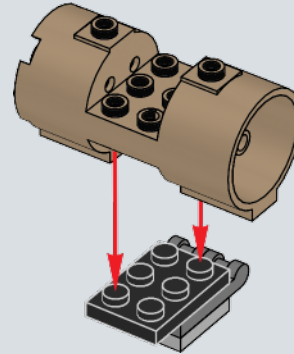



2x

58

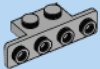
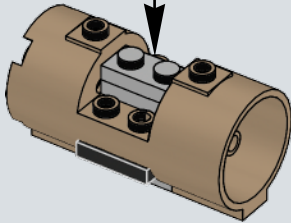
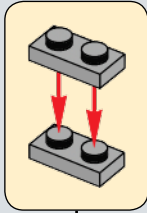

2x

59

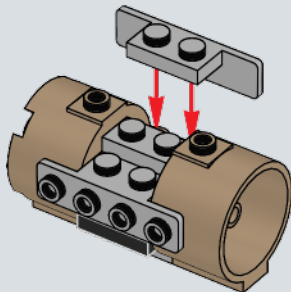

1x



1x

60

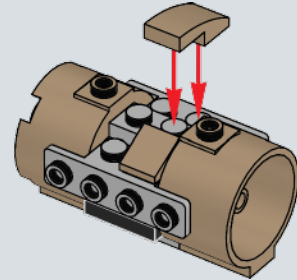

1x



1x

61

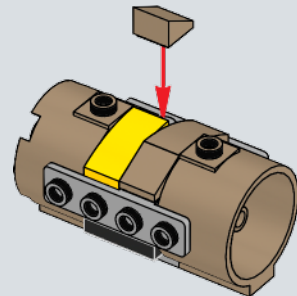



1x

62

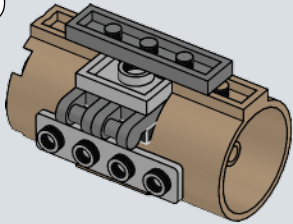

1x



1x



1x

63

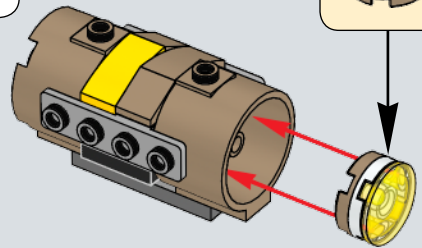
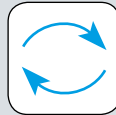

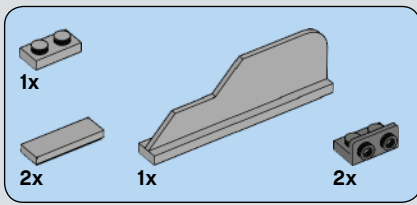

64

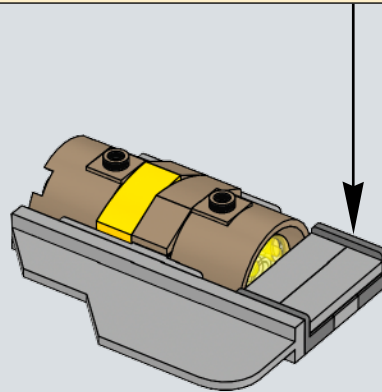
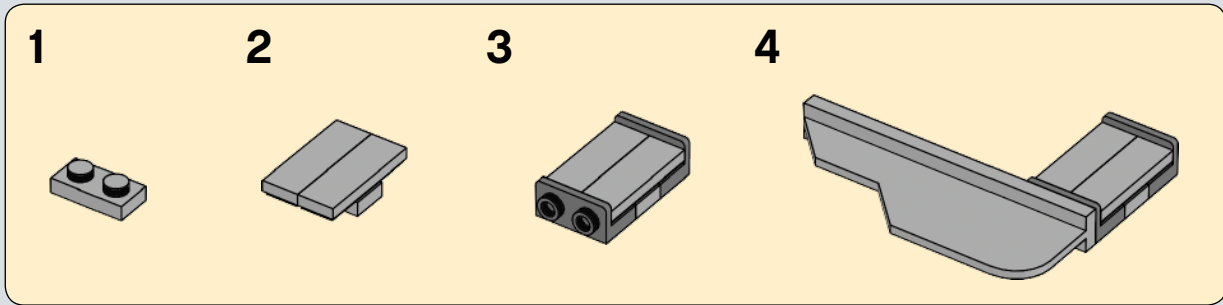

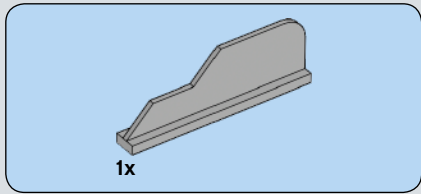

65

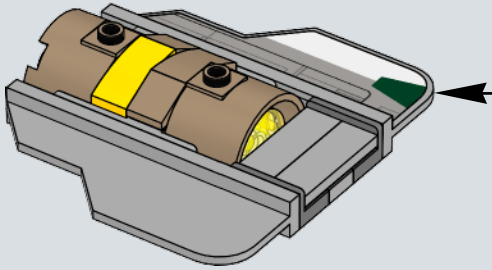
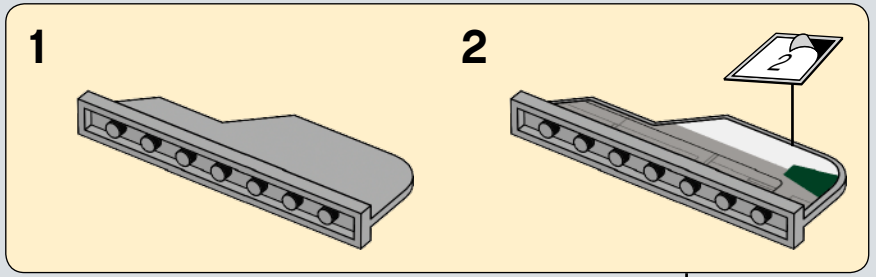

66

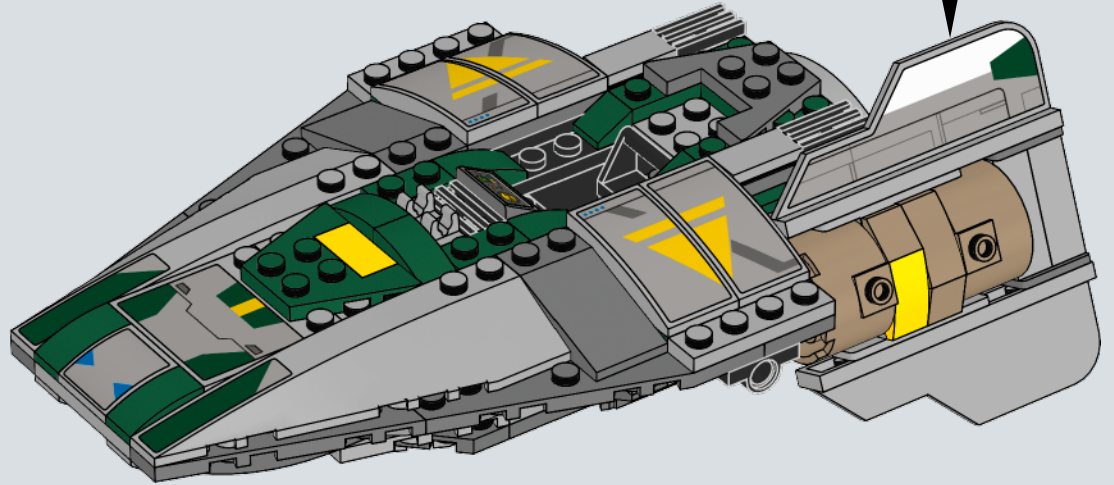

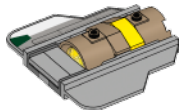

1x

67

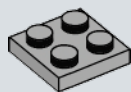

2x

68

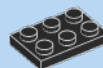
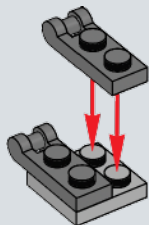

1x

69

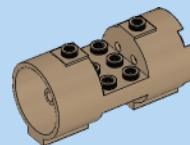
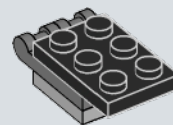

1x

70

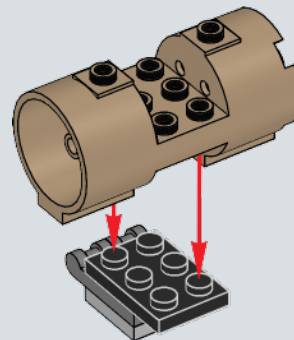



2x

71

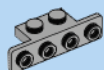
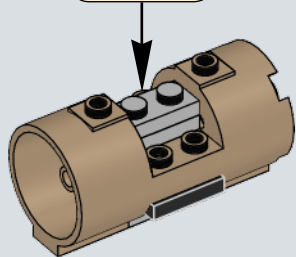
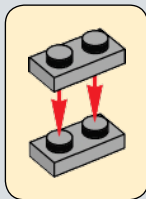

2x

72

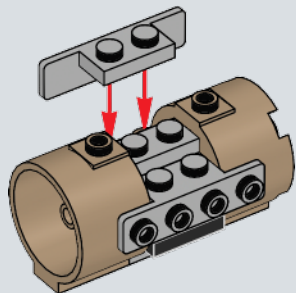

1x



1x

73

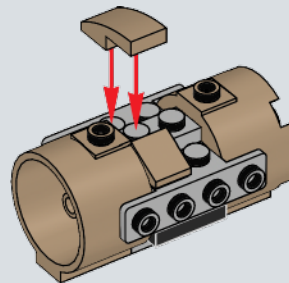

1x



1x

74

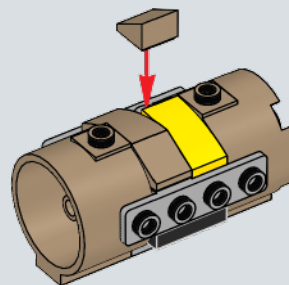

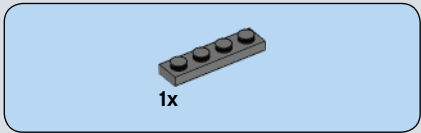

75

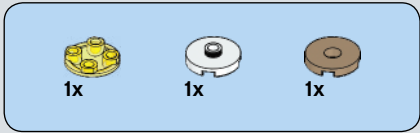
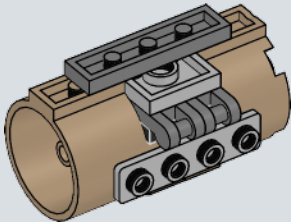

76

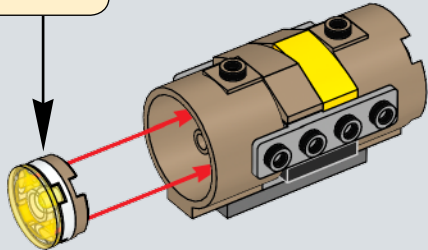
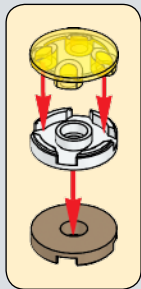

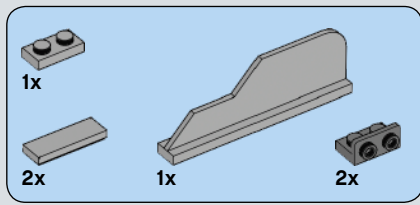

77

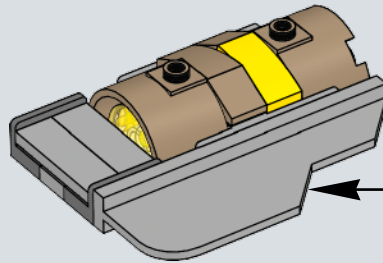
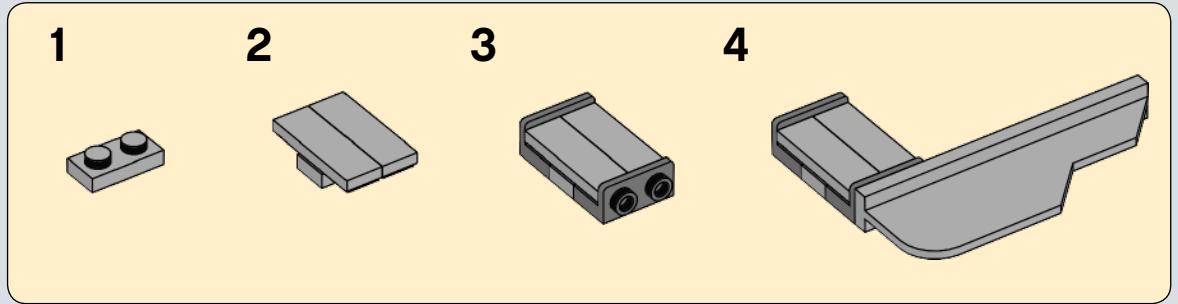

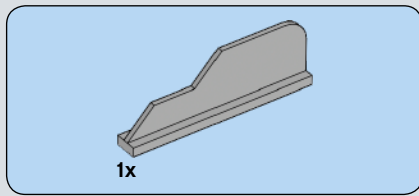

78

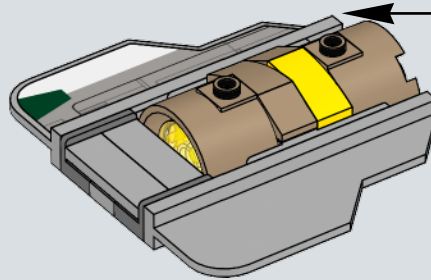
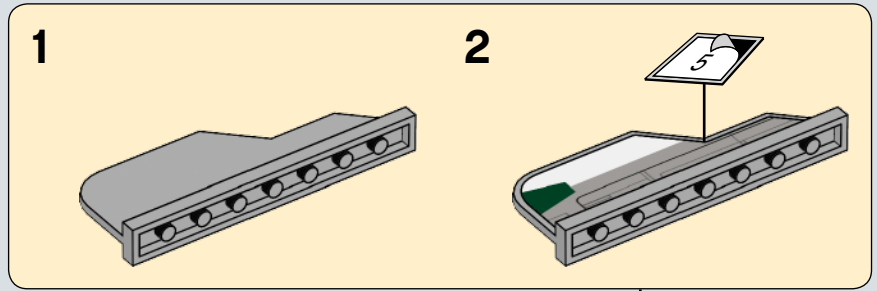

79

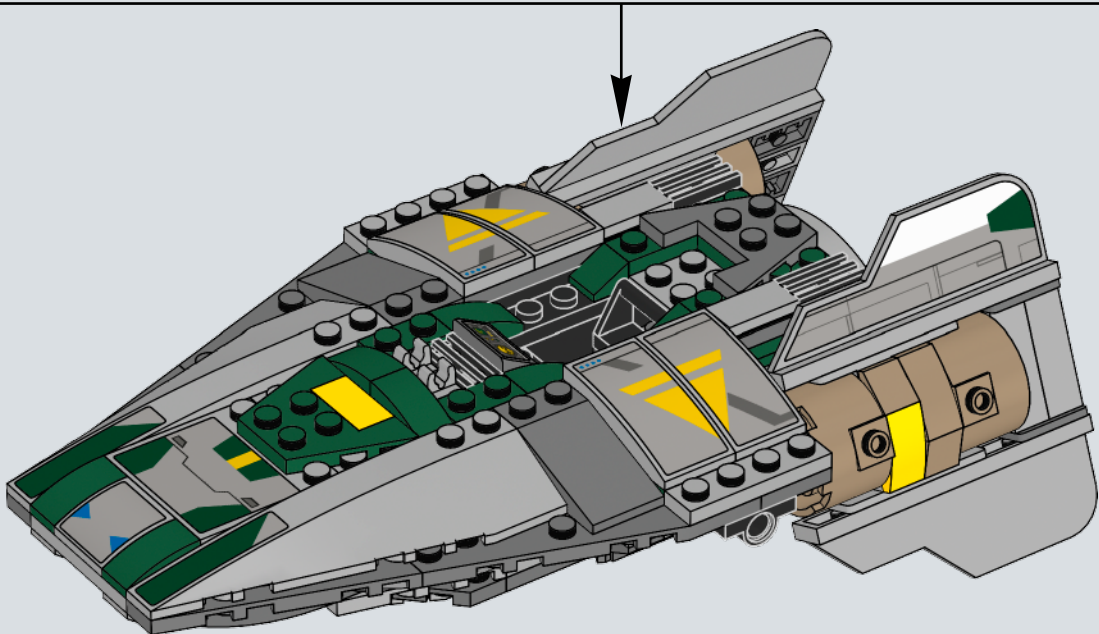

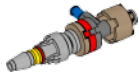

2x



1x

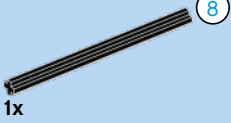

8

1x

80

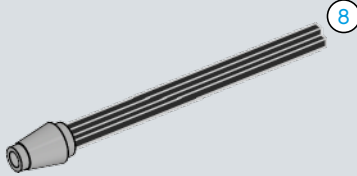

8



1x



1x

81

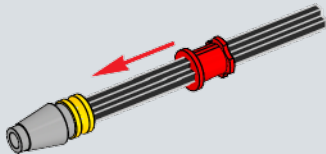

42

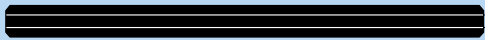

8

1:1



1x



1x

82

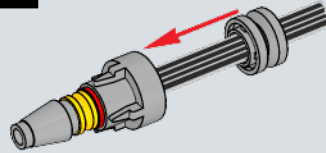

1x



1x



1x

83

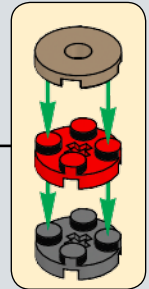
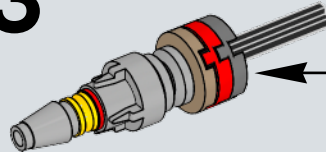

1x



1x

84

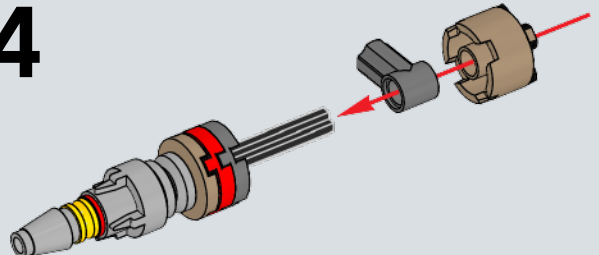



1x



1x

85

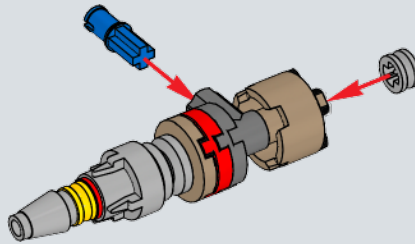

2x

86

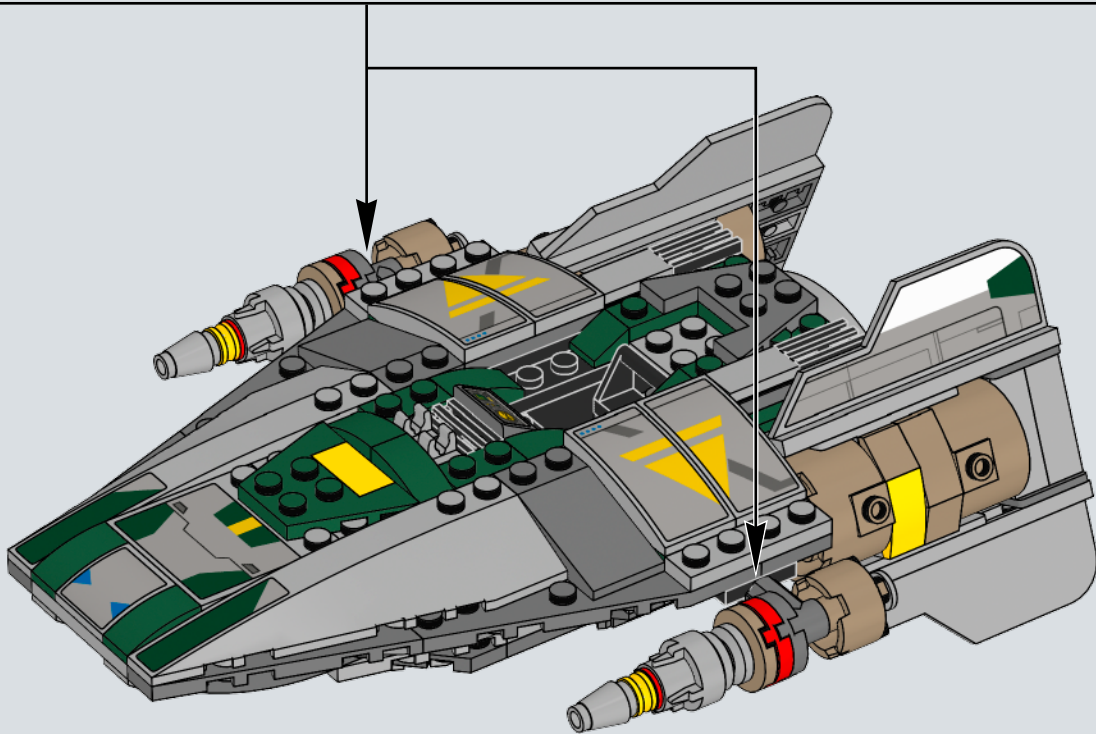

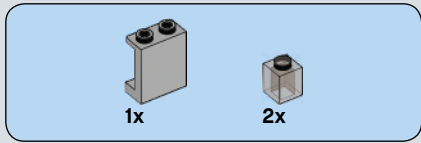

87

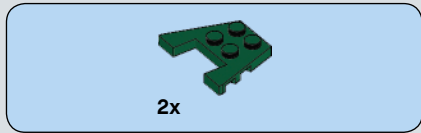
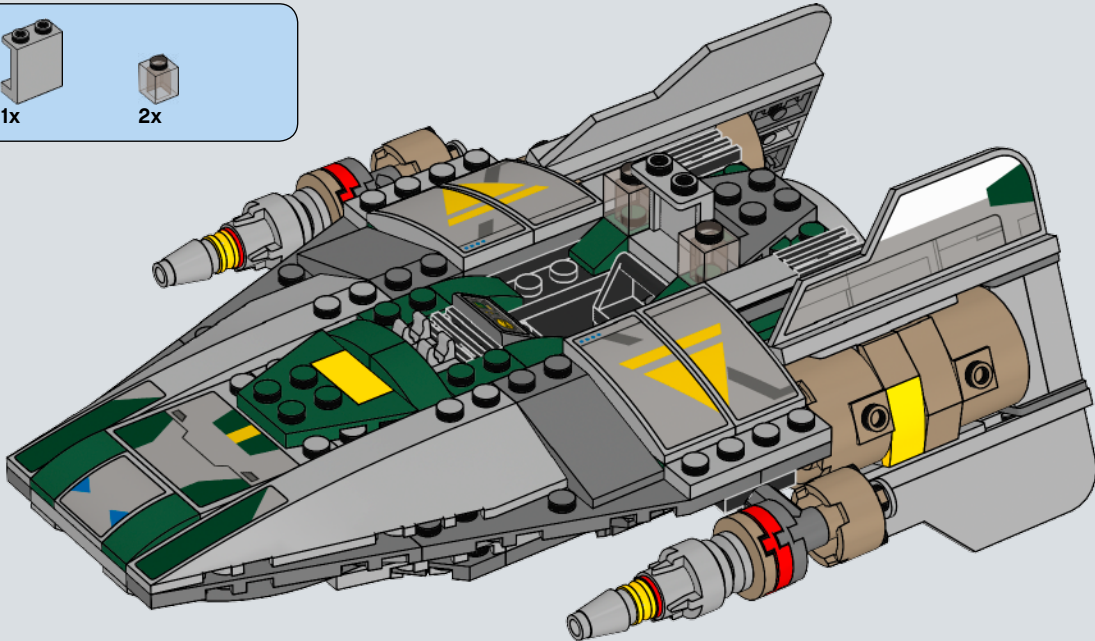

88

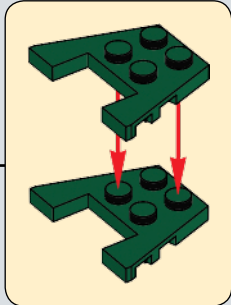
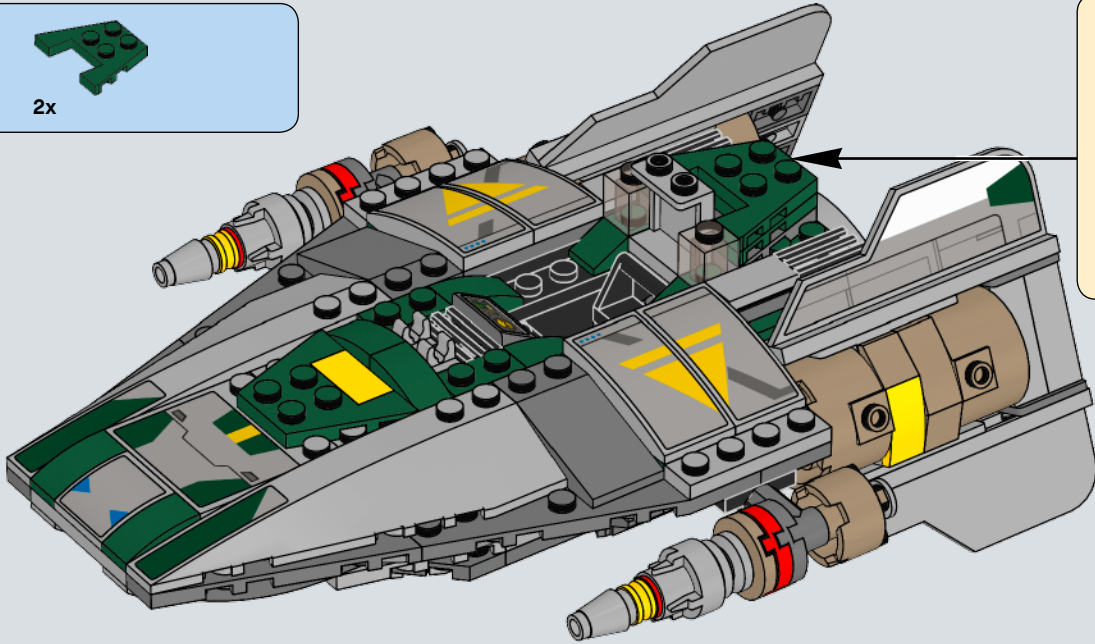

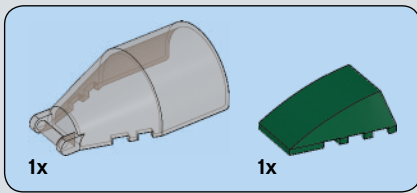

89

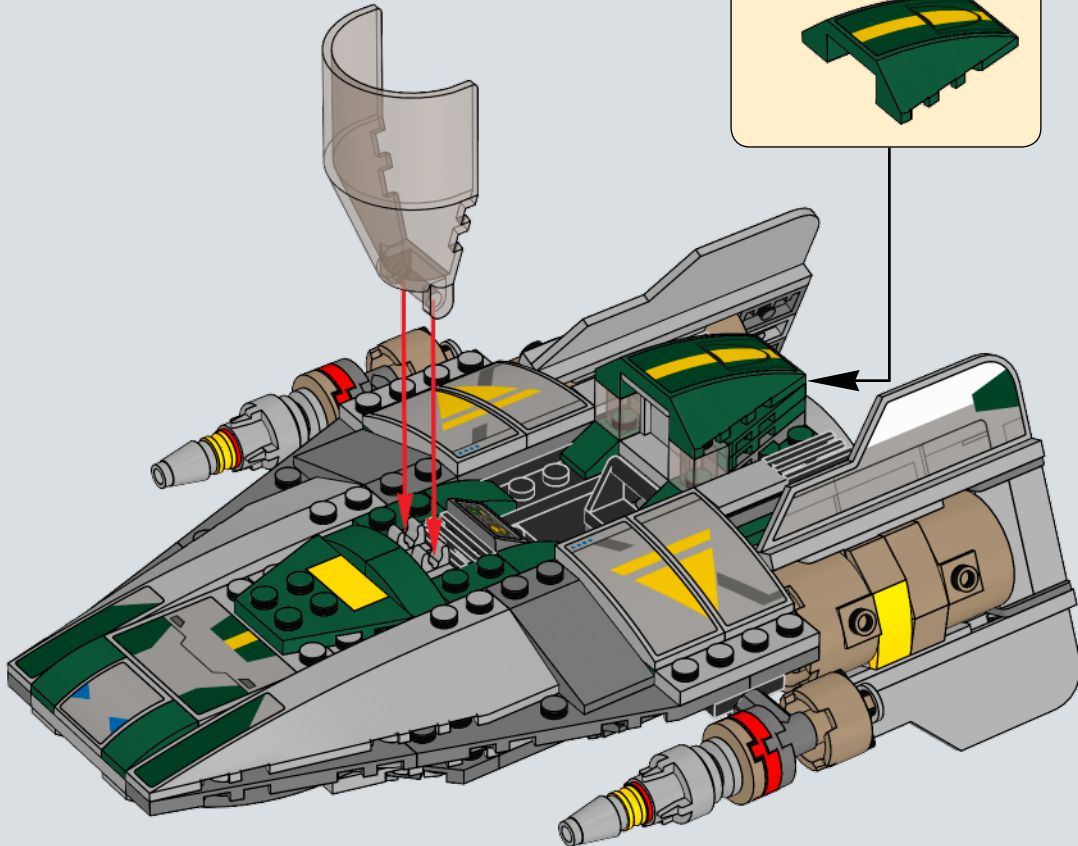
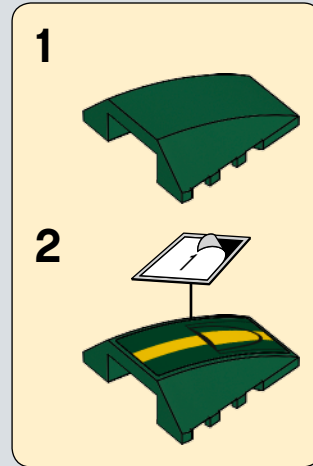

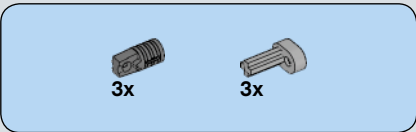

90

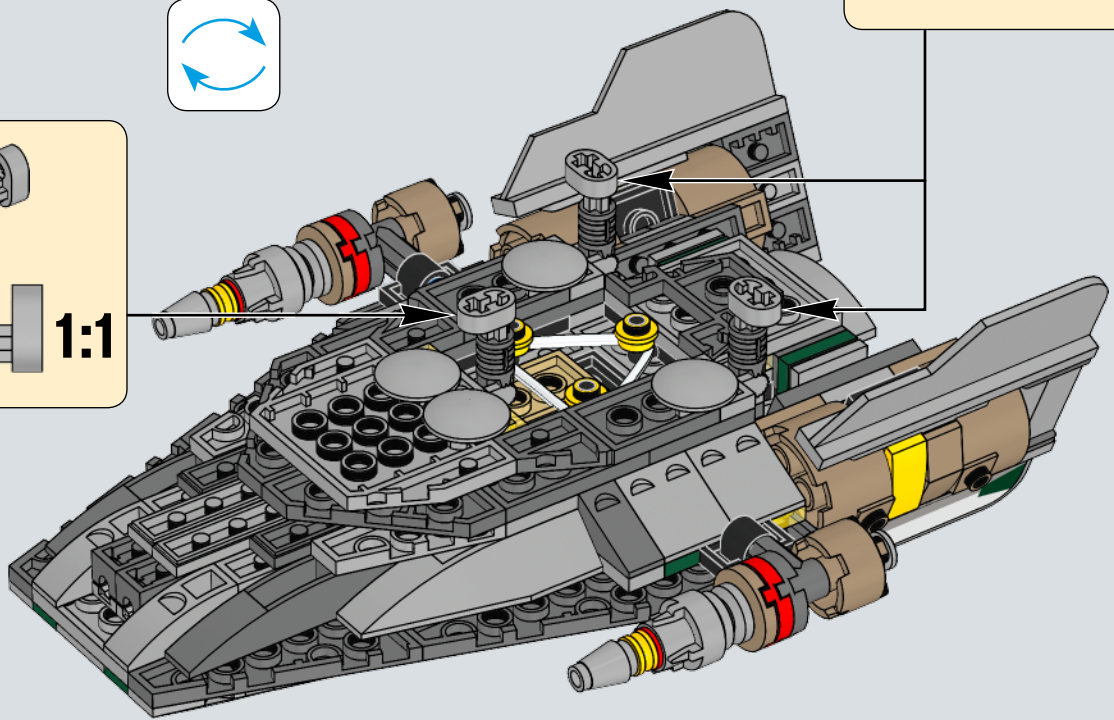
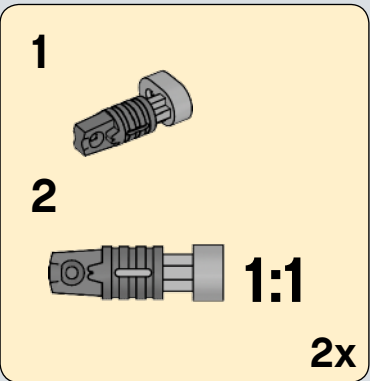
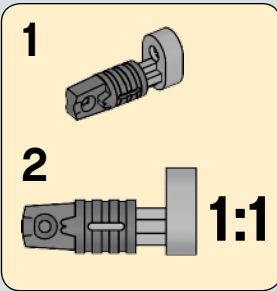
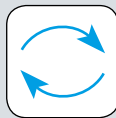

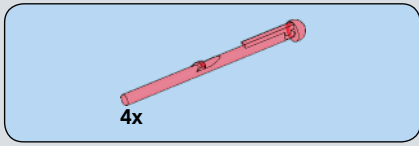

91

