

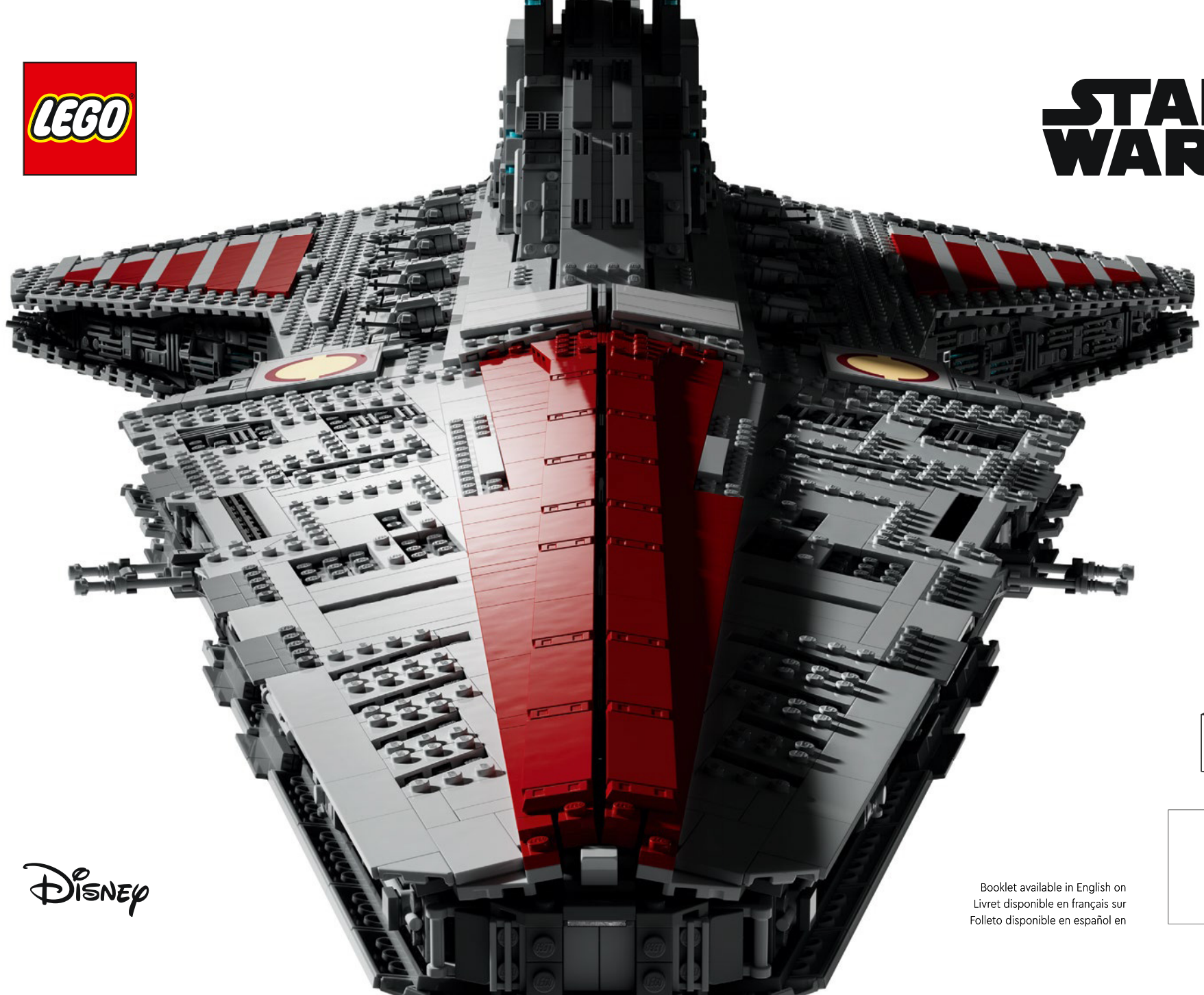

# STAR WARS™



Disney



Booklet available in English on  
Livret disponible en français sur  
Folleto disponible en español en

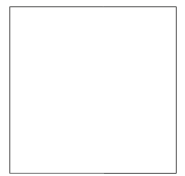



## WE'RE MAKING OUR PACKAGING MORE SUSTAINABLE

We're transitioning from single-use plastic to paper-based packaging. As we progress, you may find a mix of paper and plastic in our boxes.

## NOUS RENDONS NOS EMBALLAGES PLUS DURABLES

Nous passons des emballages en plastique à usage unique aux emballages à base de papier. Durant la transition, vous pourriez trouver un mélange de papier et de plastique dans nos boîtes.

## QUEREMOS HACER MÁS SUSTENTABLES NUESTROS MATERIALES DE EMBALAJE

Estamos cambiando las bolsas de plástico desechables por bolsas con base de papel. Conforme avanzamos en este propósito, puedes encontrar una mezcla de papel y de plástico en nuestras cajas.

[LEGO.com/sustainable-packaging](https://LEGO.com/sustainable-packaging)

# LEGO® VIP

- 1.** SIGN UP  
INSCRIVEZ-VOUS  
REGÍSTRATE

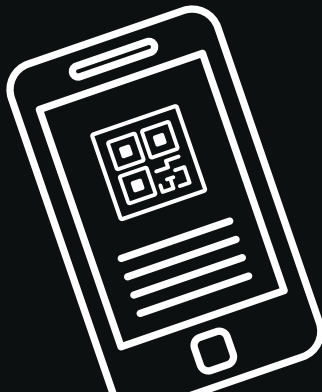

- 2.** EARN POINTS  
FOR PURCHASES  
GAGNEZ DES POINTS  
POUR VOS ACHATS  
GANA PUNTOS POR  
TUS COMPRAS

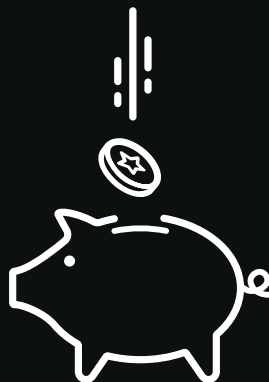

- 3.** REDEEM POINTS FOR REWARDS, EXPERIENCES,  
DISCOUNTS & MORE  
ÉCHANGEZ DES POINTS CONTRE DES RÉCOMPENSES,  
DES EXPÉRIENCES, DES RÉDUCTIONS ET PLUS ENCORE  
CANJEA PUNTOS POR RECOMPENSAS, EXPERIENCIAS,  
DESCUENTOS Y MUCHO MÁS

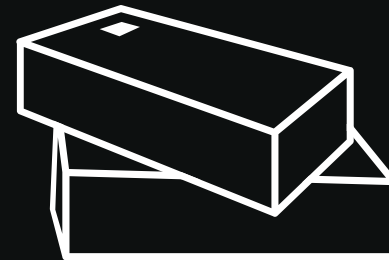

# THE CLONE WARS TURNS 20

"When the *Clone Wars 2D micro-series* premiered in 2003, its action-packed story arc, engaging characters and vibrant animation received wide acclaim from critics and *Star Wars*™ fans alike. The series paved the way for a whole new era in *Clone Wars* storytelling, including seven full seasons of the animated series *Star Wars: The Clone Wars* (2008-2020). The Venator-class Republic Attack Cruiser features in some of the most monumental scenes of the Clone Wars era, culminating in the Siege of Mandalore and the fateful Battle of Coruscant. We know that an Ultimate Collector Series version has been on LEGO® *Star Wars* fans' wish lists for a long time, so without further ado, please join us on this model's maiden voyage to commemorate twenty years of epic Clone Wars action."

Enjoy building!



**Jens Kronvold Frederiksen**  
Design Director & Creative Lead,  
LEGO® *Star Wars*™



## LA GUERRE DES CLONES FÊTE SES 20 ANS

« Lorsque la microsérie en 2D *Clone Wars* a été lancée en 2003, son arc narratif rempli d'action, ses personnages attachants et son animation éclatante ont été fortement acclamés tant par la critique que par les amateurs de *Star Wars*™. La série a ouvert la voie à une nouvelle ère dans l'histoire de la *Guerre des clones*, avec notamment les sept saisons complètes de la série animée *Star Wars : La Guerre des clones* (2008-2020). Le croiseur d'assaut de la République de classe *Venator* apparaît dans certaines des scènes les plus monumentales de la *Guerre des clones*, avec en point d'orgue le siège de Mandalore et la fatidique bataille de Coruscant. Nous savons que la version Série de collection suprême figure depuis longtemps sur la liste de souhaits des amateurs de LEGO® *Star Wars*. Rejoignez-nous pour le voyage inaugural de ce modèle et célébrez les 20 ans d'action épique de la *Guerre des clones*. »

Bonne construction !



**Jens Kronvold Frederiksen**

Directeur de la conception et responsable de la création, LEGO® *Star Wars*™

## LA GUERRA DE LOS CLONES CUMPLE 20 AÑOS

"Cuando se estrenó *La Guerra de los Clones 2D - Microseries* en 2003, su trama repleta de acción, sus cautivadores personajes y su vibrante animación fueron ampliamente aclamados tanto por la crítica como por los fans de *Star Wars*™. La serie allanó el camino para una era totalmente nueva en el estilo narrativo de *La Guerra de los Clones*, incluidas las siete temporadas completas de la serie de animación *Star Wars: La Guerra de los Clones* (2008-2020). El crucero de ataque clase *Venator* de la República aparece en algunas de las escenas más monumentales de la era de la *Guerra de los Clones*, que culmina en el Sitio de Mandalore y la fatídica Batalla de Coruscant. Sabemos que los fans de LEGO® *Star Wars* llevan mucho tiempo esperando la versión *Ultimate Collector Series*, así que, sin más preámbulo, acompáñanos a dar el viaje inaugural de este modelo para celebrar veinte años de la épica acción de *La Guerra de los Clones*".

¡Que disfrutes construyendo!



**Jens Kronvold Frederiksen**

Coordinador de diseño y director creativo de LEGO® *Star Wars*™

# THE JEDI™ CRUISER

The Venator was the first class of Star Destroyers designed and manufactured by Kuat Drive Yards. Built to transport over 400 starfighters across the galaxy, it was a crucial asset to the Galactic Republic fleet. In the hands of the Jedi Masters, this engineering masterpiece served as a forceful fighting ship and starfighter carrier in naval operations during the Clone Wars. After the fall of the Republic, Venators were incorporated into the Imperial fleet. A menacing testament to the power of the Empire, their design ultimately inspired another classic: the colossal Super Star Destroyers.

With a length of 1,137 meters (3,730.3 ft), a height of 268 meters (879.2 ft.) and a width of 548 meters (1,797.9 ft), the Venator-class Republic Attack Cruiser can accommodate a small city: 7,400 personnel, 2,000 troops, 7,000 tons of cargo and two years' worth of food supplies.

The bridge is designed for multiple specialized functions: the starboard-side bridge holds the command center, and the port-side bridge serves mainly as starfighter operations center.

## Speed

- 945 km/h (587 mph) in atmosphere
- 3,000 g acceleration
- 40,000 tons of fuel per second at maximum speed

## Armament

- 8 DBY-827 heavy turbolaser turrets
- 4 Proton torpedo launchers
- 6 Tractor beam projectors
- Beam weapons
- 52+ Point-defence laser cannons
- 2 sets of medium dual turbolasers



© & ™ Lucasfilm Ltd.



© & ™ Lucasfilm Ltd.

# LE CROISEUR JEDI™

Le Venator est la première classe de Destroyers stellaires conçue et fabriquée par les Chantiers navals de Kuat. Construit pour transporter plus de 400 chasseurs stellaires à travers la galaxie, le croiseur était un atout crucial pour la flotte de la République galactique. Entre les mains des maîtres Jedi, ce chef-d'œuvre d'ingénierie a servi de puissant vaisseau de combat et de transporteur de chasseurs stellaires lors des opérations navales de la Guerre des clones. Après la chute de la République, les Venators ont été intégrés à la flotte impériale. Témoignage menaçant de la puissance de l'Empire, le Venator a également inspiré un autre classique : le colossal Super Destroyer stellaire.

Avec une longueur de 1 137 mètres, une hauteur de 268 mètres et une largeur de 548 mètres, le croiseur d'assaut de la République de classe Venator peut accueillir une petite ville : 7 400 employés, 2 000 soldats, 7 000 tonnes de marchandises et deux ans de vivres.

Le pont est conçu pour remplir plusieurs fonctions spécialisées : le pont tribord abrite le centre de commandement, et le pont bâbord sert principalement de centre d'opérations pour les chasseurs stellaires.

## Vitesse

- 945 km/h dans l'atmosphère
- Accélération de 3 000 G
- 40 000 tonnes de carburant par seconde à vitesse maximale

## Armement

- 8 tourelles turbolaser lourdes DBY-827
- 4 lance-torpilles à proton
- 6 projecteurs de rayons tracteurs
- Des armes à faisceau
- Plus de 52 canons laser à défense ponctuelle
- 2 ensembles de doubles turbolasers lourds

# EL CRUCERO JEDI™

La classe Venator de destructores estelares fue la primera diseñada y fabricada por Kuat Drive Yards. Construido para transportar más de 400 cazas estelares por toda la galaxia, la nave fue un activo crucial de la flota de la República Galáctica. En manos de los Maestros Jedi, esta obra maestra de la ingeniería sirvió como contundente crucero de combate y transporte de cazas estelares en operaciones navales durante la Guerra de los Clones. Una vez consumada la caída de la República, los Venator se incorporaron a la flota imperial. Su diseño, amenazador testimonio del poder del Imperio, acabó por inspirar otro clásico: los imponentes súper destructores estelares.

Con una longitud de 1137 m, una altura de 268 m y una anchura de 548 m, el crucero de ataque clase Venator de la República puede albergar una pequeña ciudad: 7400 personas, 2000 soldados, 7000 toneladas de carga y provisiones alimentarias suficientes para dos años.

El puente está diseñado para desempeñar múltiples funciones especializadas: el lado de estribor alberga el centro de mando y el lado de babor sirve principalmente como centro de operaciones de los cazas estelares.

## Velocidad

- 945 km/h en atmósfera
- Aceleración de 3000 g
- 40.000 t de combustible por segundo a velocidad máxima

## Armamento

- 8 torretas turboláser pesadas DBY-827
- 4 lanzadores de torpedos de protones
- 6 proyectores de rayo tractor
- Armas de rayos
- Más de 52 cañones láser de defensa puntual
- 2 conjuntos de turboláseres duales medios

# RECREATING A CLONE WARS ICON

The LEGO® Venator-class Republic Attack Cruiser is a true heavyweight addition to the Ultimate Collector Series. The familiar Kuat Drive Yards wedge-shape, the signature Republic Red stripe and the double bridge make it instantly recognizable throughout the many battles of the Clone Wars as a commanding force across the galaxy – and on your shelf. The miniature scale model of a Republic Gunship in the port-side hangar emphasizes the sheer magnitude of the starship. Tinted panorama windows in the bridge exude determined action, the enormous ion thrusters create an illusion of motion and the turbolaser turrets are positioned for attack. The Captain Rex and Wulf Yularen minifigures come with a separate display stand. Both are exclusive to this set, with all-new helmet, torso and head designs to capture the unique traits of these charismatic and central characters in the saga.





## RECRÉER UN EMBLÈME DE LA GUERRE DES CLONES

Le croiseur d'assaut de la République de classe *Venator* LEGO® est un véritable poids lourd qui vient s'ajouter à la Série de collection suprême. La forme triangulaire typique des Chantiers navals de Kuat, la bande rouge caractéristique de la République et le double pont en font une arme immédiatement reconnaissable au cours des nombreuses batailles de la Guerre des clones et une force imposante dans toute la galaxie... et sur votre étagère. Le modèle miniature d'un vaisseau de guerre de la République, situé dans le hangar bâbord, souligne l'ampleur du vaisseau. Les verrières panoramiques teintées du pont évoquent une action déterminée, les énormes propulseurs ioniques créent une illusion de mouvement et les tourelles turbolaser sont positionnées pour l'assaut. Les figurines du Capitaine Rex et de Wullf Yularen sont accompagnées d'un socle d'exposition séparé. Elles sont toutes deux exclusives à cet ensemble, avec des casques, des torsos et des têtes entièrement nouveaux pour refléter les traits uniques de ces personnages charismatiques et centraux de la saga.

## RECREACIÓN DE UN ÍCONO DE LA GUERRA DE LOS CLONES

El Crucero de Ataque Clase *Venator* de la República LEGO® es una verdadera adición de peso pesado a la colección Ultimate Collector Series. La inconfundible forma de cuña de las creaciones de Kuat Drive Yards, la franja roja que caracteriza a los vehículos de la flota de la República y el puente doble lo hacen reconocible al instante en las numerosas batallas de la Guerra de los Clones como una fuerza dominante en toda la galaxia, ¡y en tu estante favorito! El modelo a escala en miniatura de una cañonera de la República en el hangar de babor hace resaltar la descomunal magnitud de la nave espacial. Las ventanas panorámicas tintadas del puente destilan acción decidida, los enormes propulsores de iones generan la ilusión de movimiento y las torretas turboláser están preparadas para atacar. Las minifiguras del Capitán Rex y Wullf Yularen vienen con una base de exhibición independiente. Ambas son exclusivas de este set y sus cascos, torsos y cabezas tienen un diseño totalmente nuevo que captura los singulares rasgos de estos carismáticos personajes tan fundamentales para la saga.

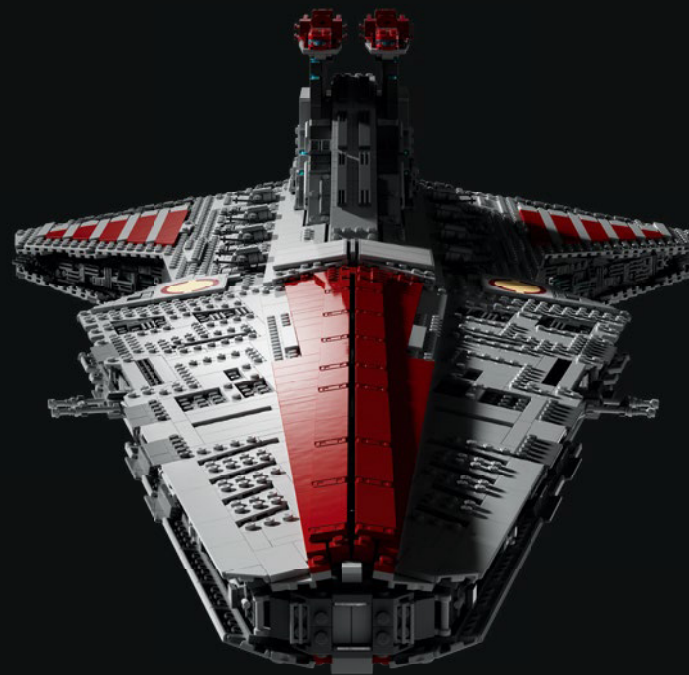



Hans Burkhard Schlömer,  
LEGO® Star Wars™ Model Designer

Jens Kronvold Frederiksen  
Design Director & Creative Lead,  
LEGO® Star Wars™



## DESIGNING FOR OUR GALAXY

"This is the first time we're releasing the *Venator*-class Republic Attack Cruiser at this scale – in fact, it's almost twice as big as the LEGO® *Star Wars*™ 8039 *Venator*-class Republic Attack Cruiser from 2009. With models this size, we can really dive into every detail, and this is no exception. With every LEGO brick and element, we wanted to create a faithful replica of the original, and an engaging build experience that would do *The Clone Wars* series justice. No prop versions of the *Venator* were made for the filming of *Revenge of the Sith* or *The Clone Wars* series, it was all CGI, and details like the red stripe evolved over the seven seasons, so this model incorporates details from different versions. For the main engines, we used the large wheel elements to save weight, provide details and optimize building time, and the titanium metallic color completed the look. The hull panels and skeleton are unlike anything we have created before, with different orientations and connection points with the internal frame. The center frame had to be strong enough to absorb the pull from the tail weight – an unsupported overhang clocking in at over one kilo (2 lbs)!"

Hans Burkhard Schlömer,  
LEGO® *Star Wars*™ Model Designer

## CONCEVOIR POUR NOTRE GALAXIE

« C'est la première fois que nous lançons le croiseur d'assaut de la République de classe *Venator* à cette échelle. En fait, il est presque deux fois plus grand que le croiseur d'assaut de la République de classe *Venator* LEGO® *Star Wars*™ 8039 sorti en 2009. Avec des modèles de cette taille, nous pouvons vraiment approfondir chaque détail, et celui-ci ne fait pas exception à la règle. Avec chaque brique et élément LEGO, nous voulions créer une réplique fidèle du vaisseau original et une expérience de construction captivante qui ferait honneur à la série *La Guerre des clones*. Aucun accessoire de *Venator* n'a été fabriqué pour le tournage de *La Revanche des Sith* ou de *La Guerre des clones*. Tout a été réalisé en images de synthèse, et des détails comme la bande rouge ont évolué au fil des sept saisons. Ce modèle intègre donc des détails provenant de différentes versions. Pour les réacteurs principaux, nous avons utilisé les grands éléments de roue afin d'économiser du poids, de donner des détails et d'optimiser le temps de construction, et la couleur titane métallisée a complété son apparence. Les panneaux et le squelette de la coque ne ressemblent à rien que nous ayons créé auparavant, avec des orientations et des points de connexion différents avec le cadre interne. Le cadre central devait être suffisamment solide pour absorber la traction exercée par le poids de la queue – un porte-à-faux non soutenu de plus d'un kilo ! »

Hans Burkhard Schlömer,  
concepteur de modèles LEGO® *Star Wars*™

## DISEÑO CONCEBIDO PARA NUESTRA GALAXIA

"Es la primera vez que lanzamos el Crucero de Ataque Clase *Venator* de la República a esta escala. De hecho, es casi el doble de grande que el set LEGO® *Star Wars*™ *Venator*-class Republic Attack Cruiser (8039) de 2009. Los modelos de esta magnitud nos permiten profundizar en cada uno de los detalles, y este no fue una excepción. Cada brick y elemento LEGO está allí para crear una réplica fiel del original y una experiencia de construcción amena que hiciera justicia a la serie *La Guerra de los Clones*. No hubo versiones de utilería del *Venator* para la filmación de *La Venganza de los Sith* ni para la serie *La Guerra de los Clones*: todo fue CGI. Y detalles como la franja roja evolucionaron a lo largo de las siete temporadas, así que este modelo incorpora detalles de distintas versiones. Para los motores principales, utilizamos los elementos de ruedas grandes con el fin de ahorrar peso, incorporar detalles y optimizar el tiempo de construcción, y el color titanio metálico fue lo que completó el aspecto del modelo. Debido a las múltiples orientaciones y puntos de conexión con el armazón interno, los paneles del casco y el esqueleto no se parecen a nada que hayamos creado antes. La estructura central tenía que ser lo suficientemente fuerte como para absorber la tracción del peso de la cola: ¡una proyección sin soportes de más de un kilogramo!"

Hans Burkhard Schlömer,  
modelista de LEGO® *Star Wars*™



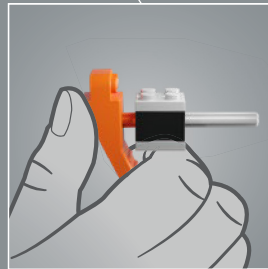
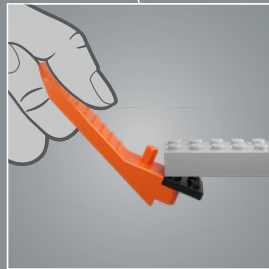
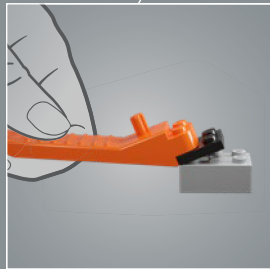
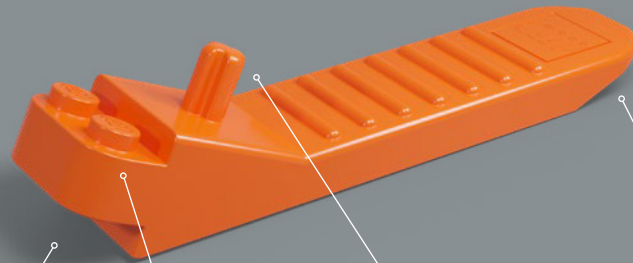

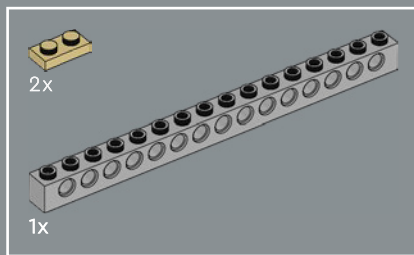

1

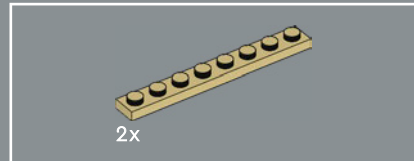
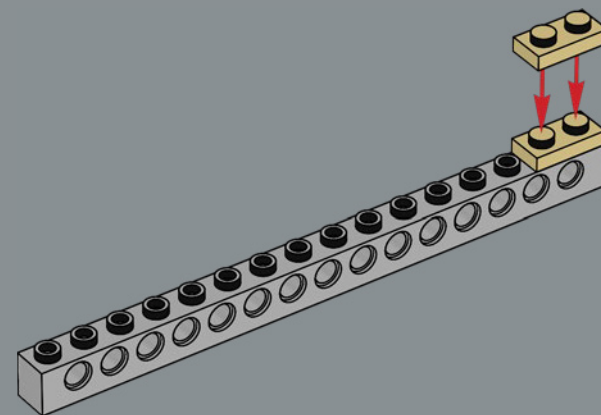

2

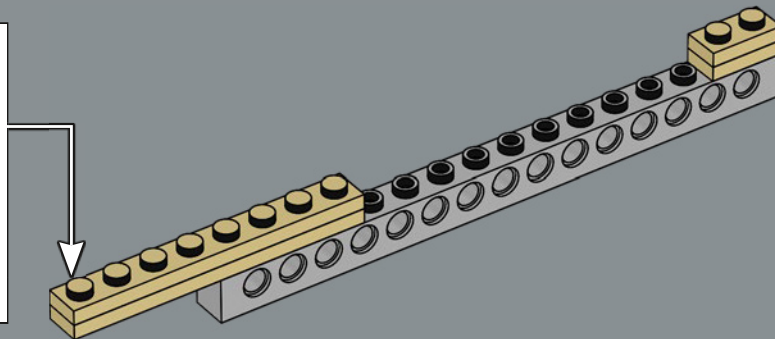
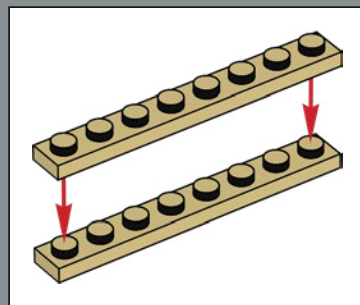

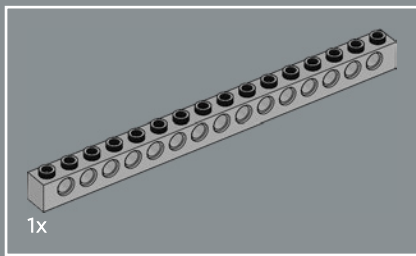

3

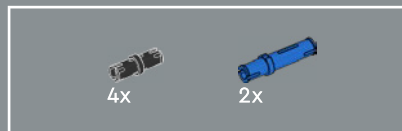
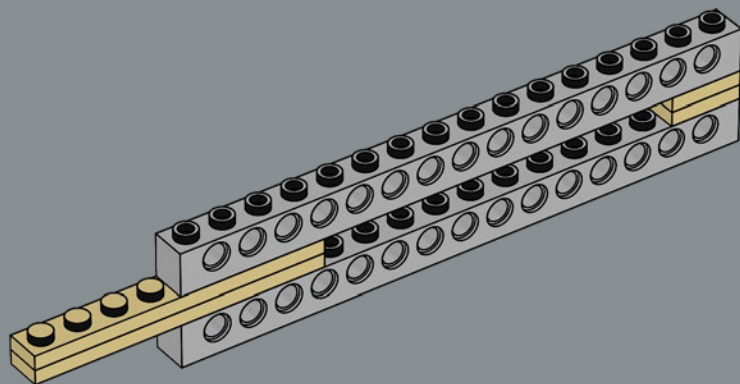

4

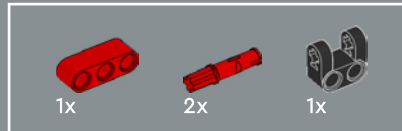
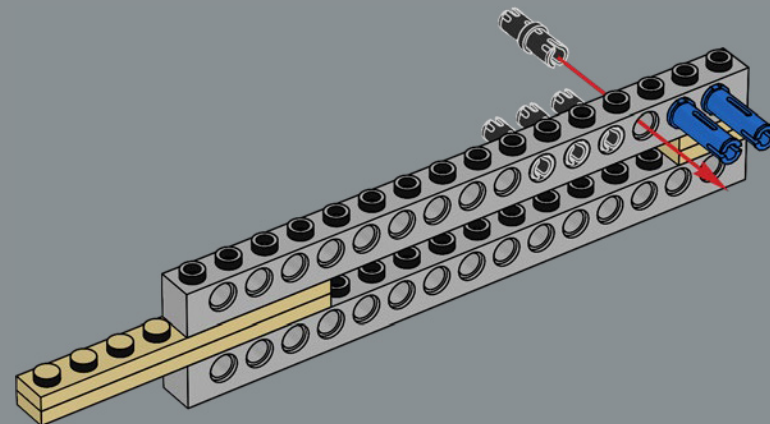

5

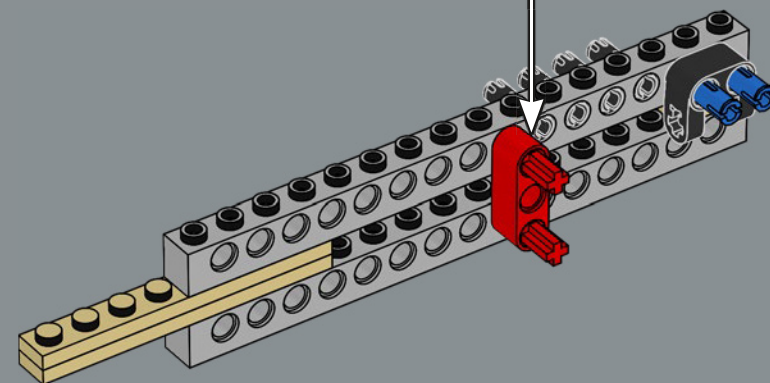
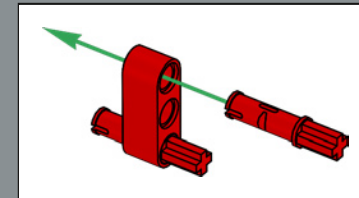

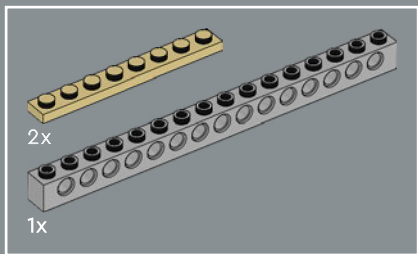

6

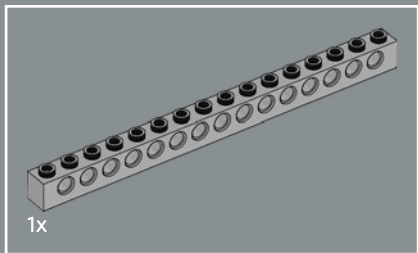
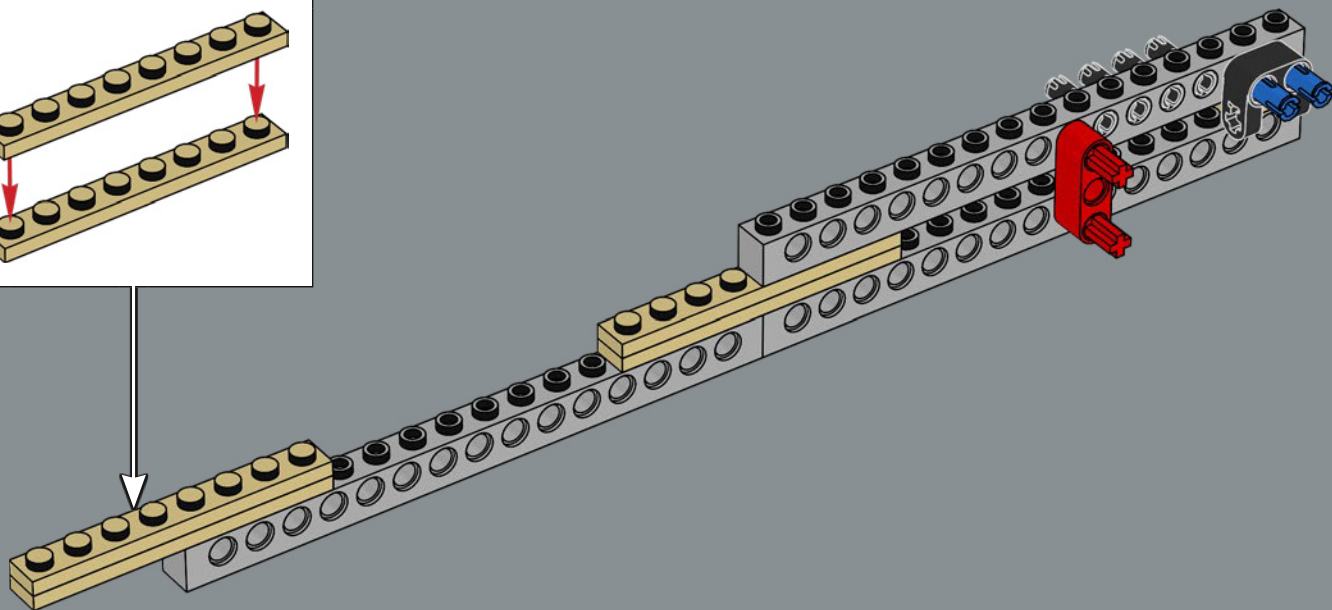
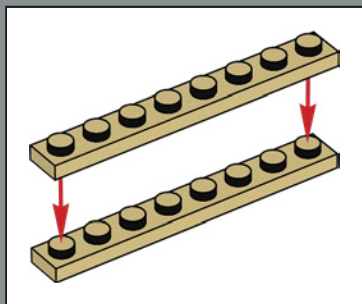

7

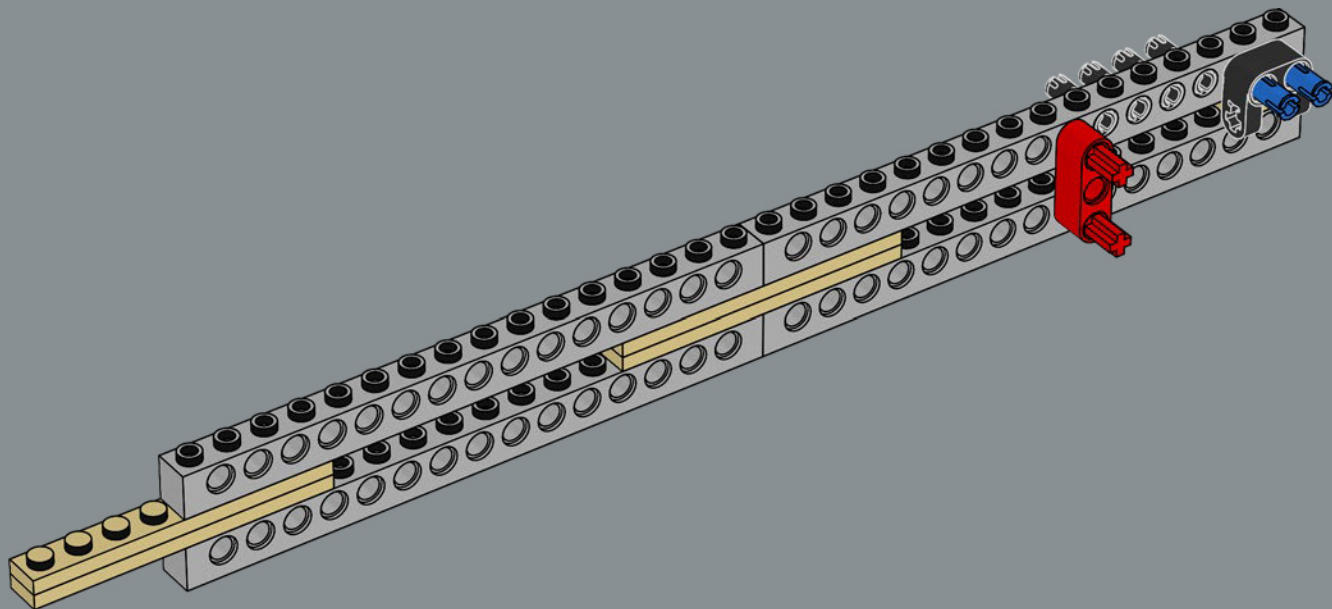



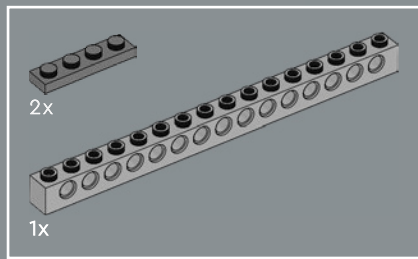

8

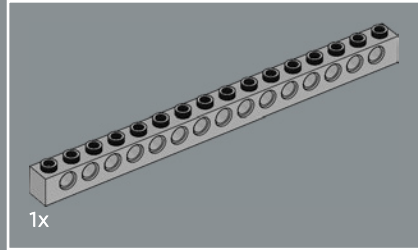
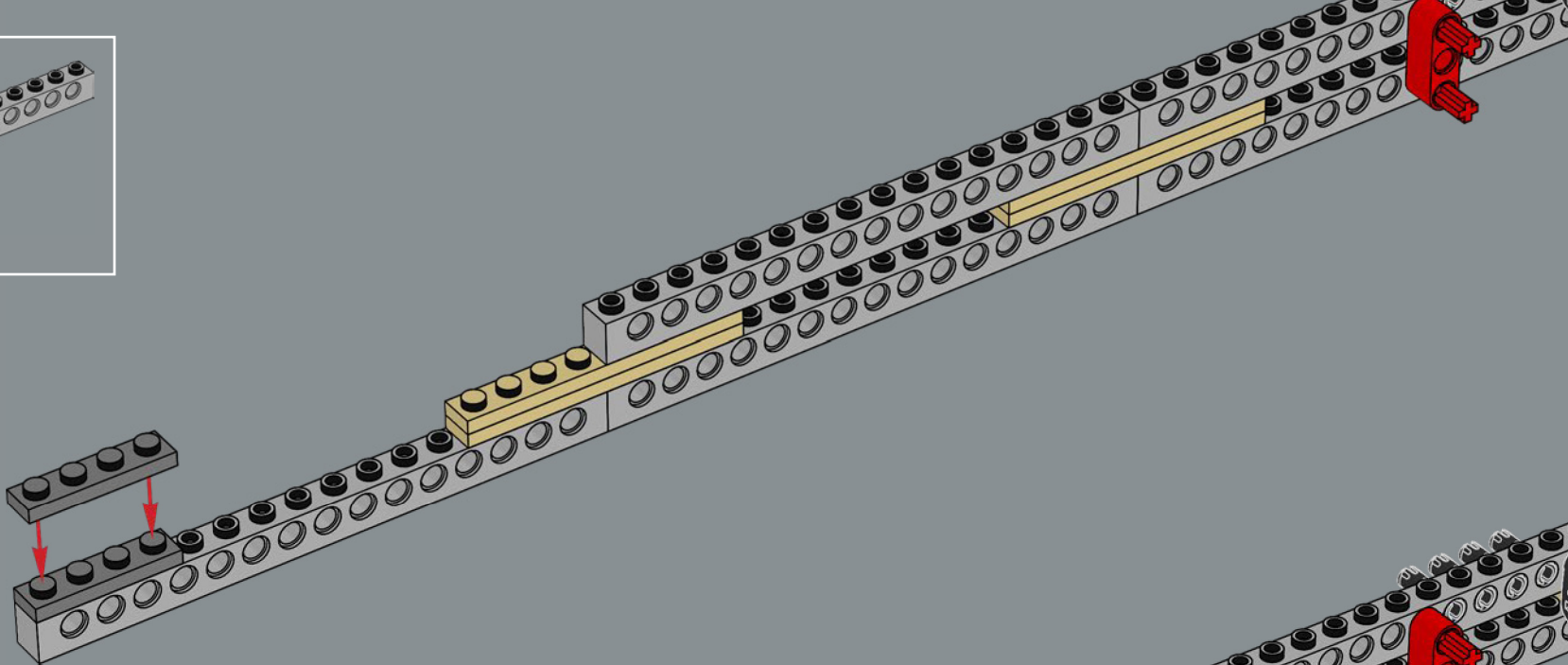

9

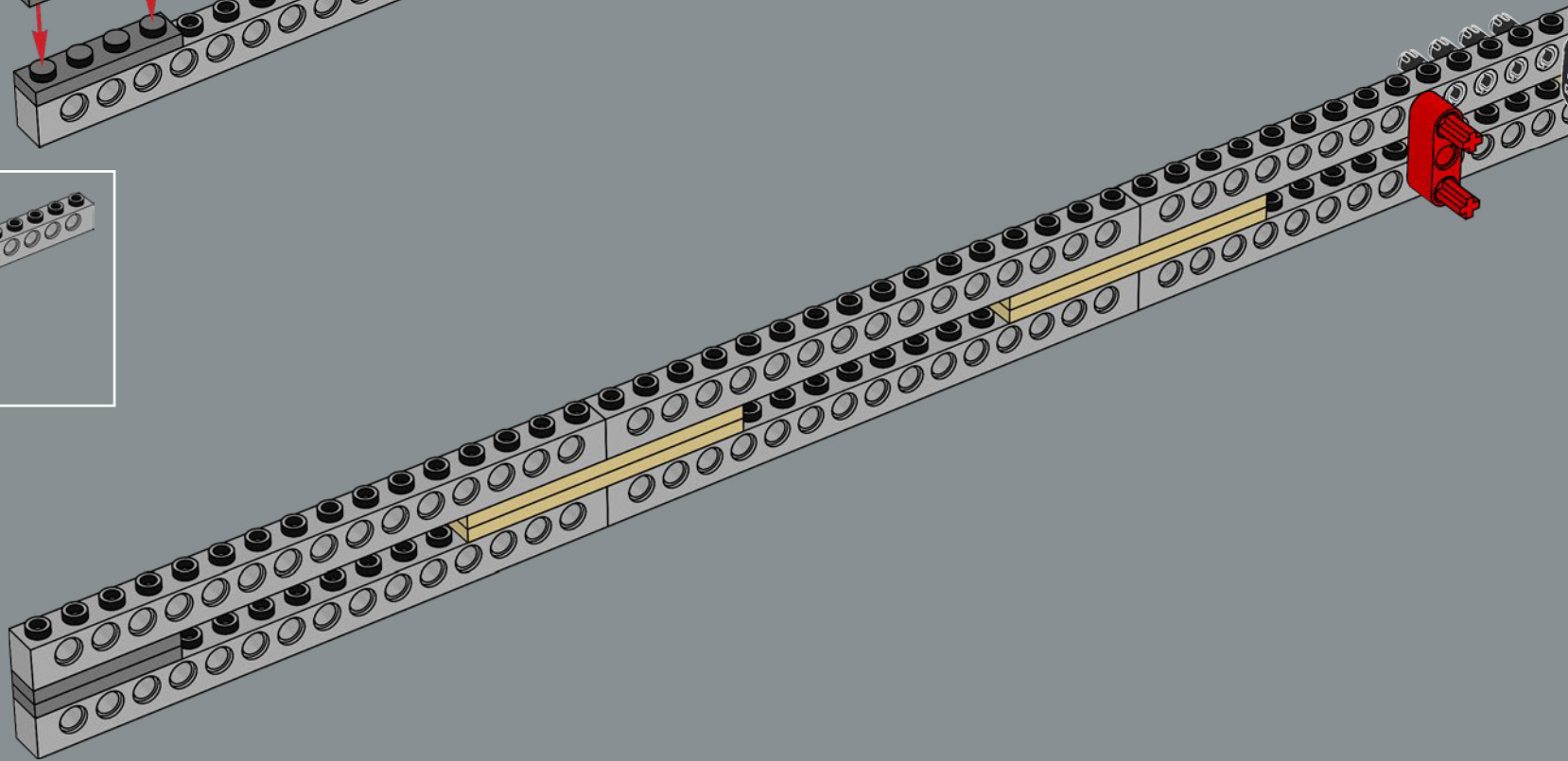

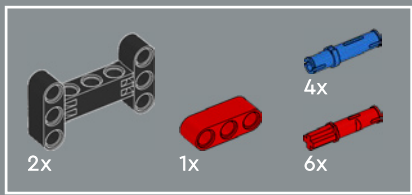

10

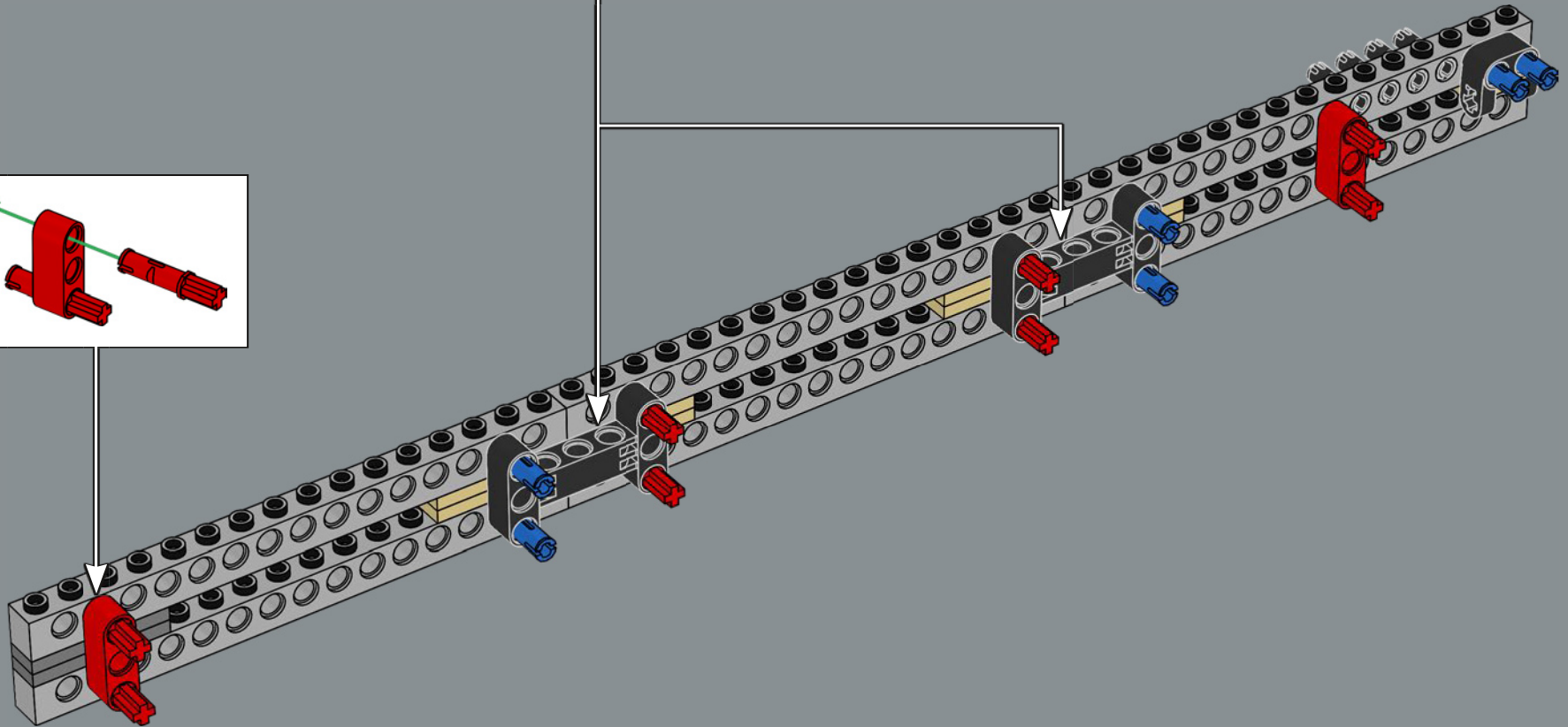
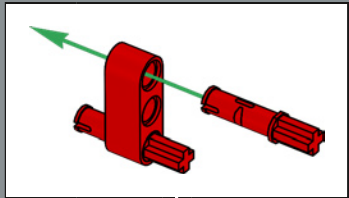
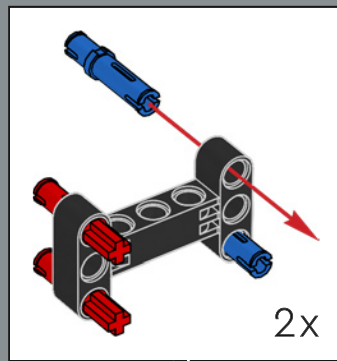

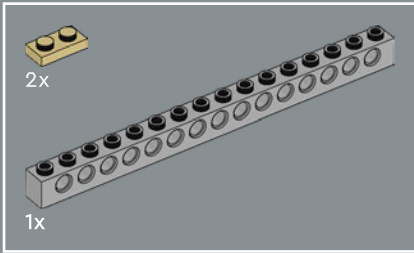
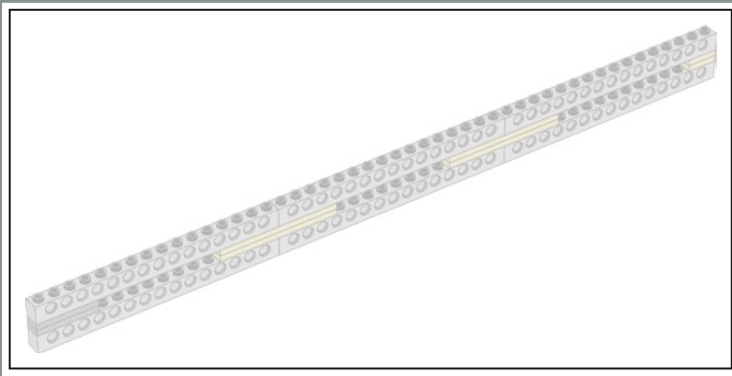

11

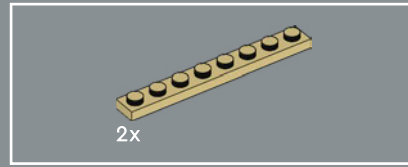
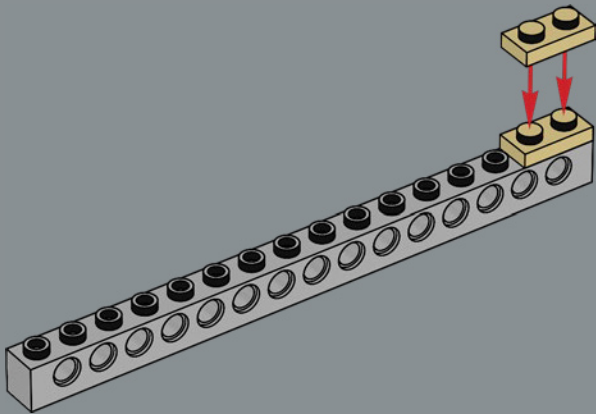

12

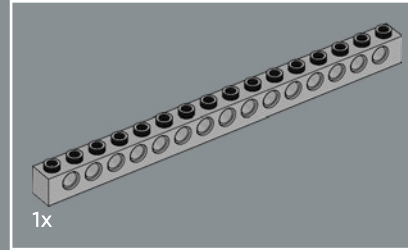
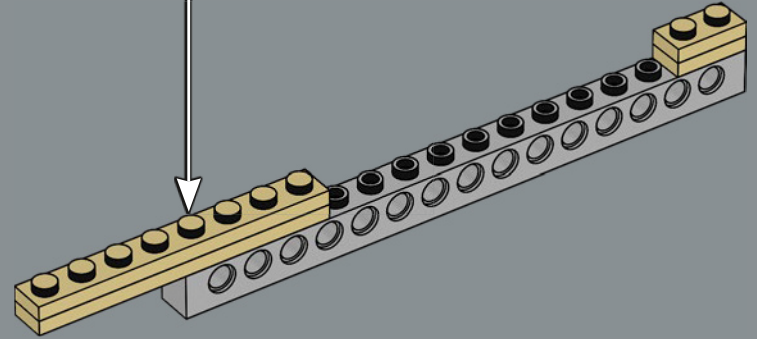
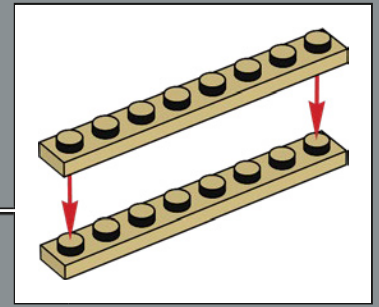

13

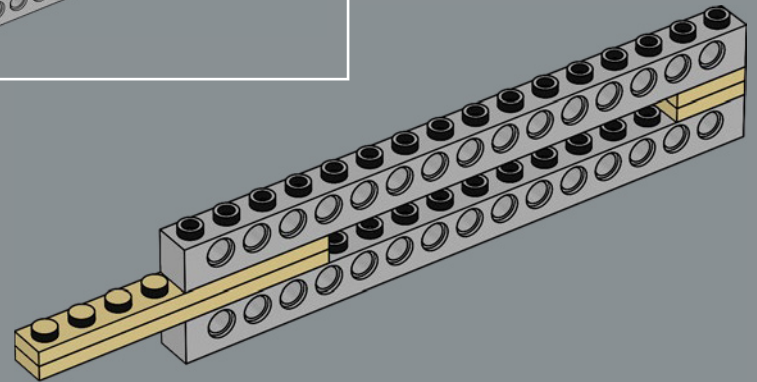

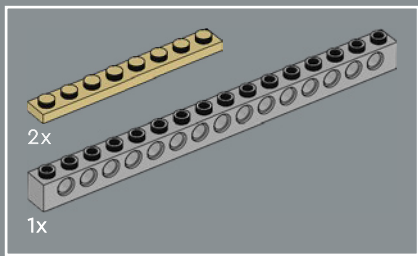

14

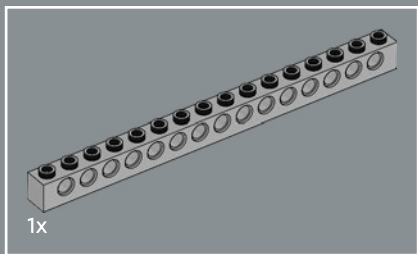
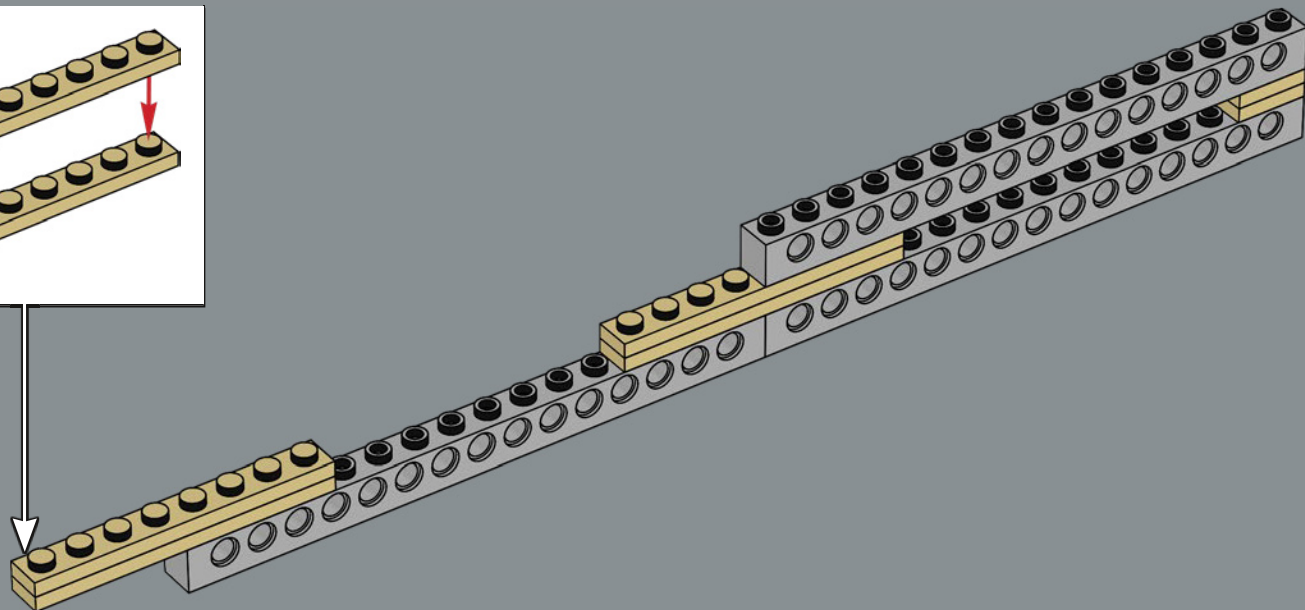
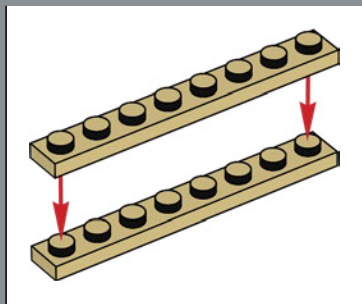

15

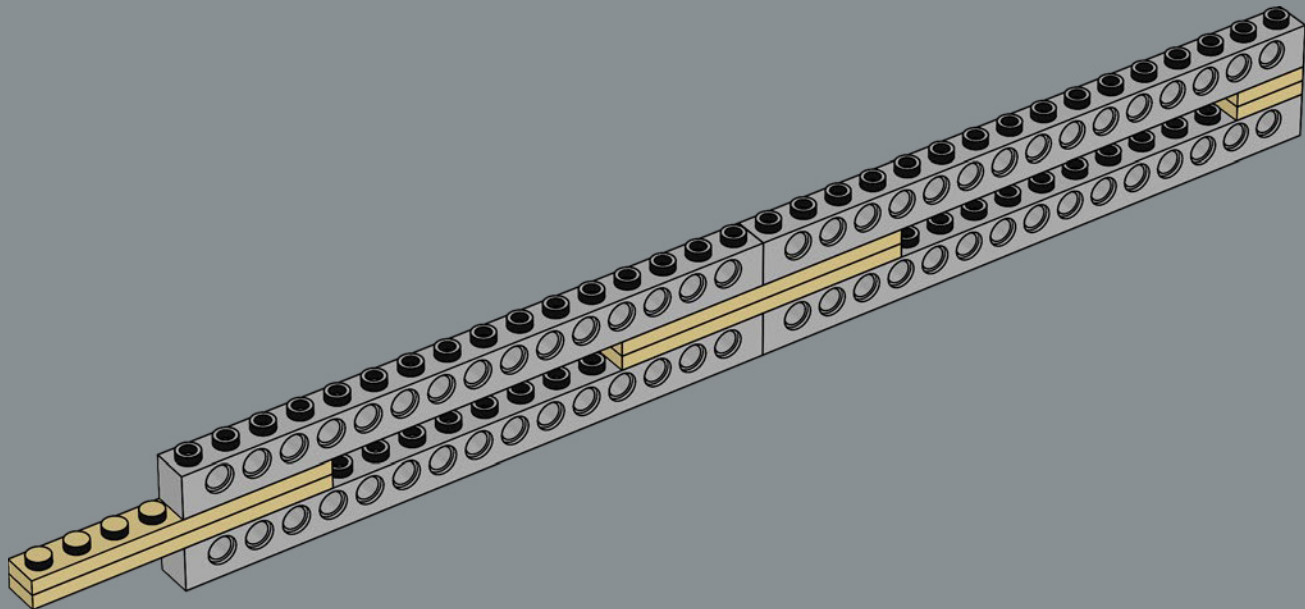

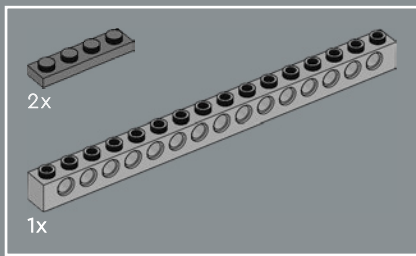

16

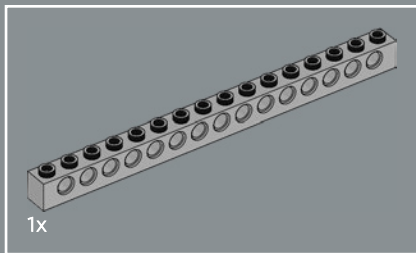
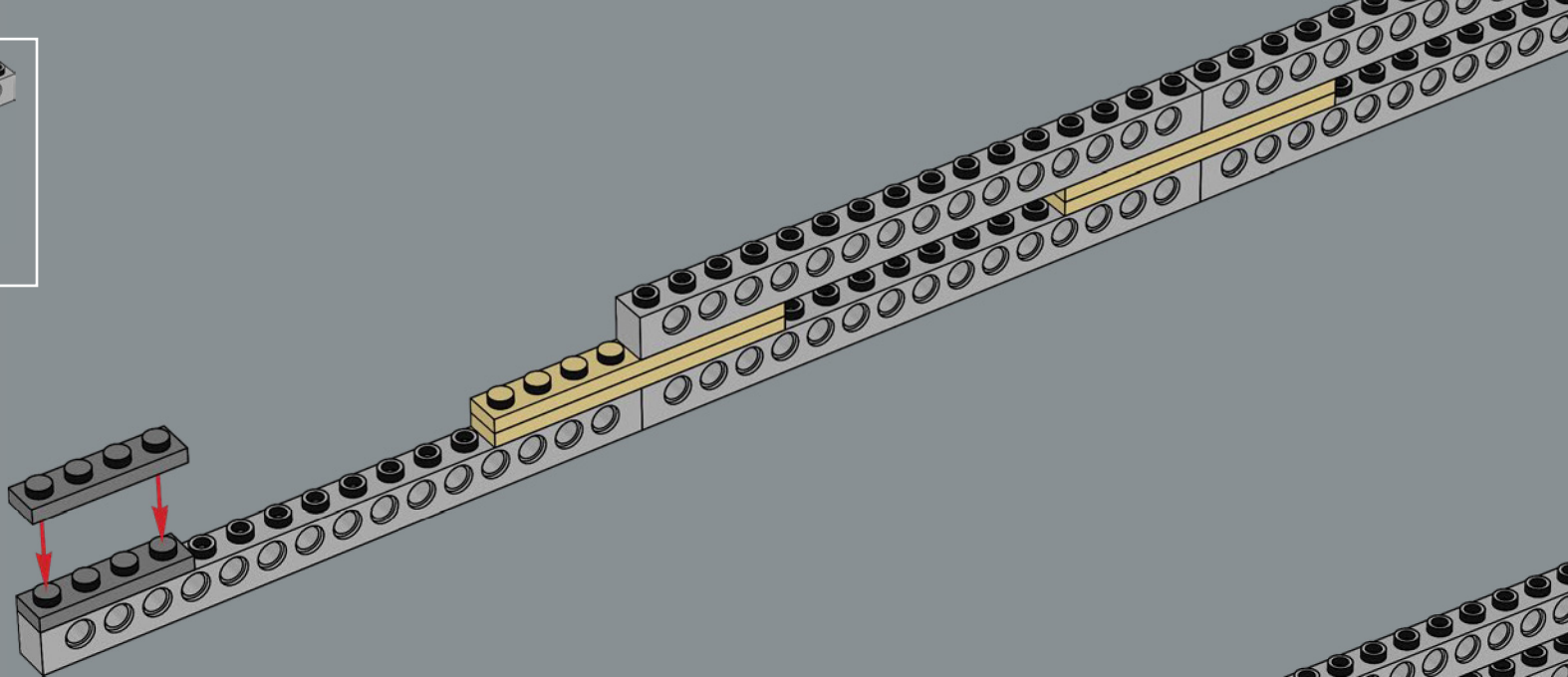

17

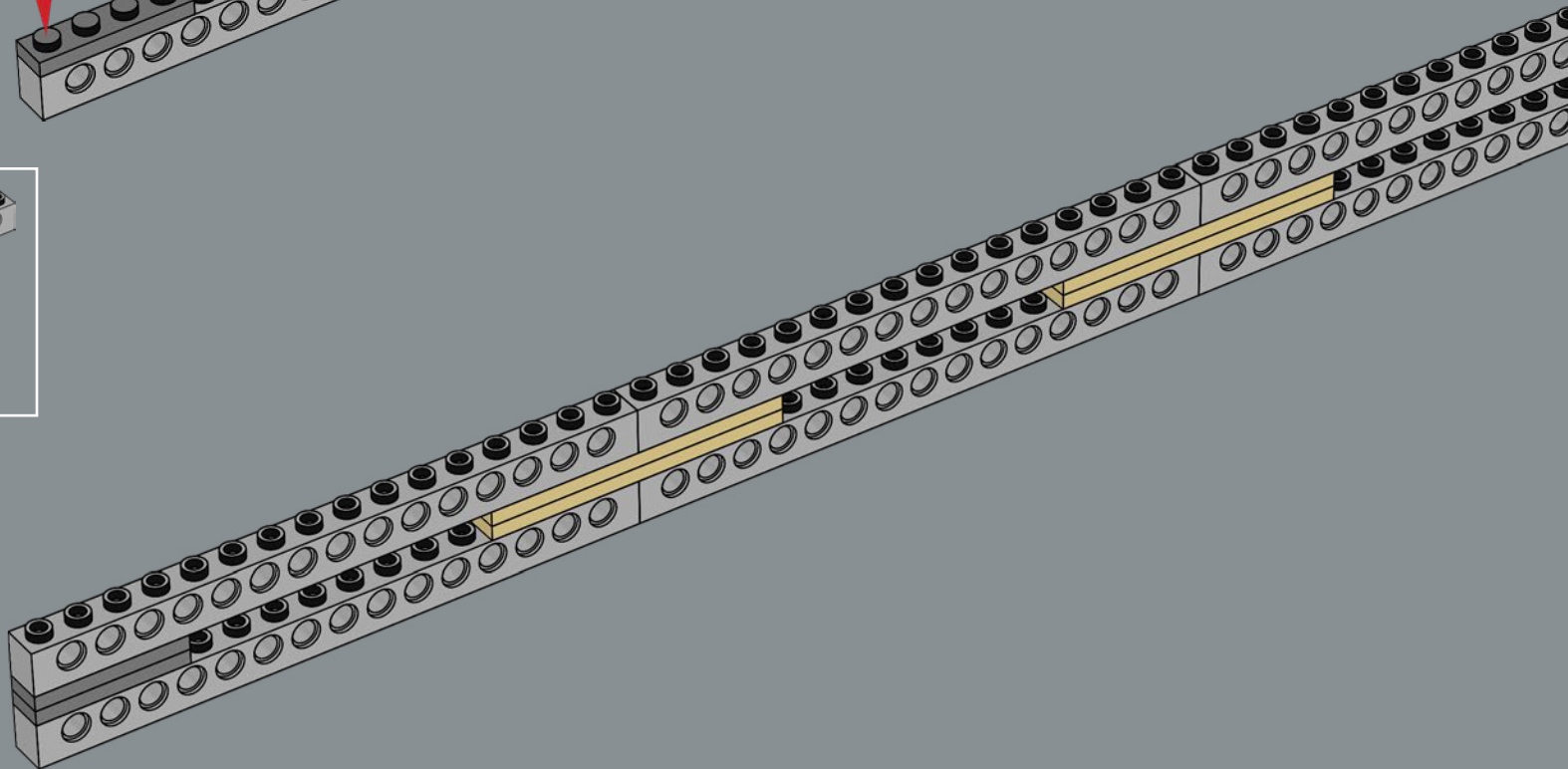

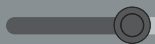
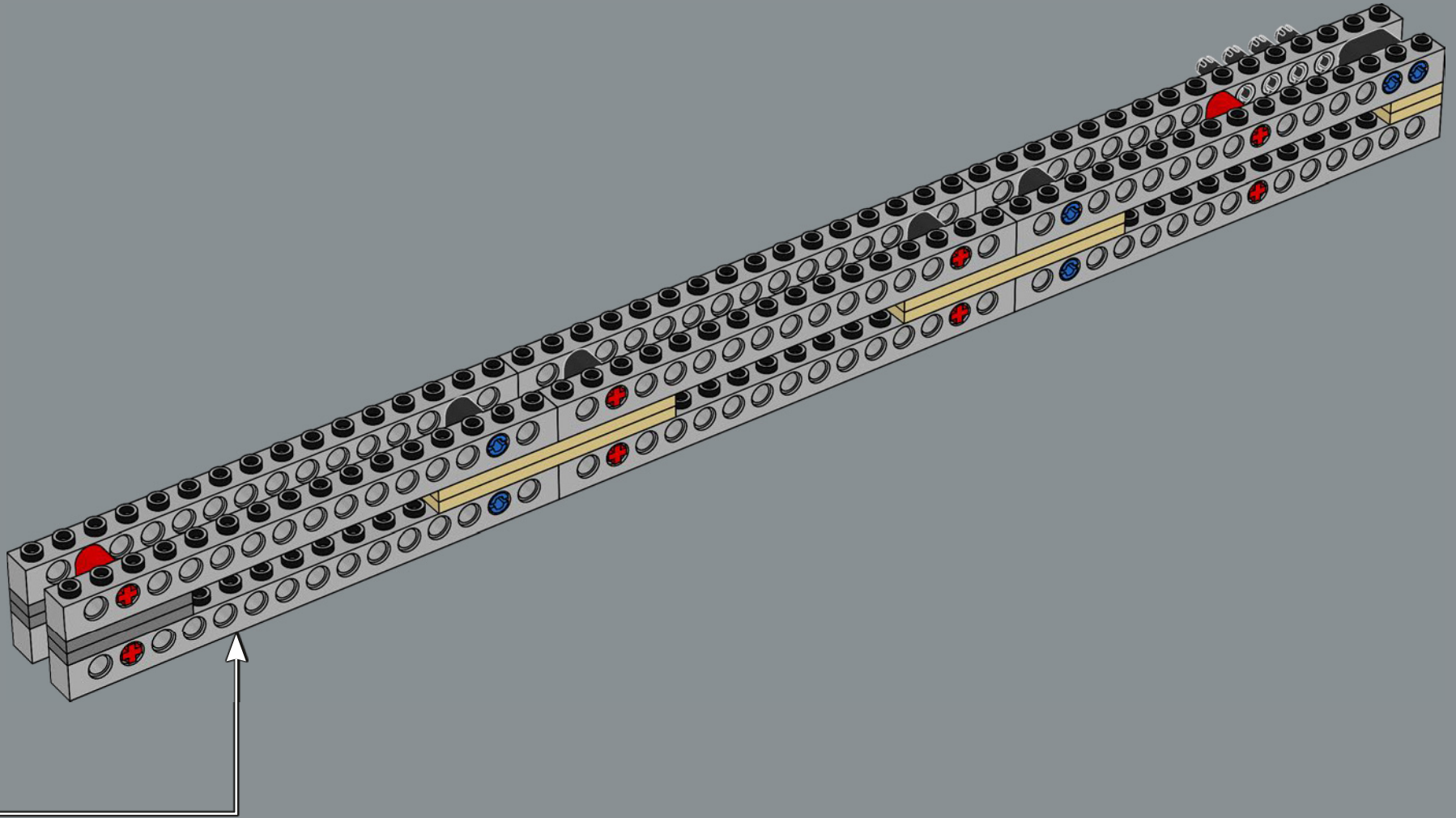



19

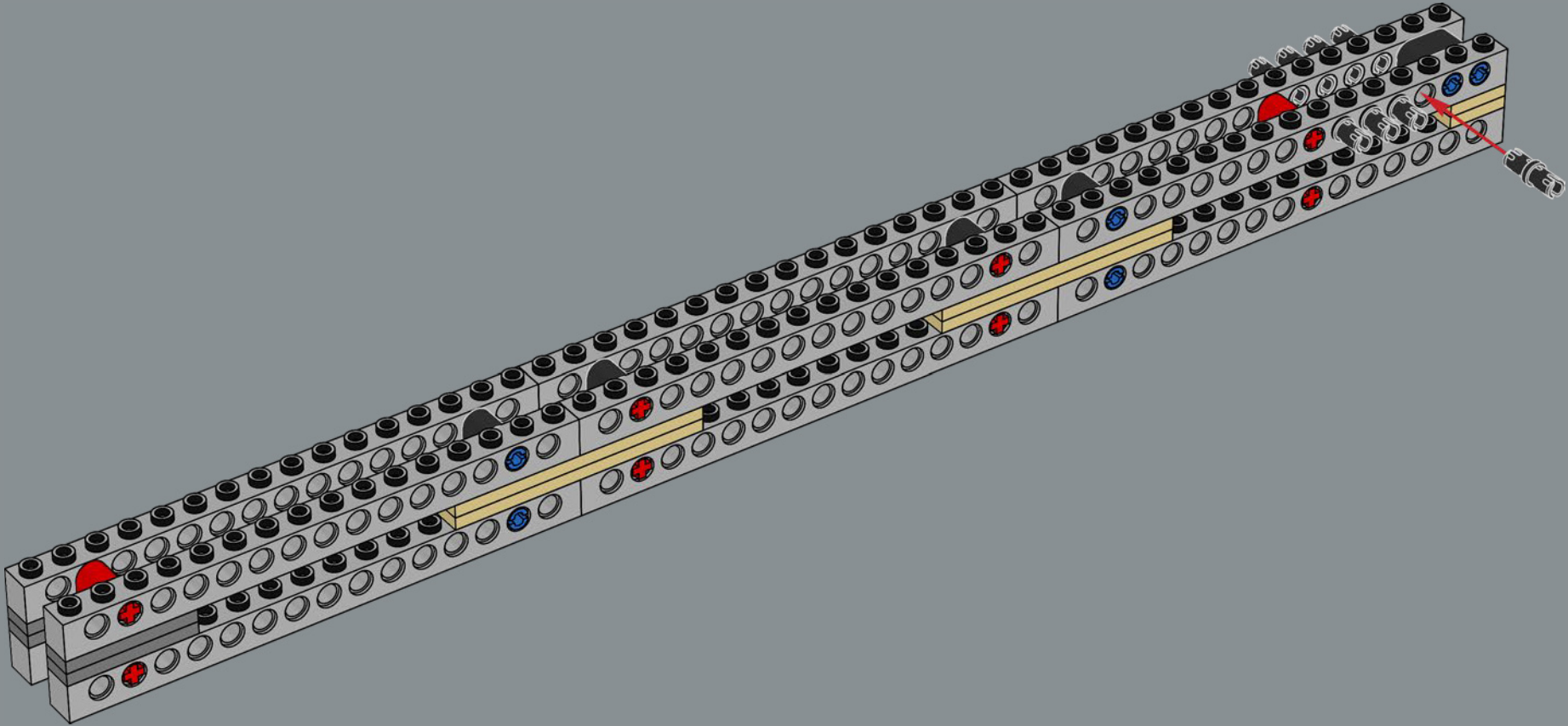

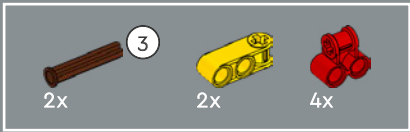

20

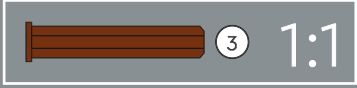
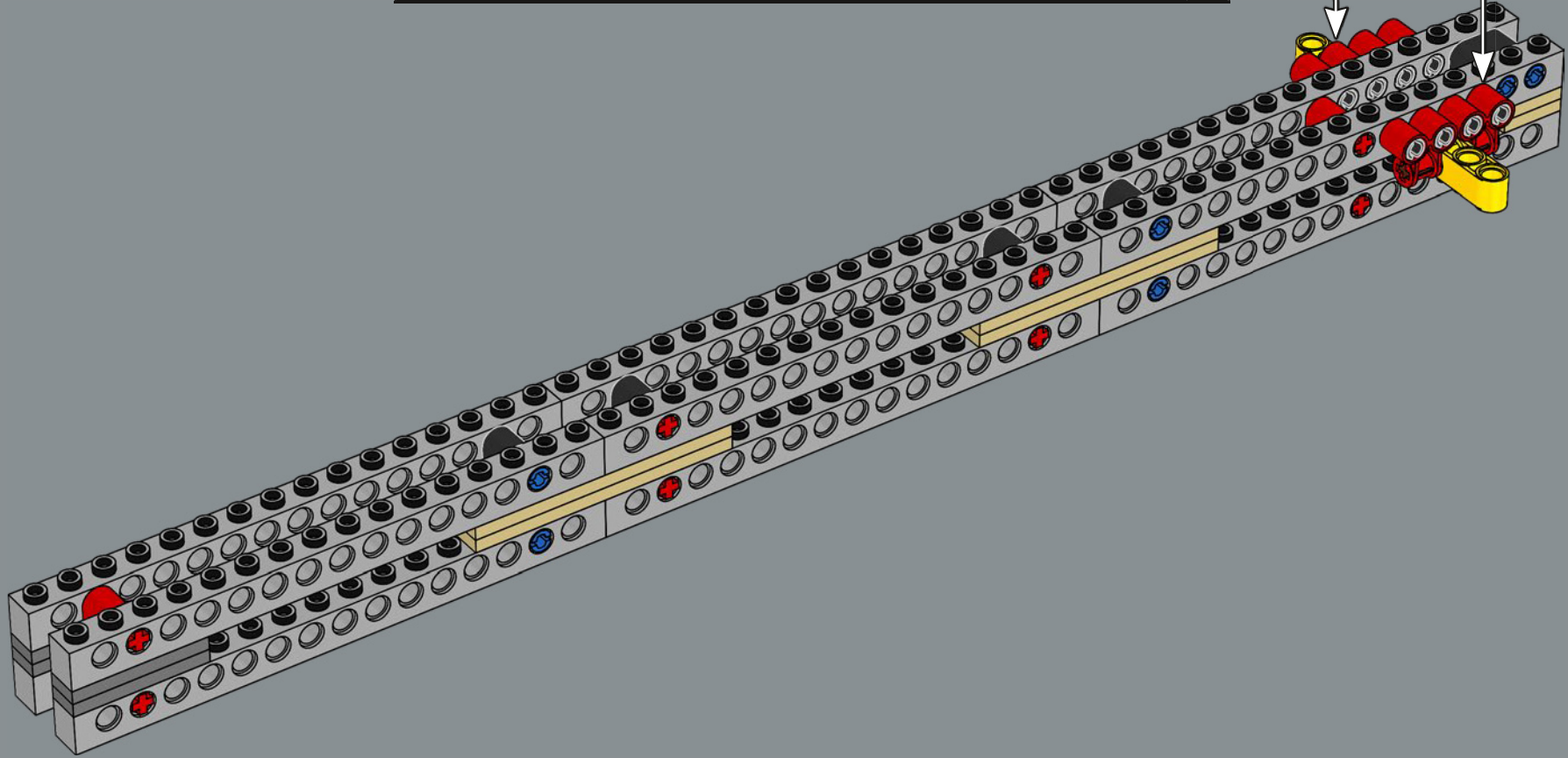
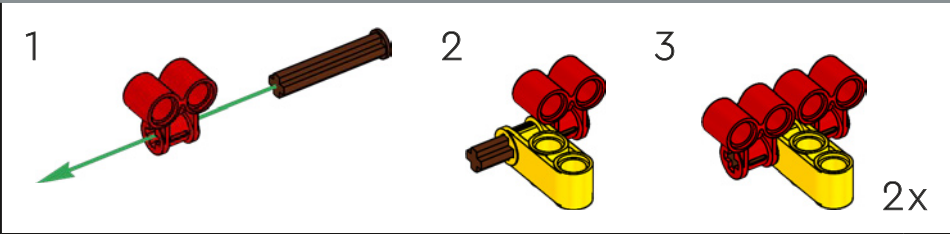





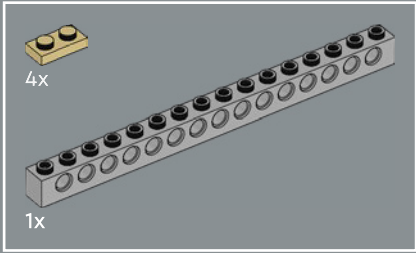
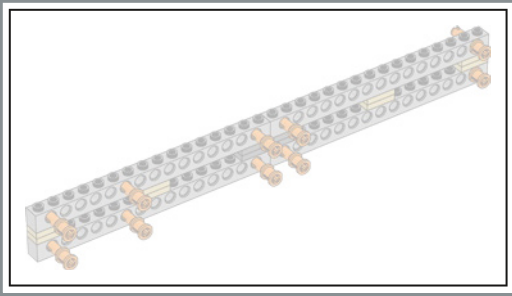

22

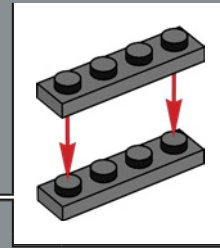
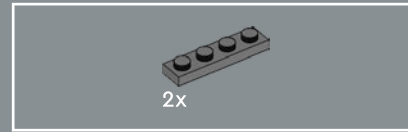
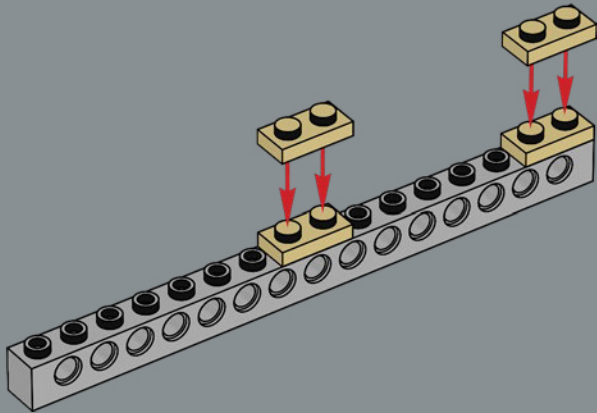

23

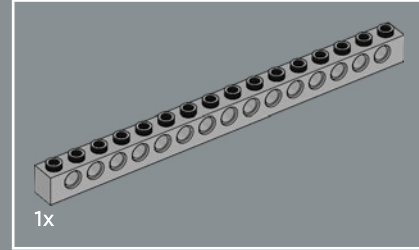
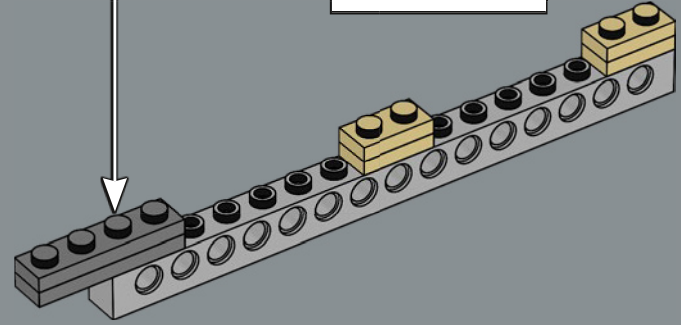

24

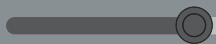
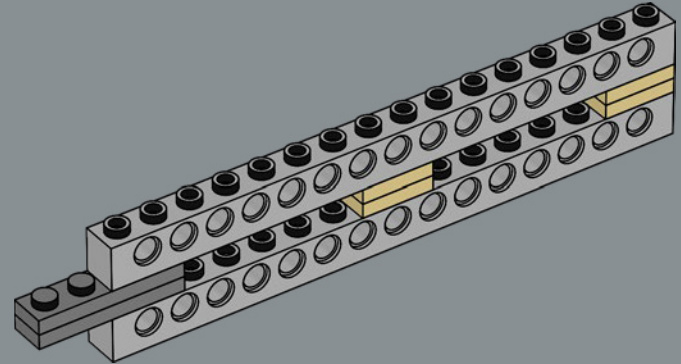



25

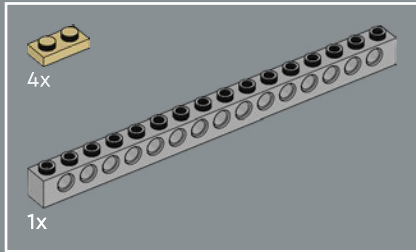
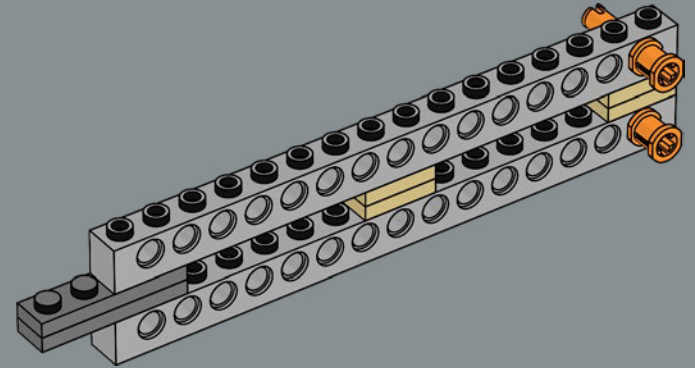

26

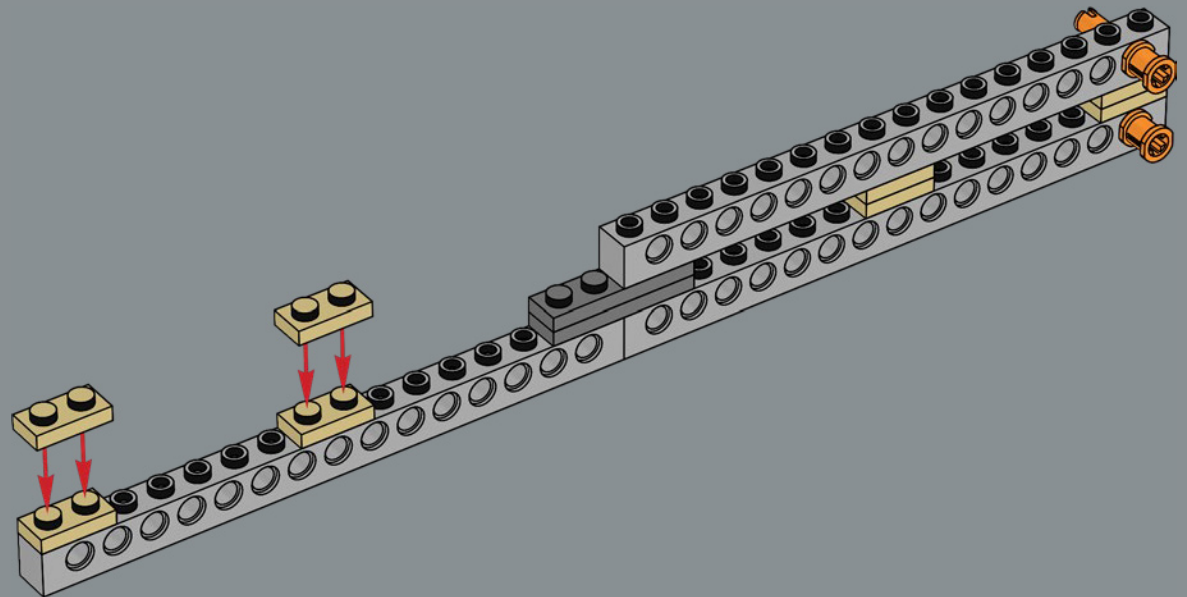

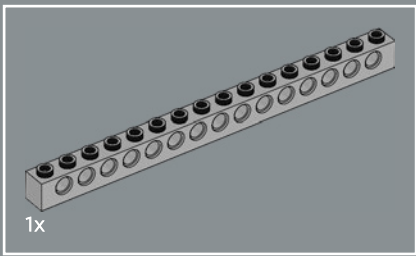

27

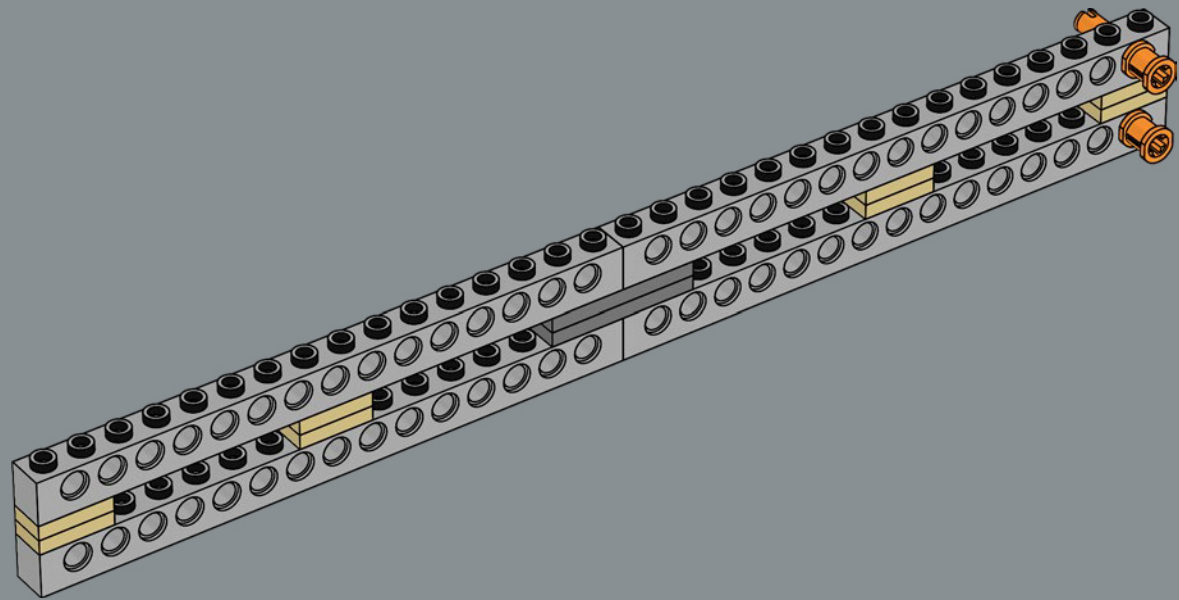

28

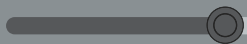
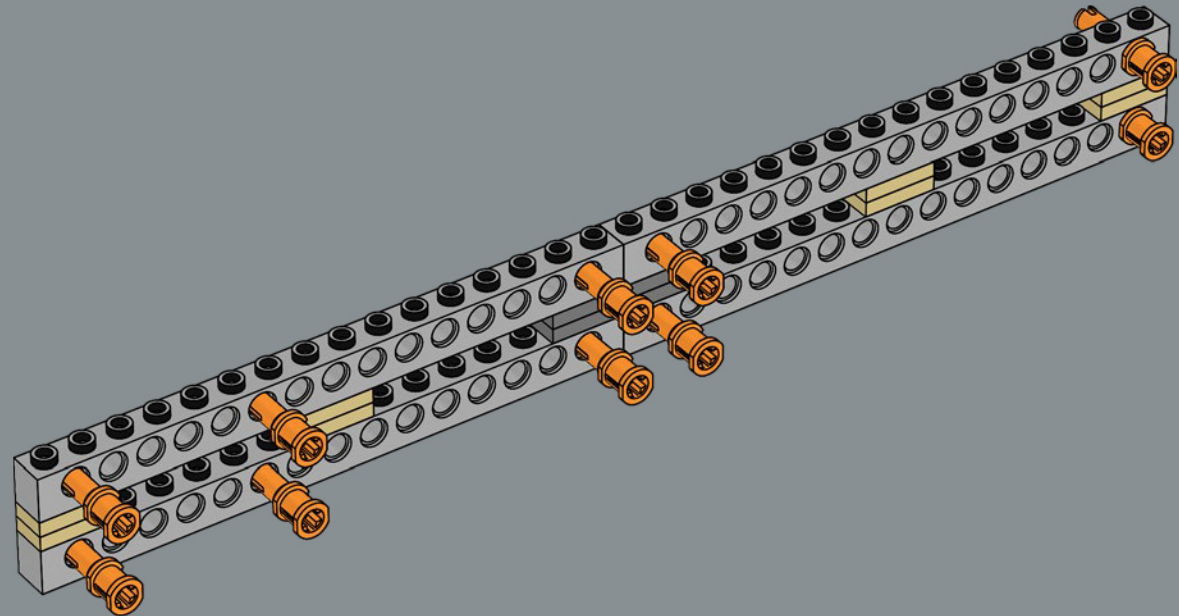

29

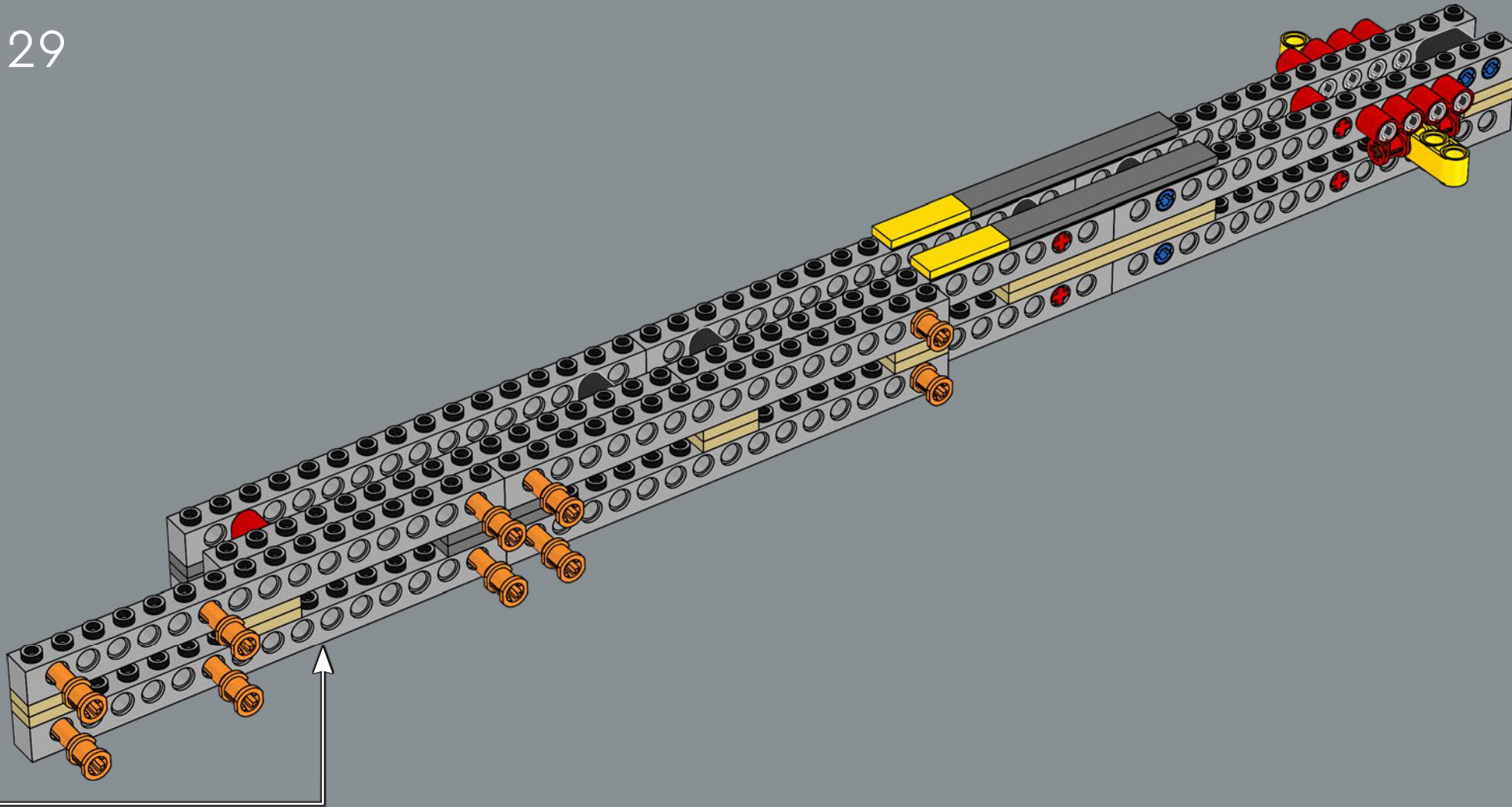

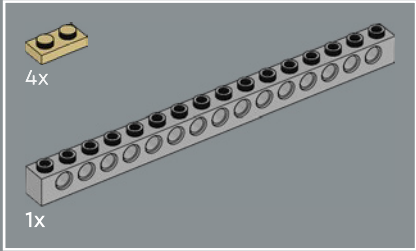
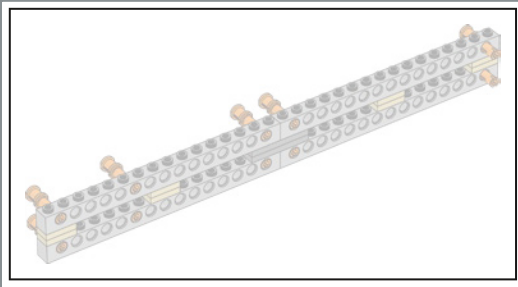

30

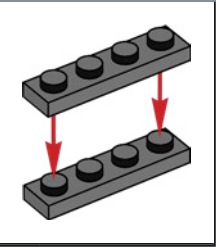
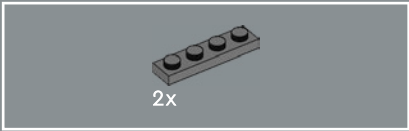
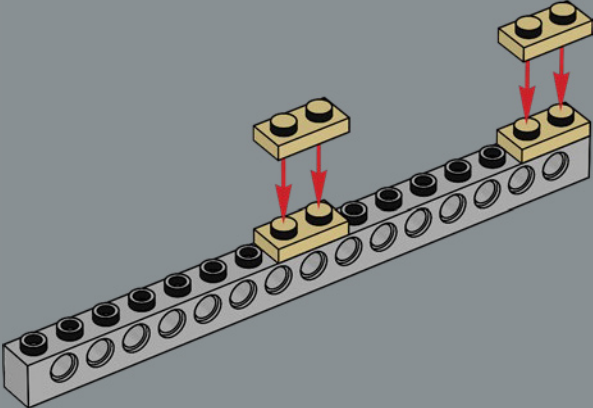

31

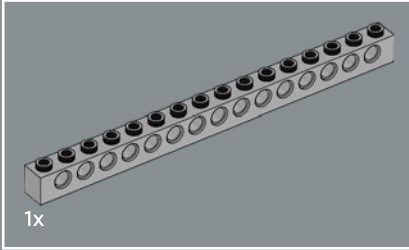
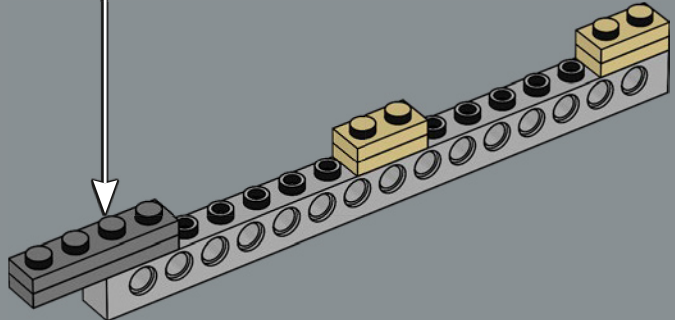

32

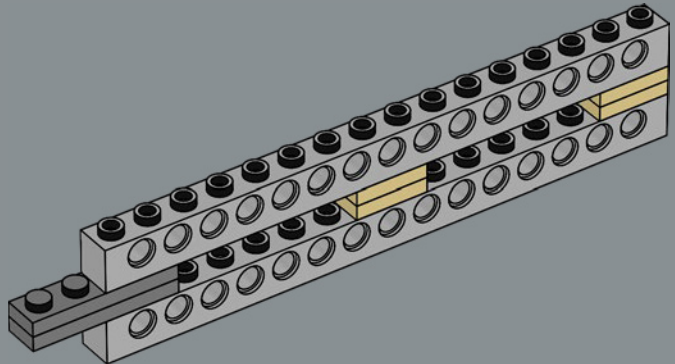



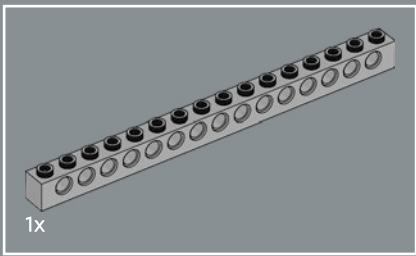

35

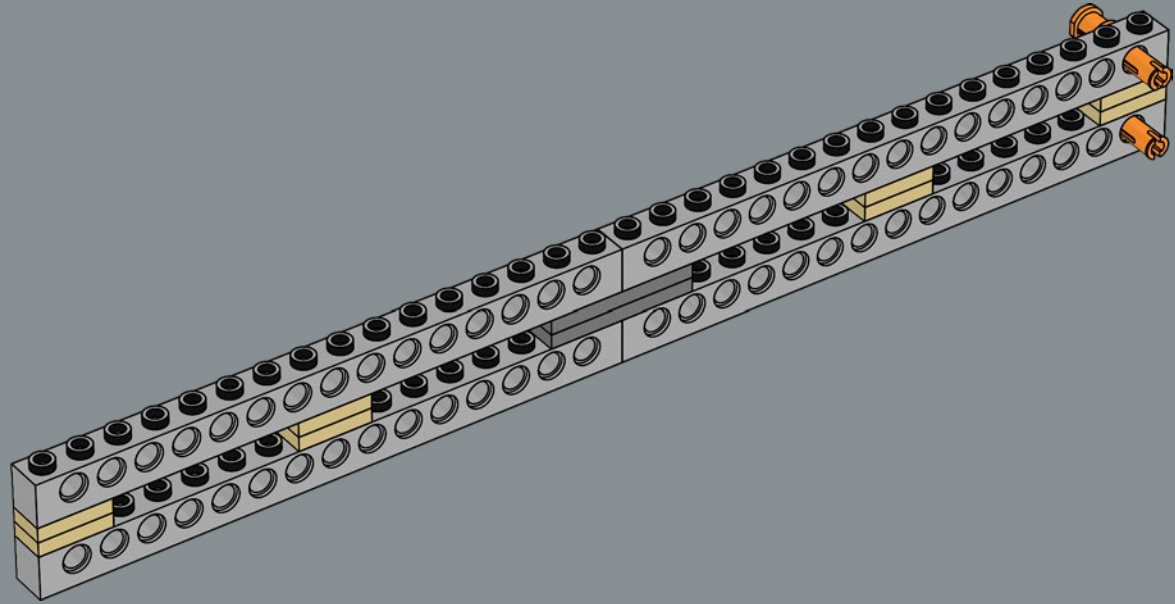

36

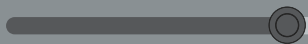
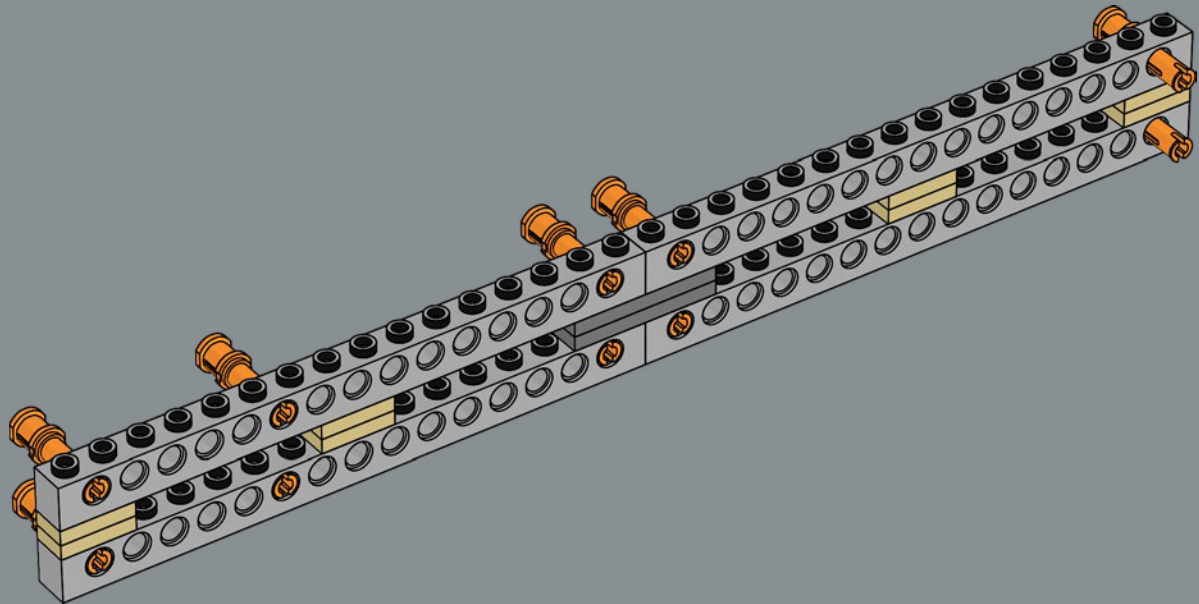



37

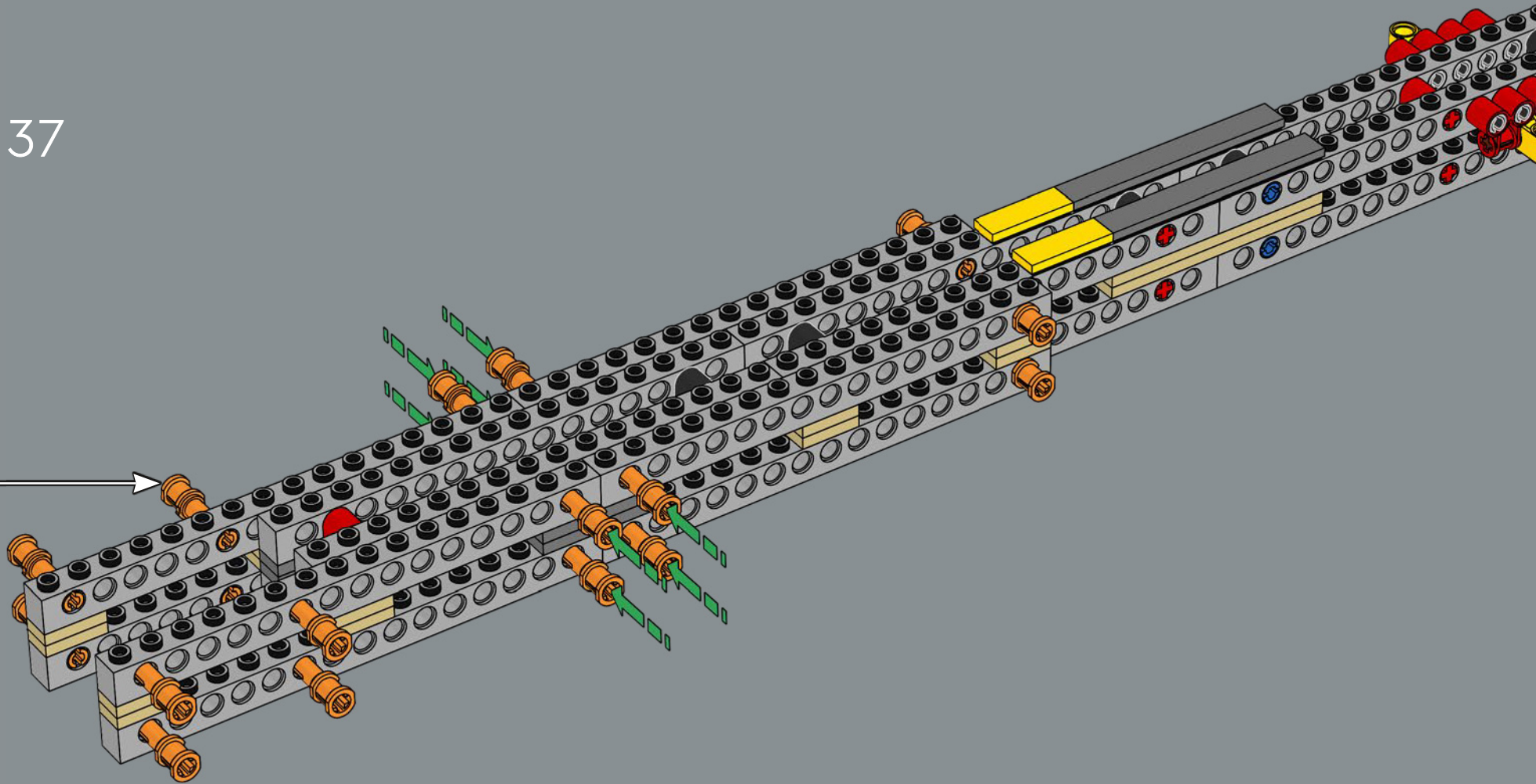

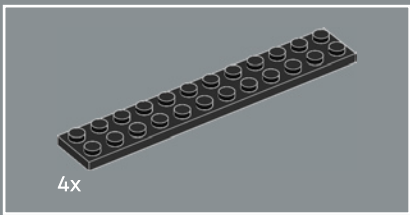

38

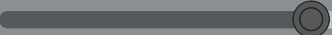
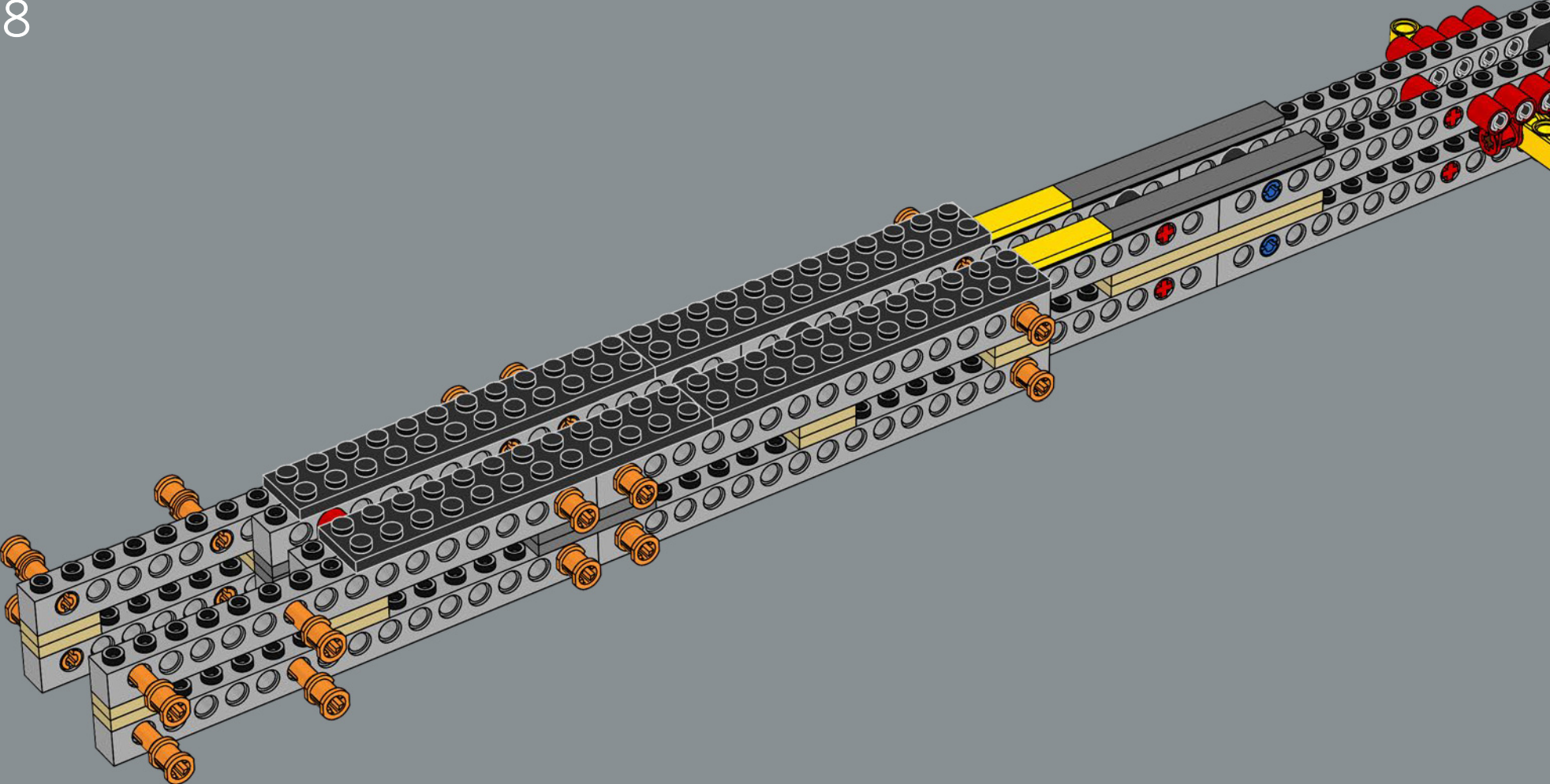

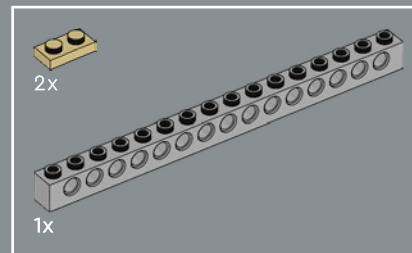
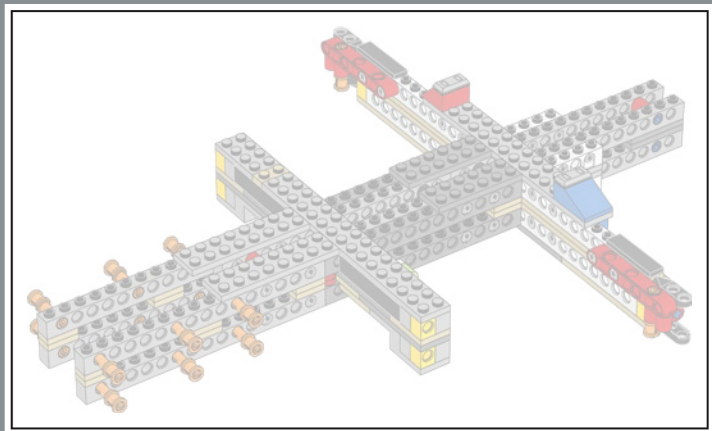

39

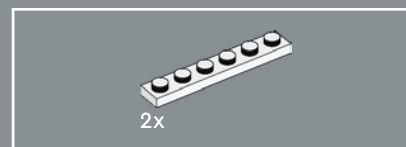
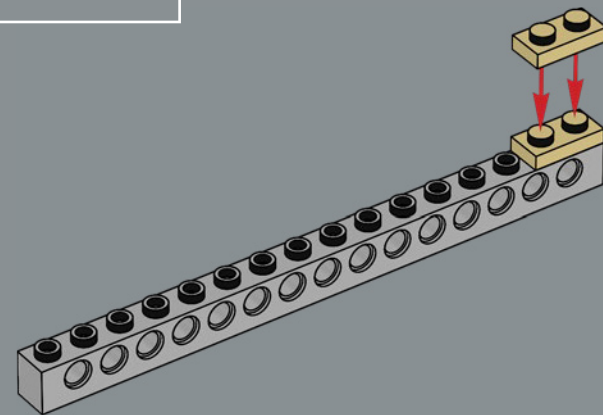

40

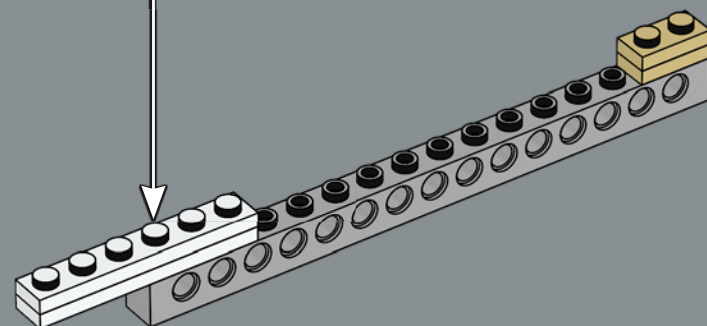
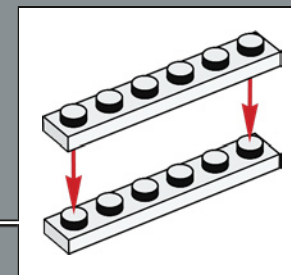

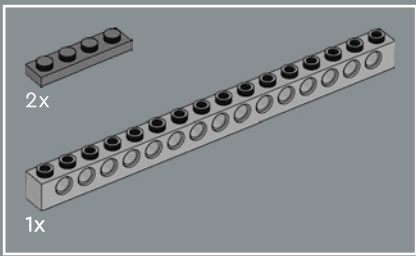

41

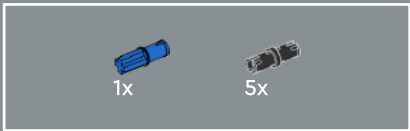
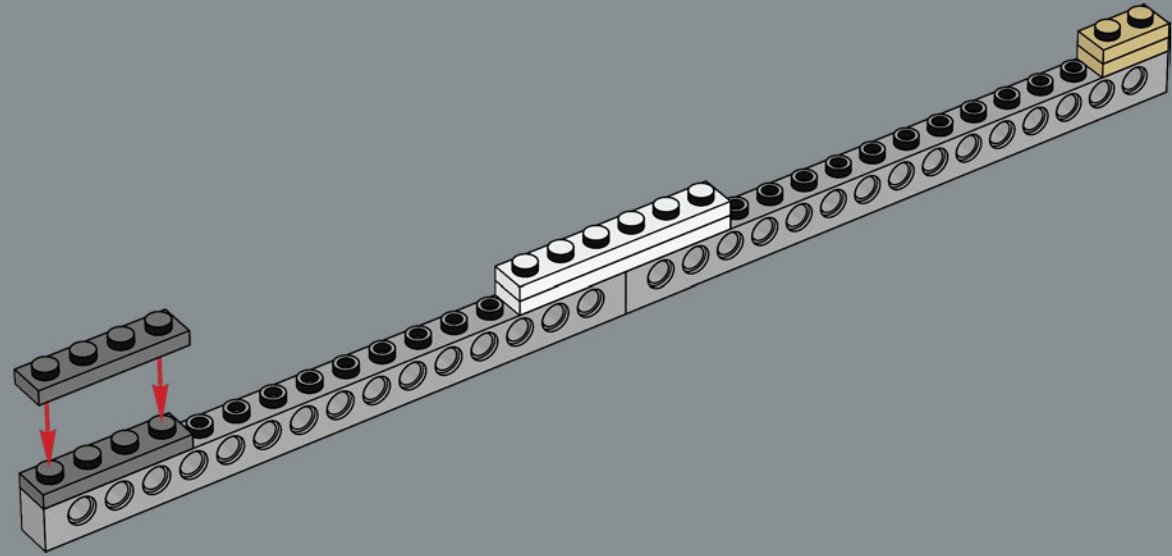

42

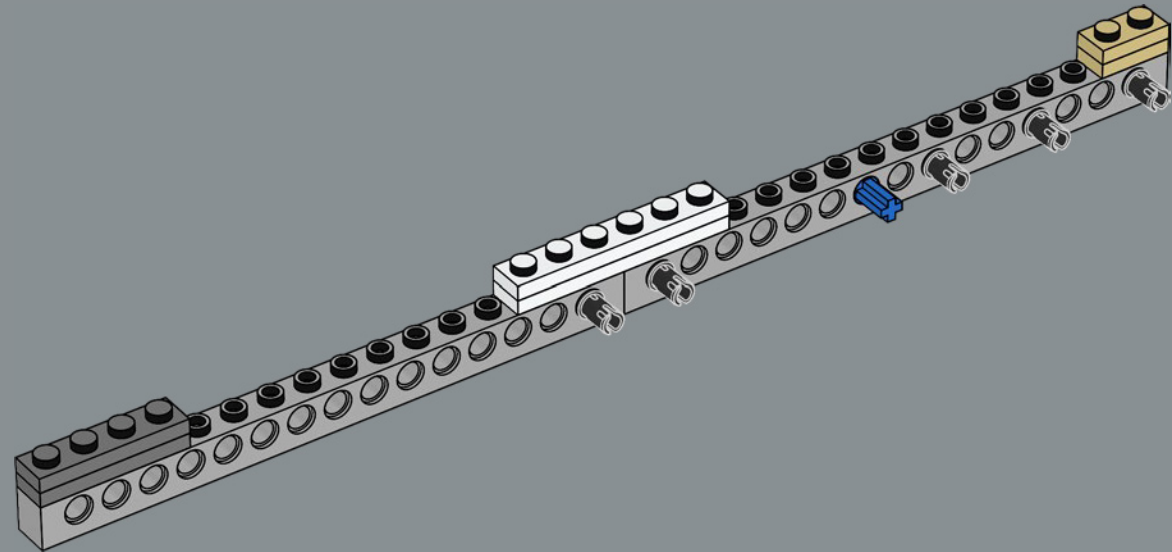

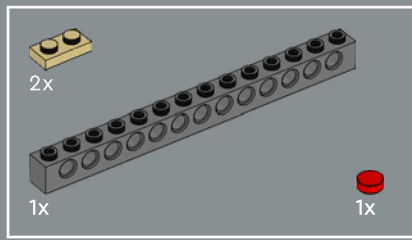

43

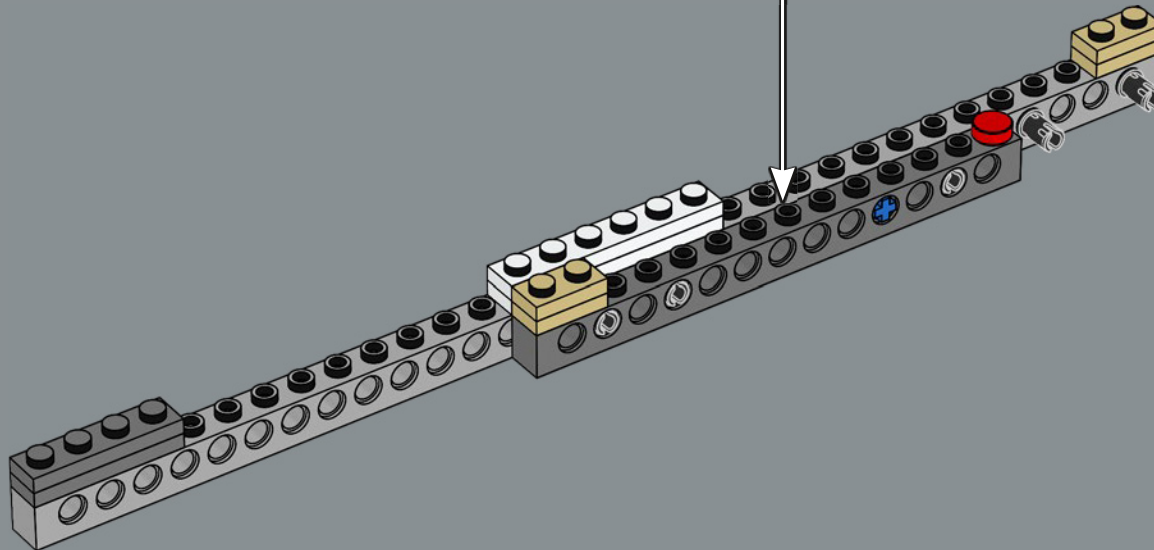
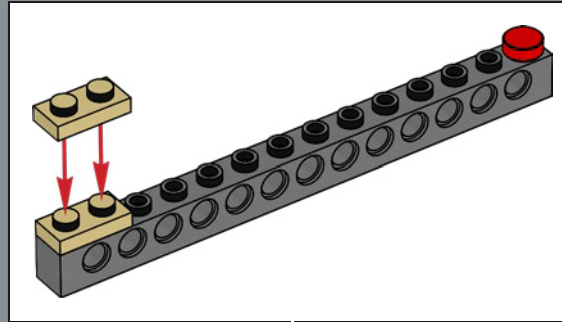

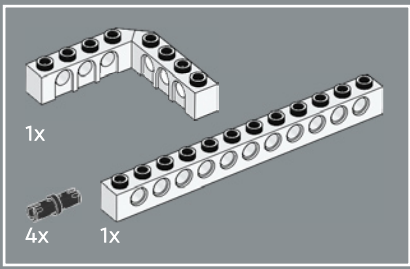

44

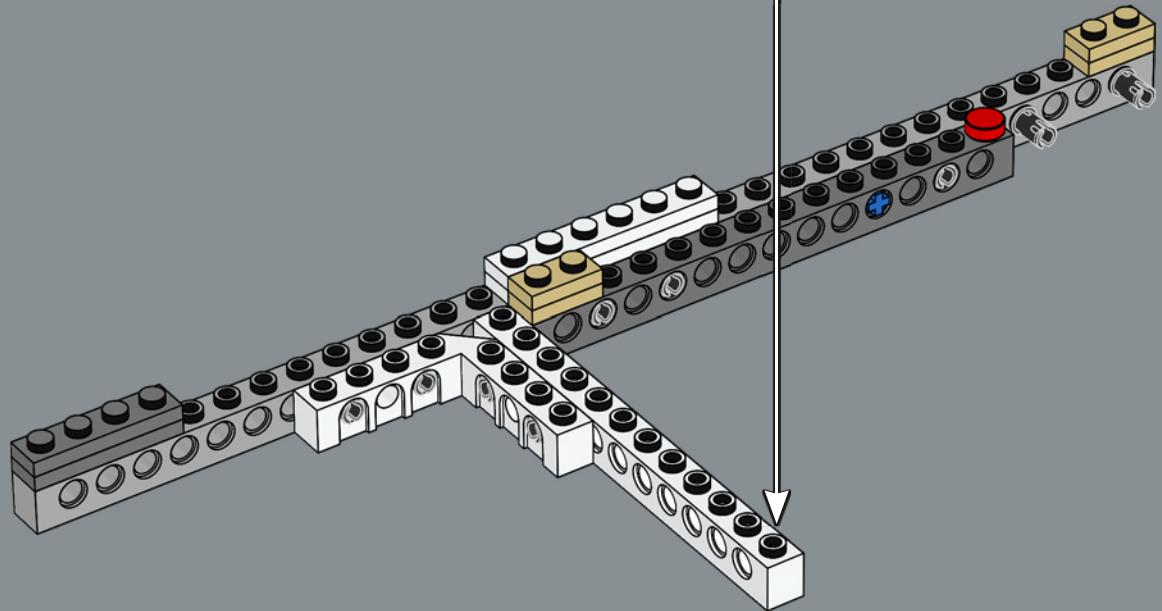
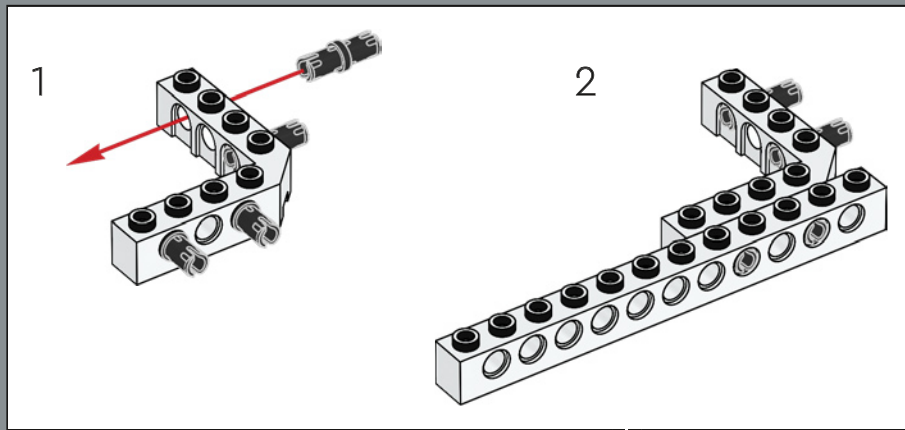





1x

46

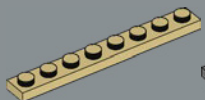
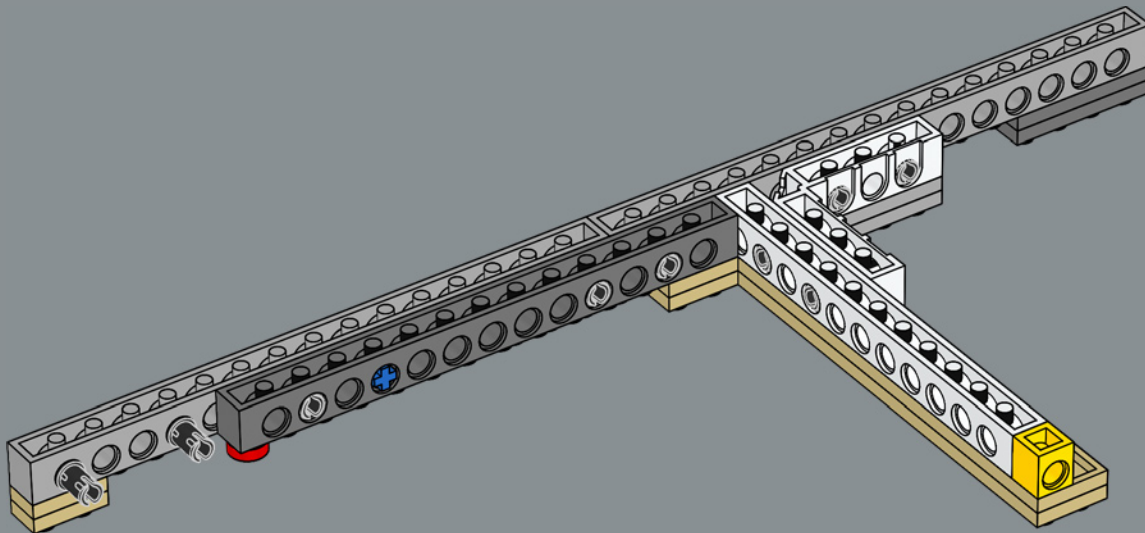

2x



1x

47

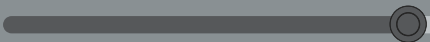
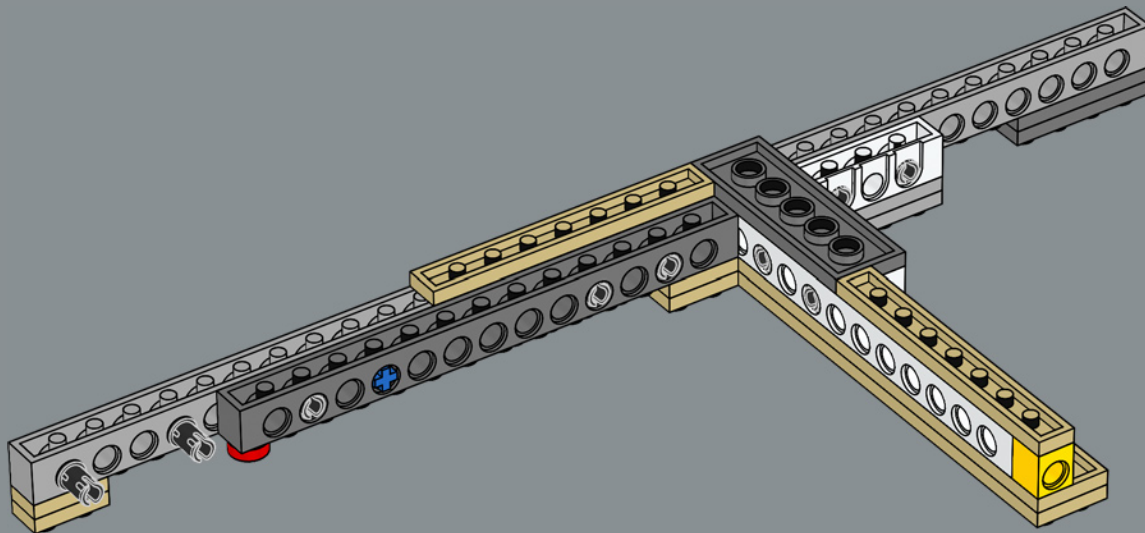



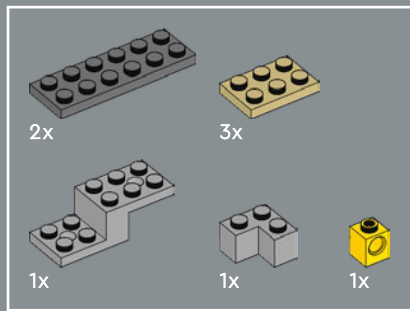

48

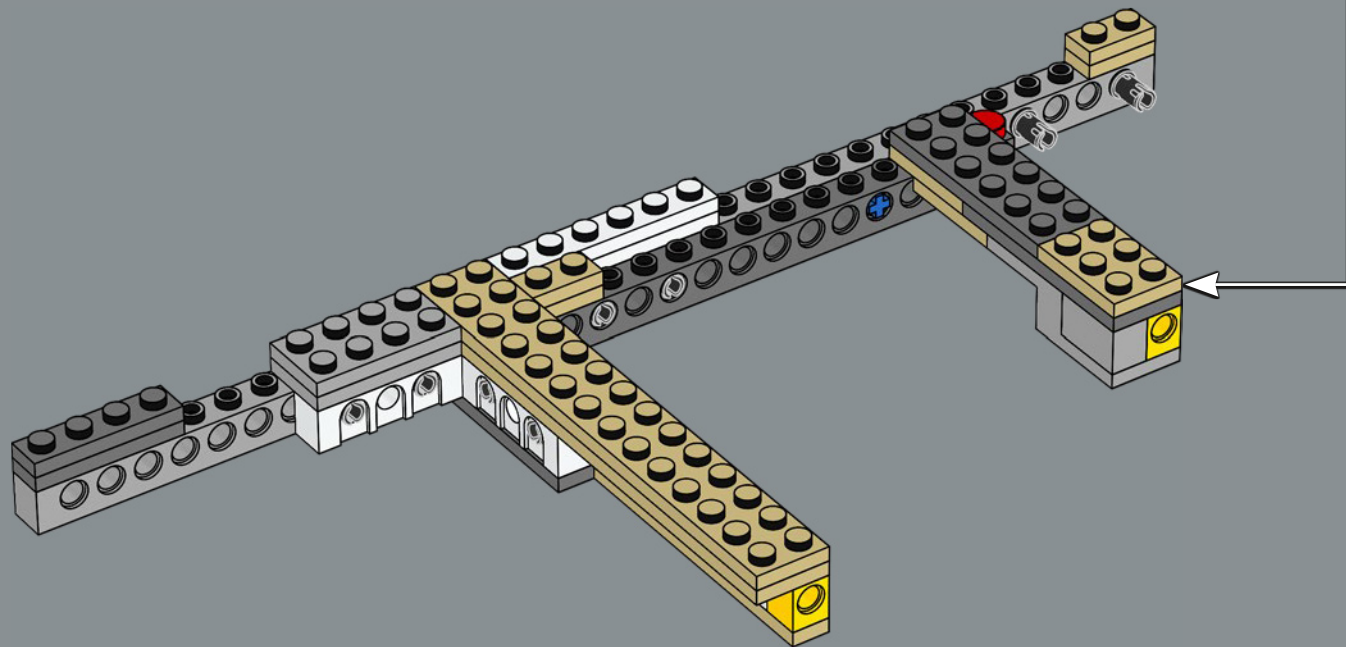
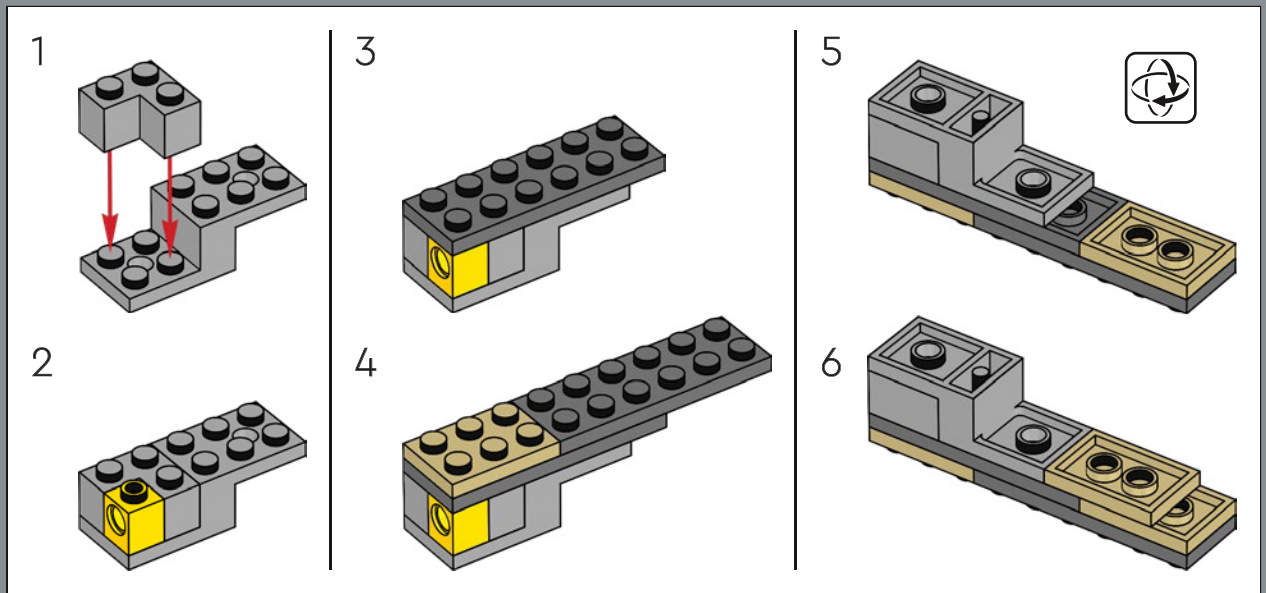

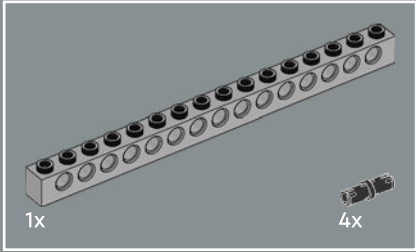
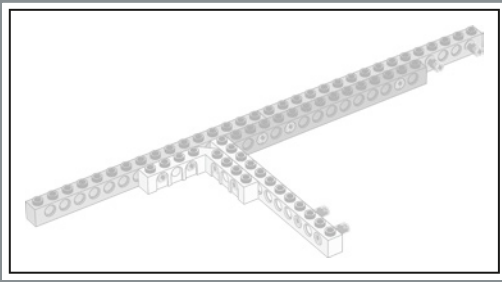

49

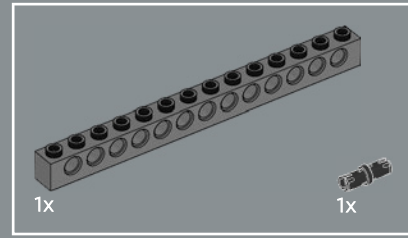
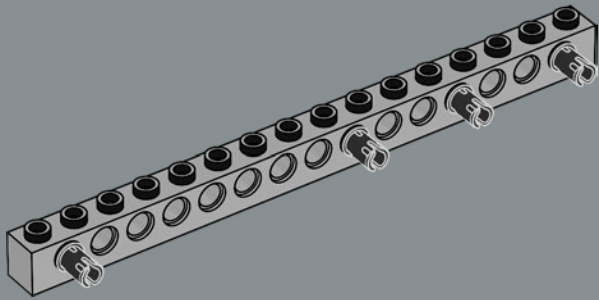

50

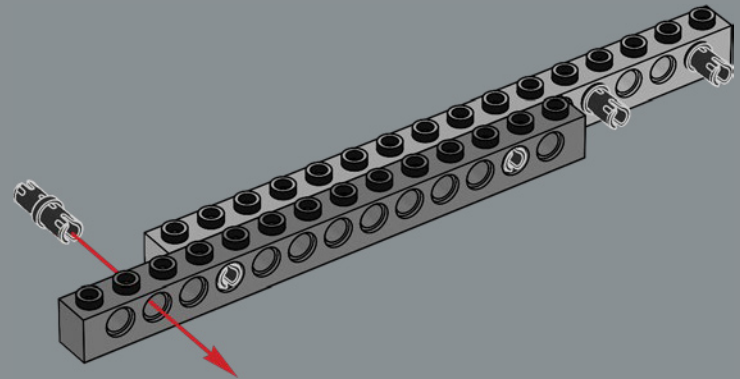

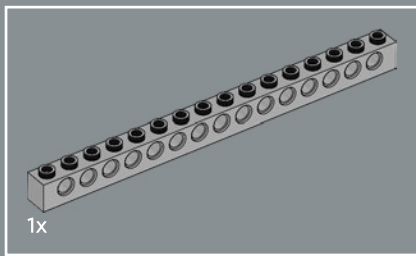

51

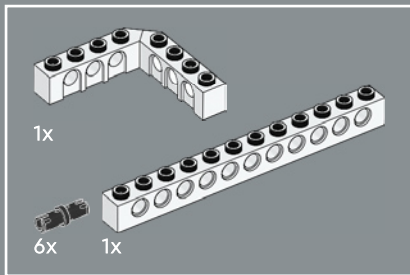
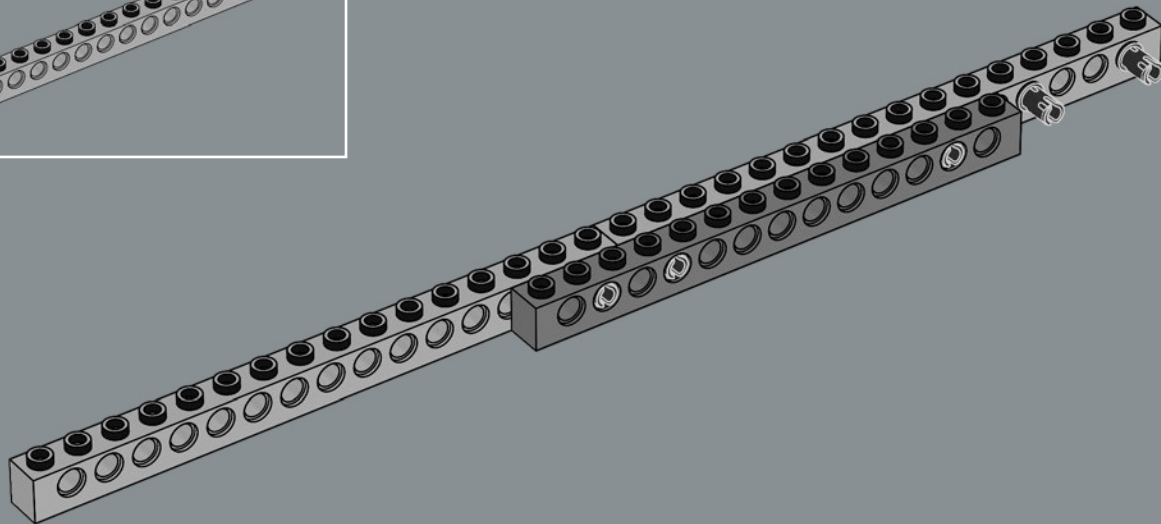

52

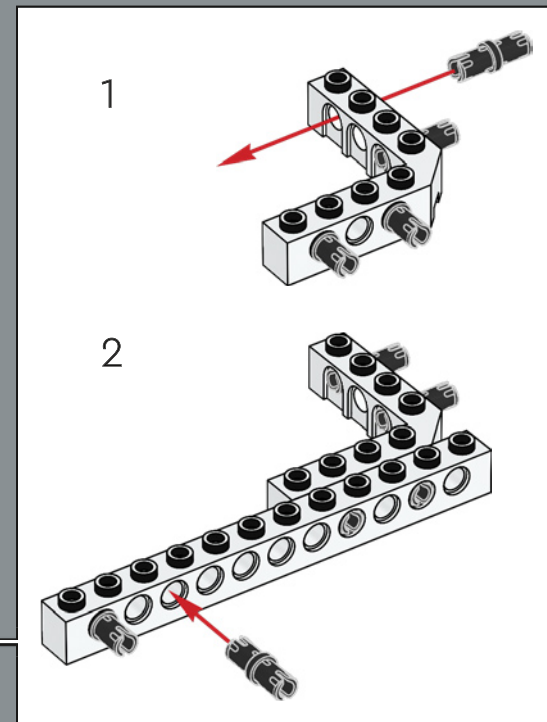
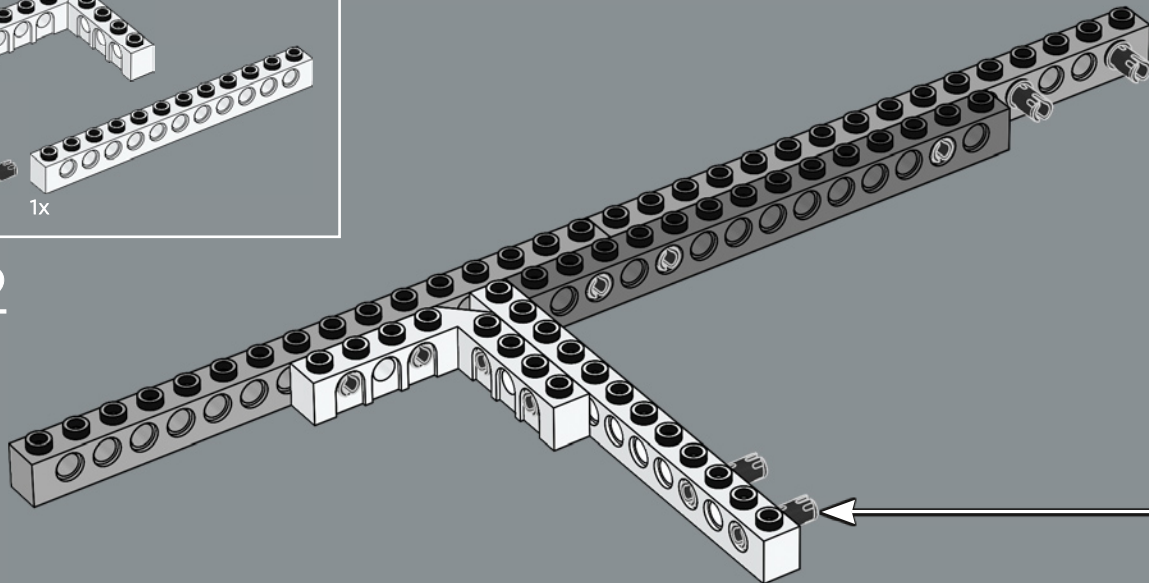



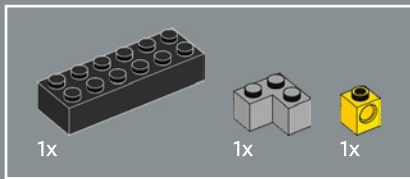

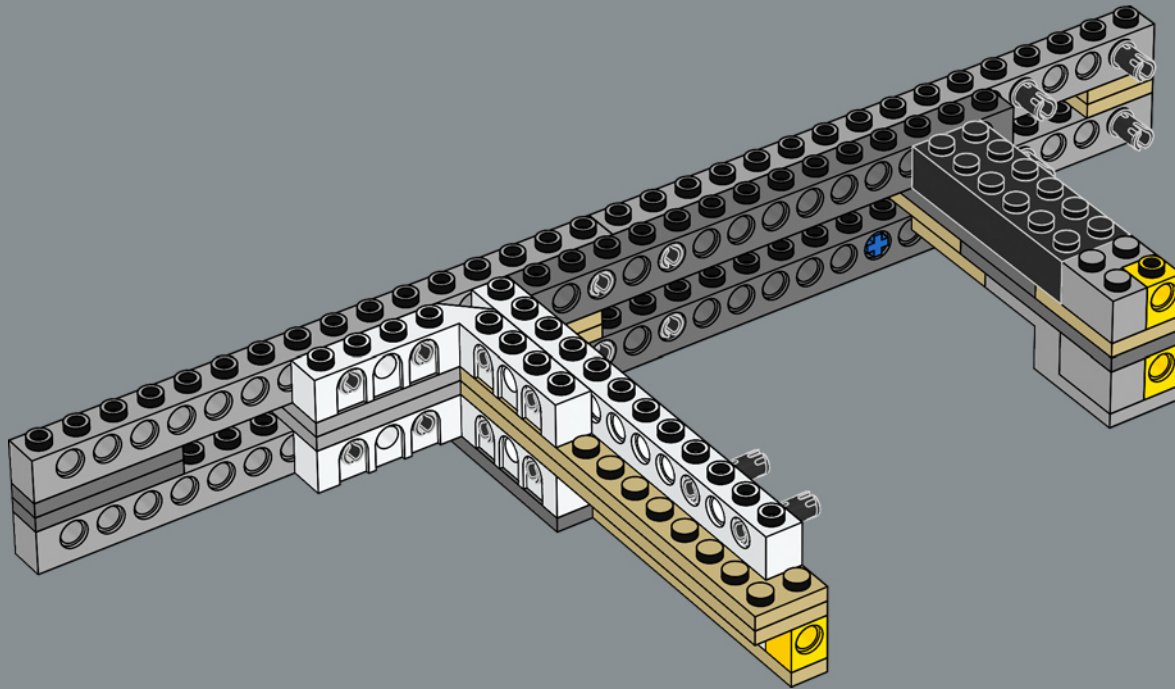

54



 1x	 1x
--	--

55

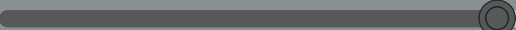
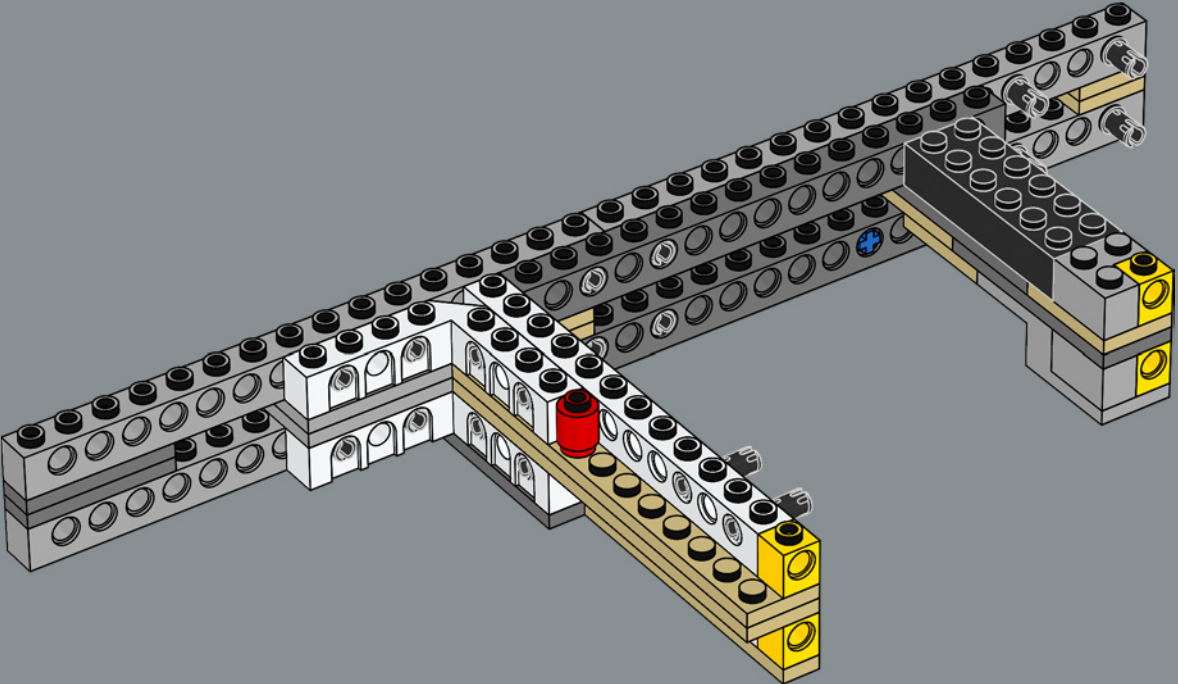



56

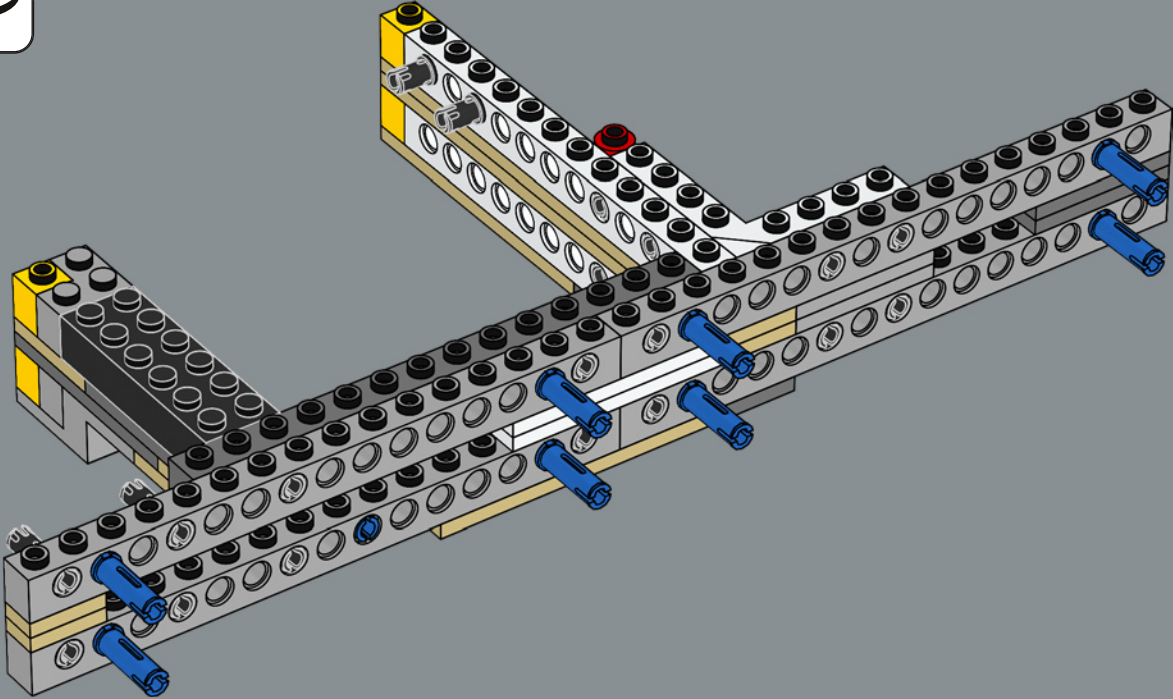

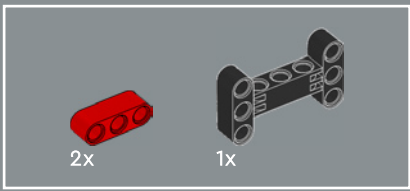

57

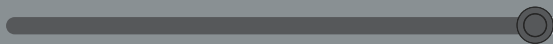
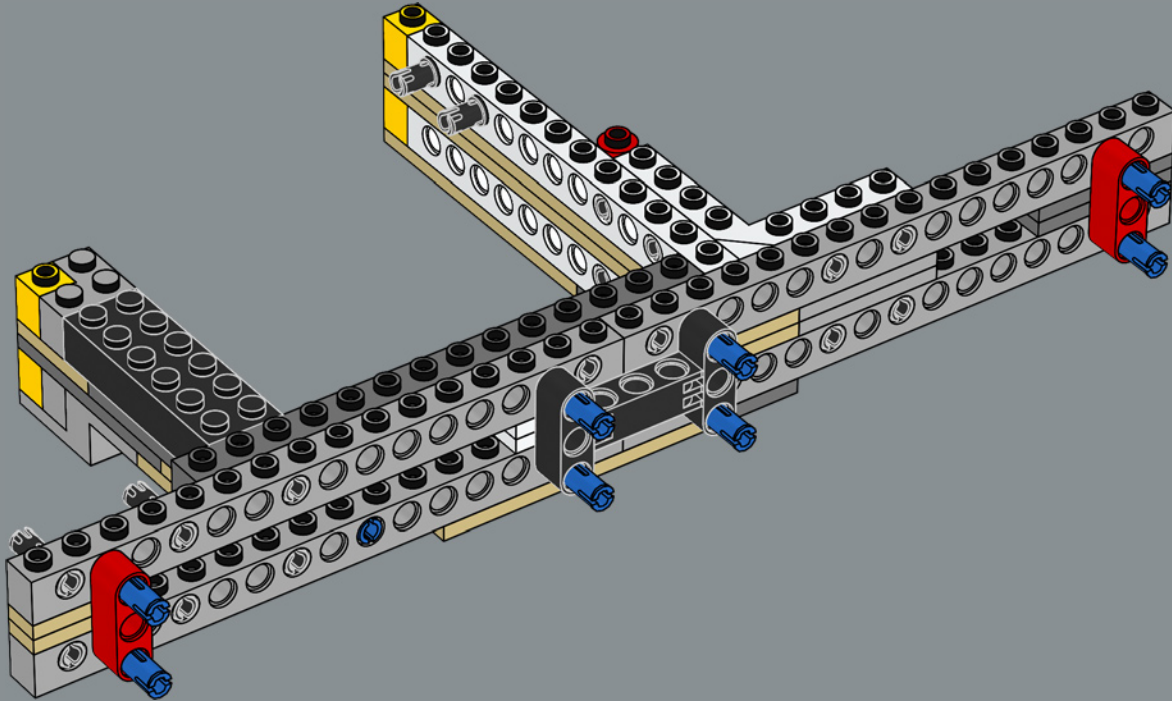



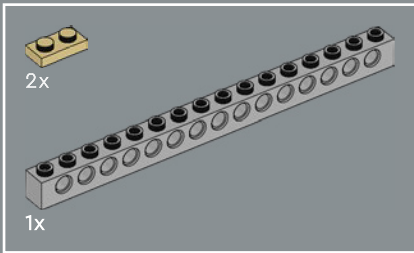
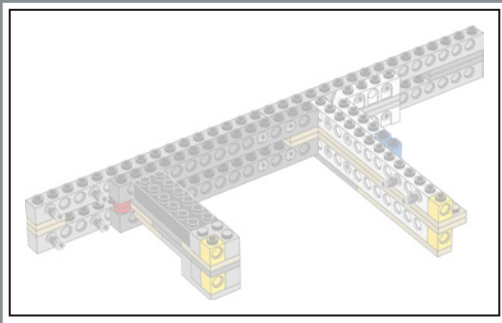

58

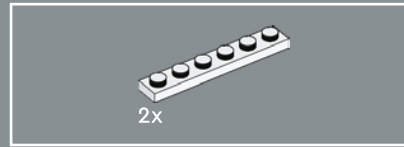
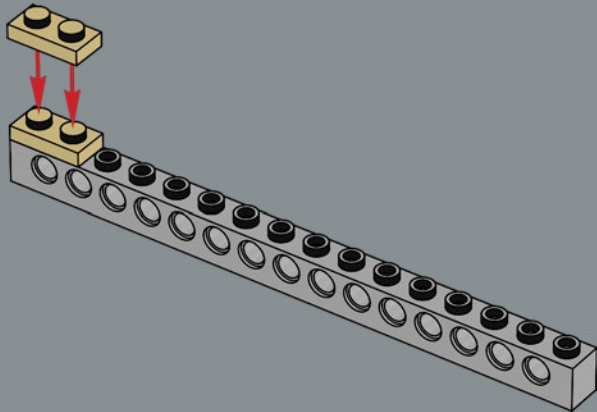

59

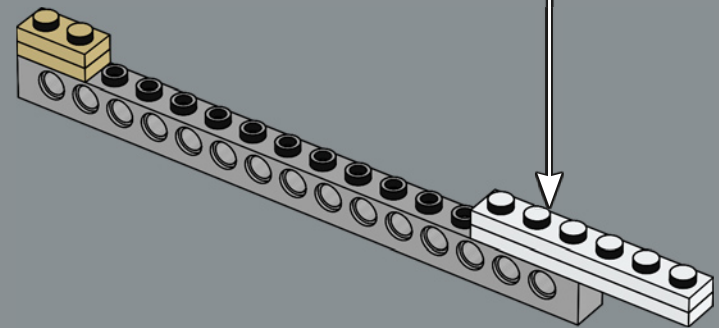
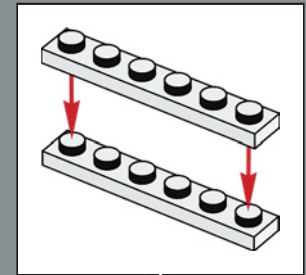

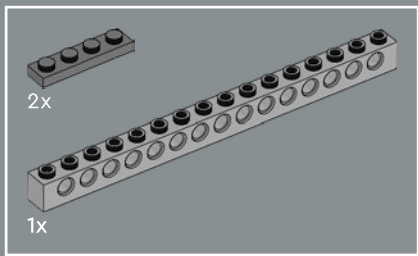

60

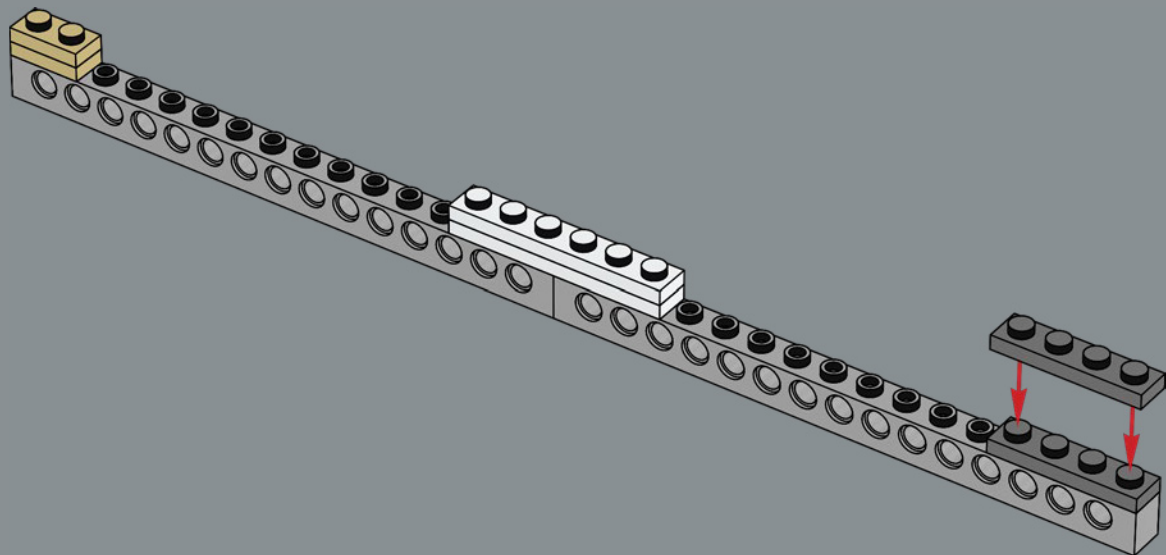

61

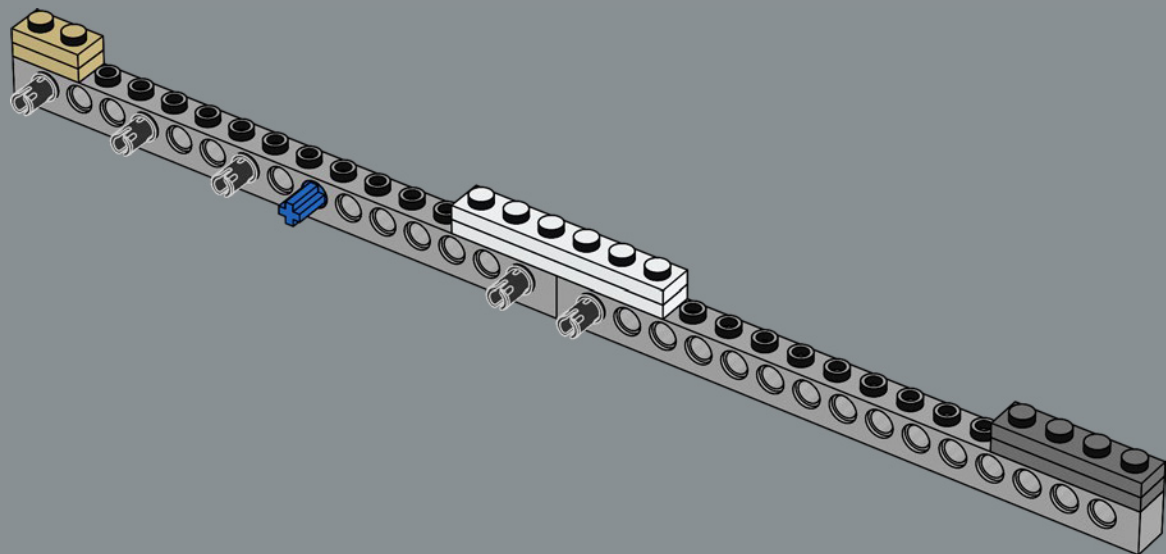

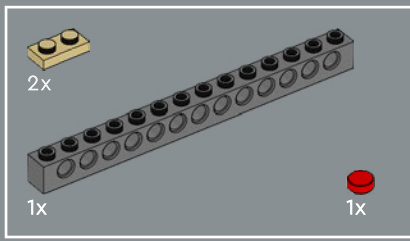

62

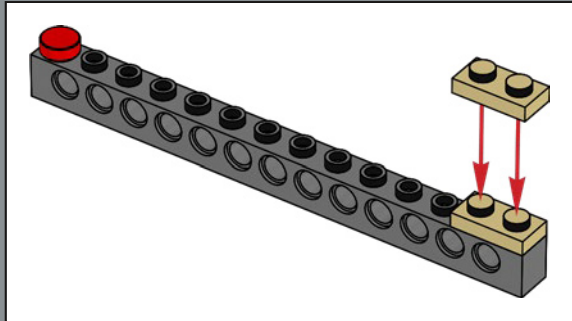
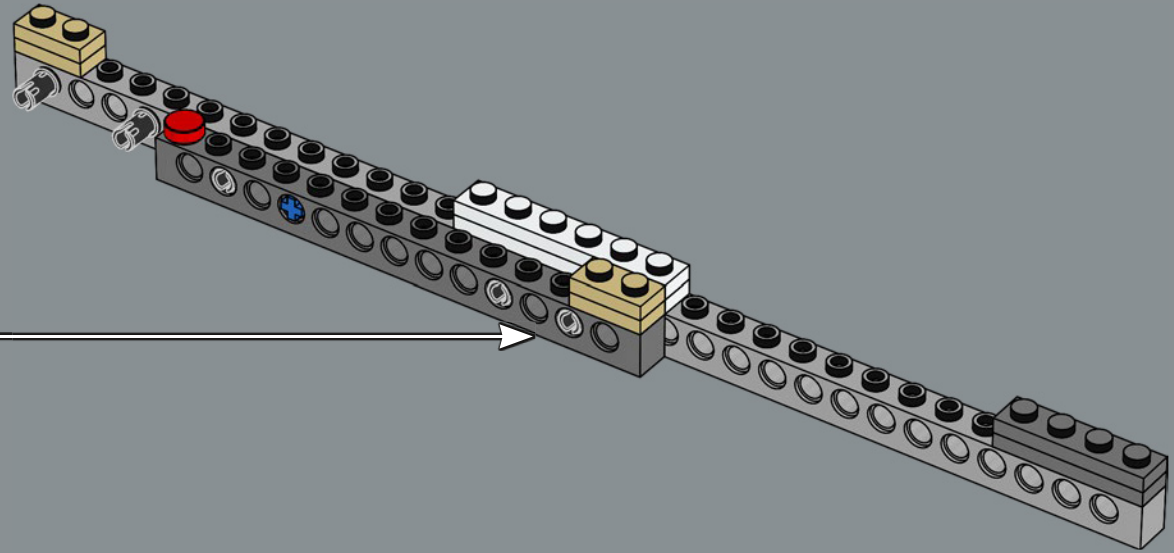

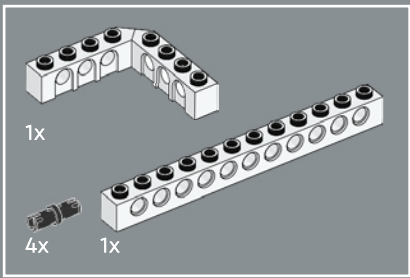

63

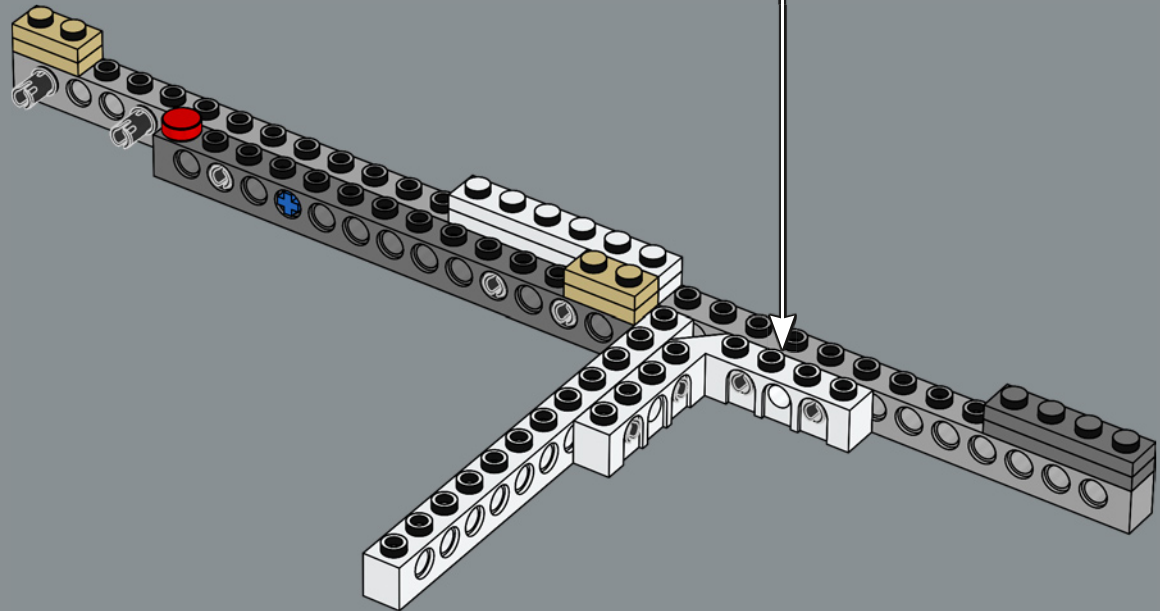
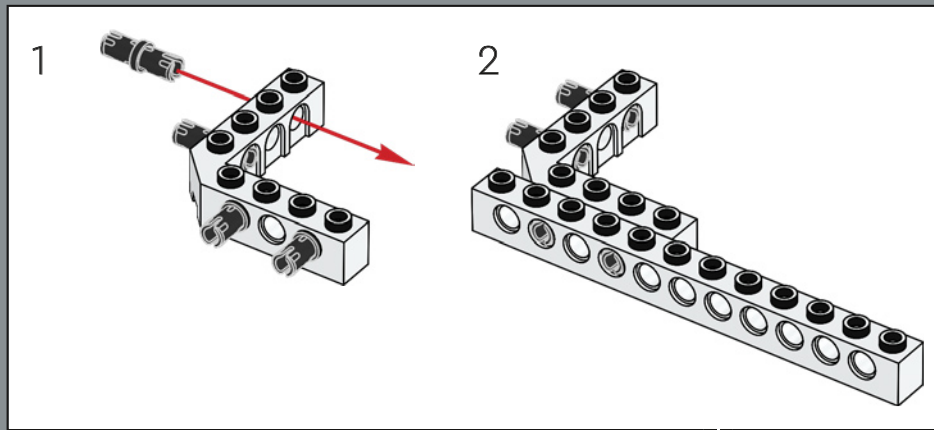

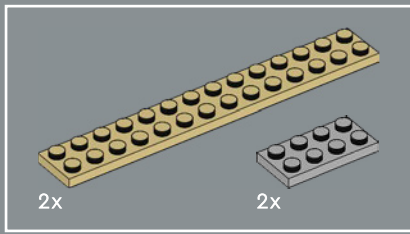

64

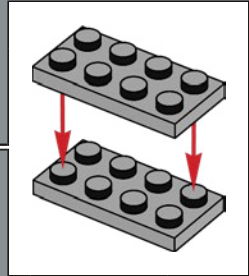
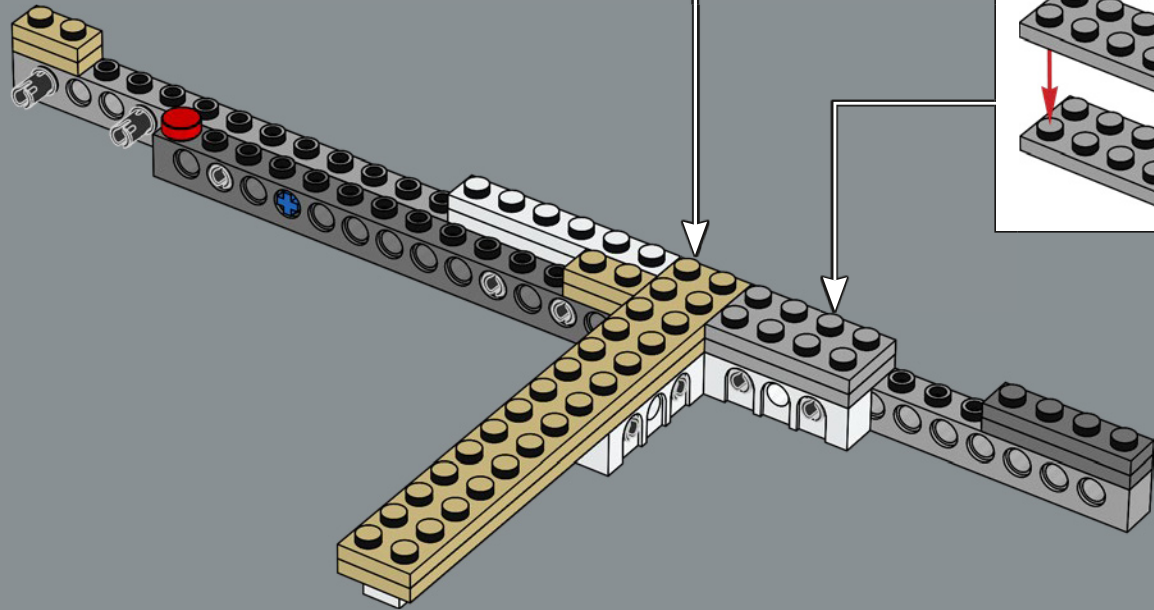
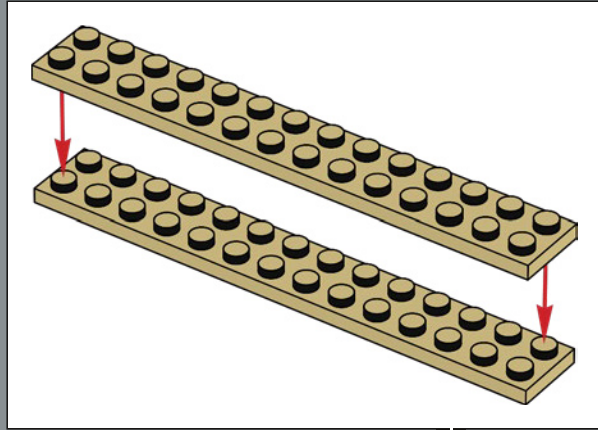



1x

65

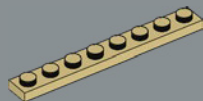
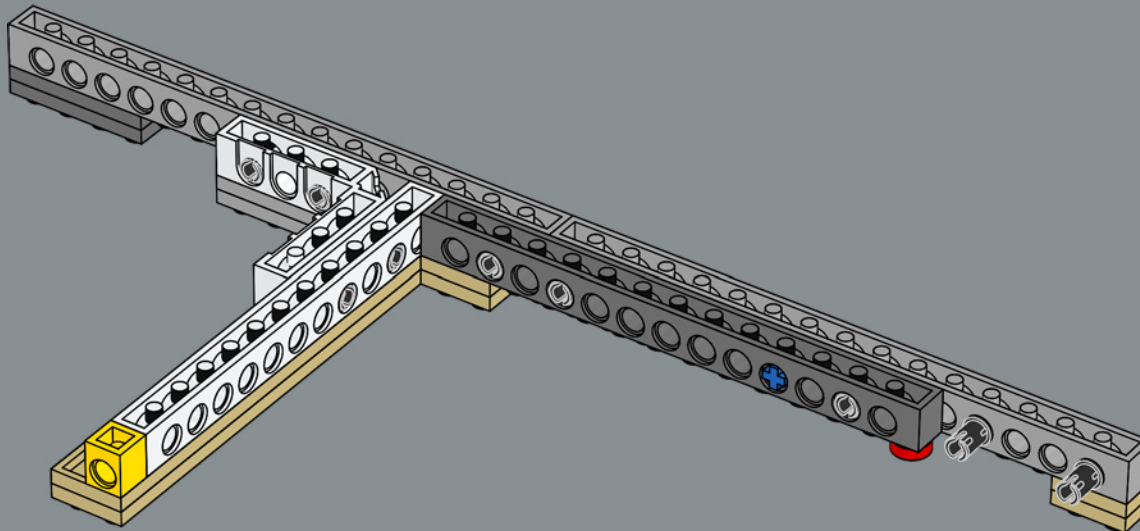

2x



1x

66

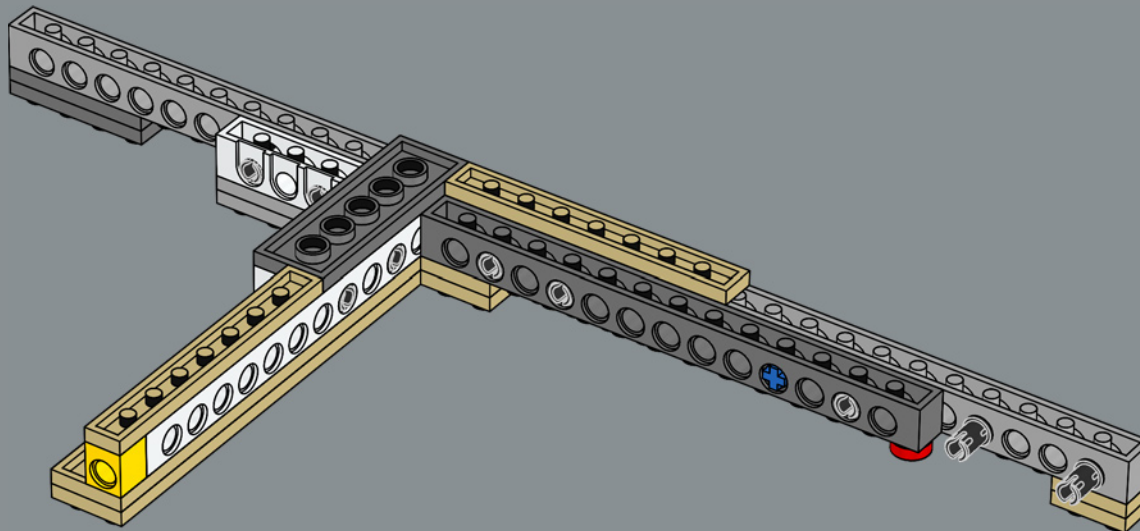

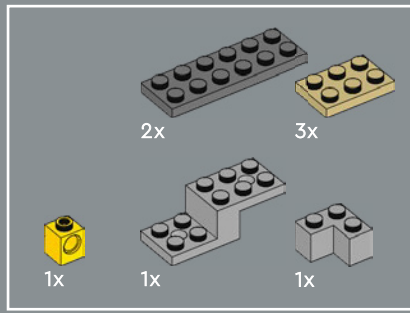

67

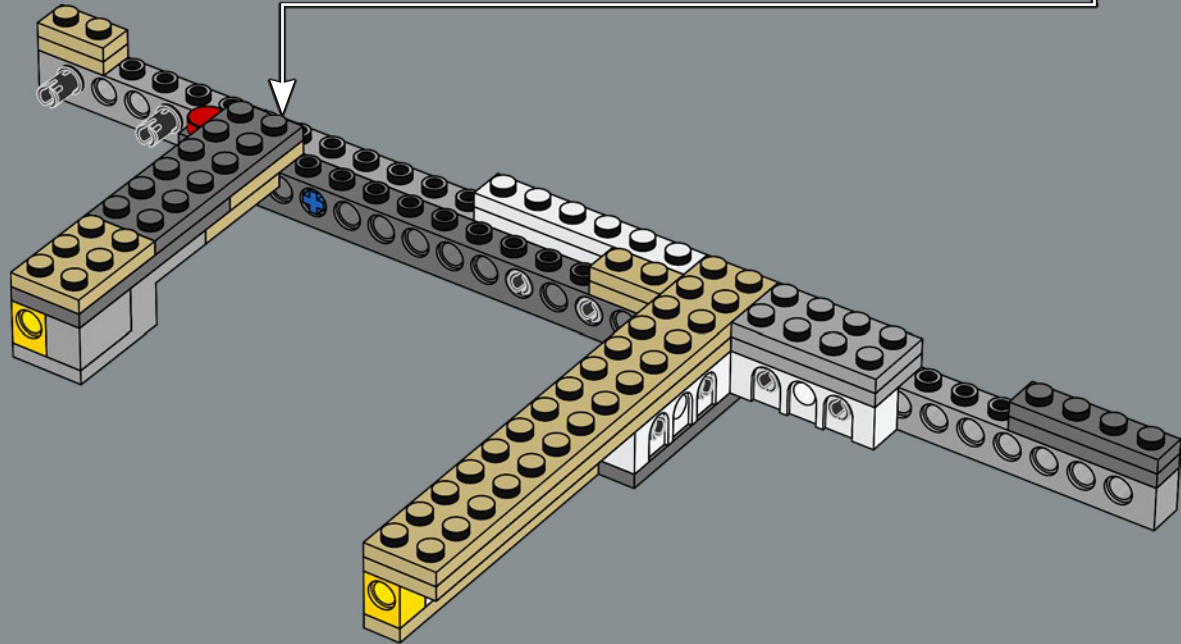
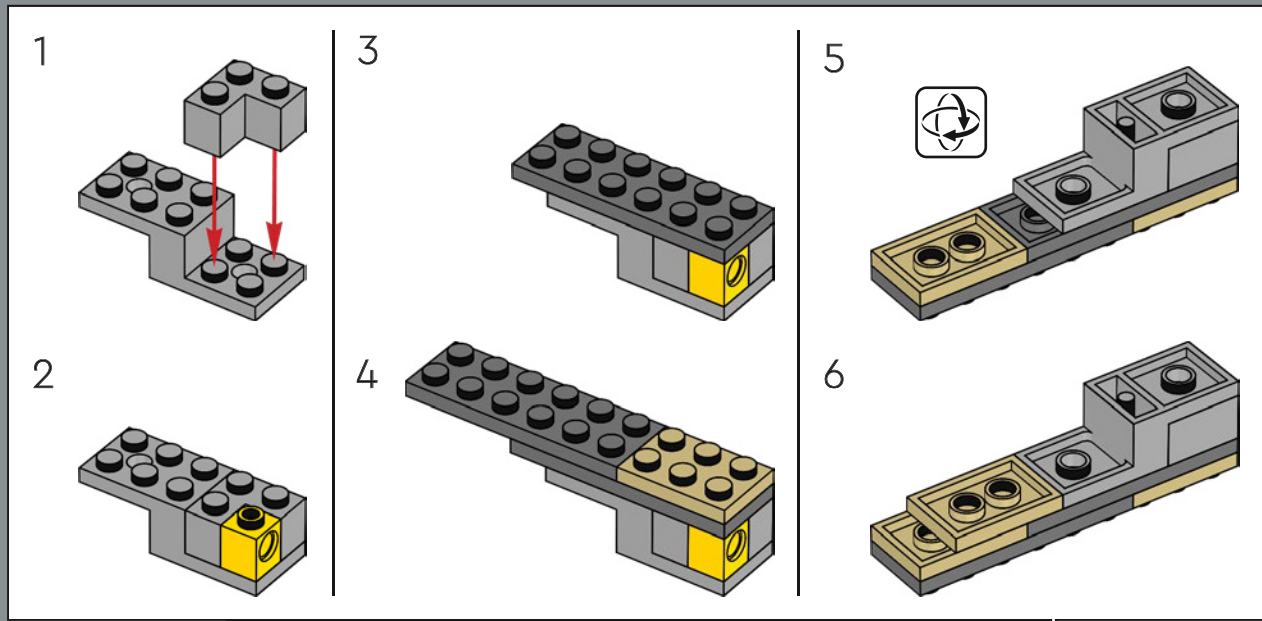

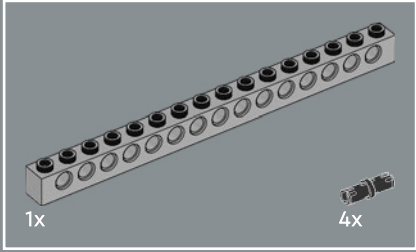
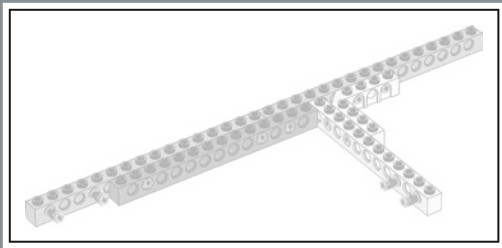

68

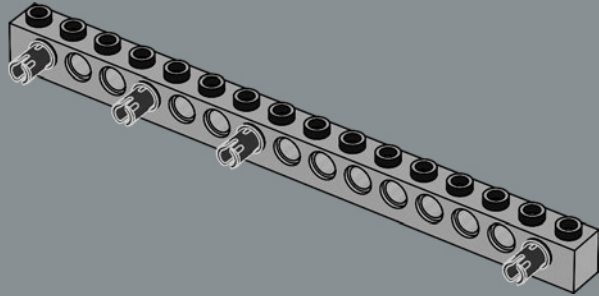



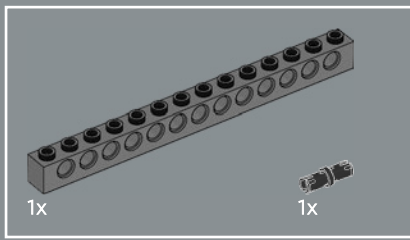

69

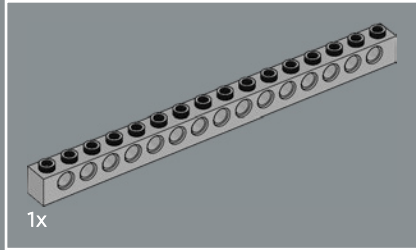
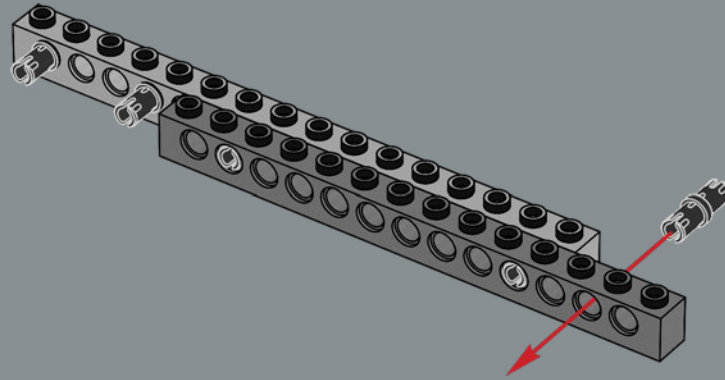

70

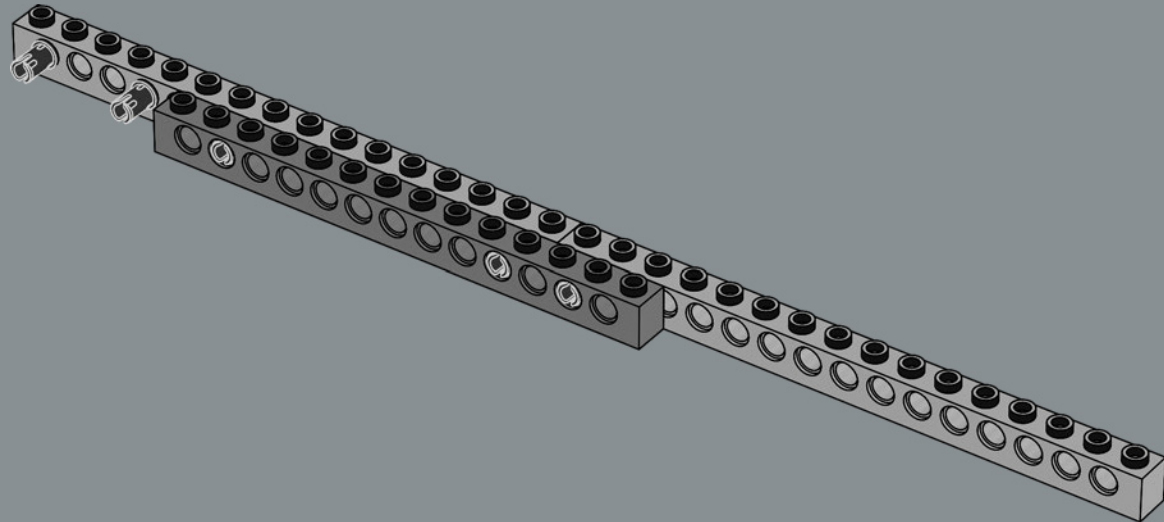

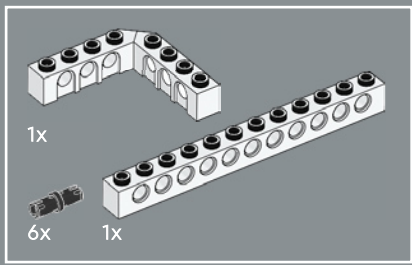

71

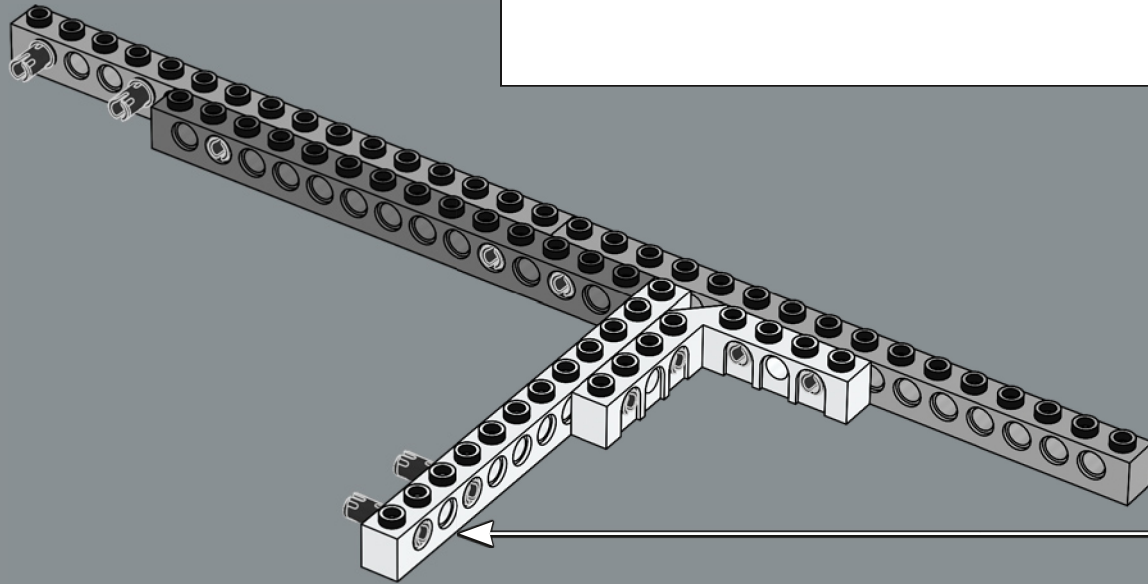
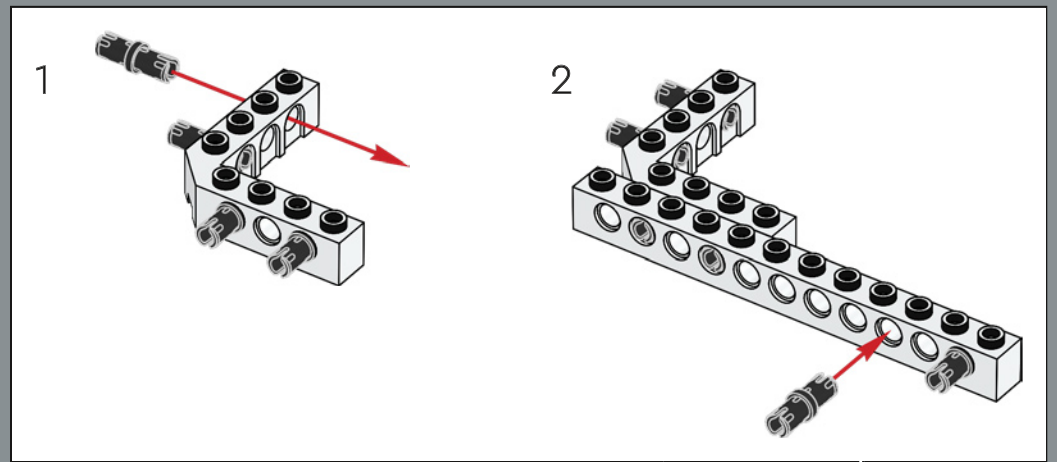

72

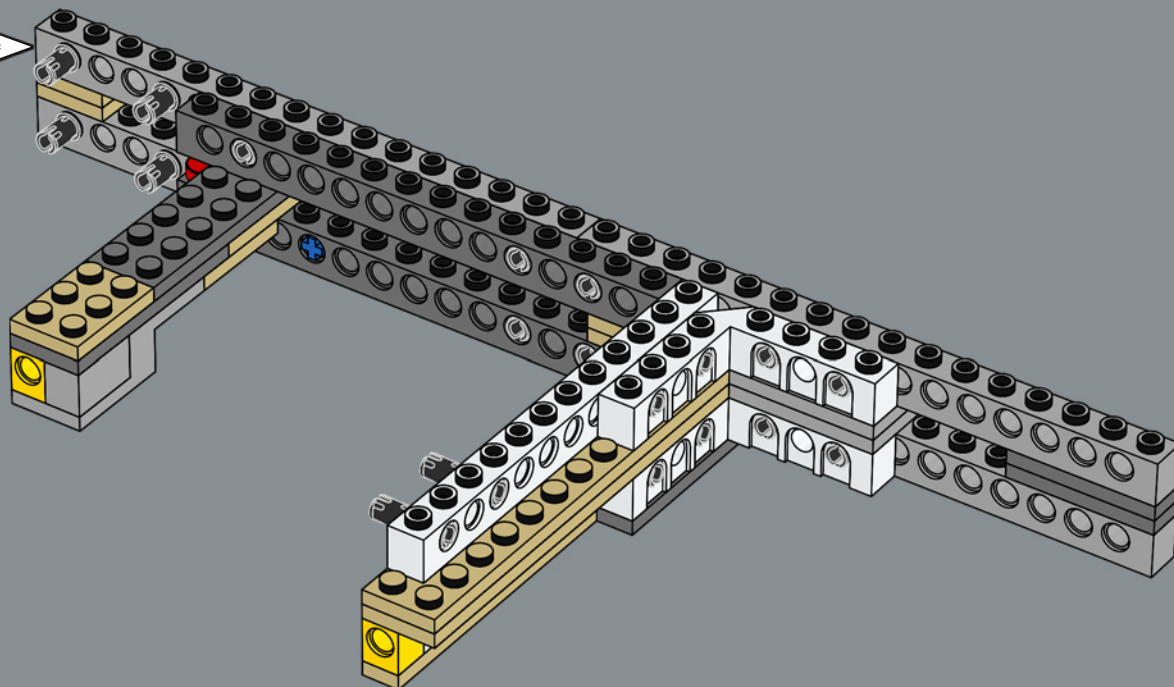

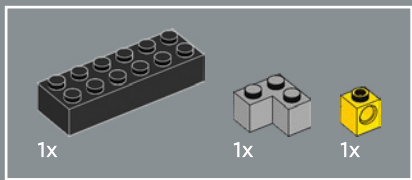

73

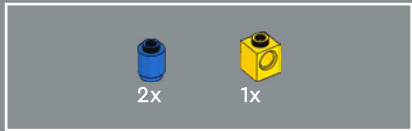
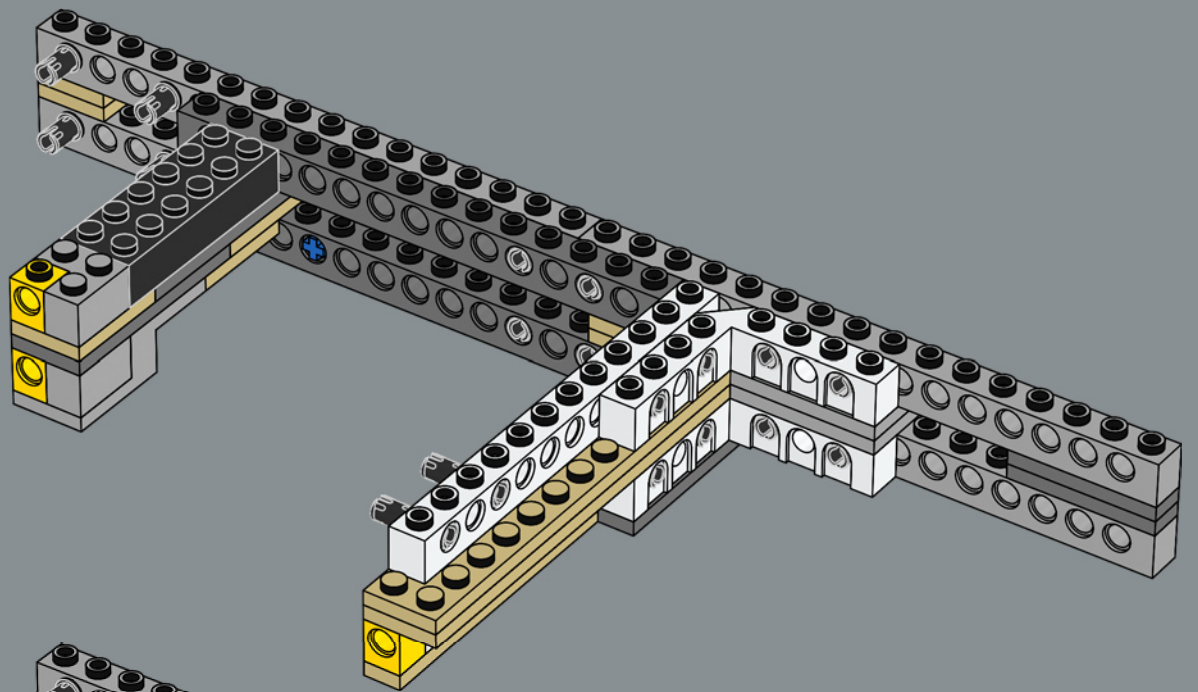

74

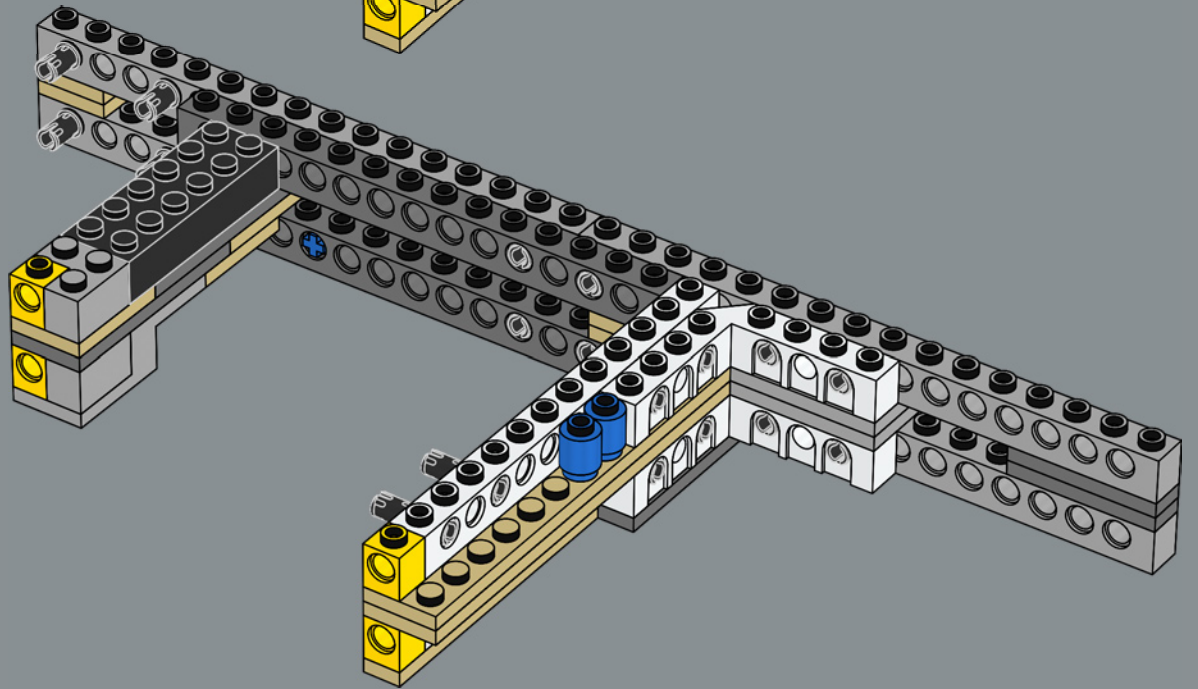

75

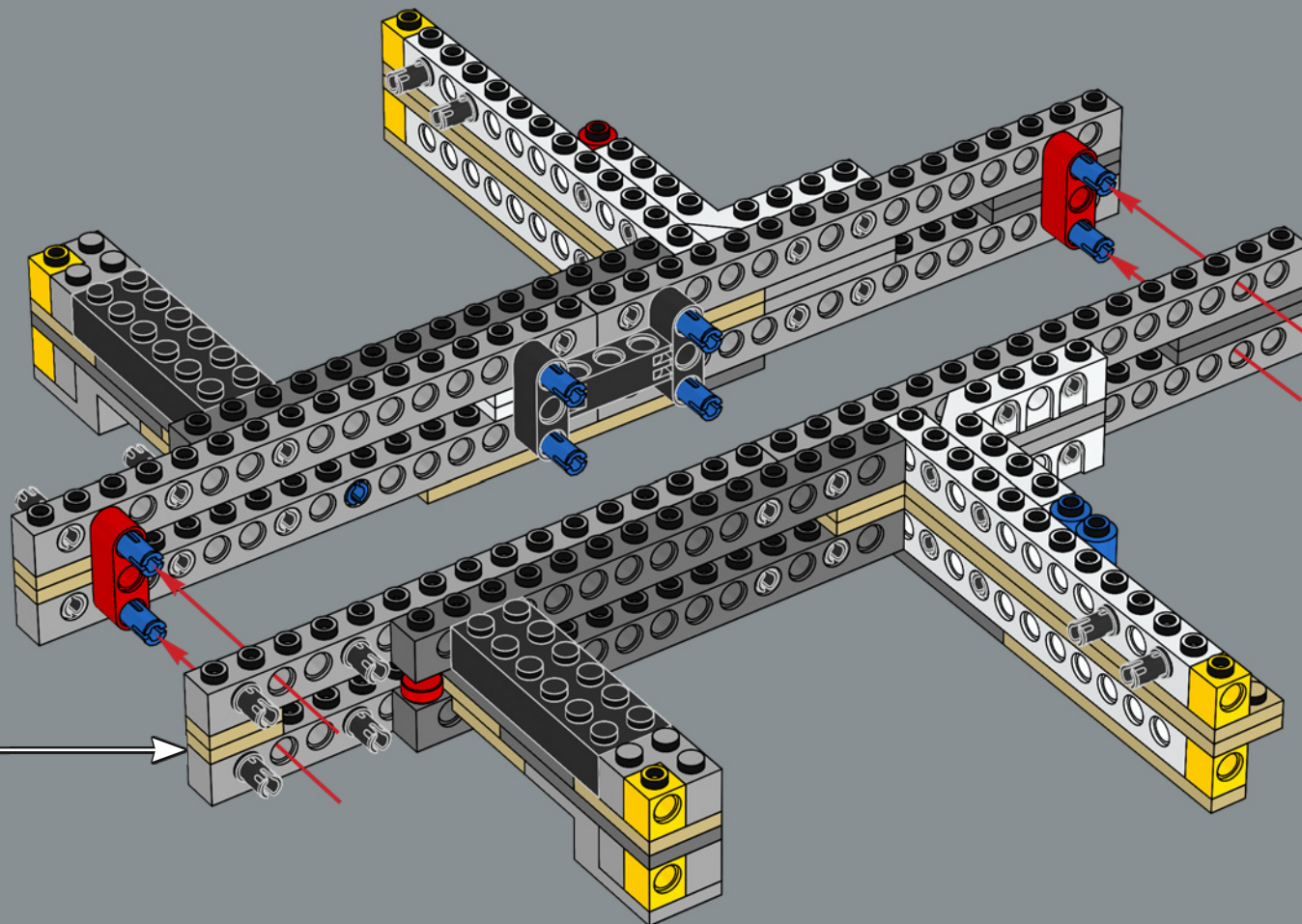

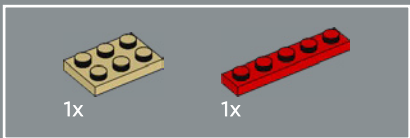

76

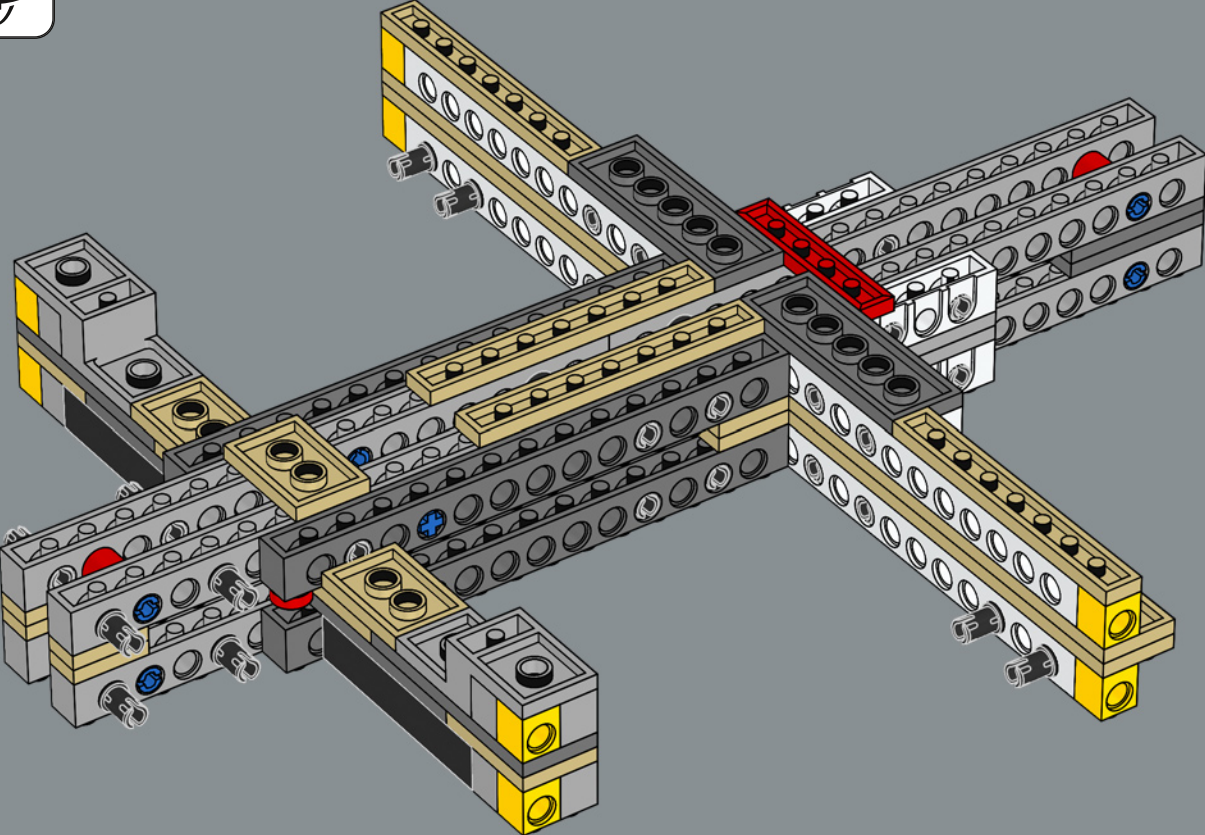

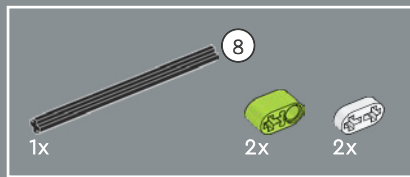

77

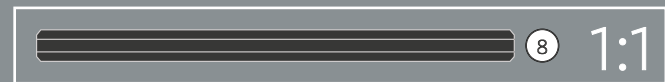
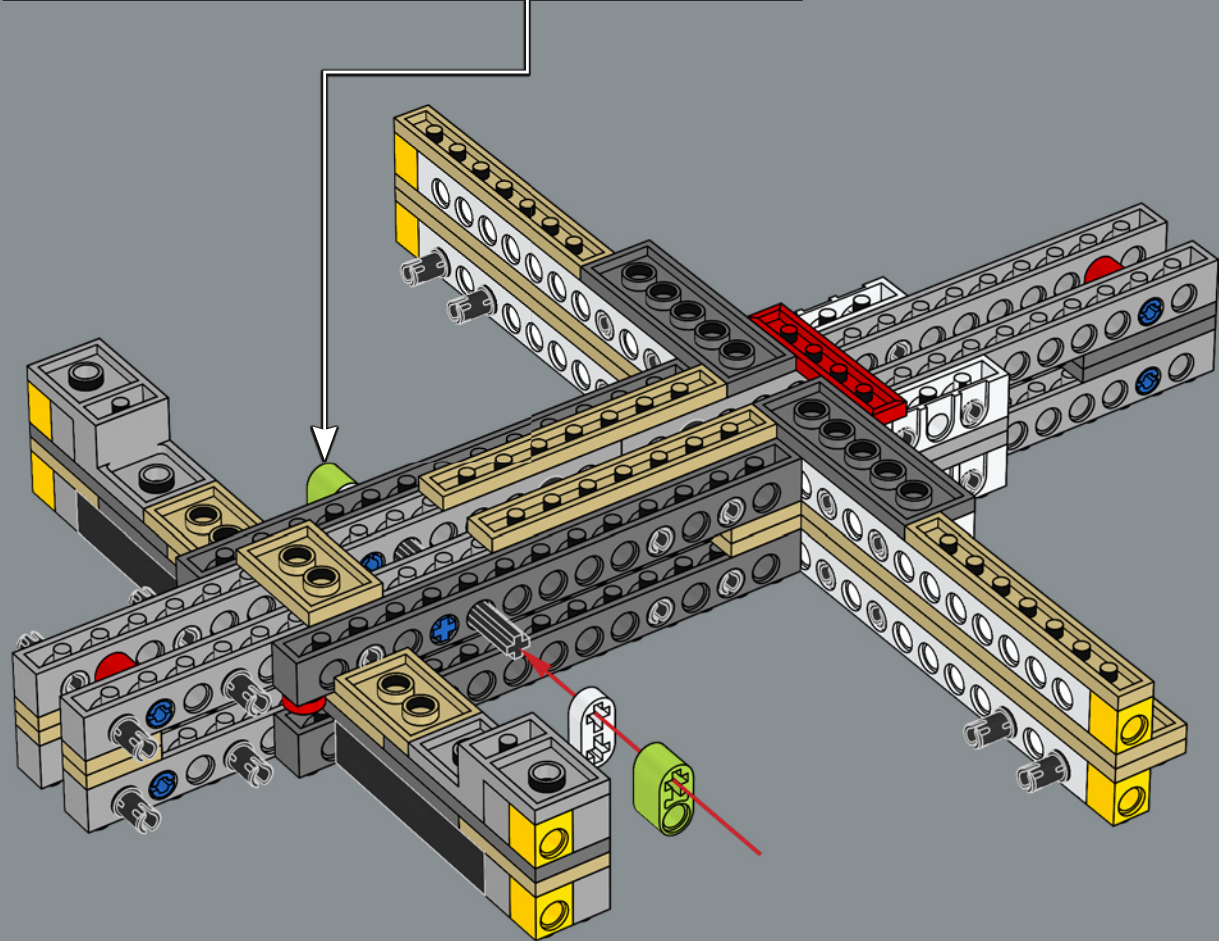
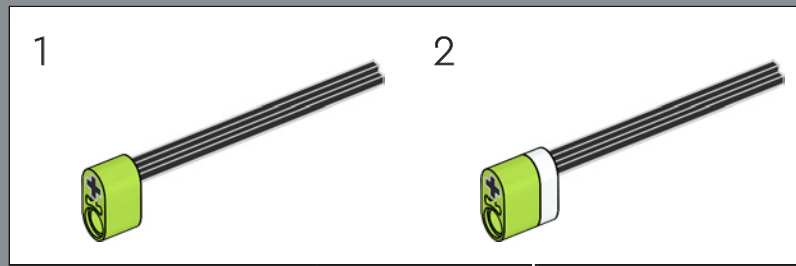

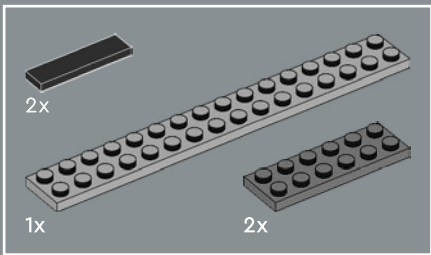

78

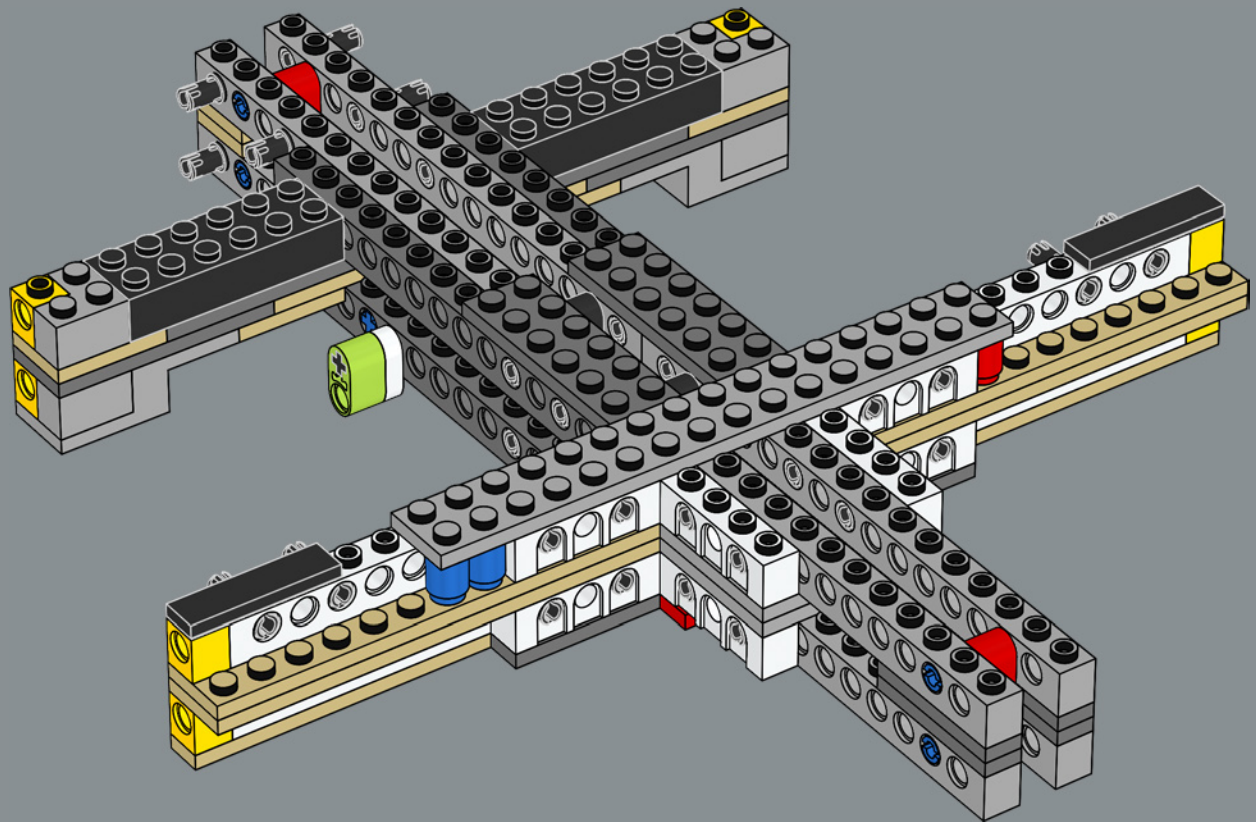



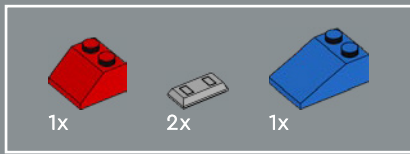

79

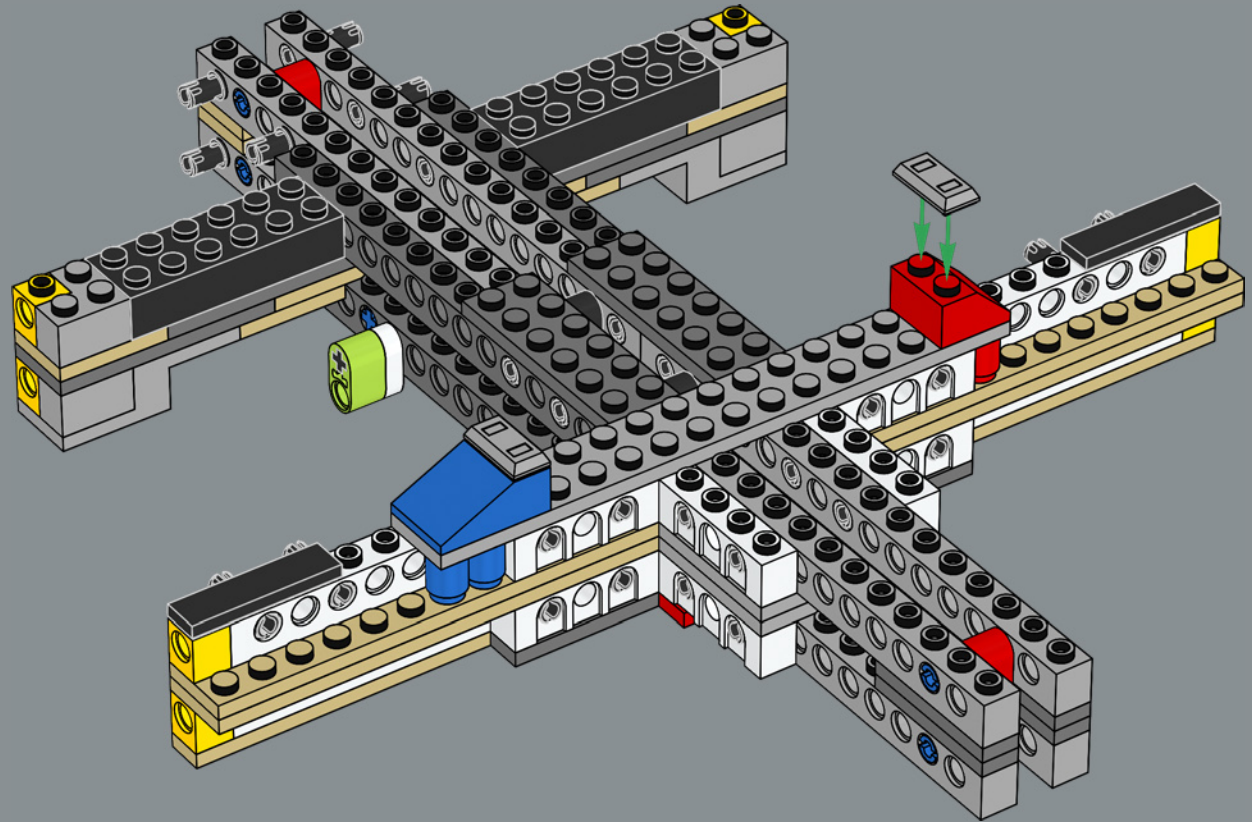

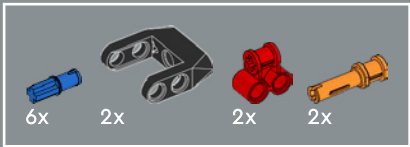

80

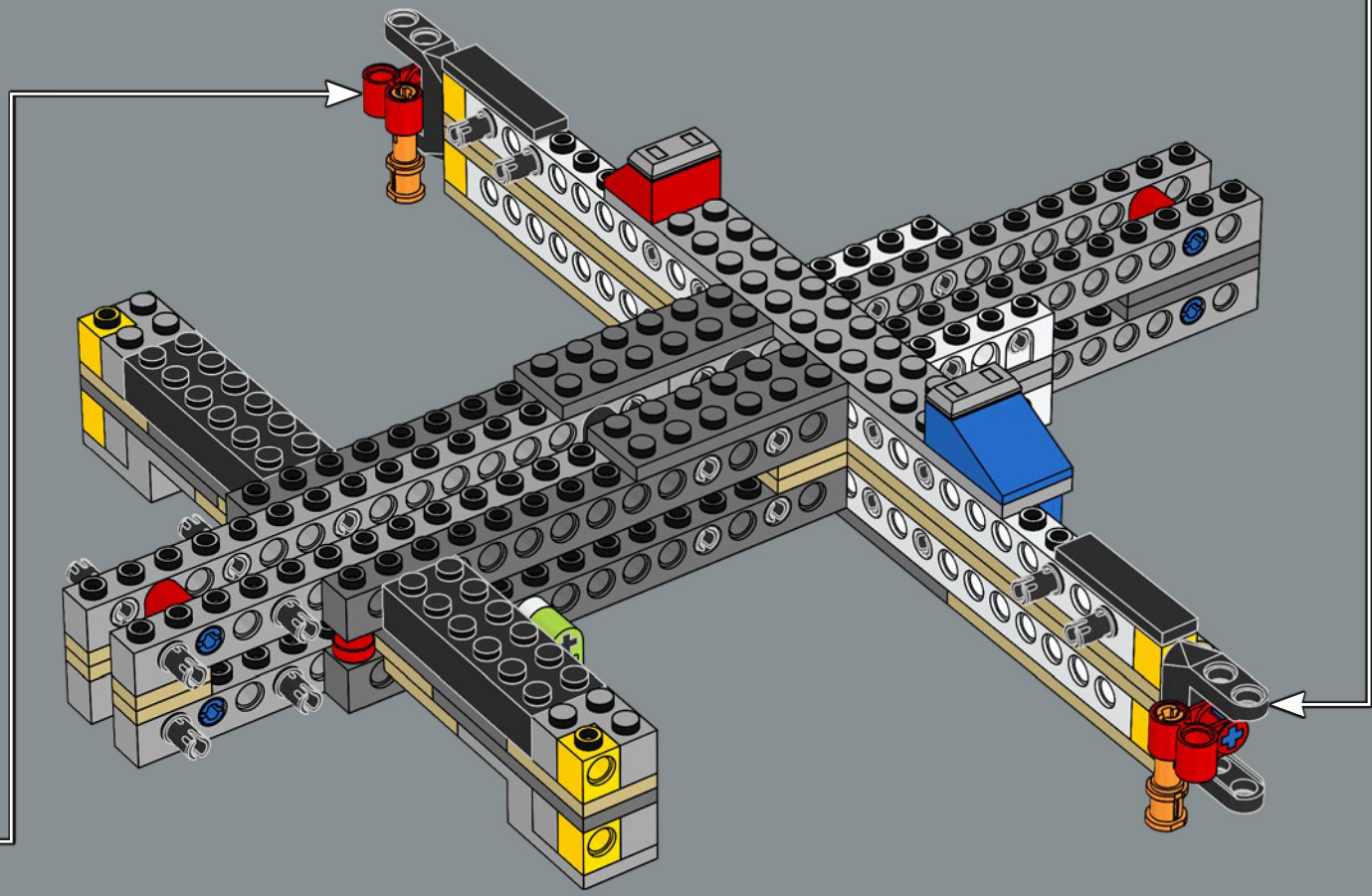
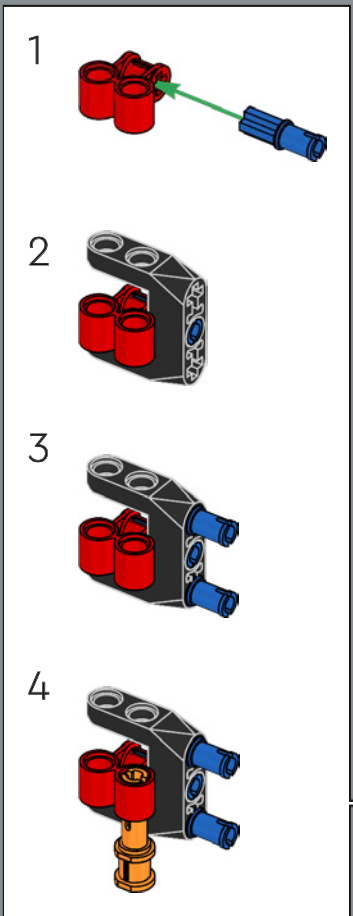
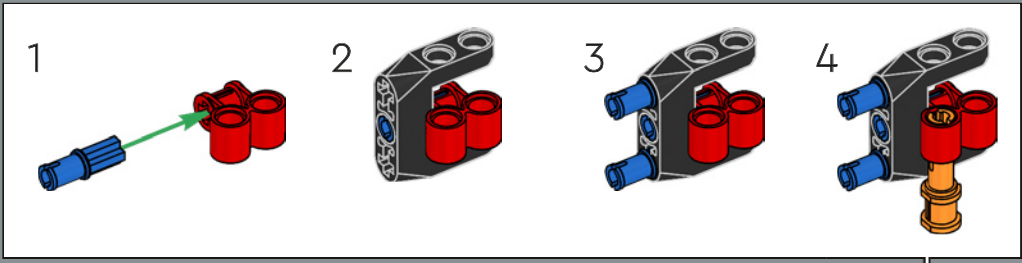

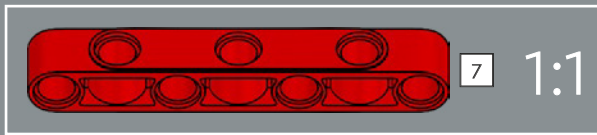
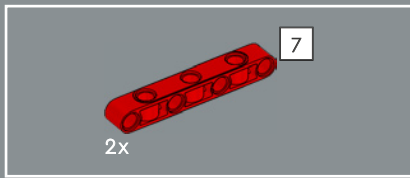

81

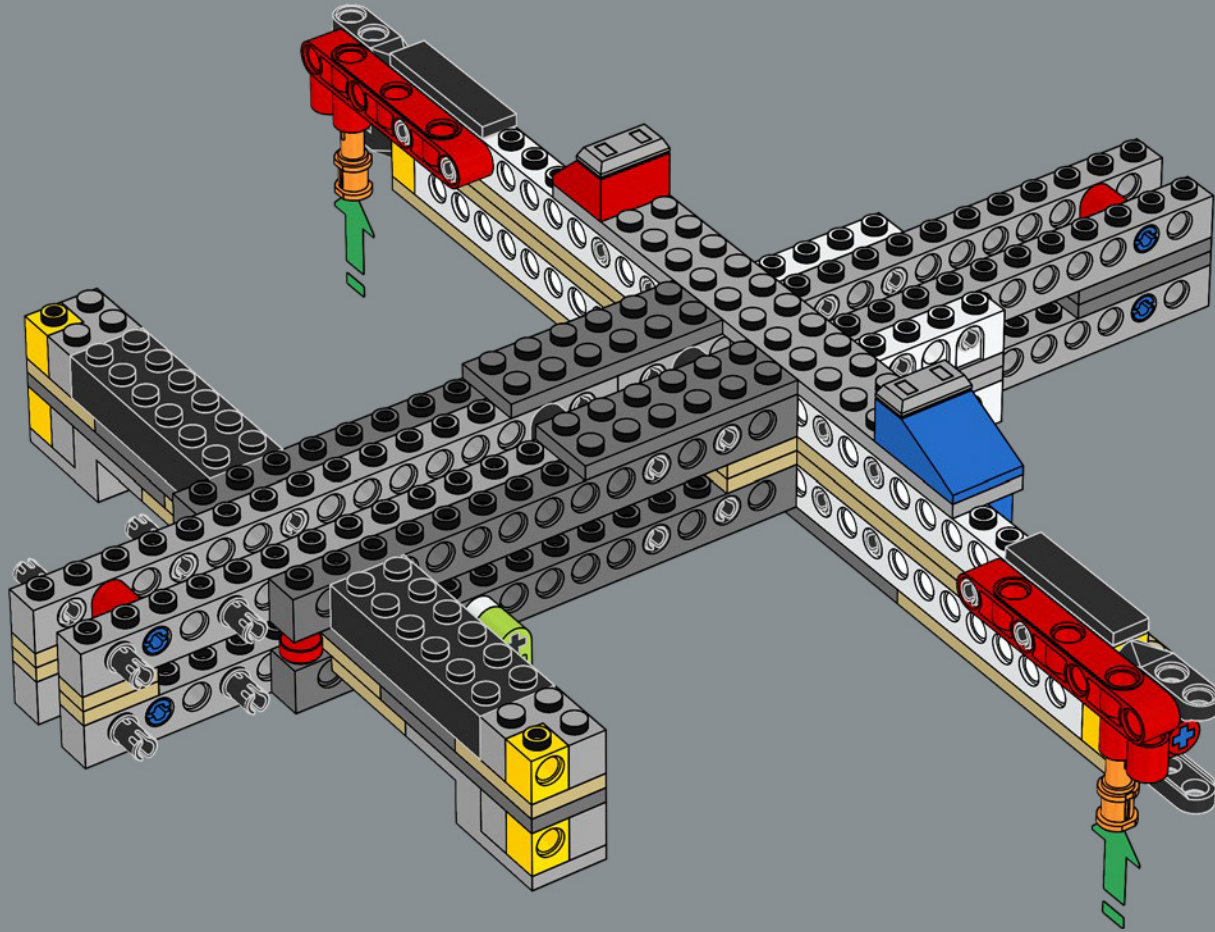

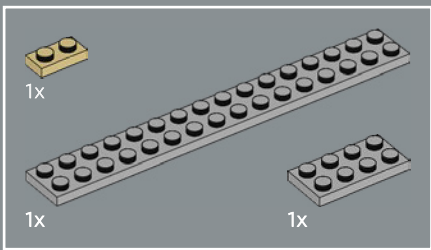

82

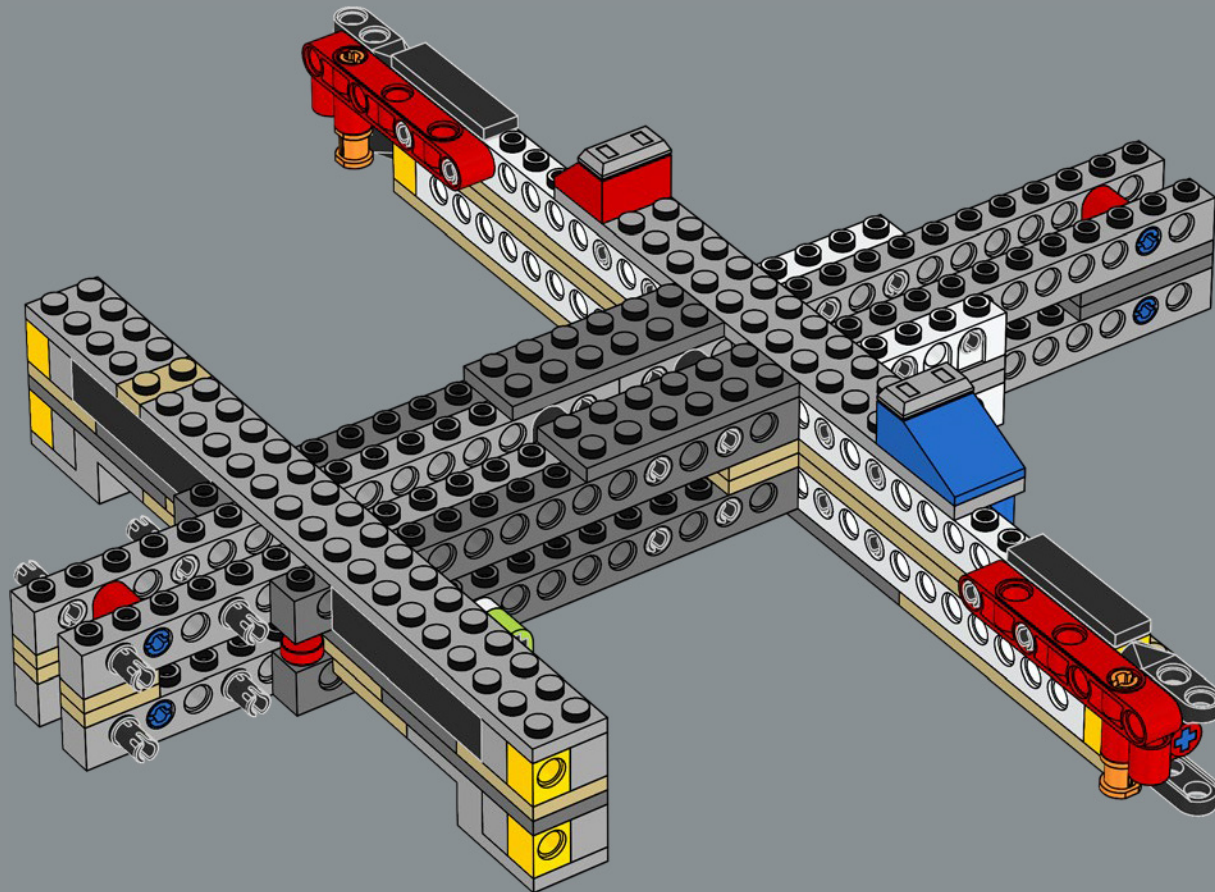

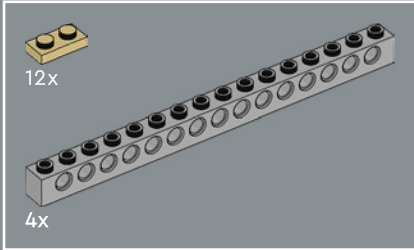
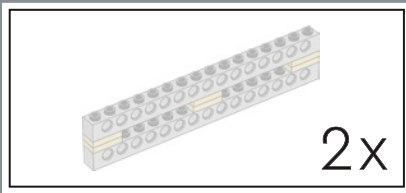

83

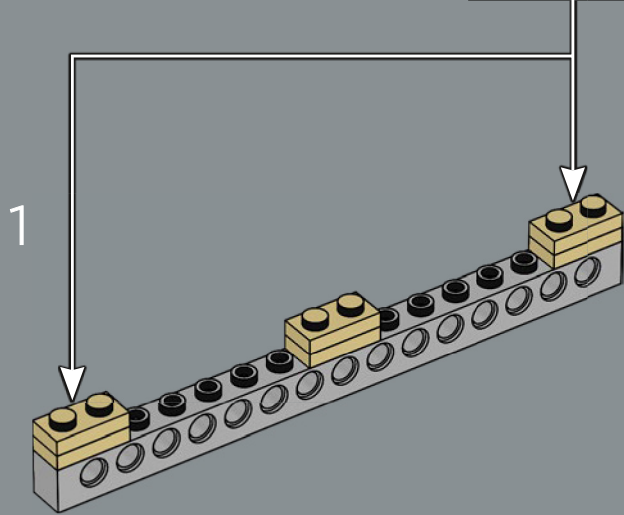
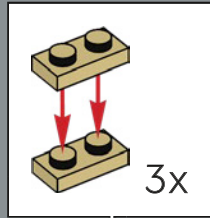

2

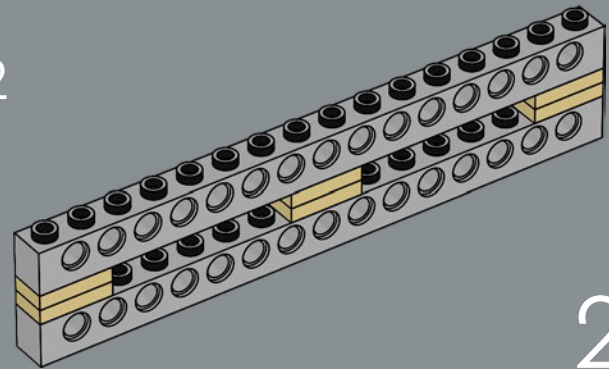

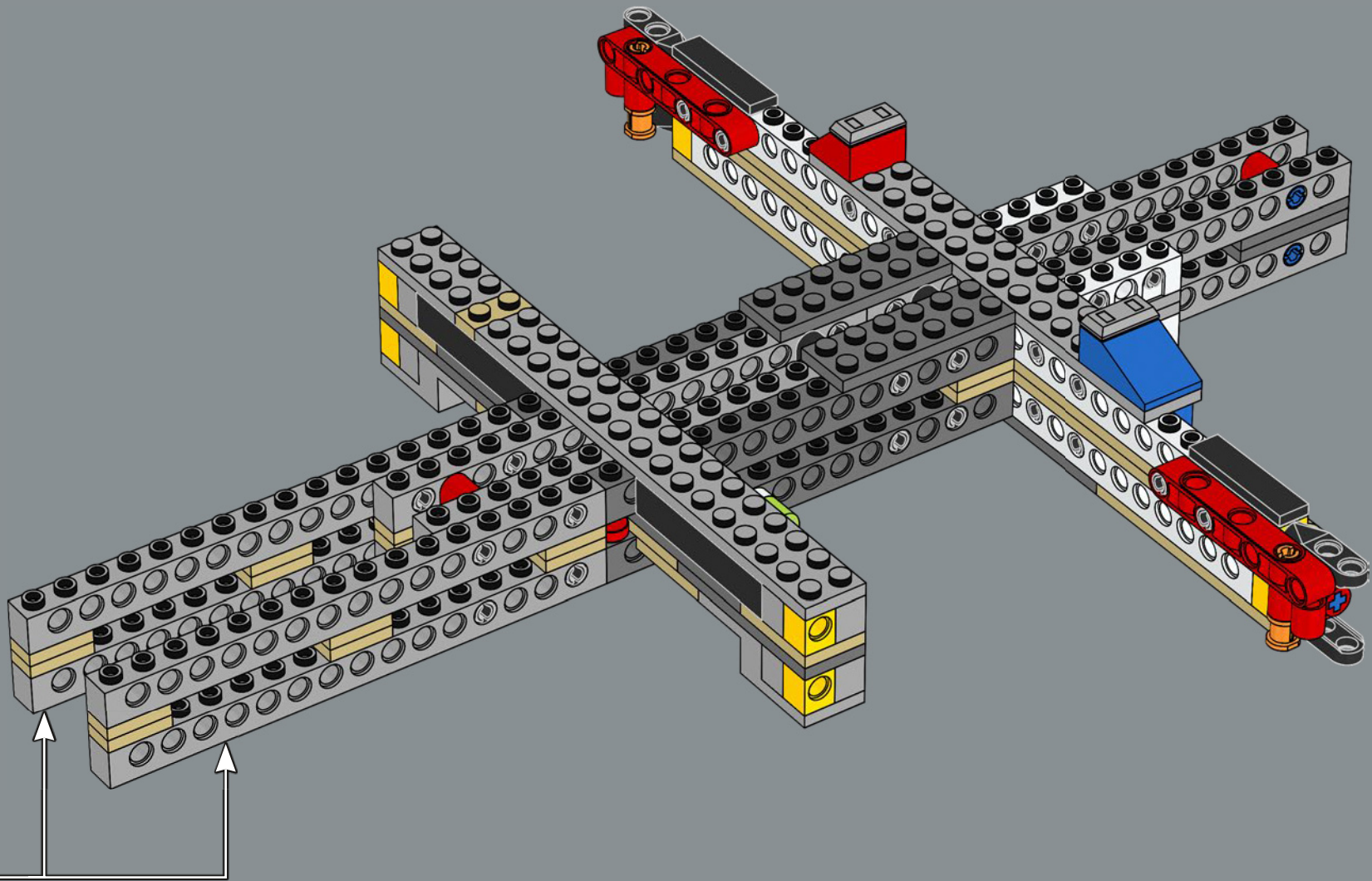



84

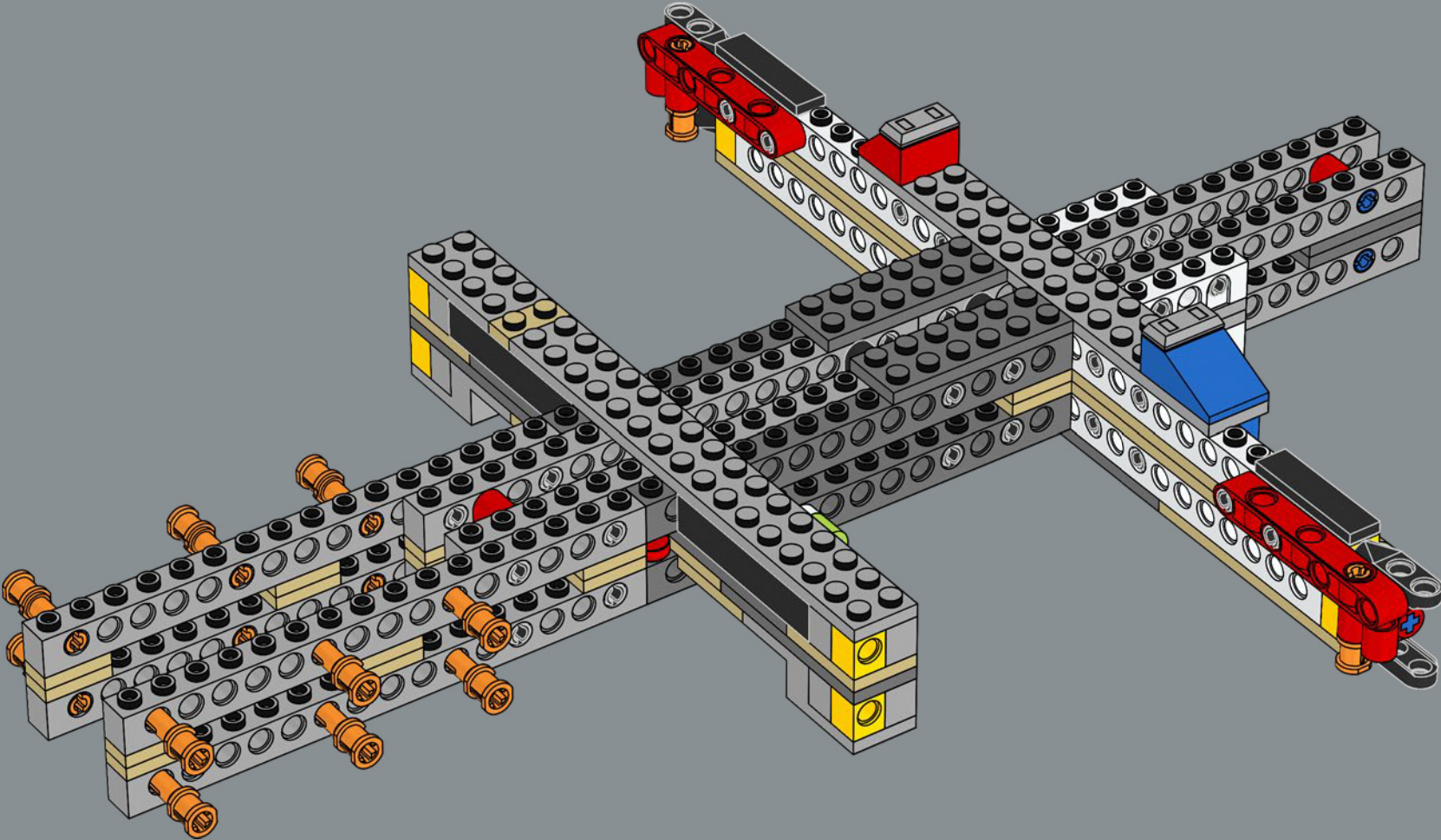

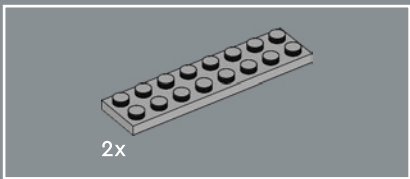

85

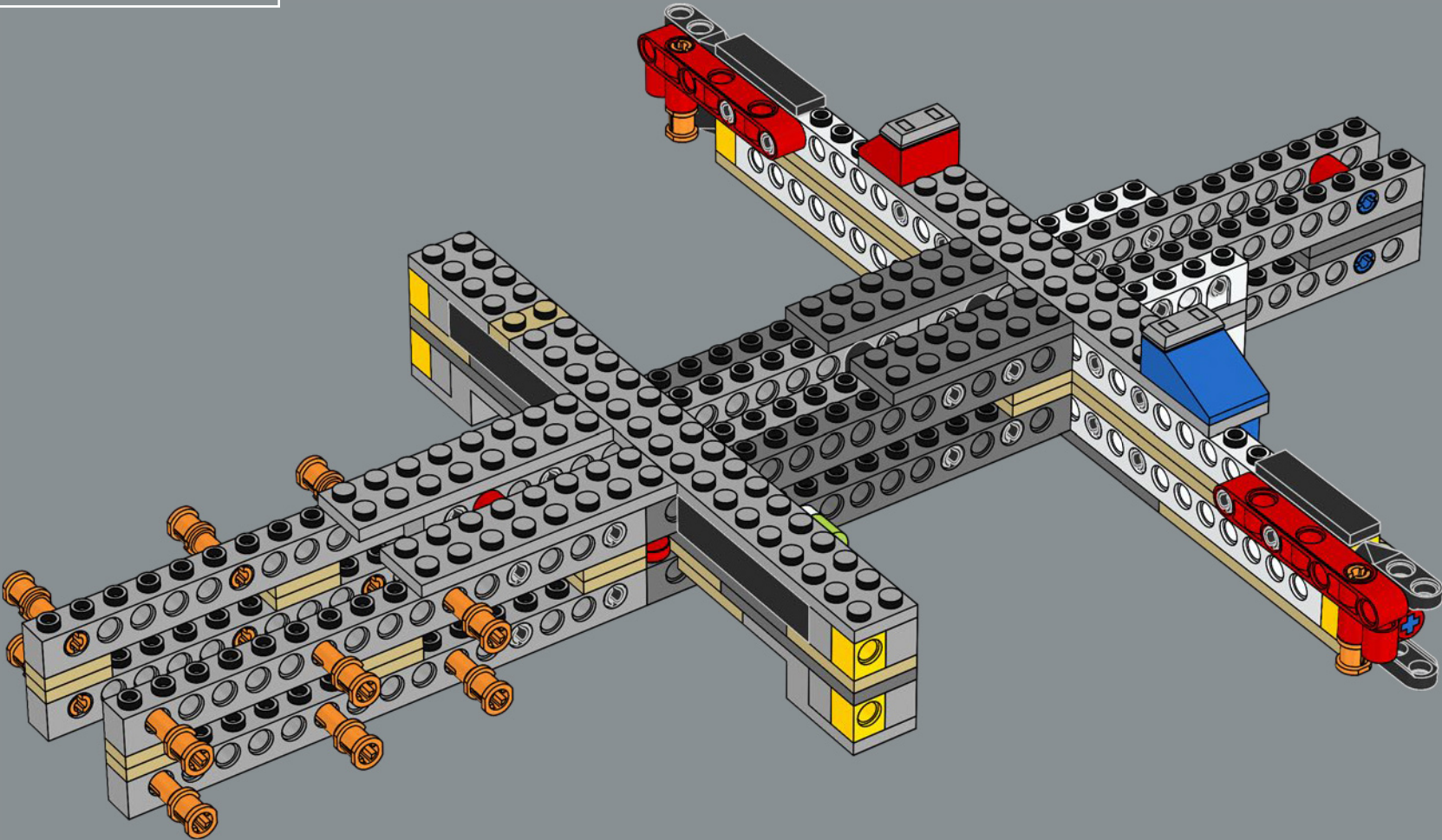



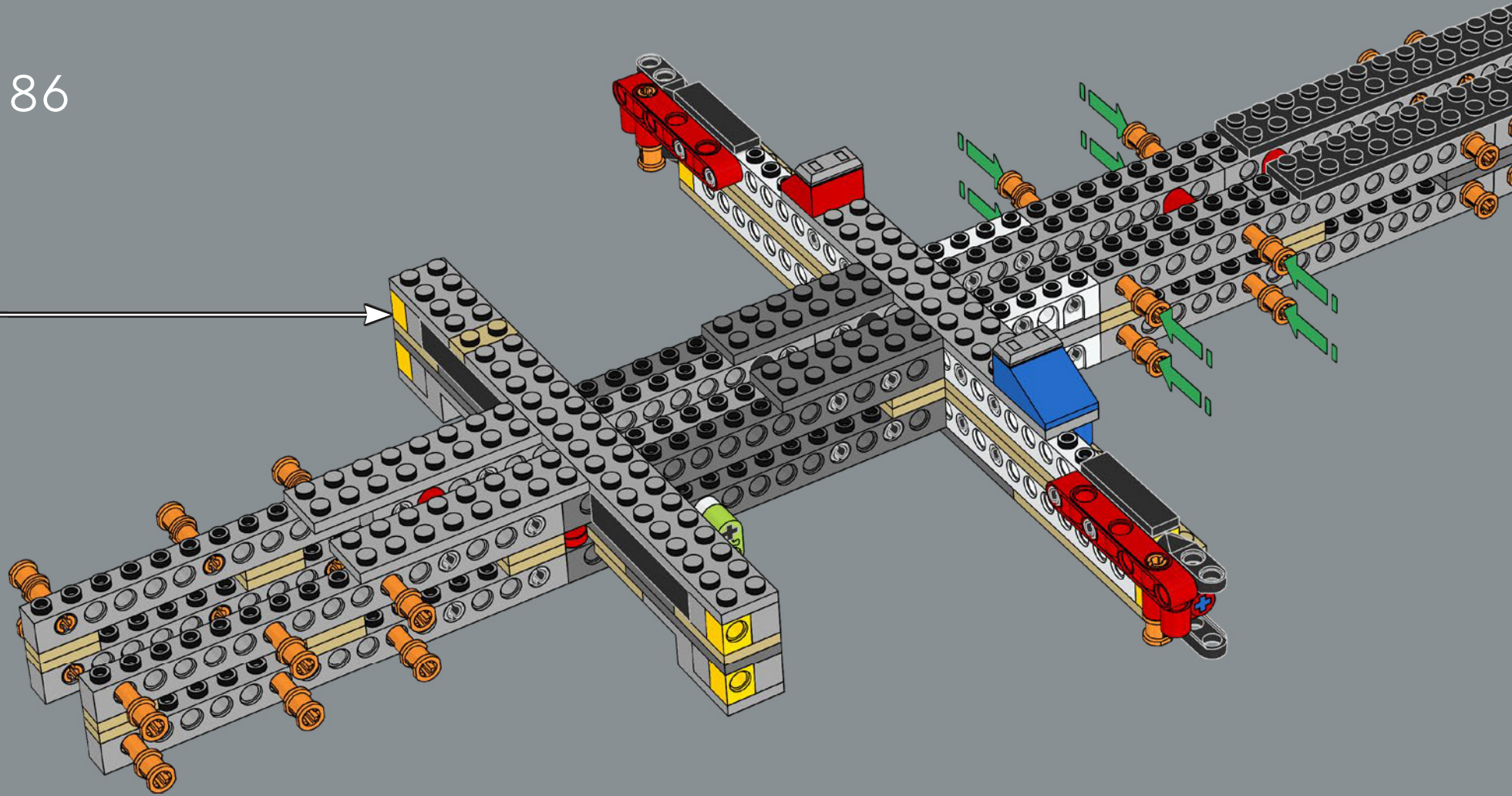

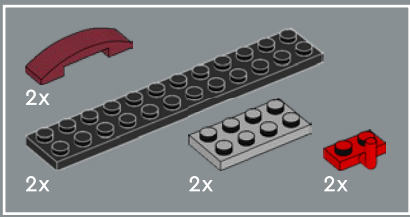

87

1

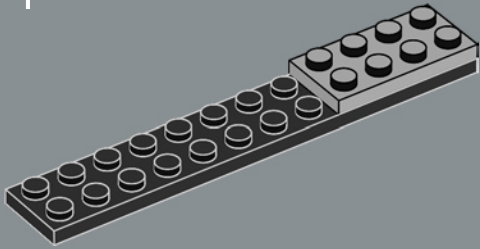

2

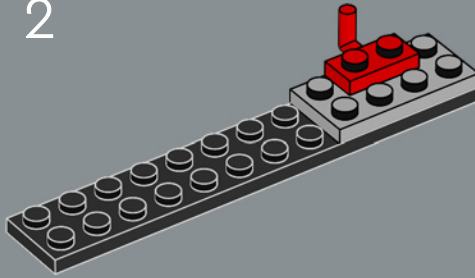

3

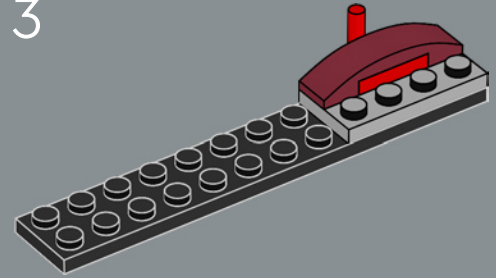

1

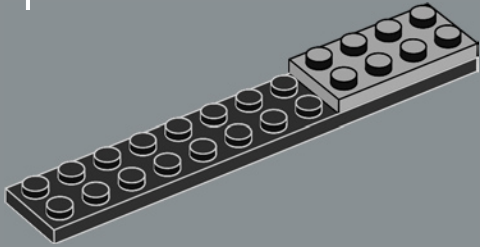

2

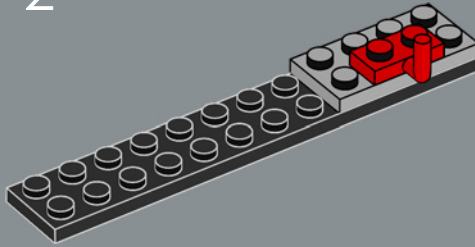

3

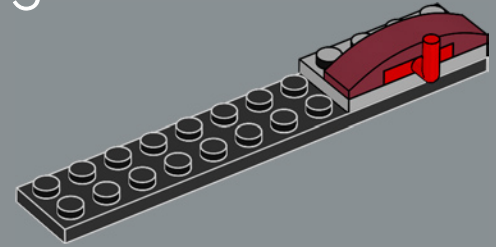

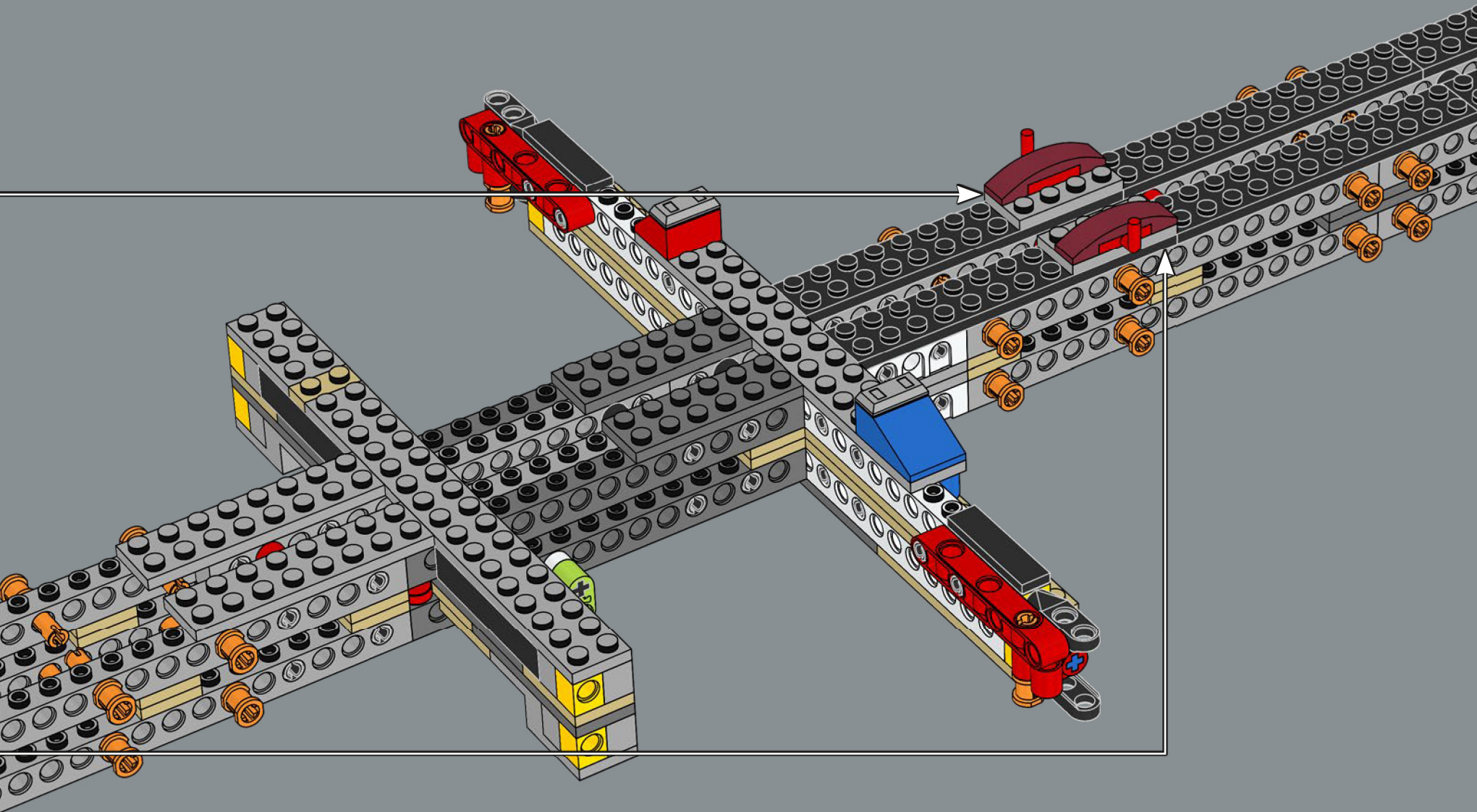

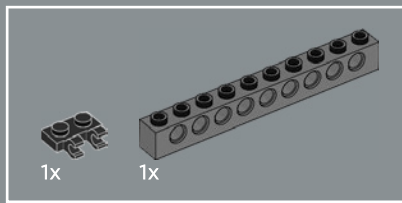
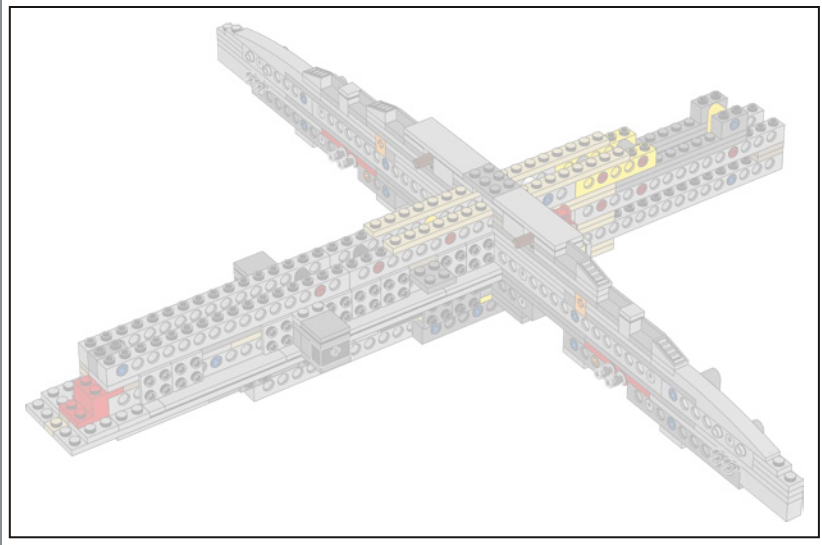

88

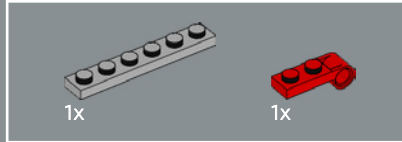
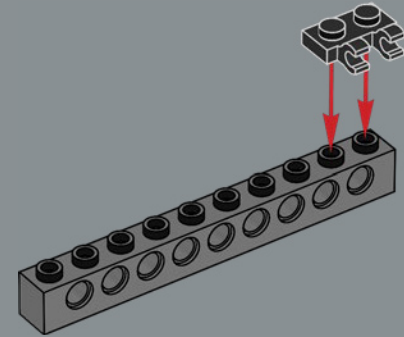

89

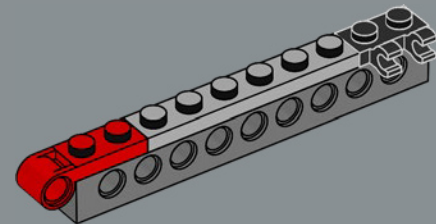

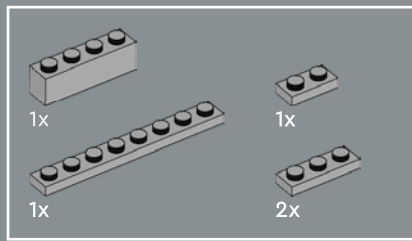

90

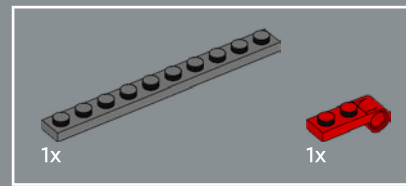
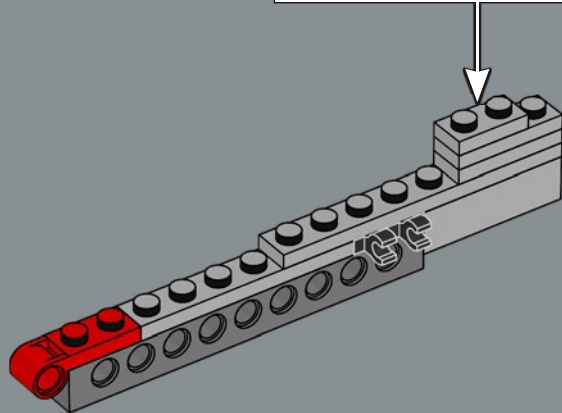
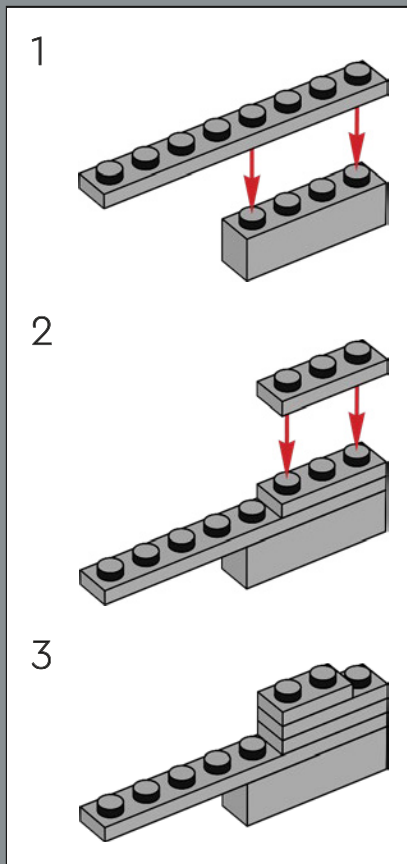

91

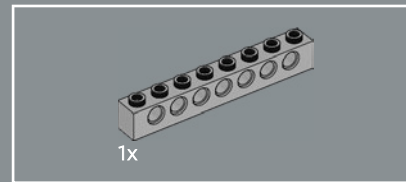
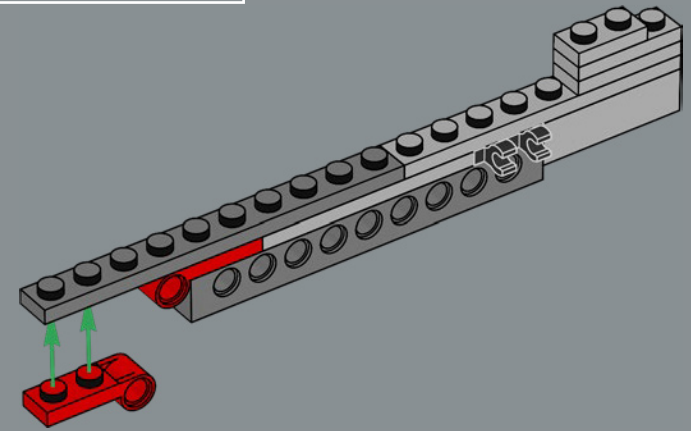

92

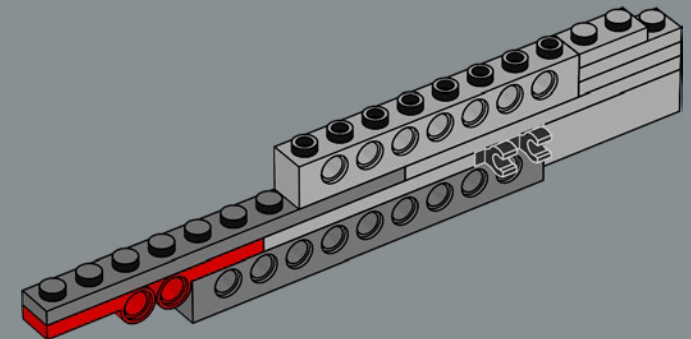

2x

93

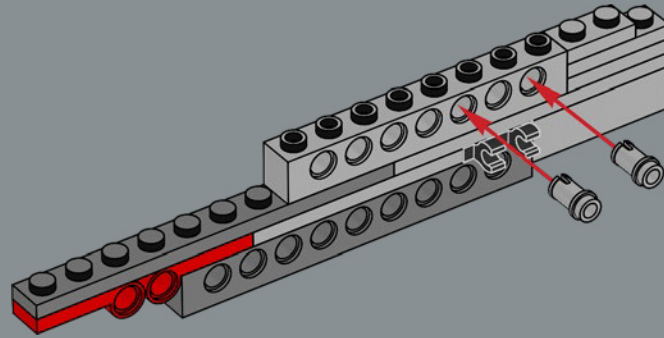

1x

94

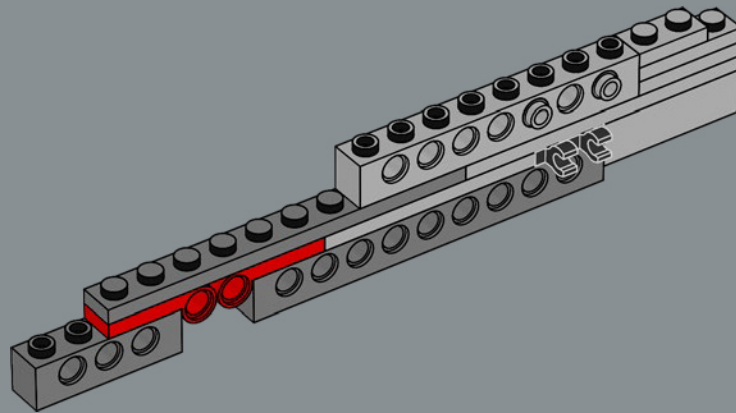

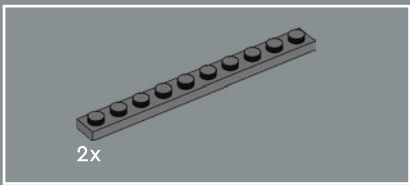

95

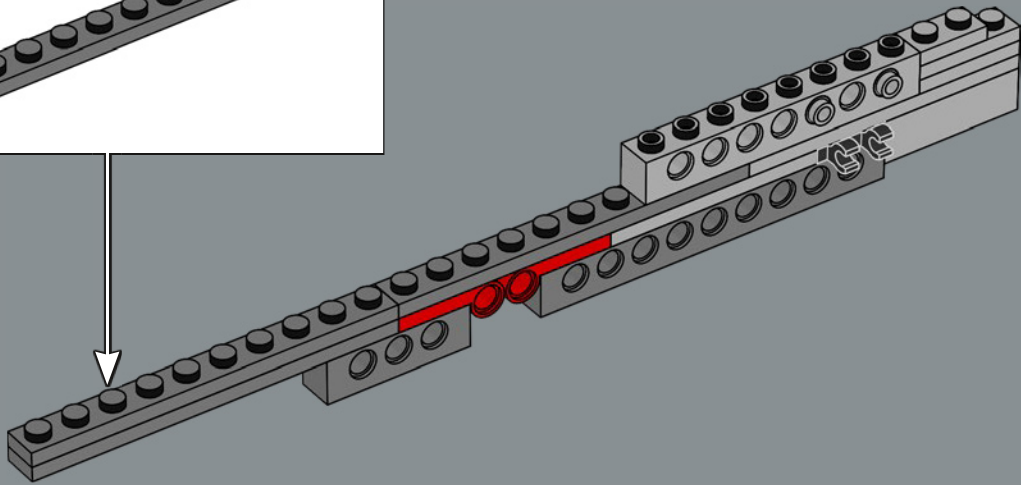
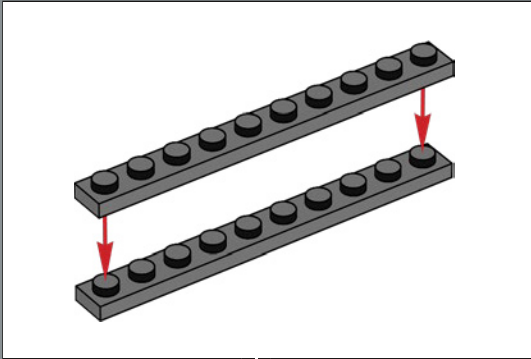







97

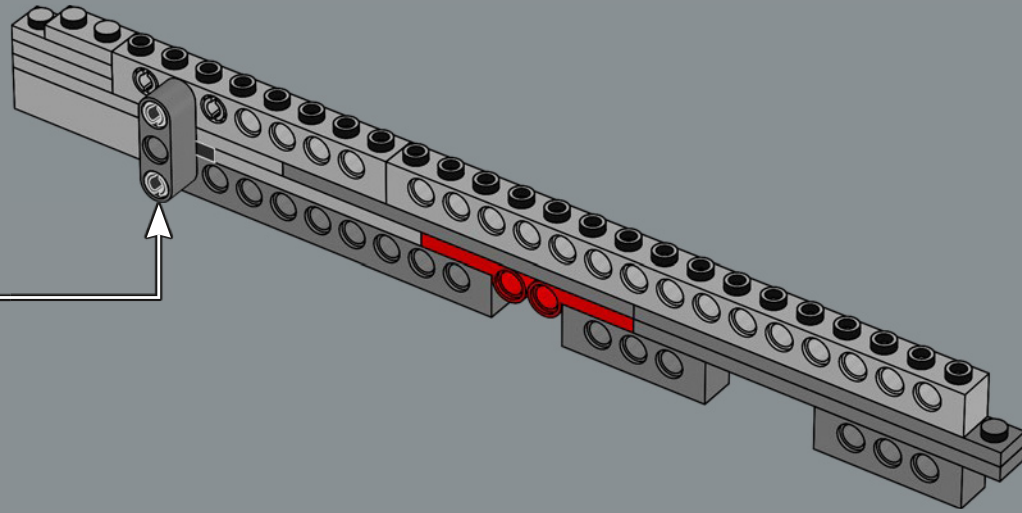
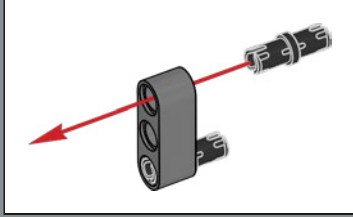

98

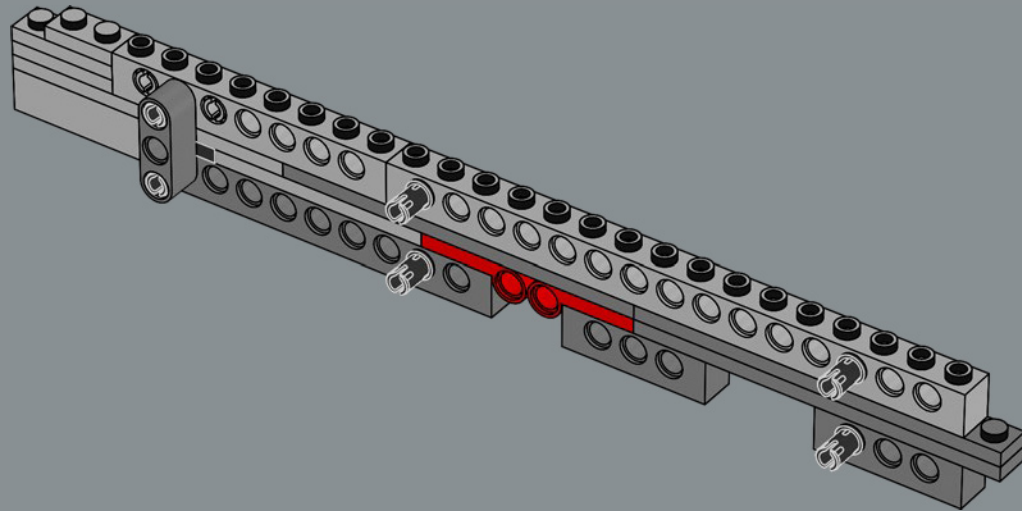

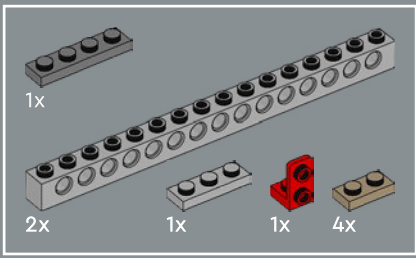

99

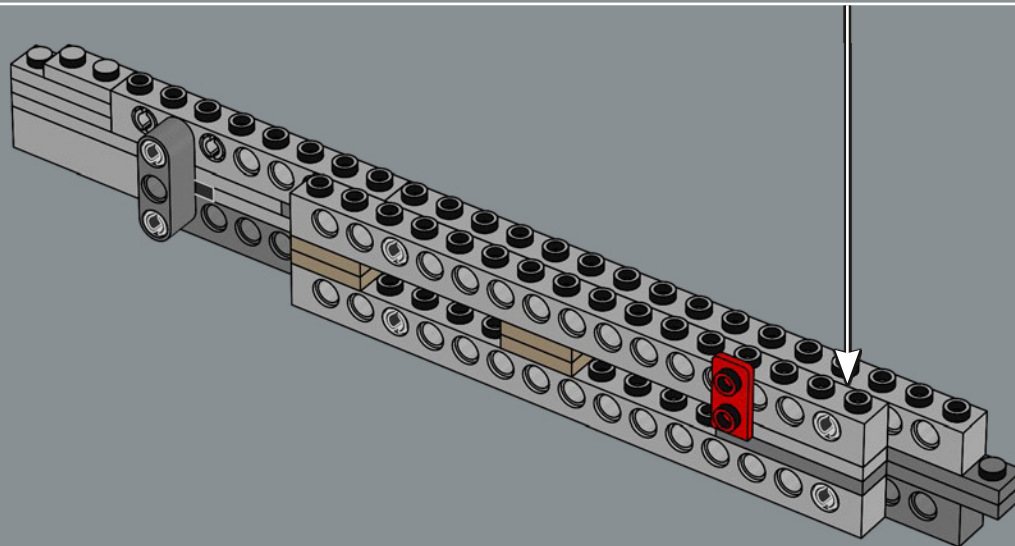
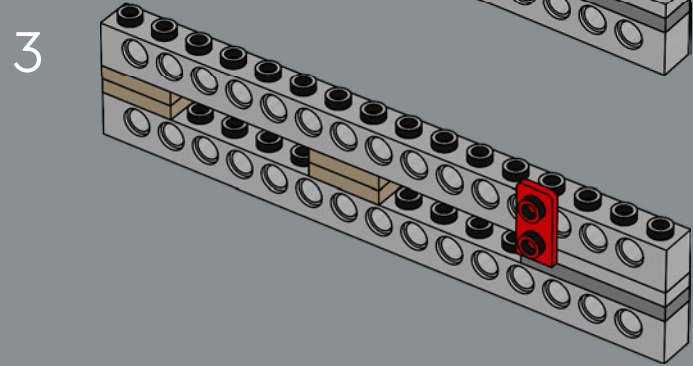
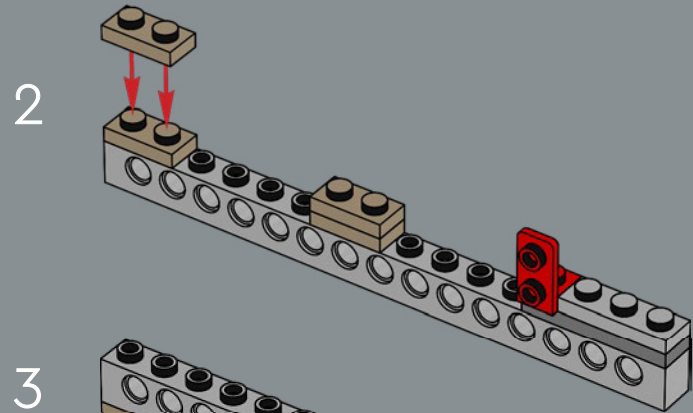
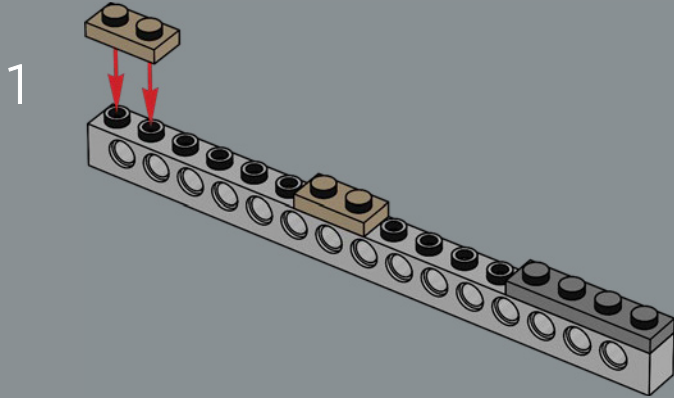

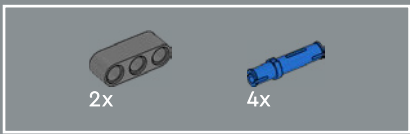

100

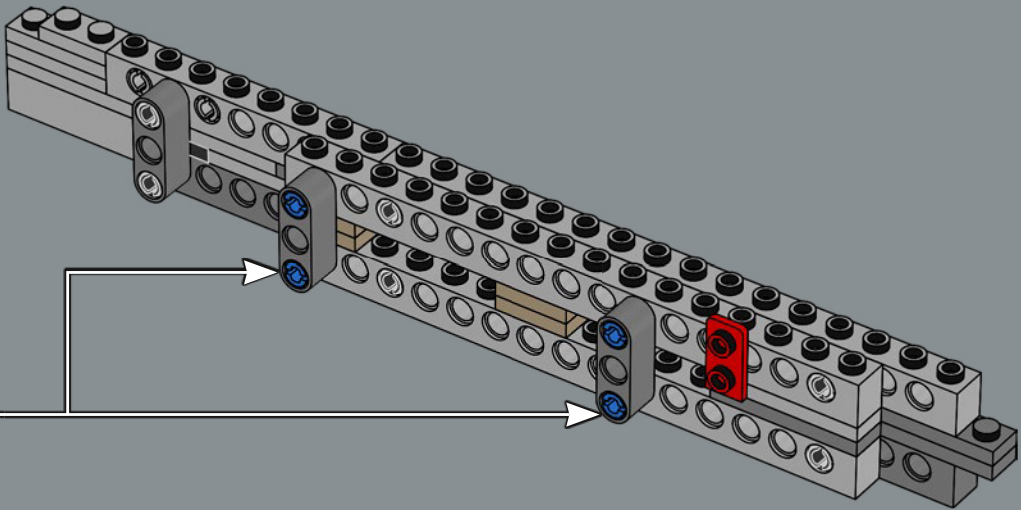
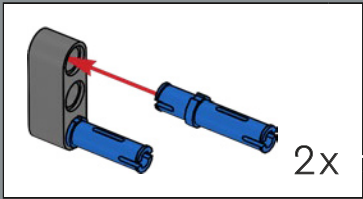



101

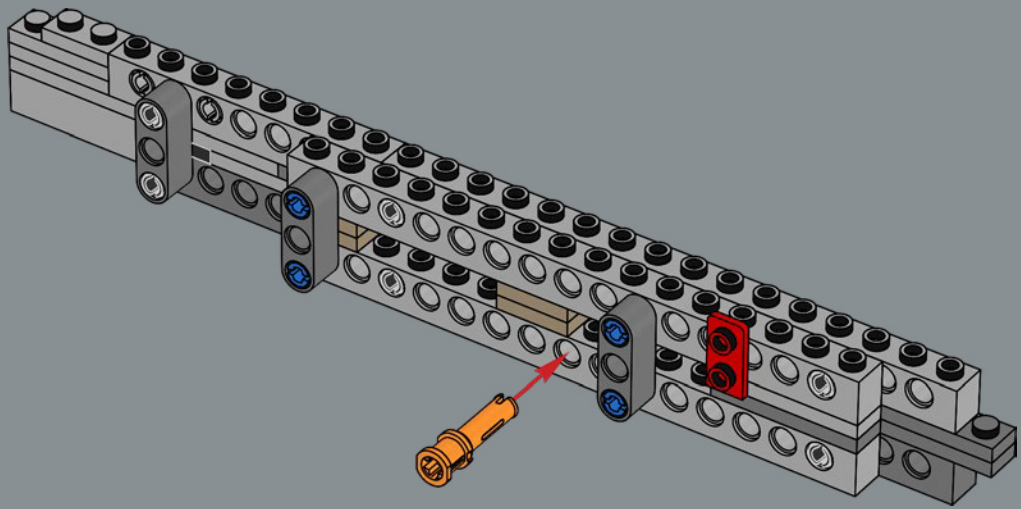

102

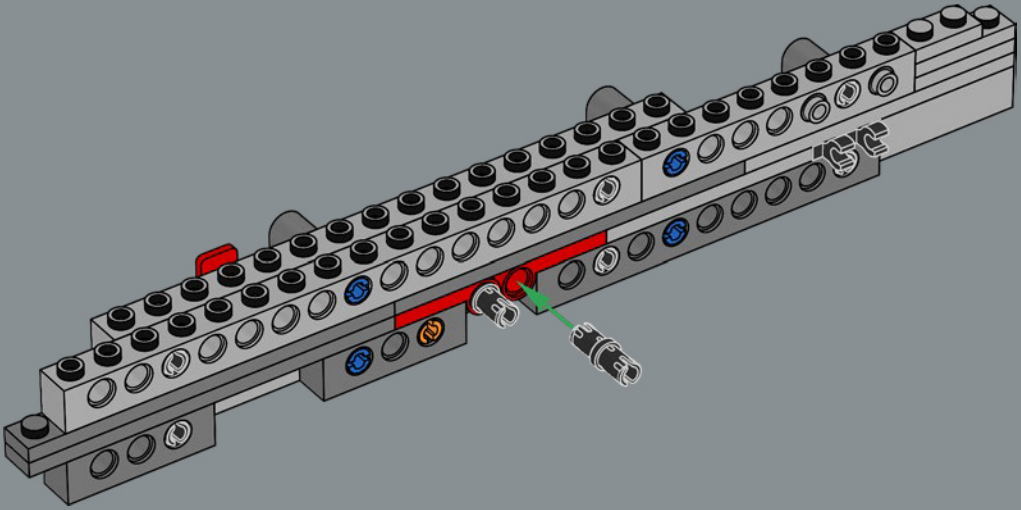

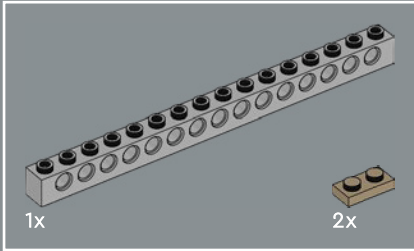
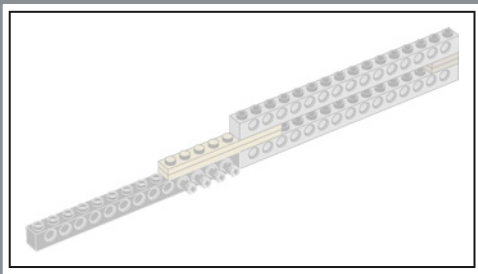

103

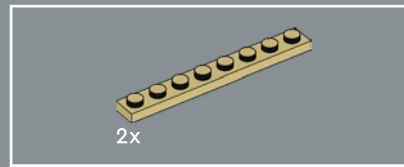
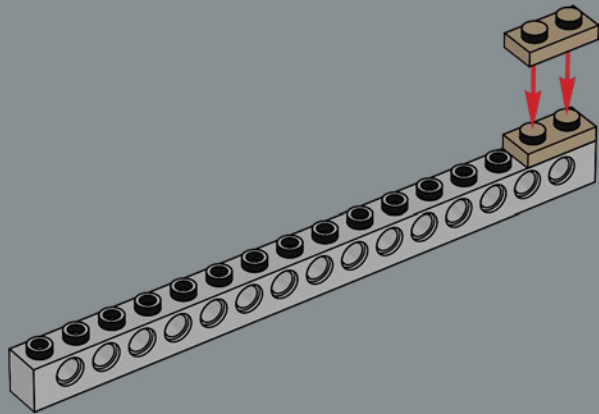

104

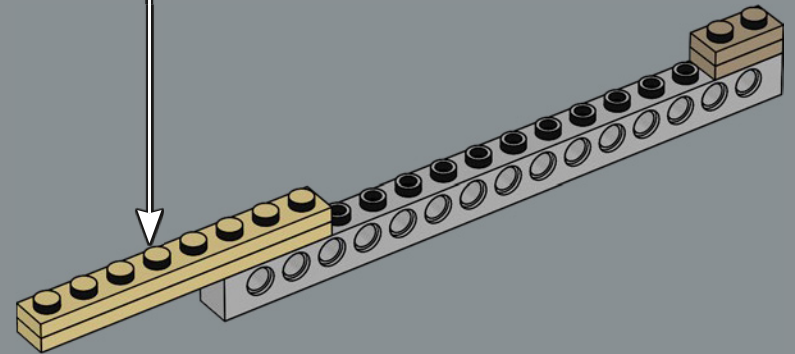
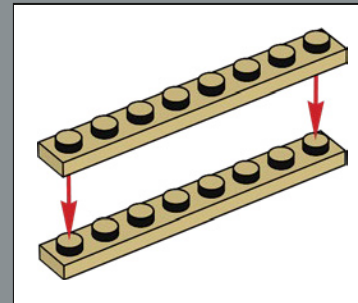

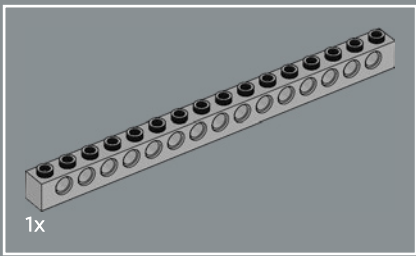

105

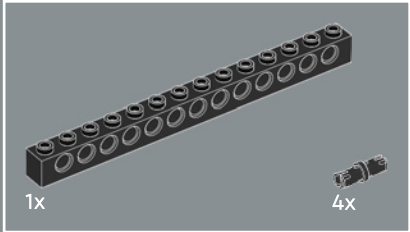
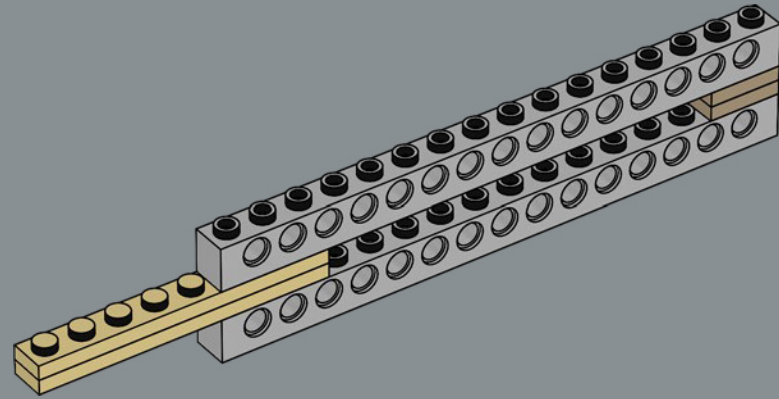

106

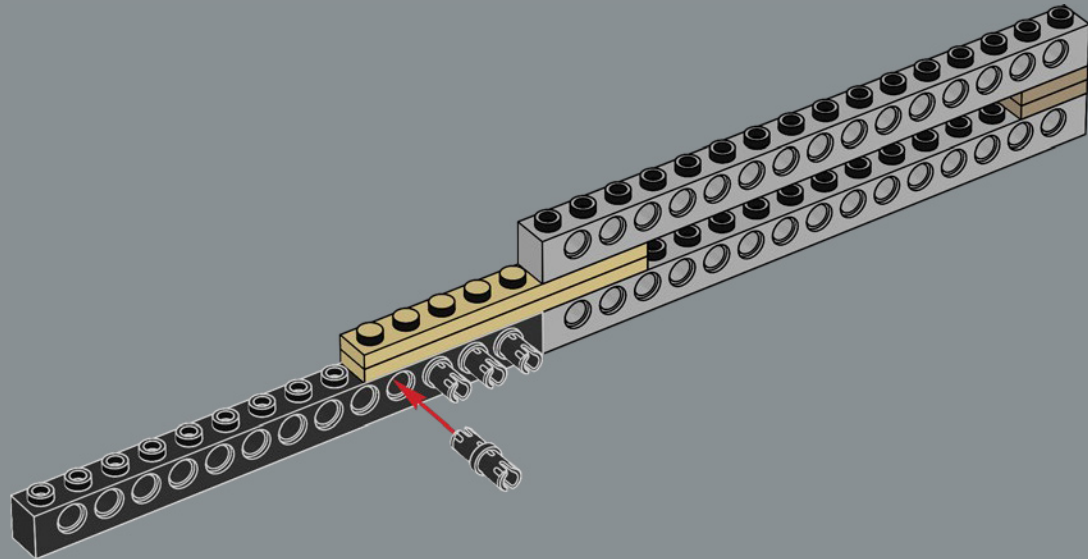

107

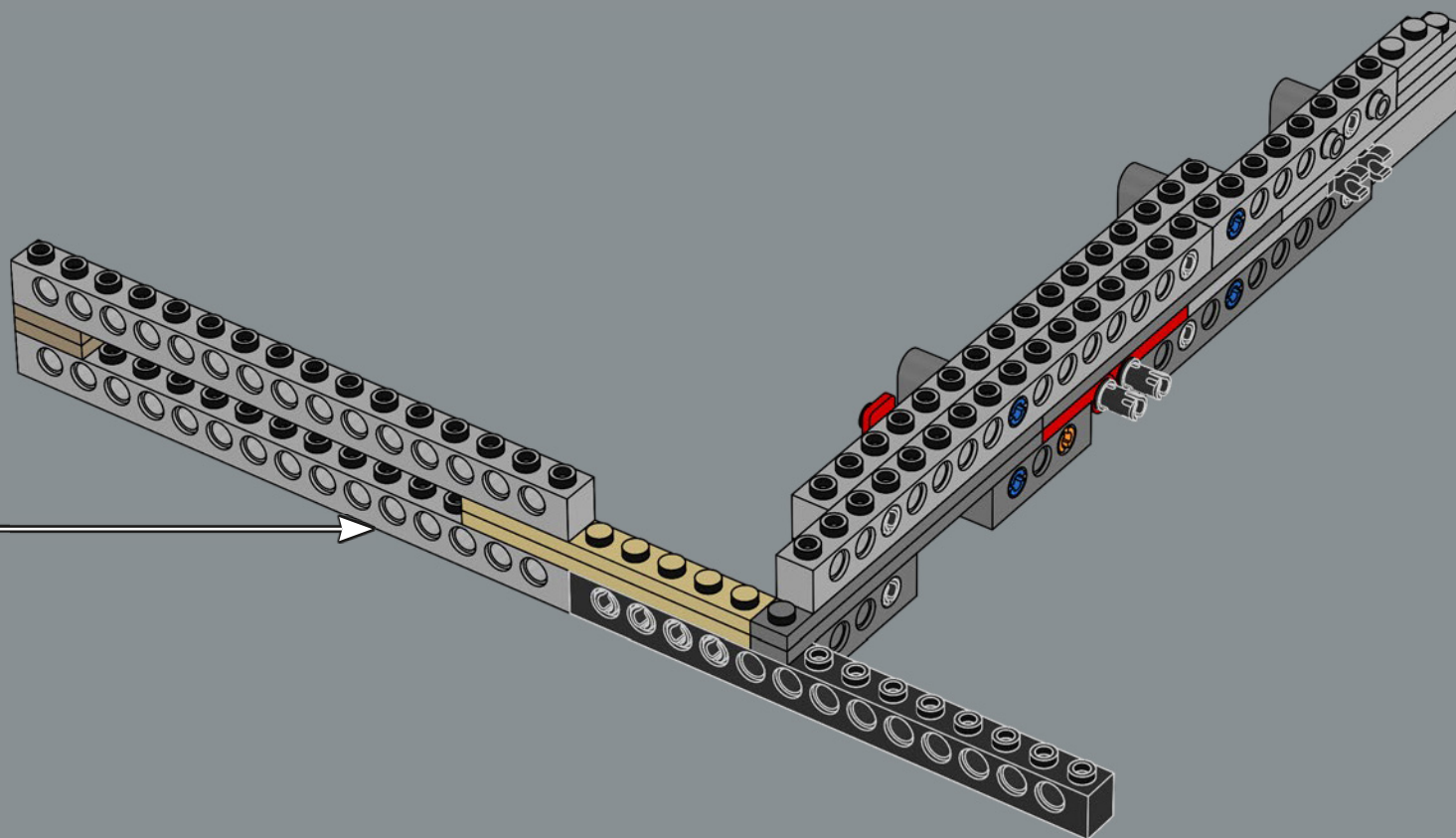

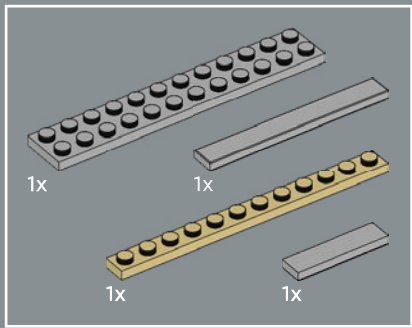

108

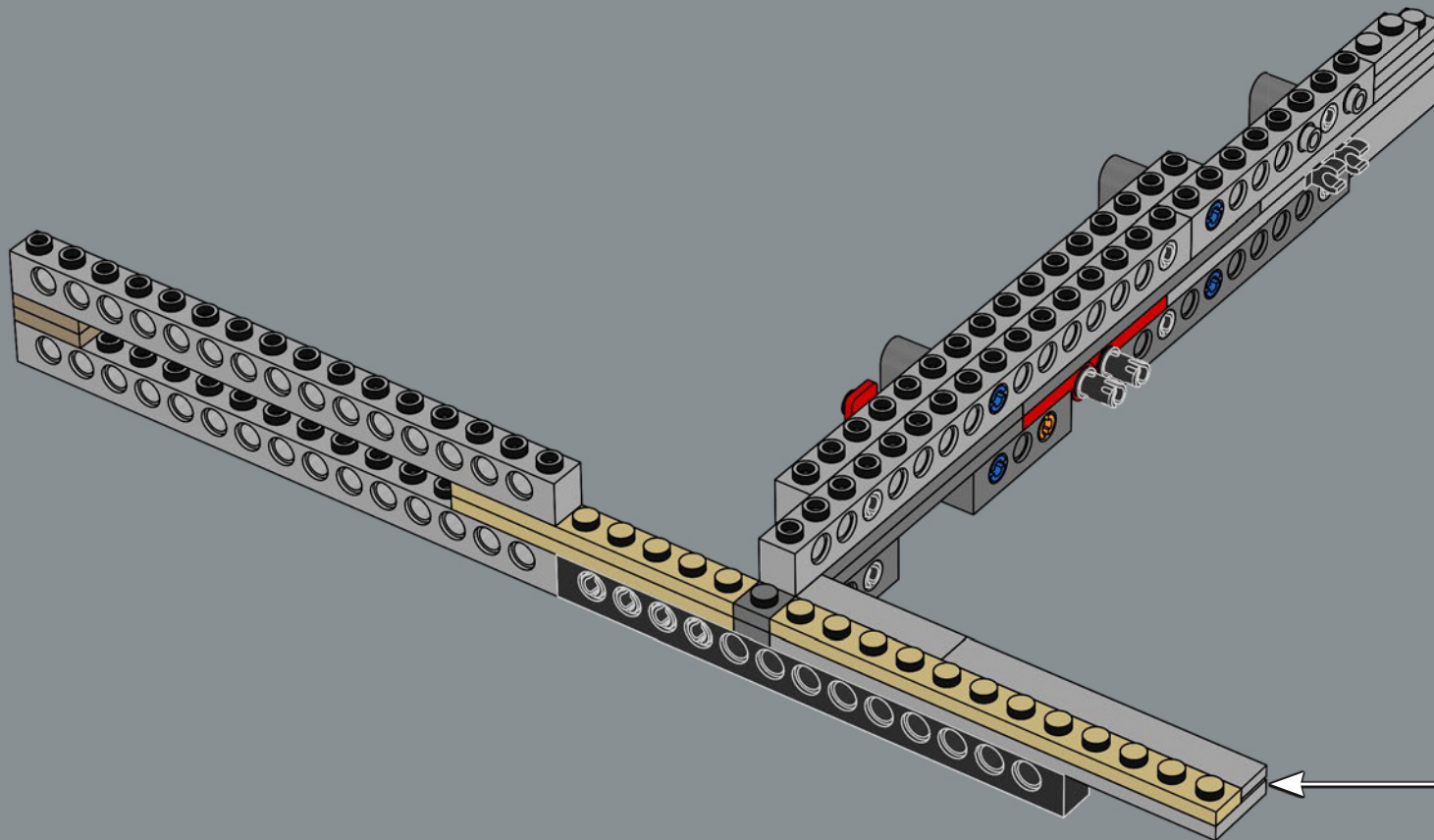
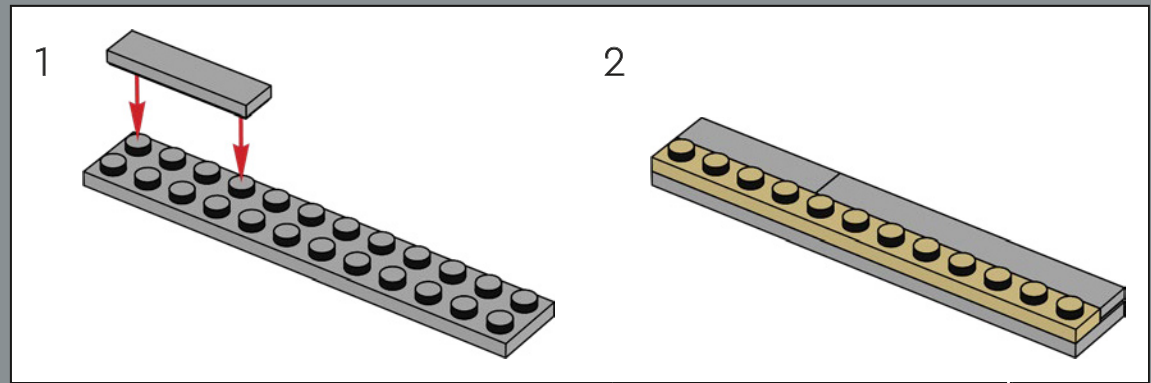



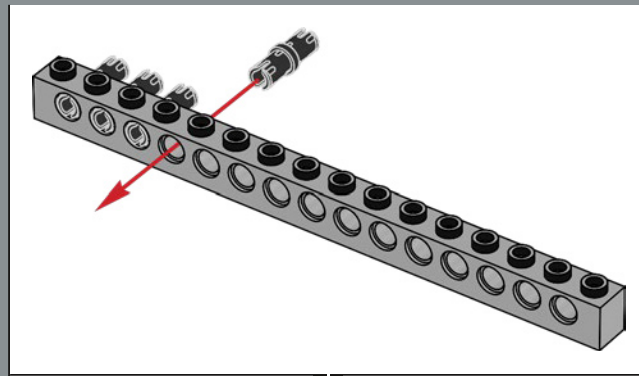
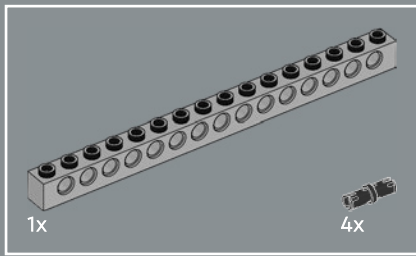

109

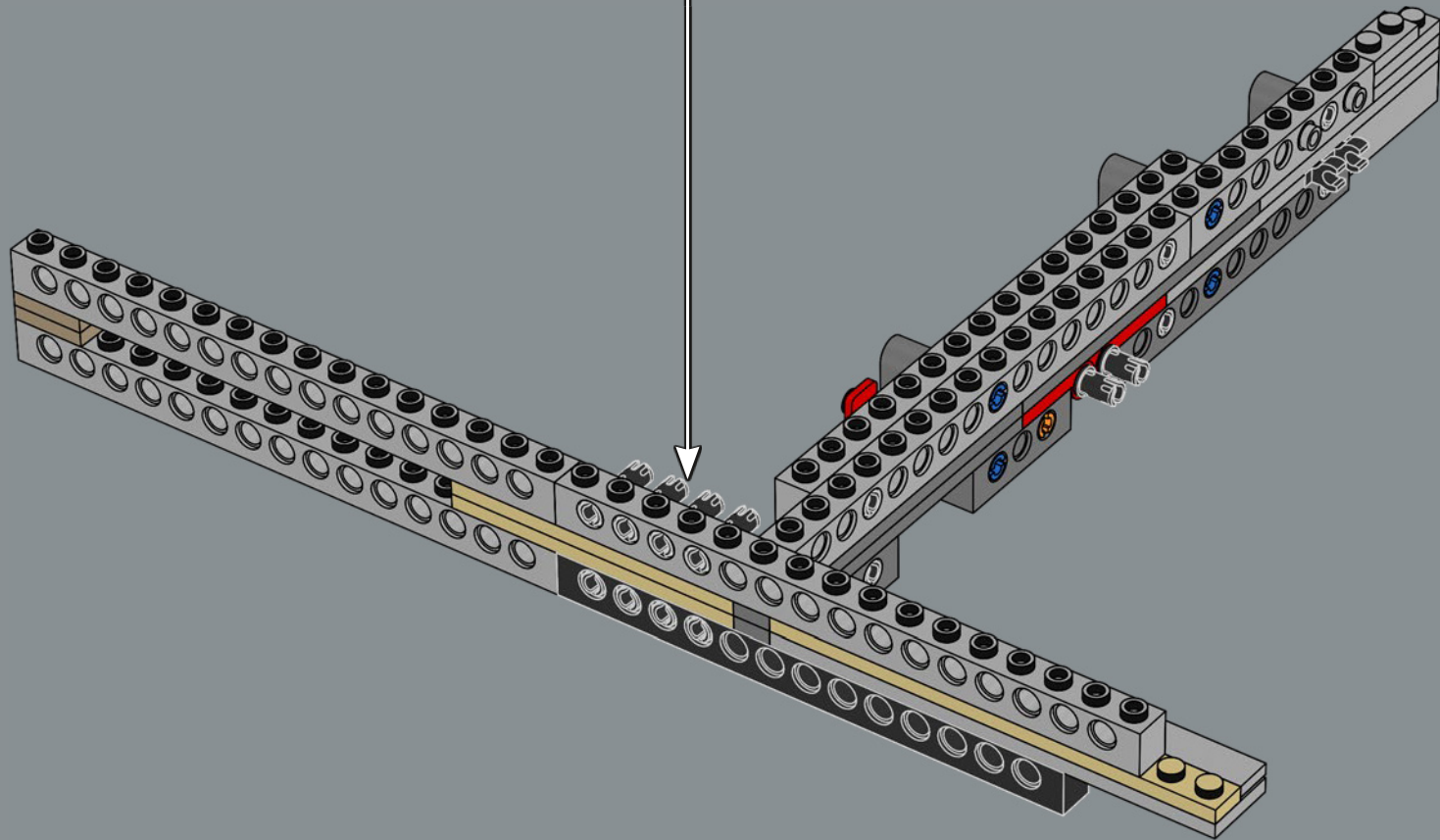

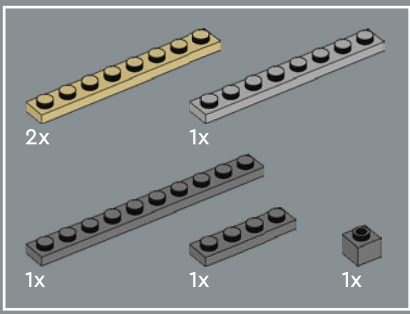

110

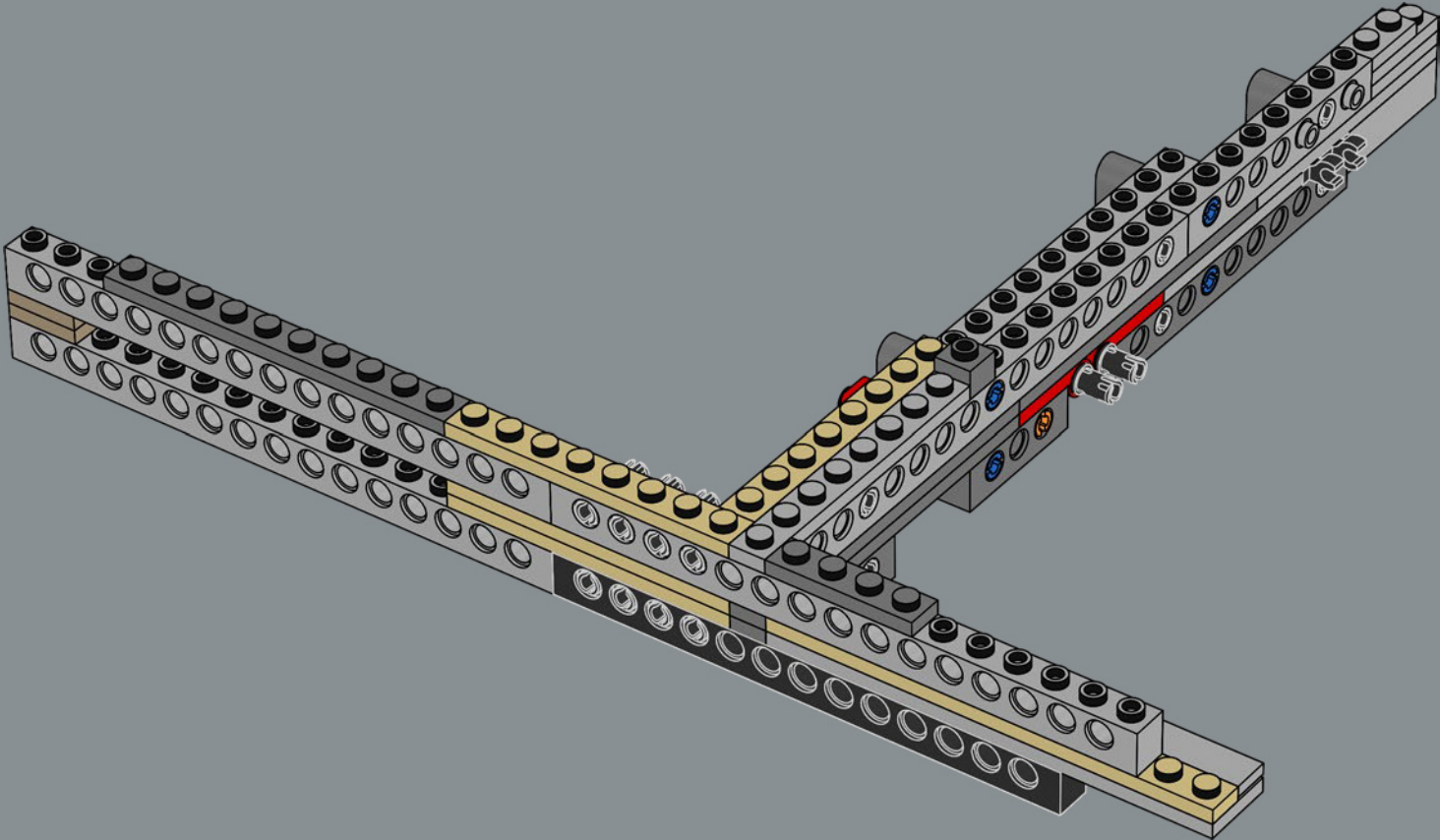

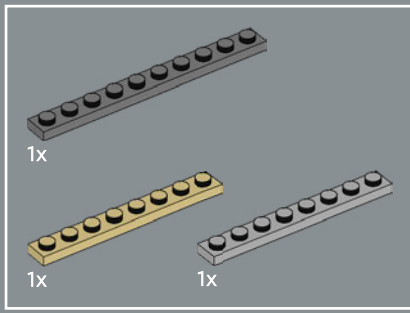

111

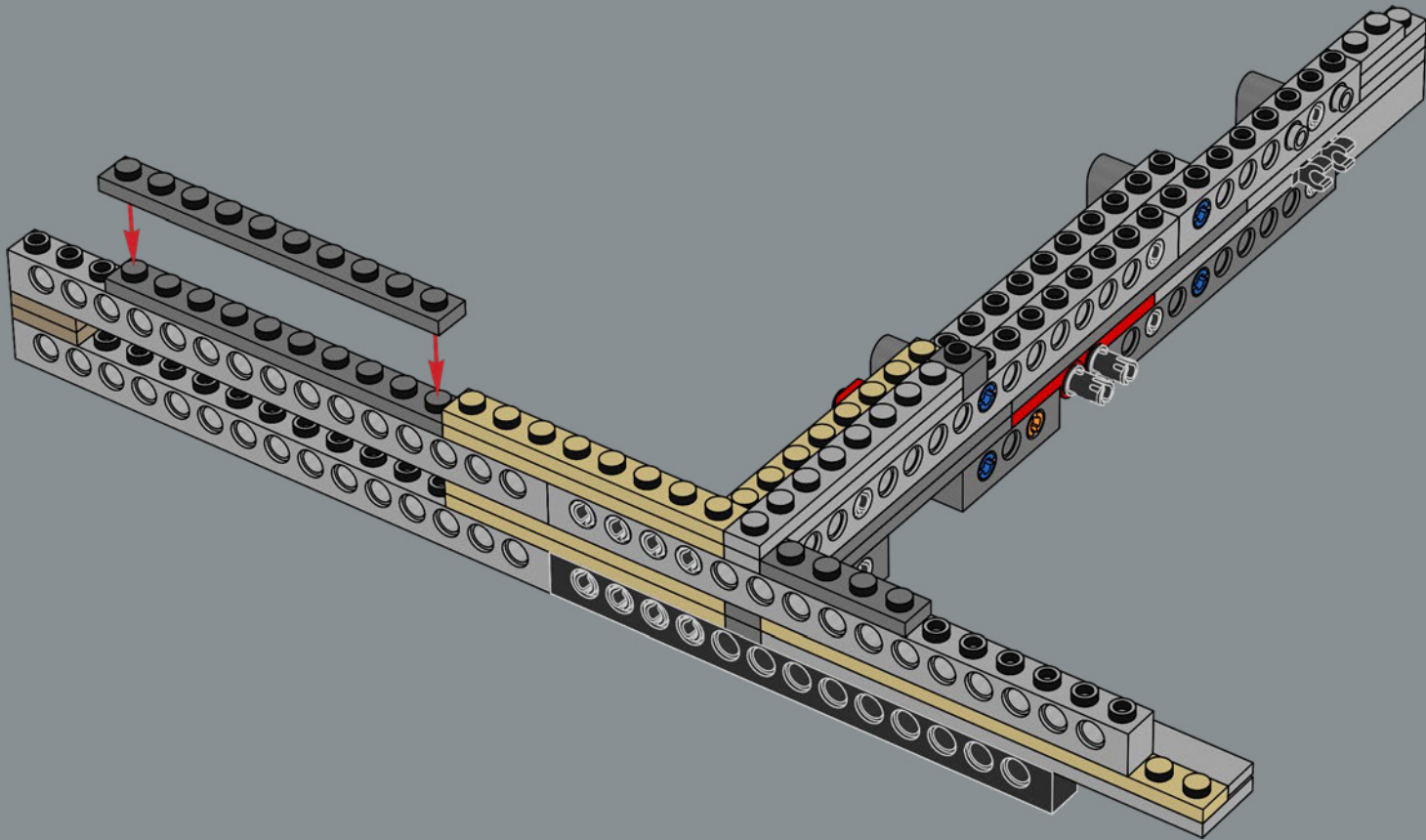



2x

112

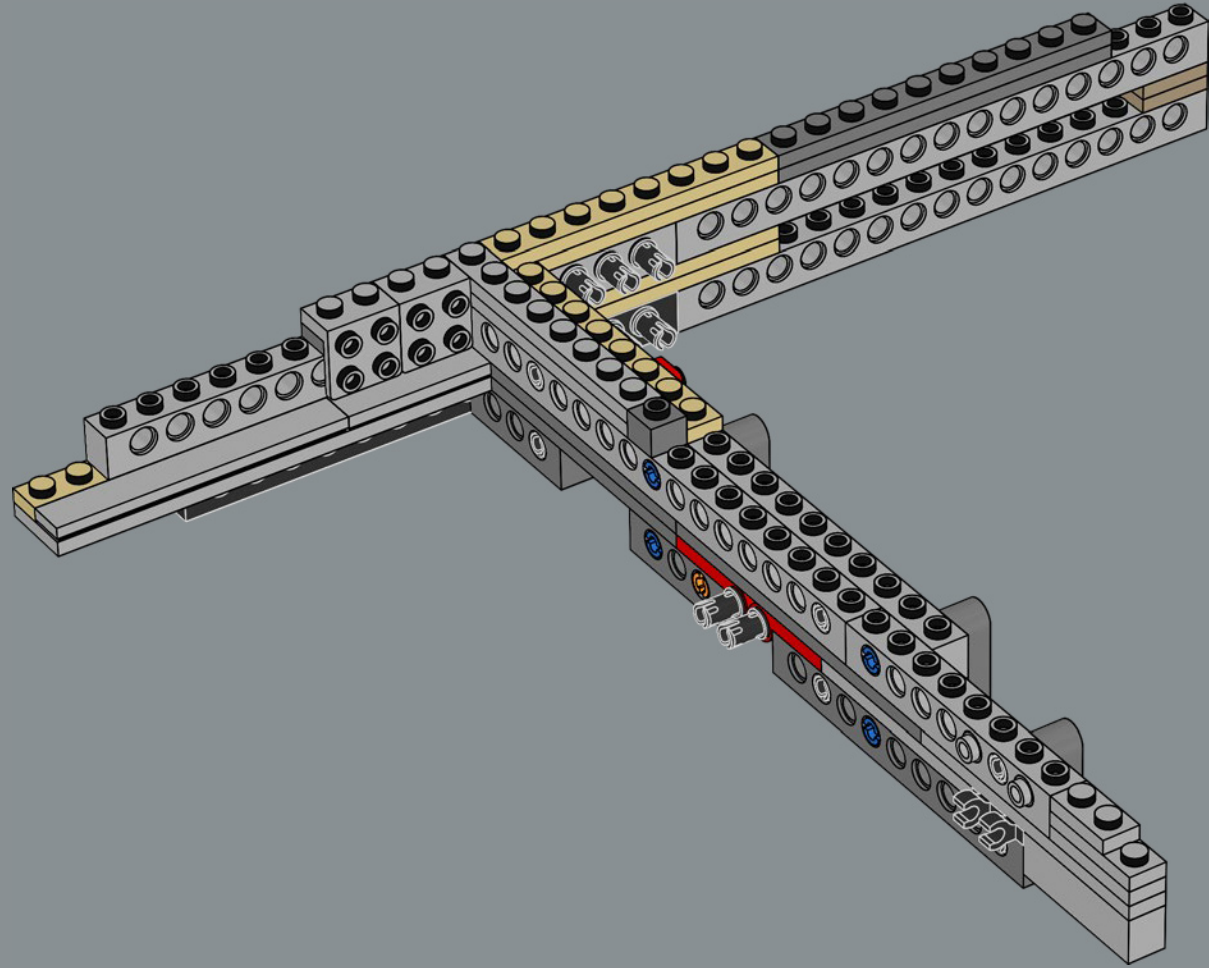

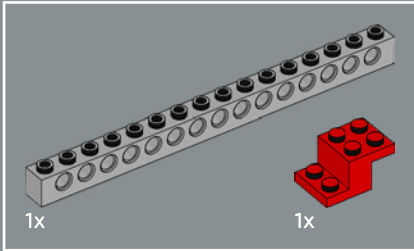
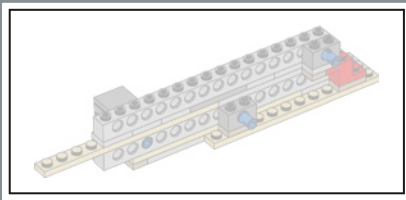

113

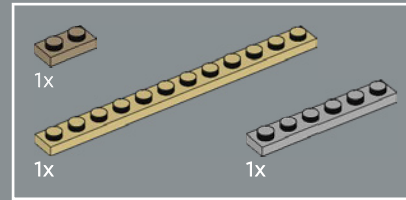
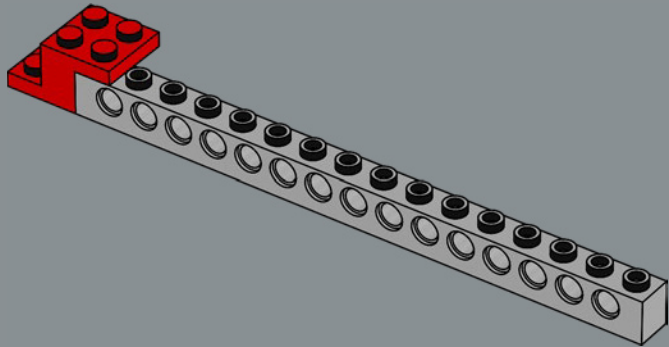

114

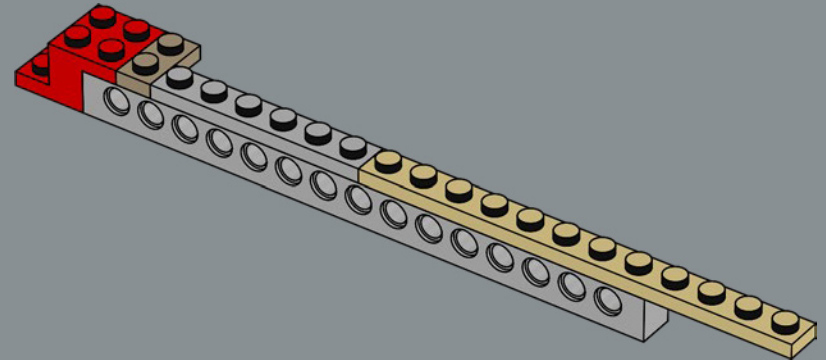

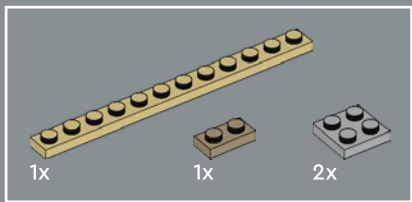

115

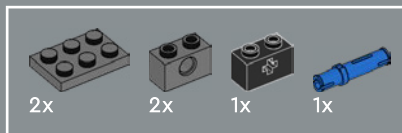
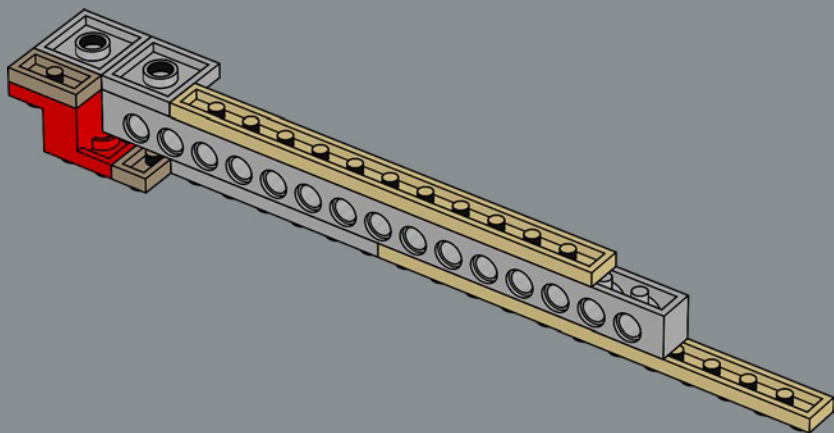

116

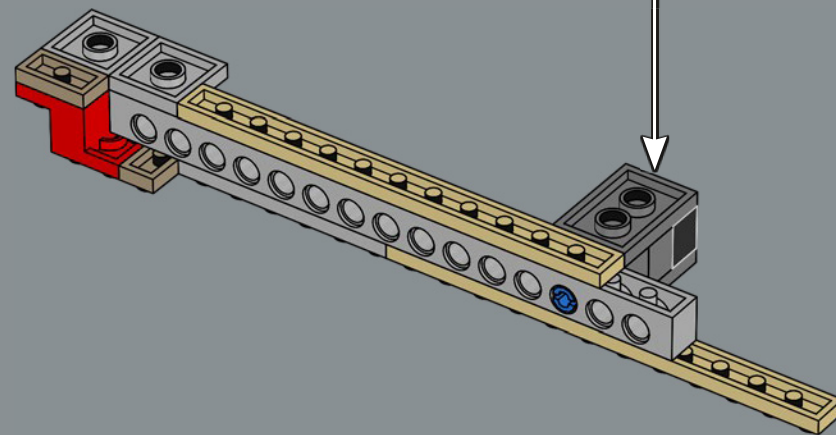
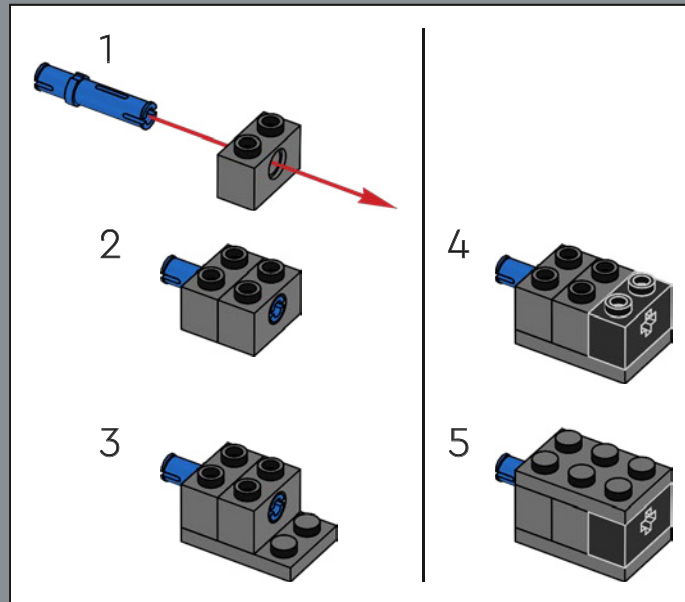

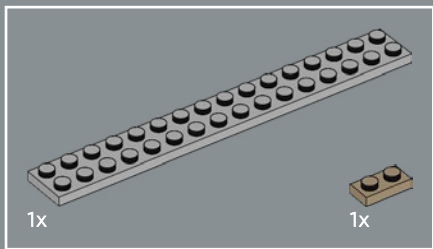

117

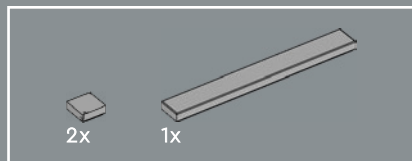
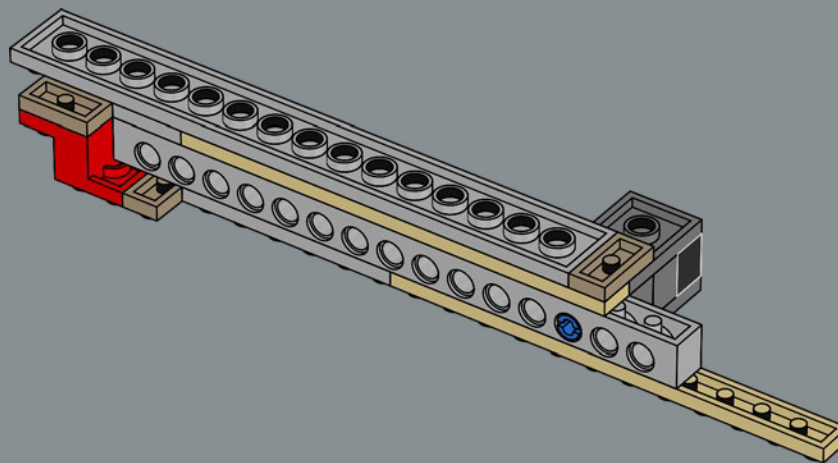

118

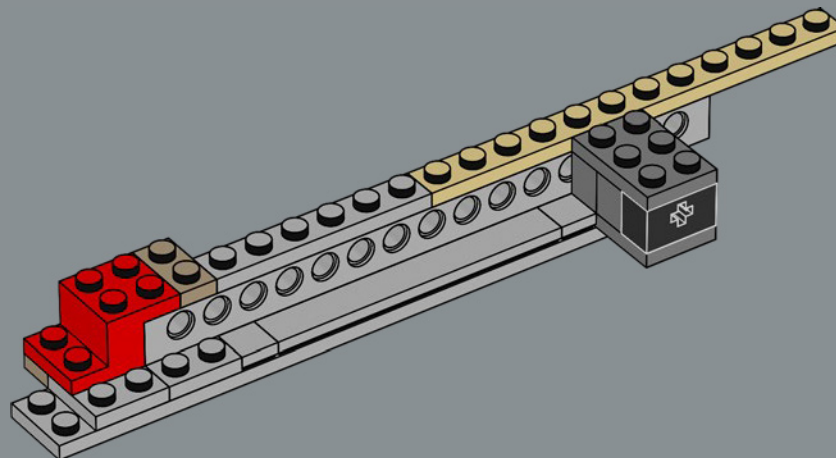

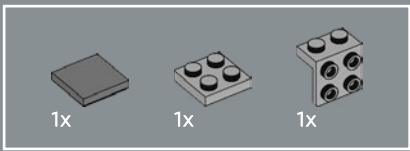

119

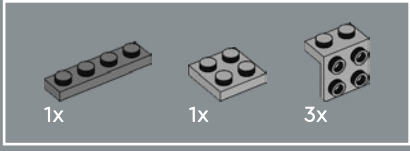
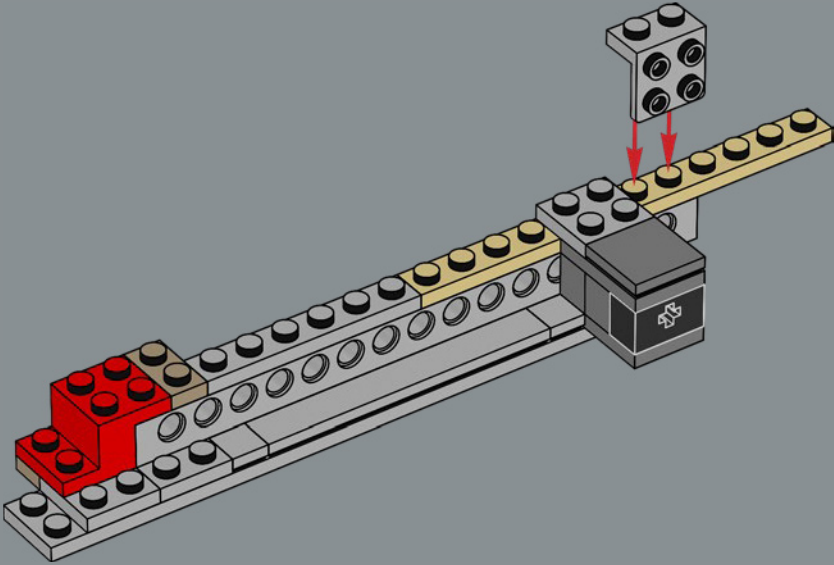

120

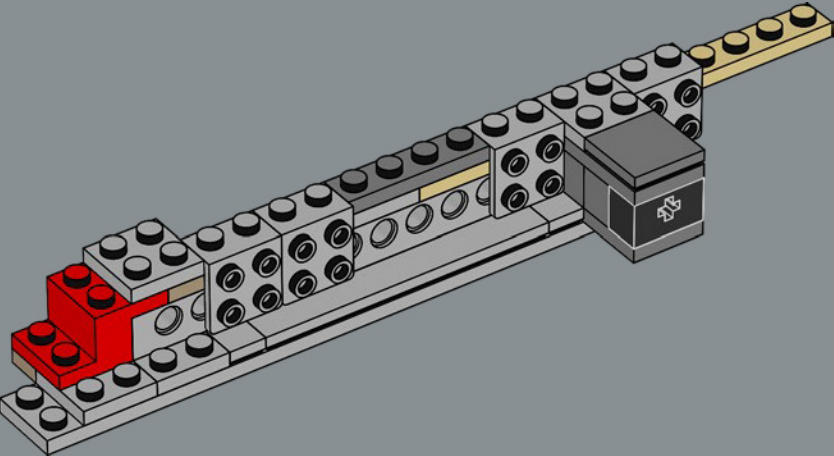



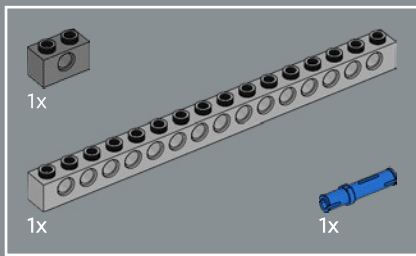

121

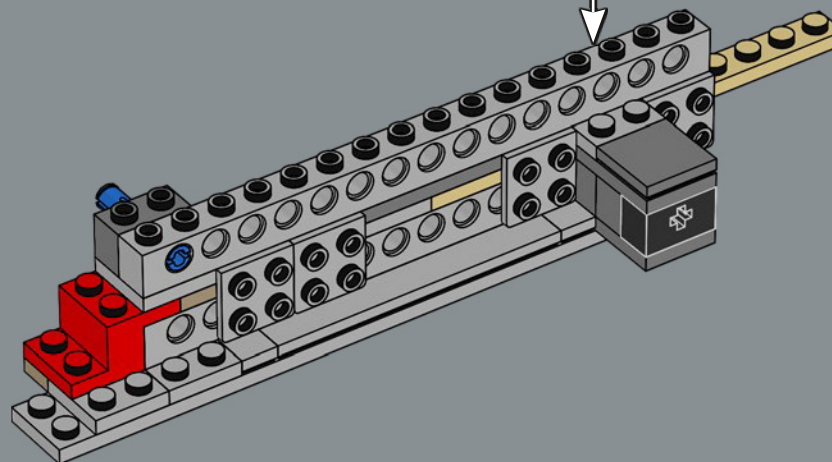
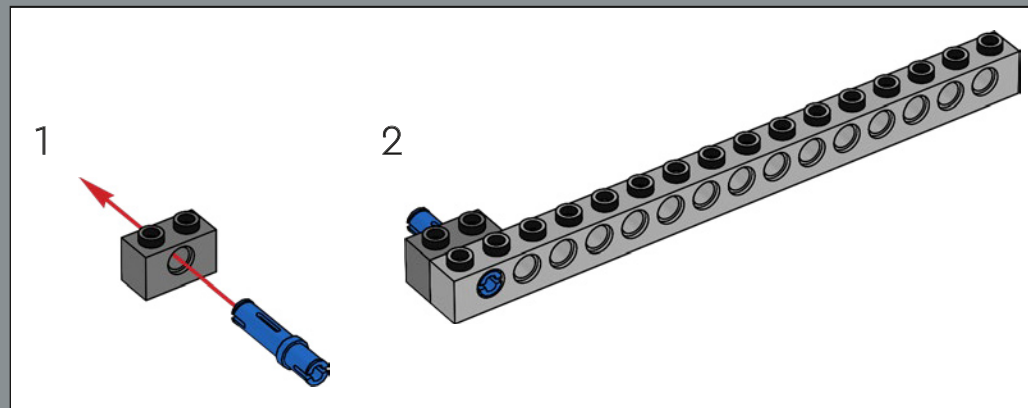

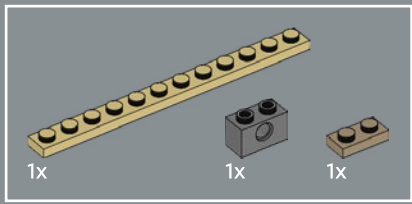

122

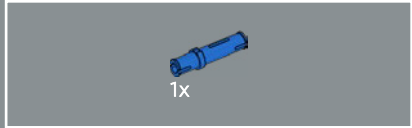
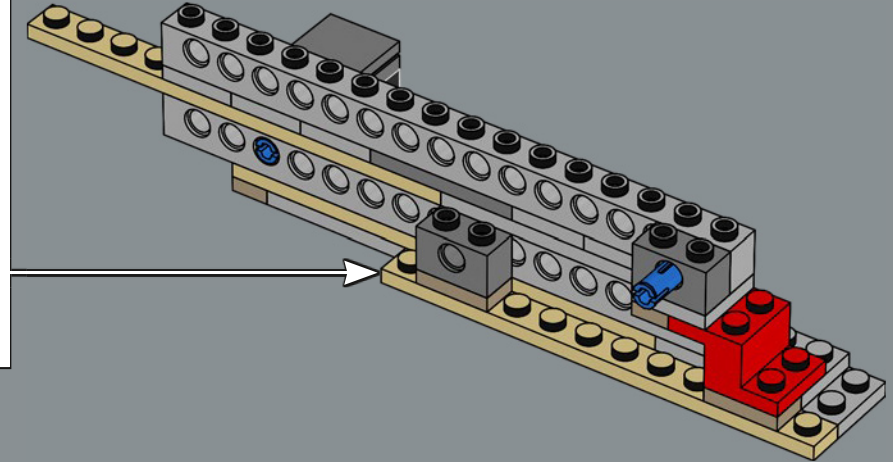
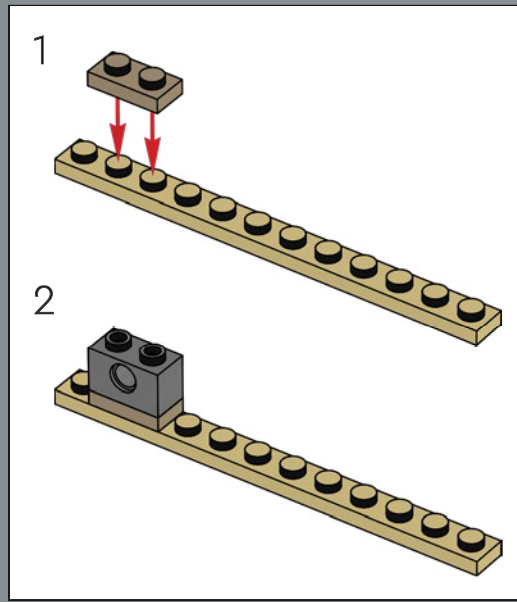

123

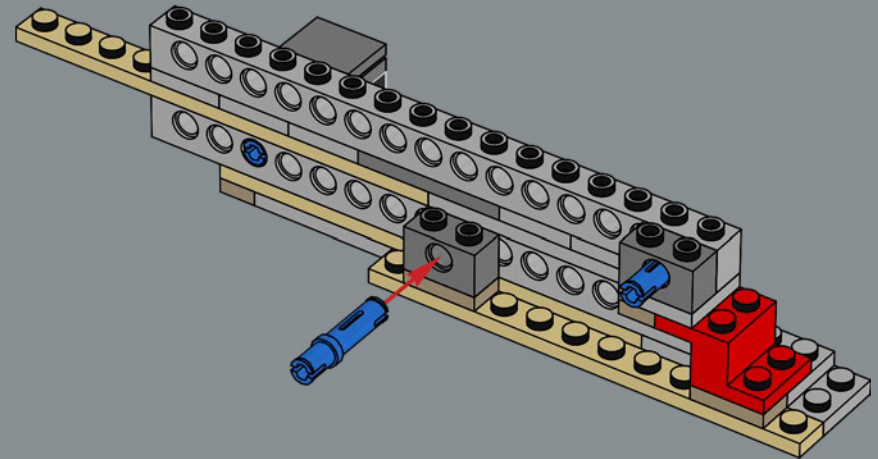

124

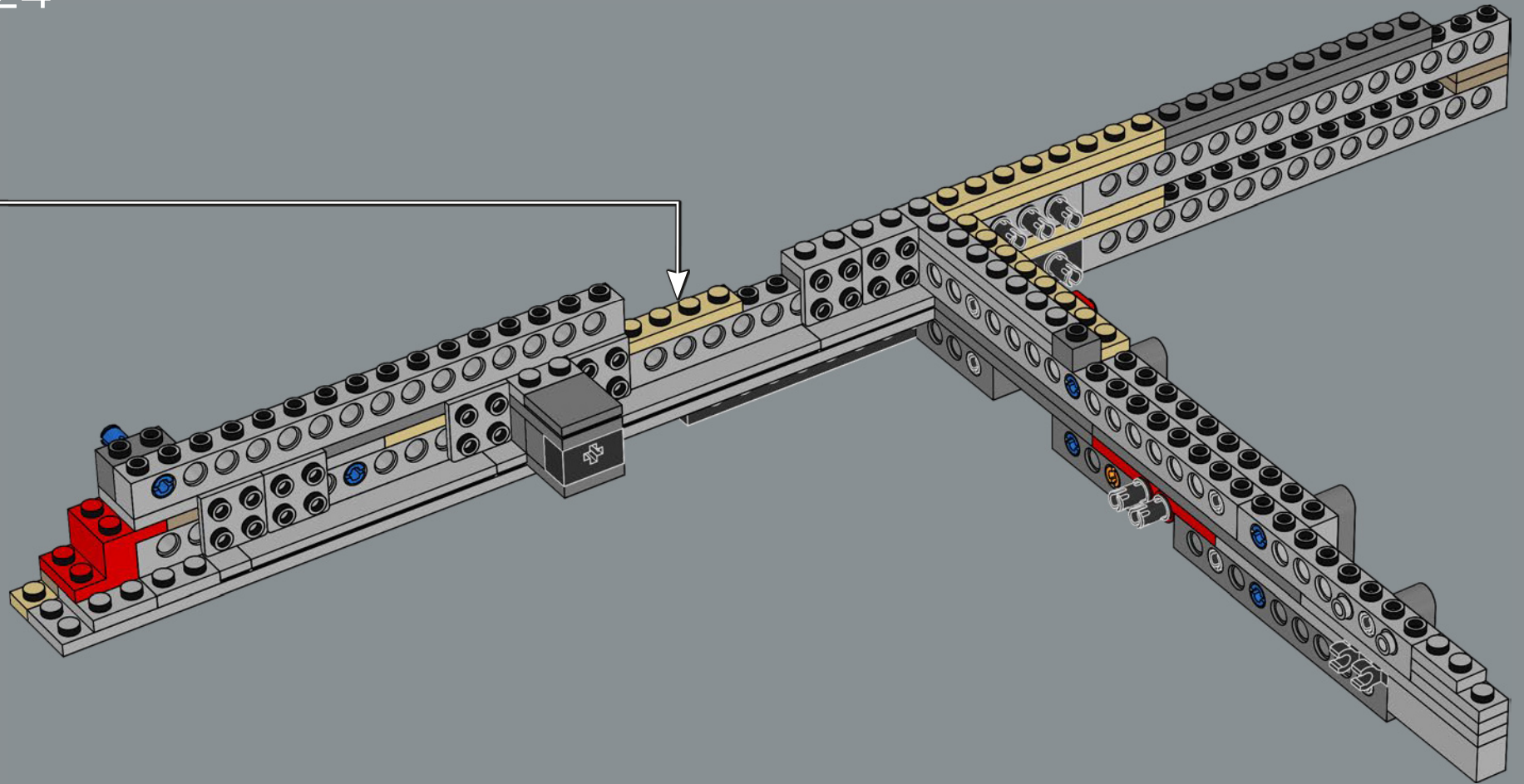

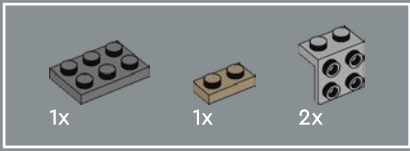

125

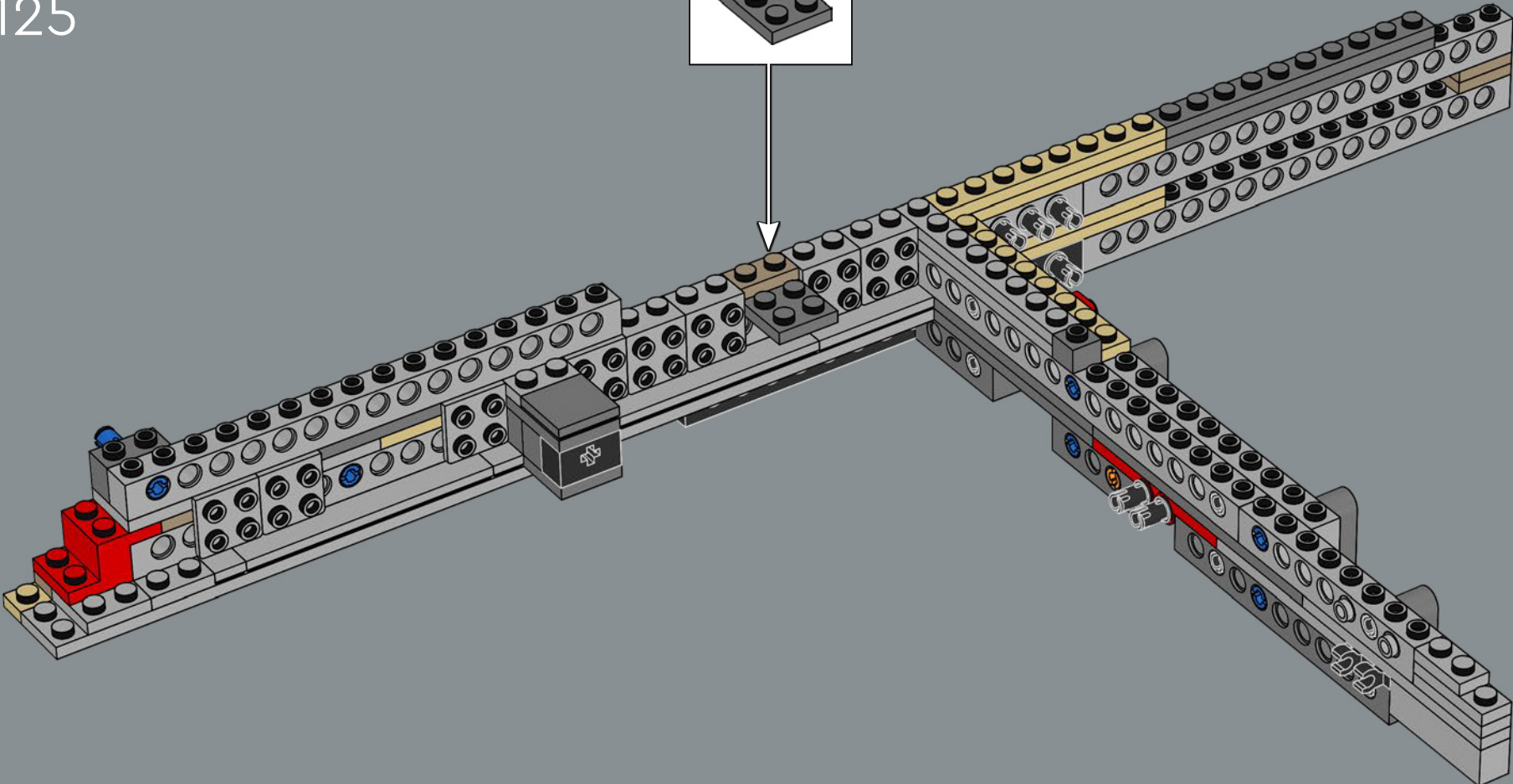
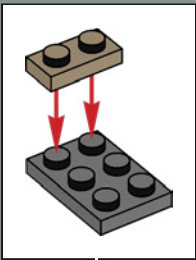

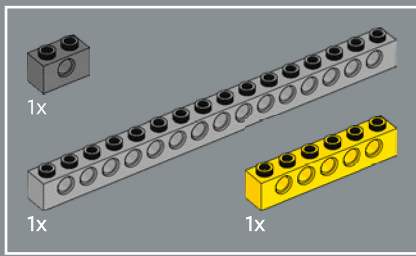

126

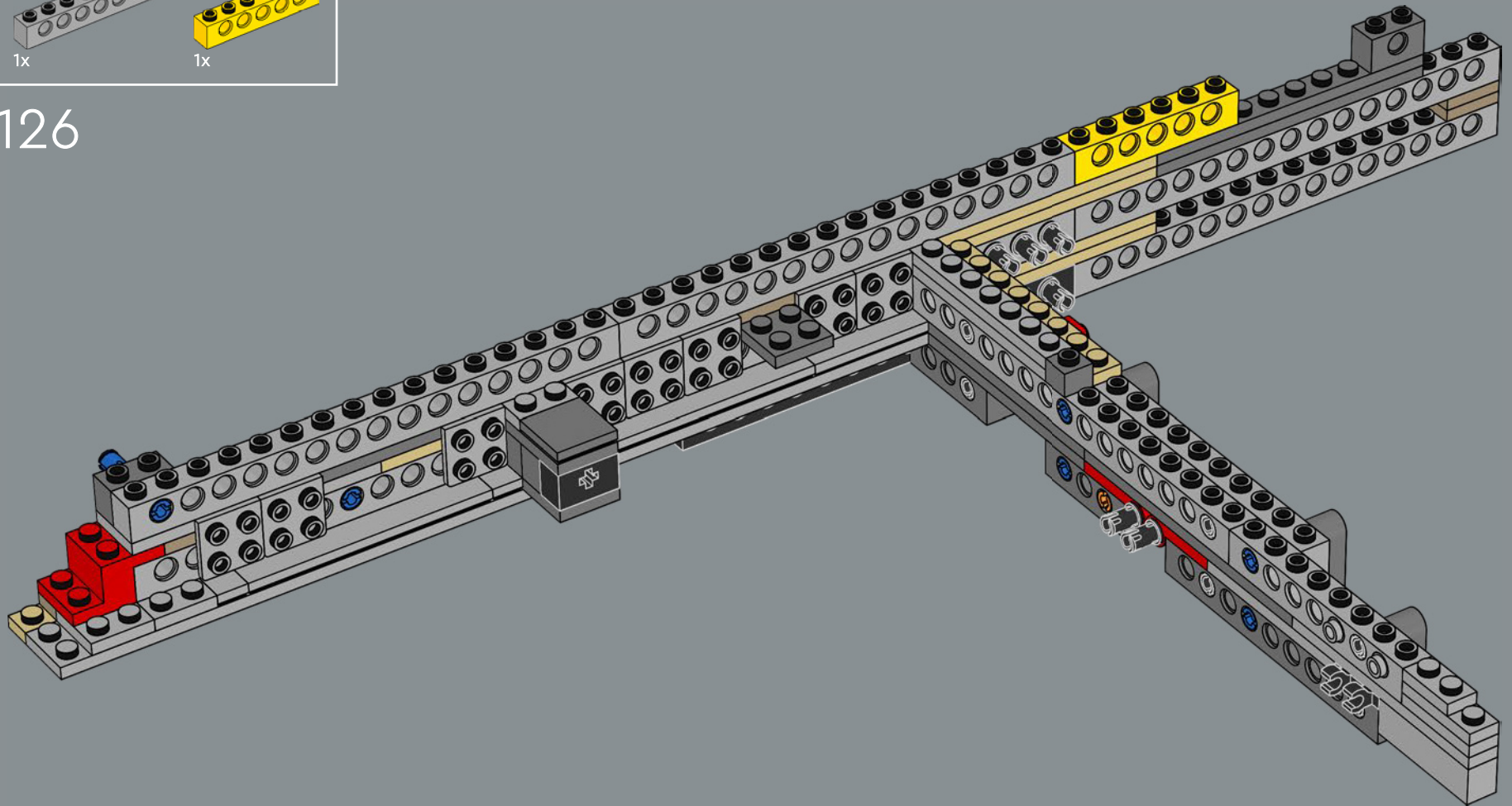

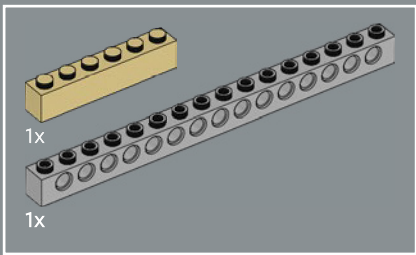

127

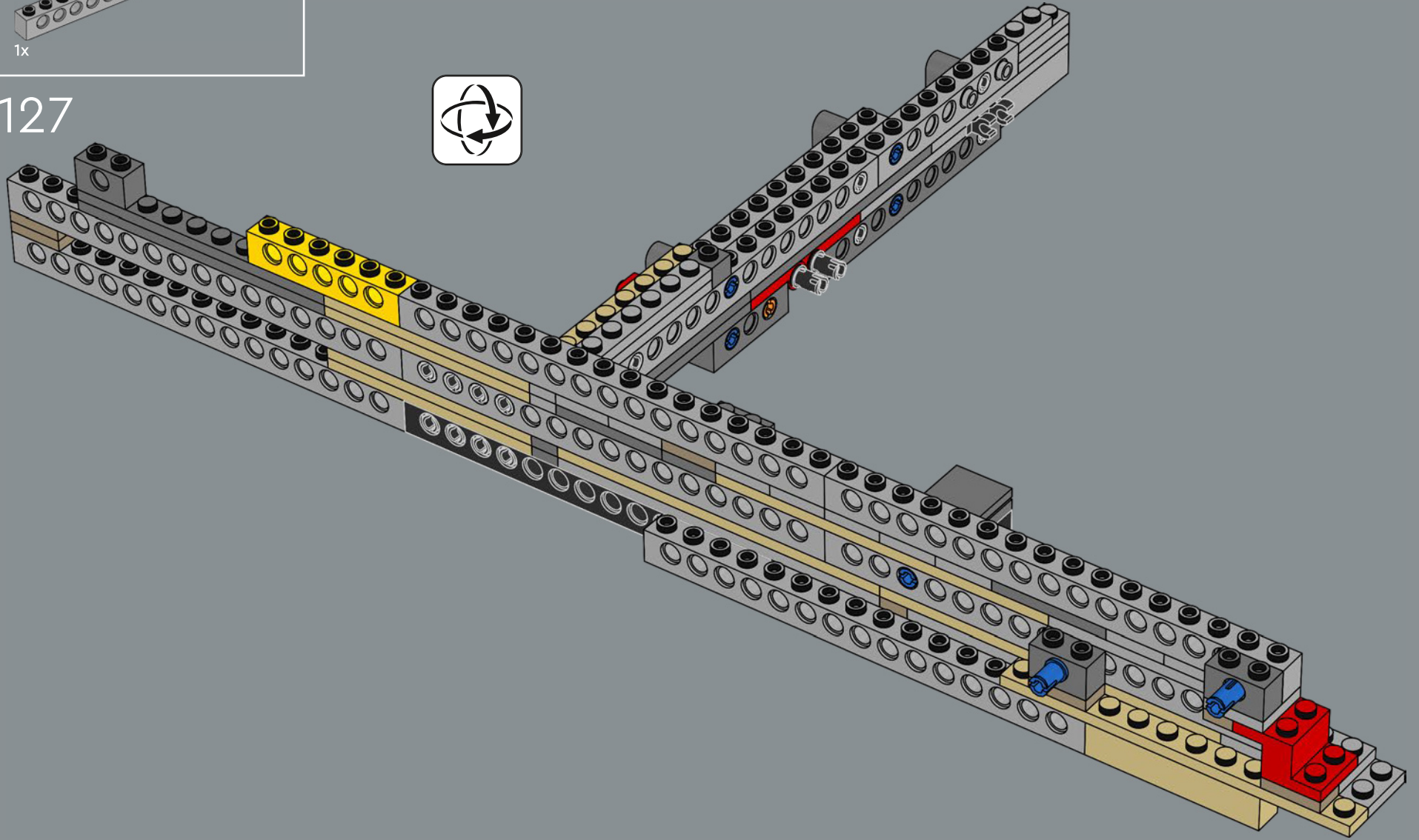

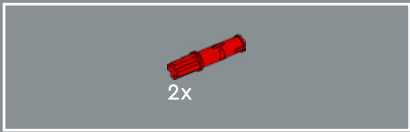

128

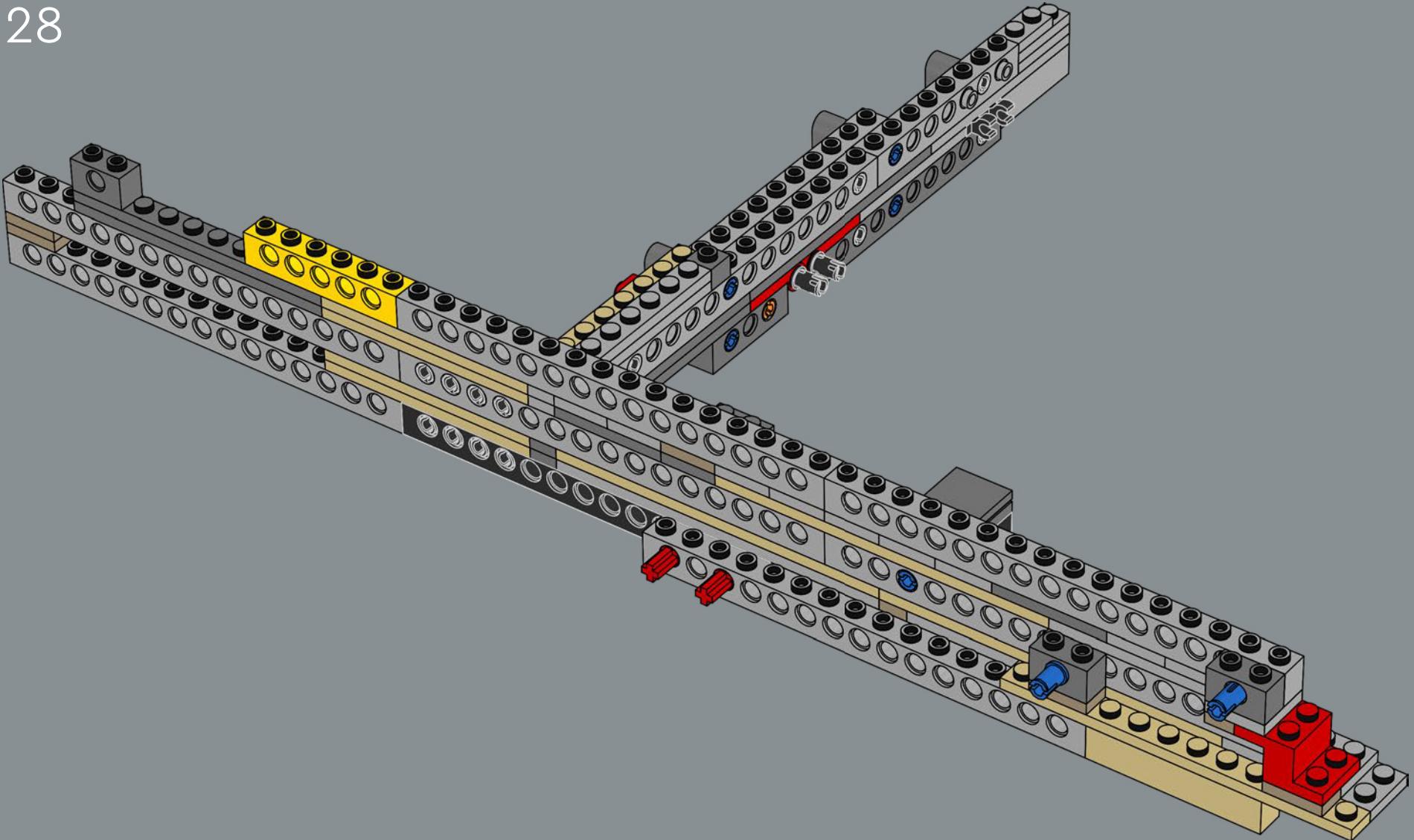

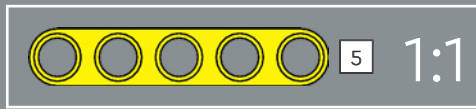
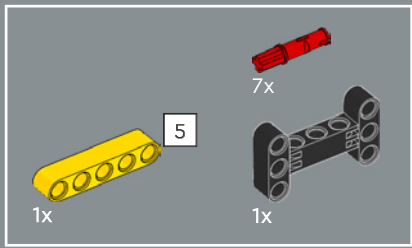

129

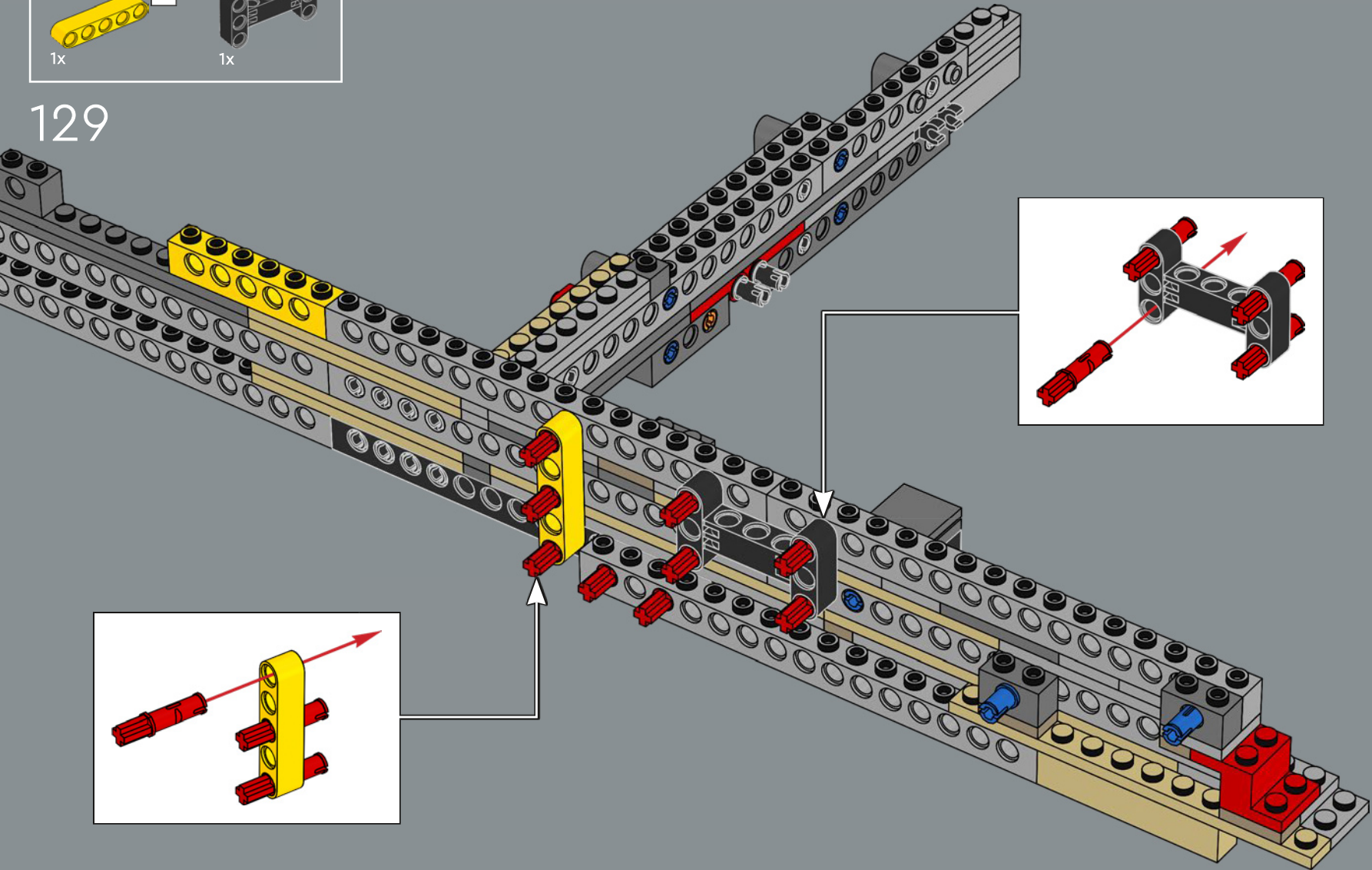



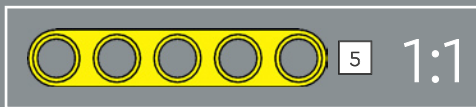
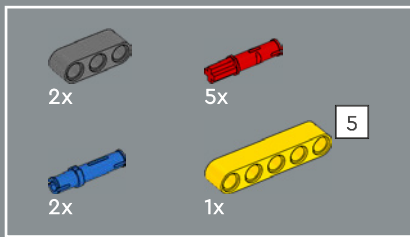

130

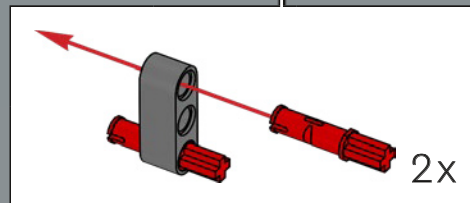
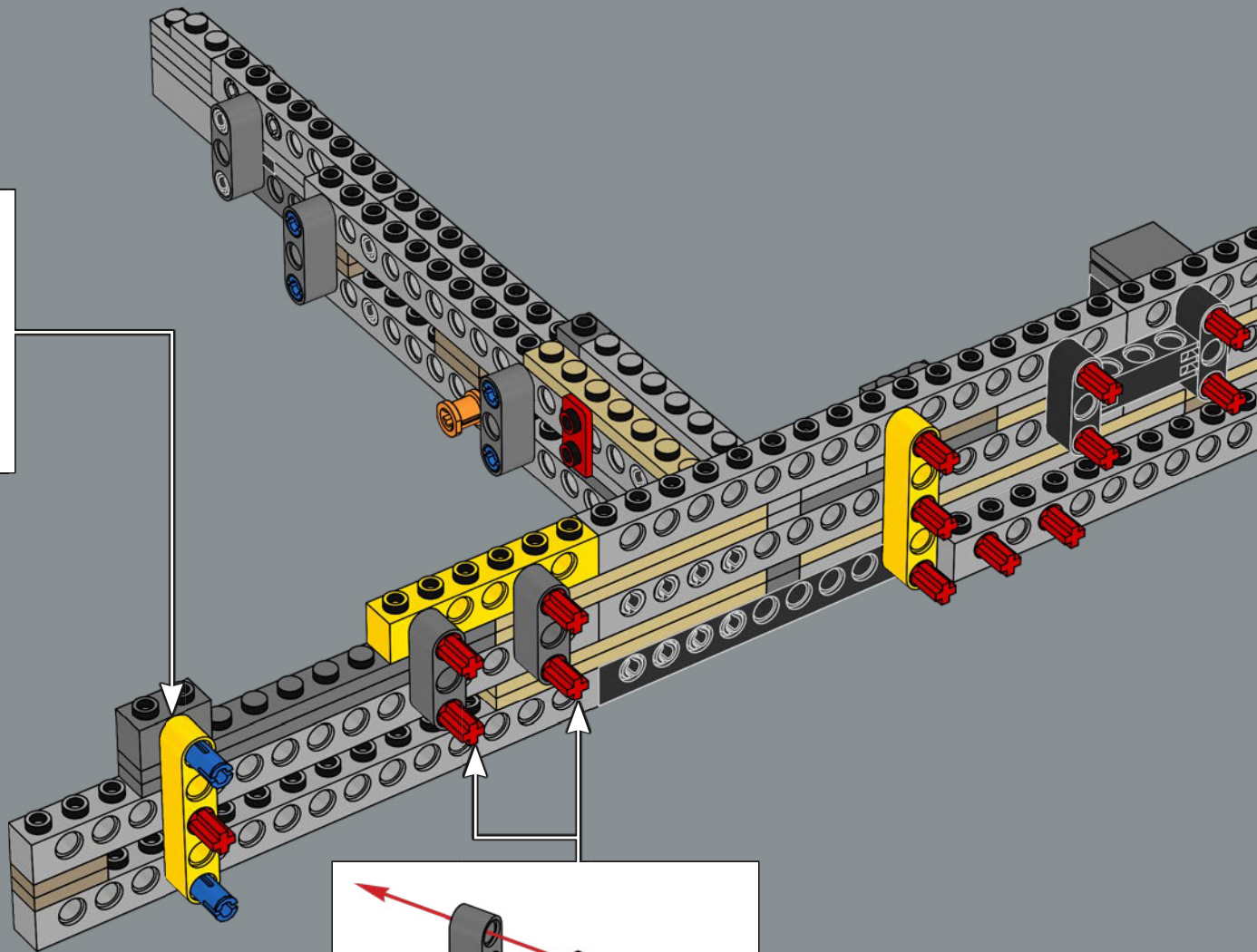
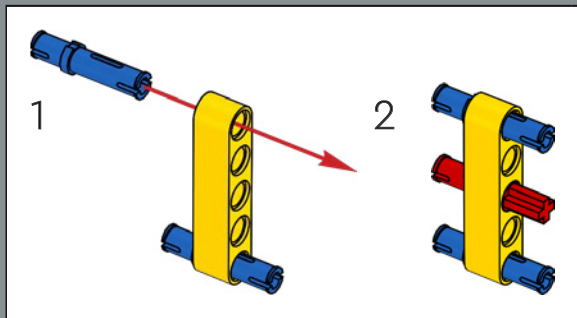

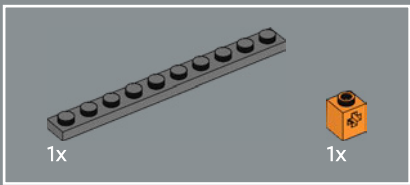

131

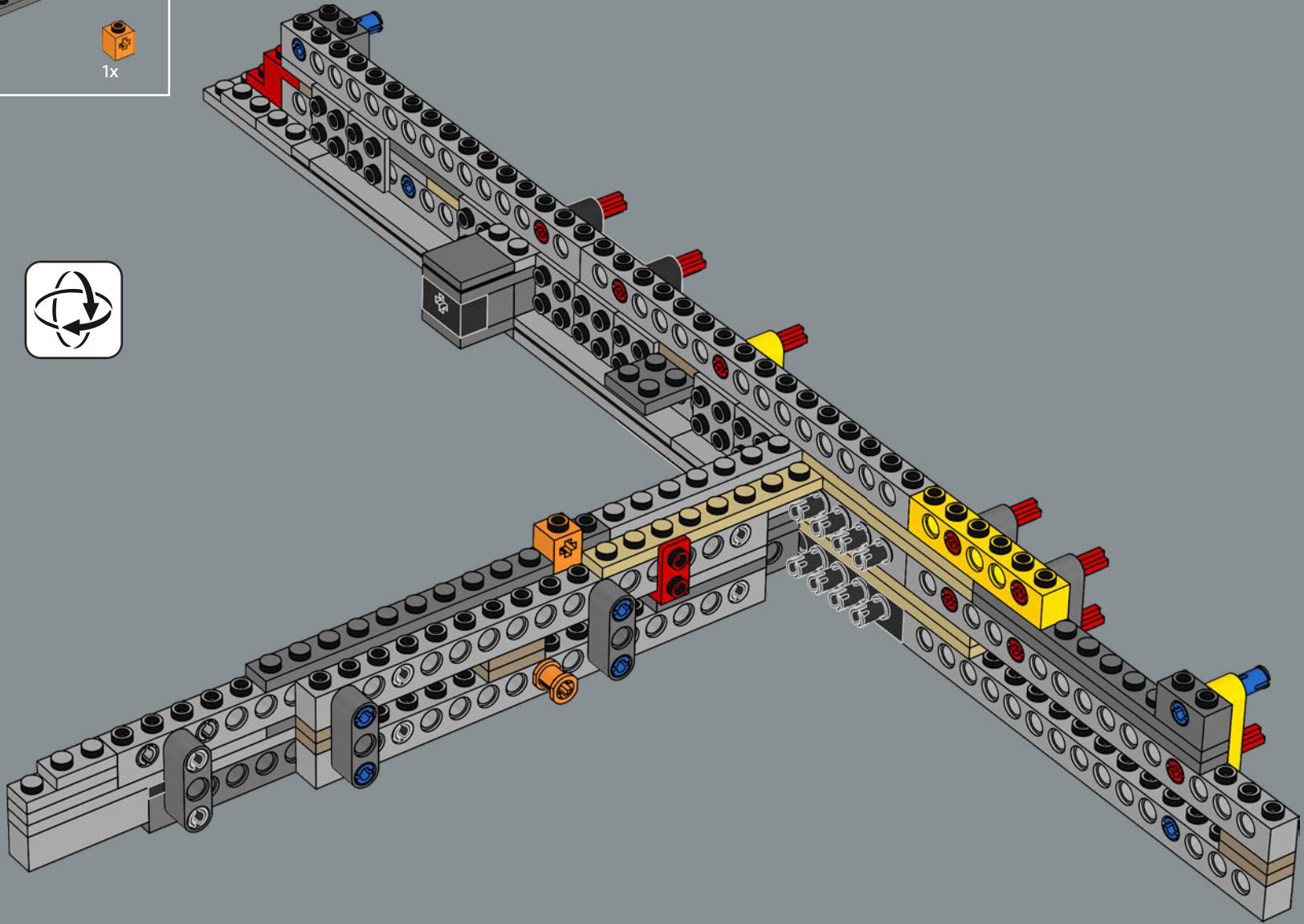

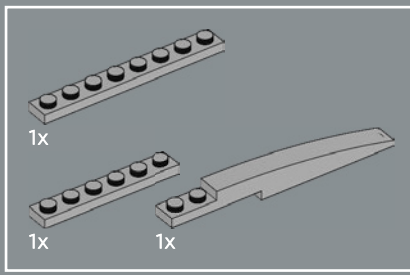

132

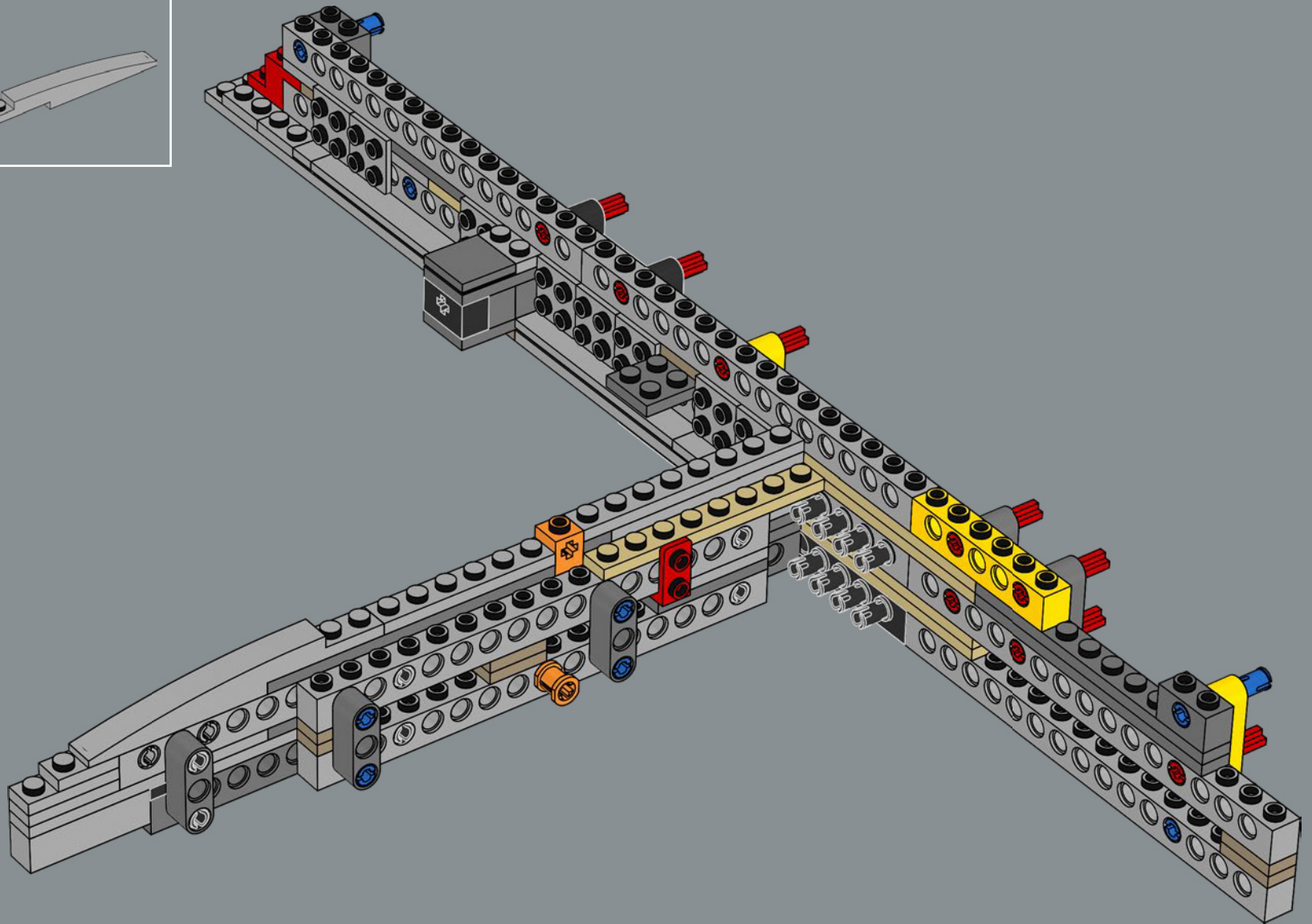

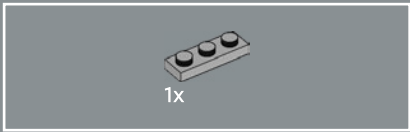

133

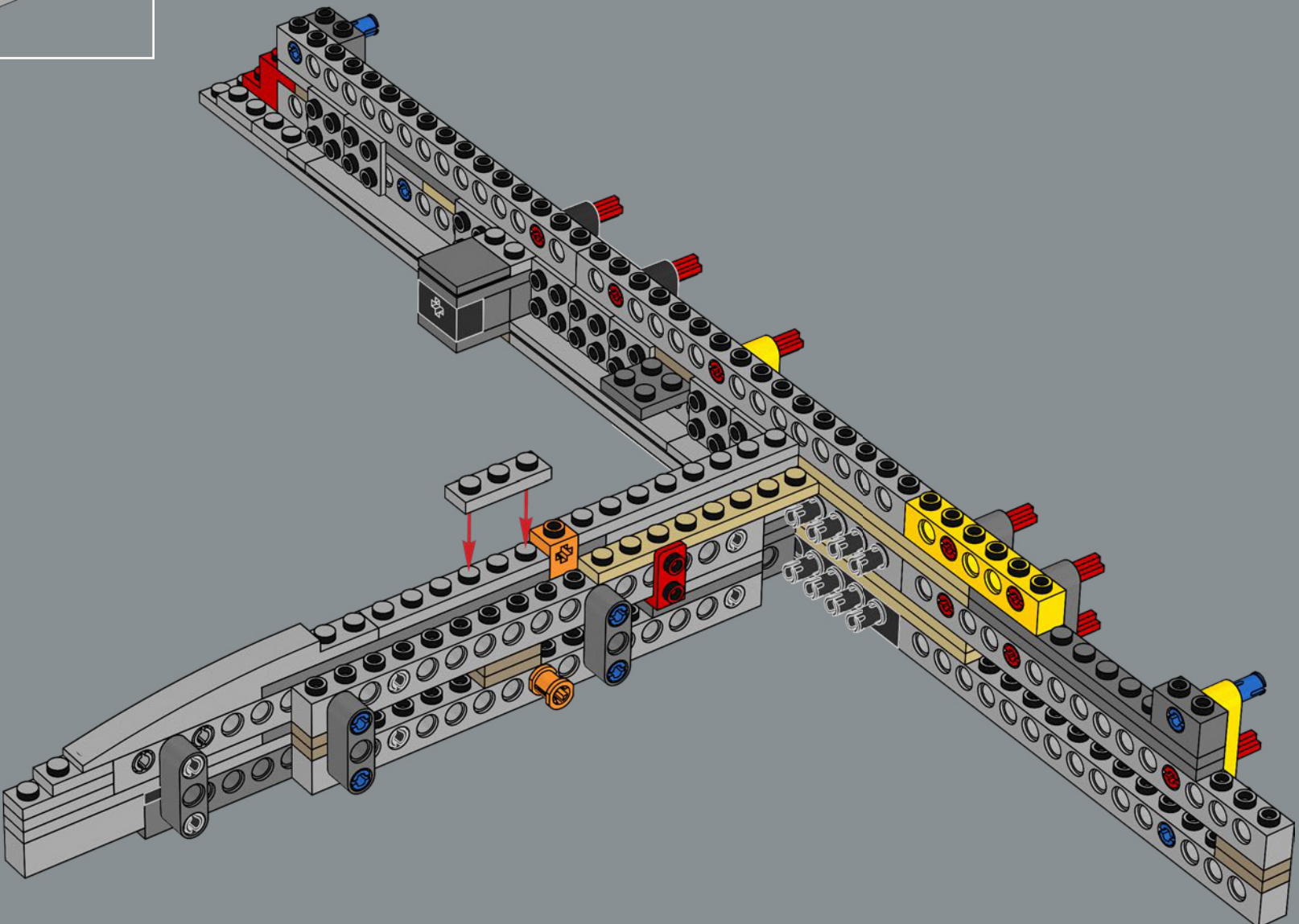

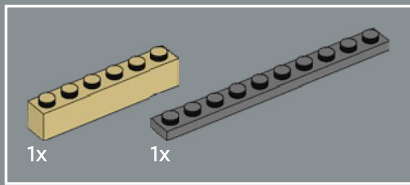

134

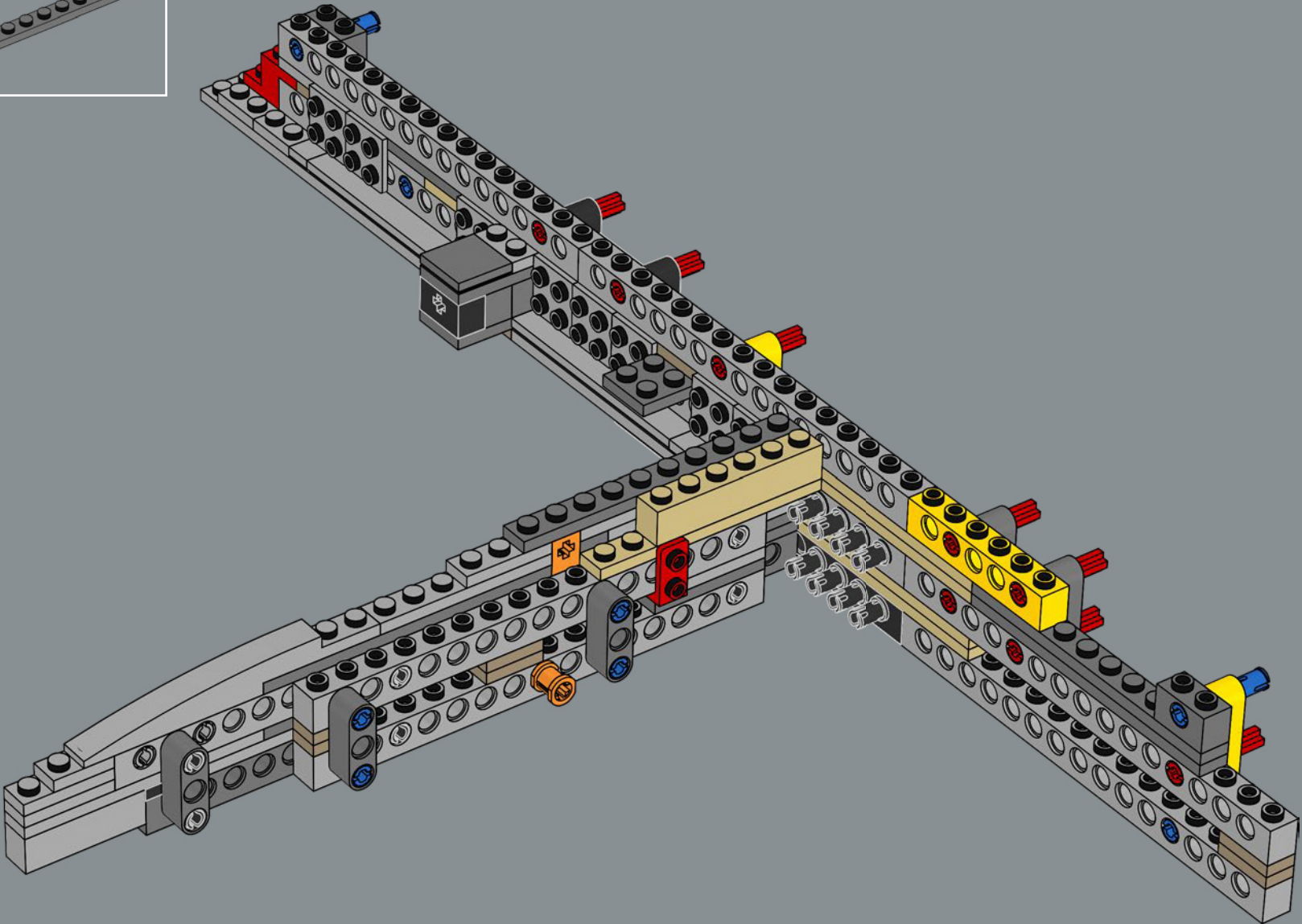

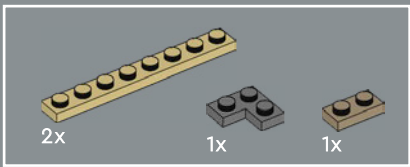

135

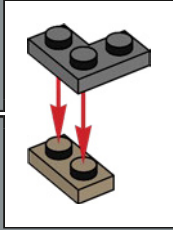
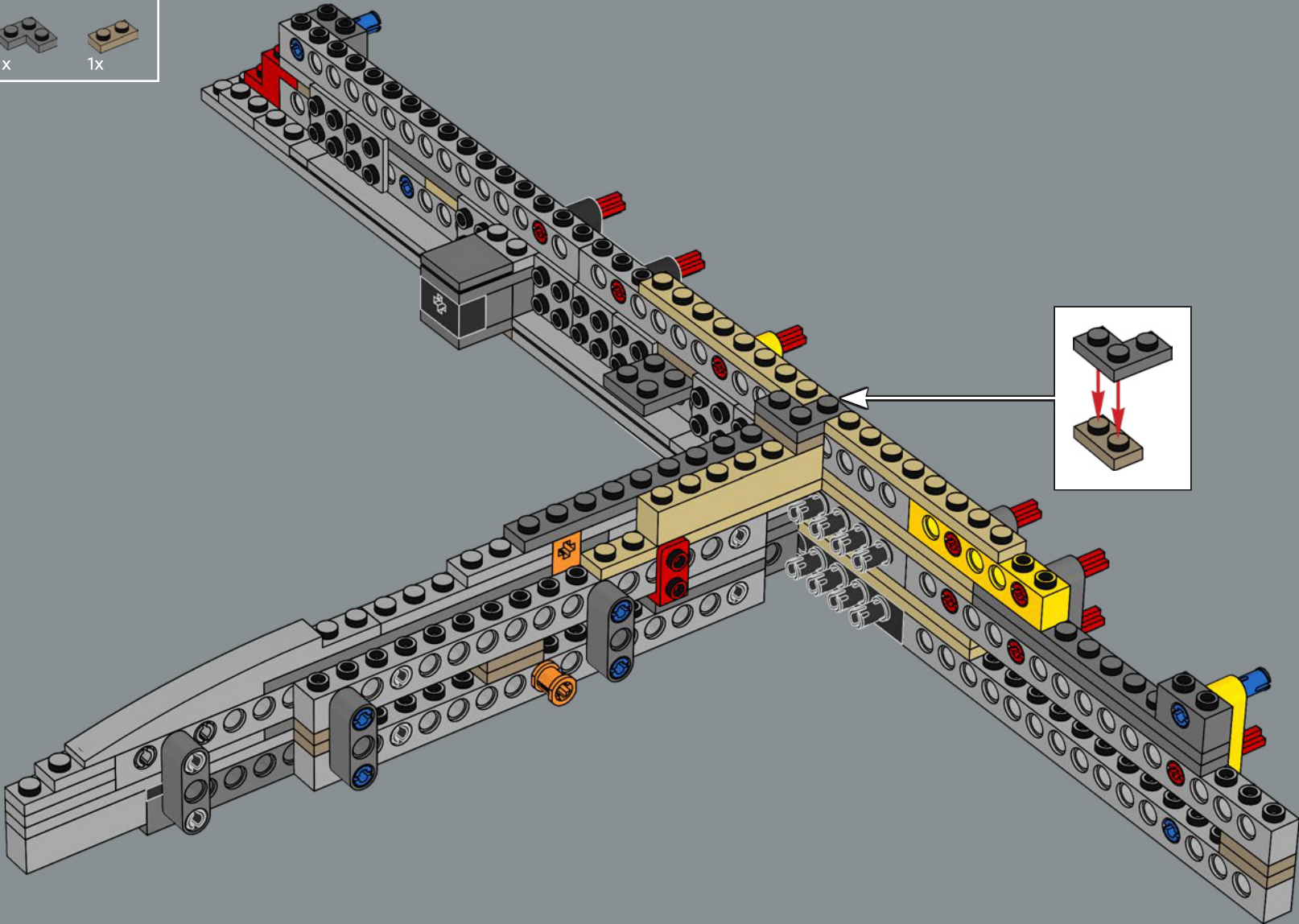

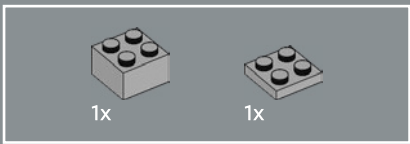

136

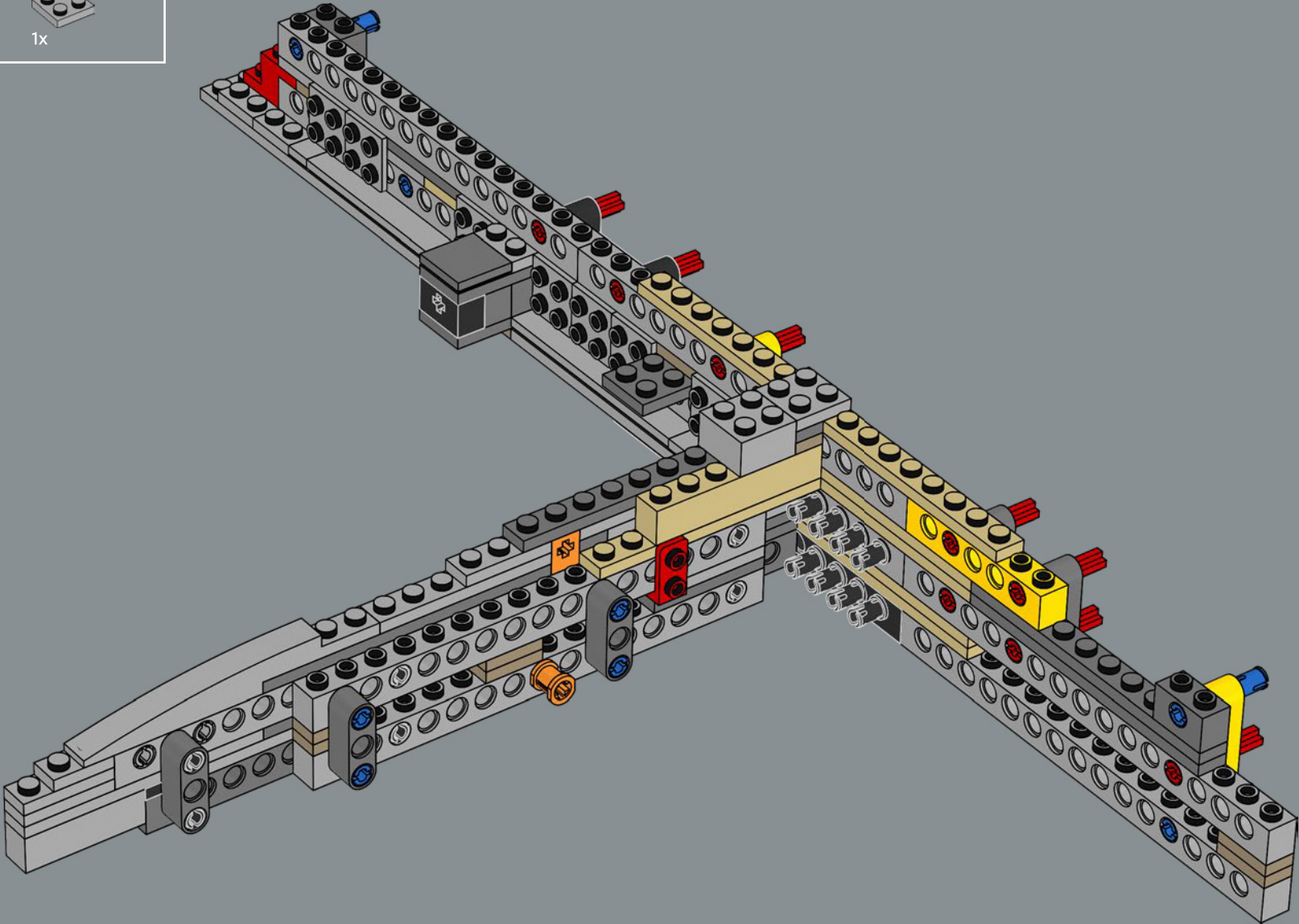

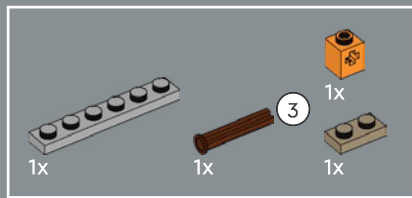

137

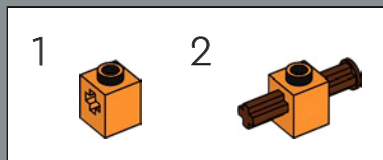
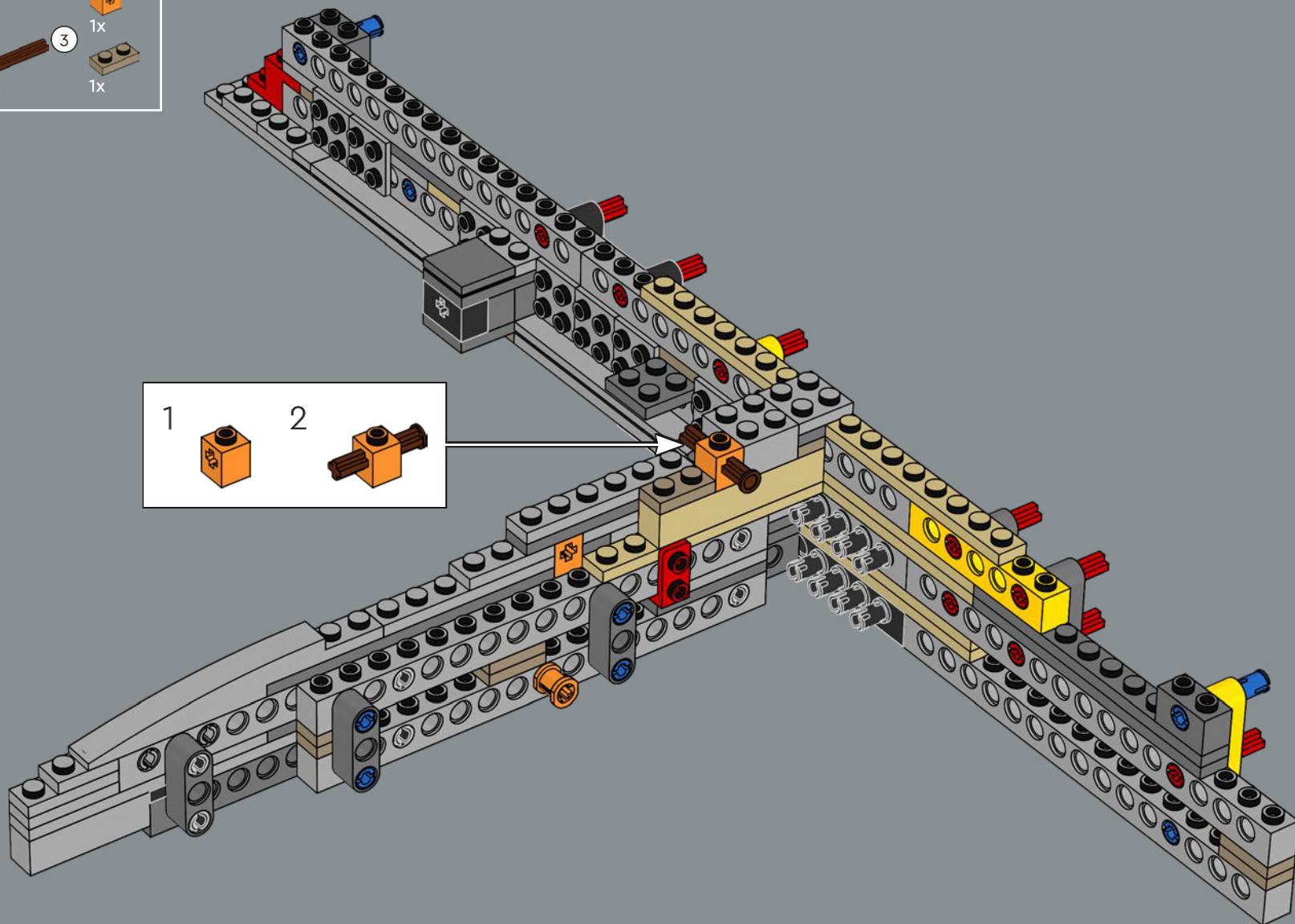



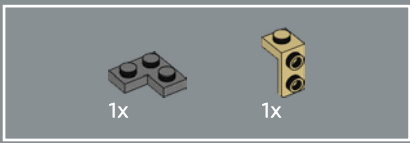

138

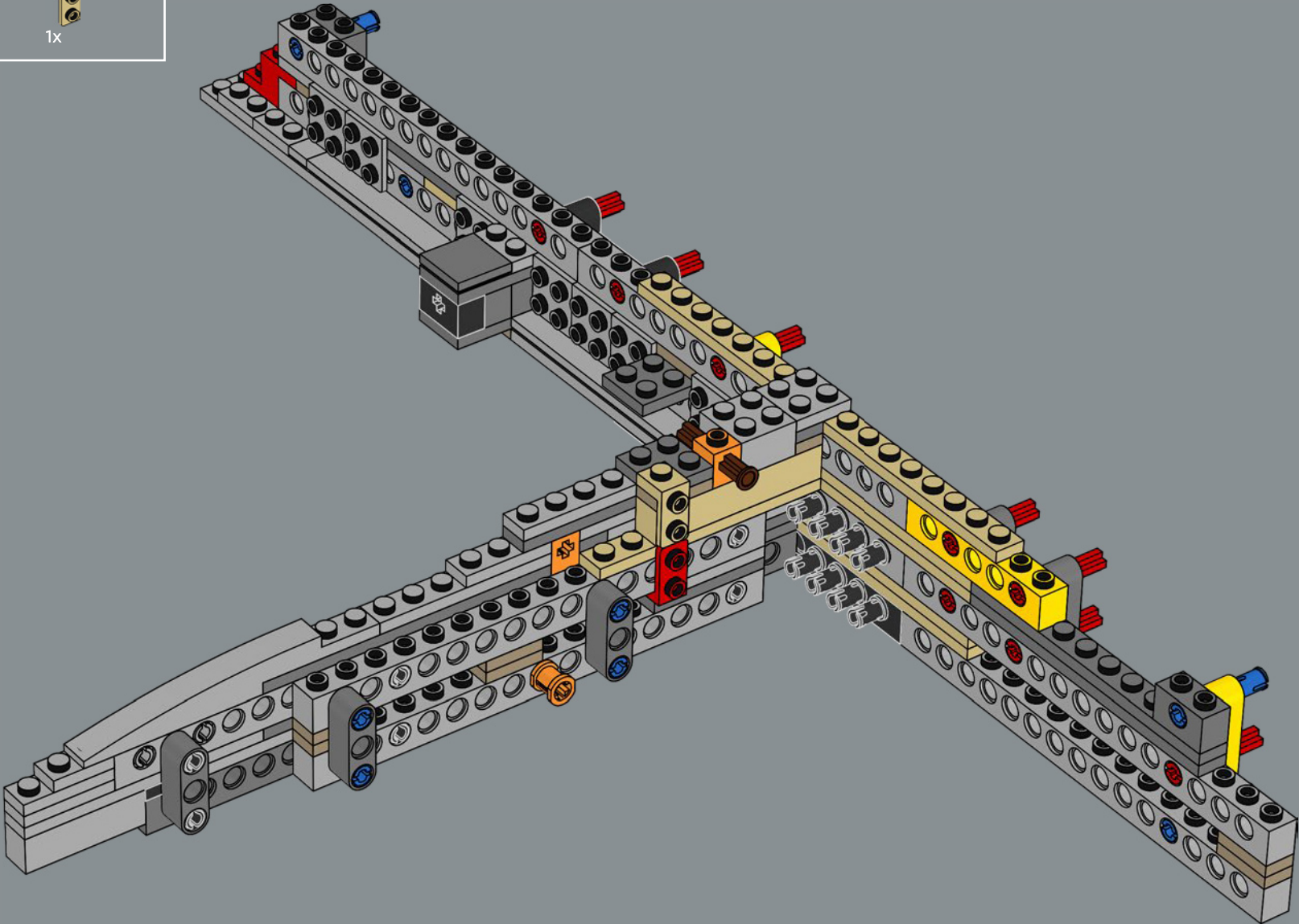

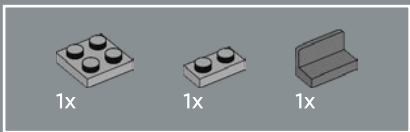

139

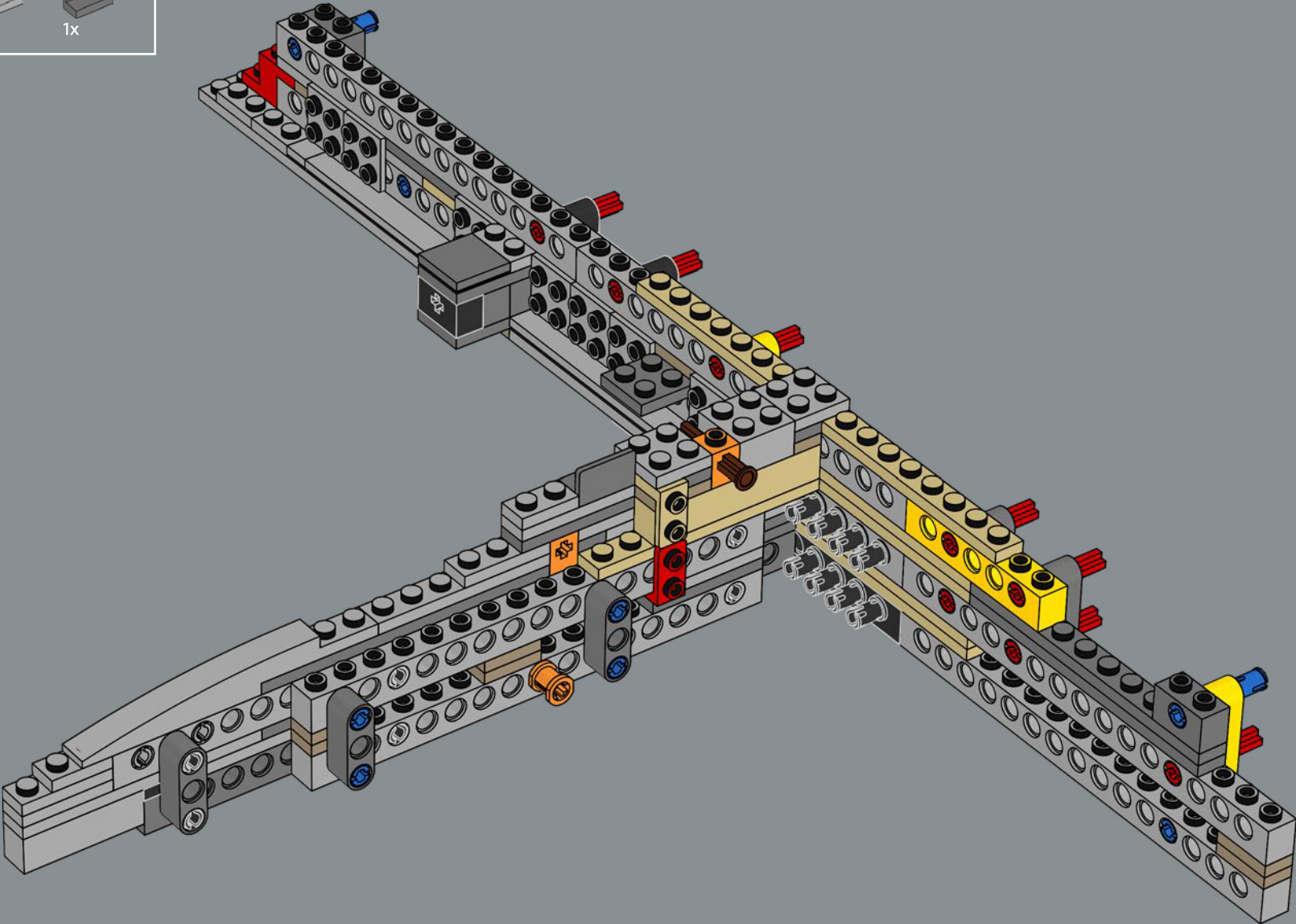



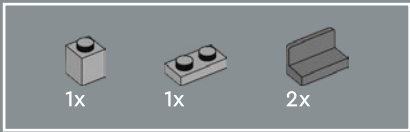

141

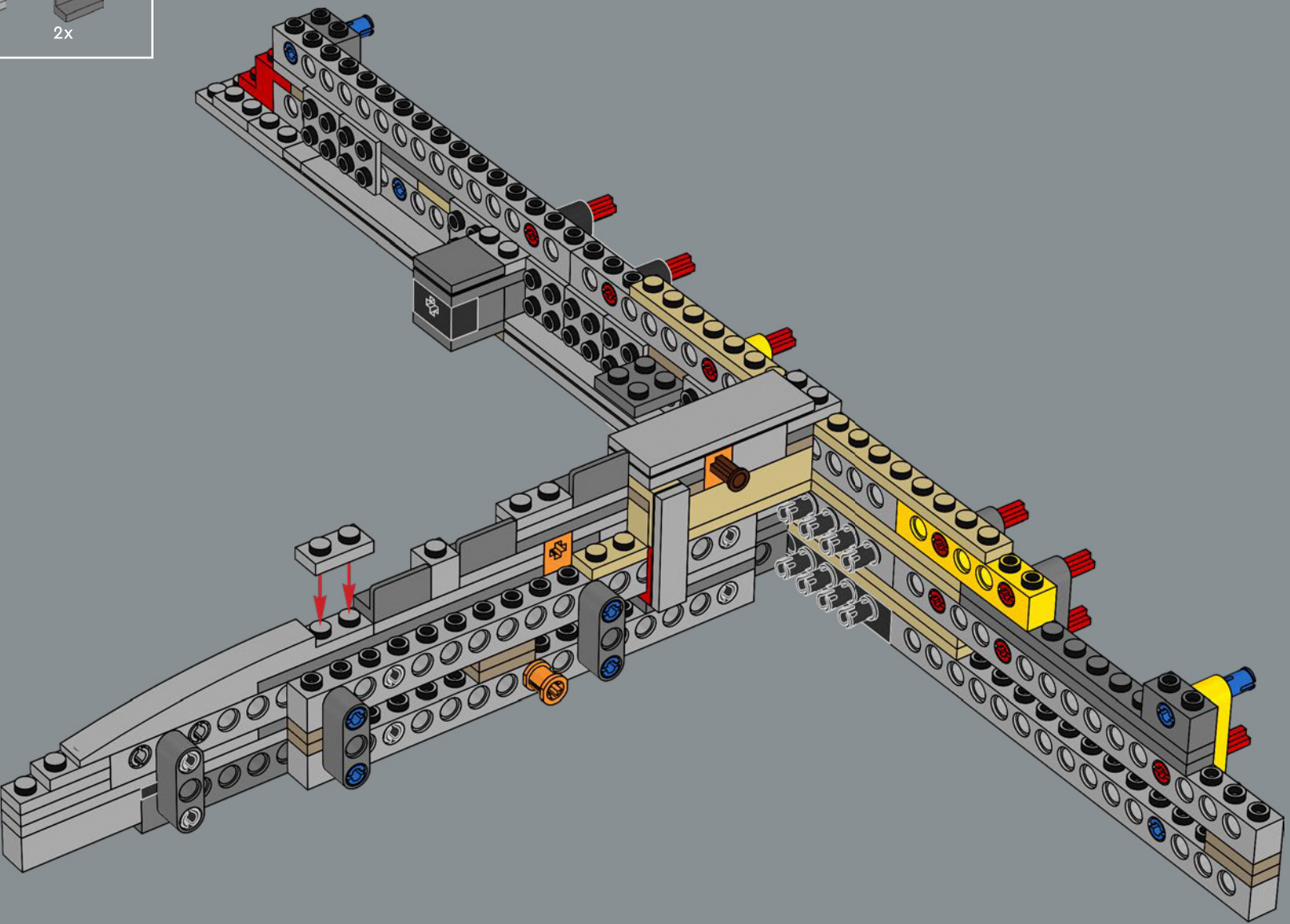

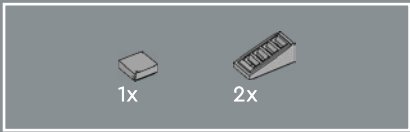

142

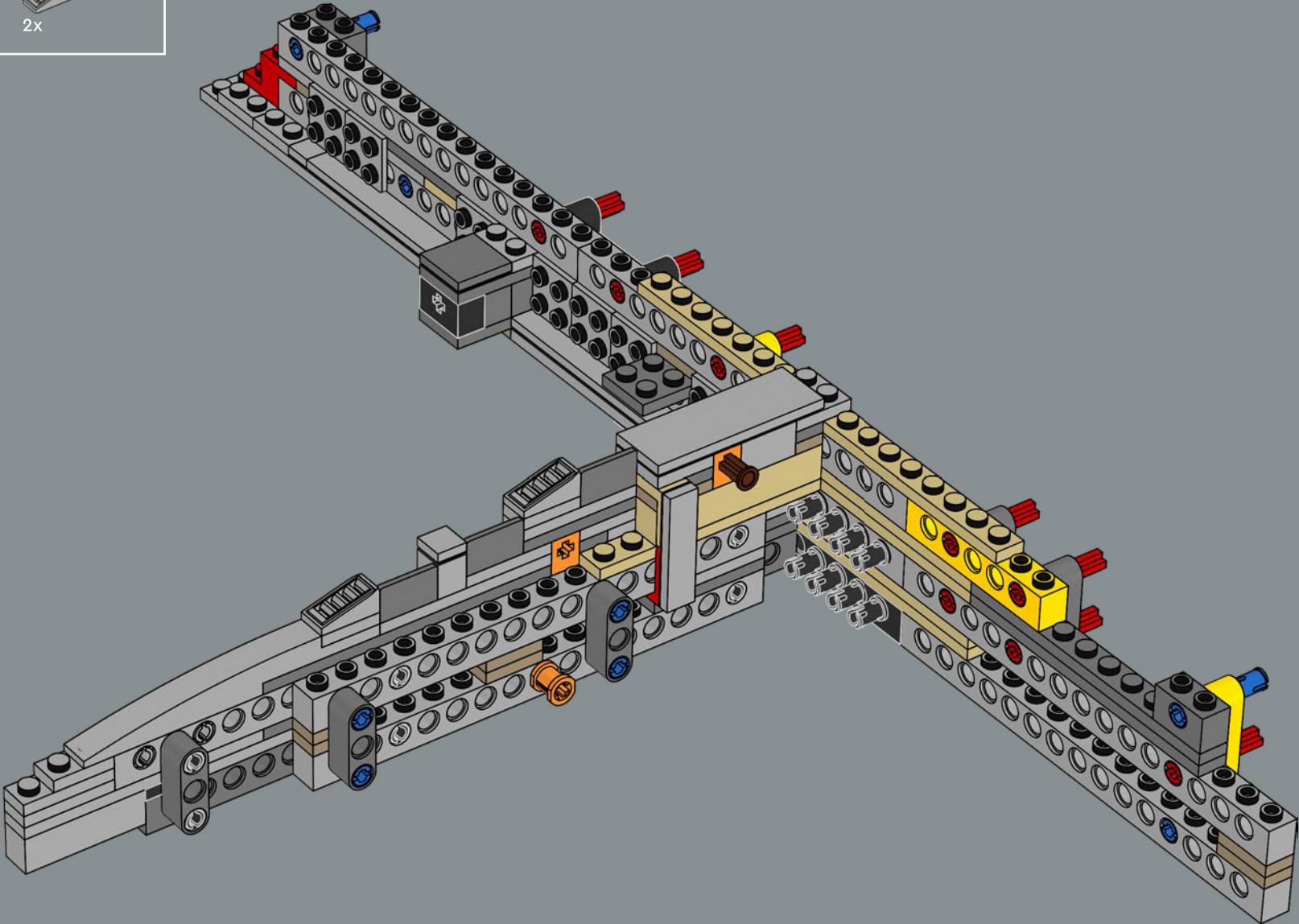

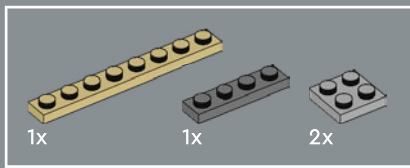

143

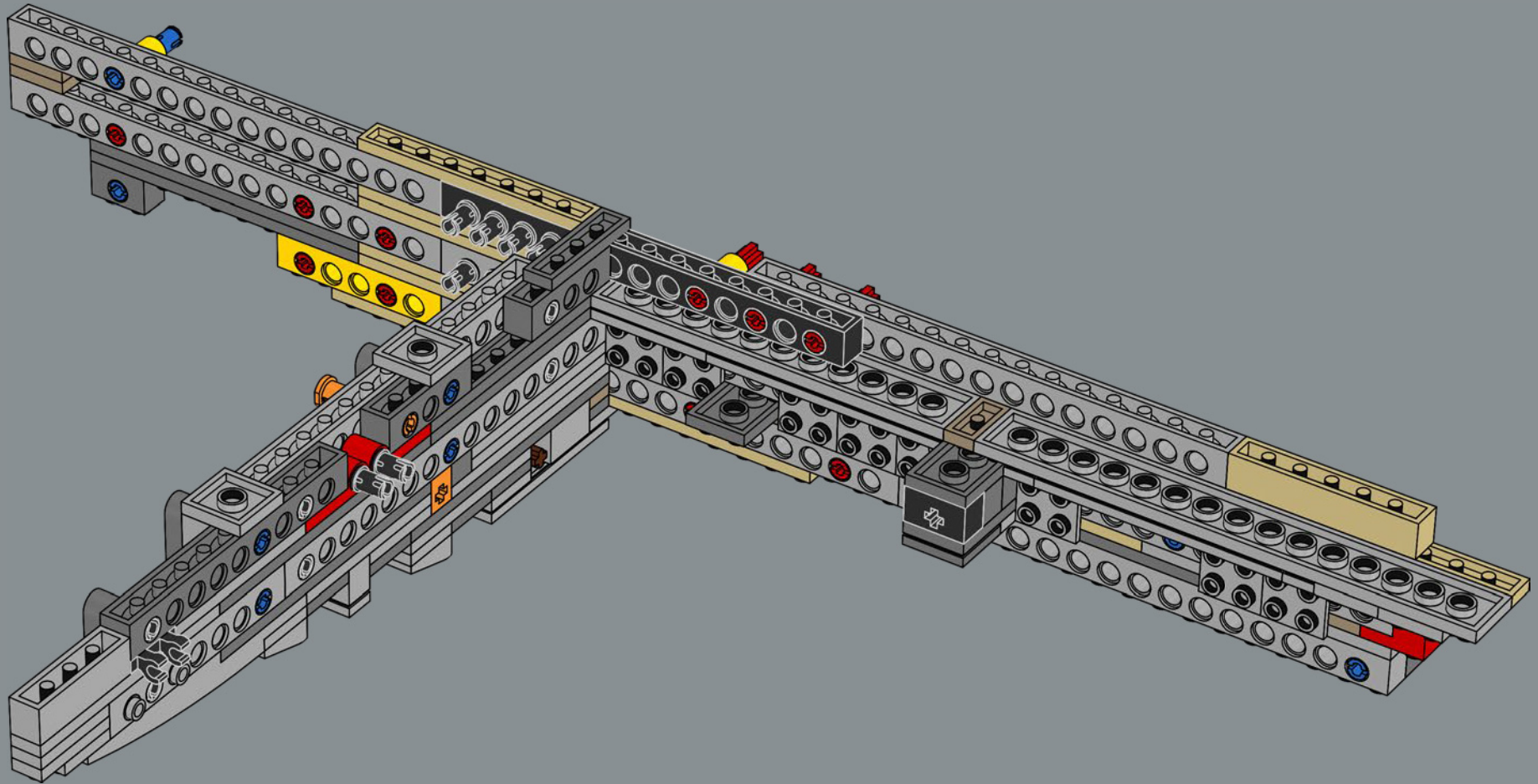

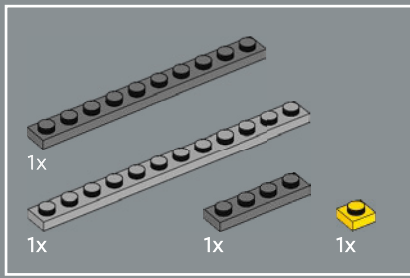

144

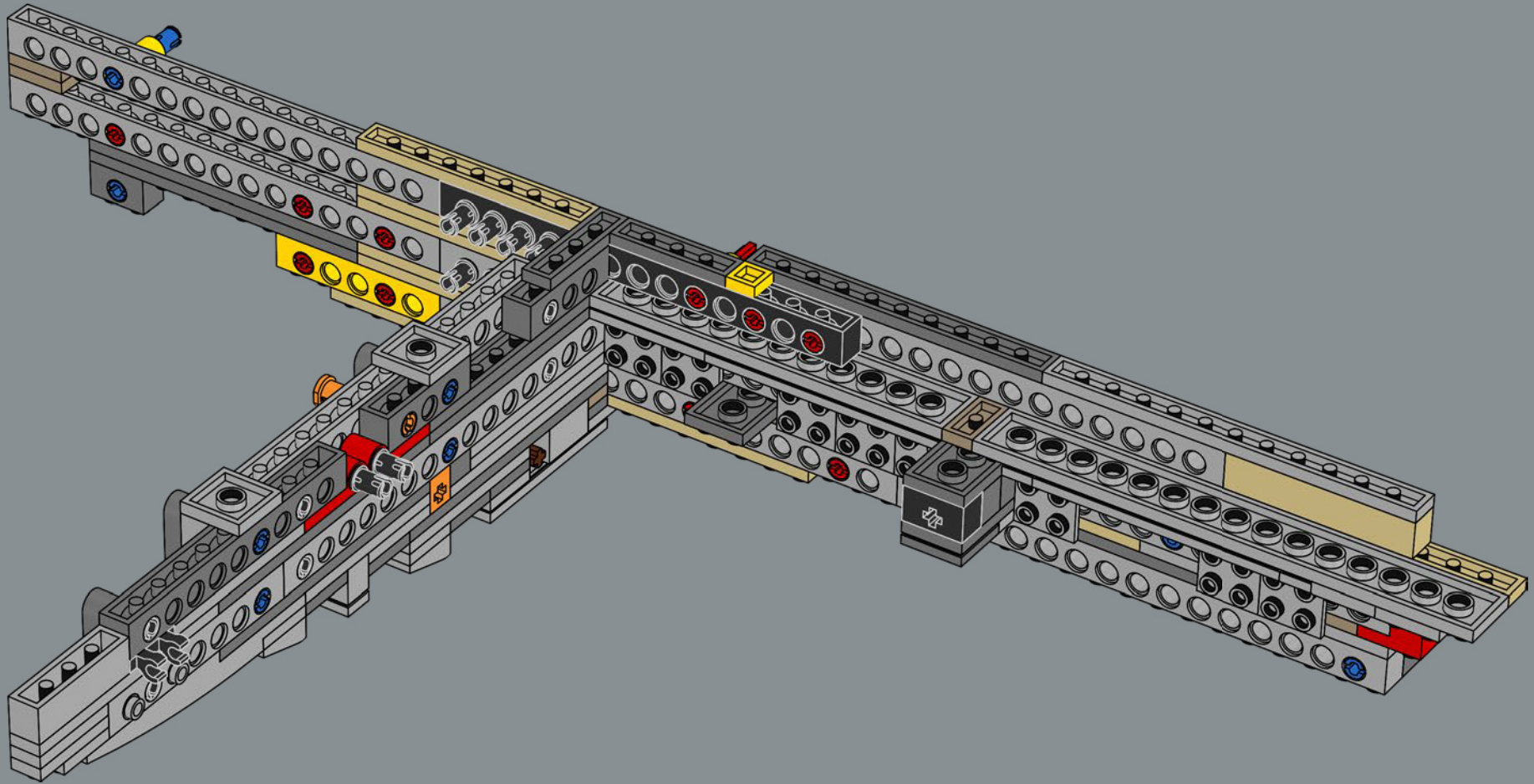

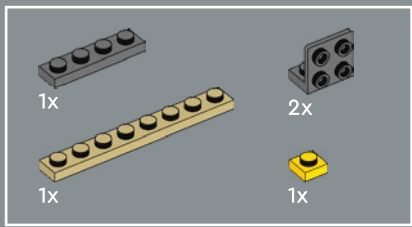

145

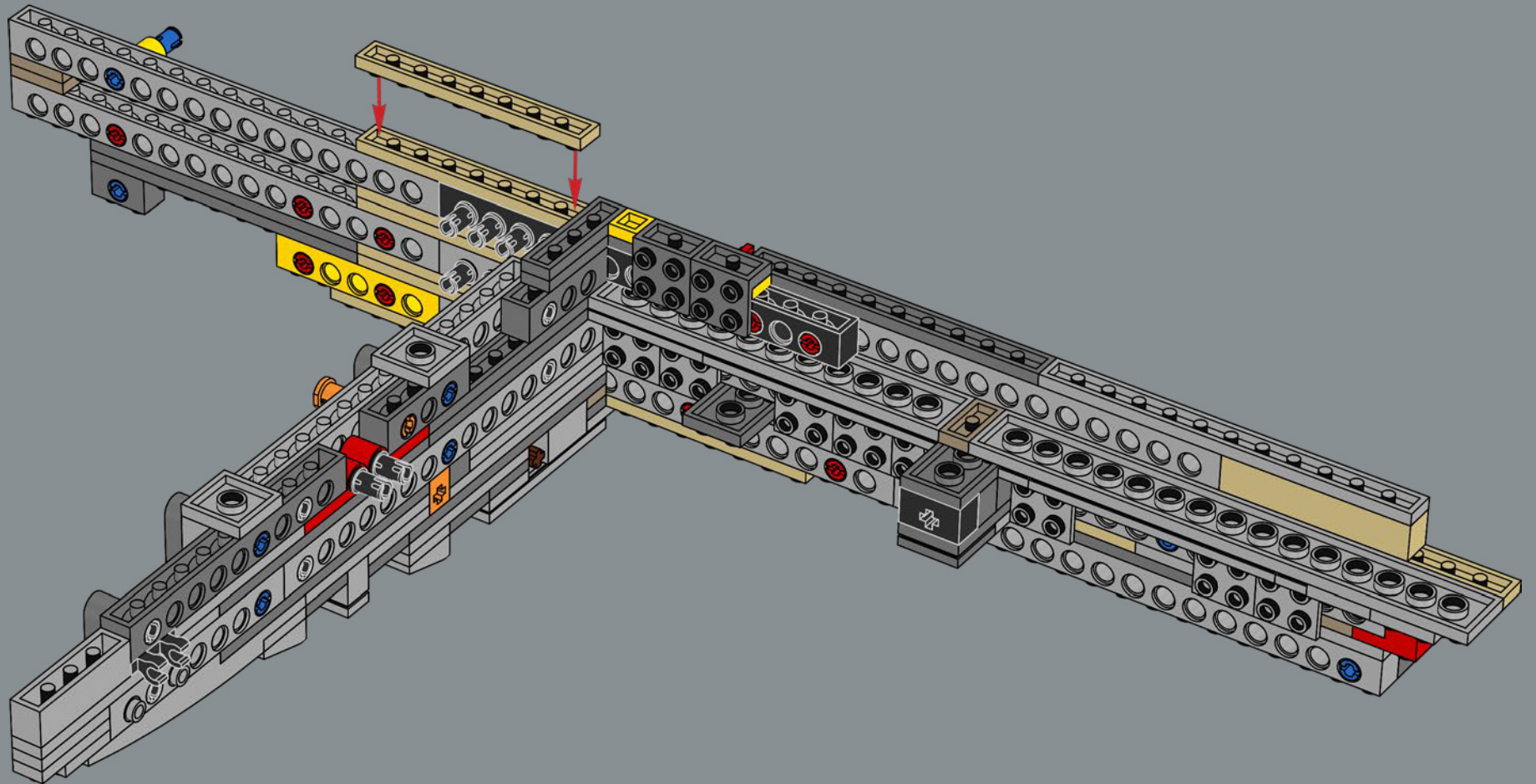



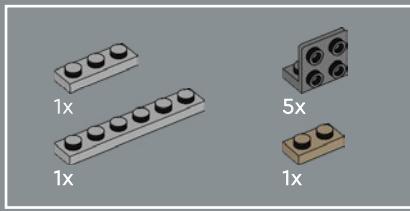

146

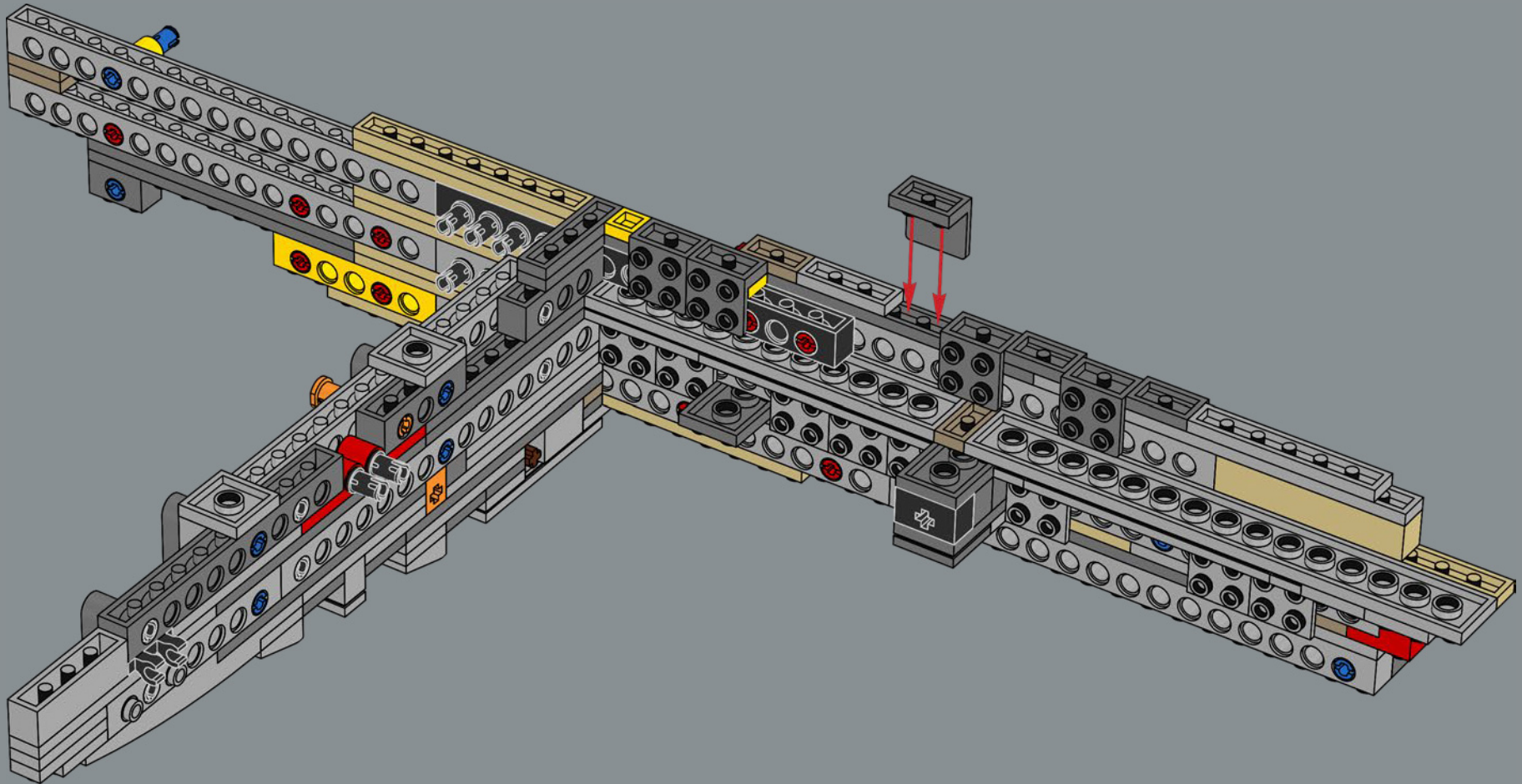

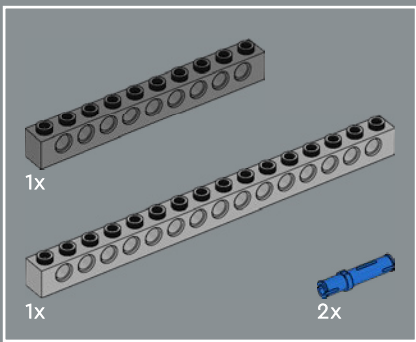

147

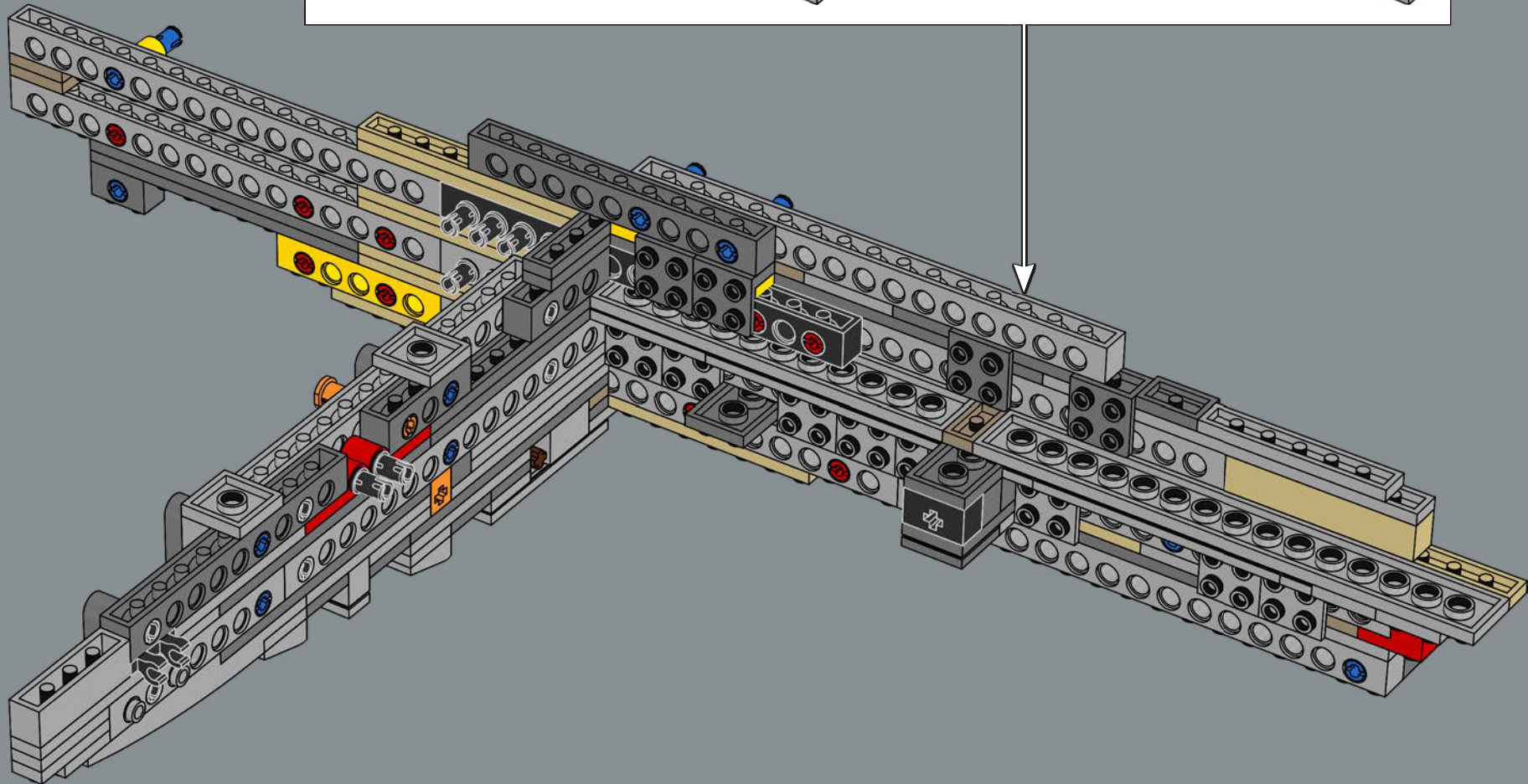
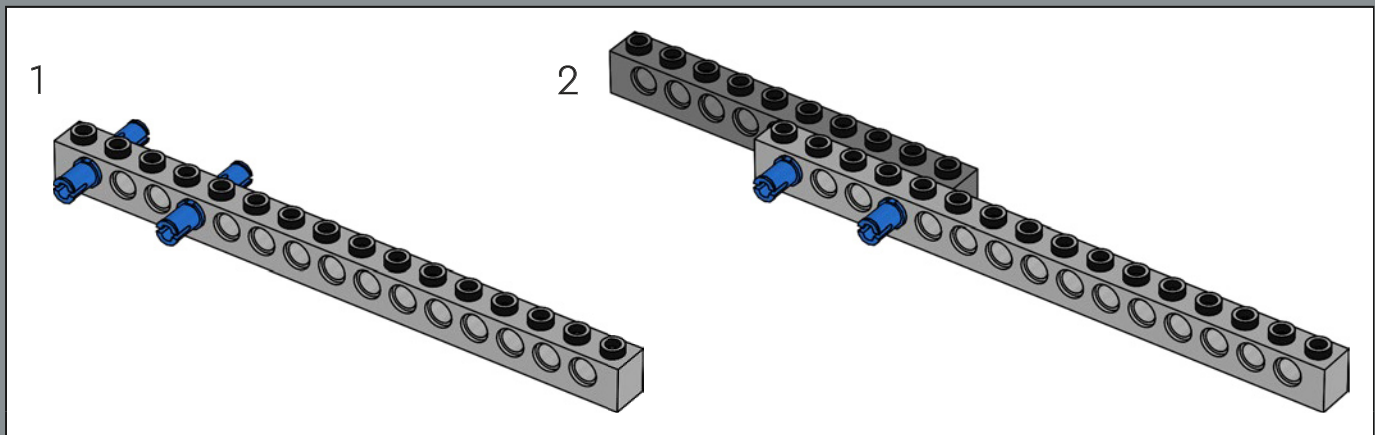

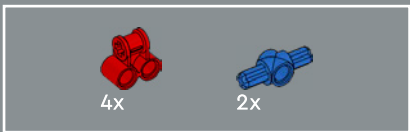

148

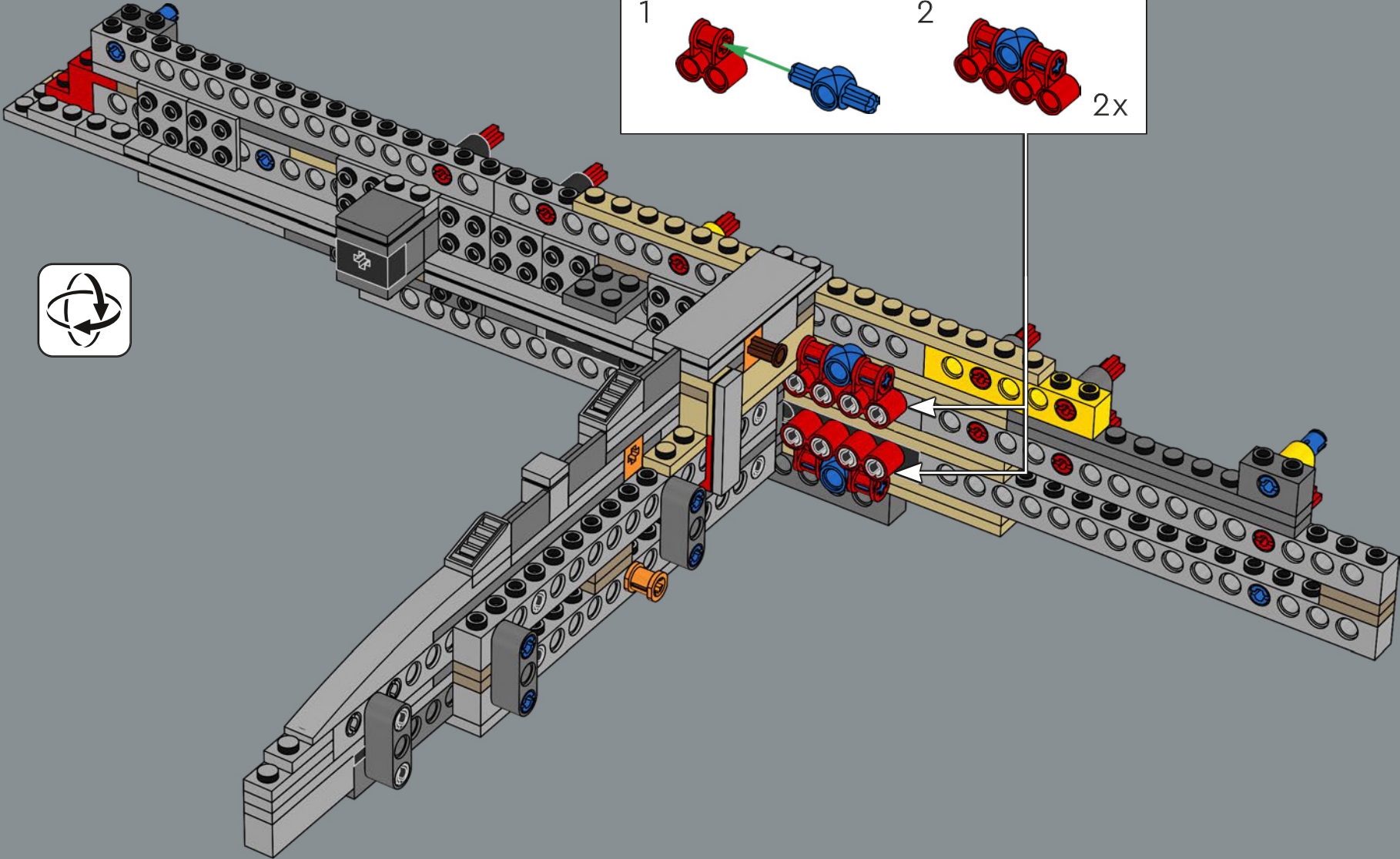
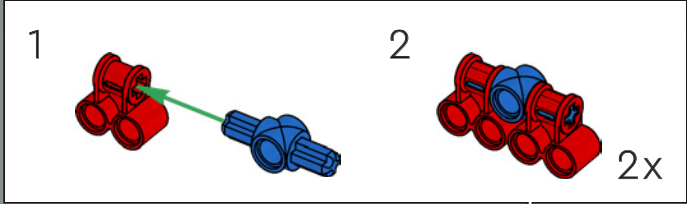

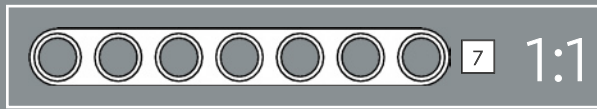
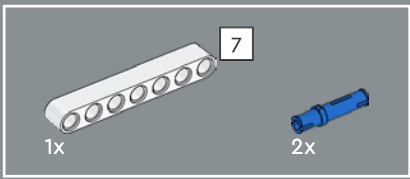

149

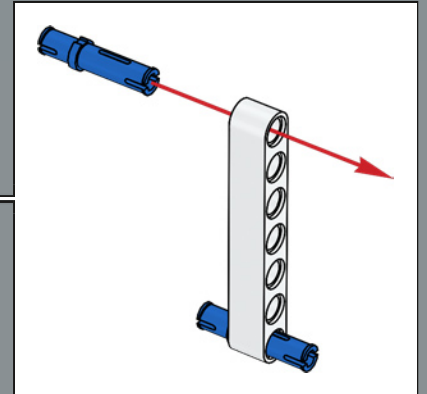
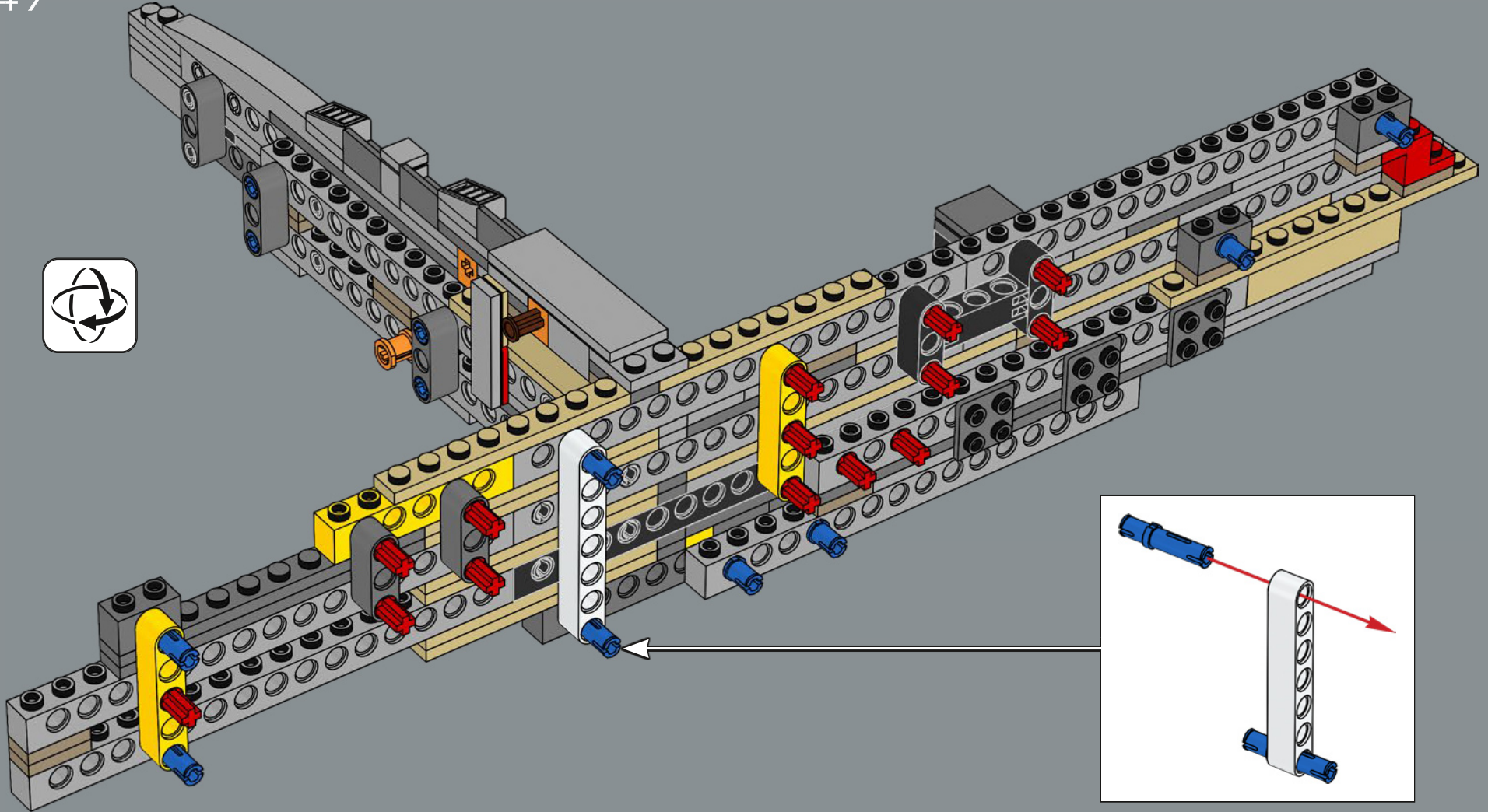

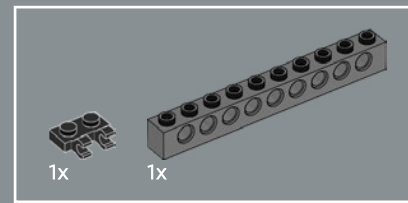
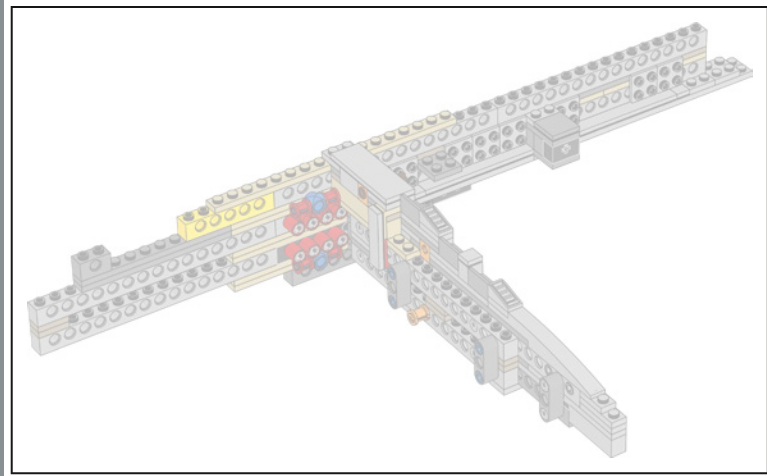

150

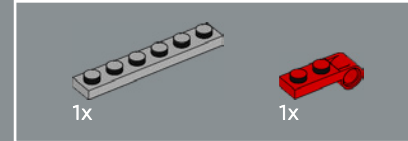
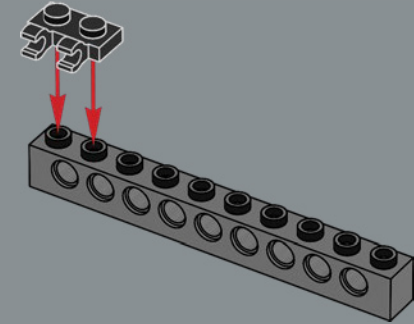

151

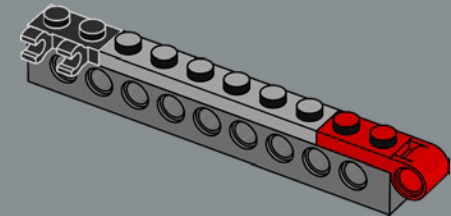

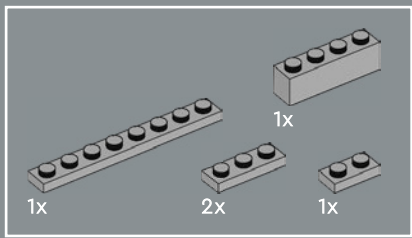

152

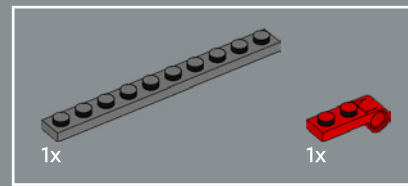
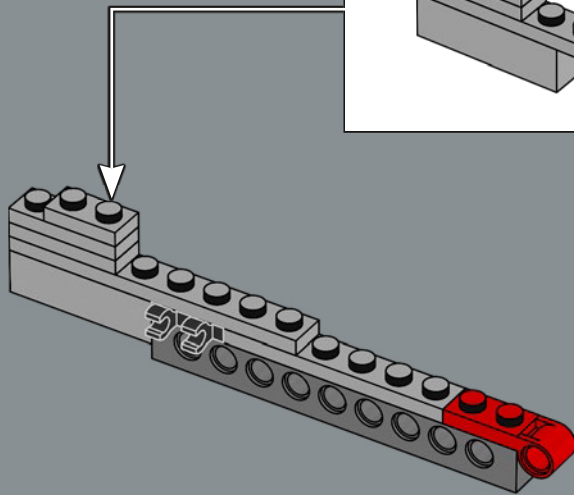
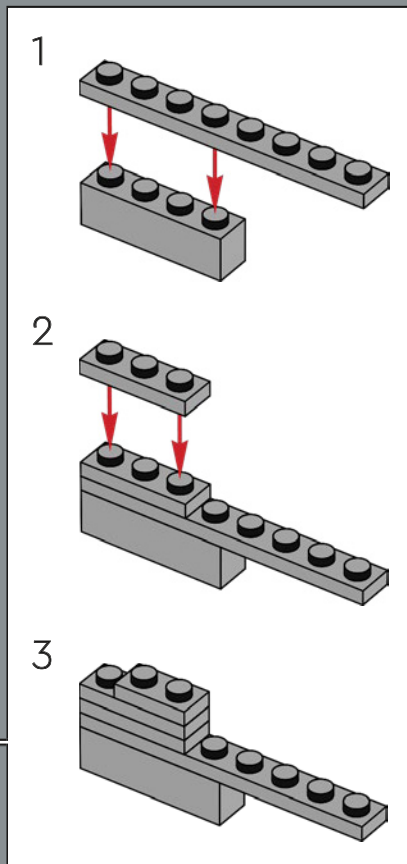

153

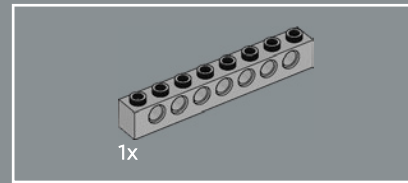
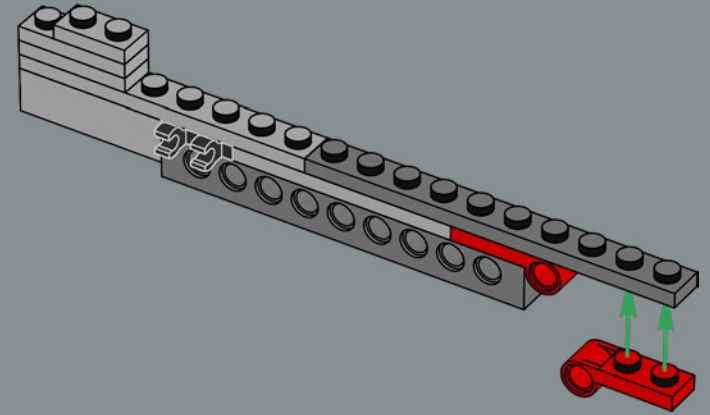

154

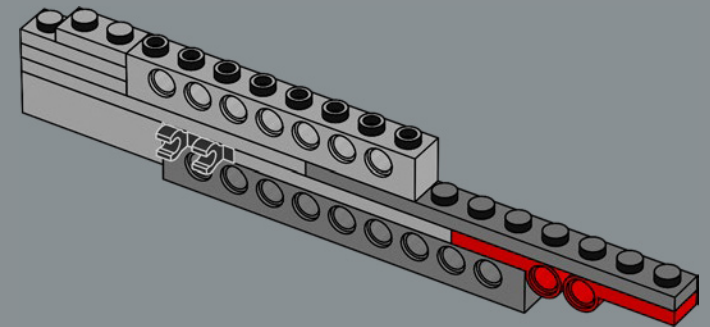



155

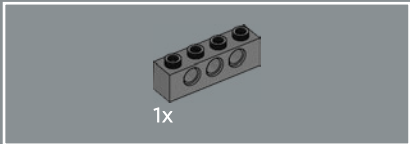
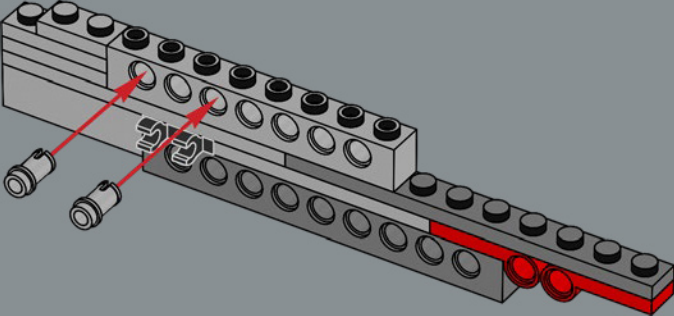

156

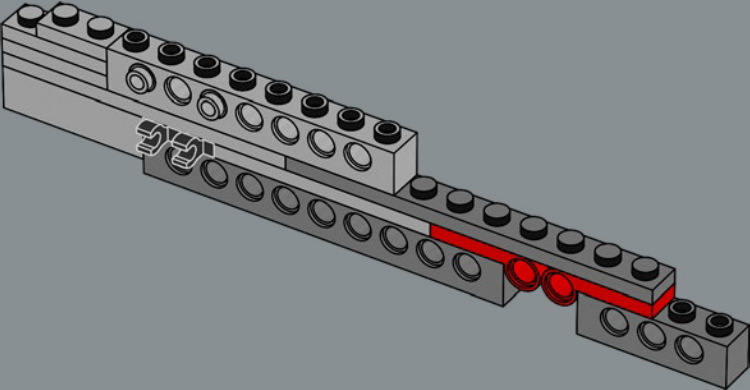

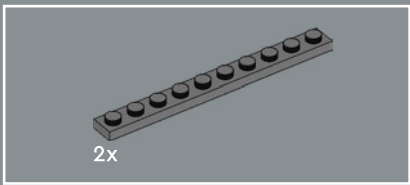

157

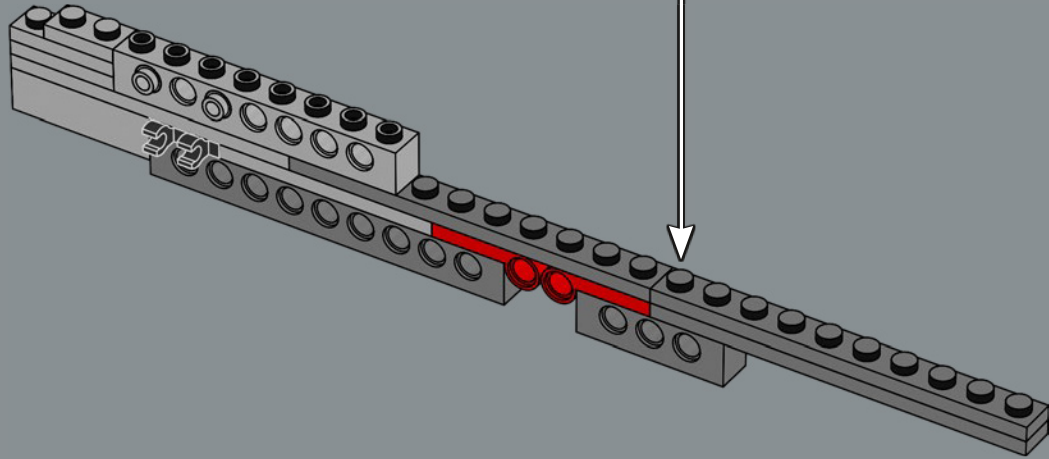
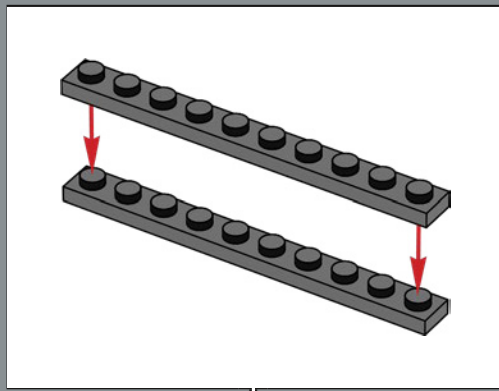



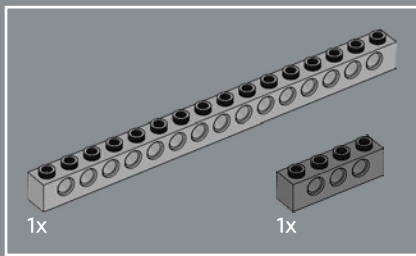

158

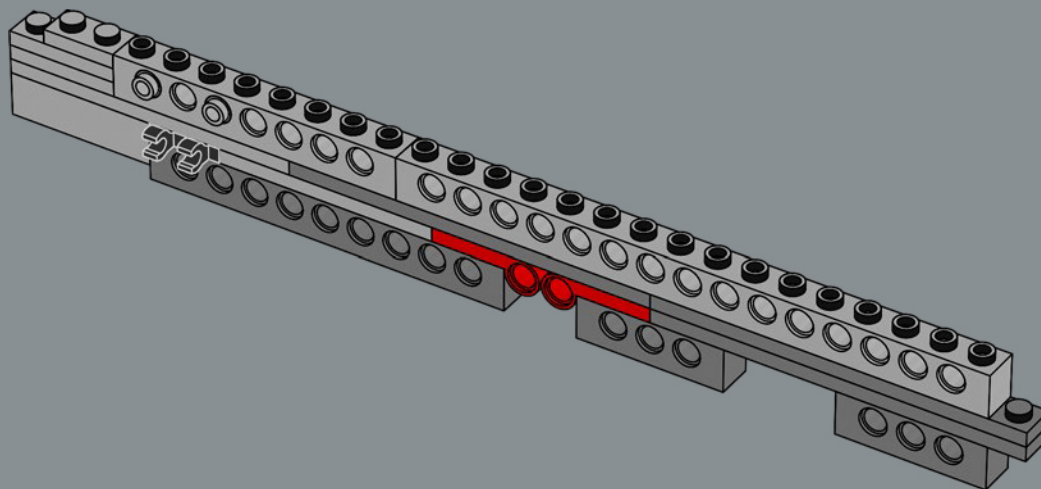

159

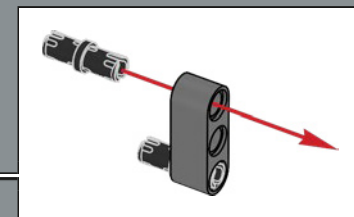
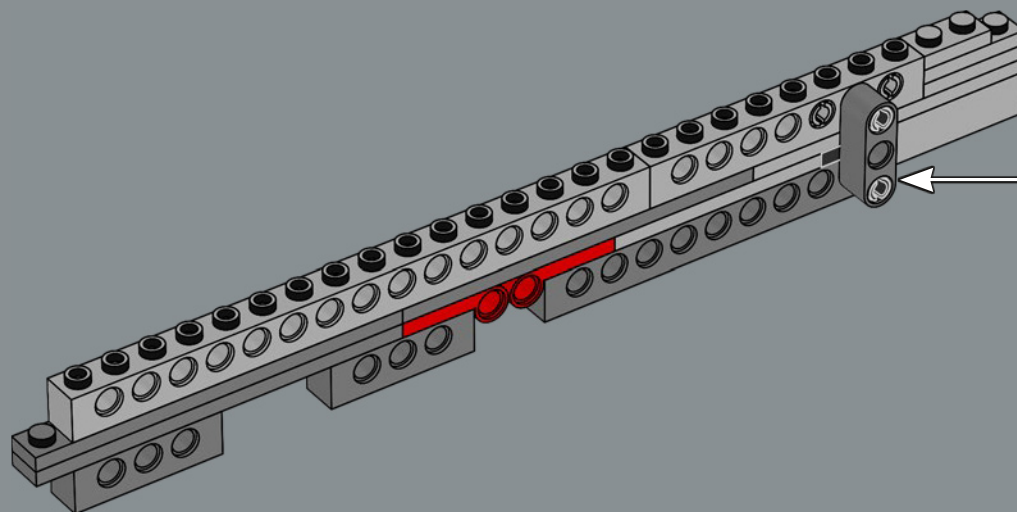





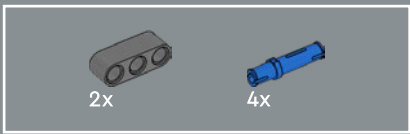

162

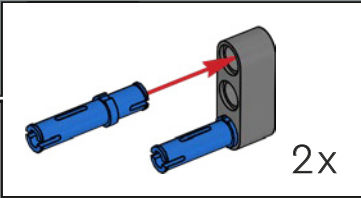
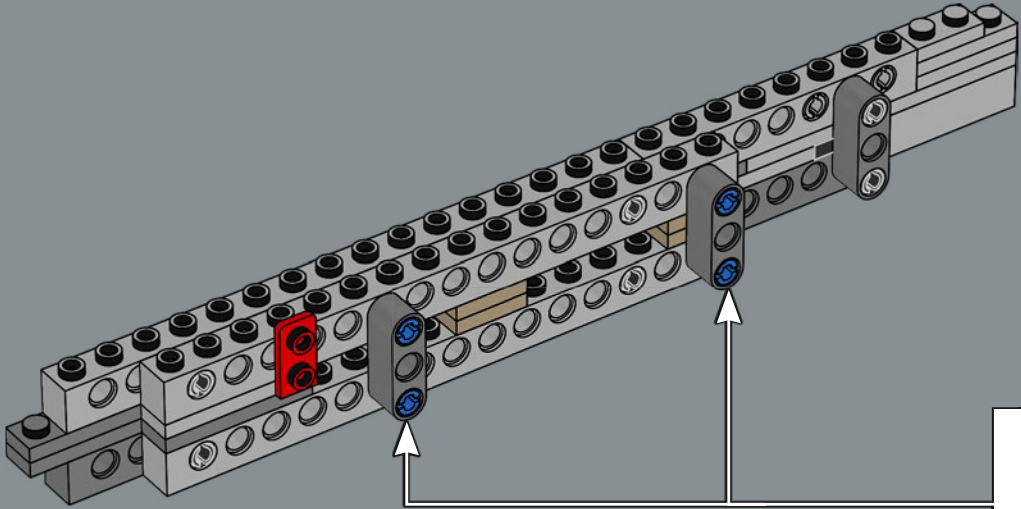

163

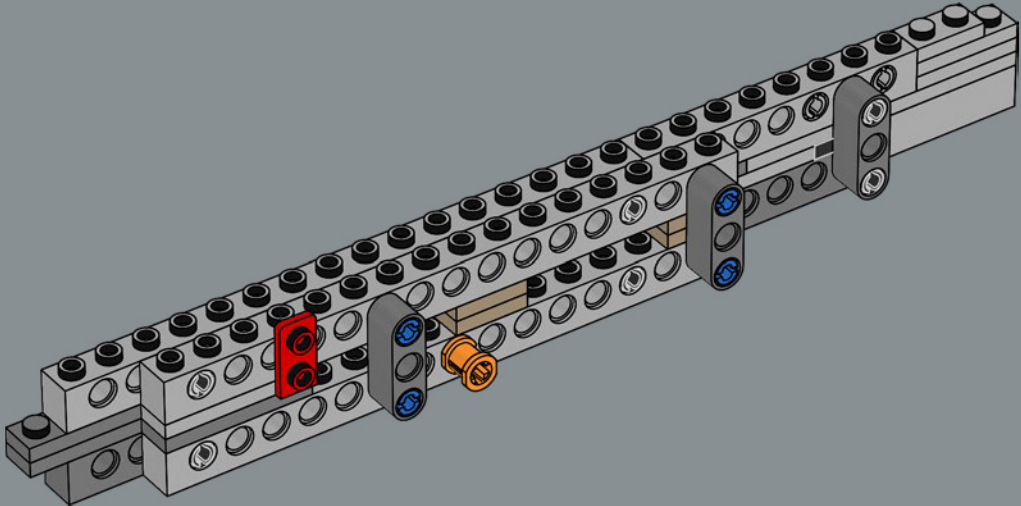



164

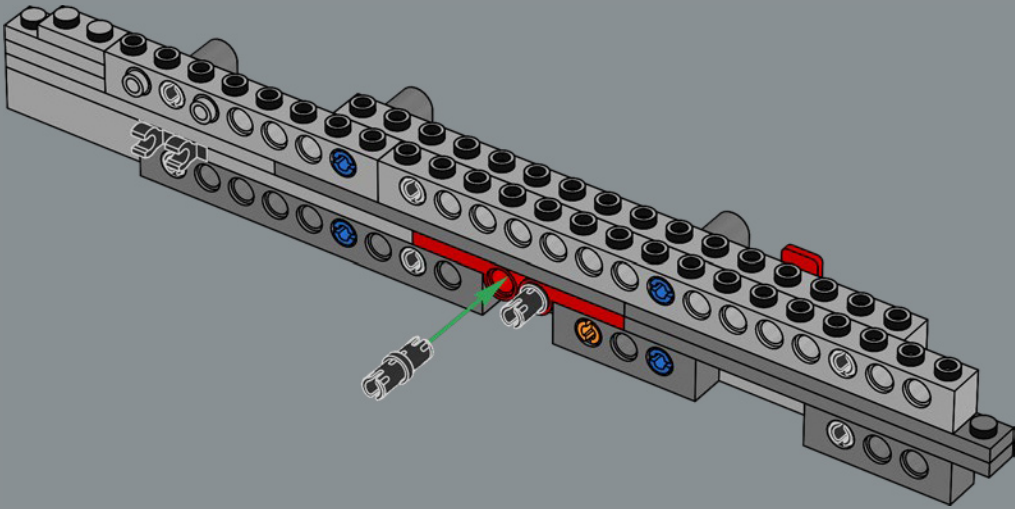

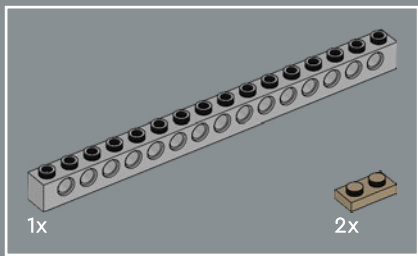

165

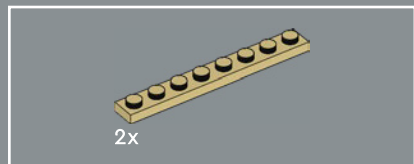
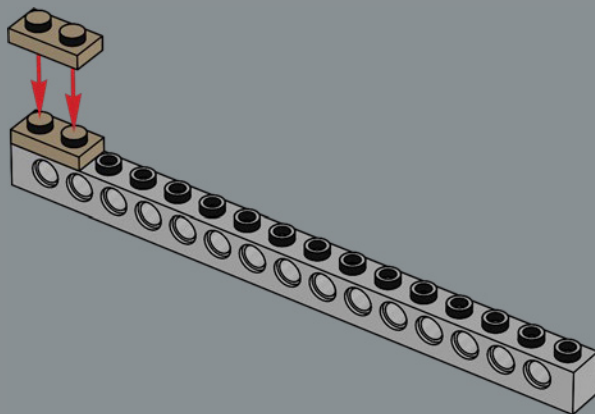

166

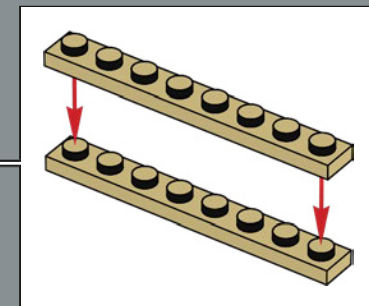
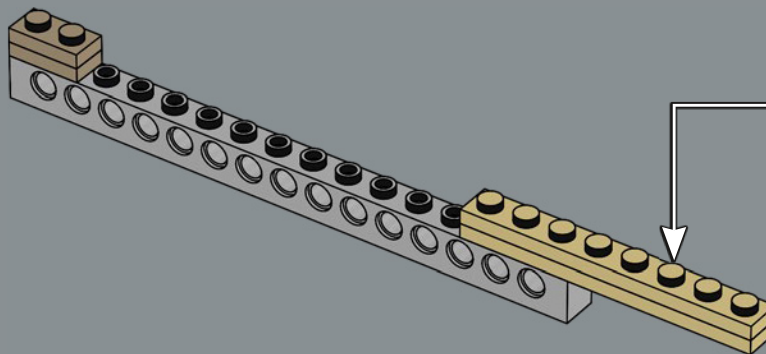

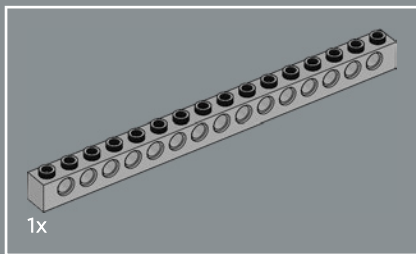

167

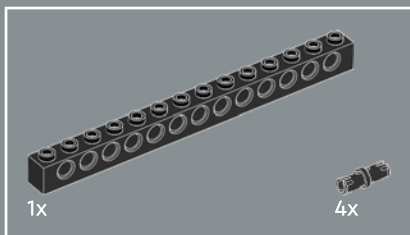
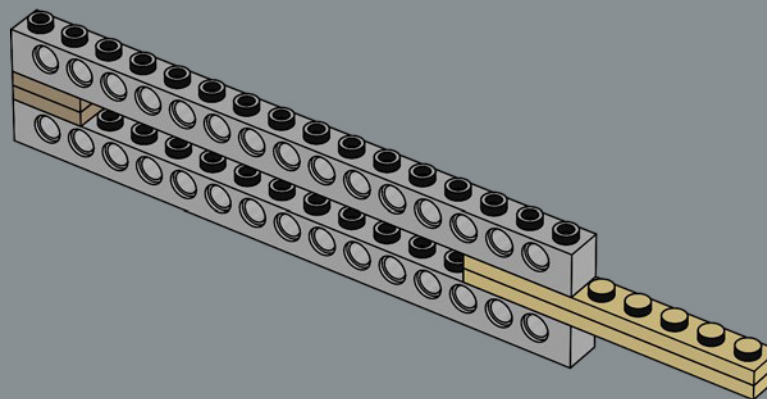

168

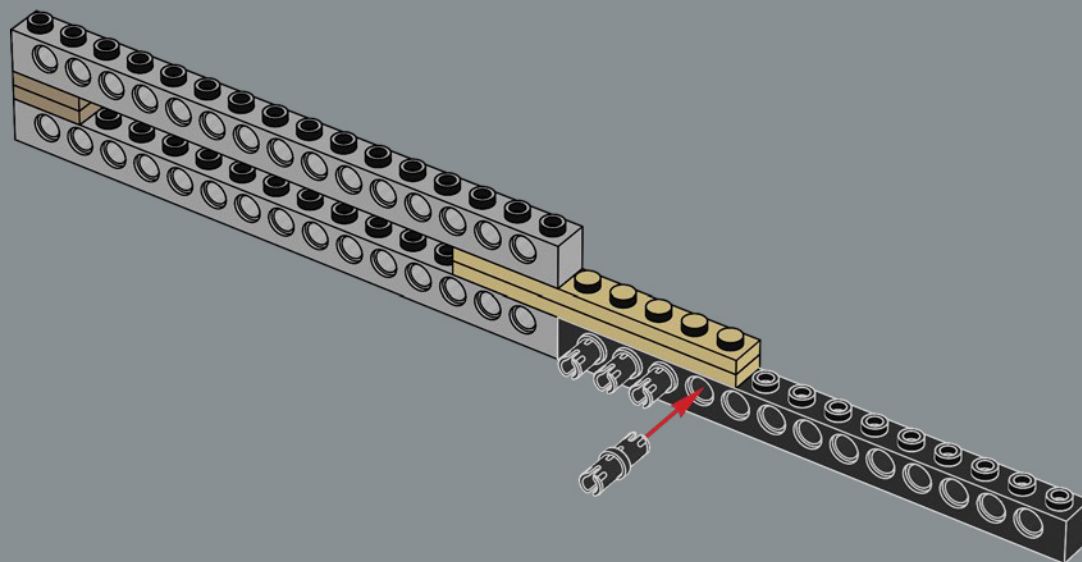

169

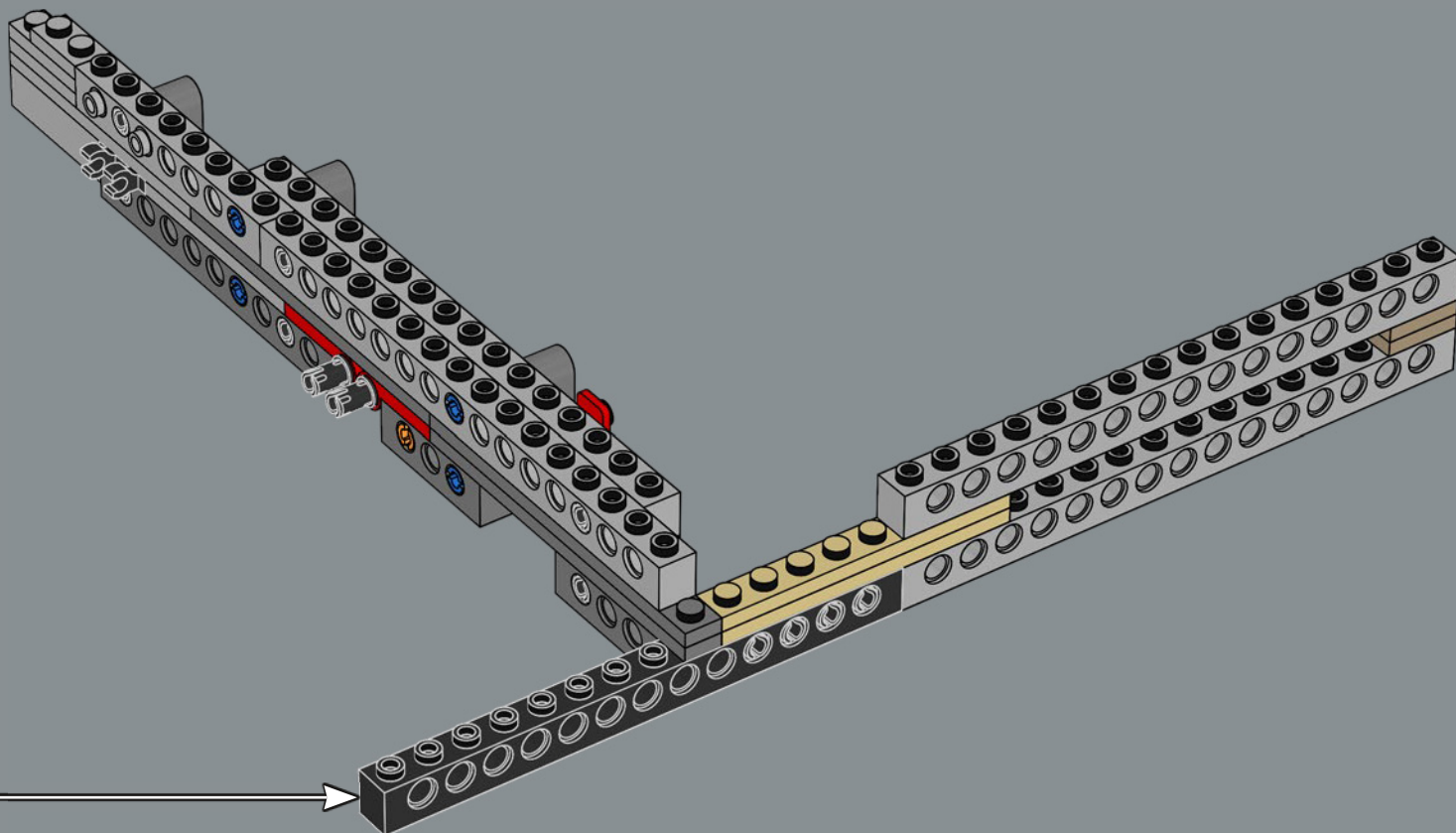



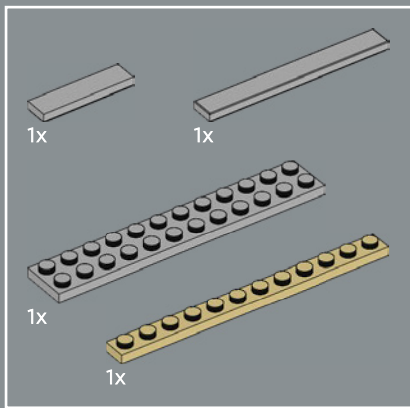

170

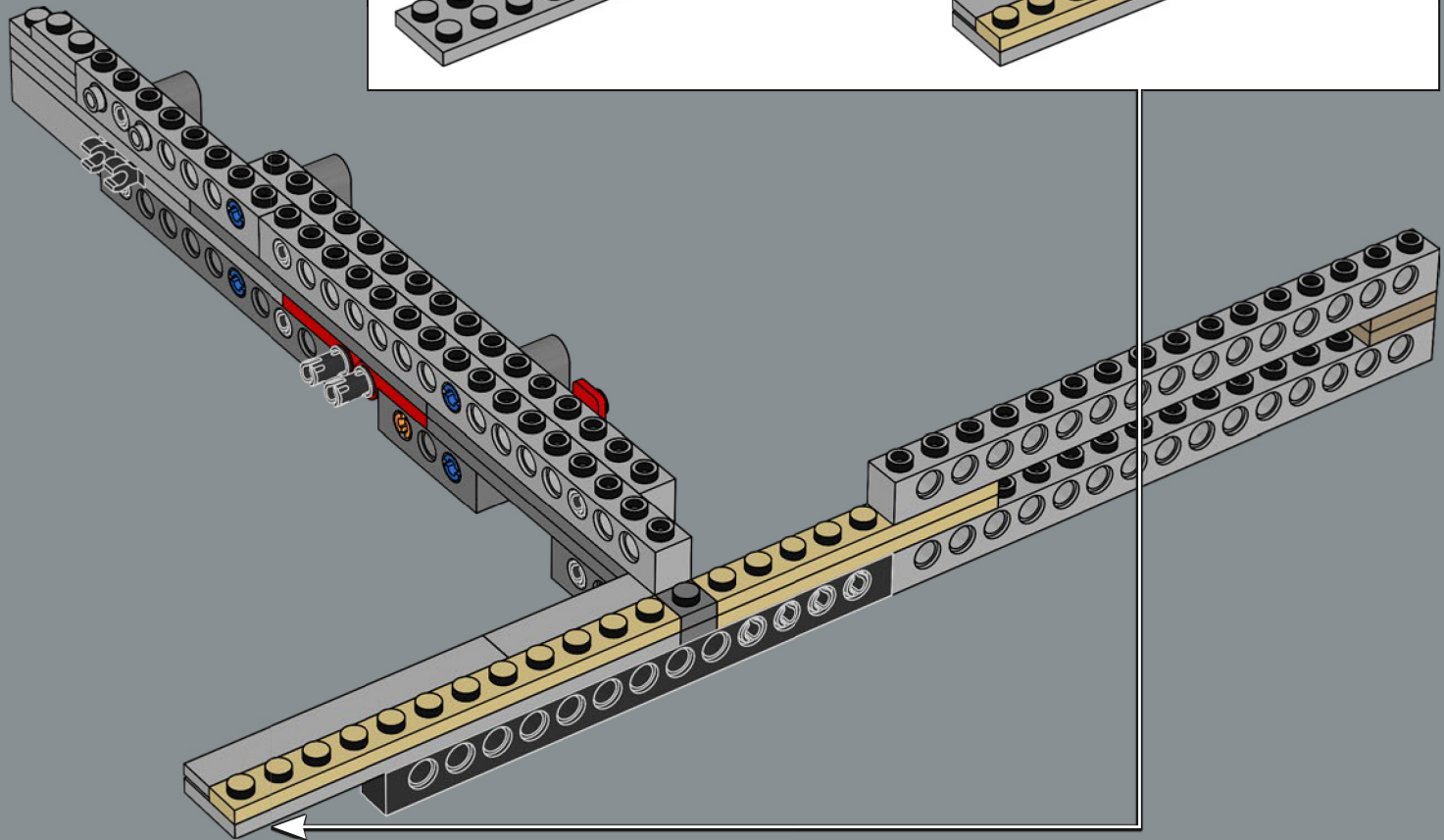
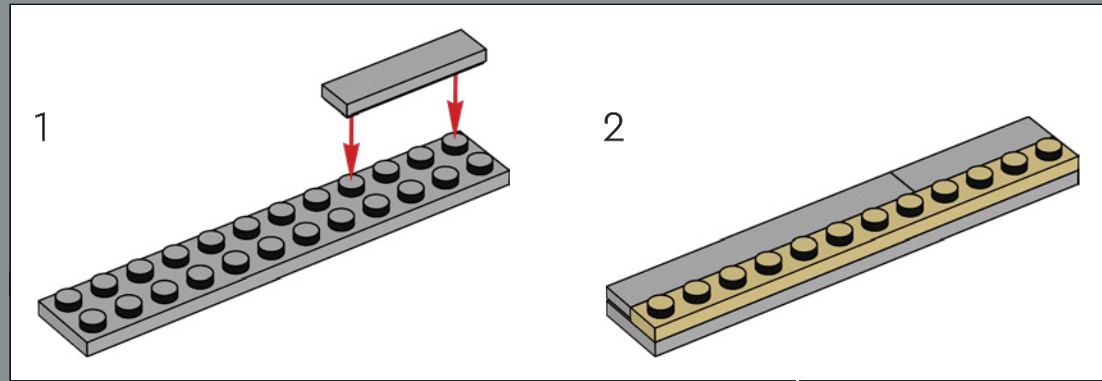

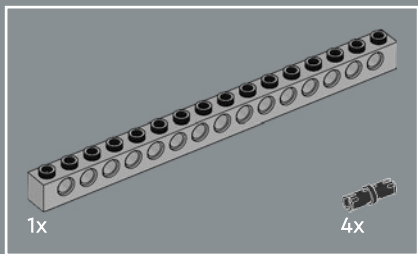

171

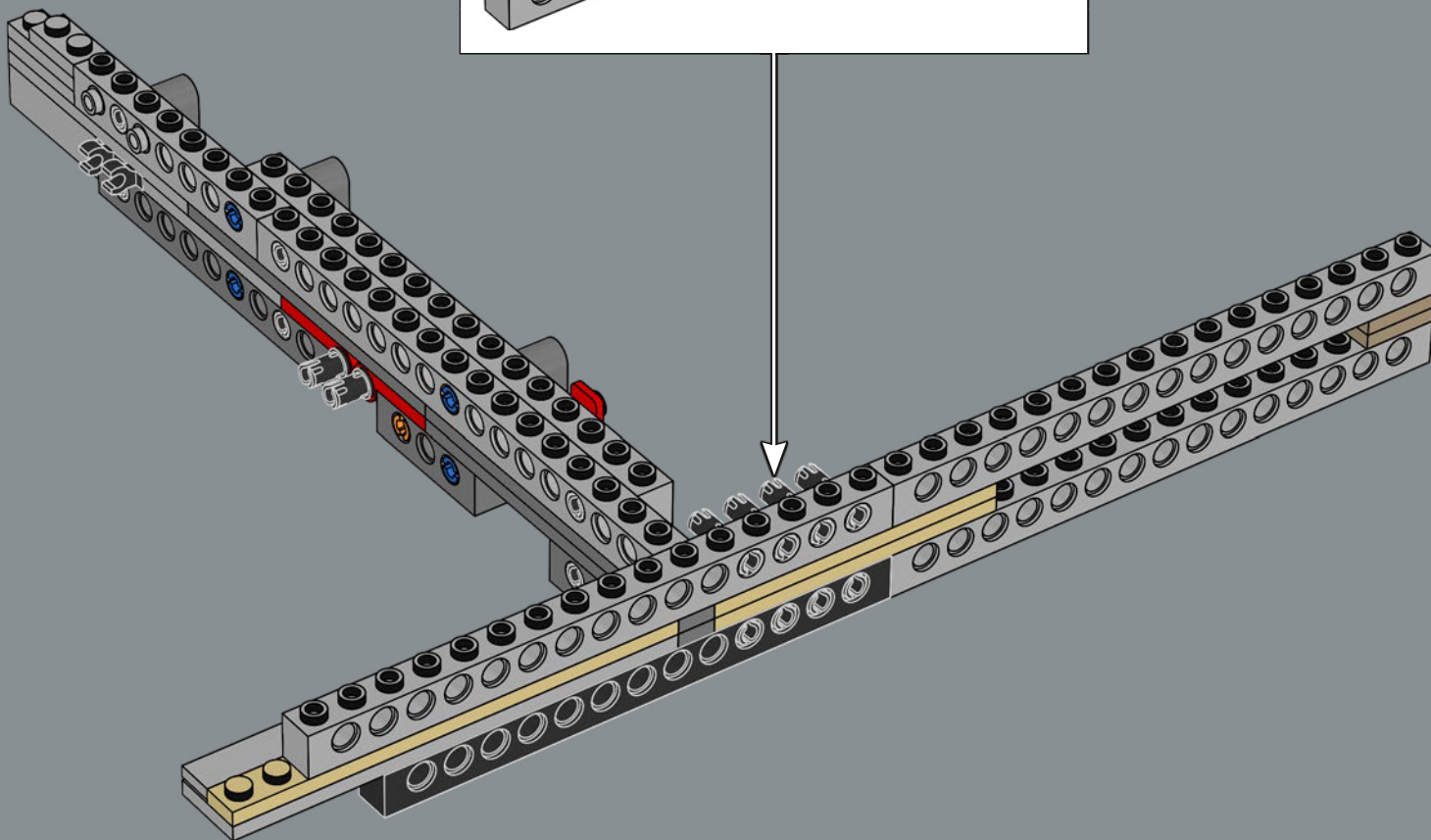
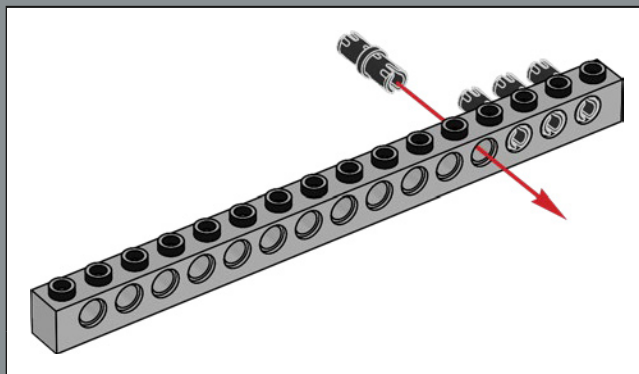

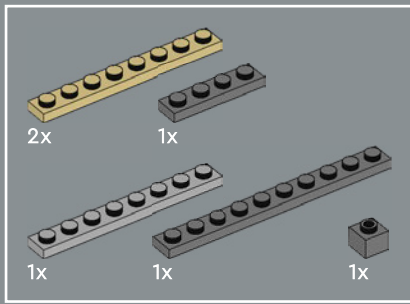

172

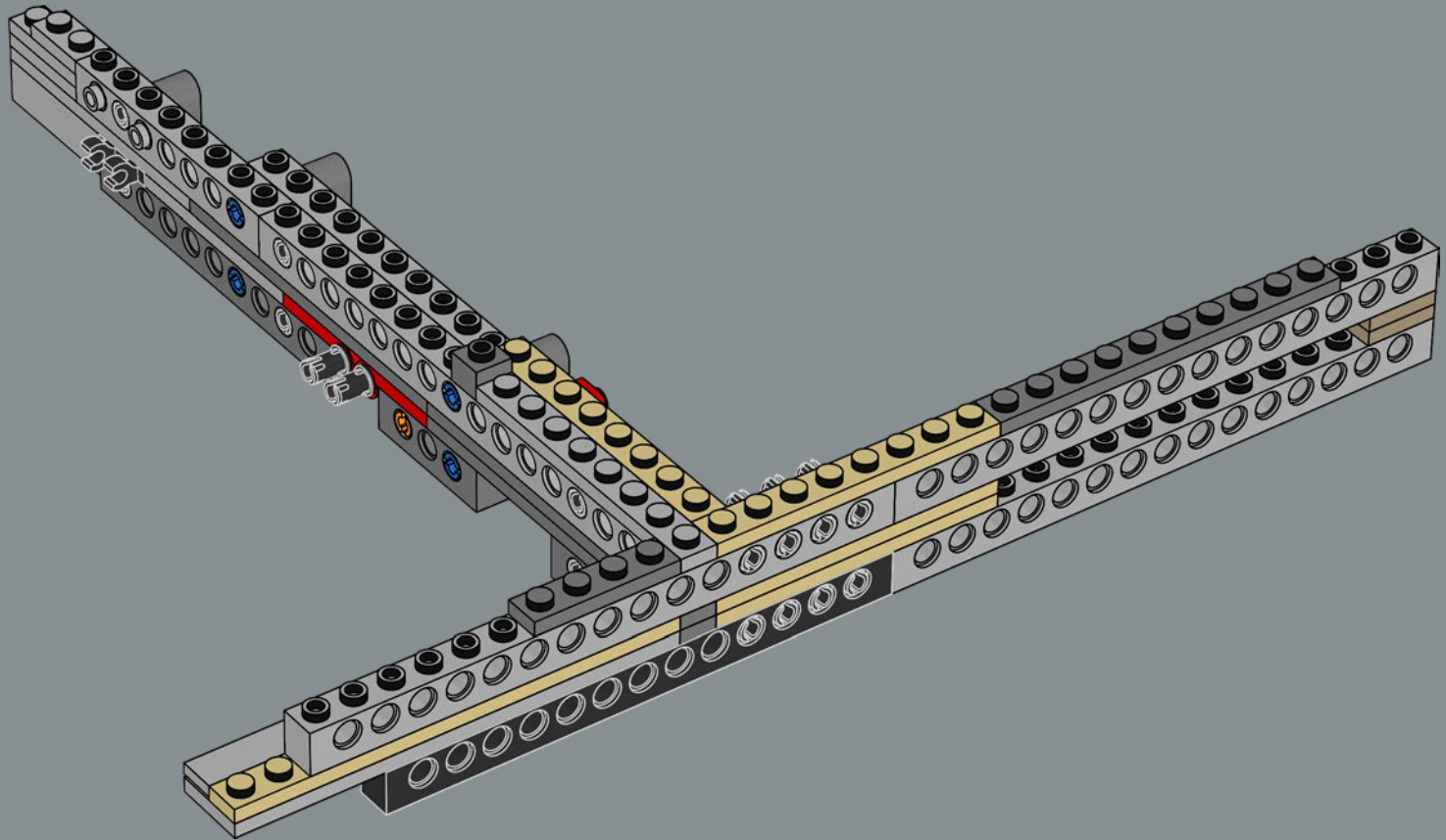

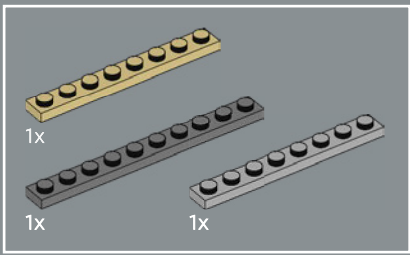

173

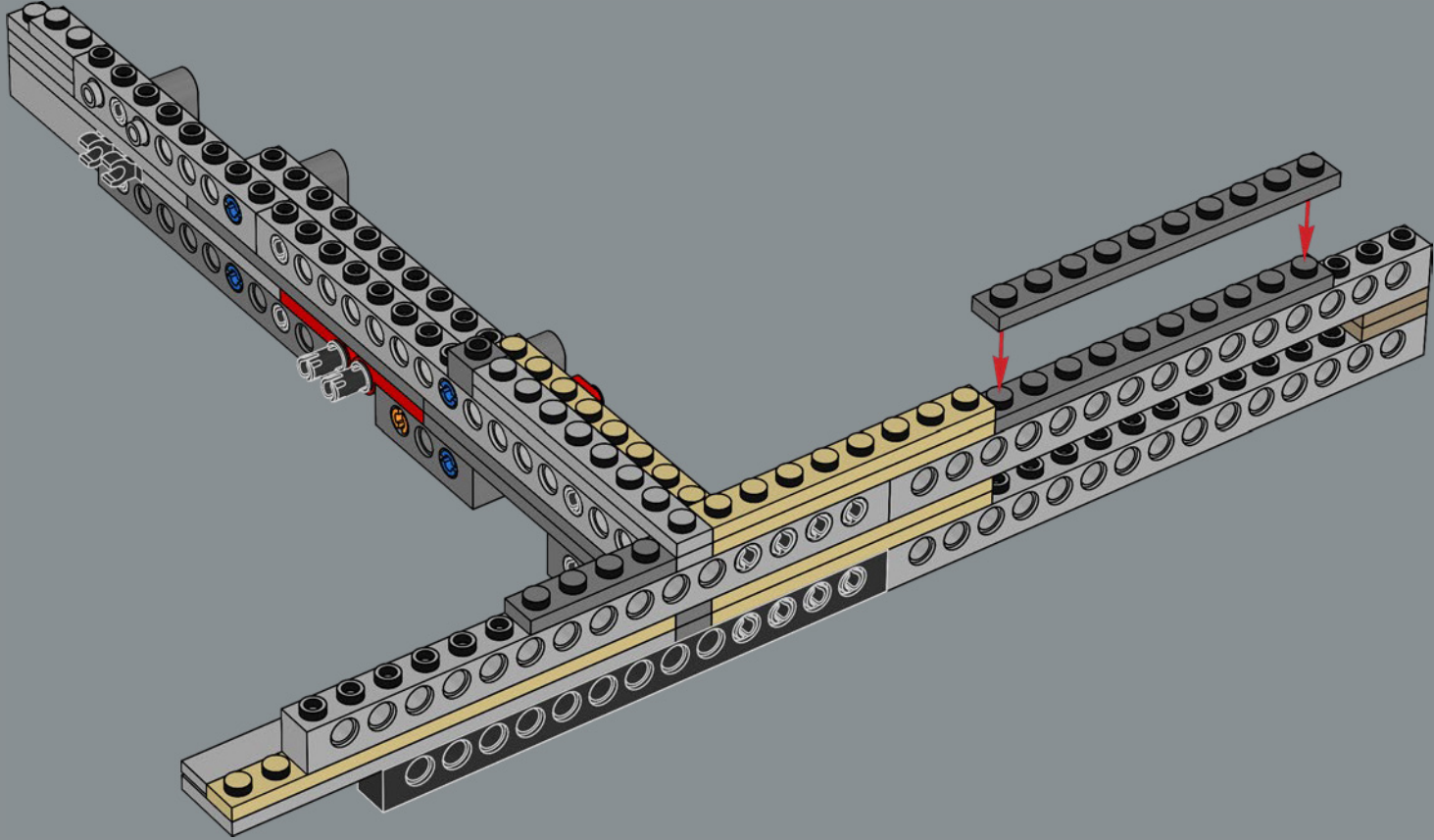

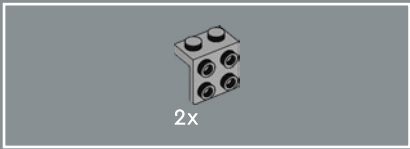

174

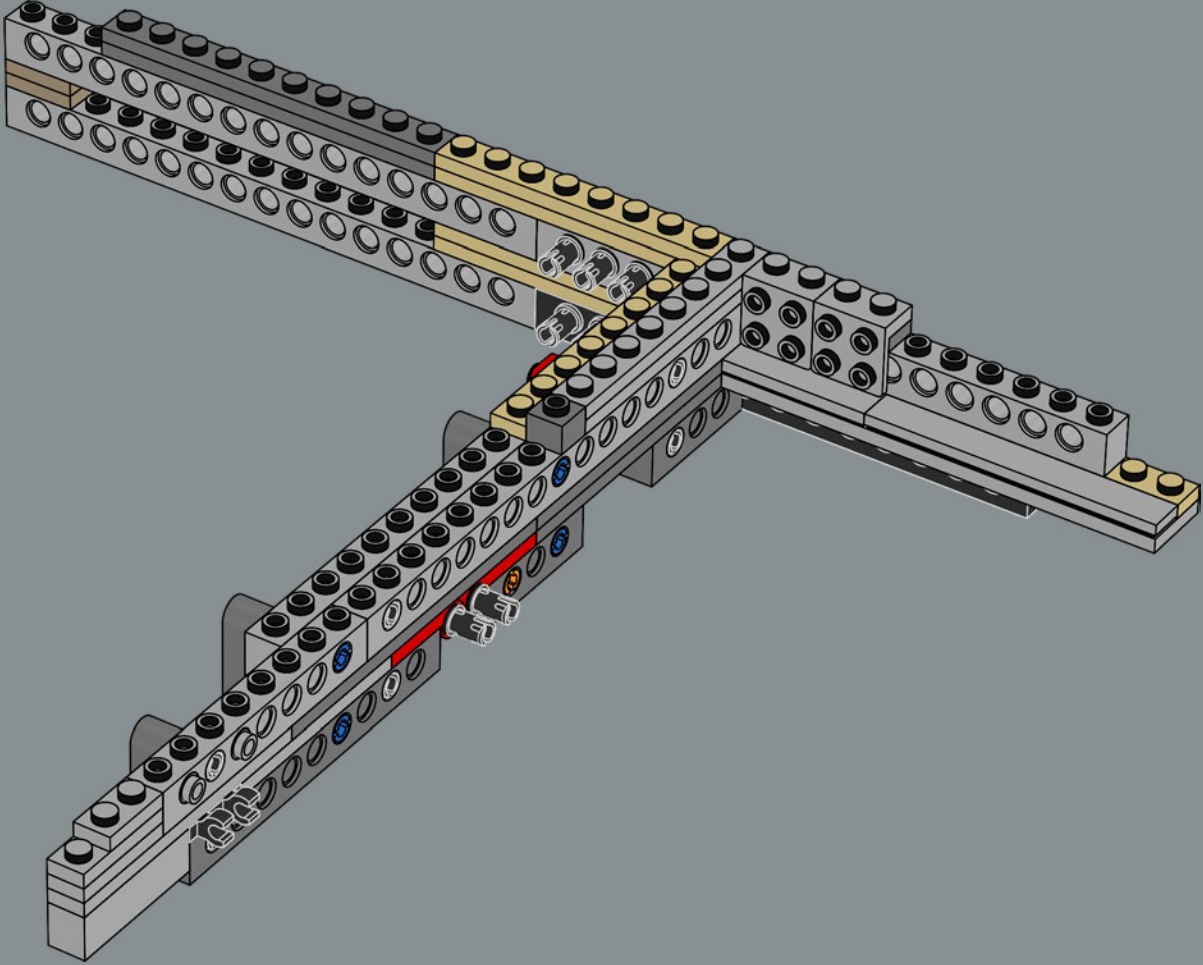

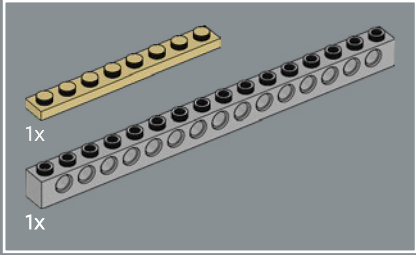
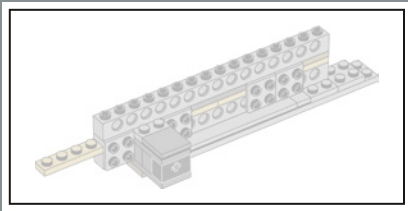

175

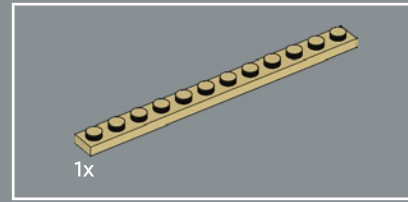
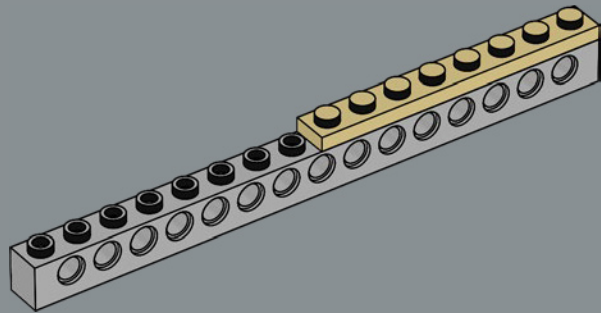

176

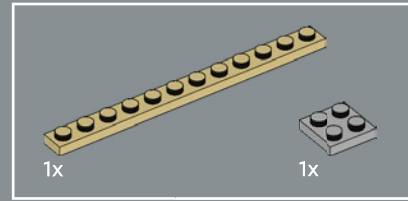
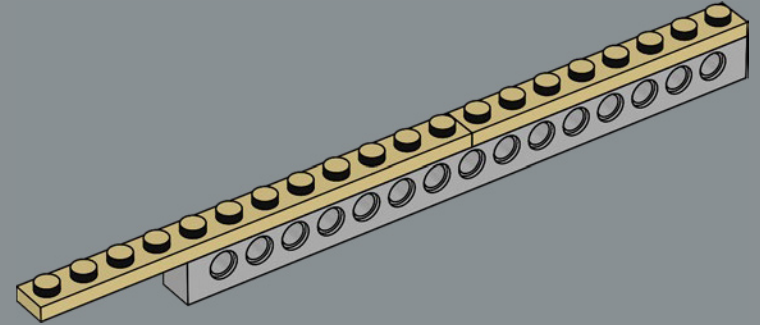

177

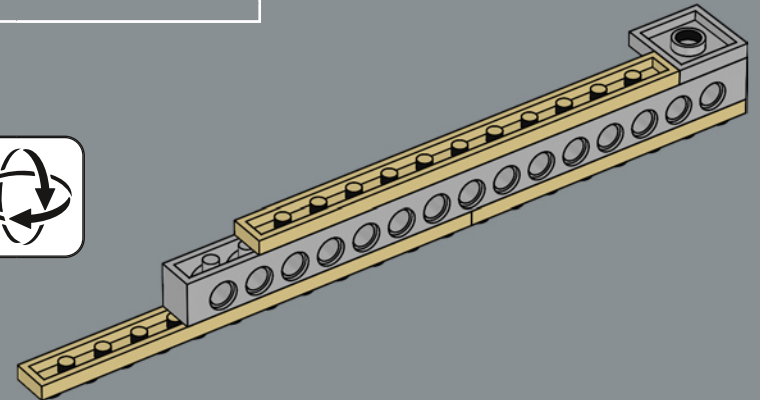

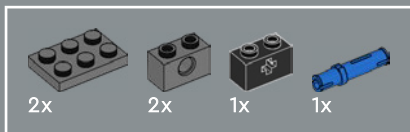

178

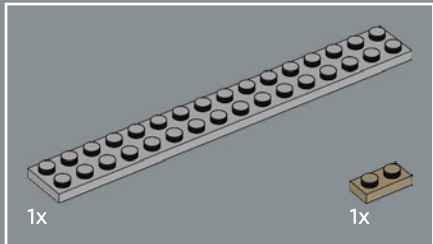
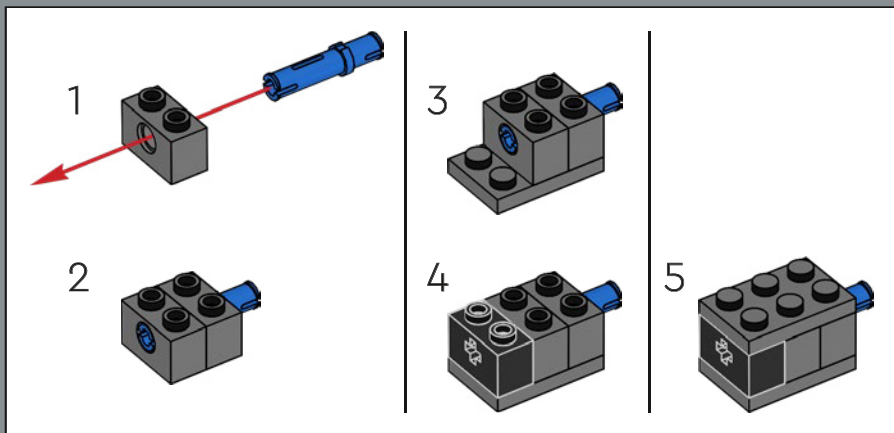

179

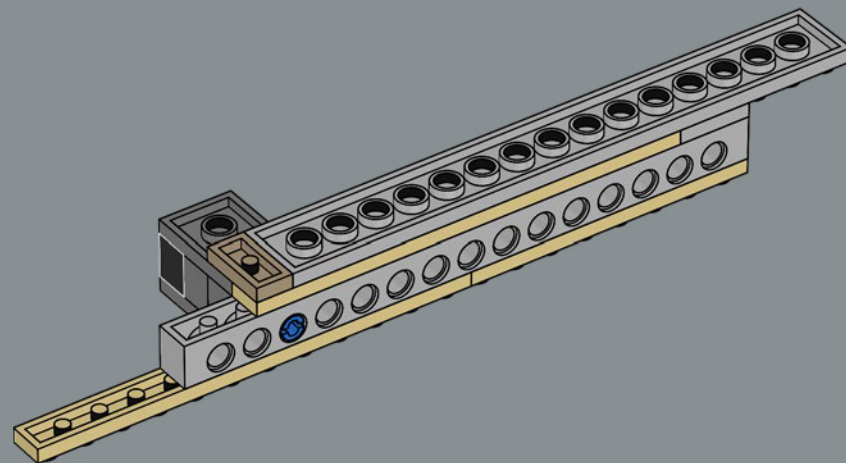
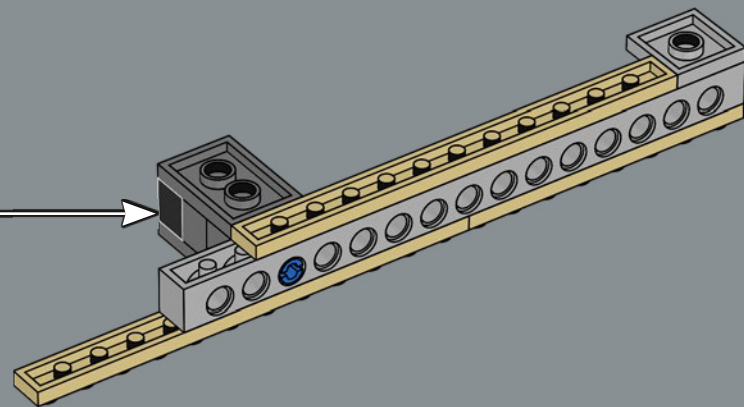

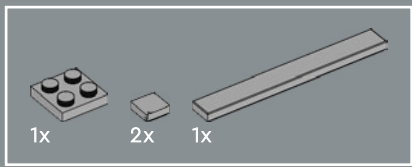

180

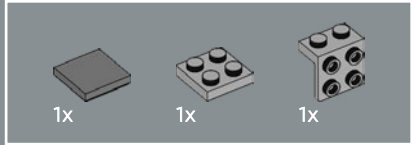
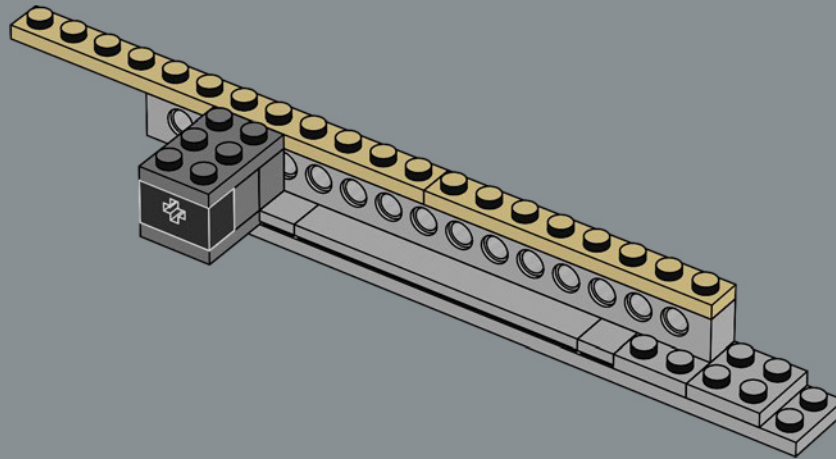

181

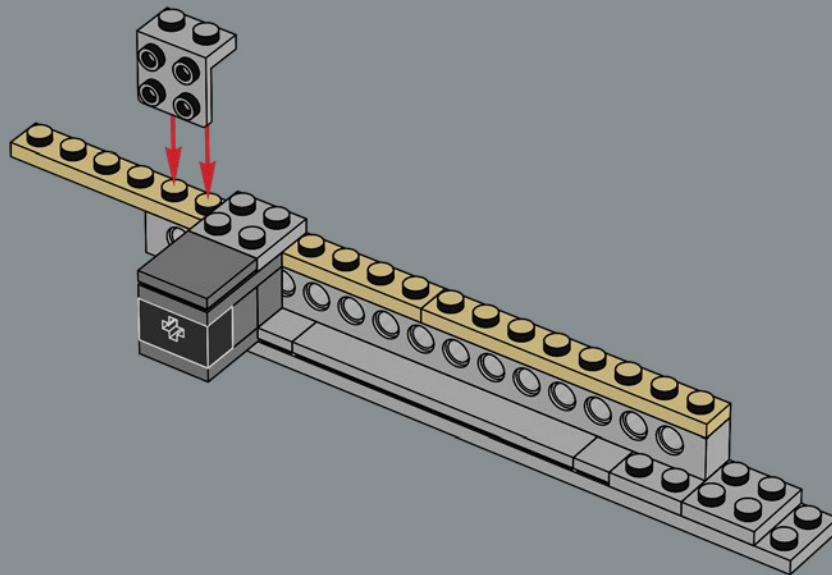



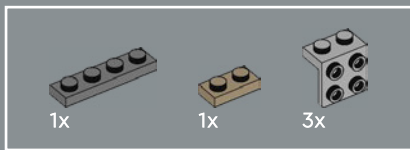

182

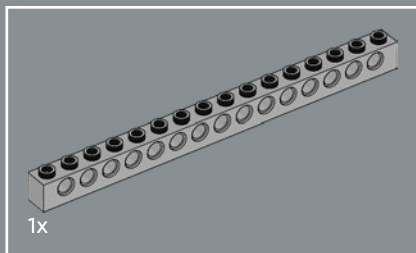
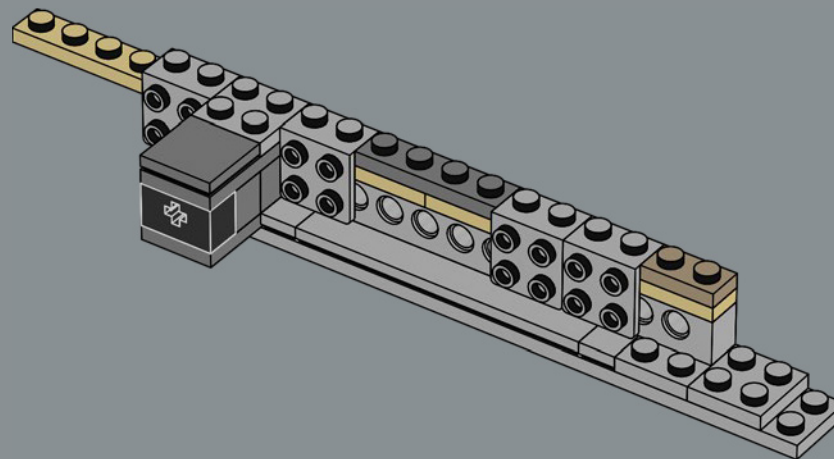

183

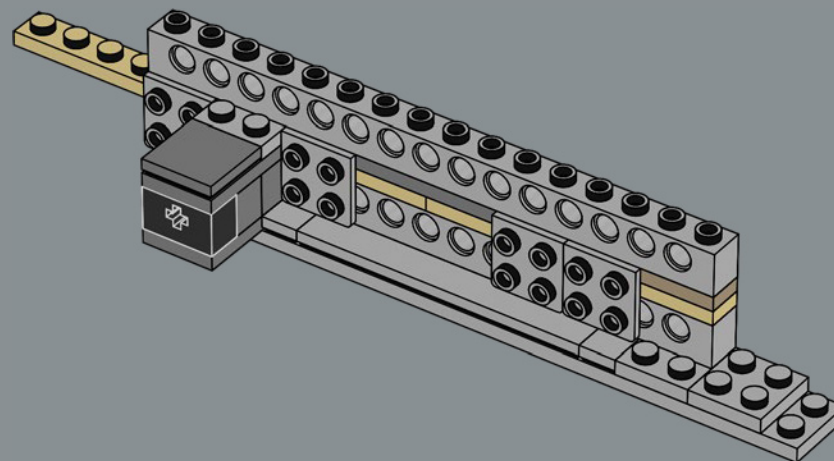

184

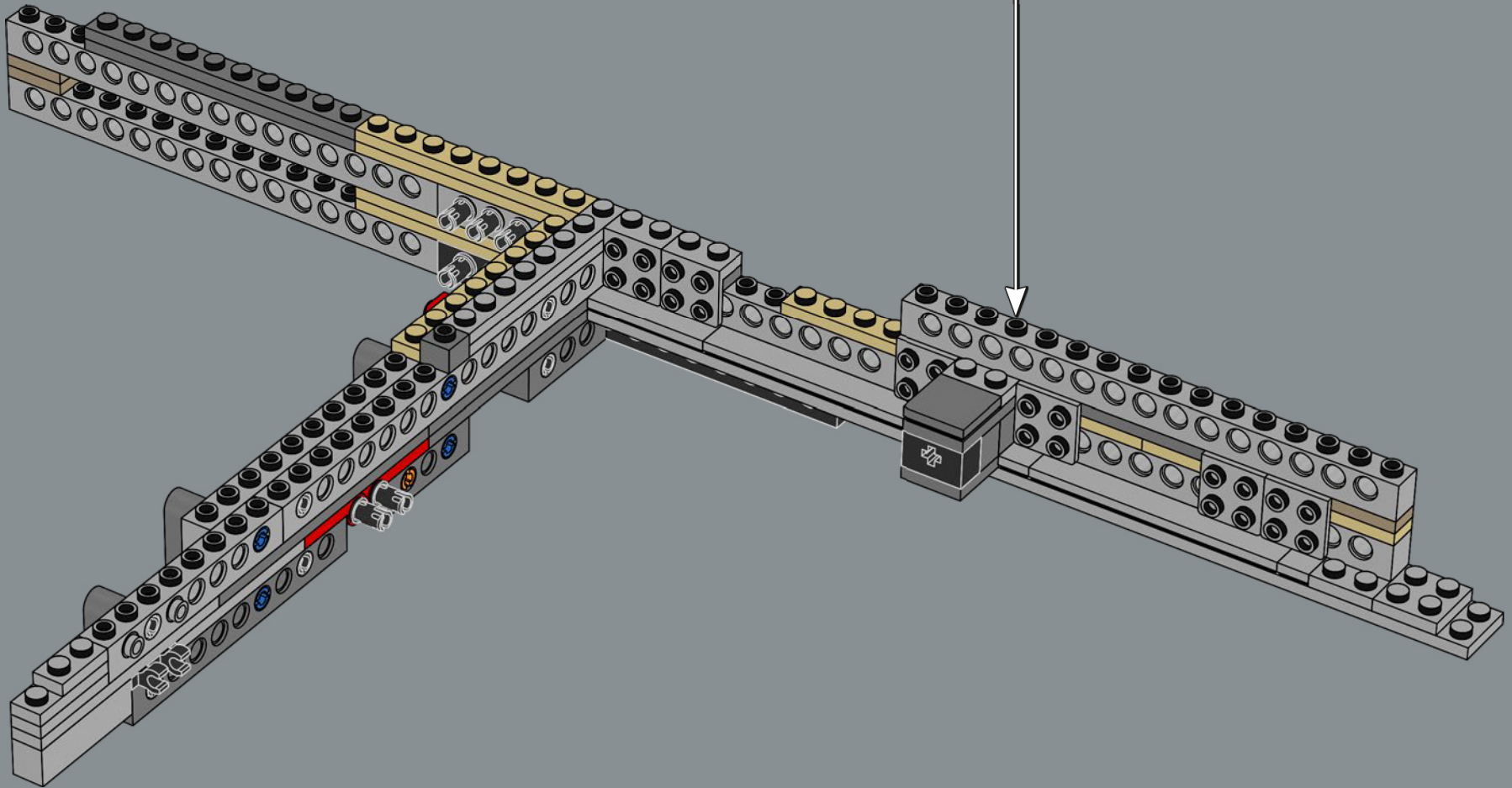

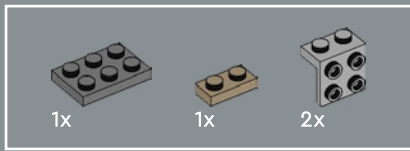

185

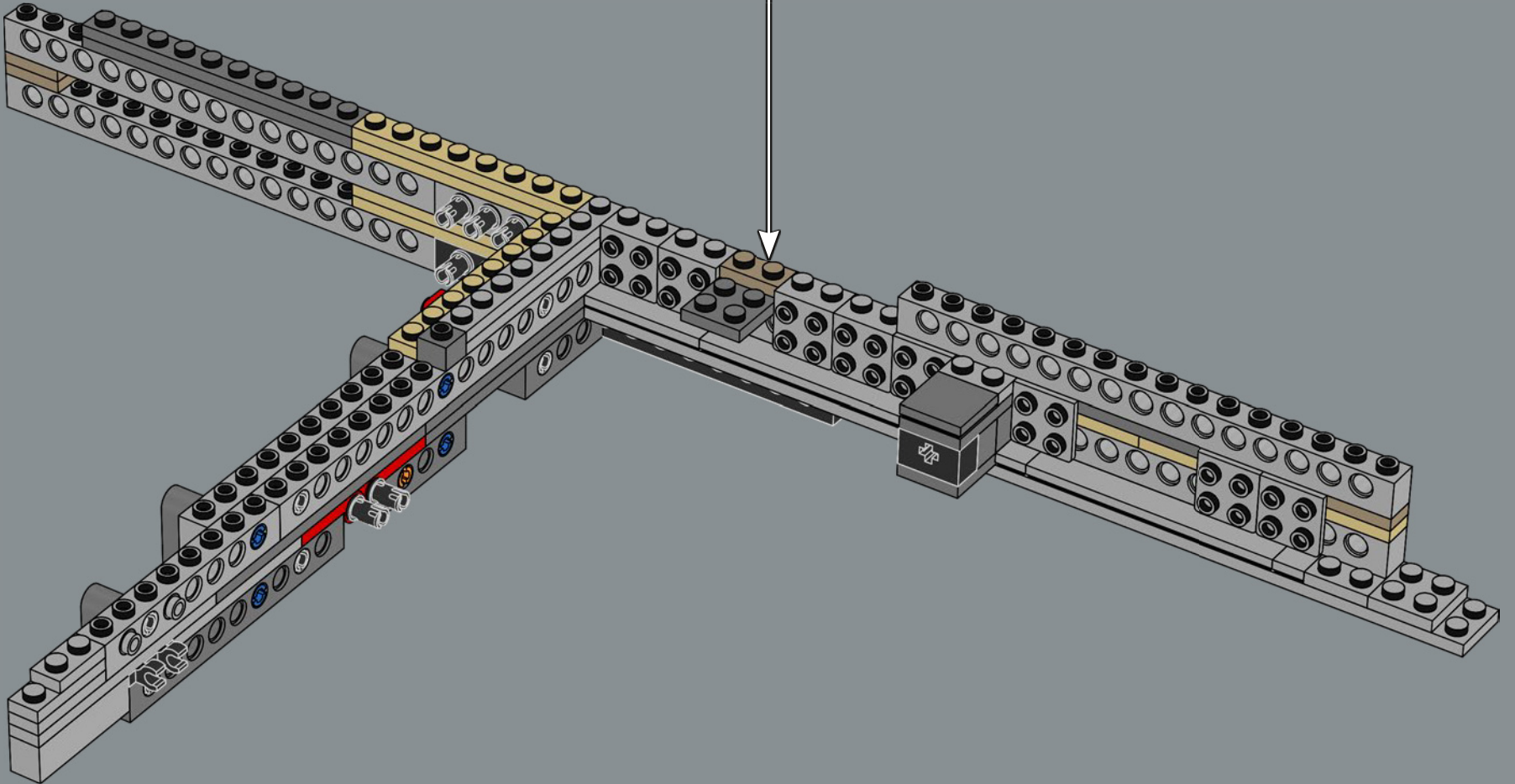
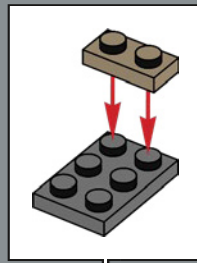

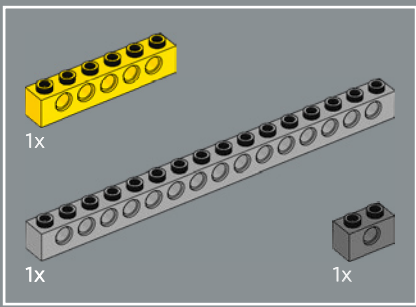

186

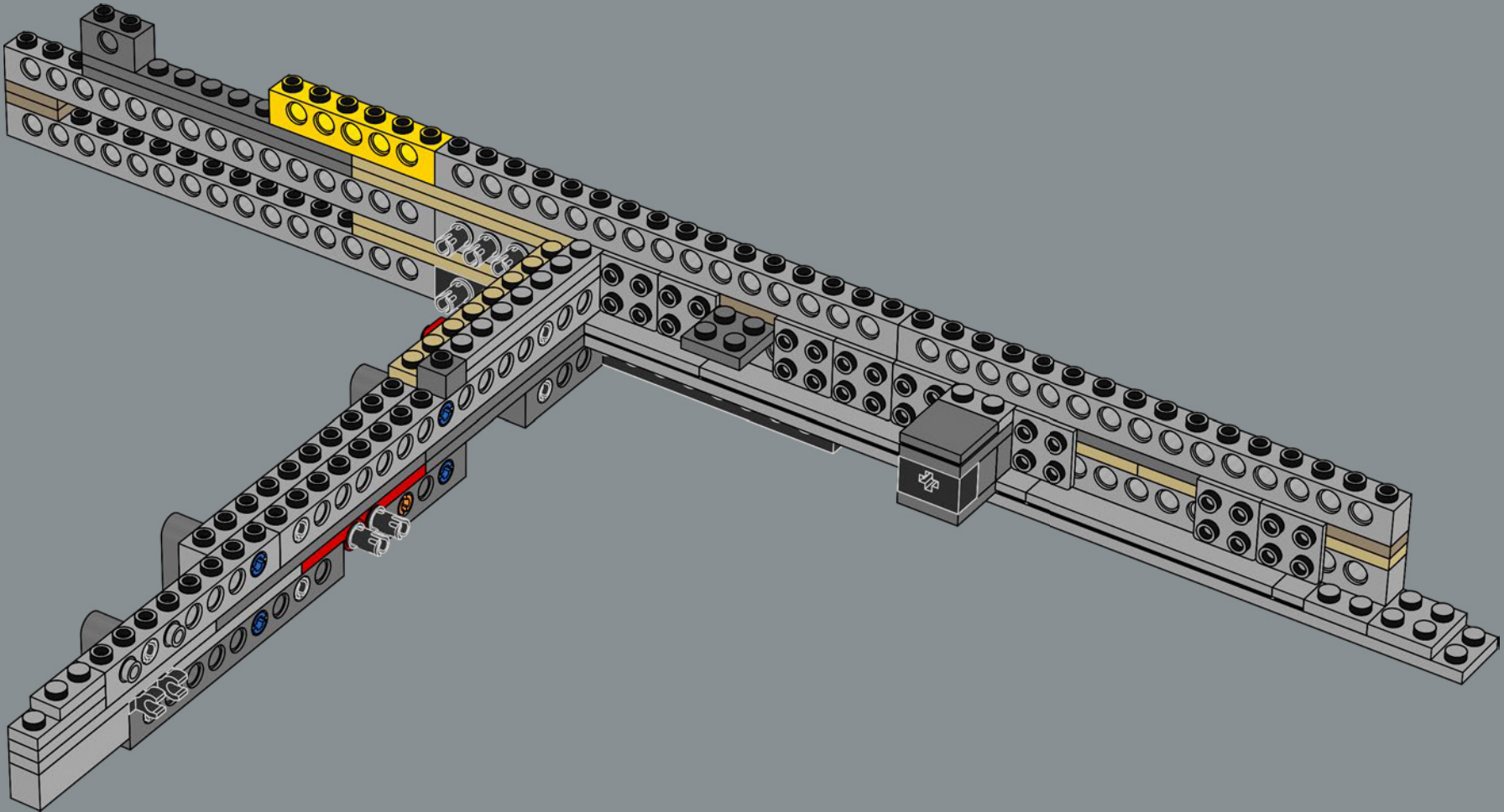

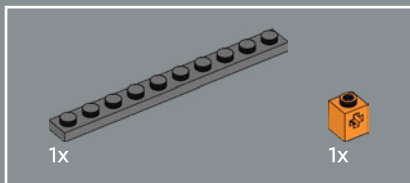

187

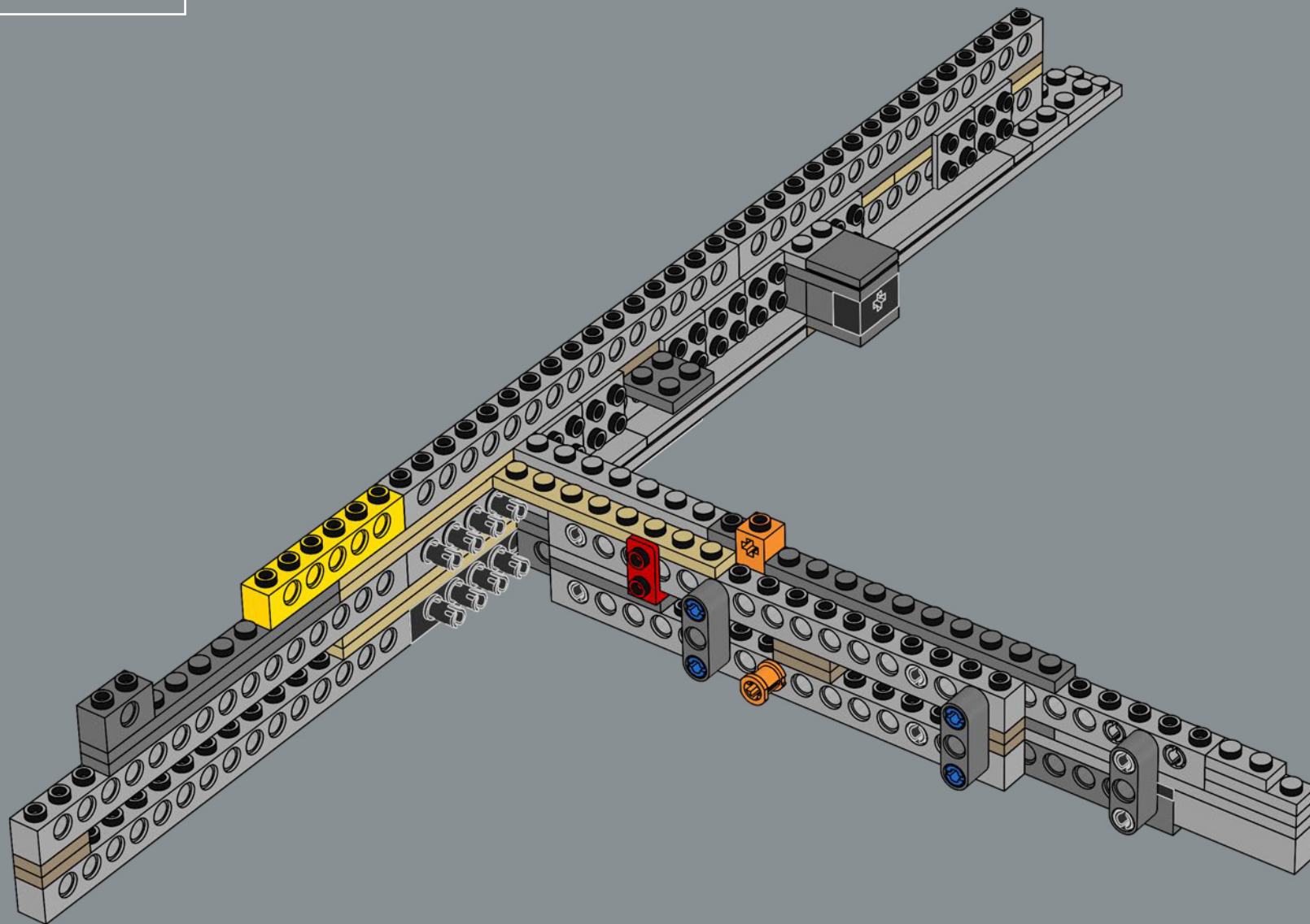

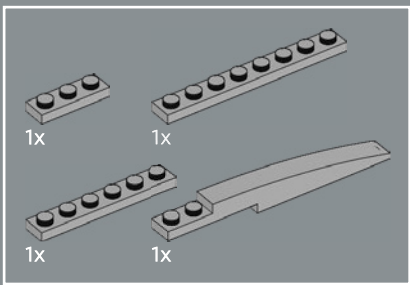

188

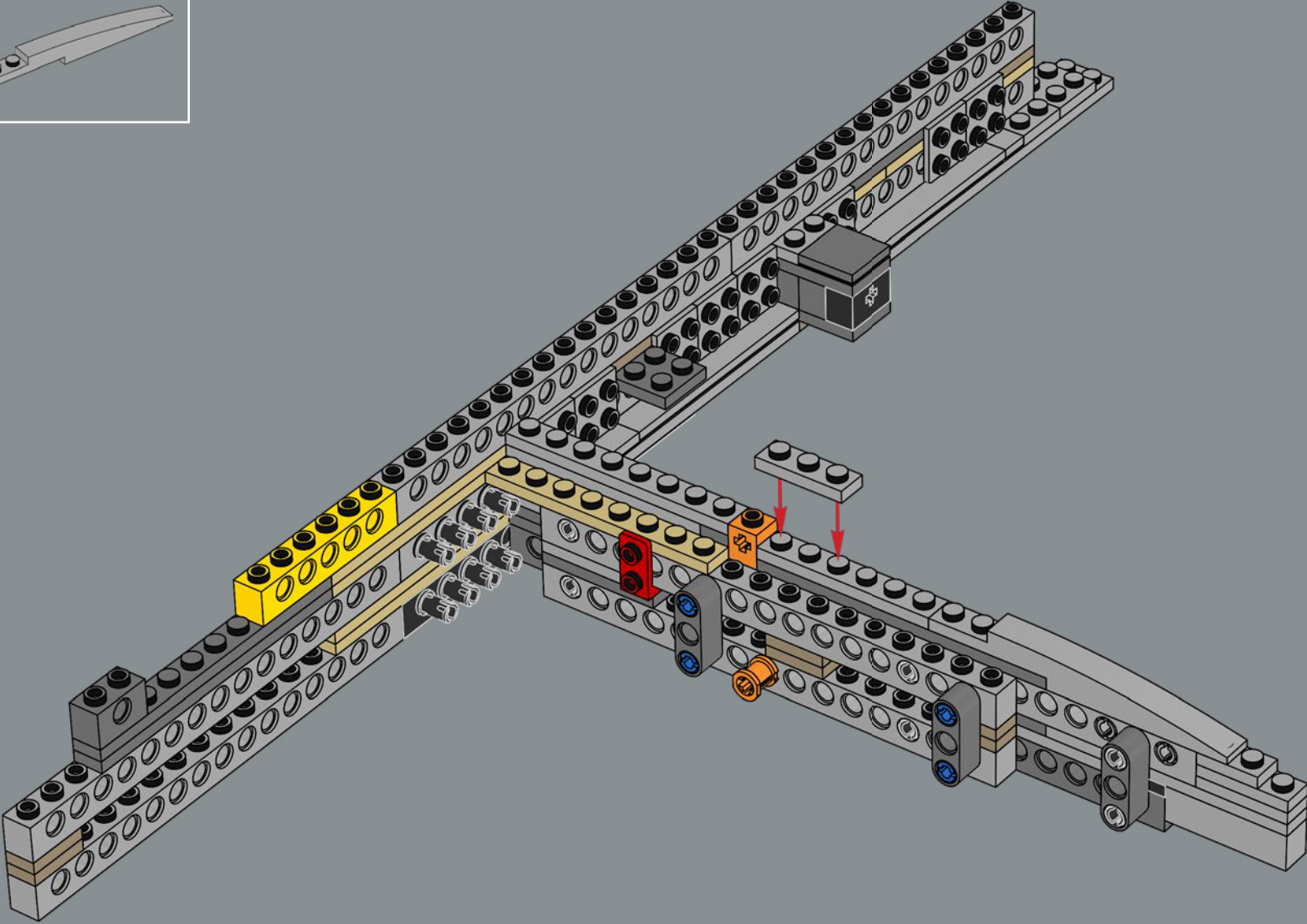

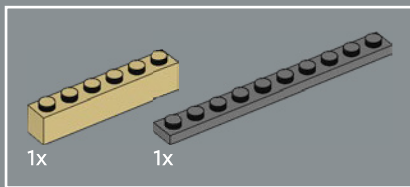

189

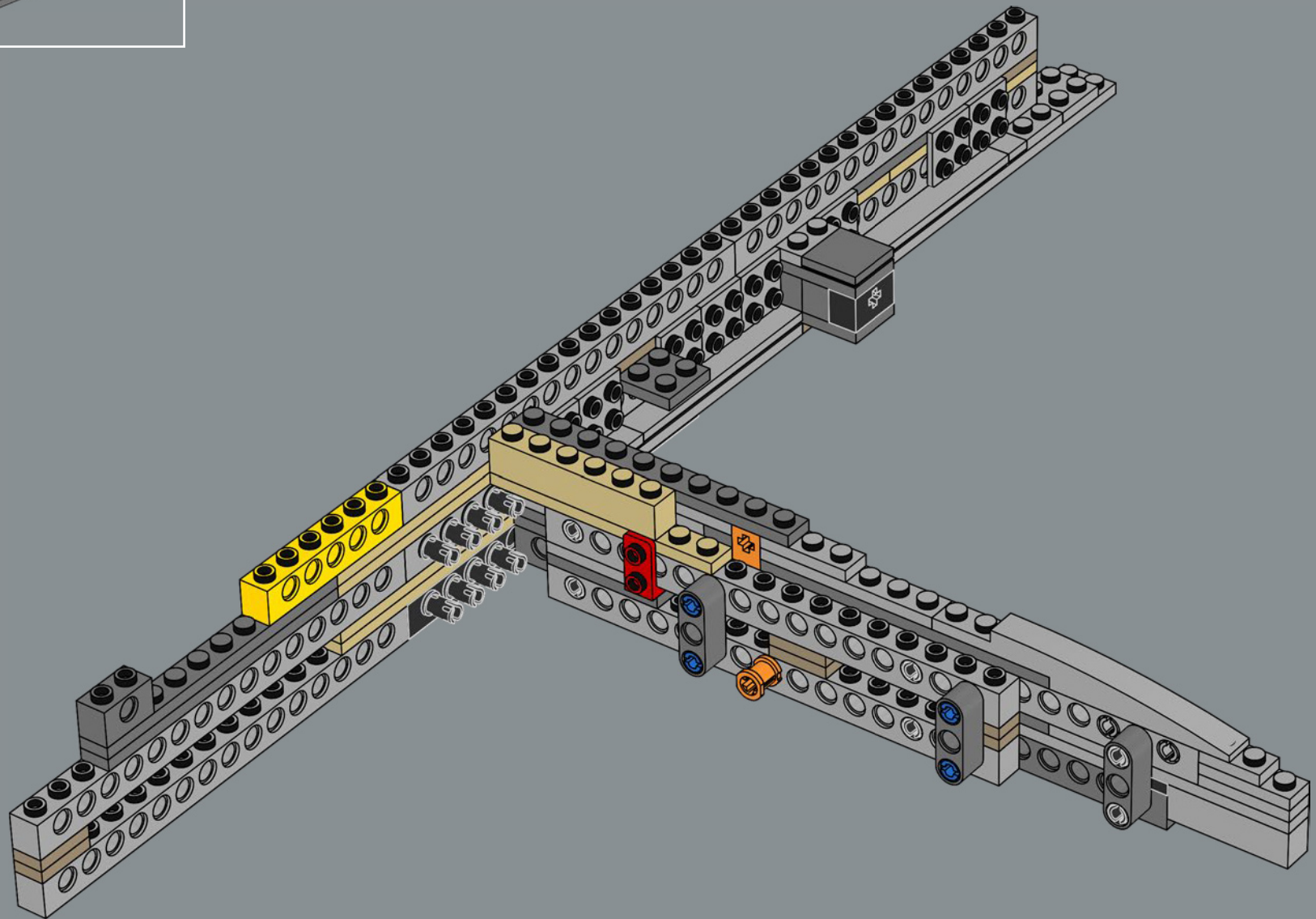





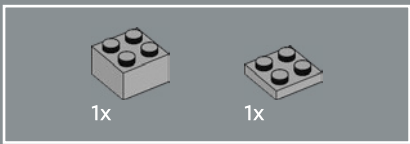

191

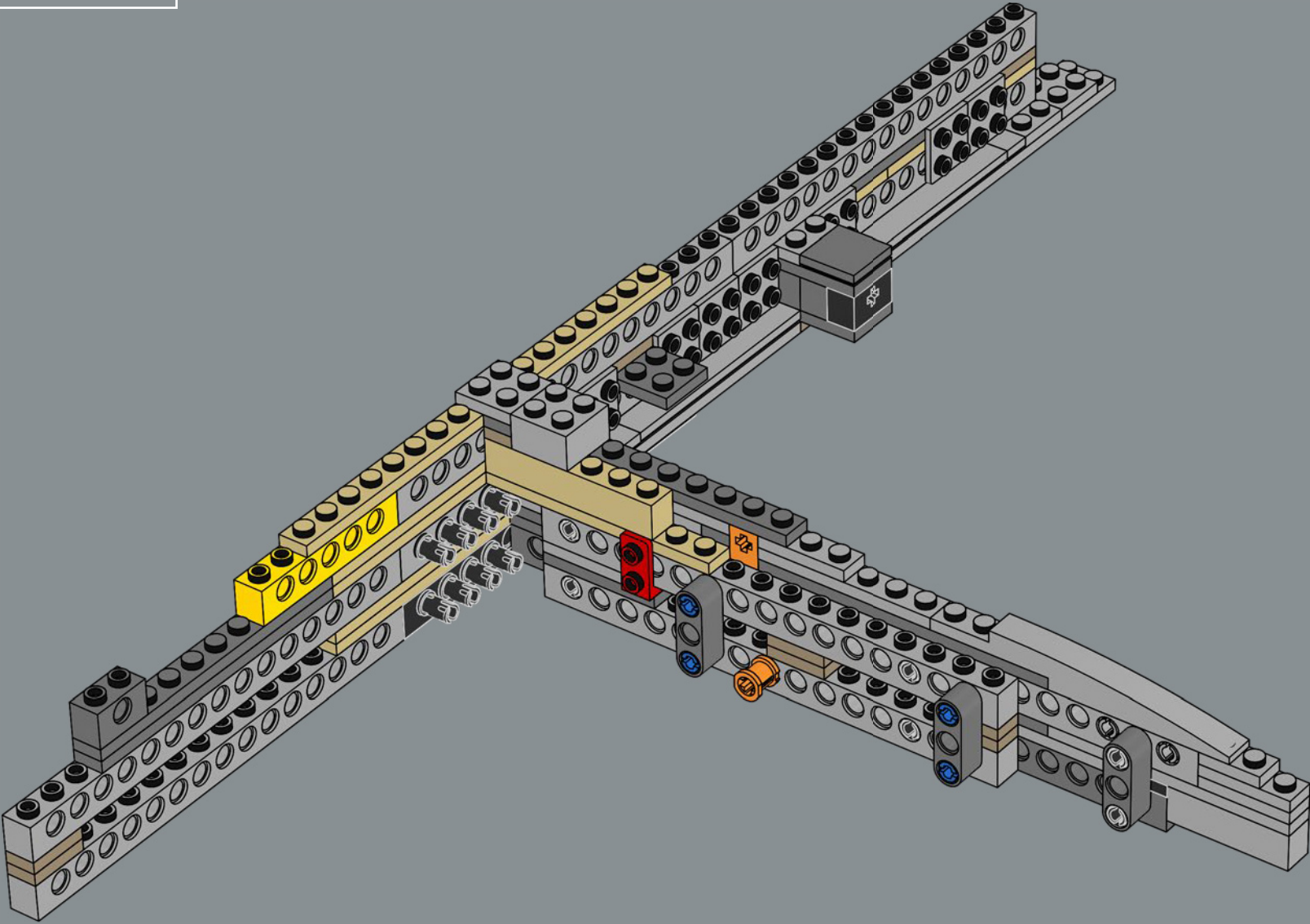

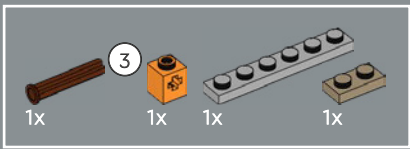

192

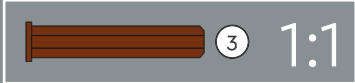
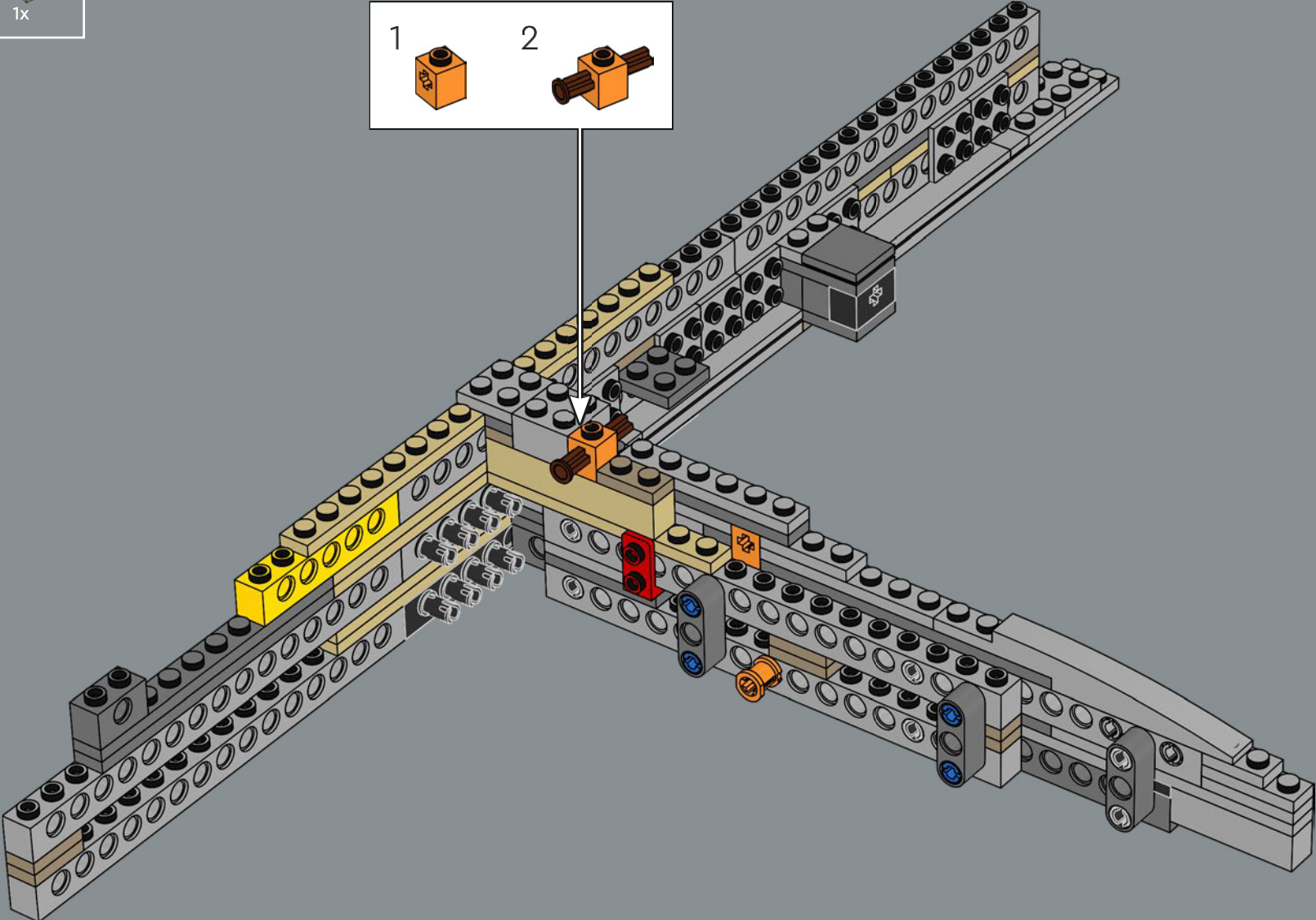
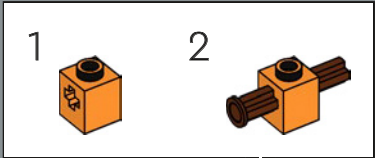



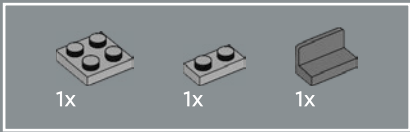

194

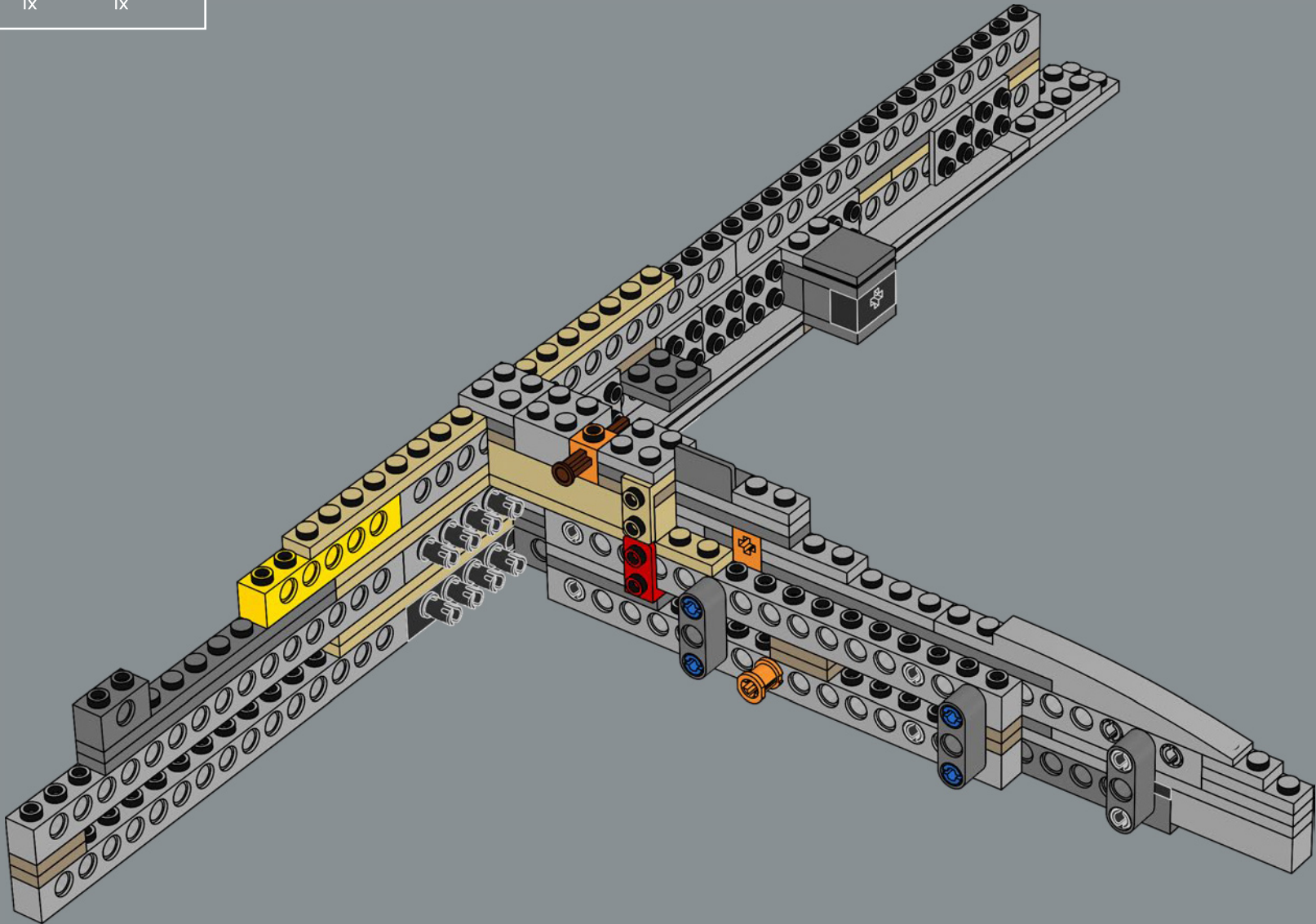



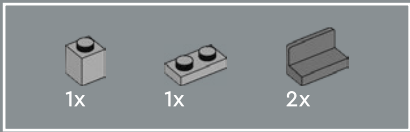

196

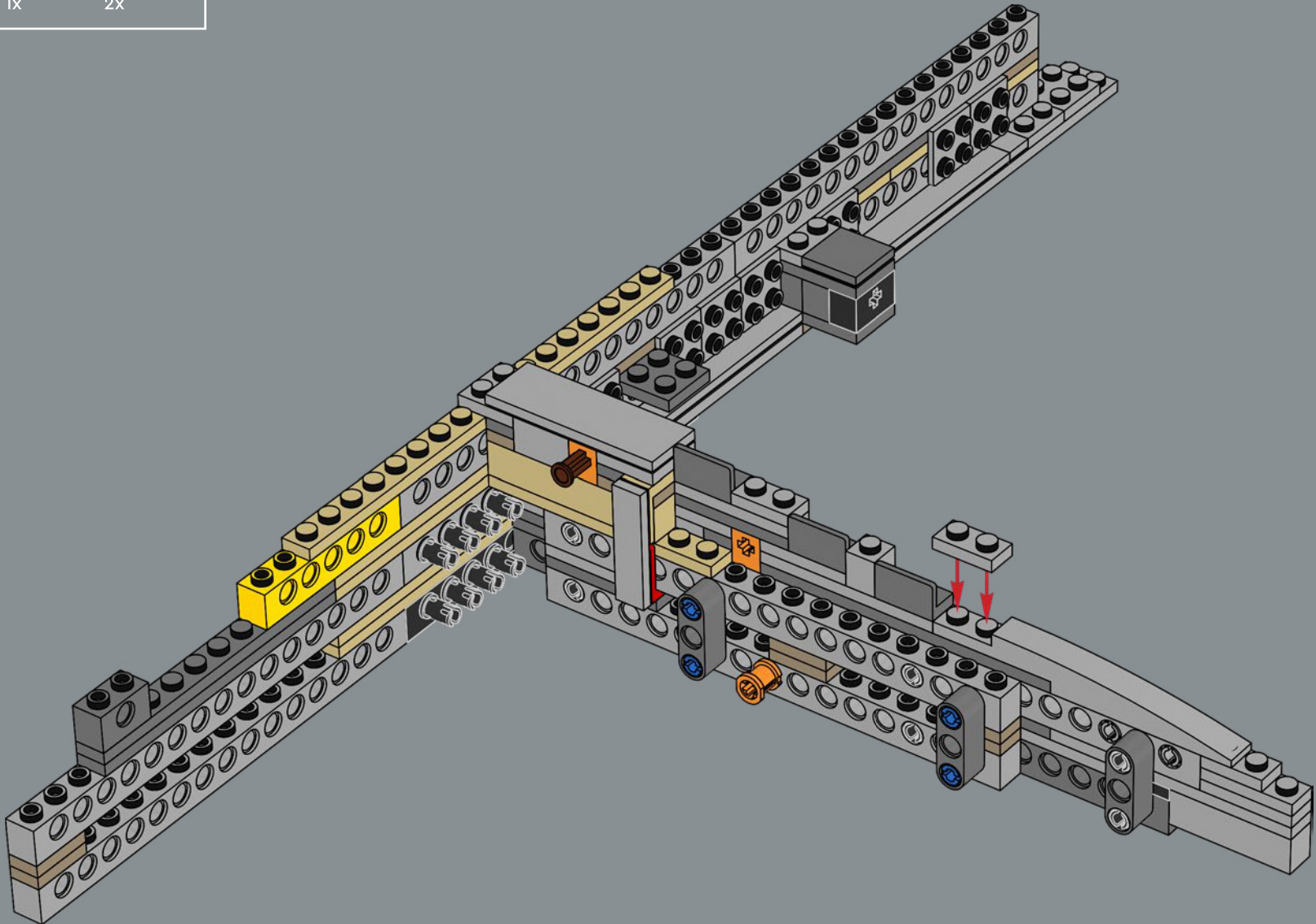



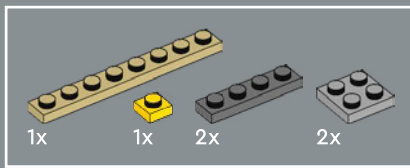

198

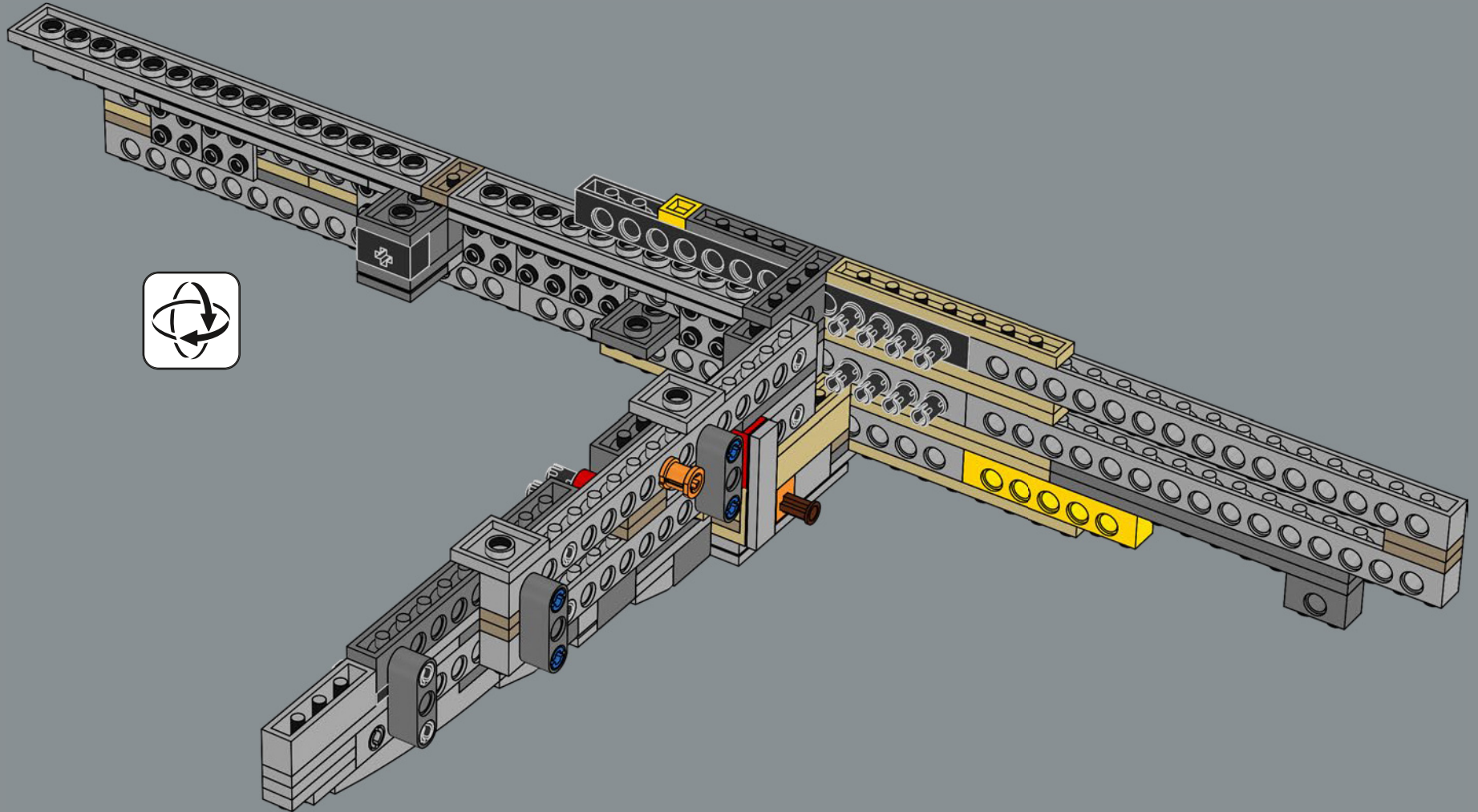



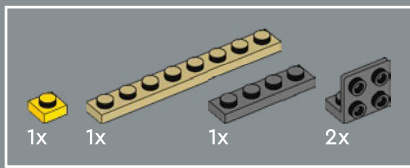

199

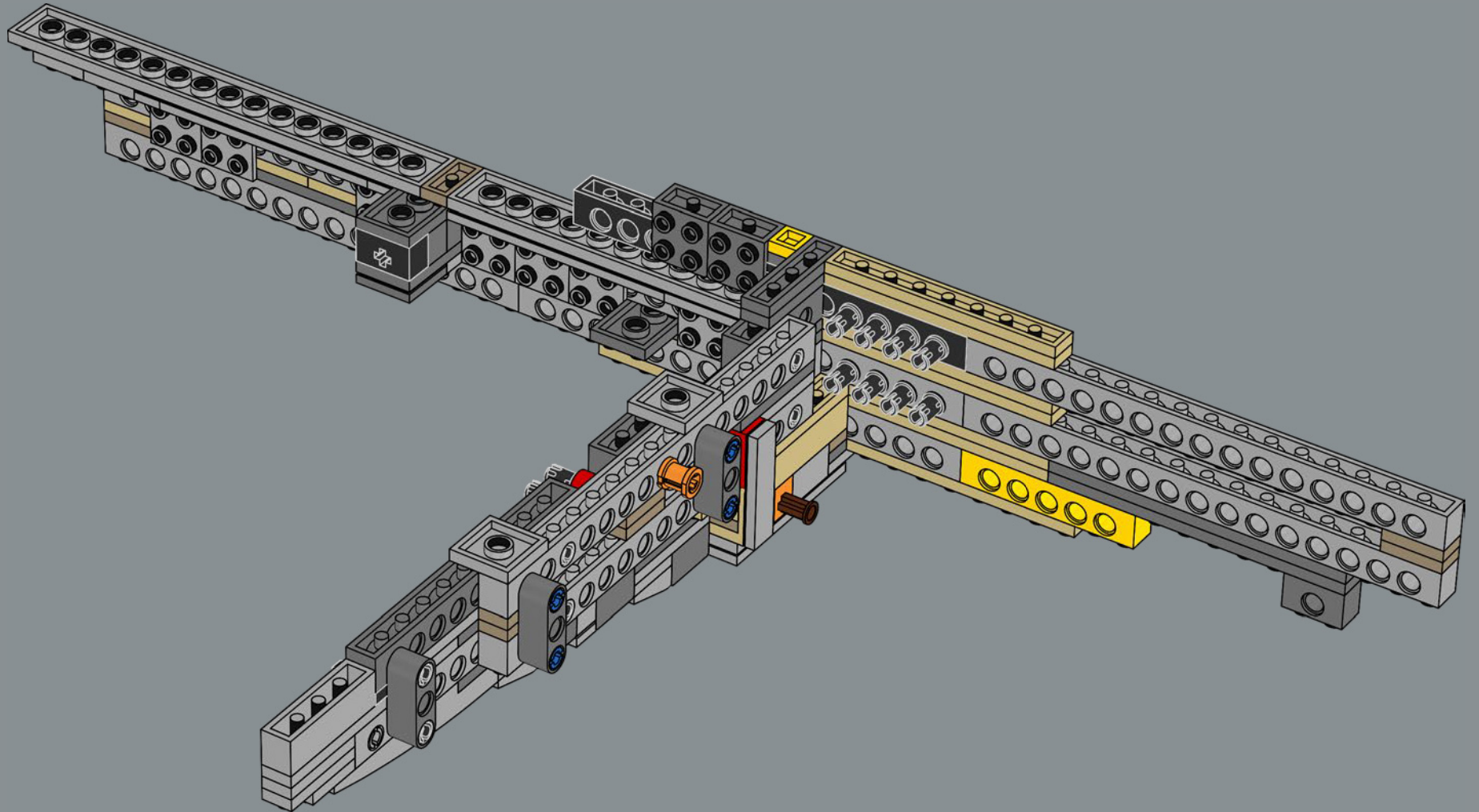

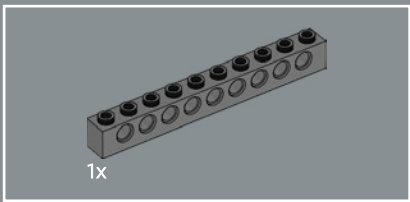

200

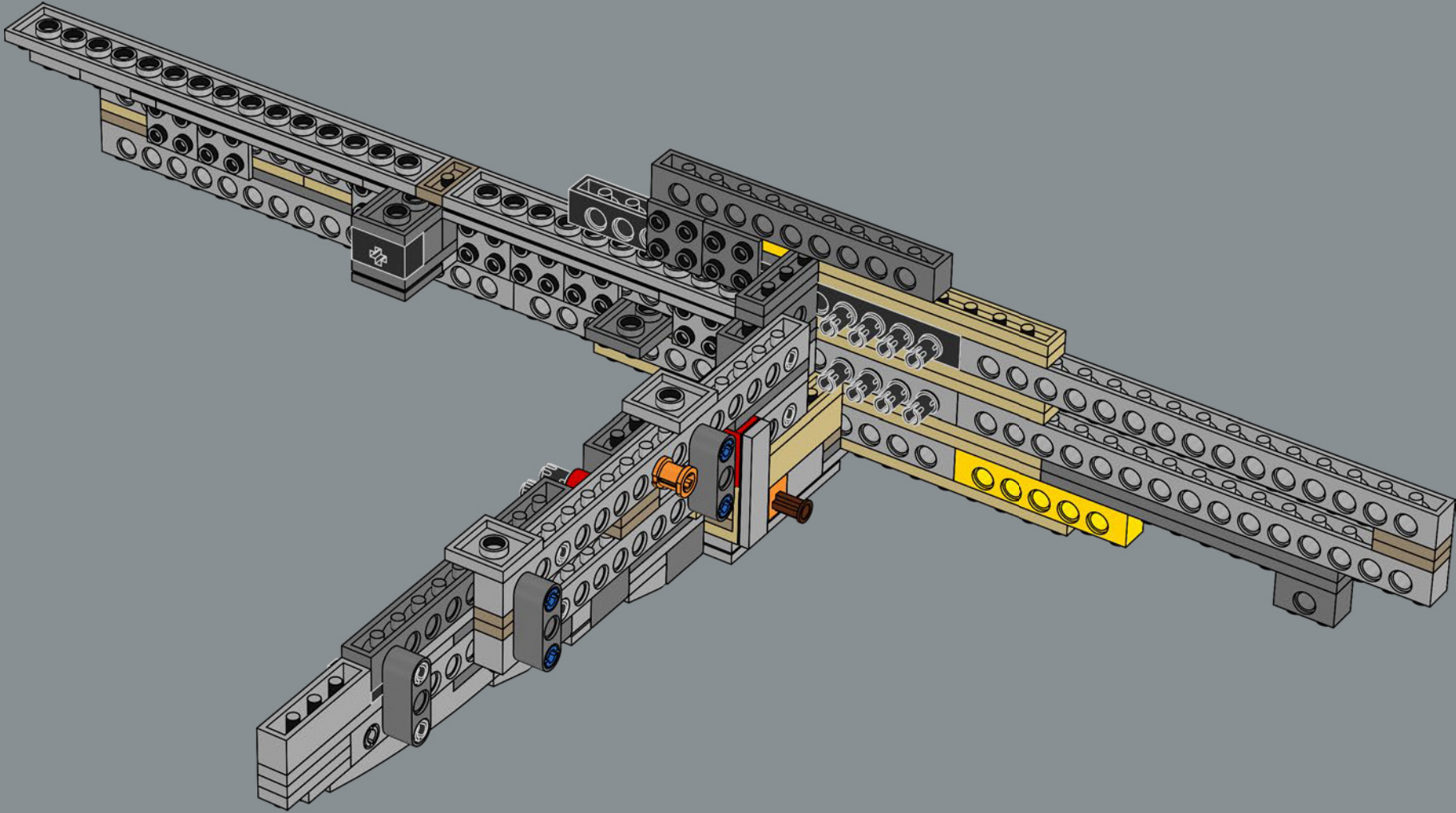

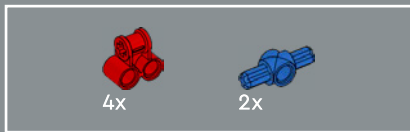

201

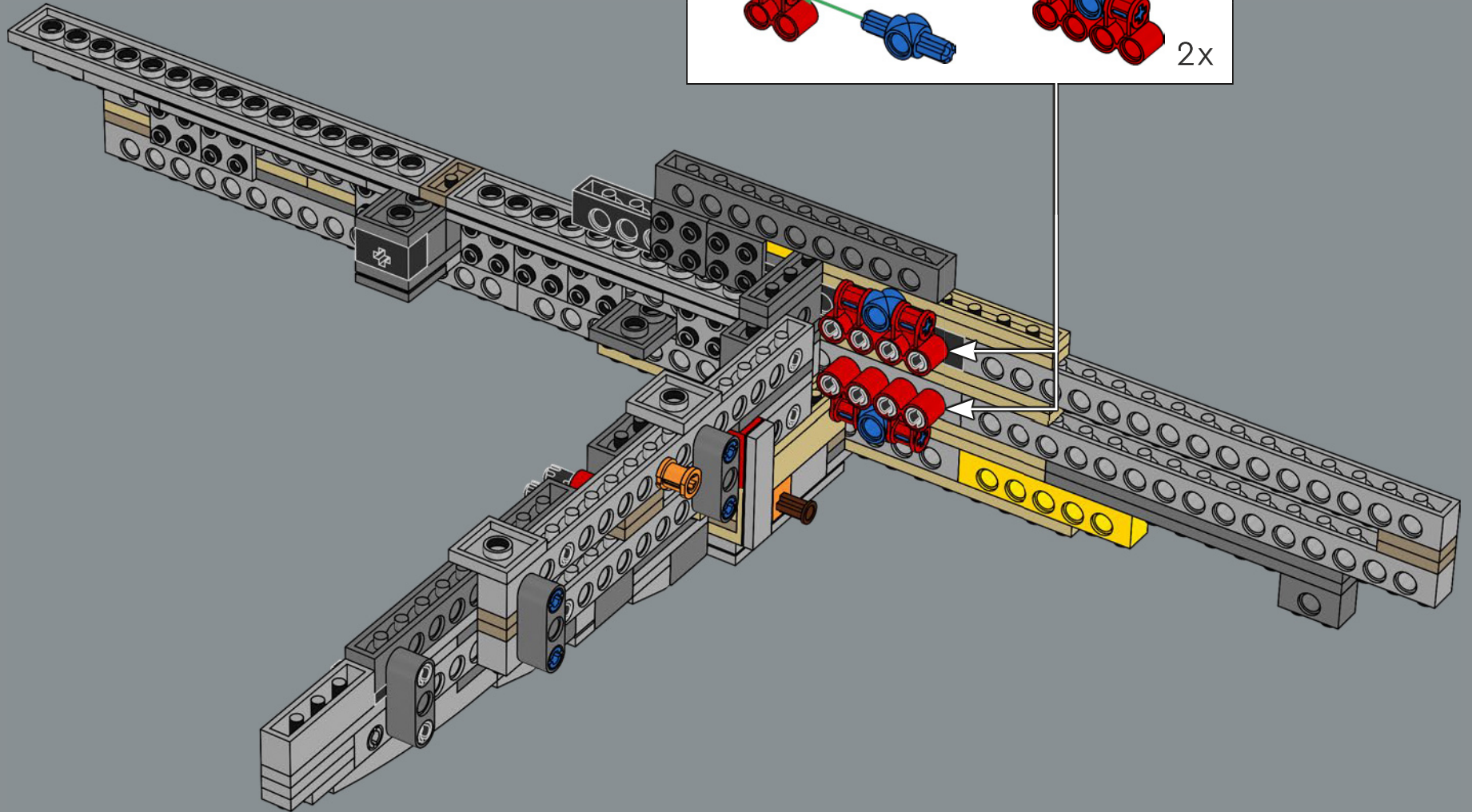
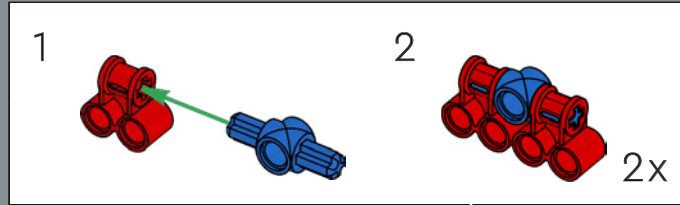

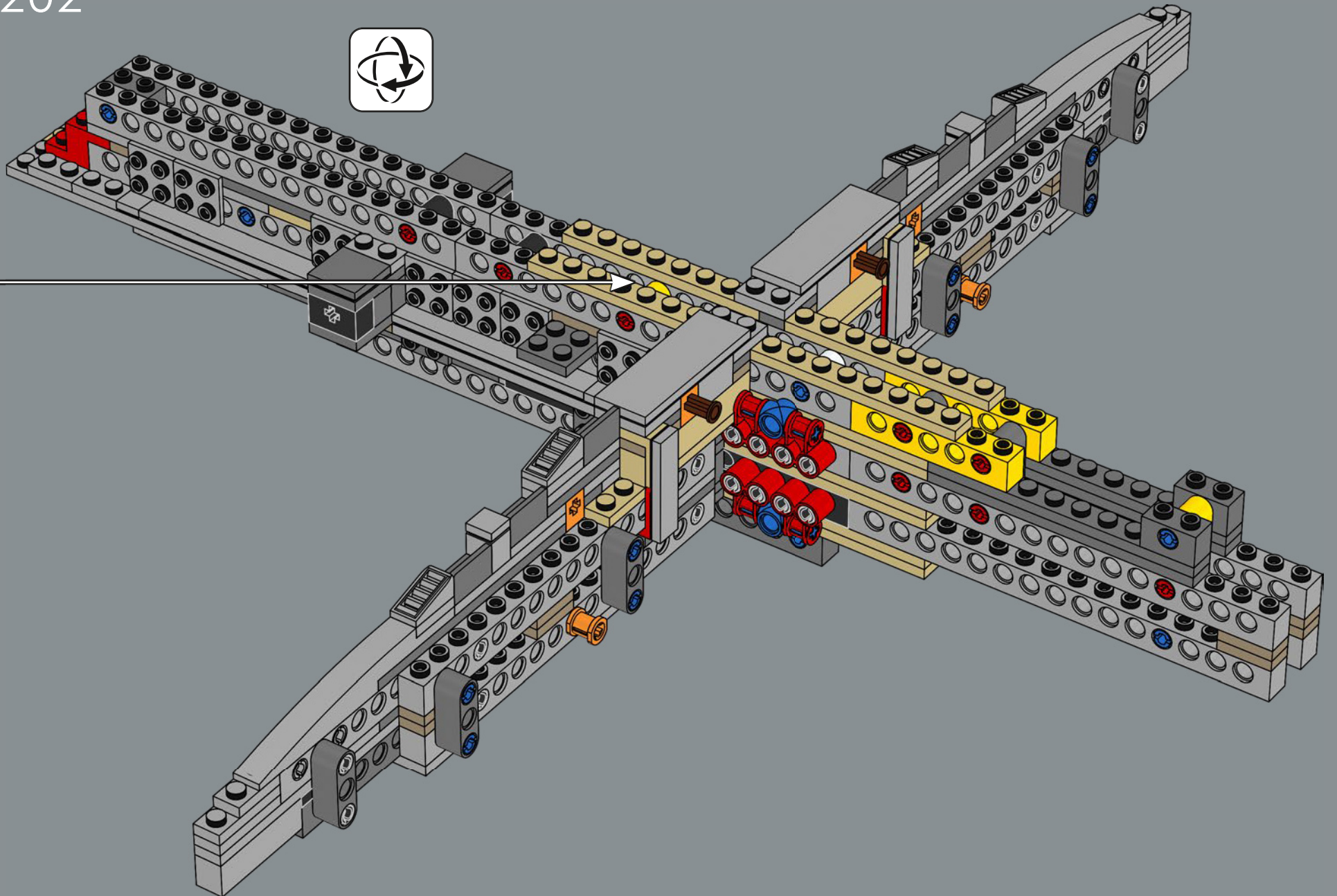

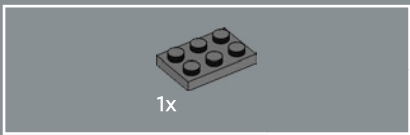

203

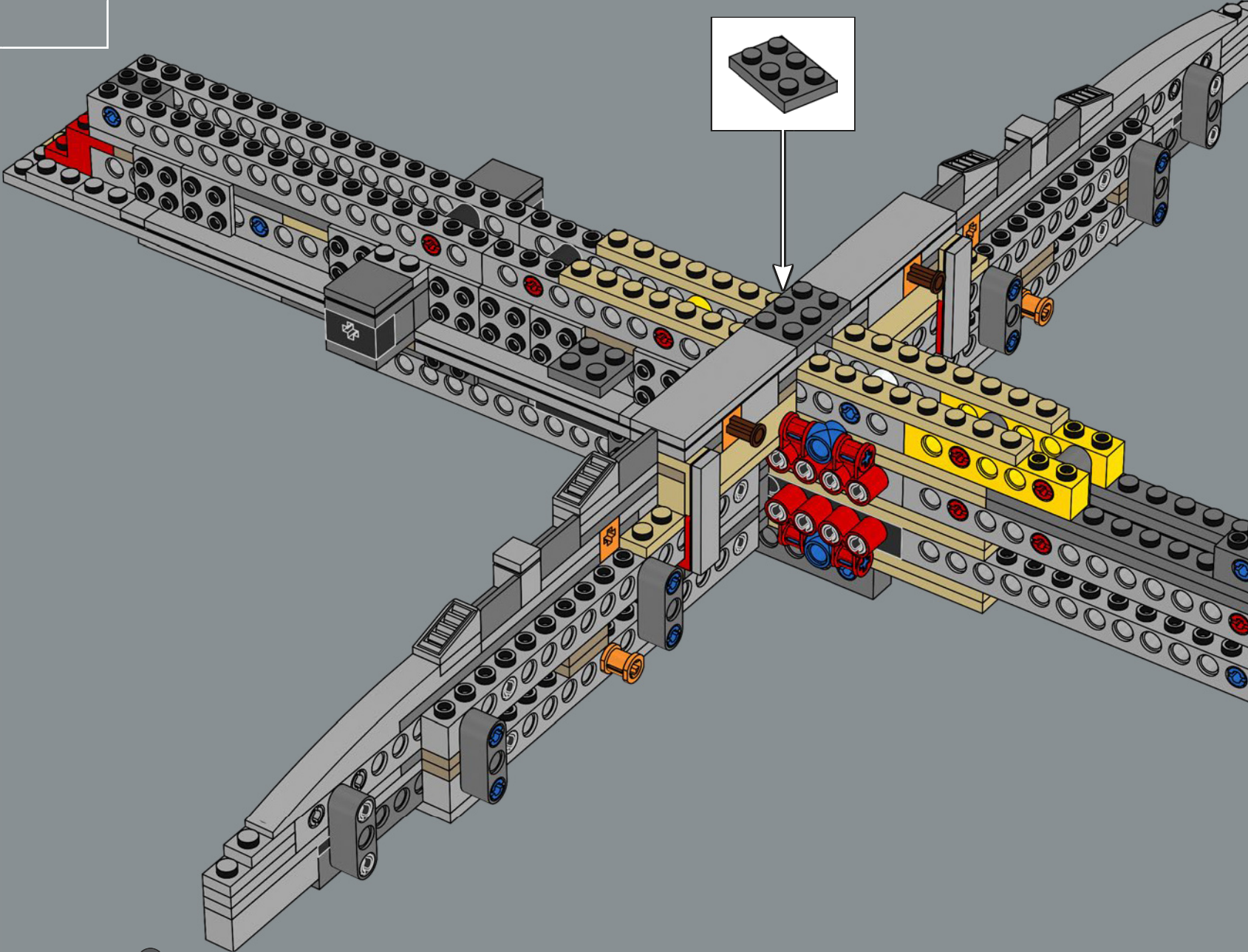
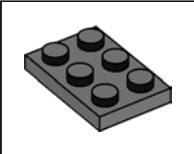

204

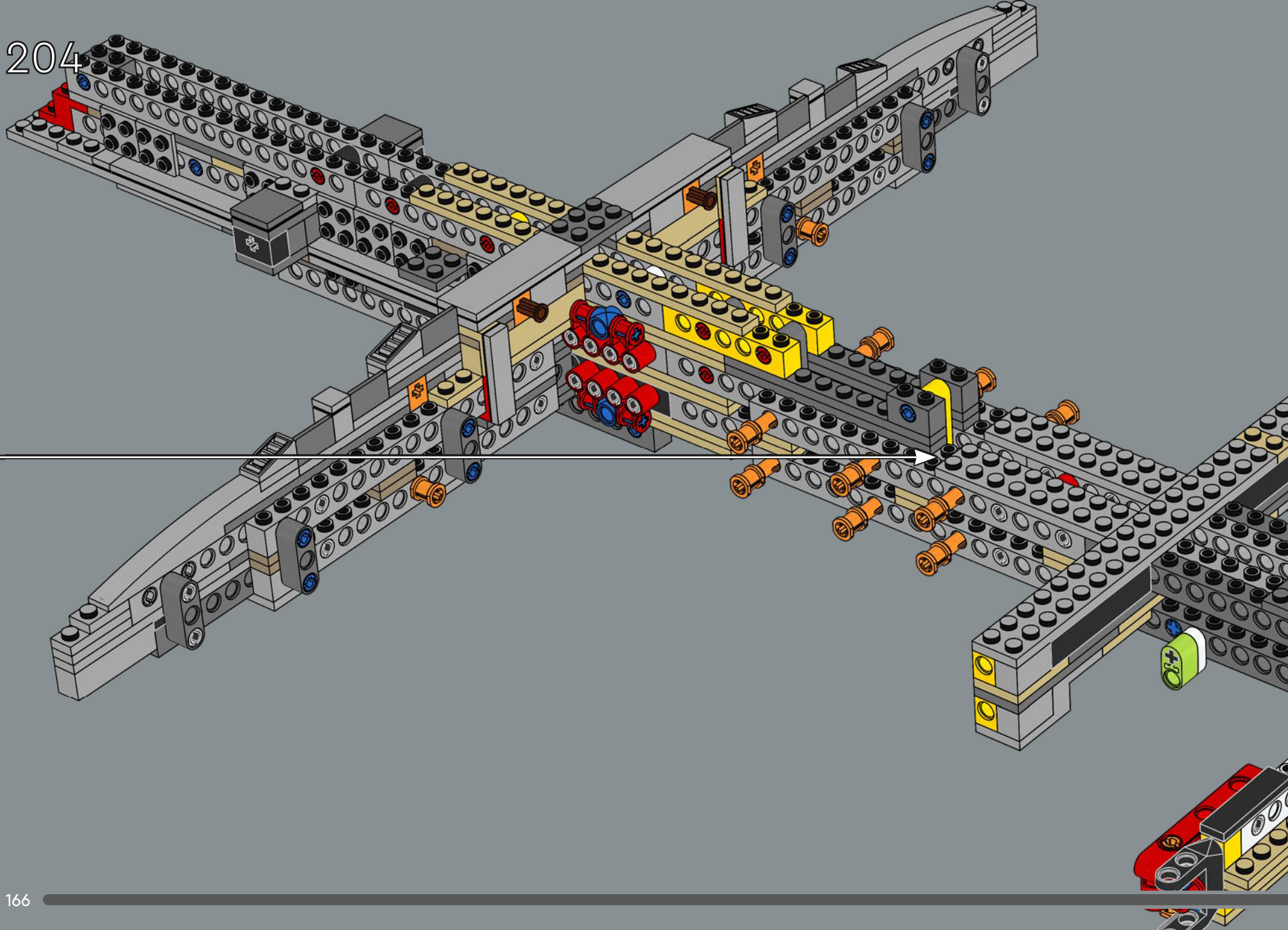

205



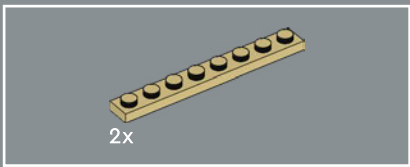

206

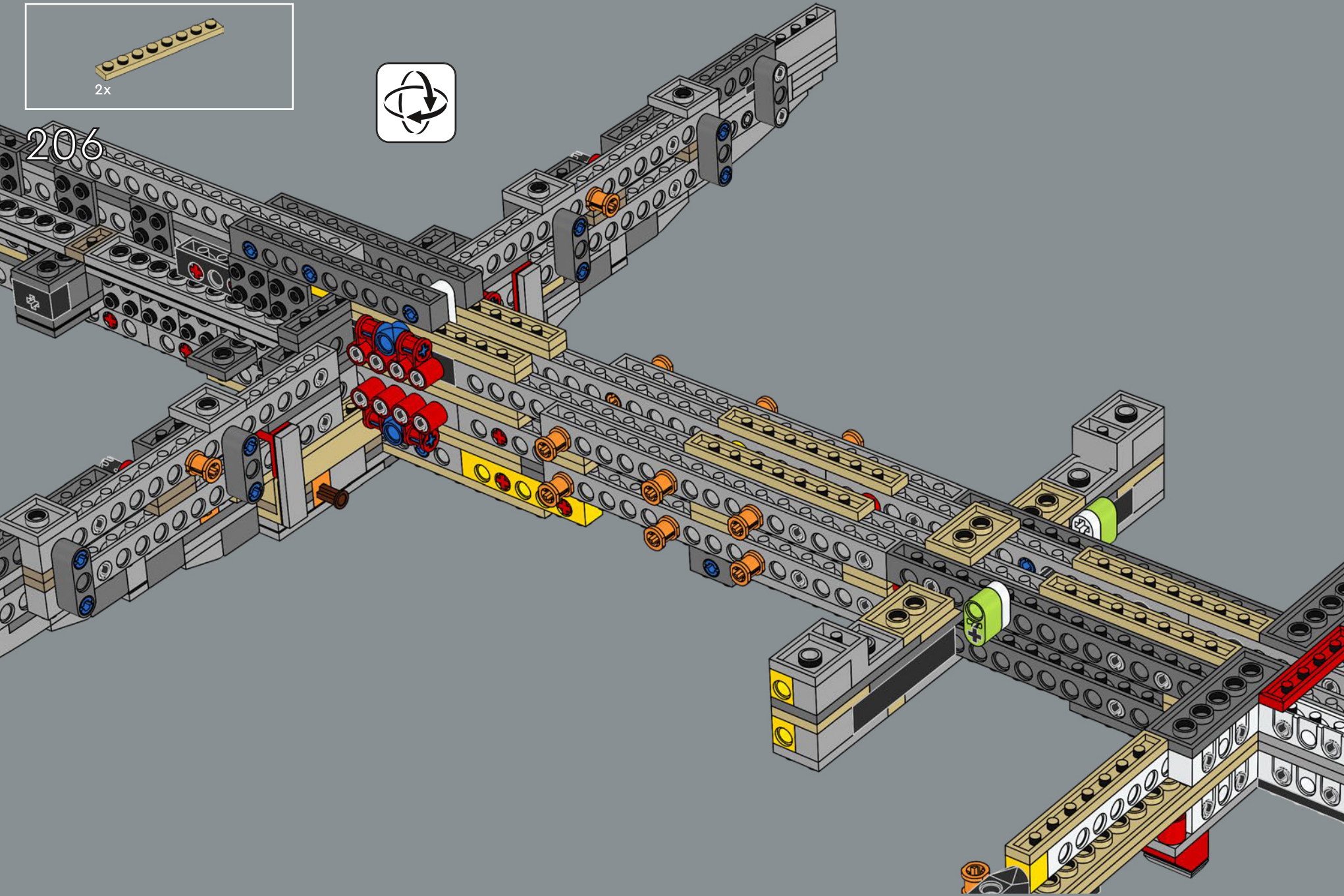



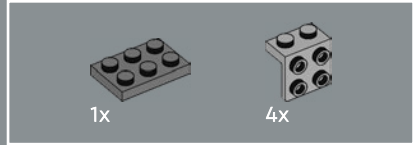
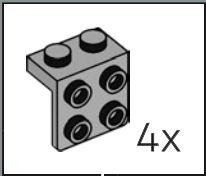

207

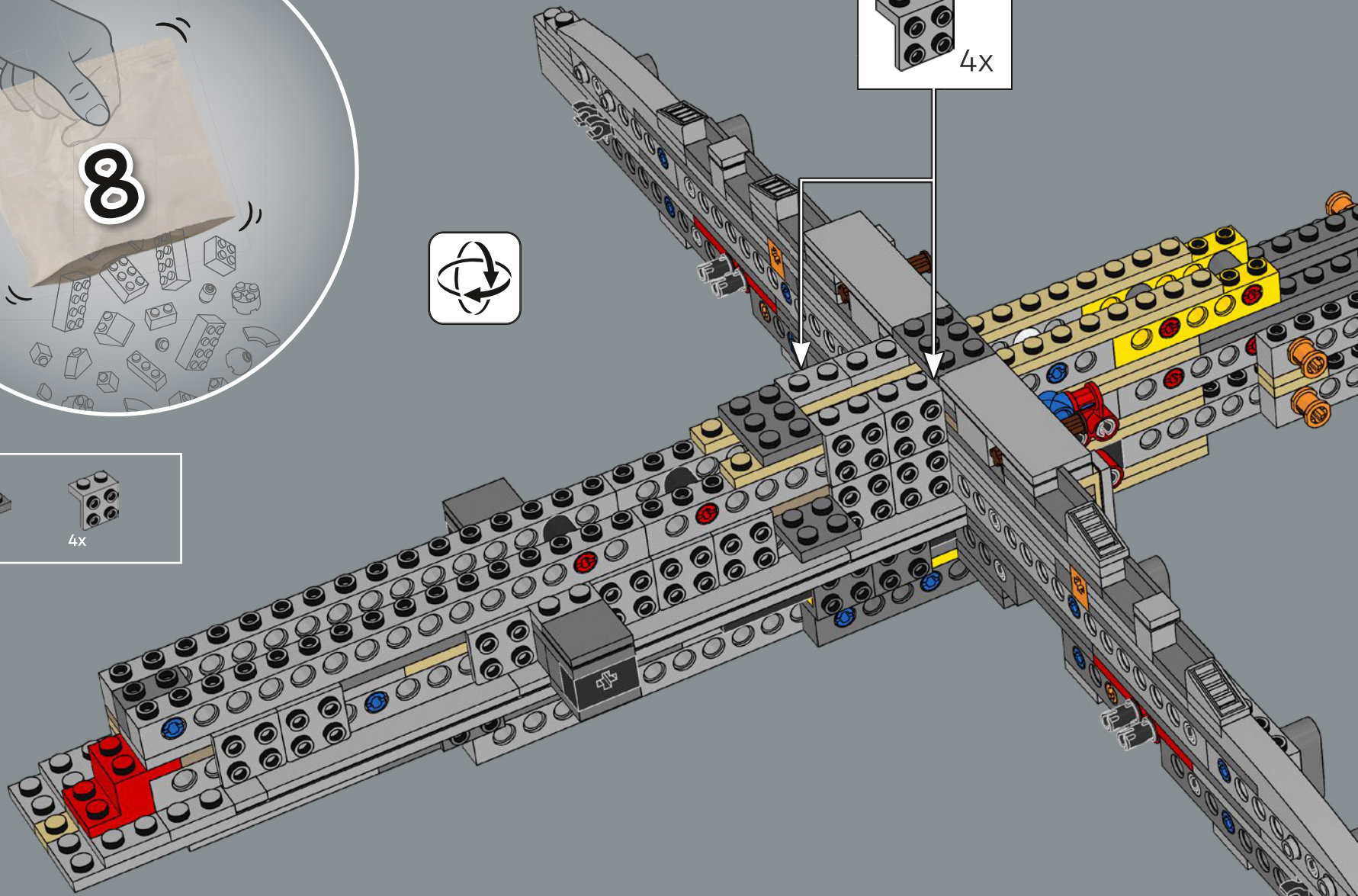



208

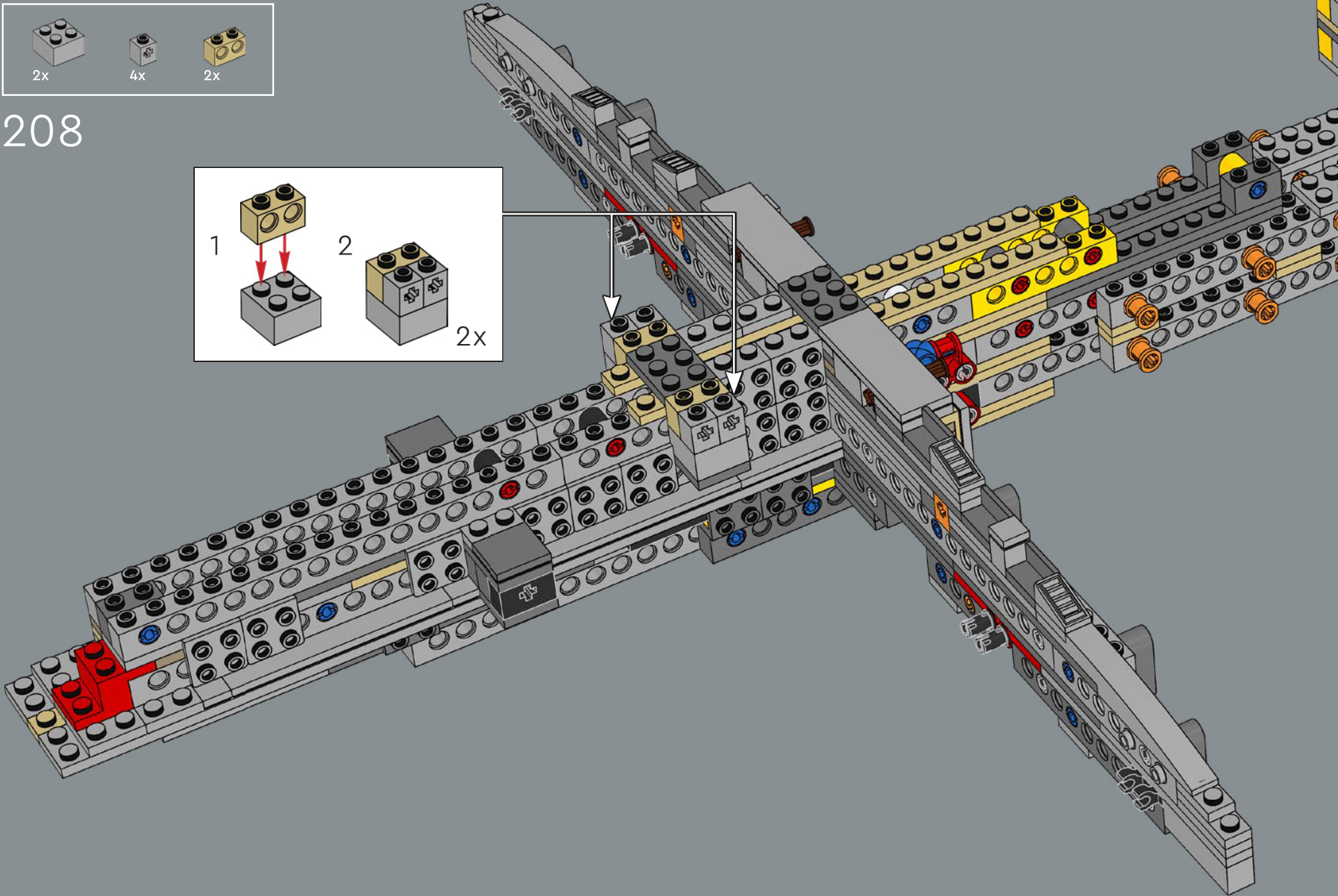
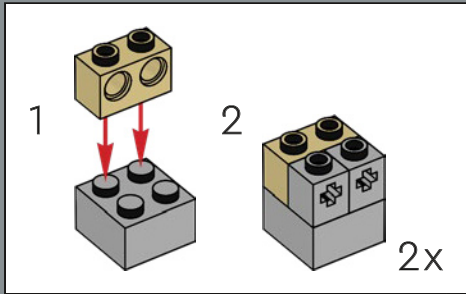

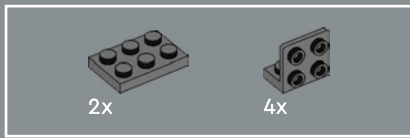

209

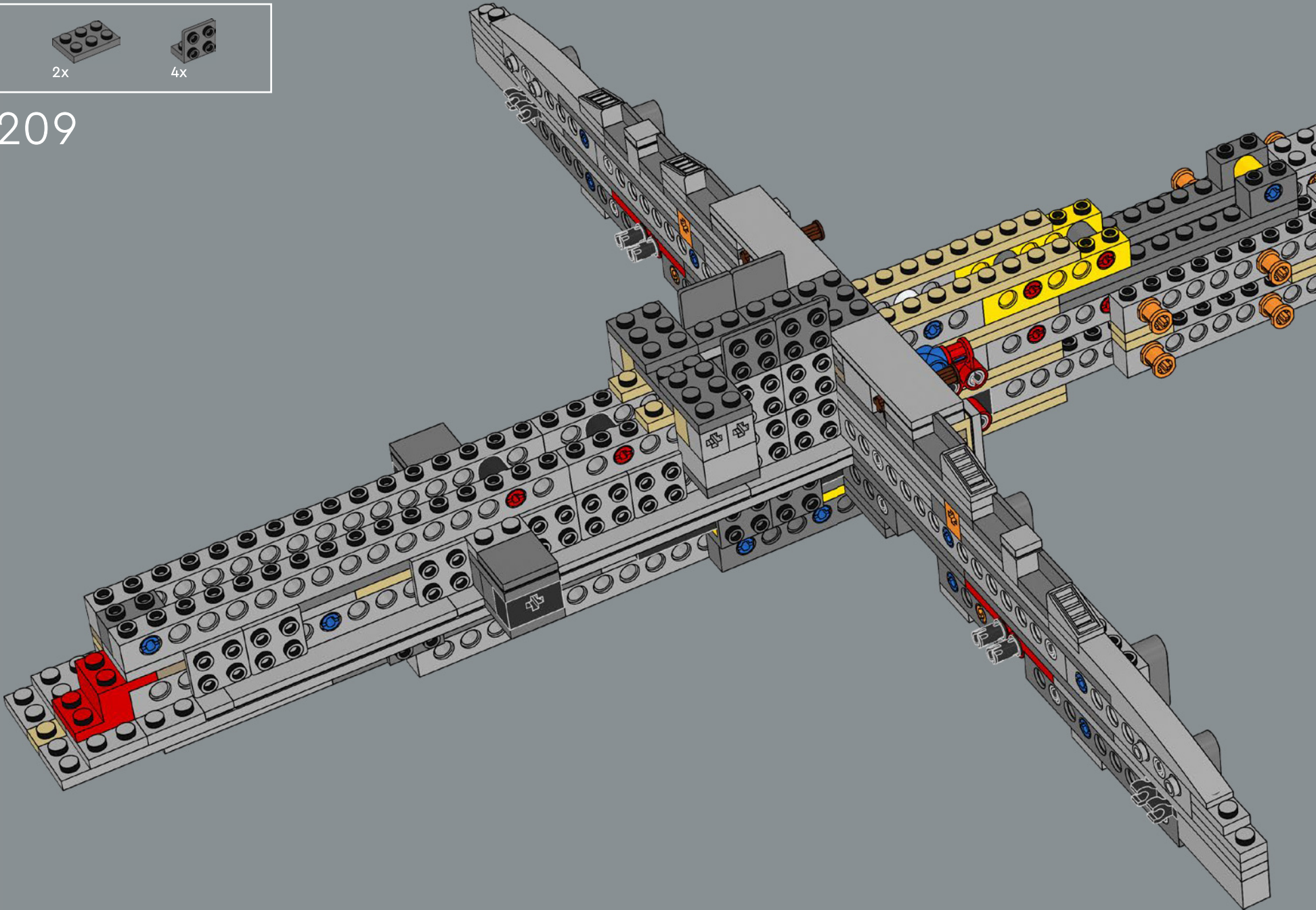

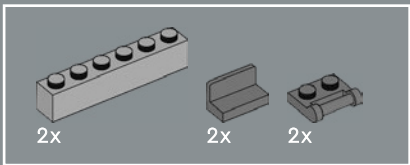

210

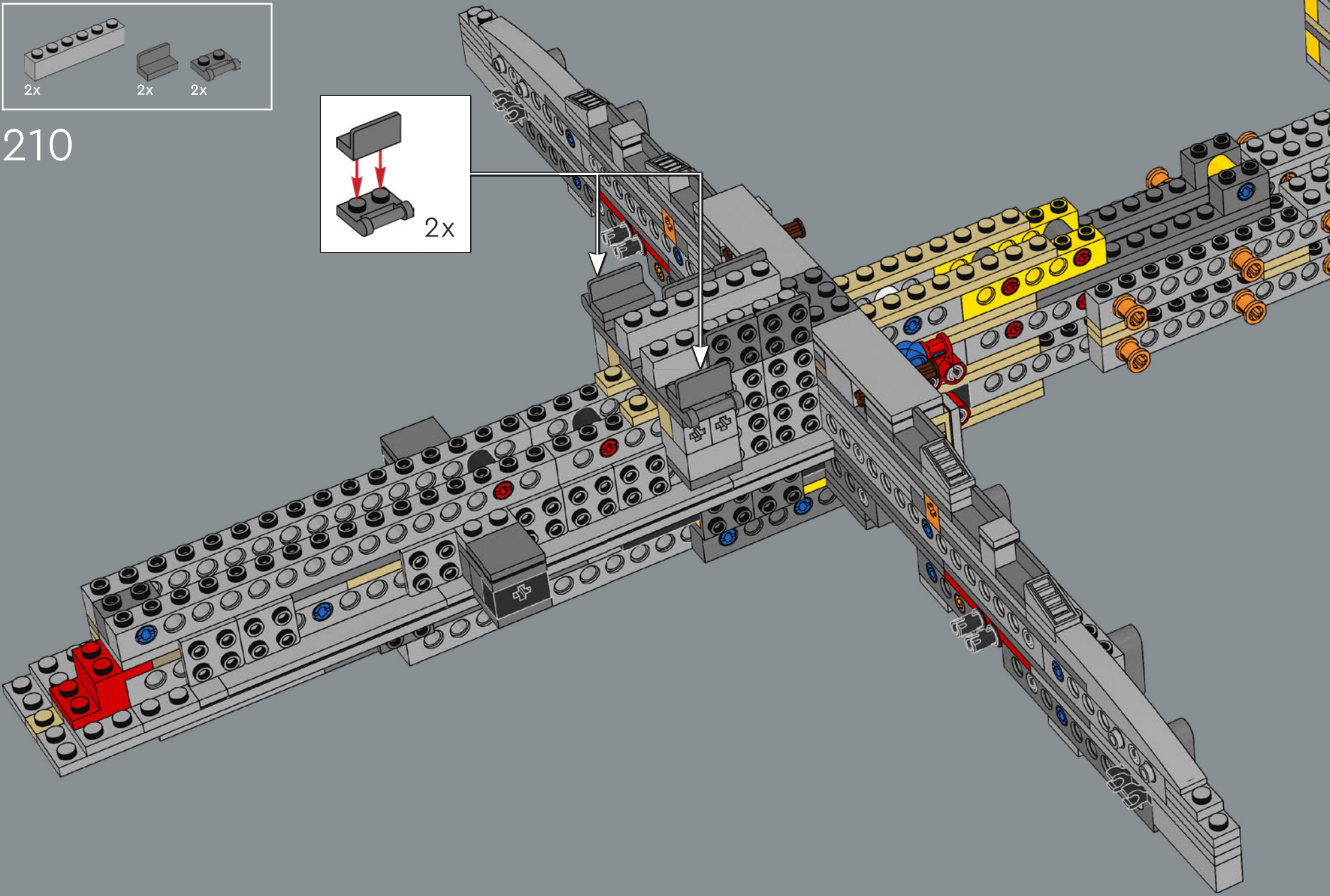
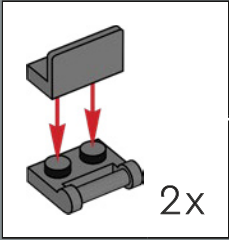

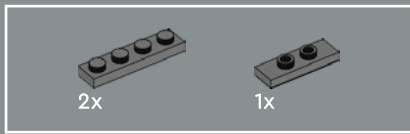

211

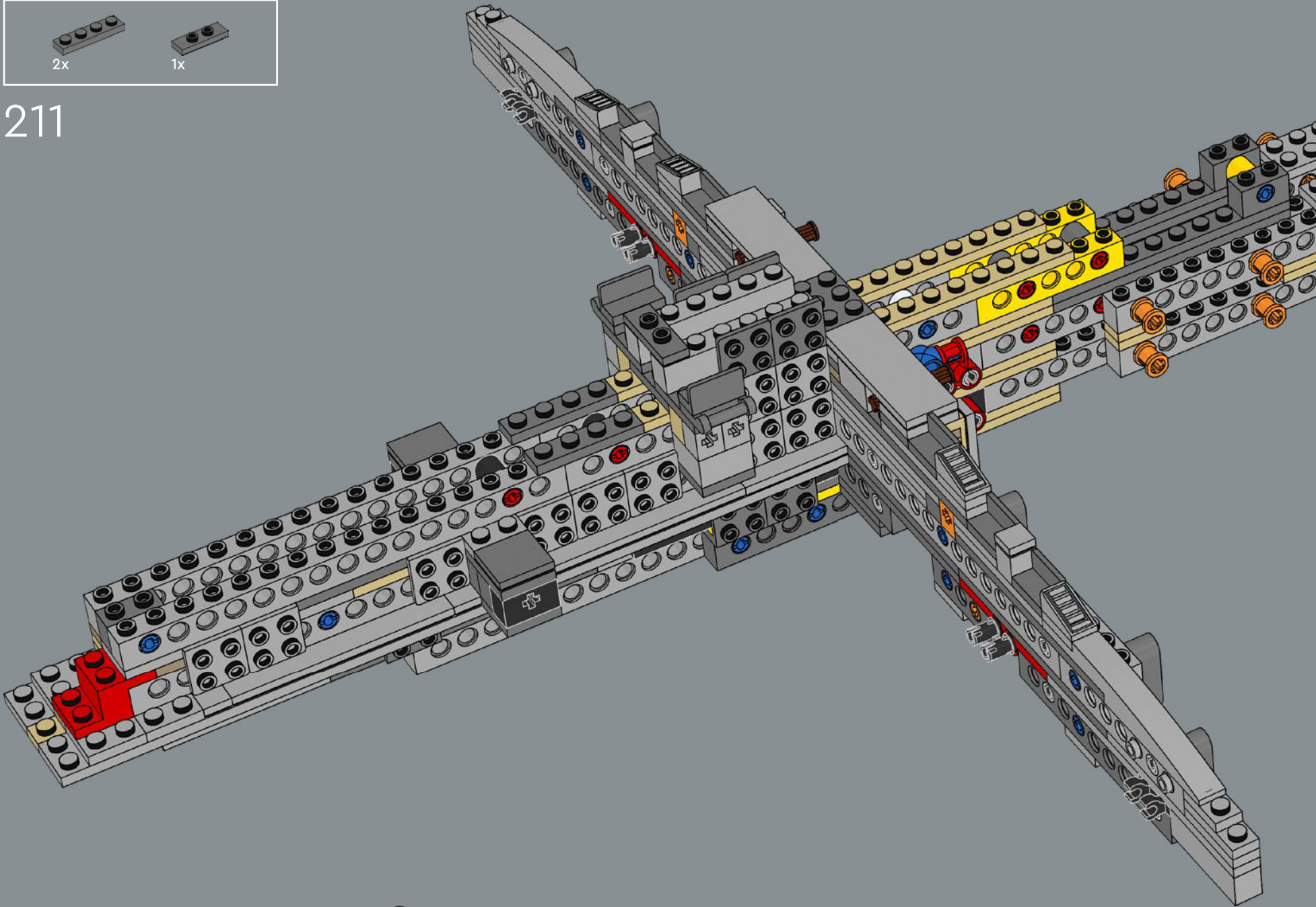

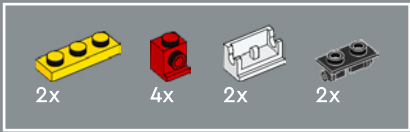

212

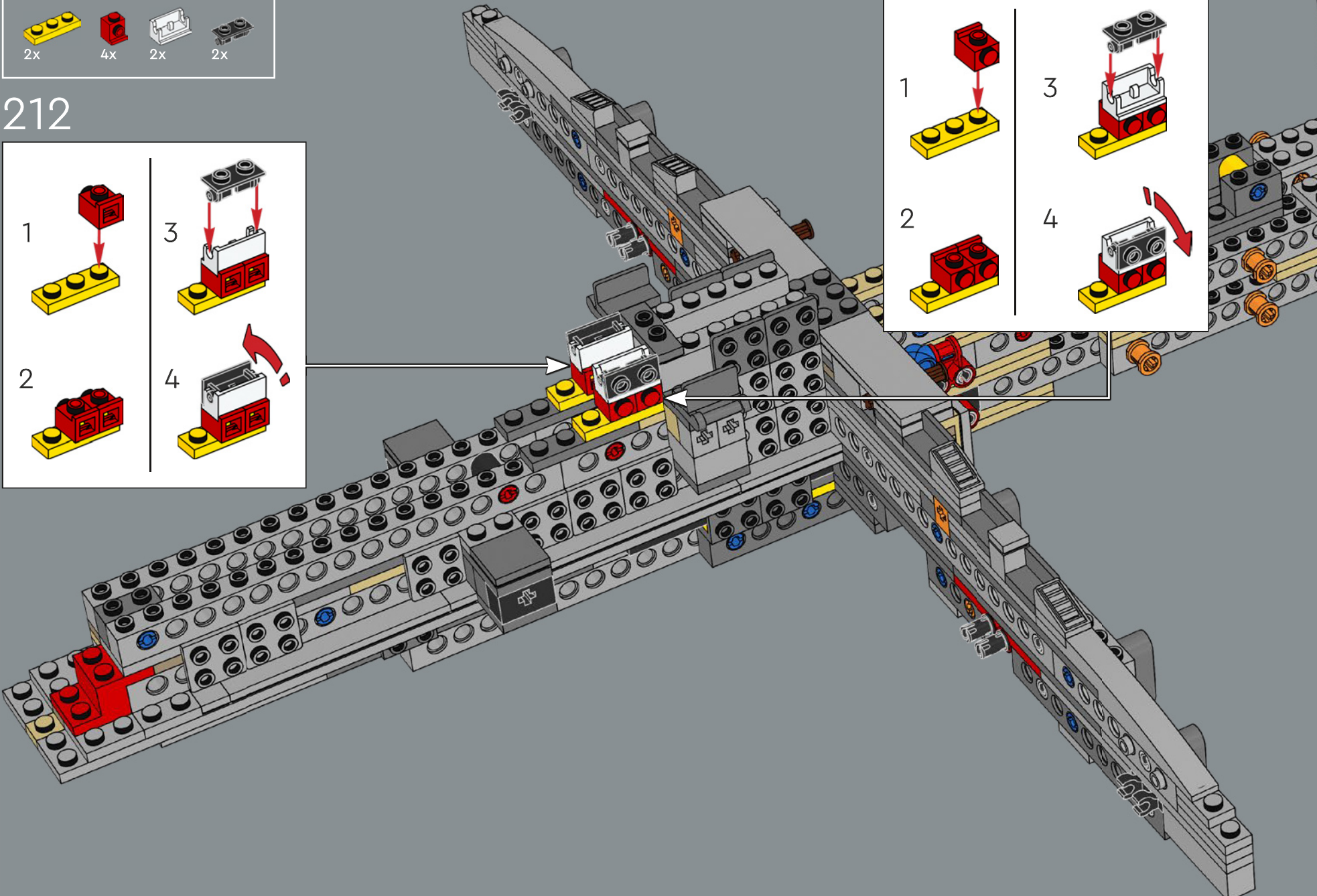
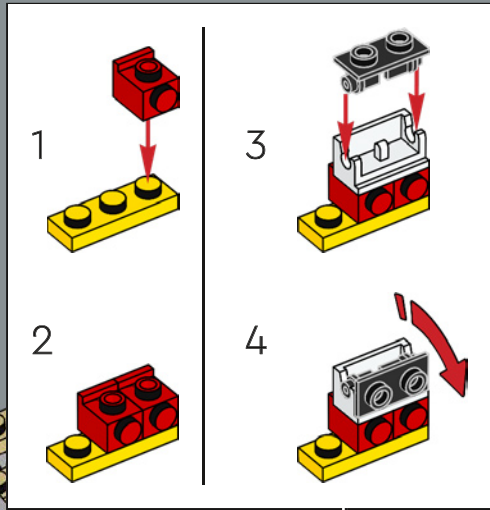
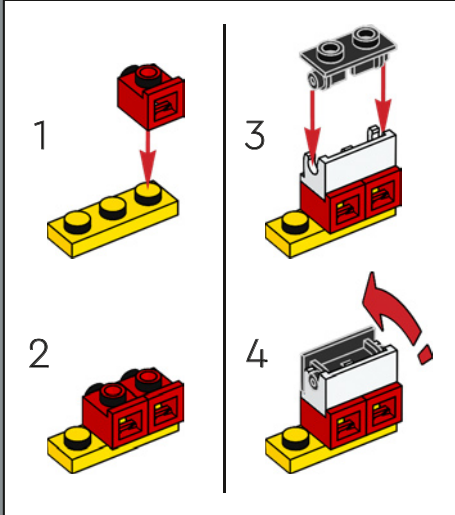

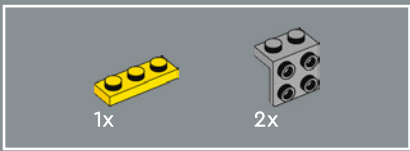

213

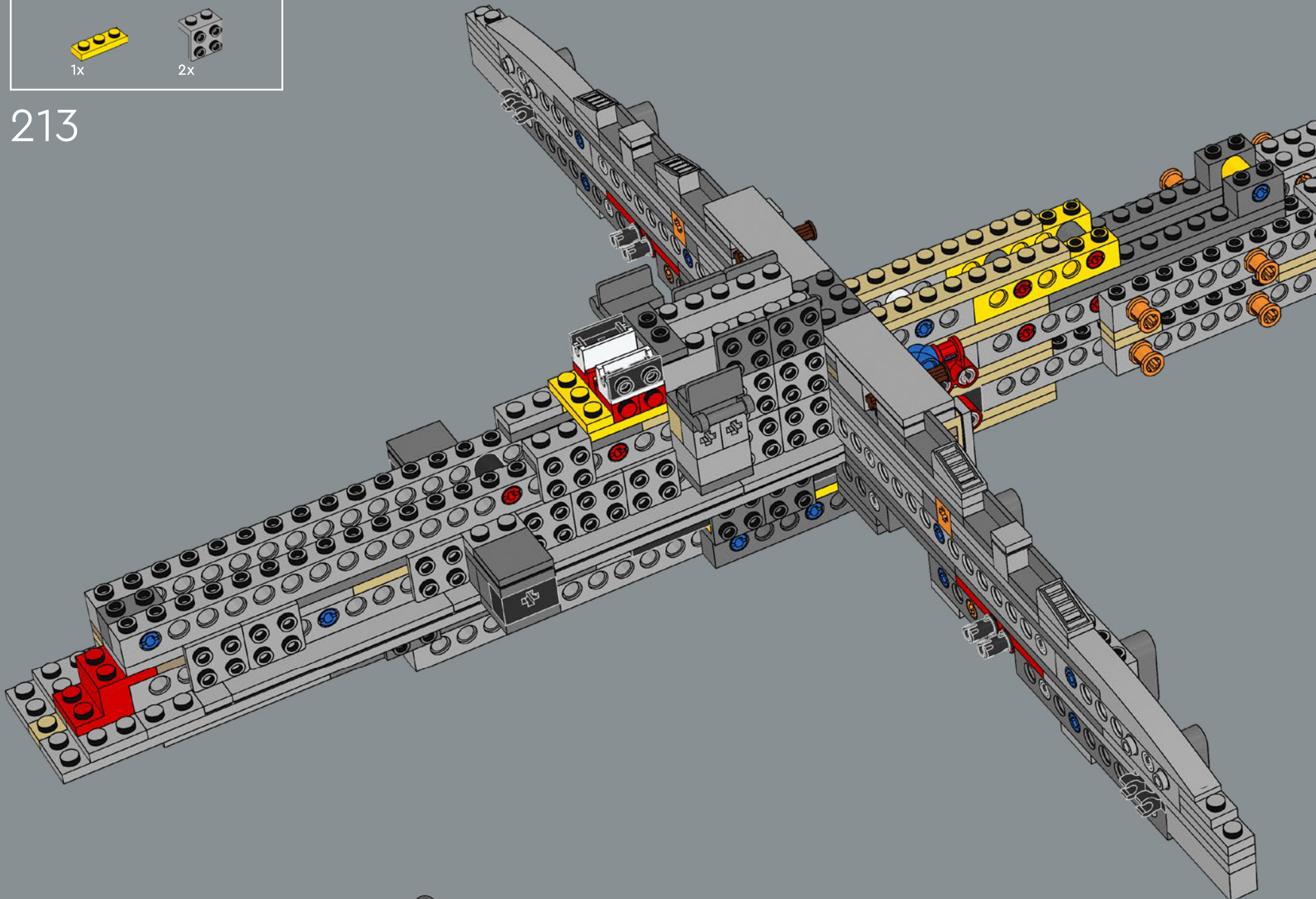

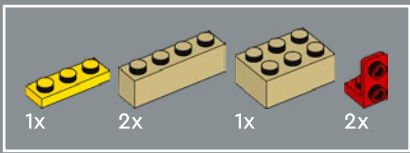

214

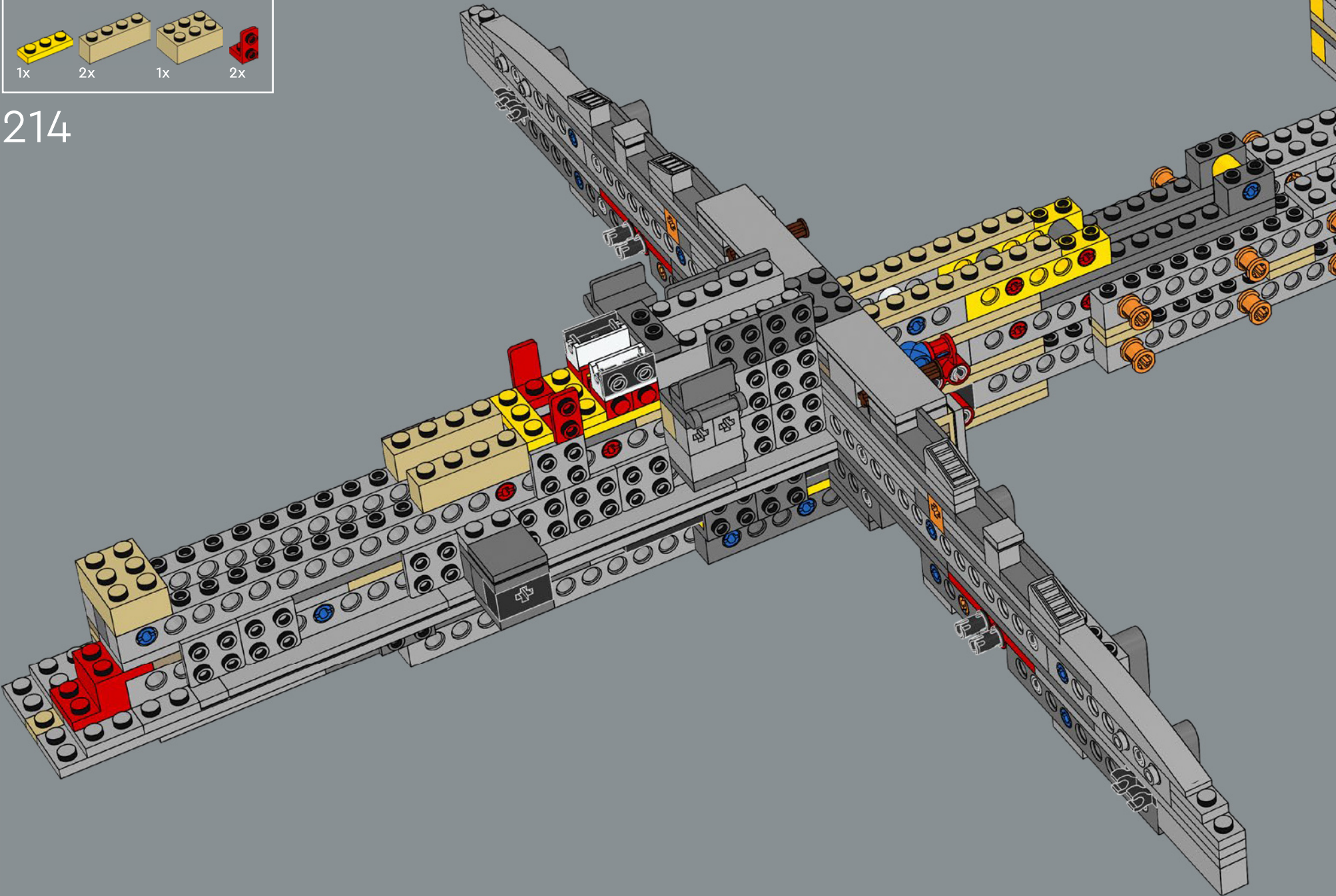



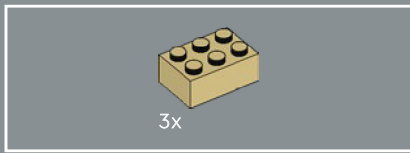

215



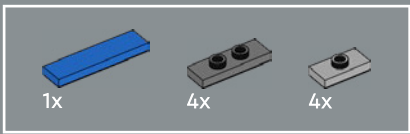

216

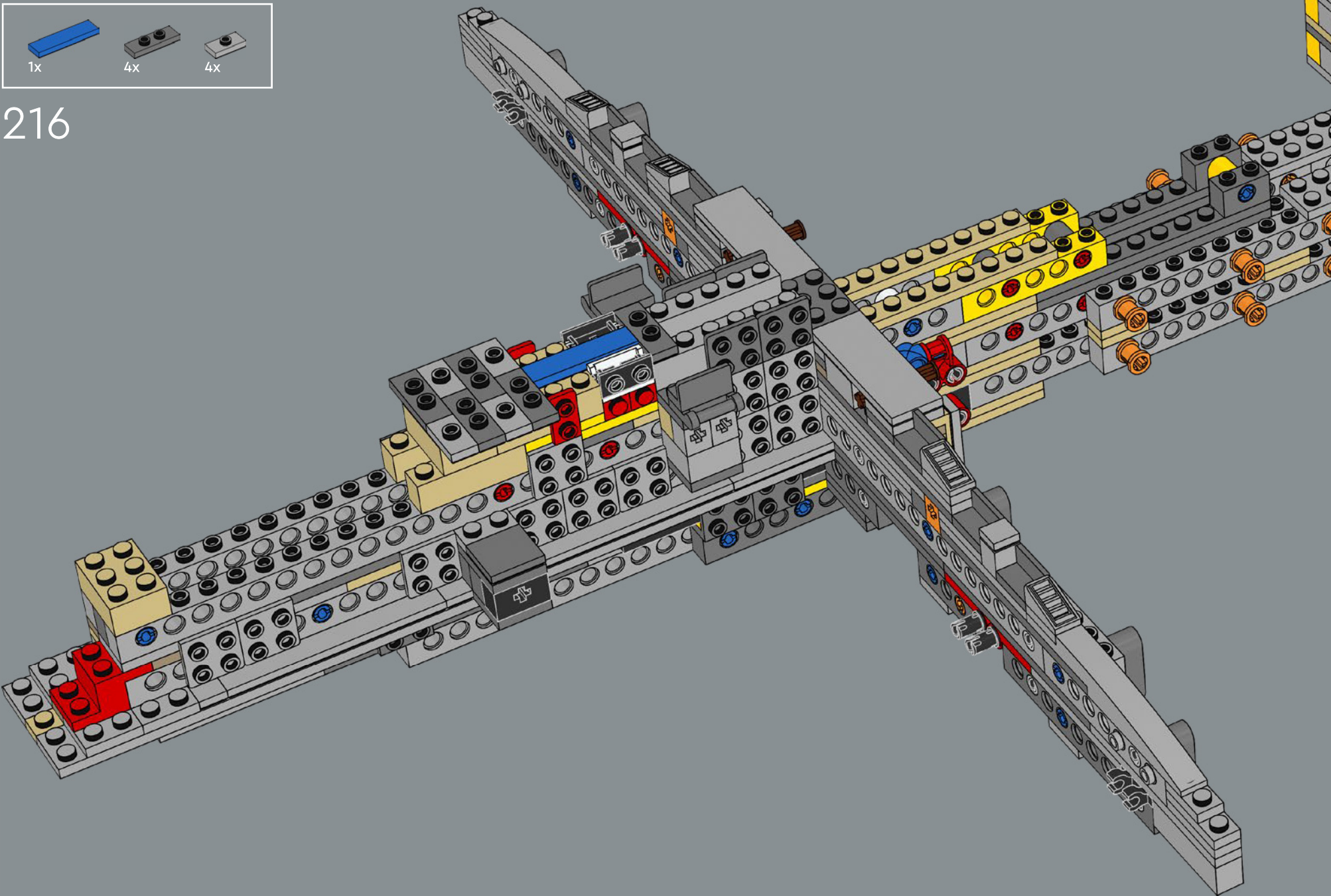

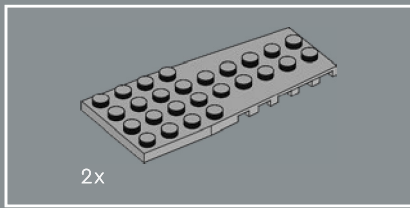

217

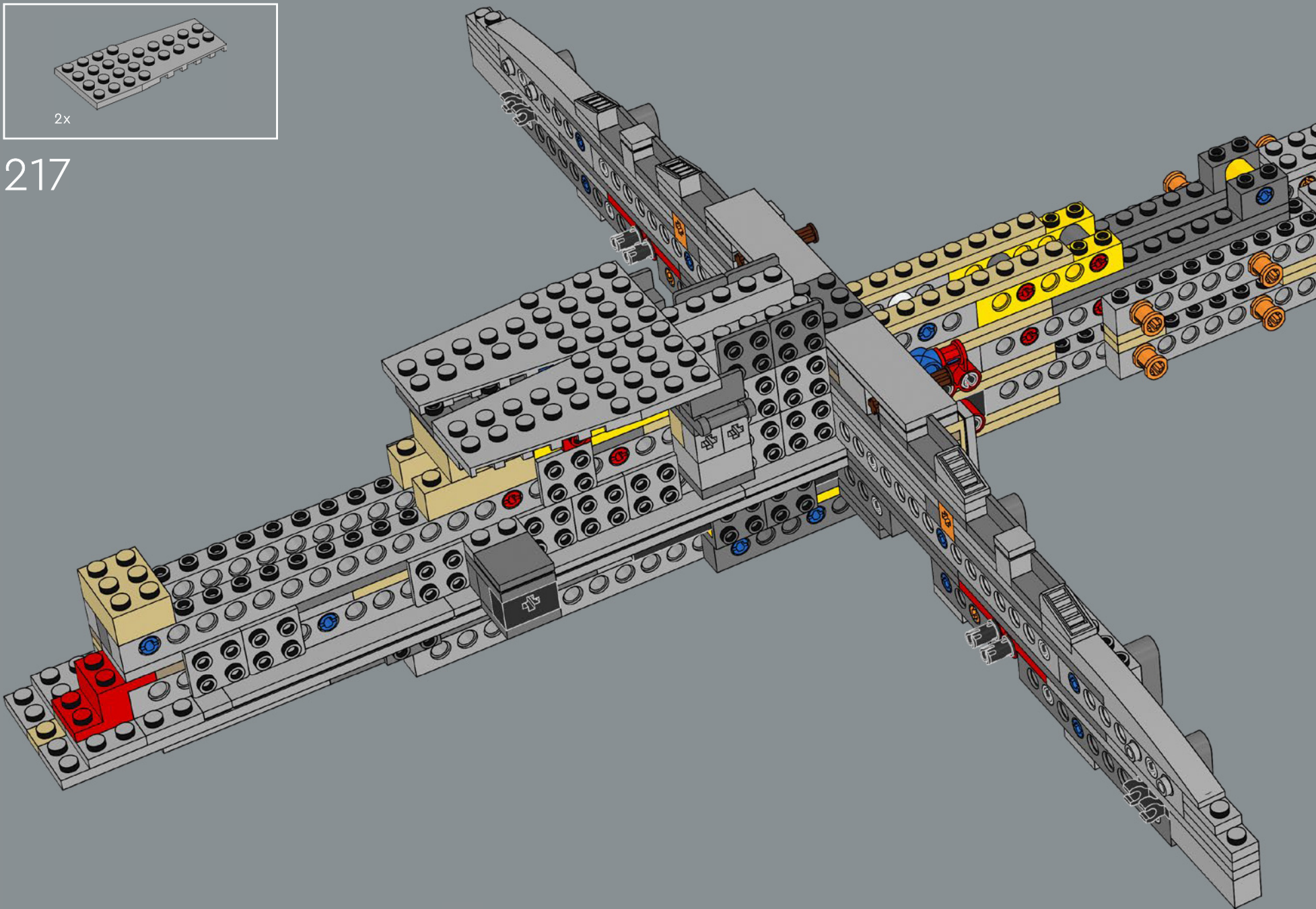

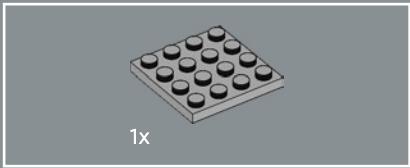

218

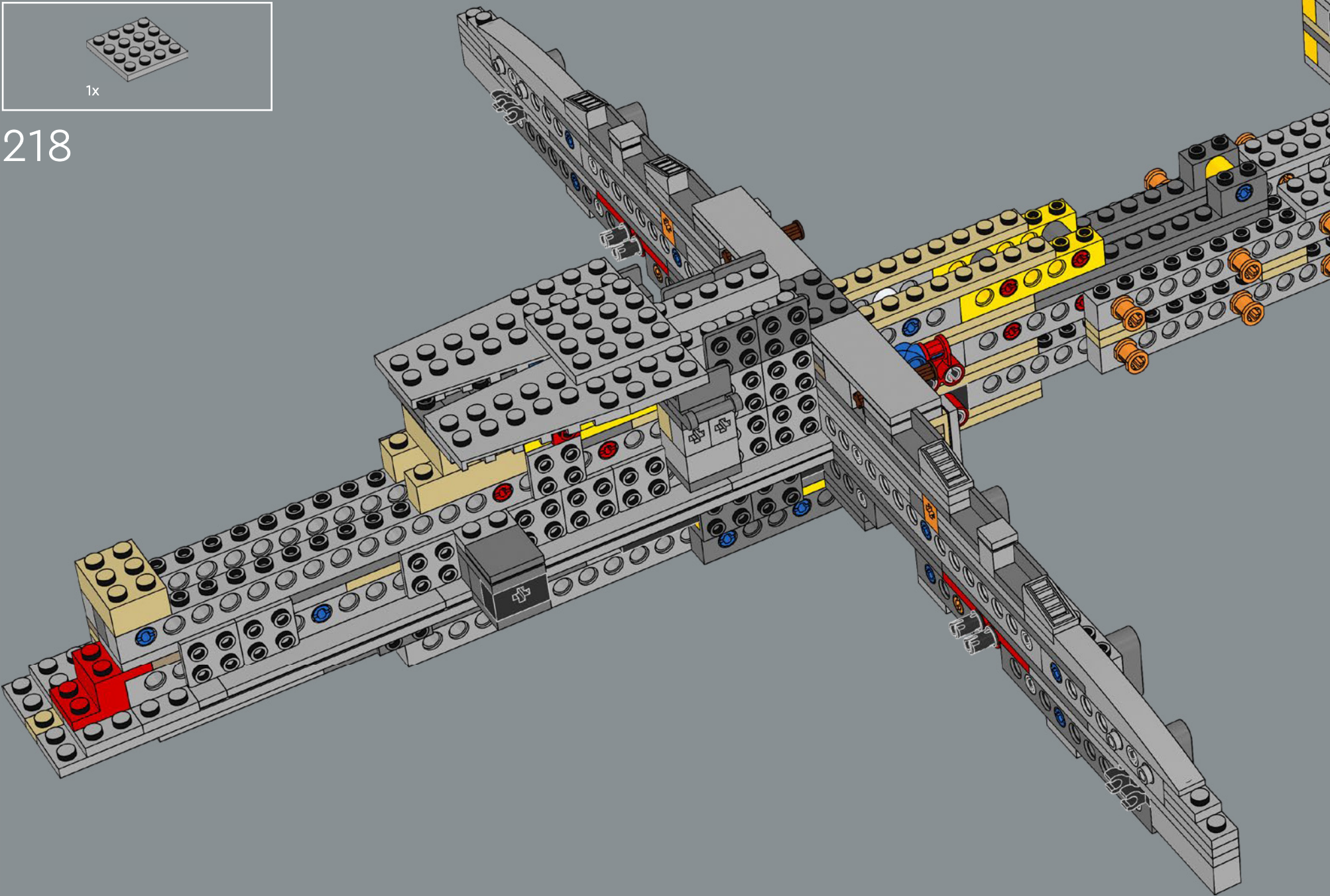

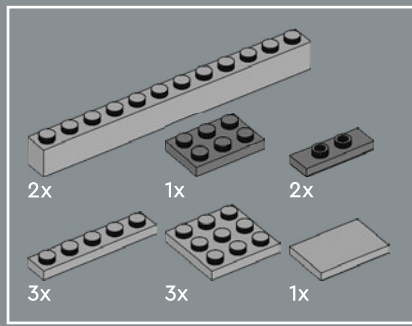

219

1

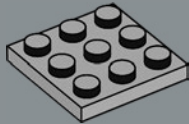

2

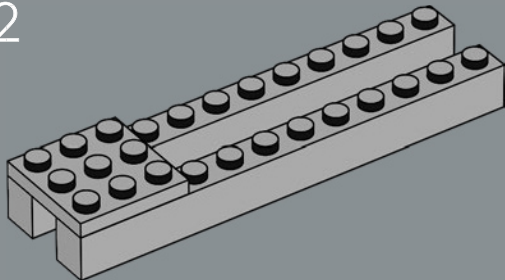

3

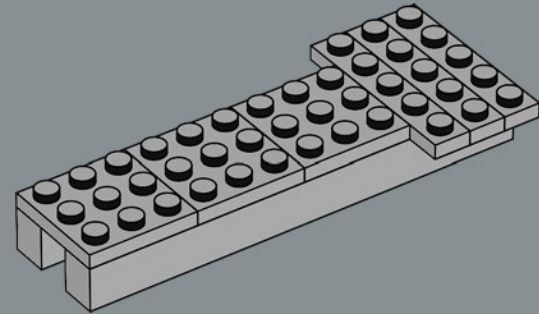

4

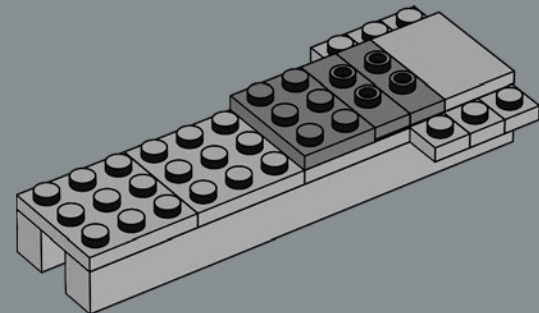

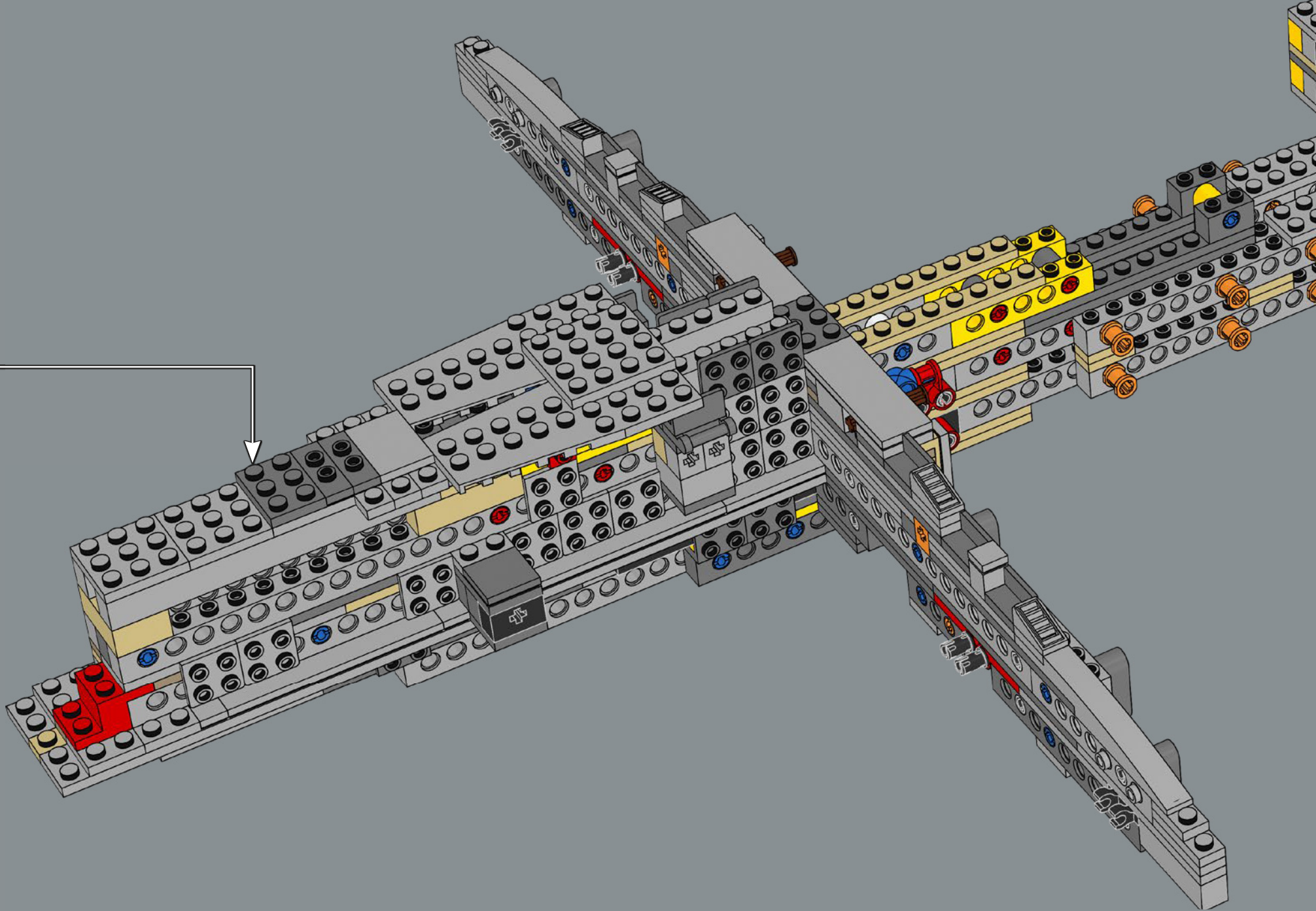

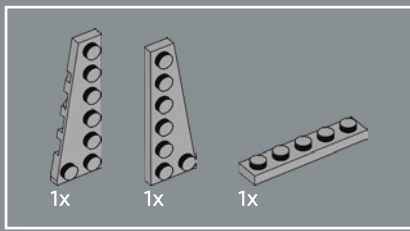

220

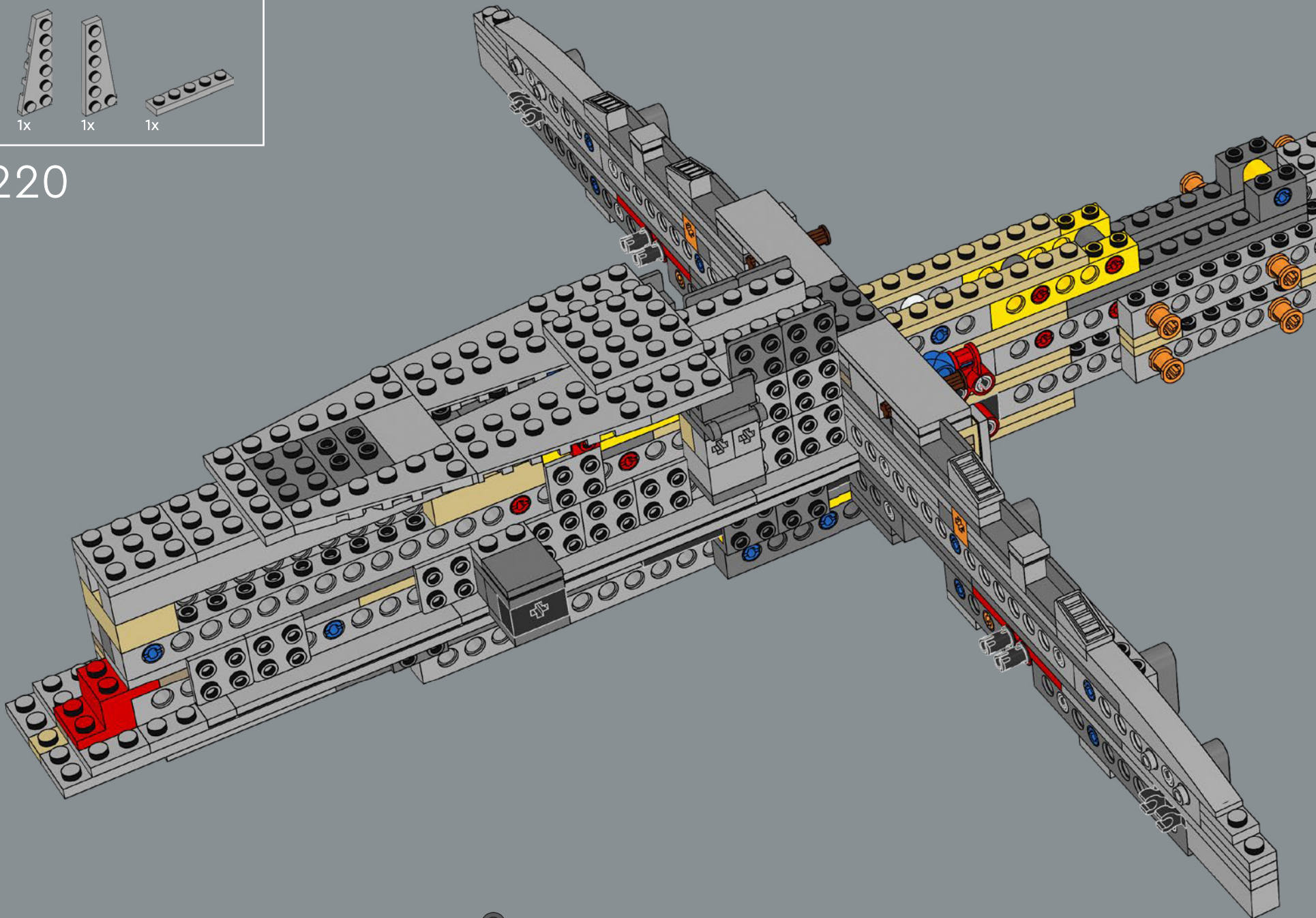





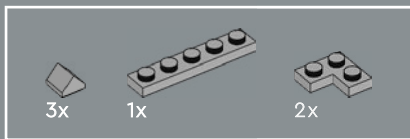

222

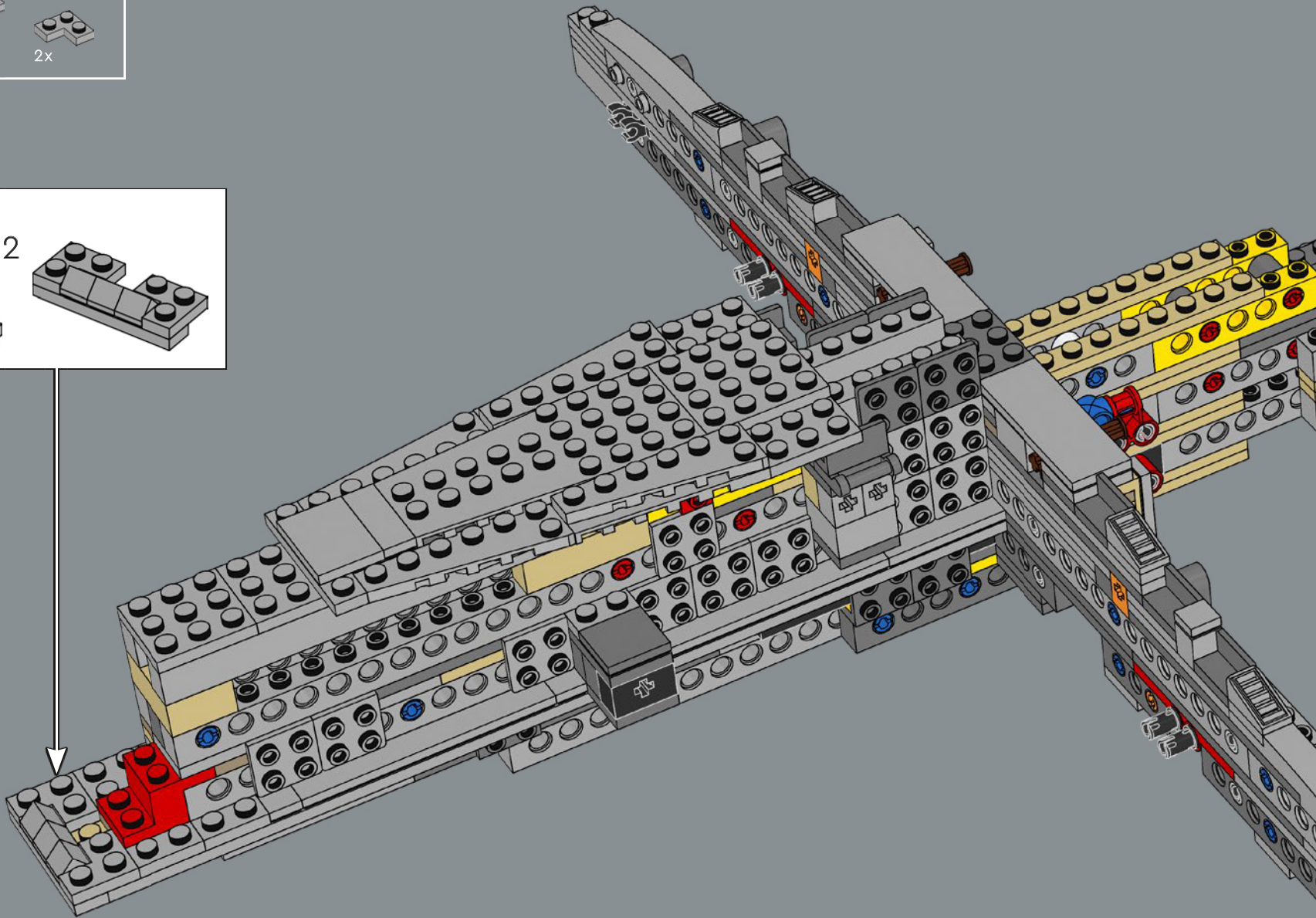
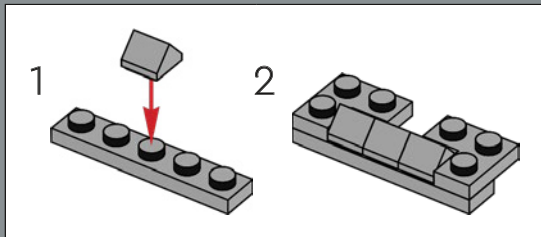

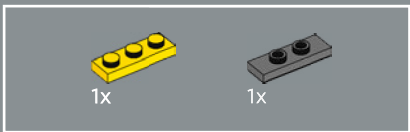

223

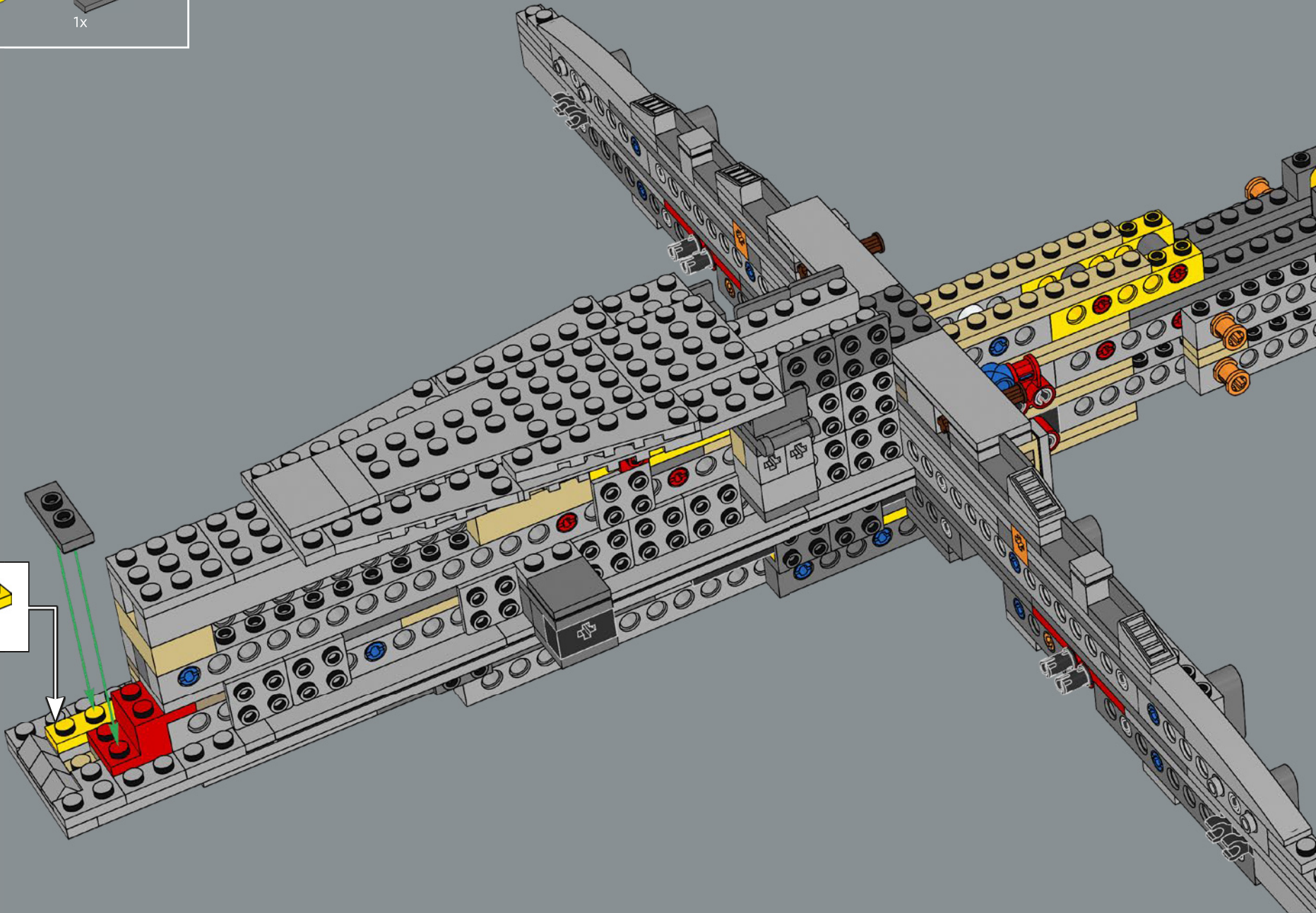
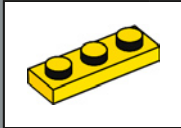

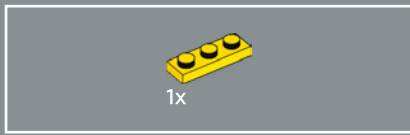

224

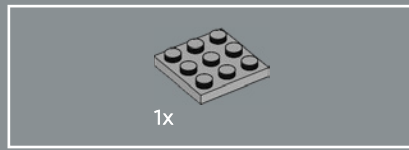

226



228

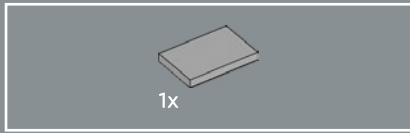
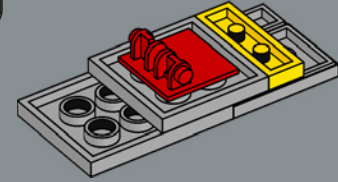

225

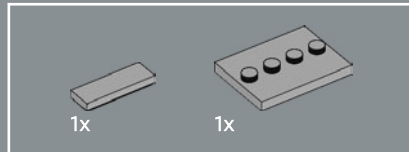

227

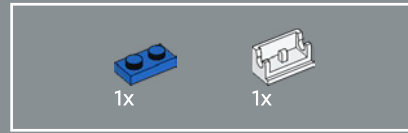
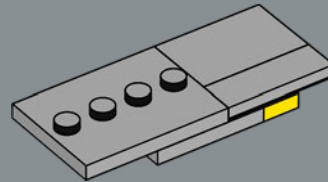

229

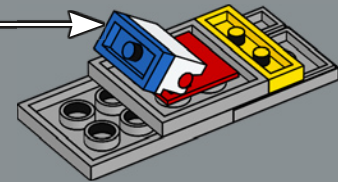
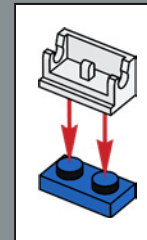

230

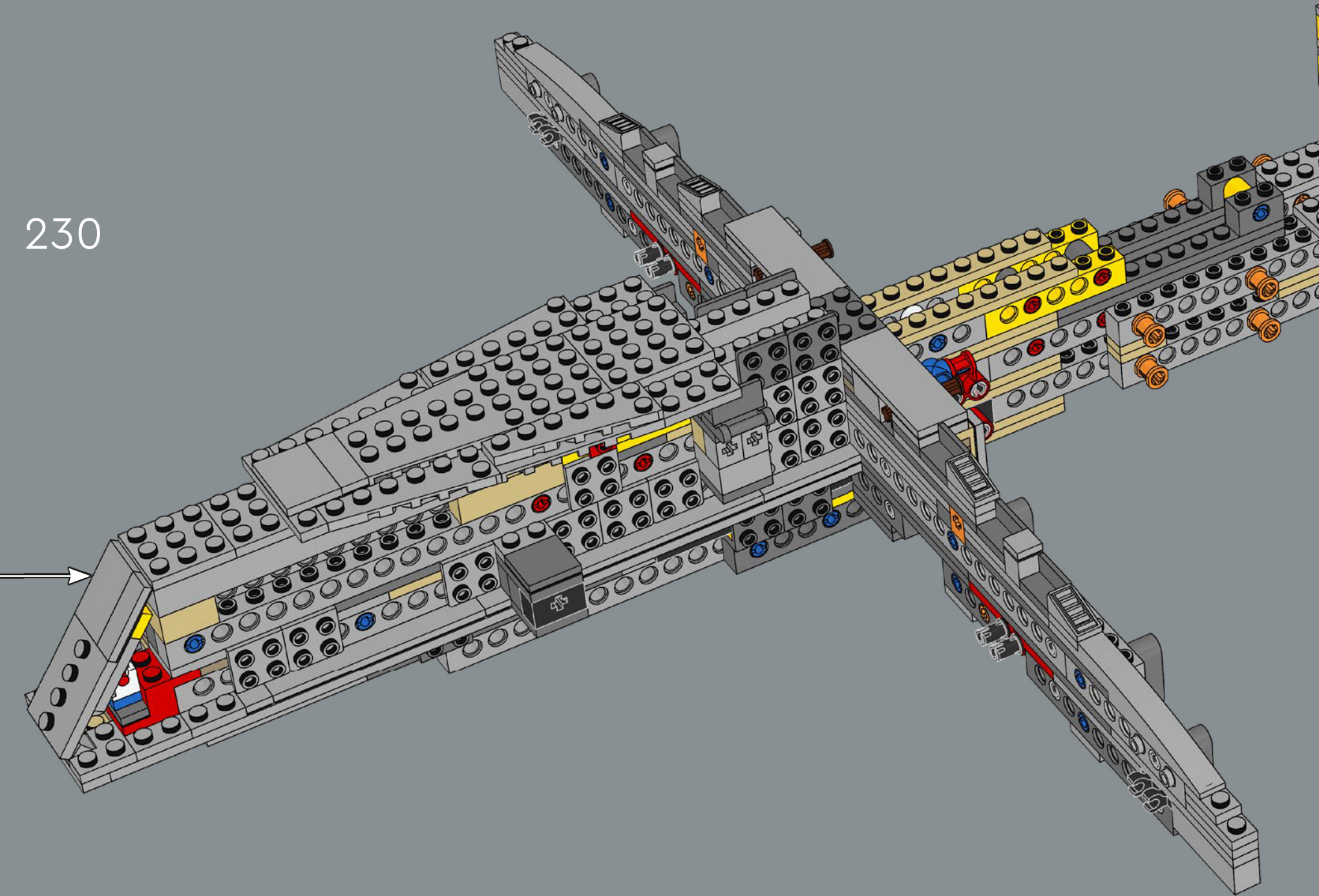

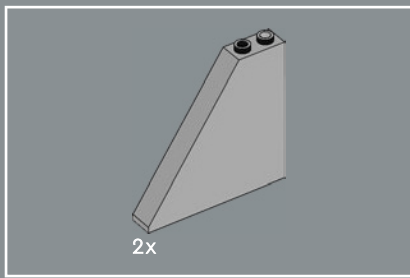

231

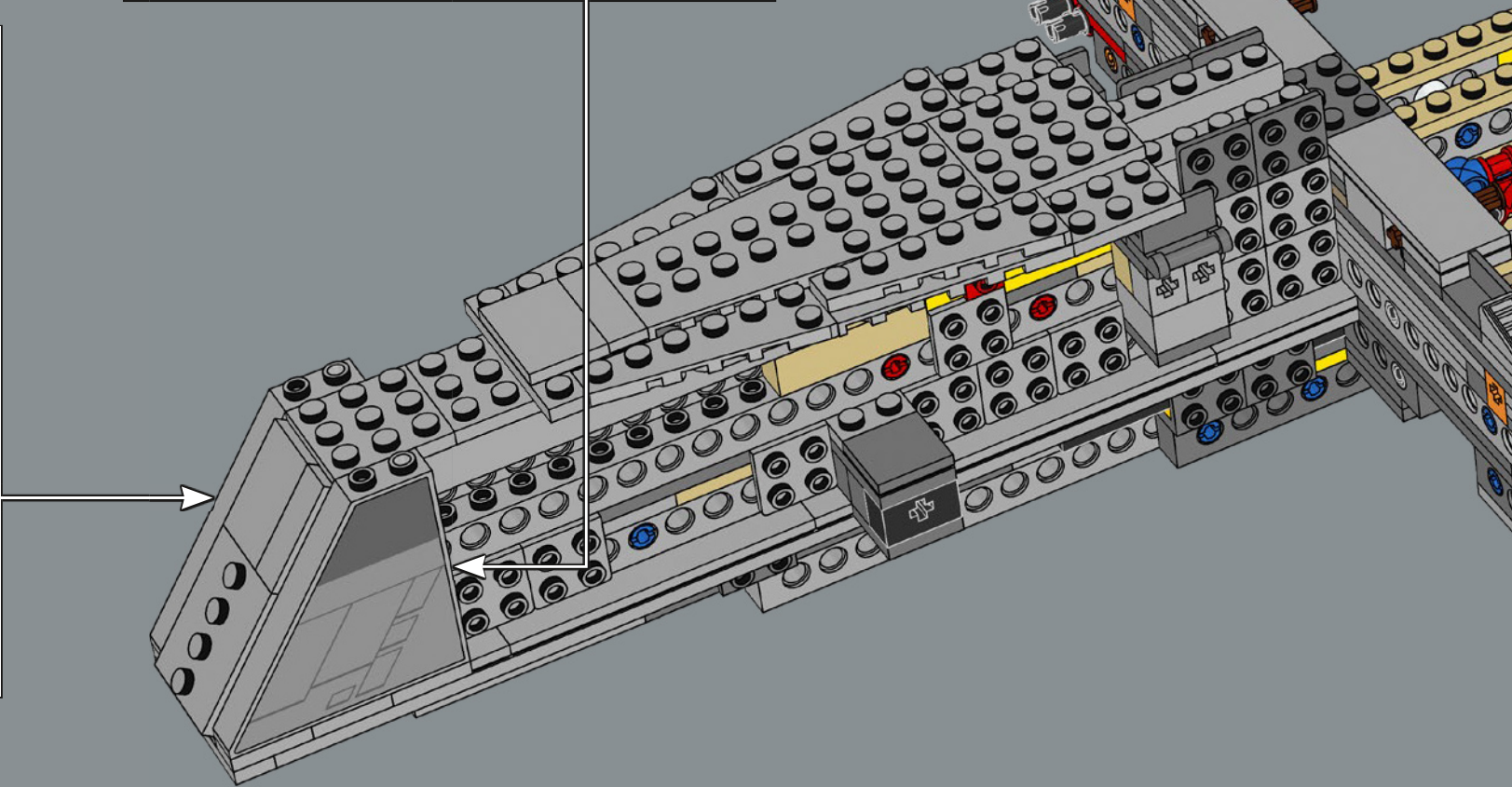
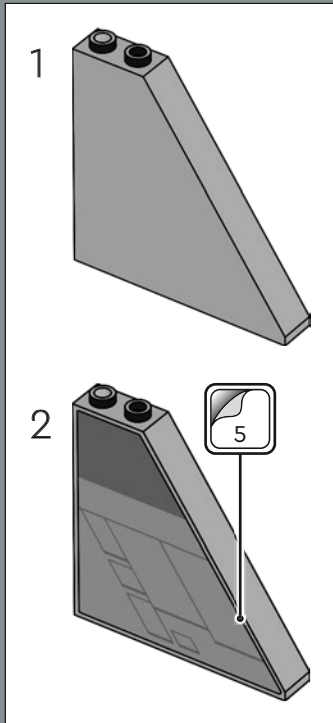
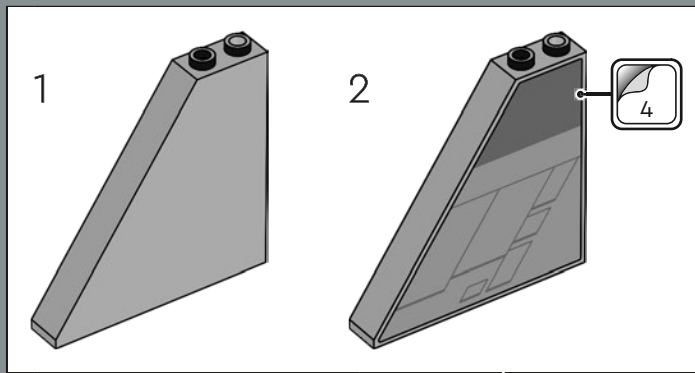

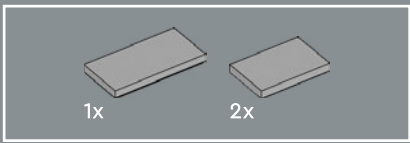

232

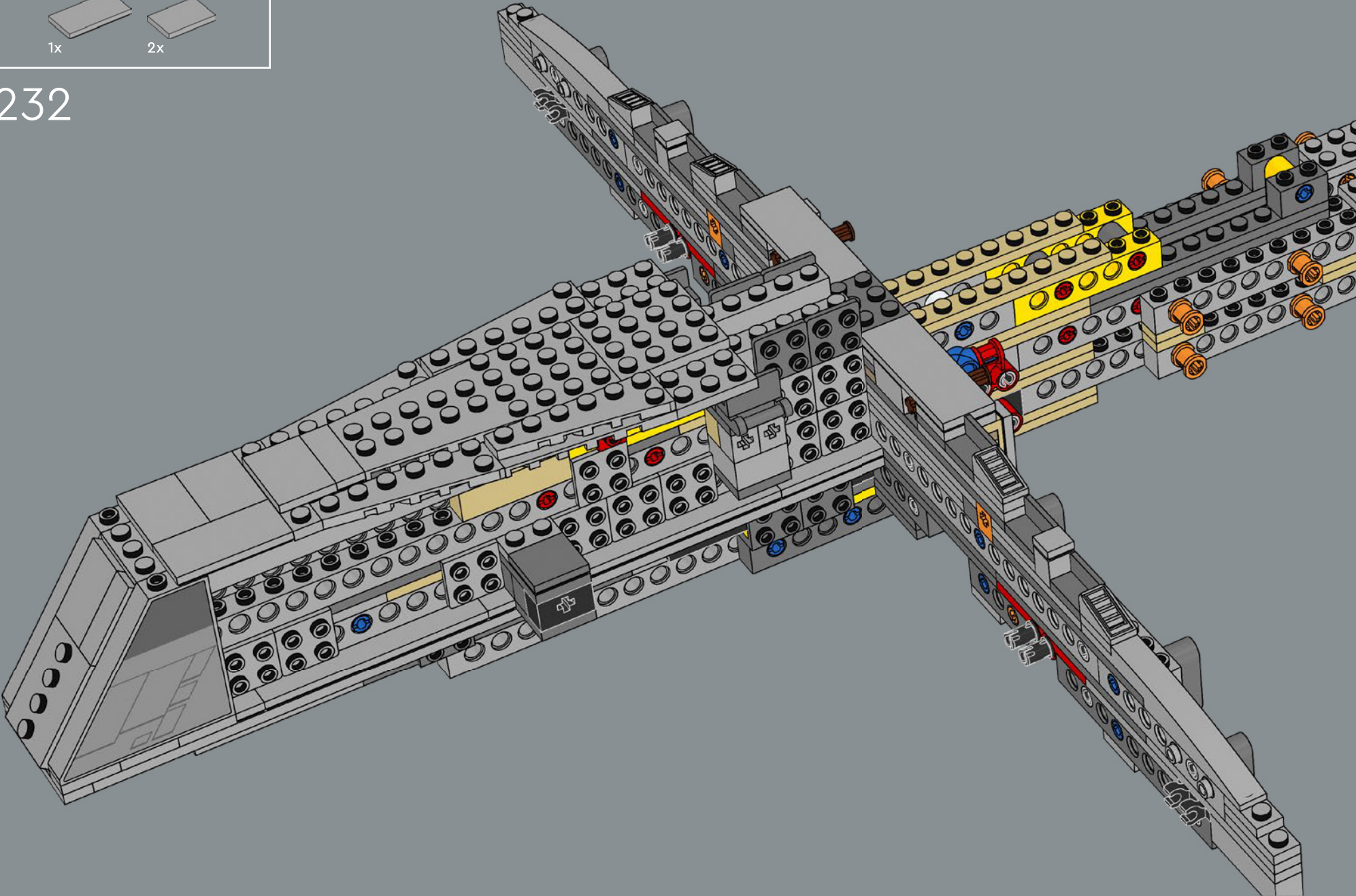

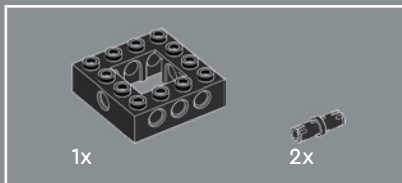
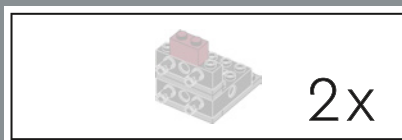

233

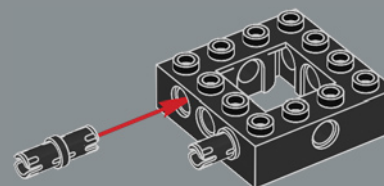

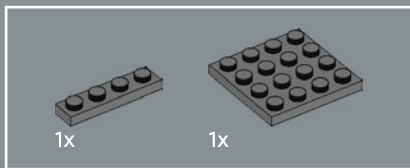

234

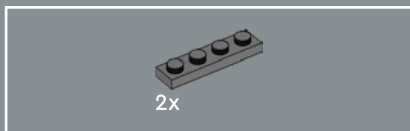

235

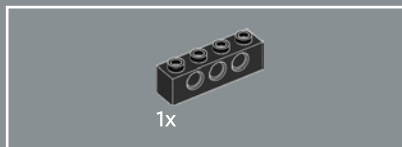
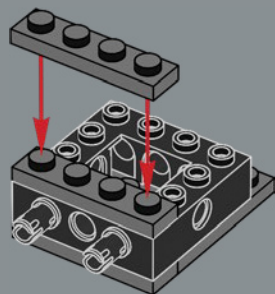

236

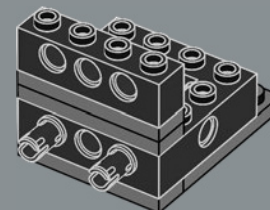

237

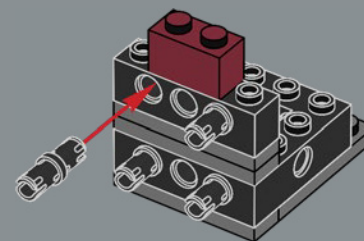

2x



238

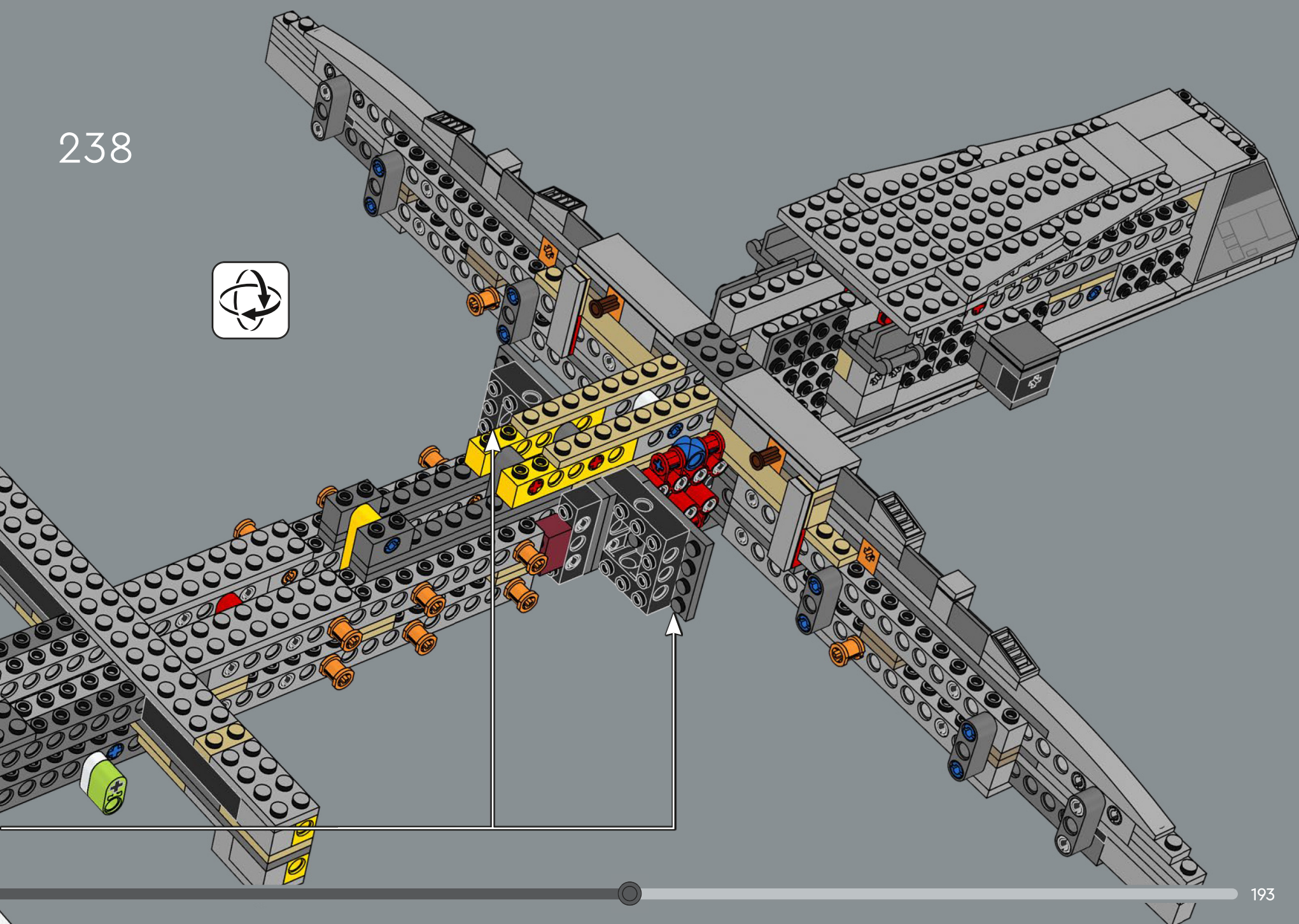

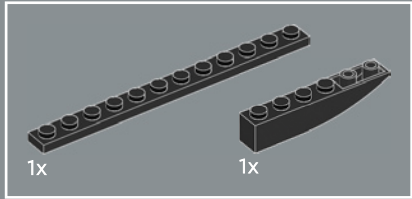
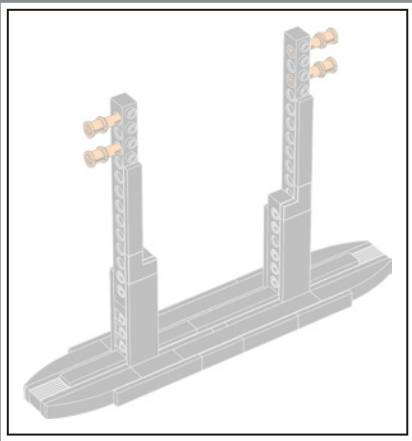

239

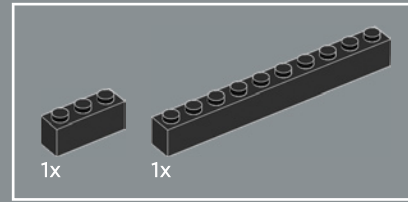
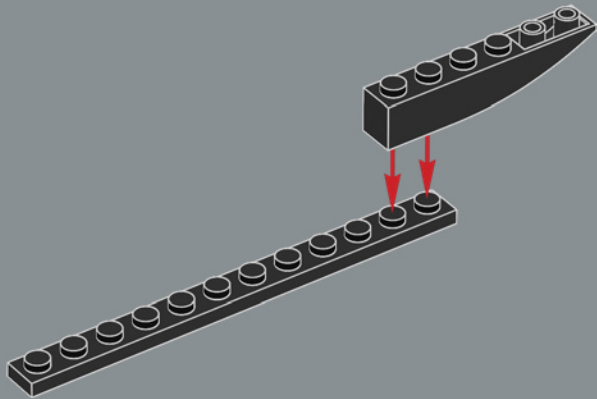

240

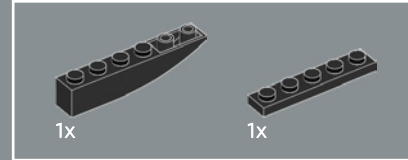
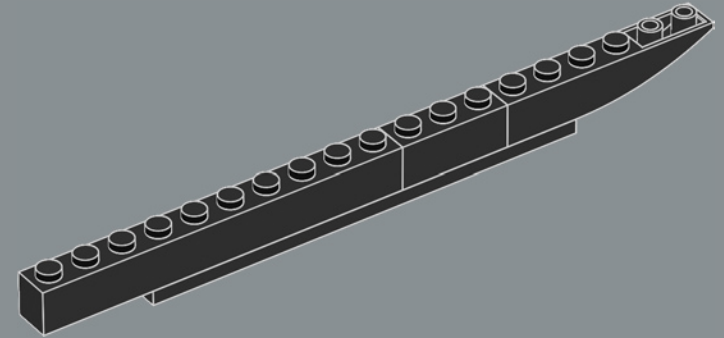

241

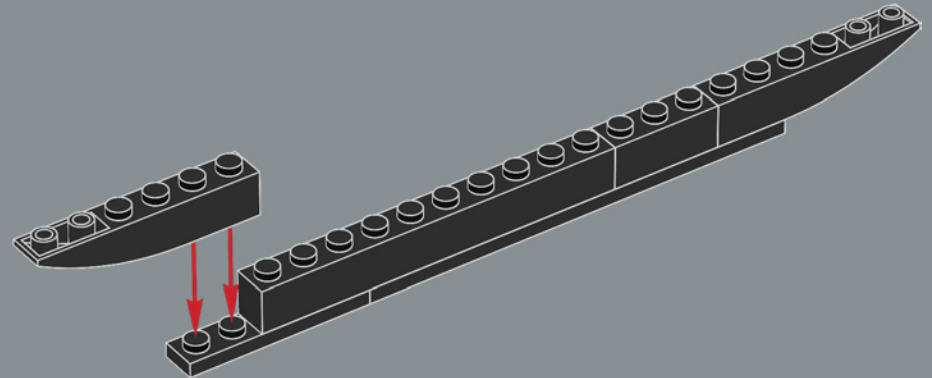

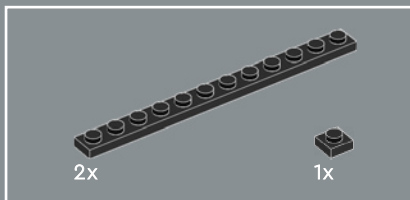

242

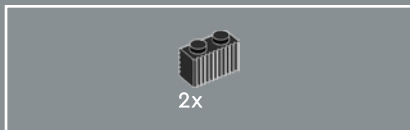
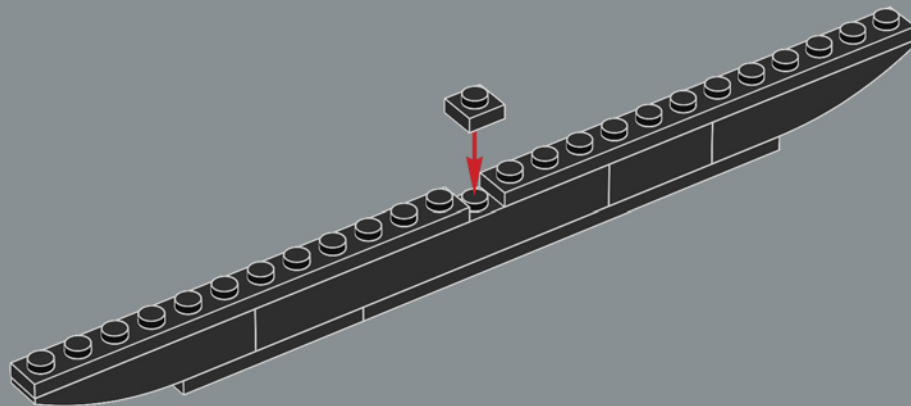

243

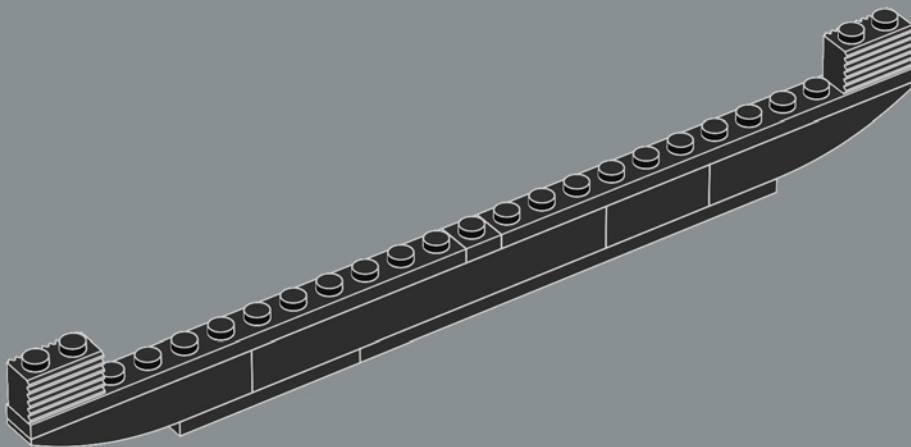

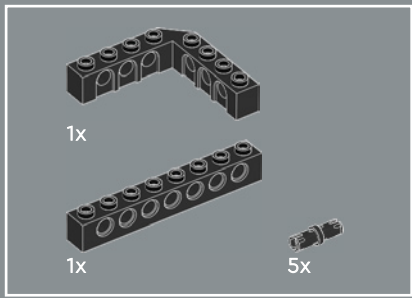

244

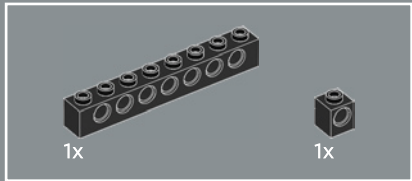
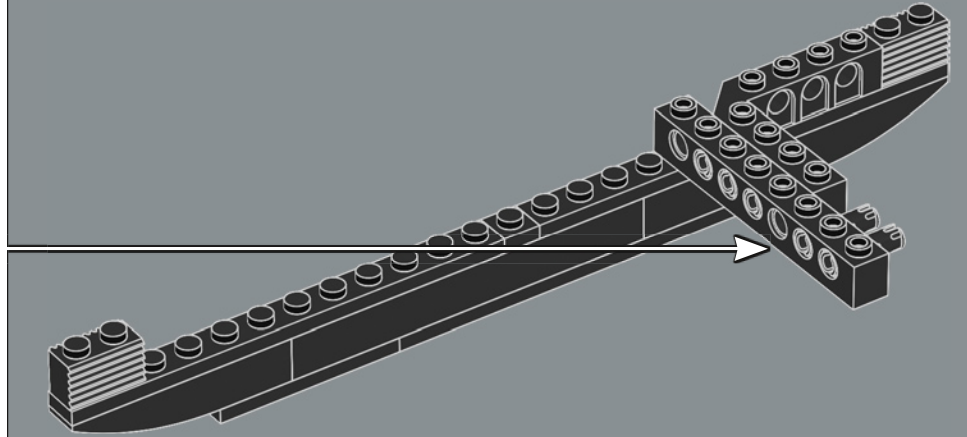
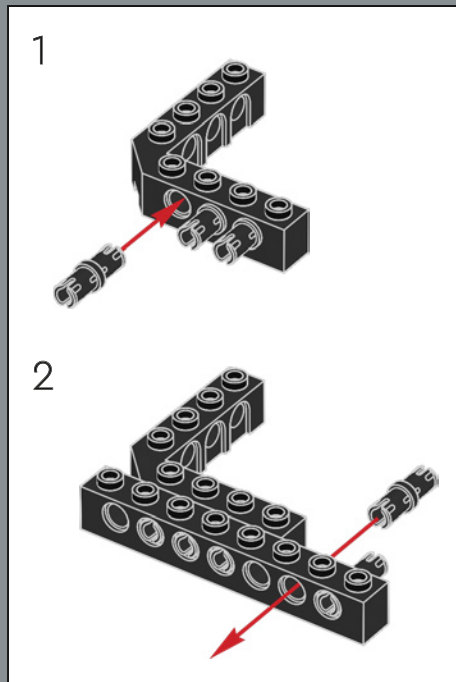

245

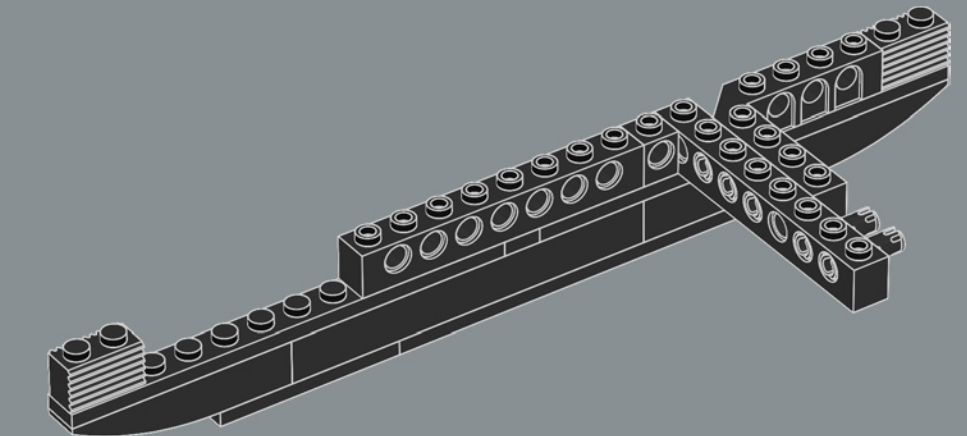

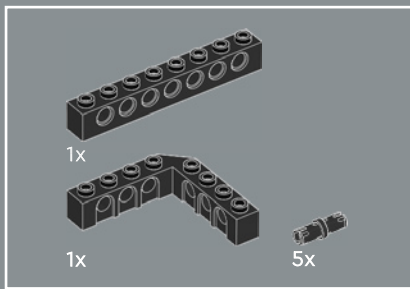

246

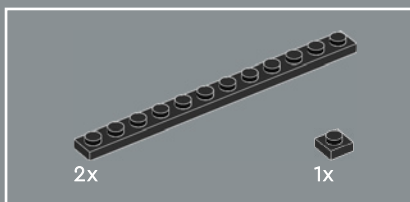
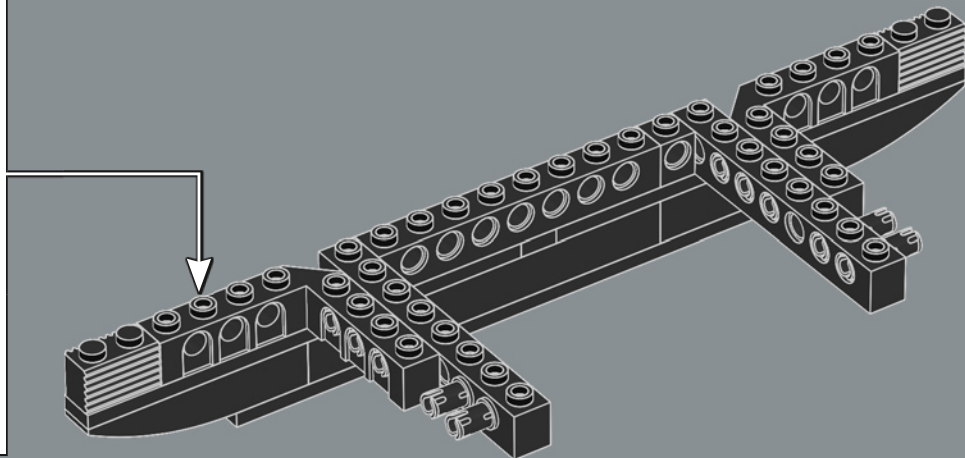
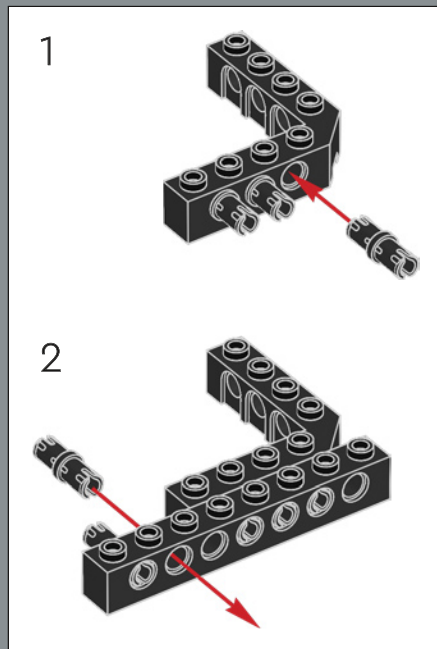

247

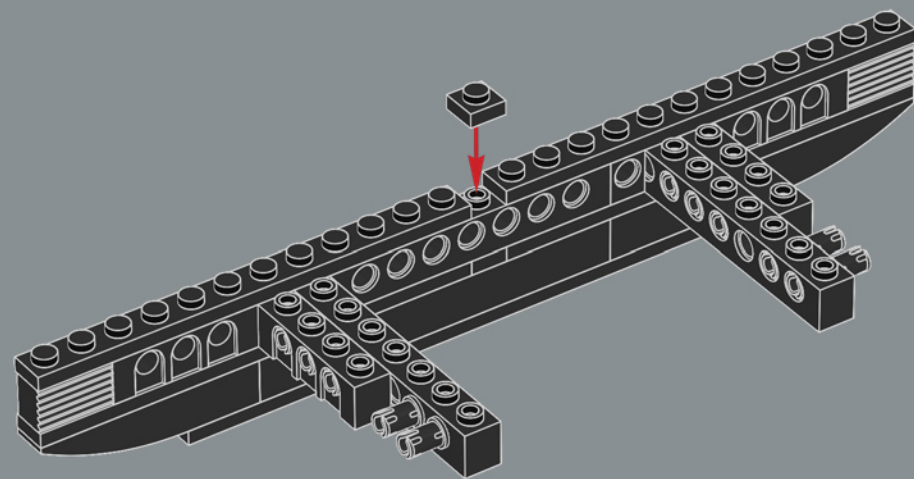

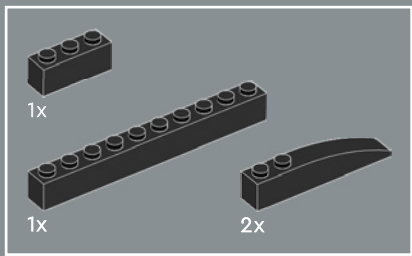

248

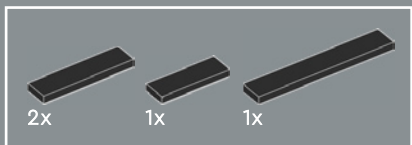
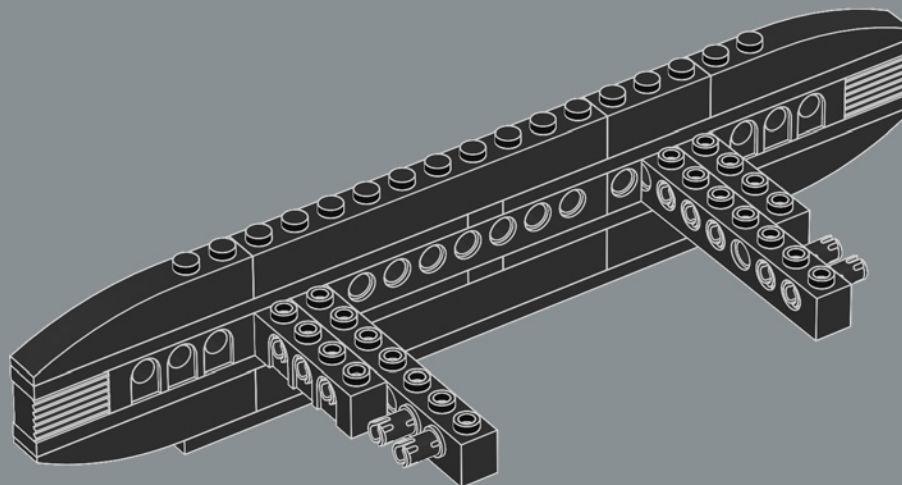

249

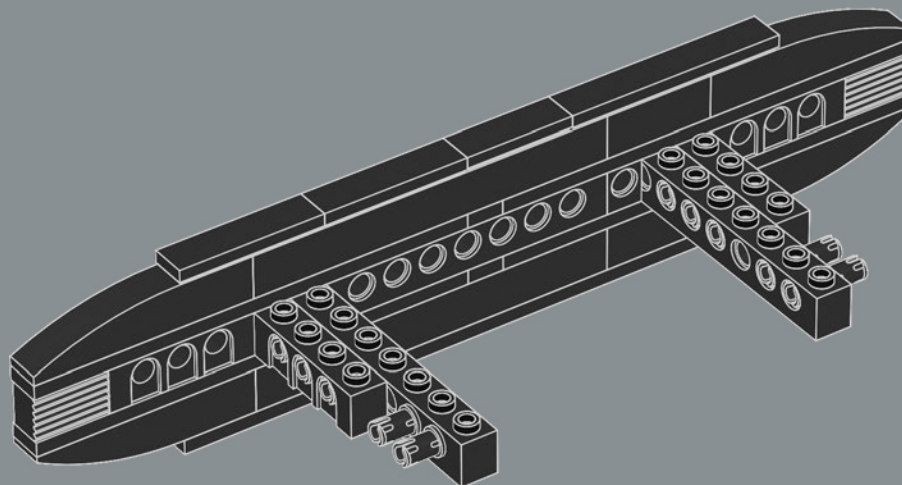



250

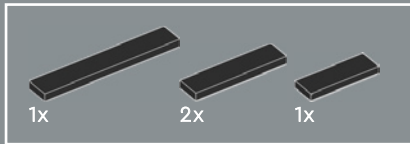
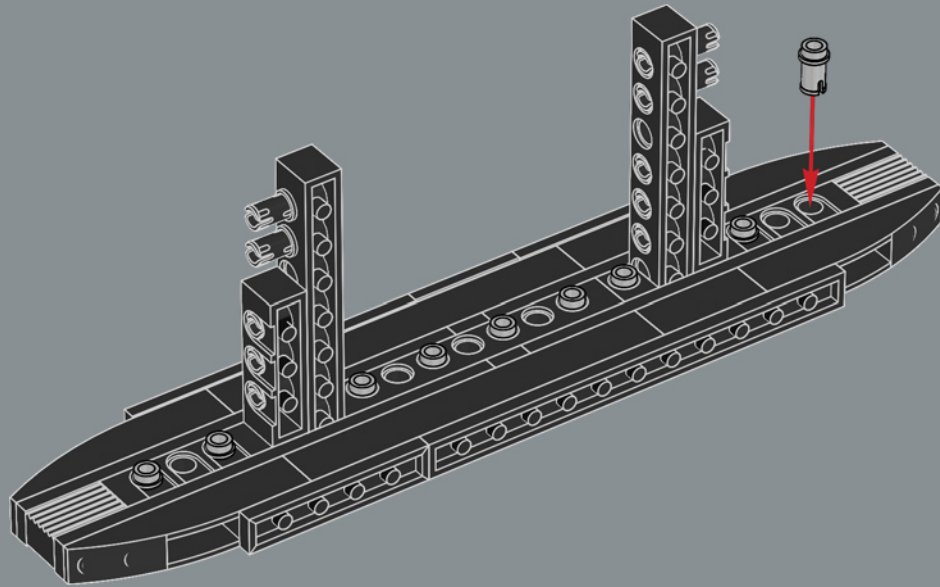

251

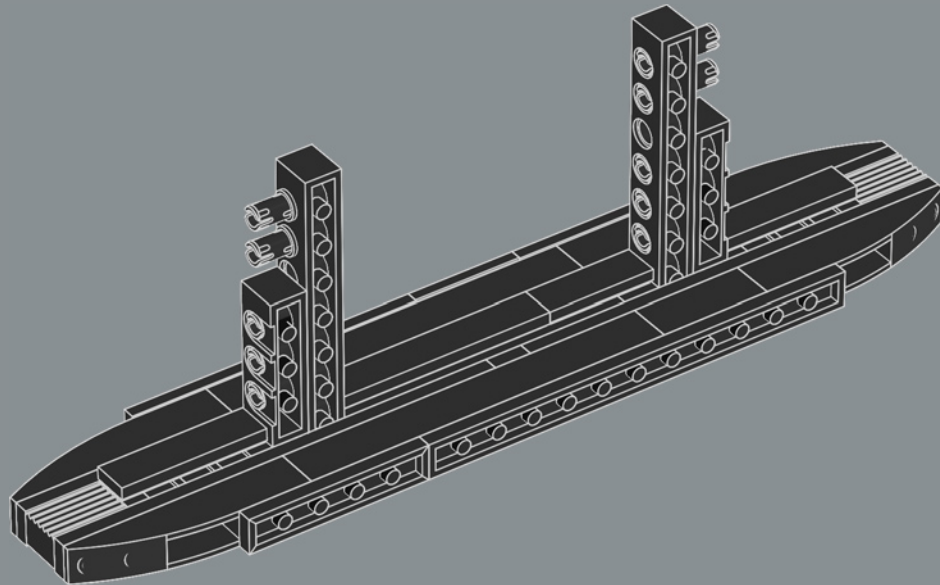

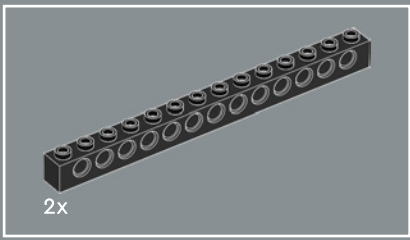

252

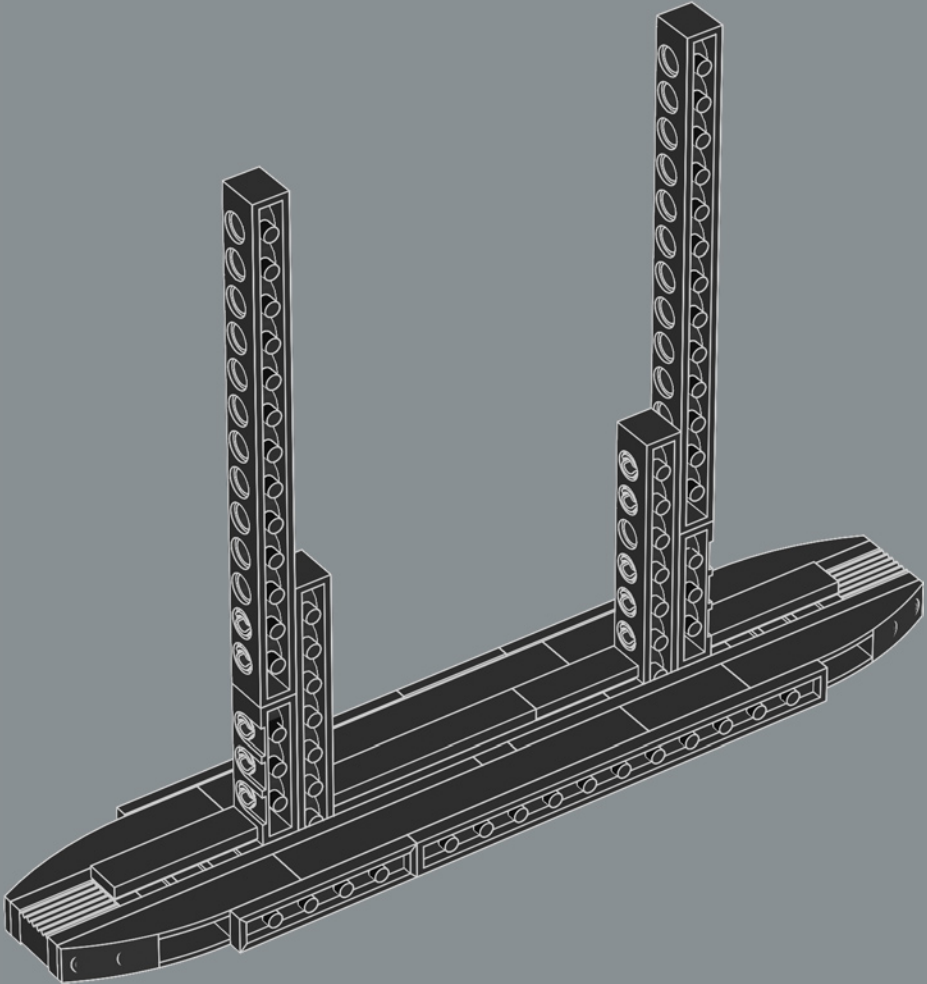



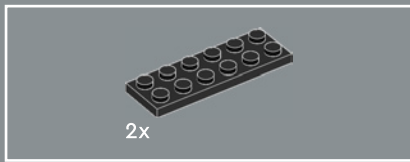

253

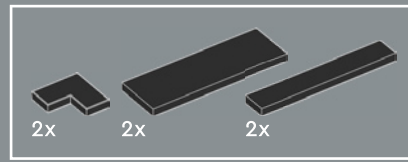
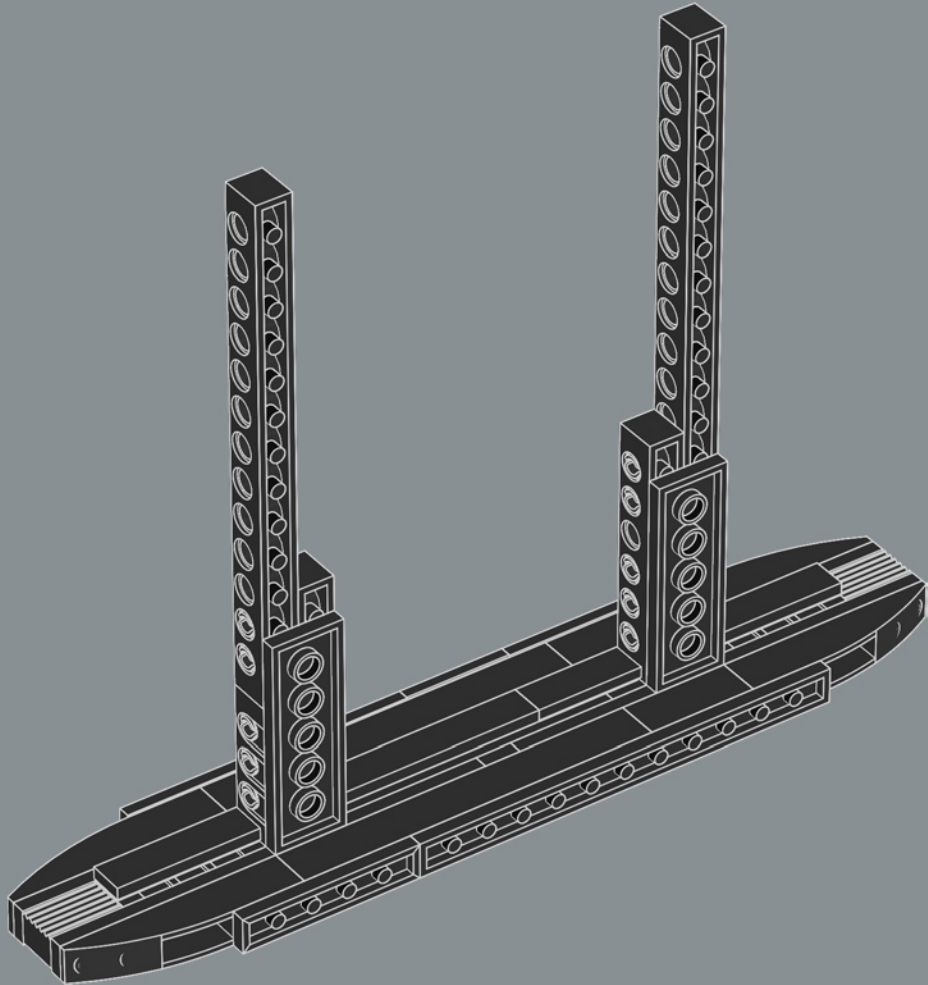

254

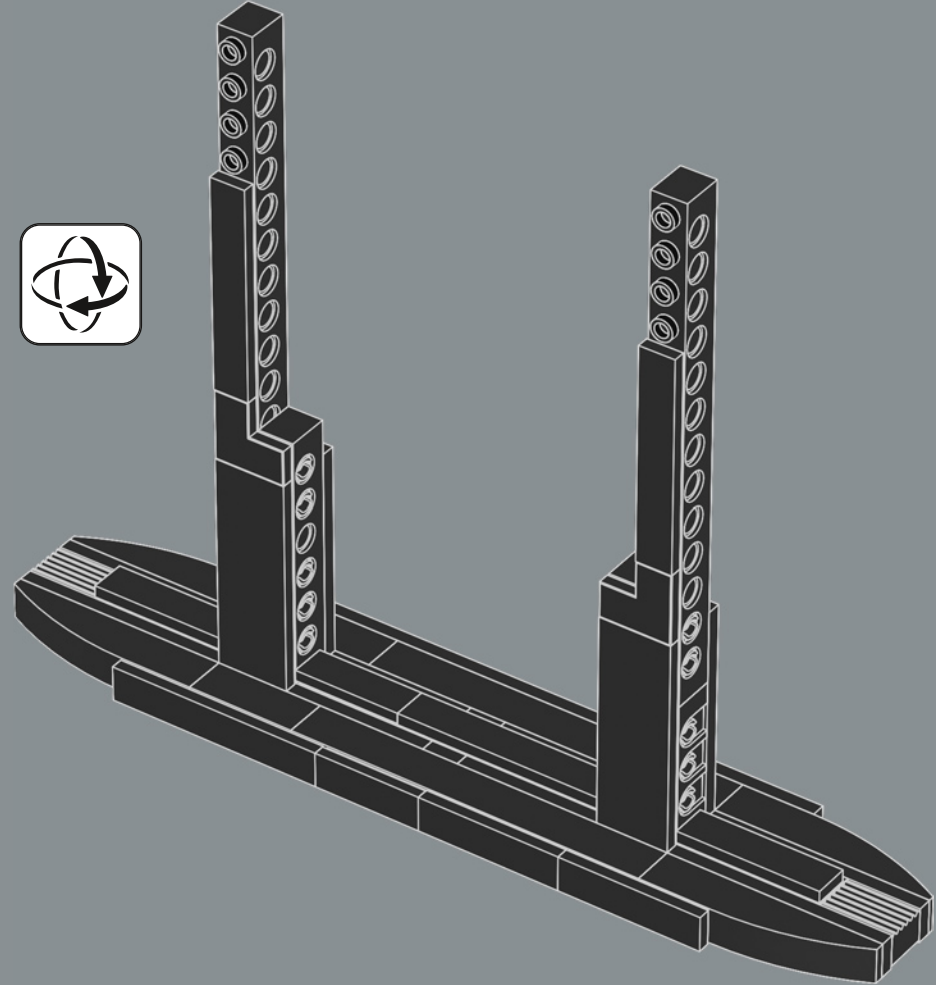



255

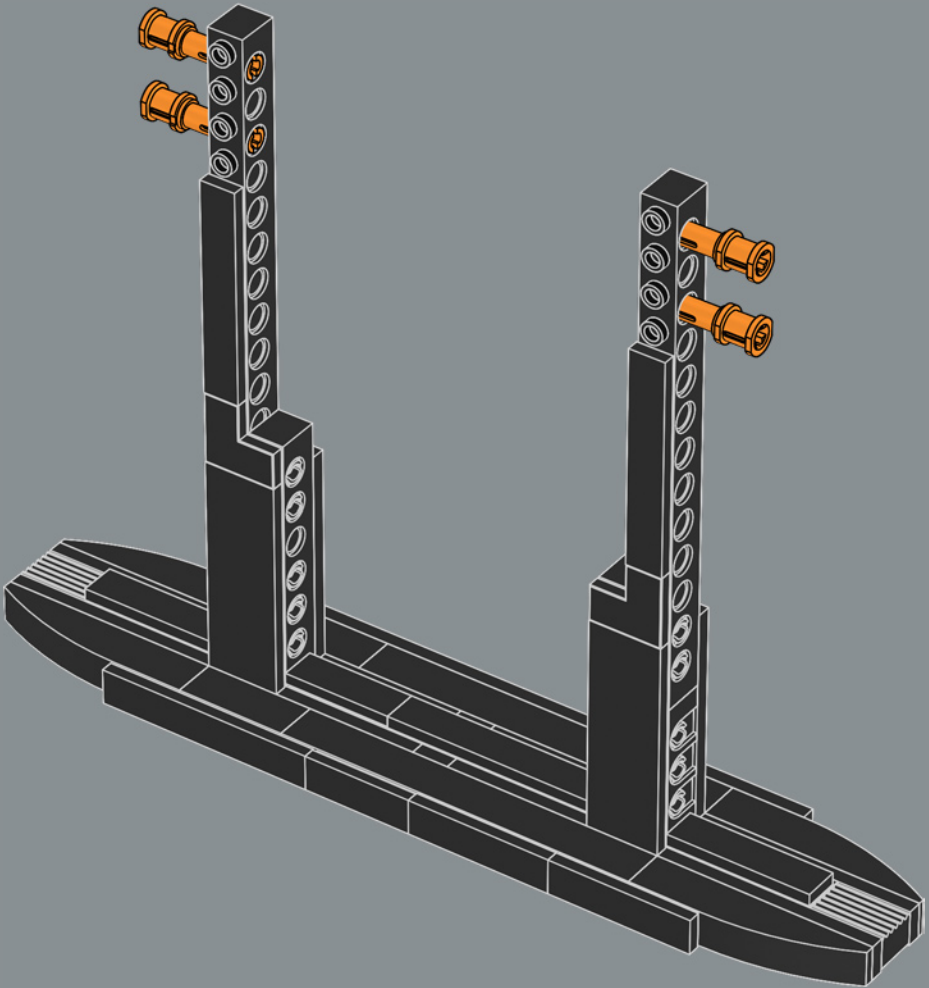

256

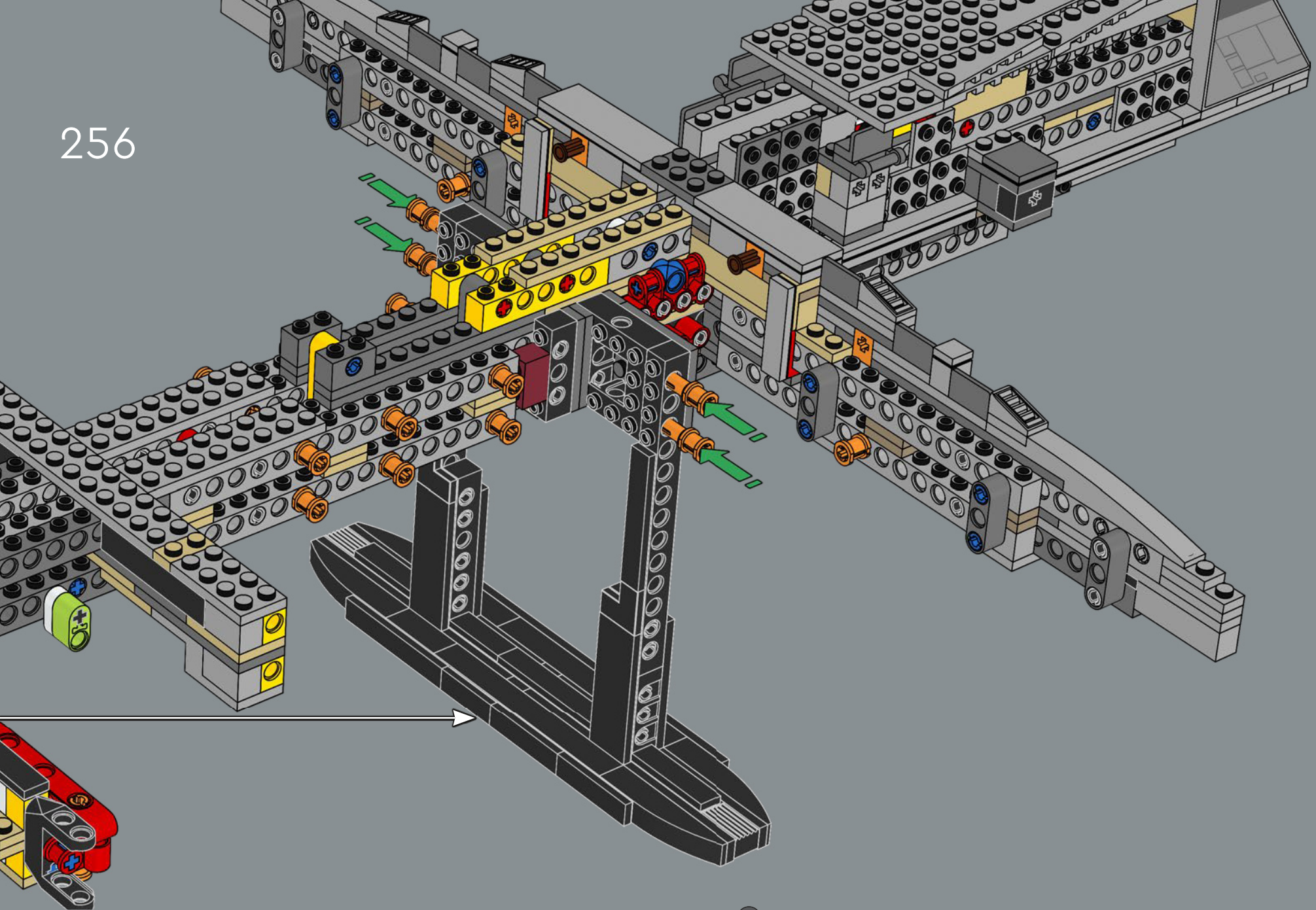

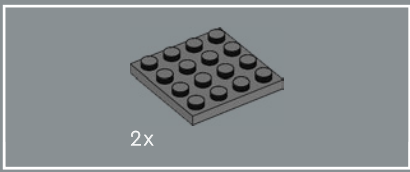

257

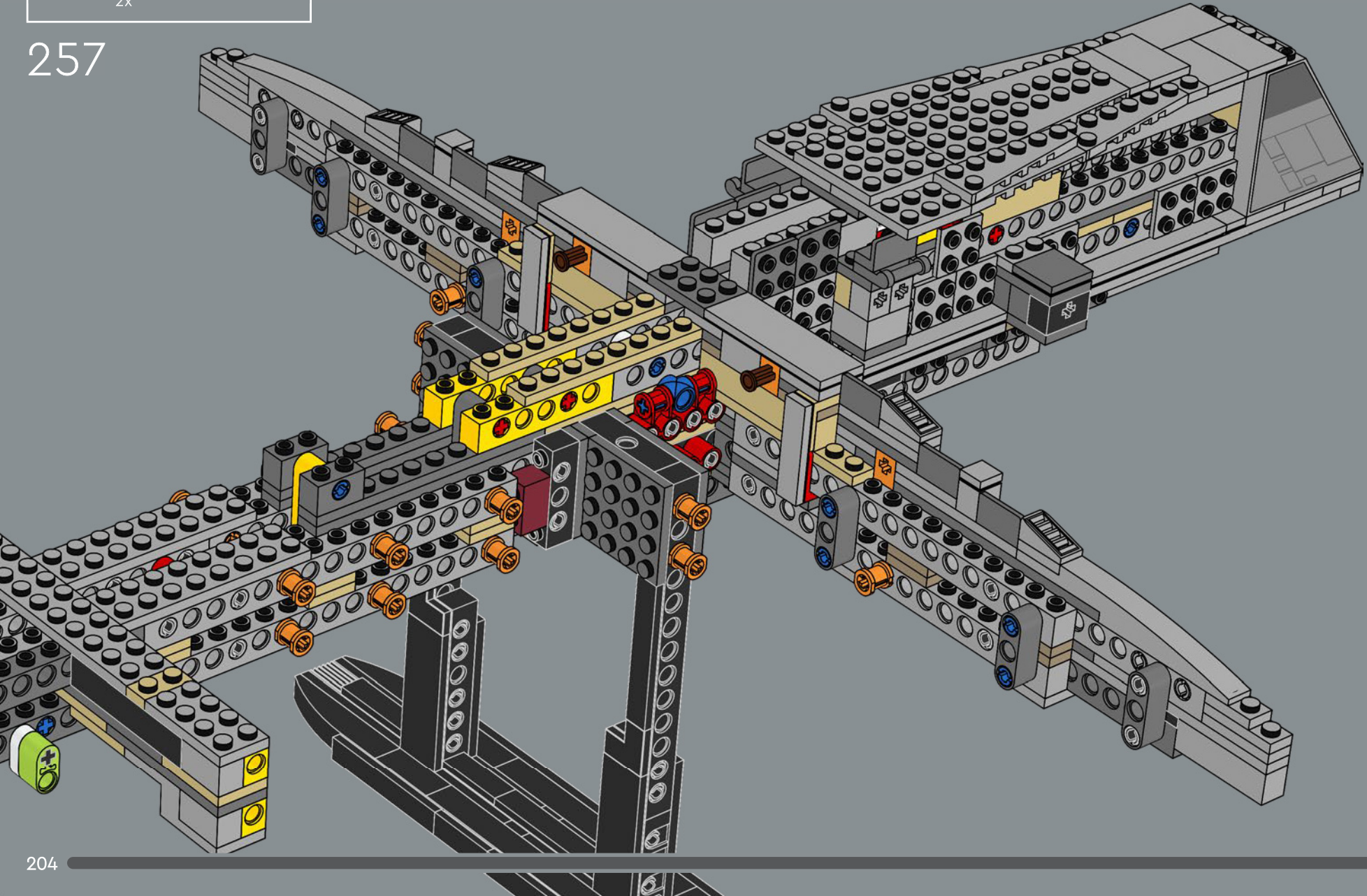

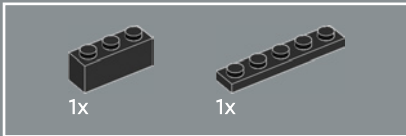
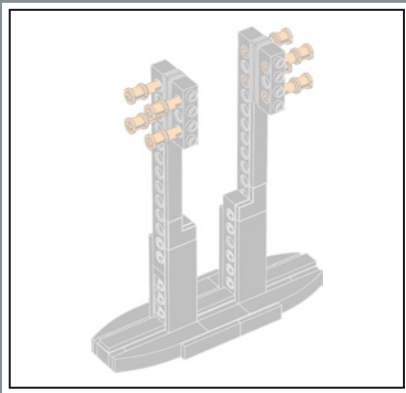

258

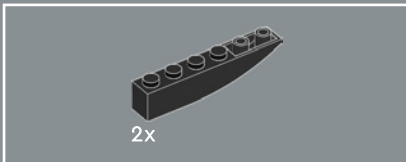
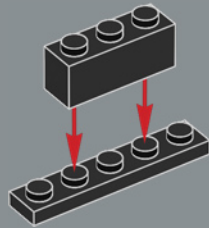

259

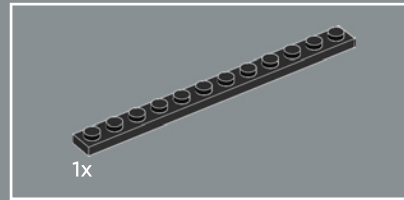
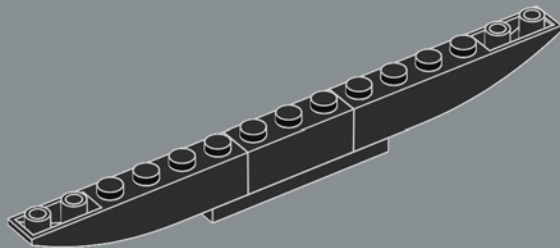

260

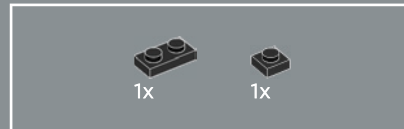
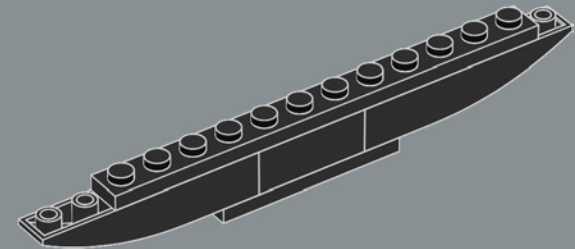

261

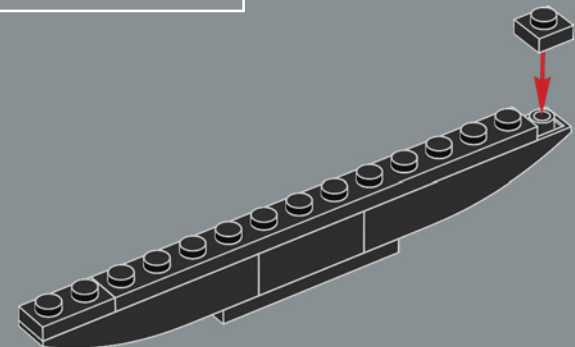

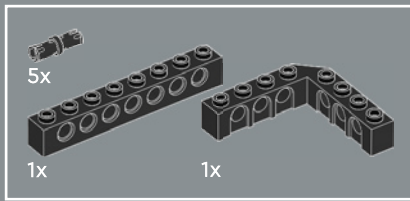

262

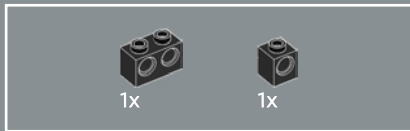
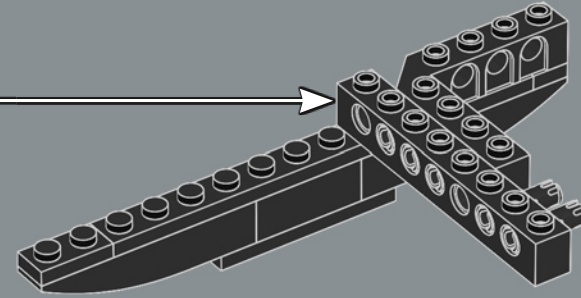
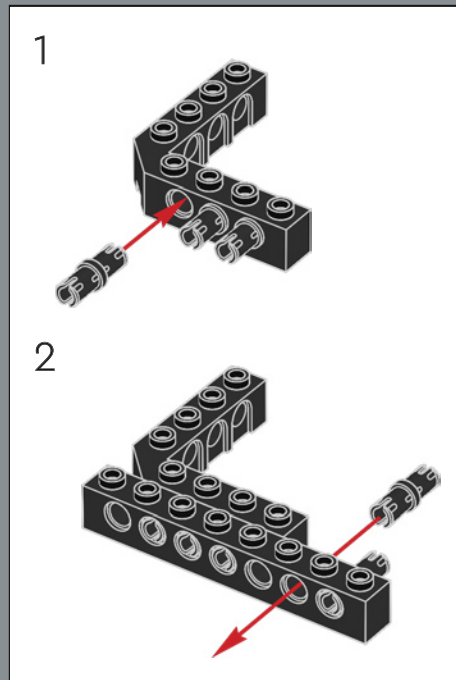

263

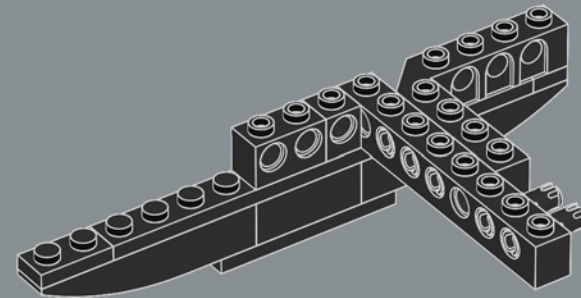

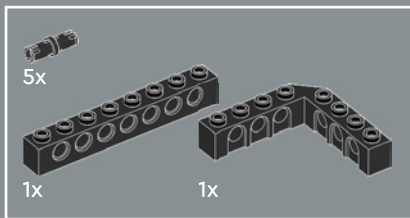

264

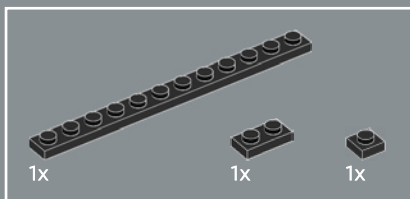
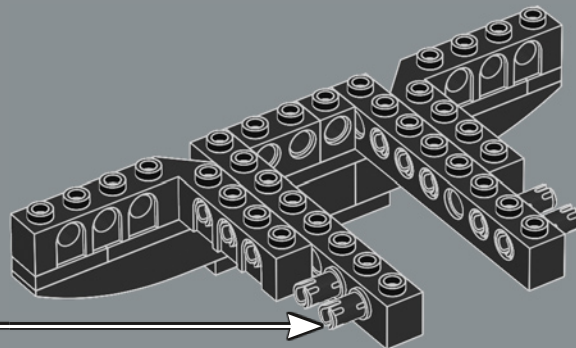
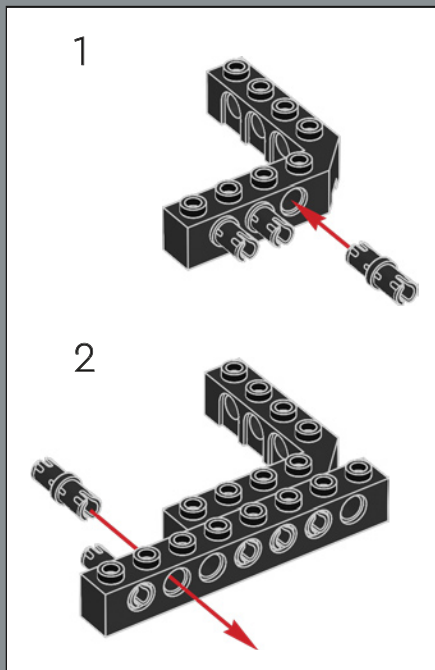

265

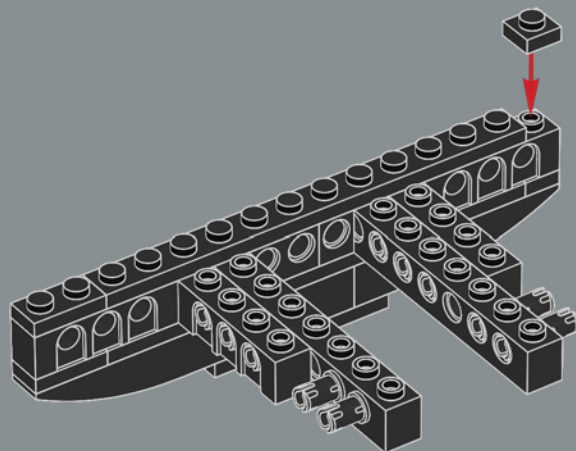

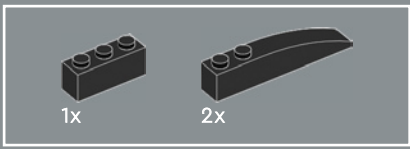

266

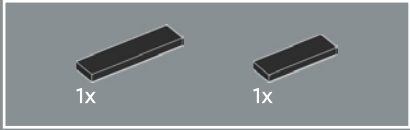
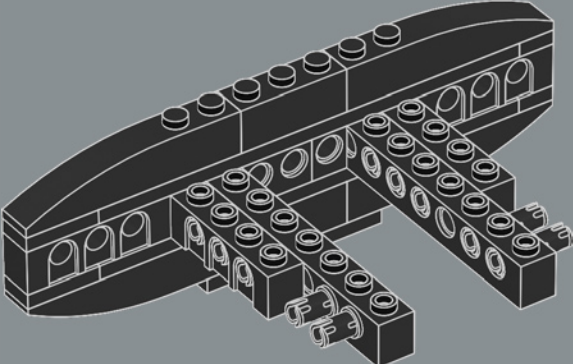

267

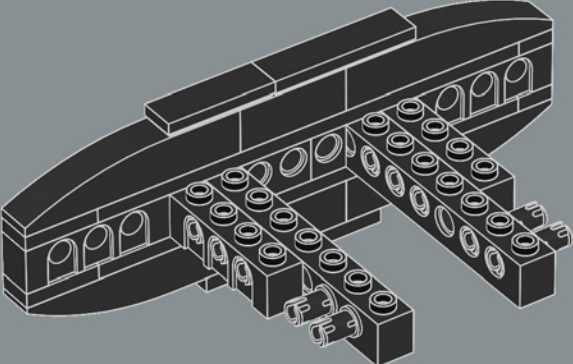





268

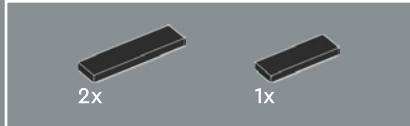
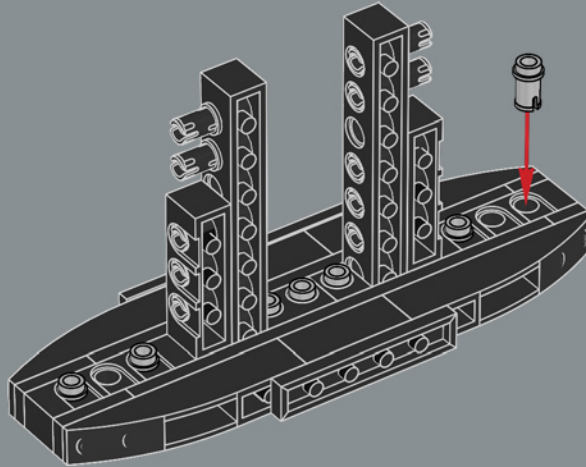

269

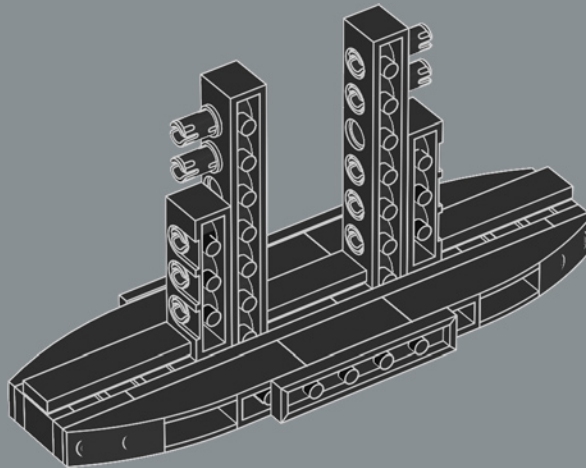

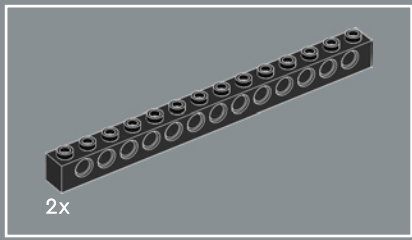

270

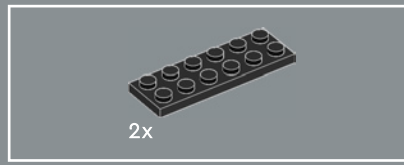
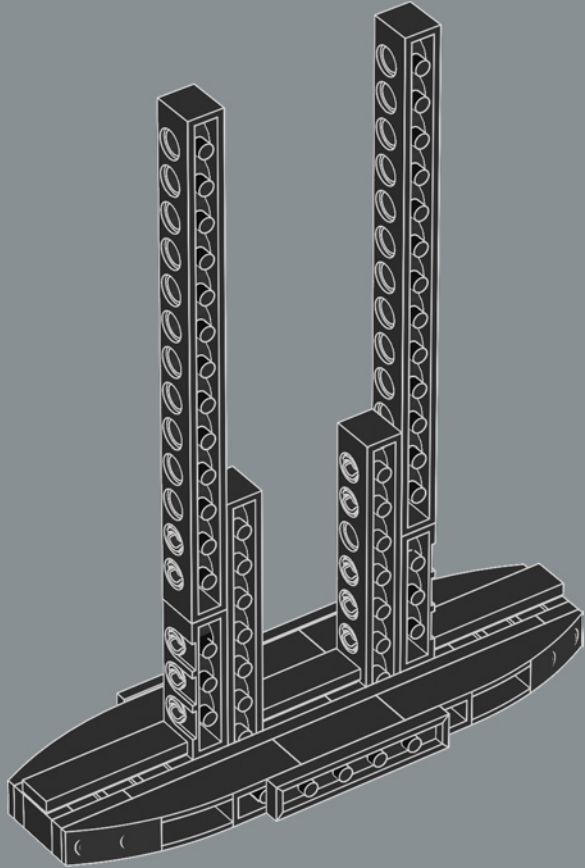

271

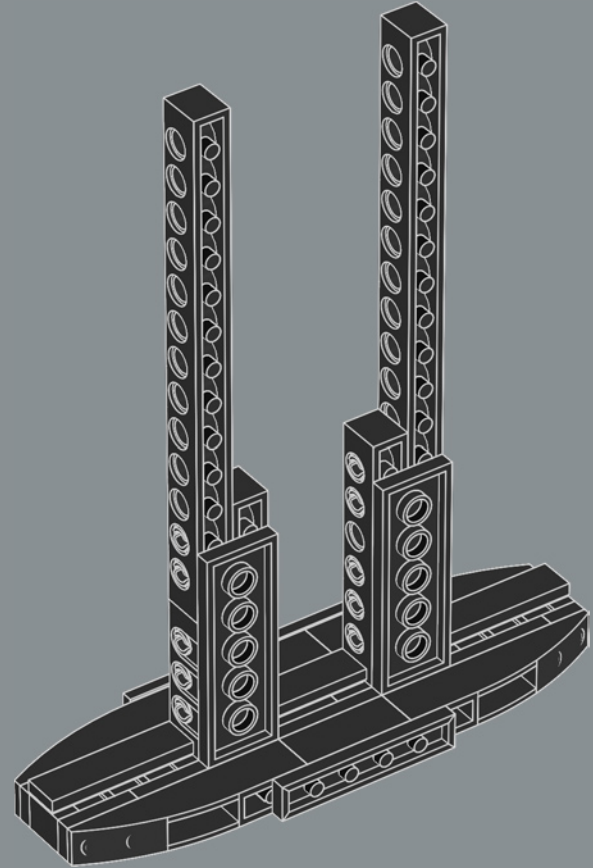

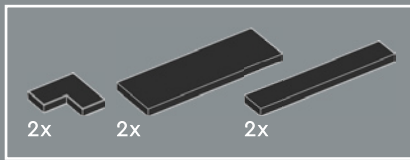

272

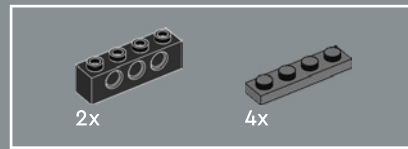
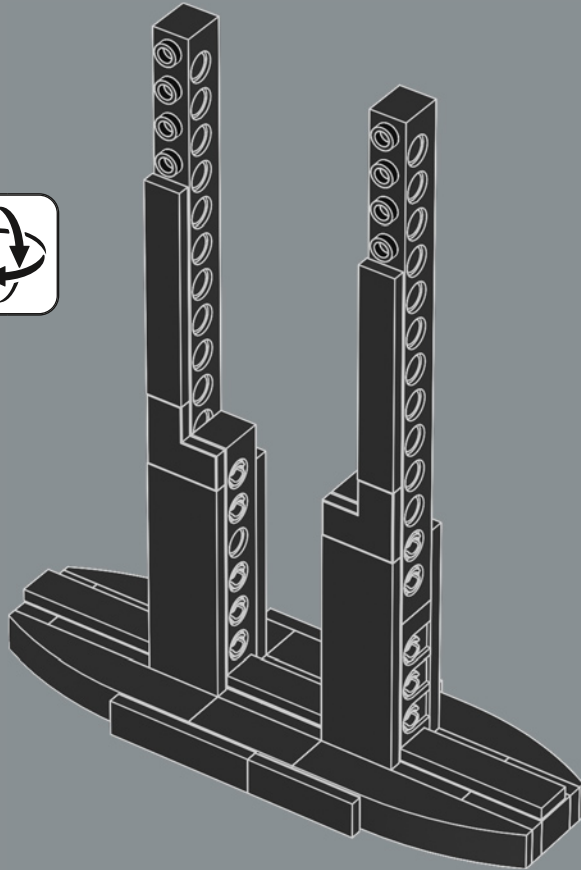

273

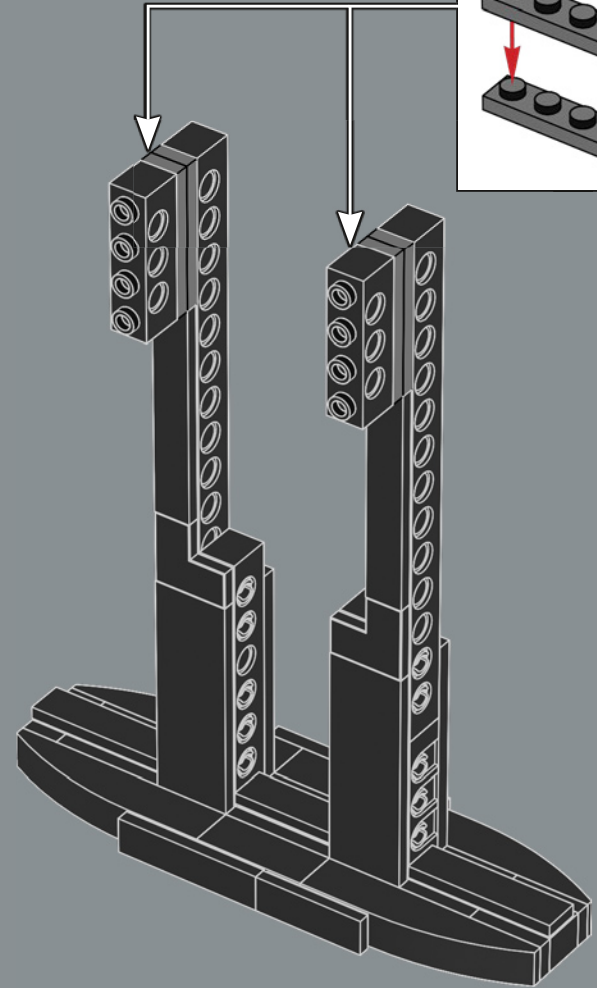
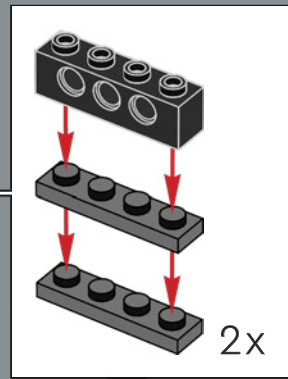



274

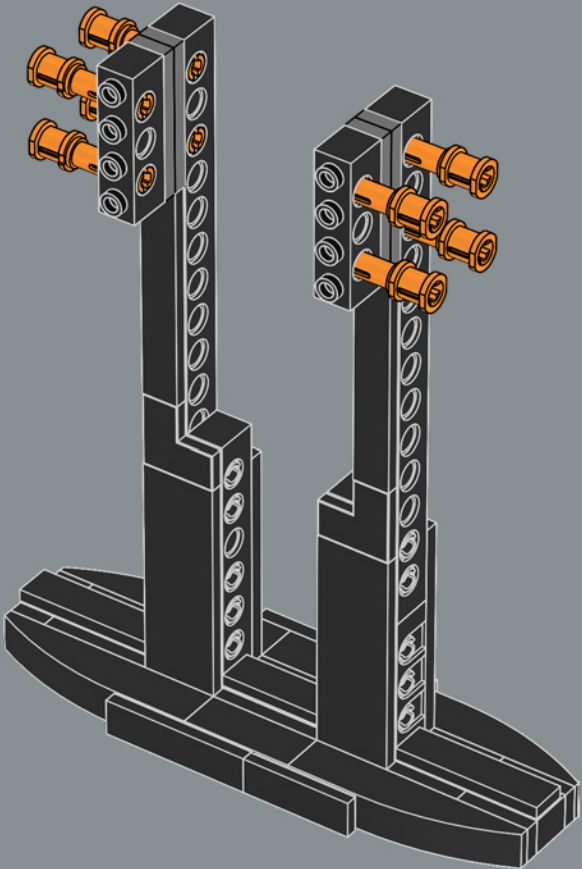

275

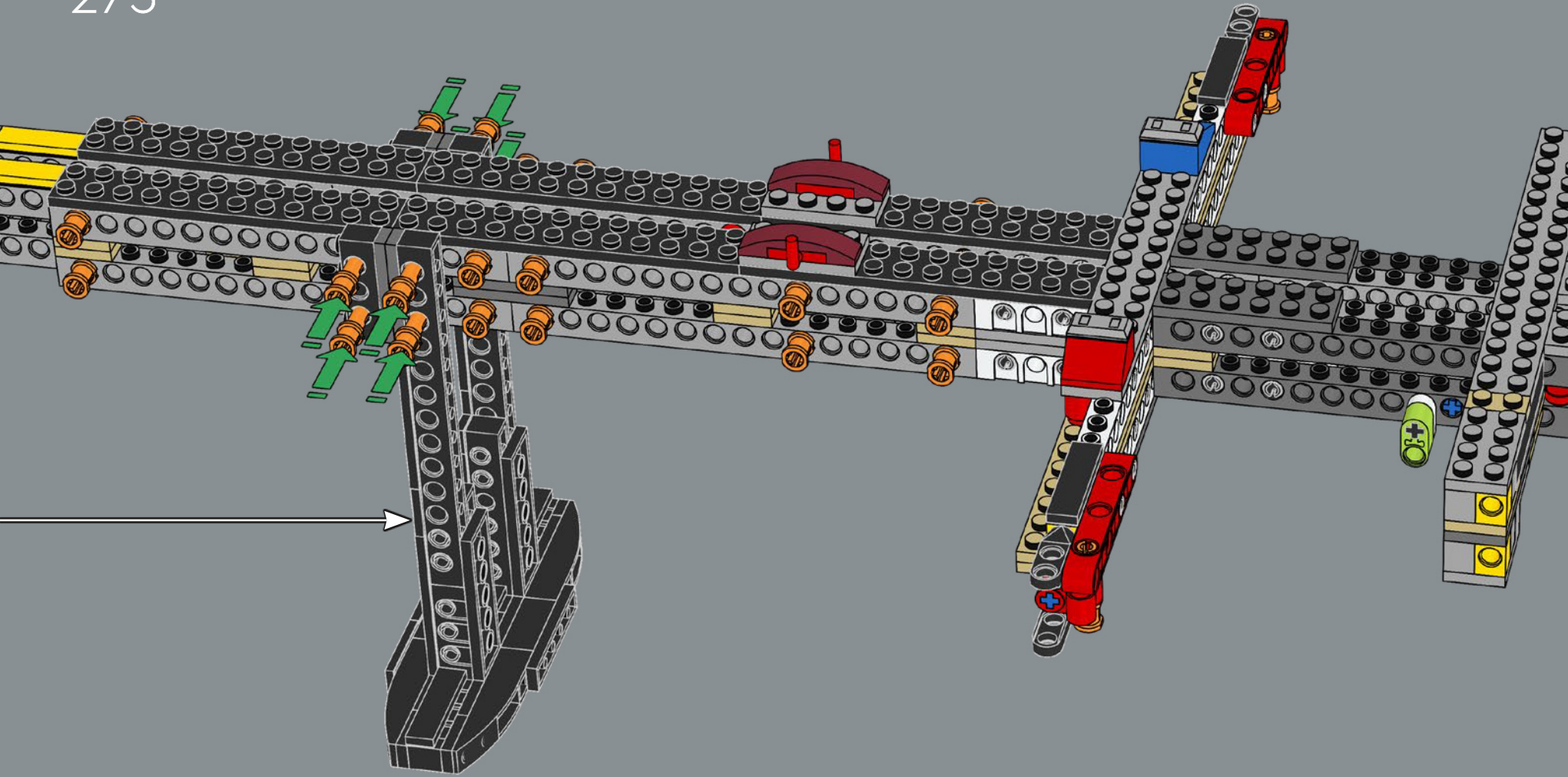

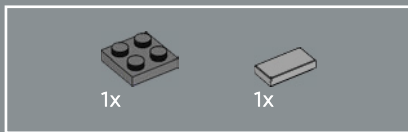

276

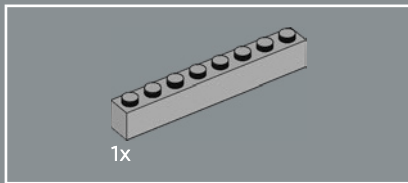
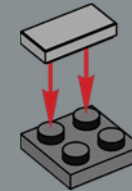

277

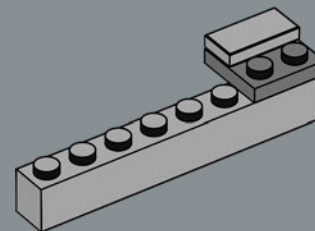

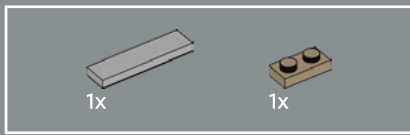

278

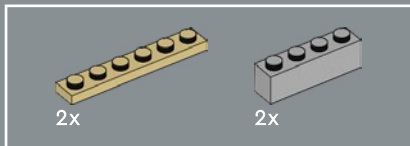
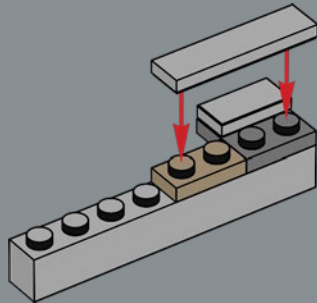

279

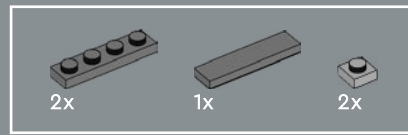
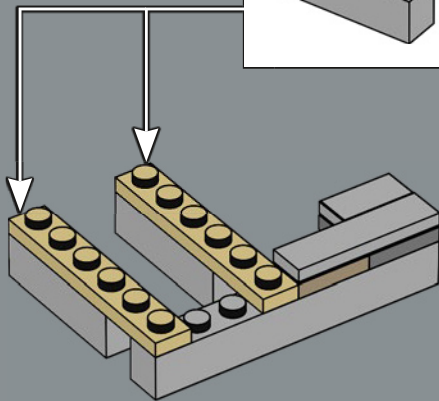
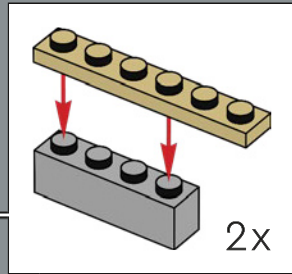

280

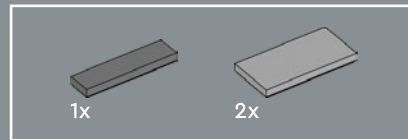
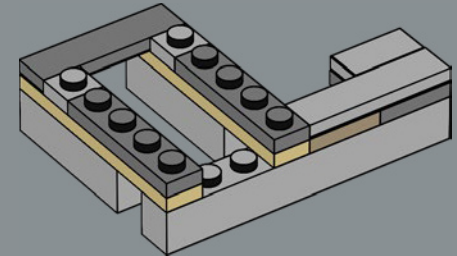

281

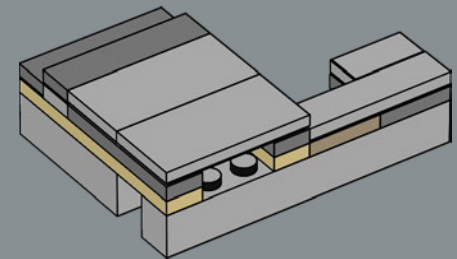

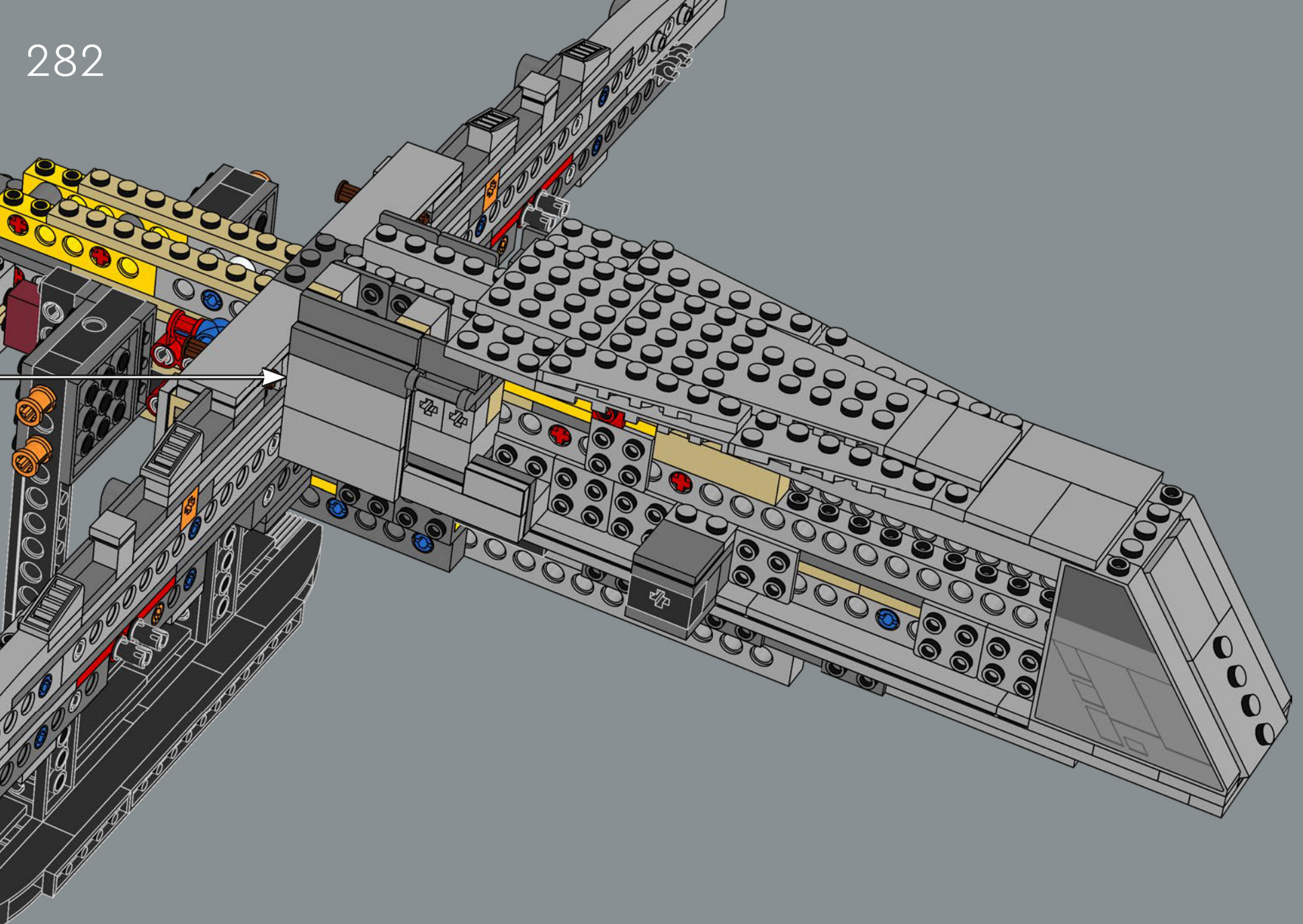



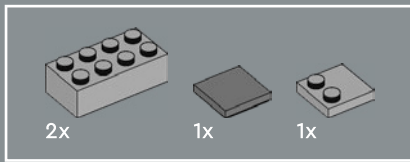

283

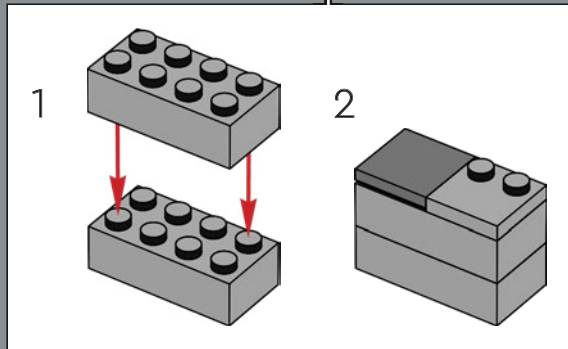
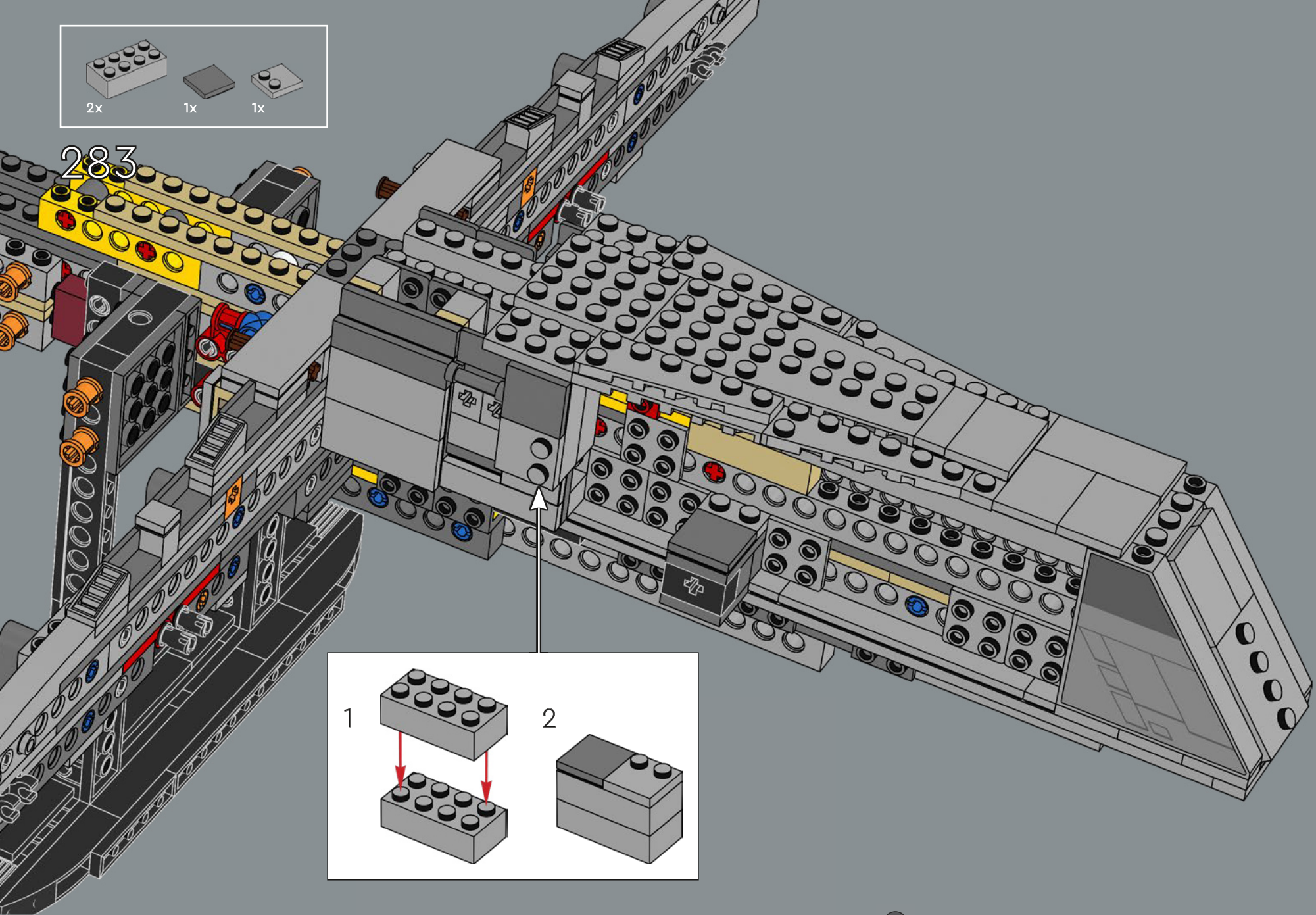

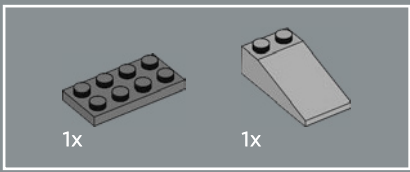

284

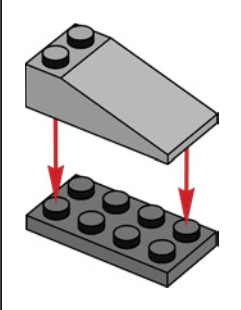
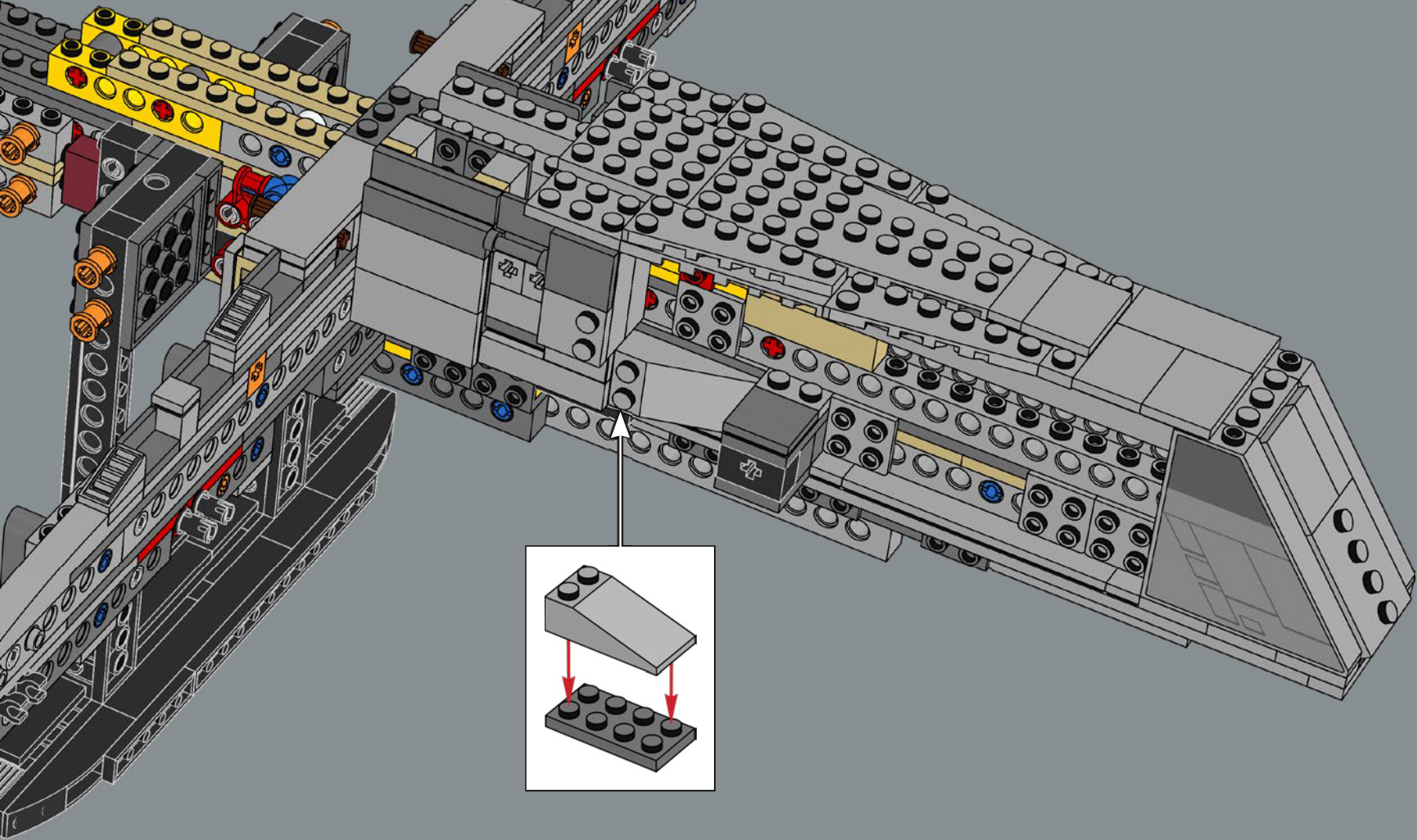

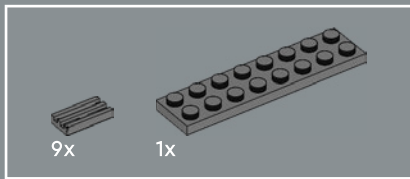

285

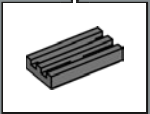
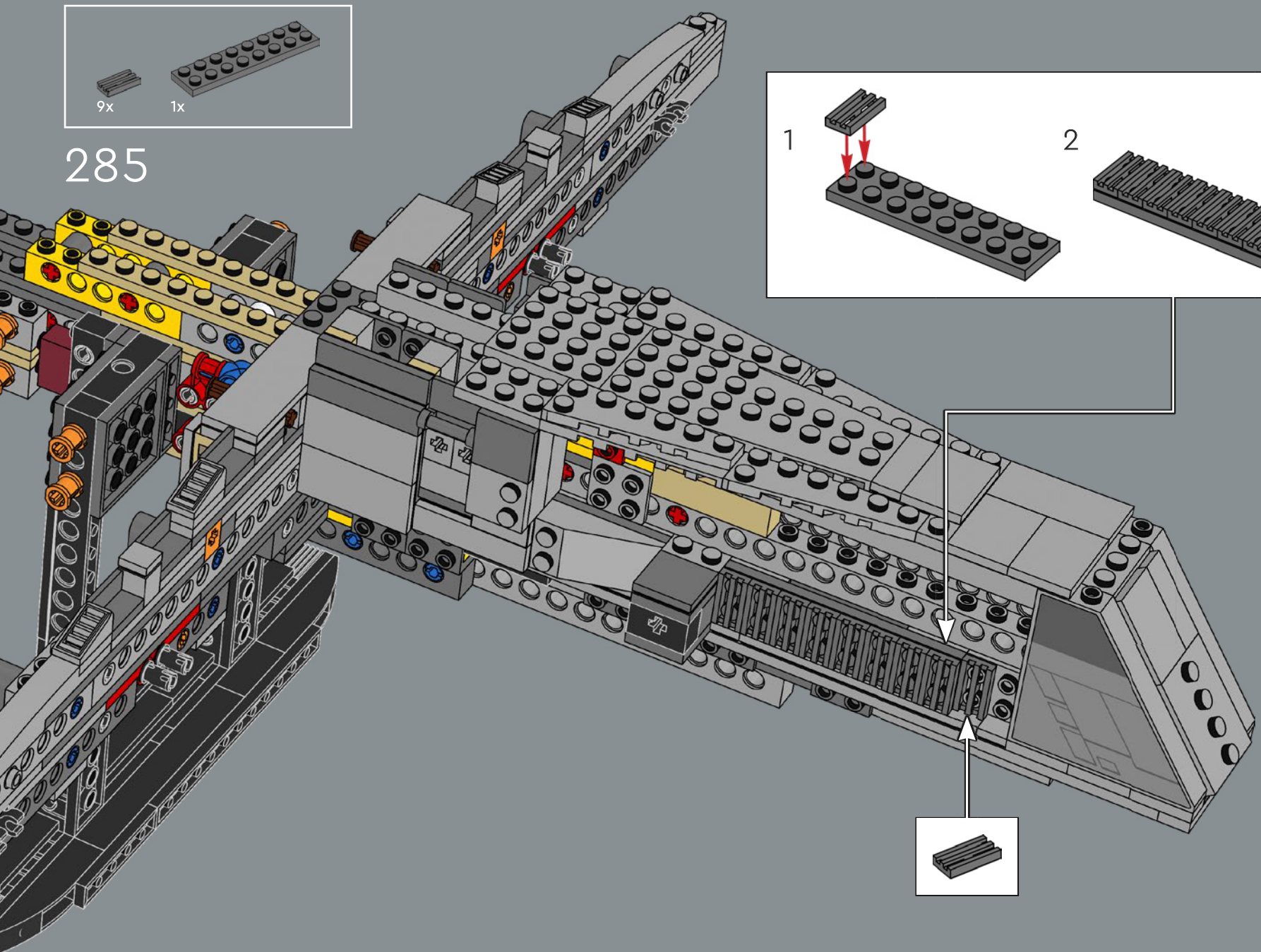
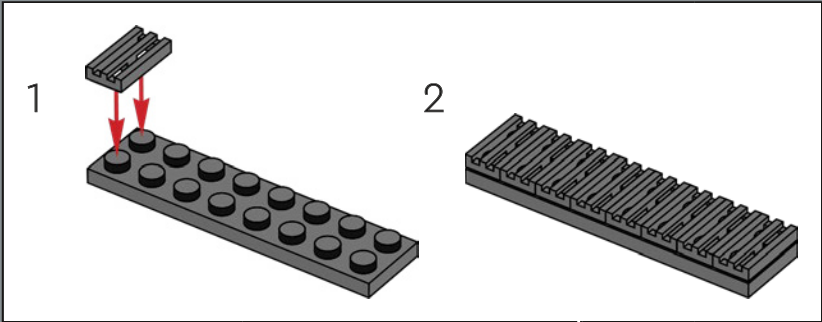

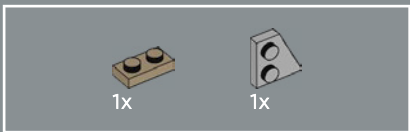

286

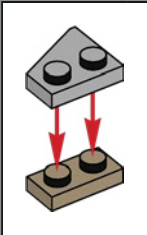
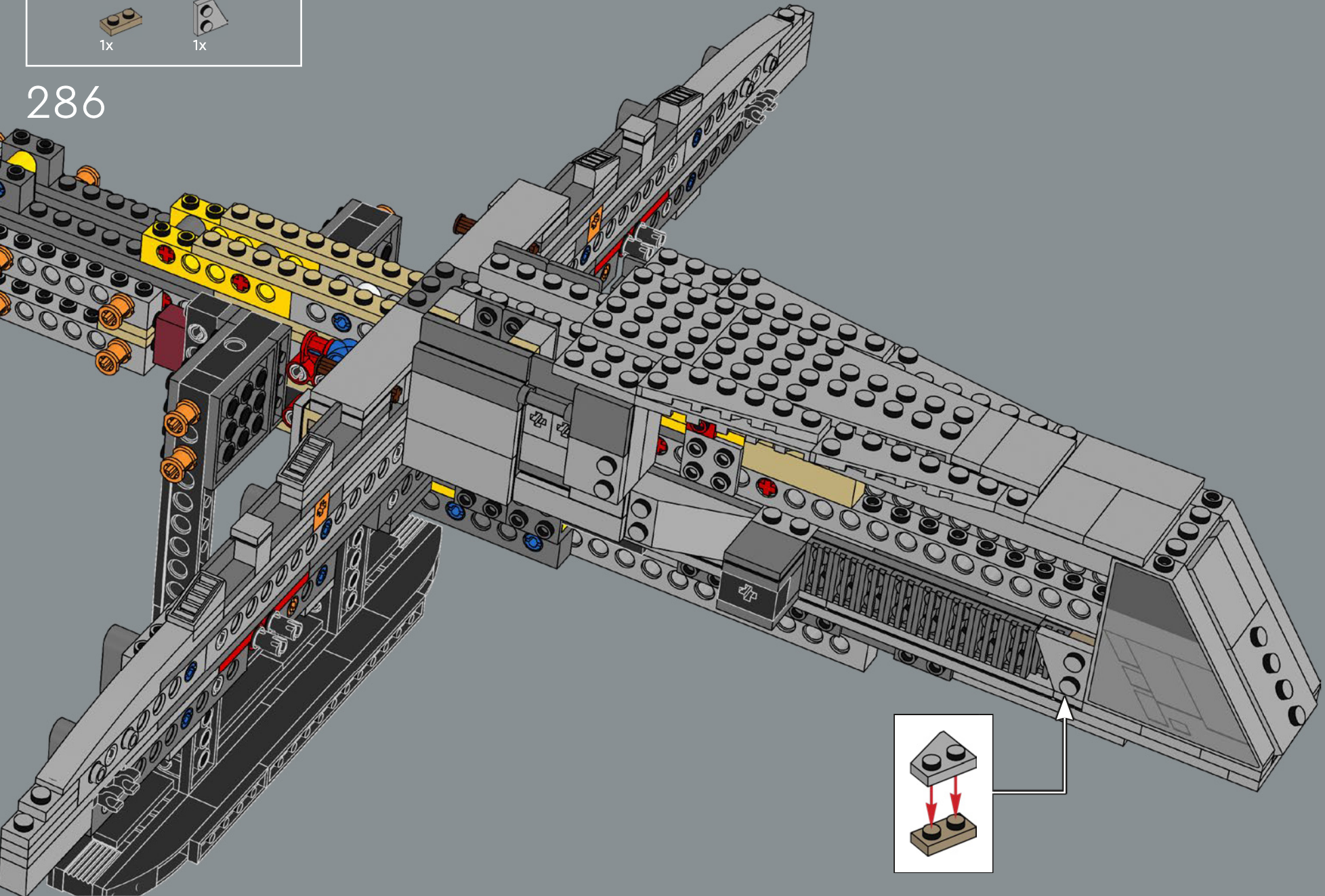

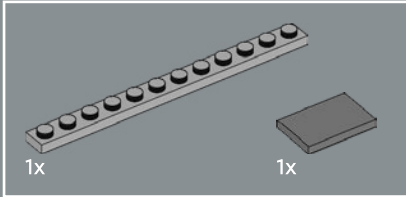
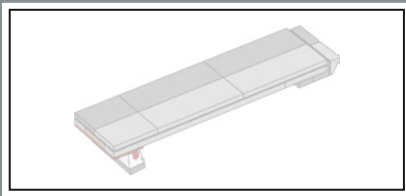

287

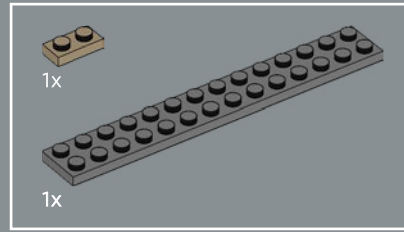
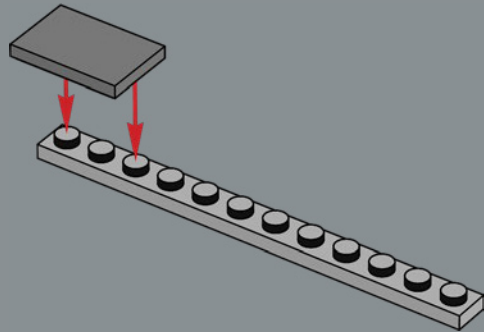

288

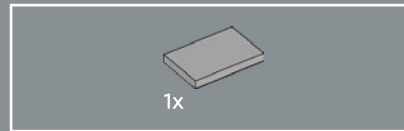
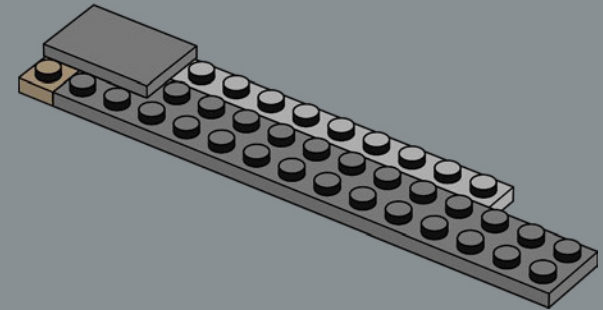

289

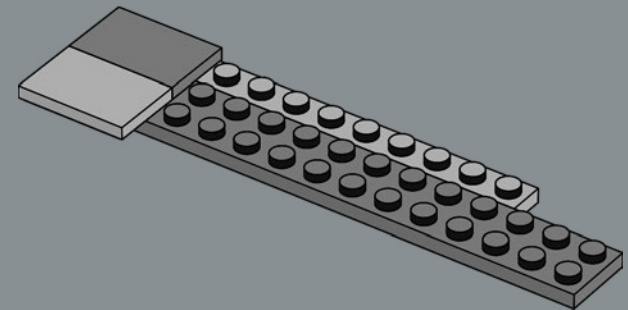

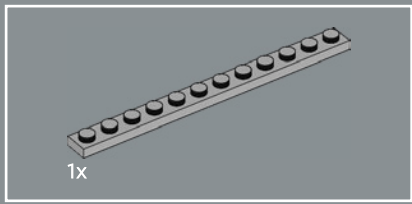

290

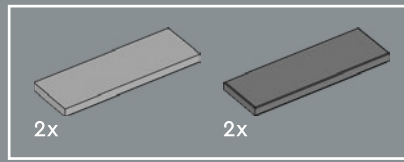
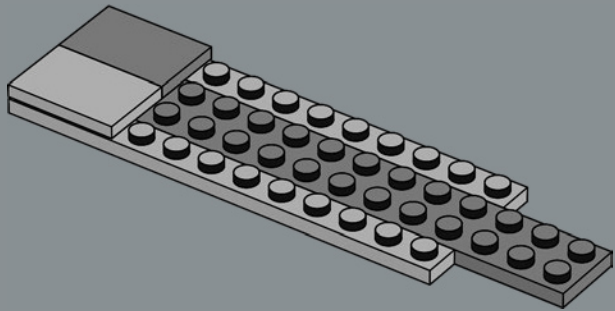

291

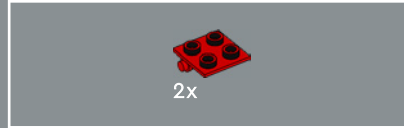
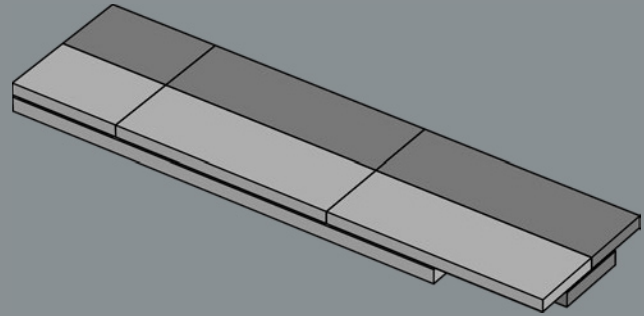

292

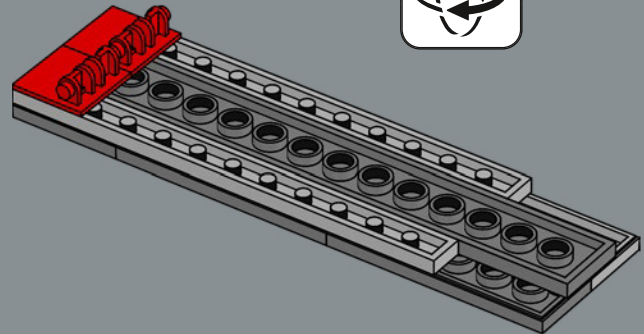

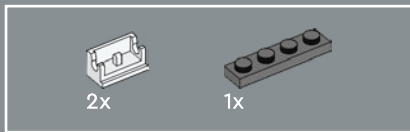

293

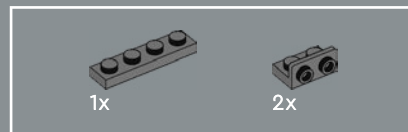
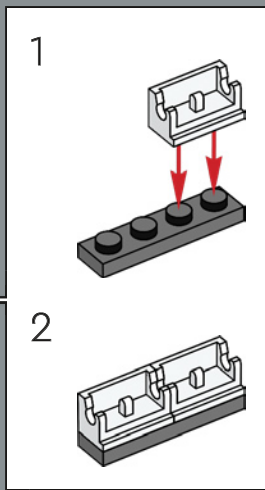
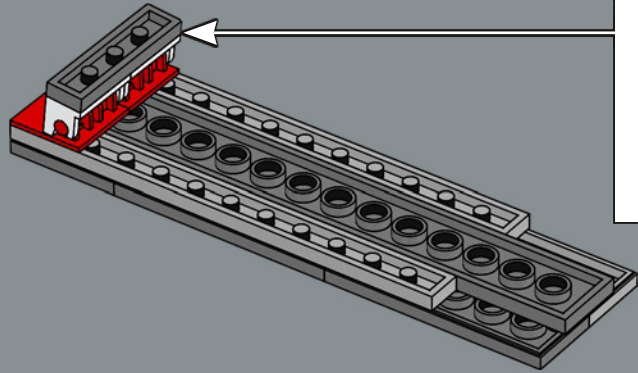

295

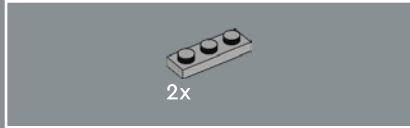
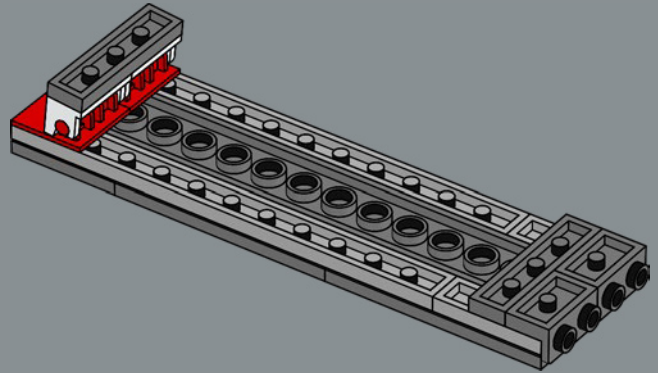

294

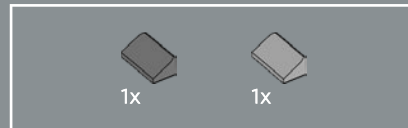
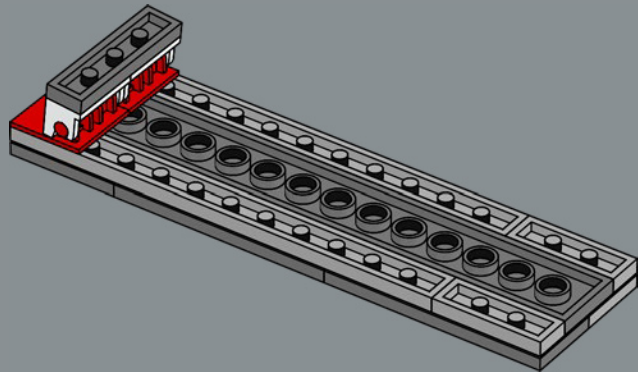

296

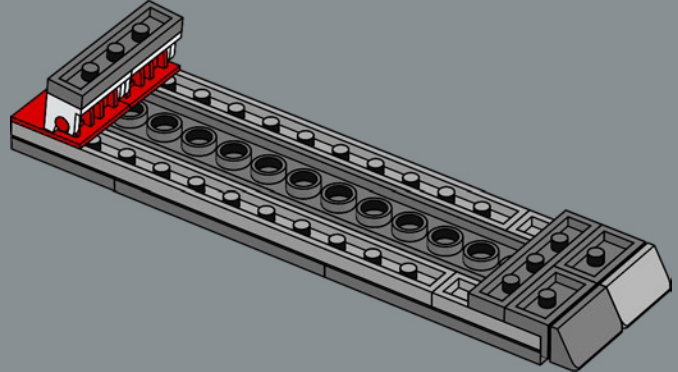

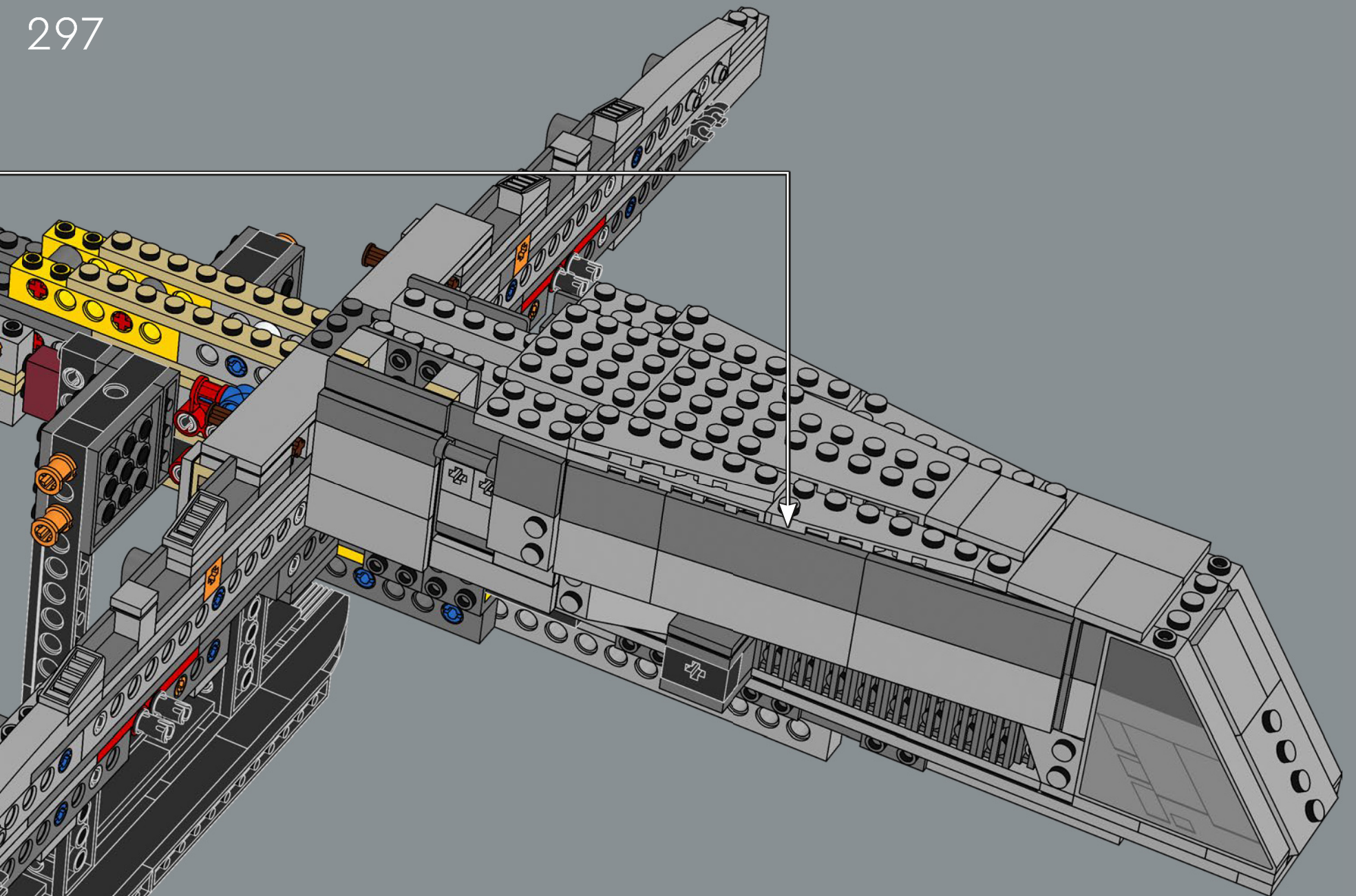



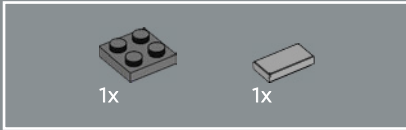
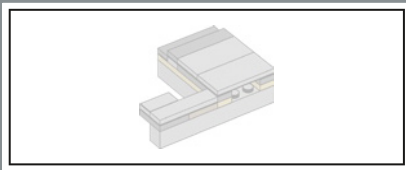

298

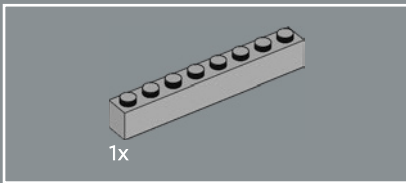
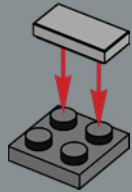

299

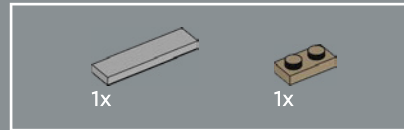
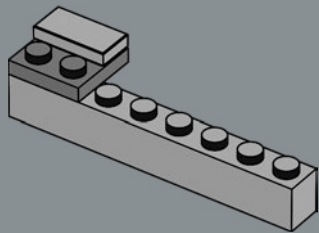

300

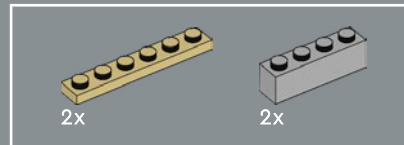
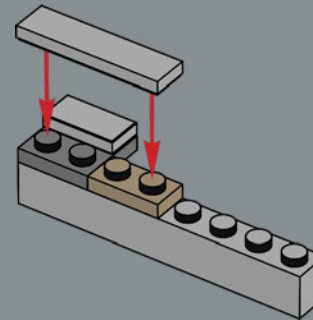

301

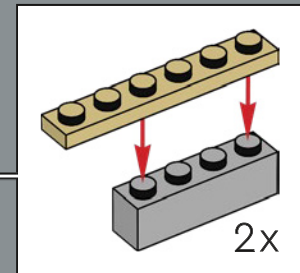
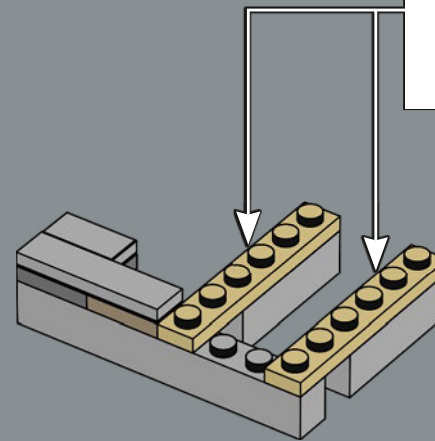

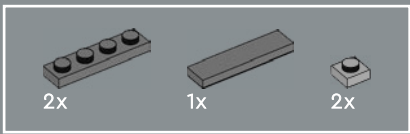

302

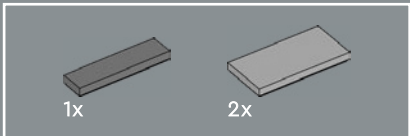
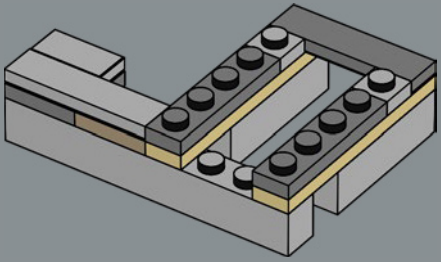

303

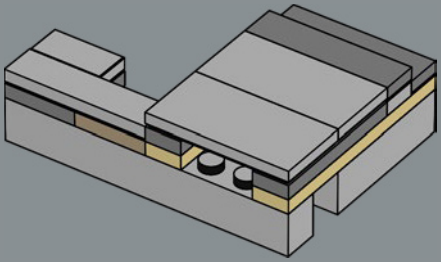

304

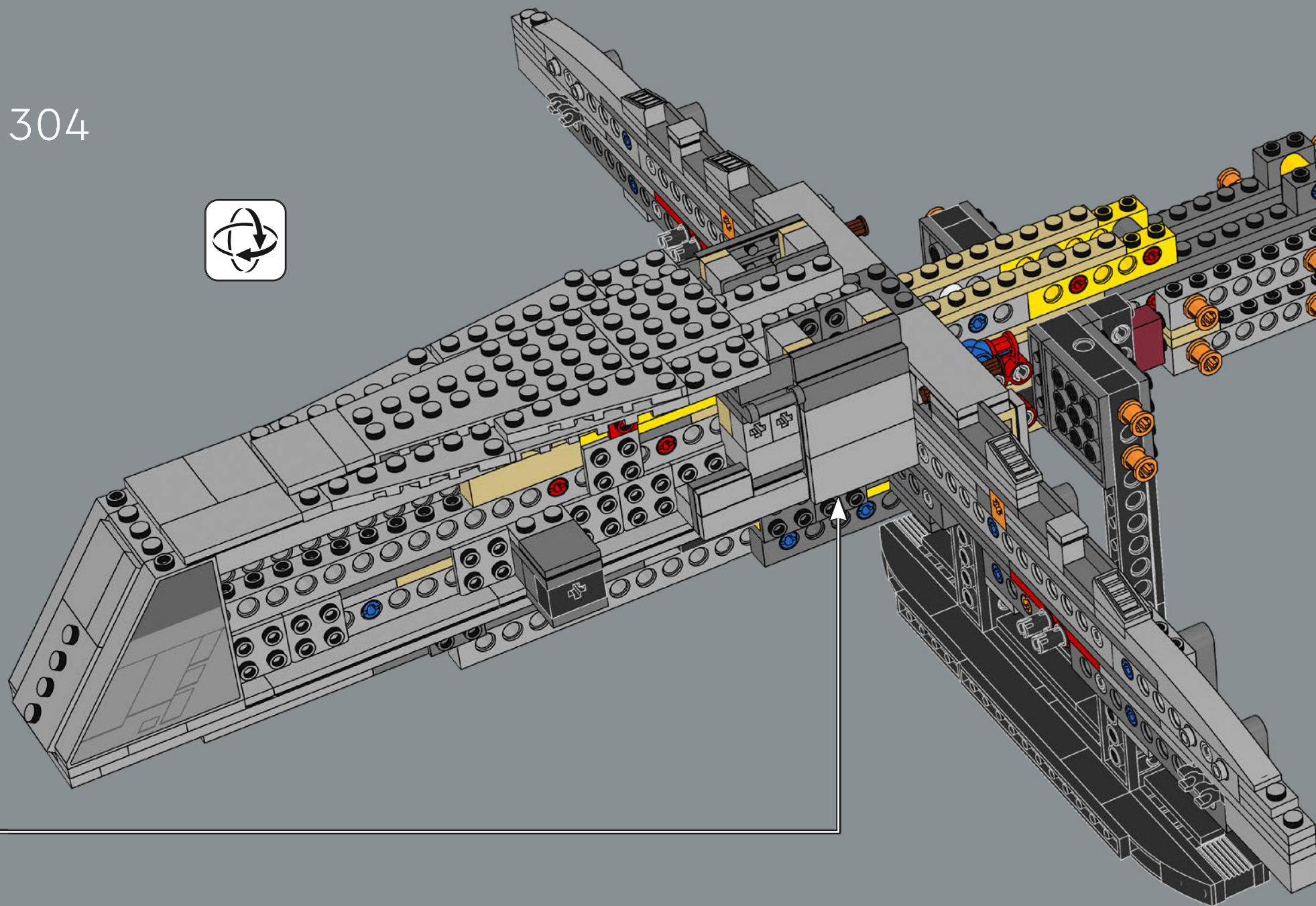

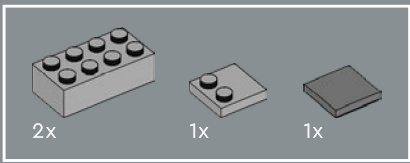

305

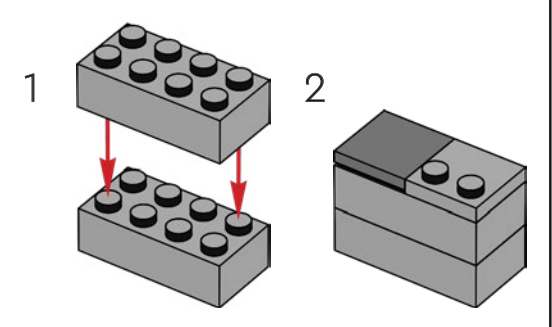
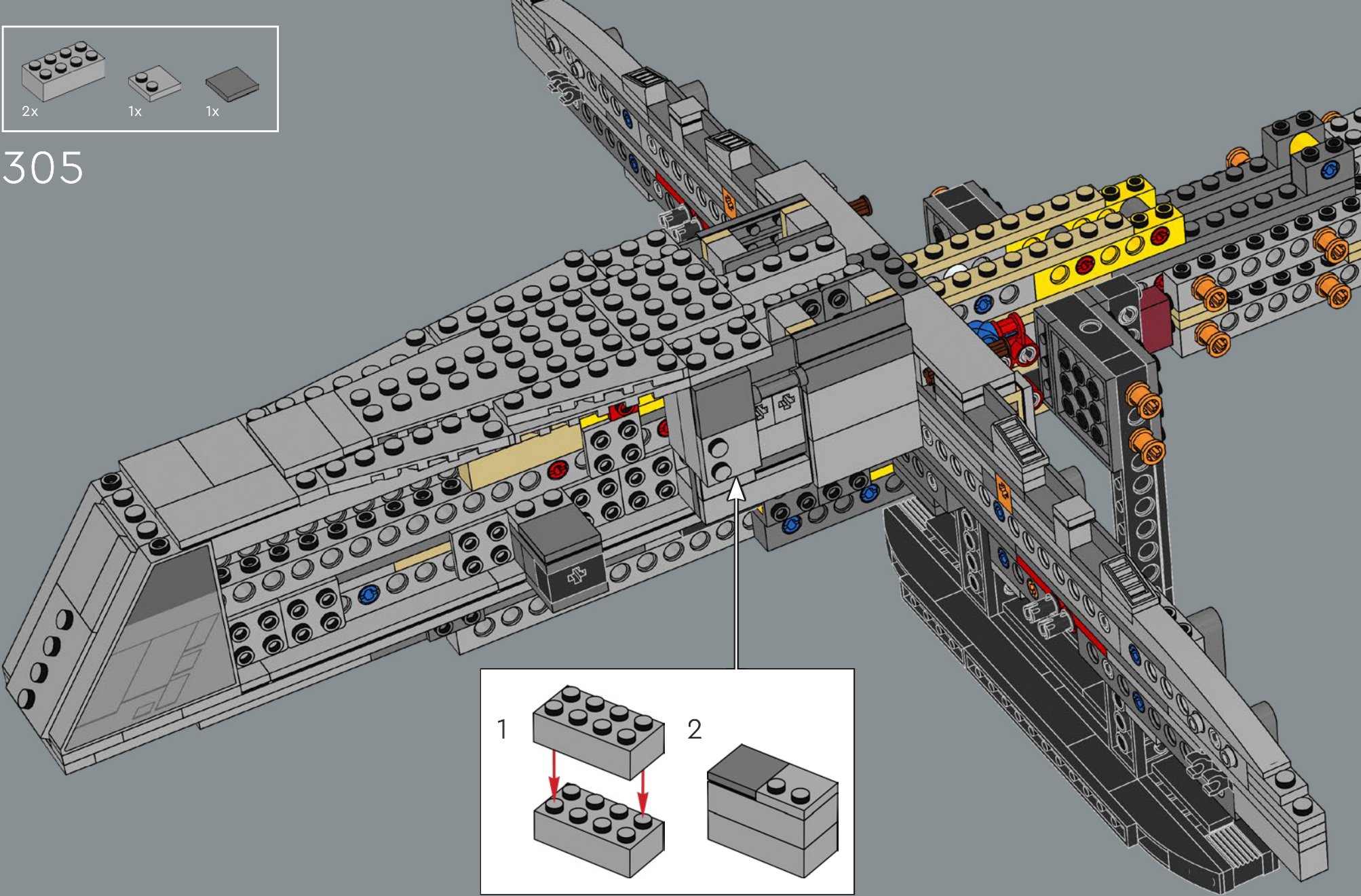

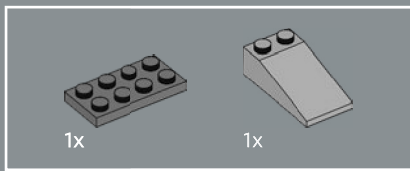

306

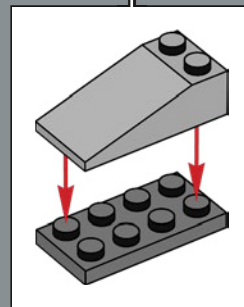
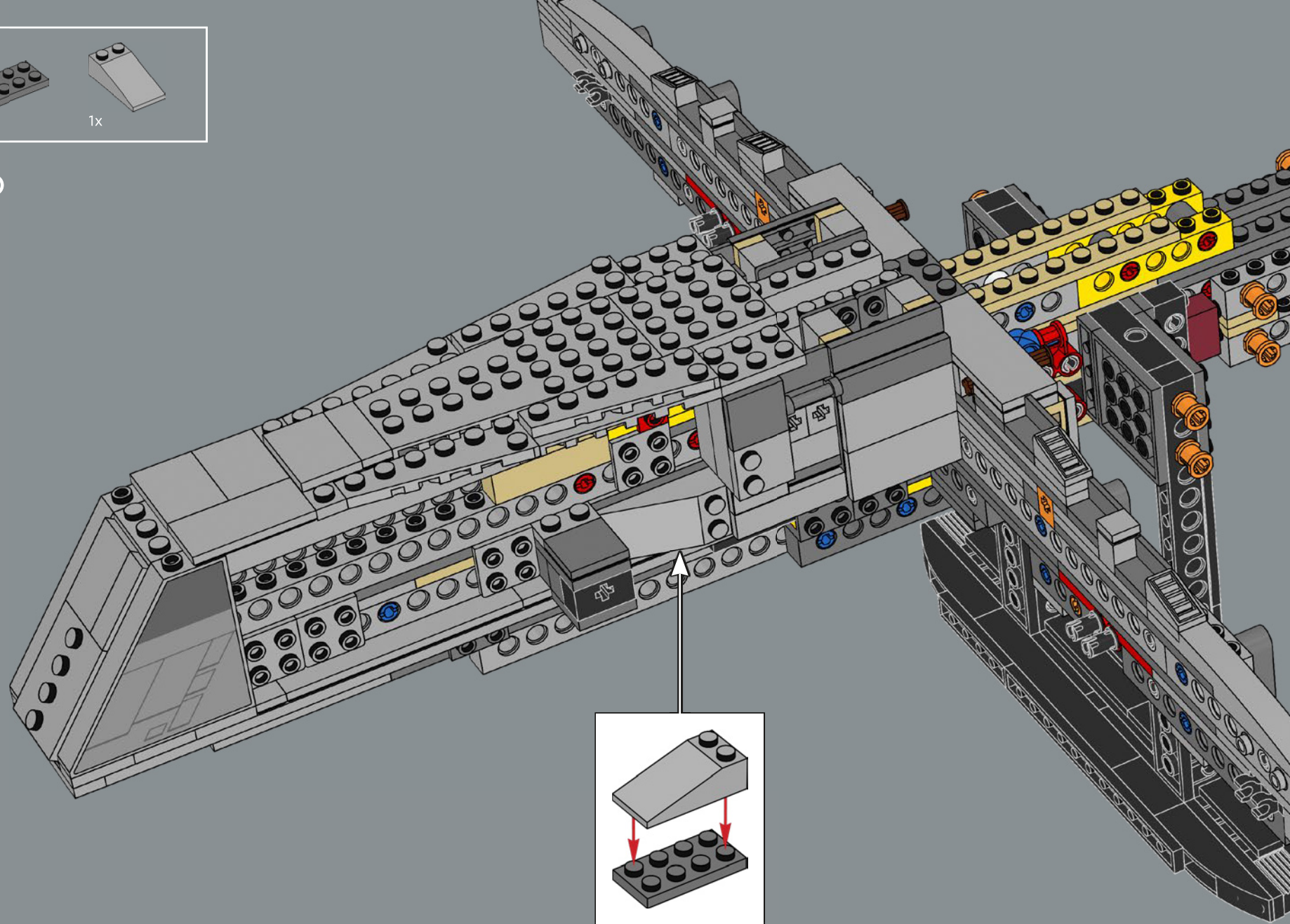

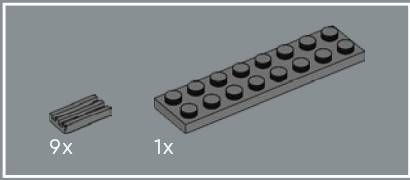

307

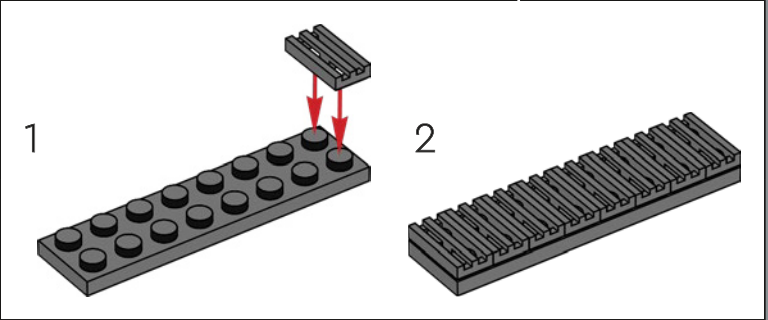
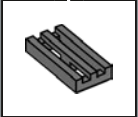
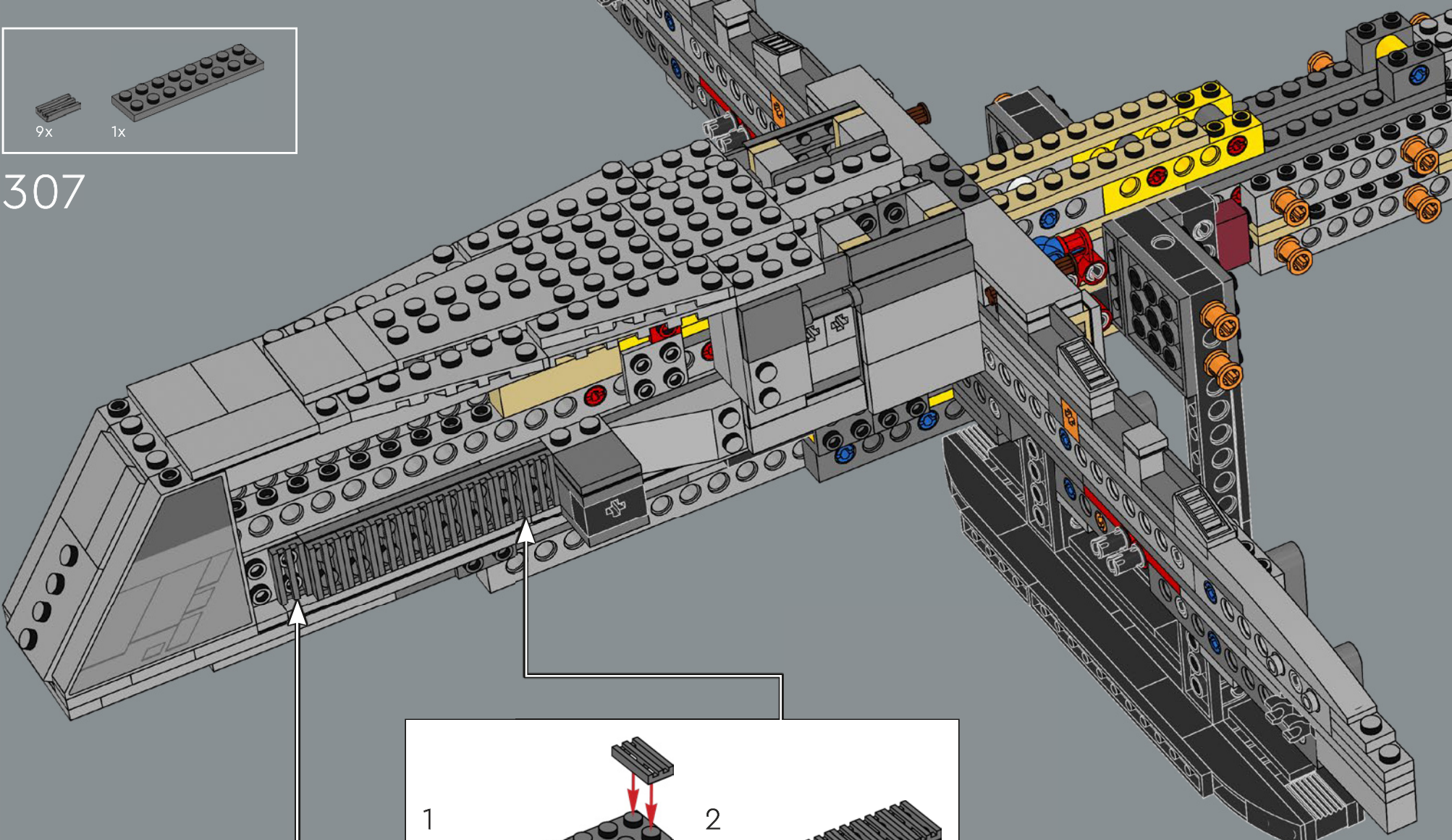

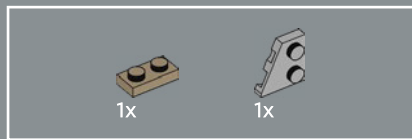

308

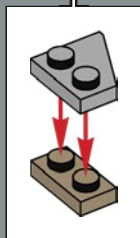
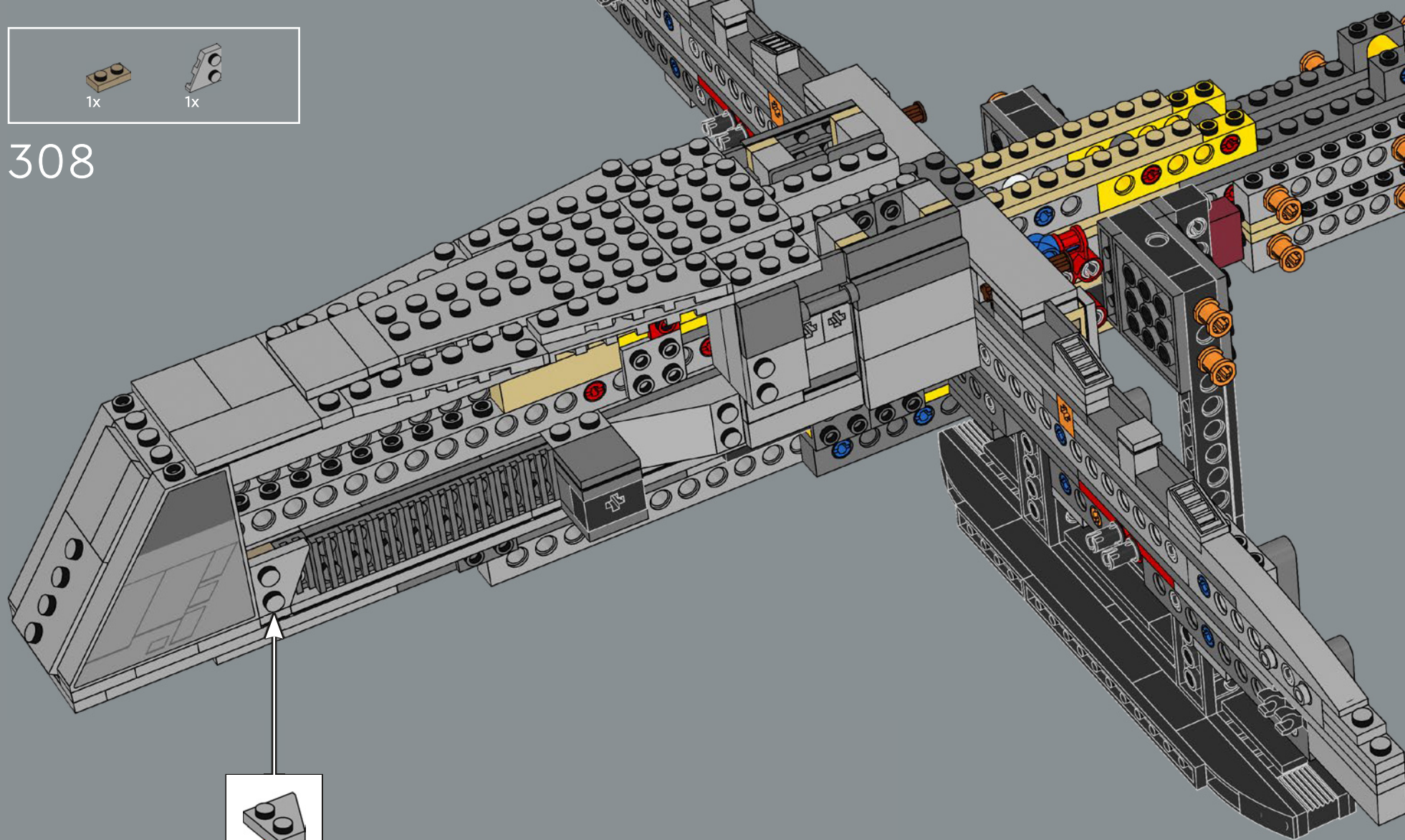

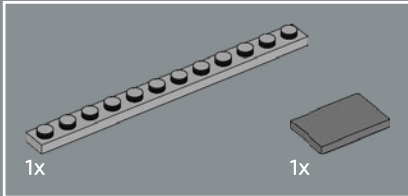
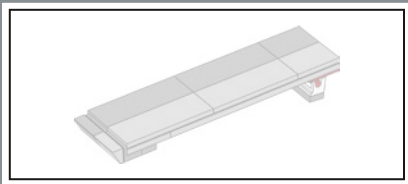

309

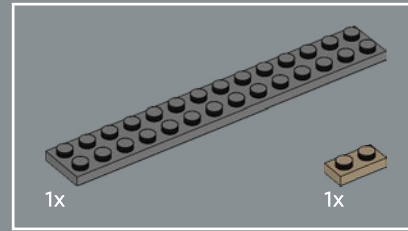
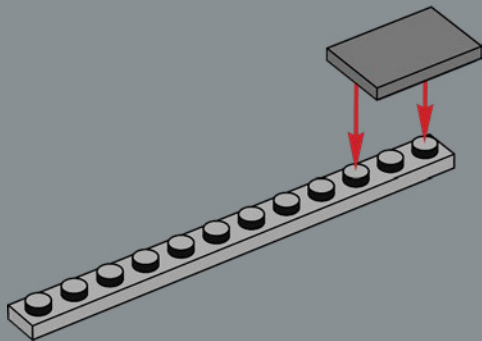

310

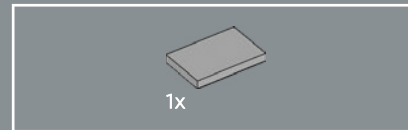
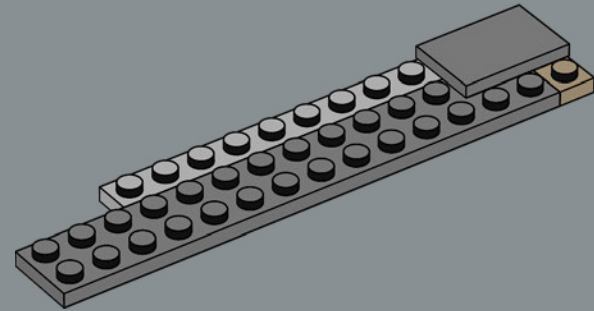

311

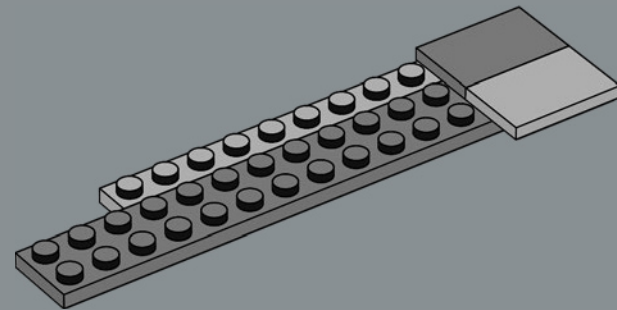



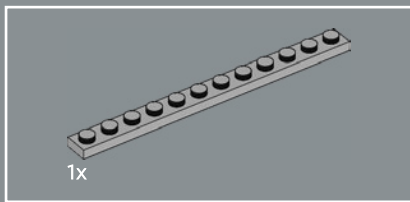

312

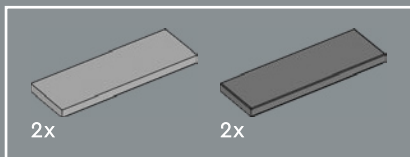
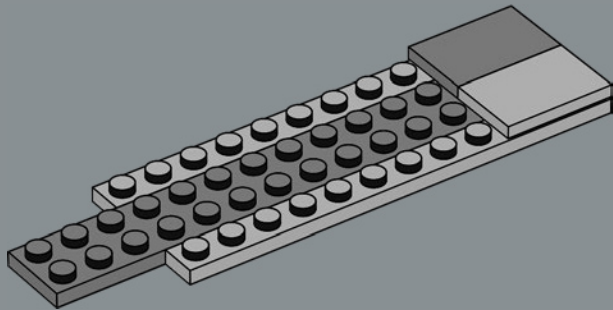

313

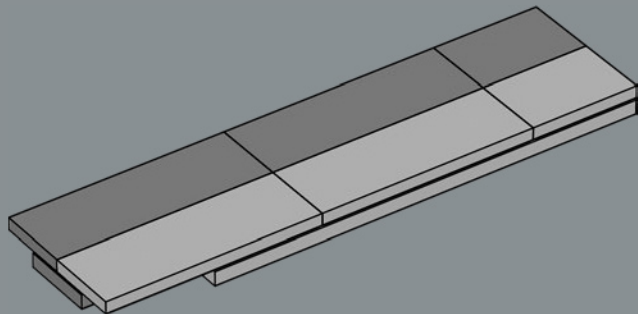

314

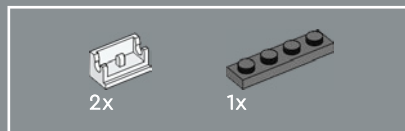
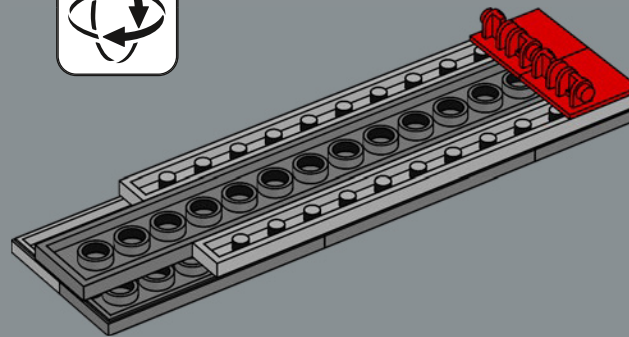

315

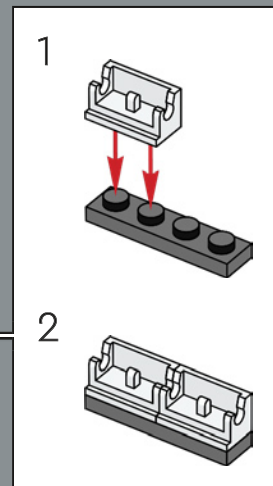
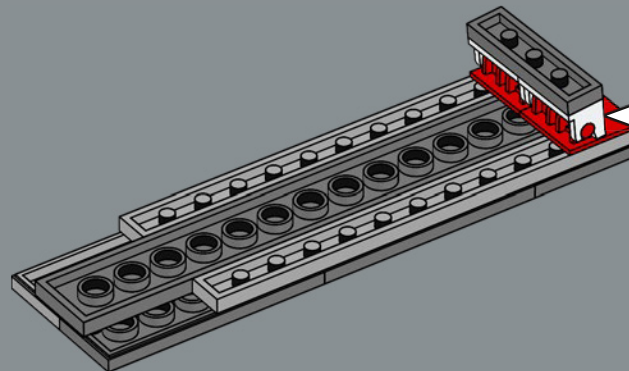

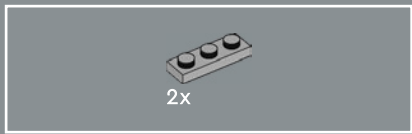

316

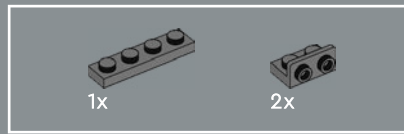
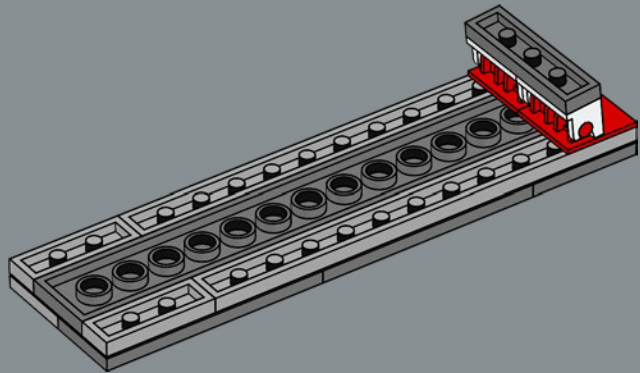

317

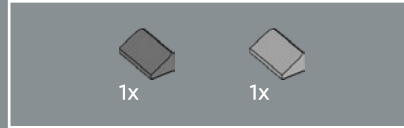
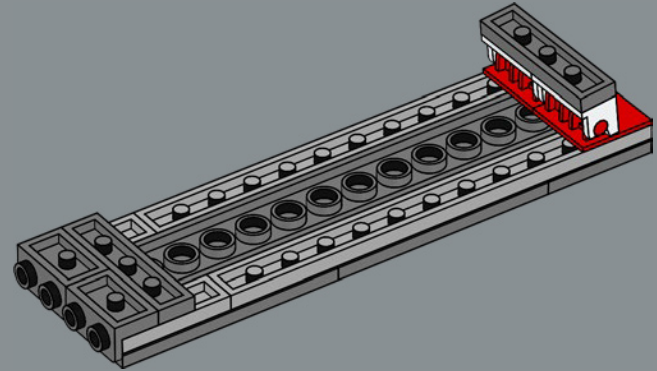

318

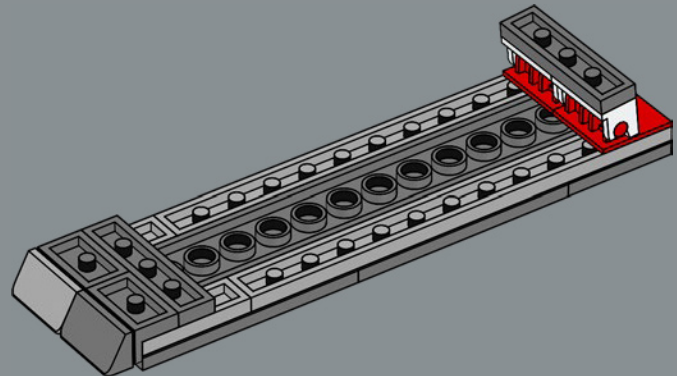

319

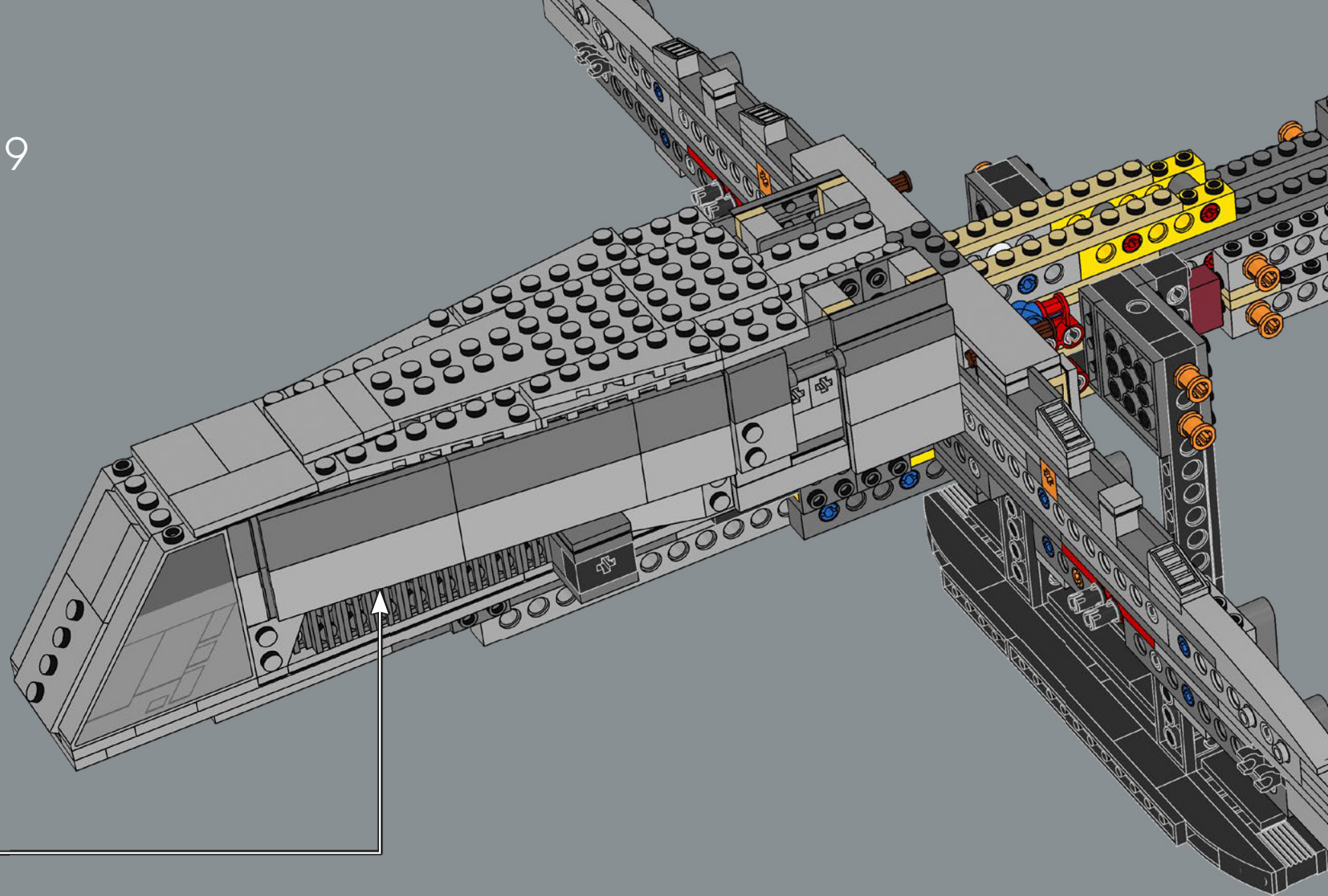

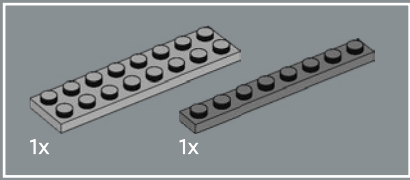

320

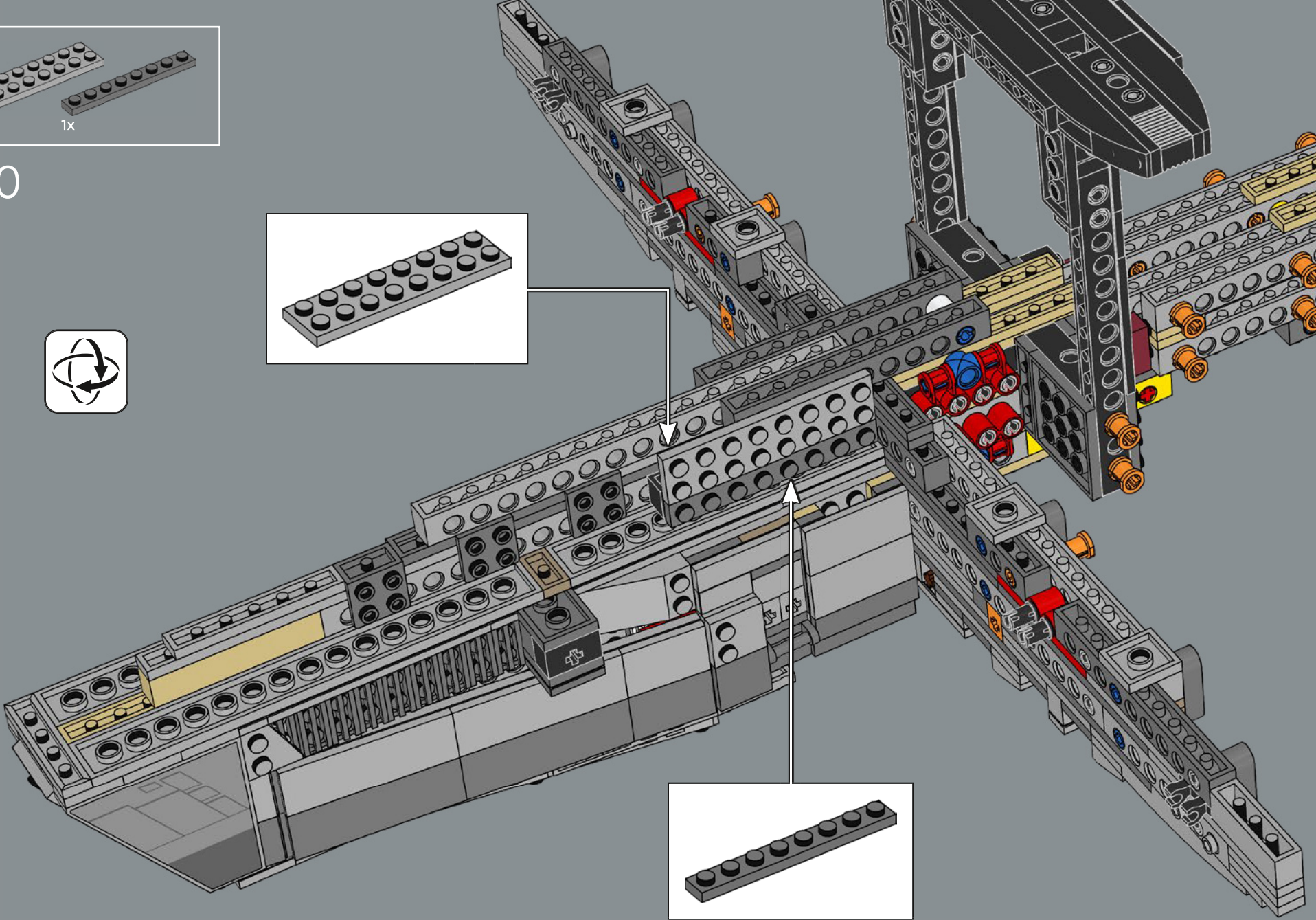
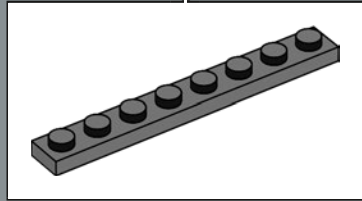
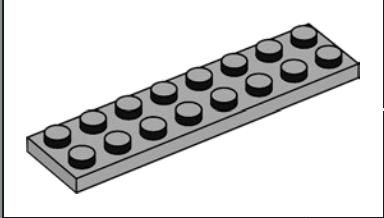

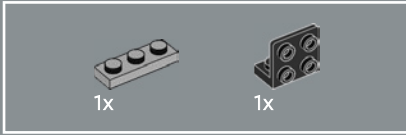
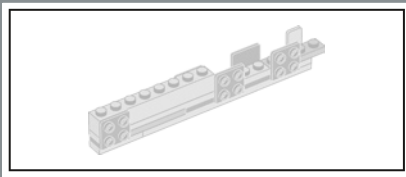

321

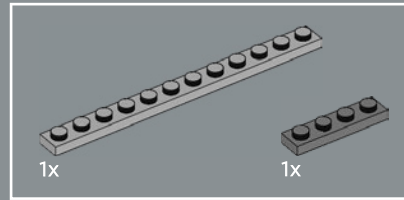
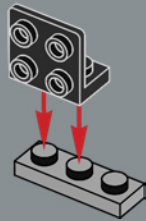

322

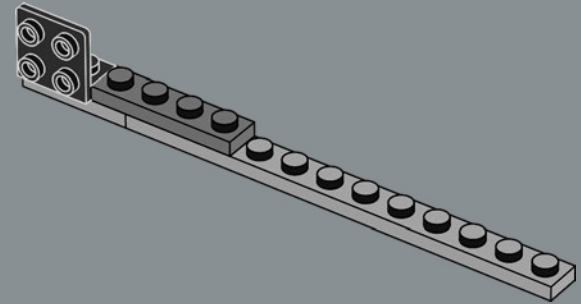

323

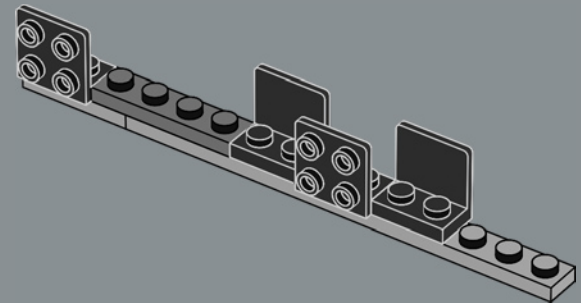

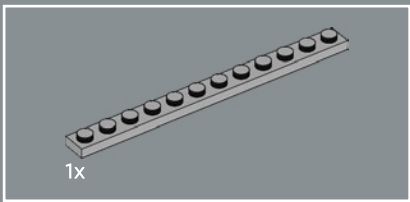

324

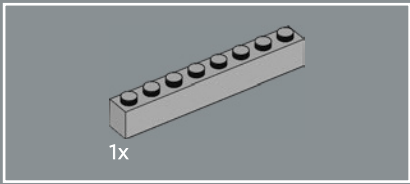
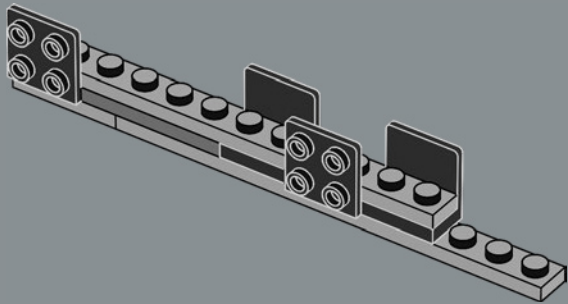

325

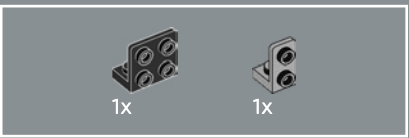
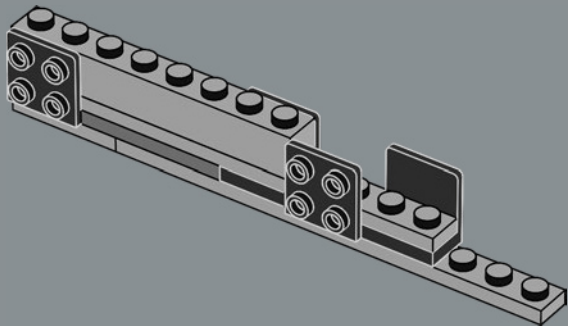

326

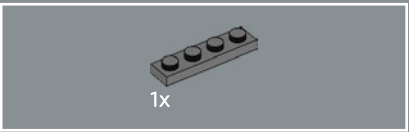
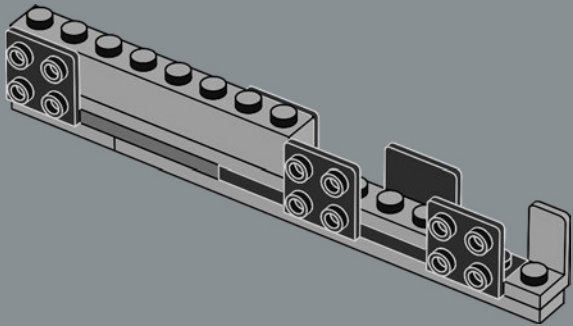

327

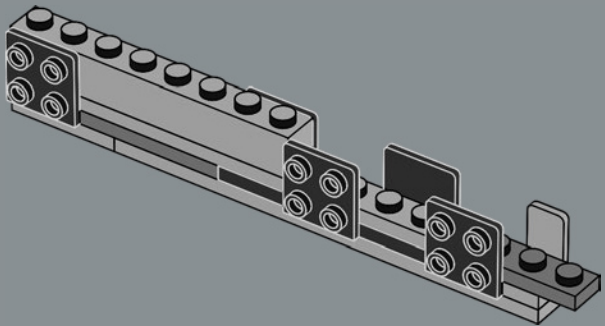

328

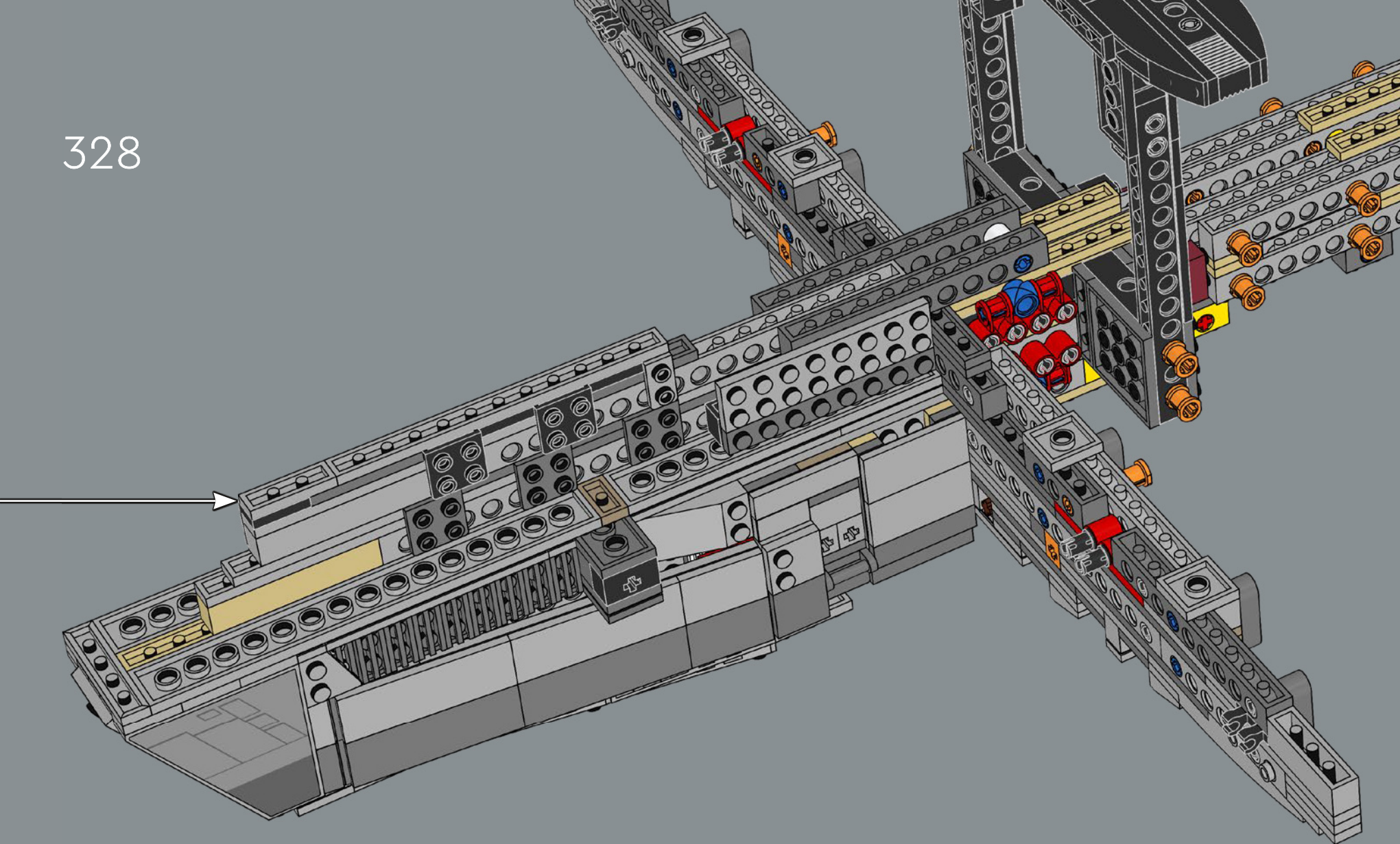

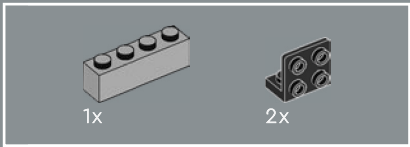

329

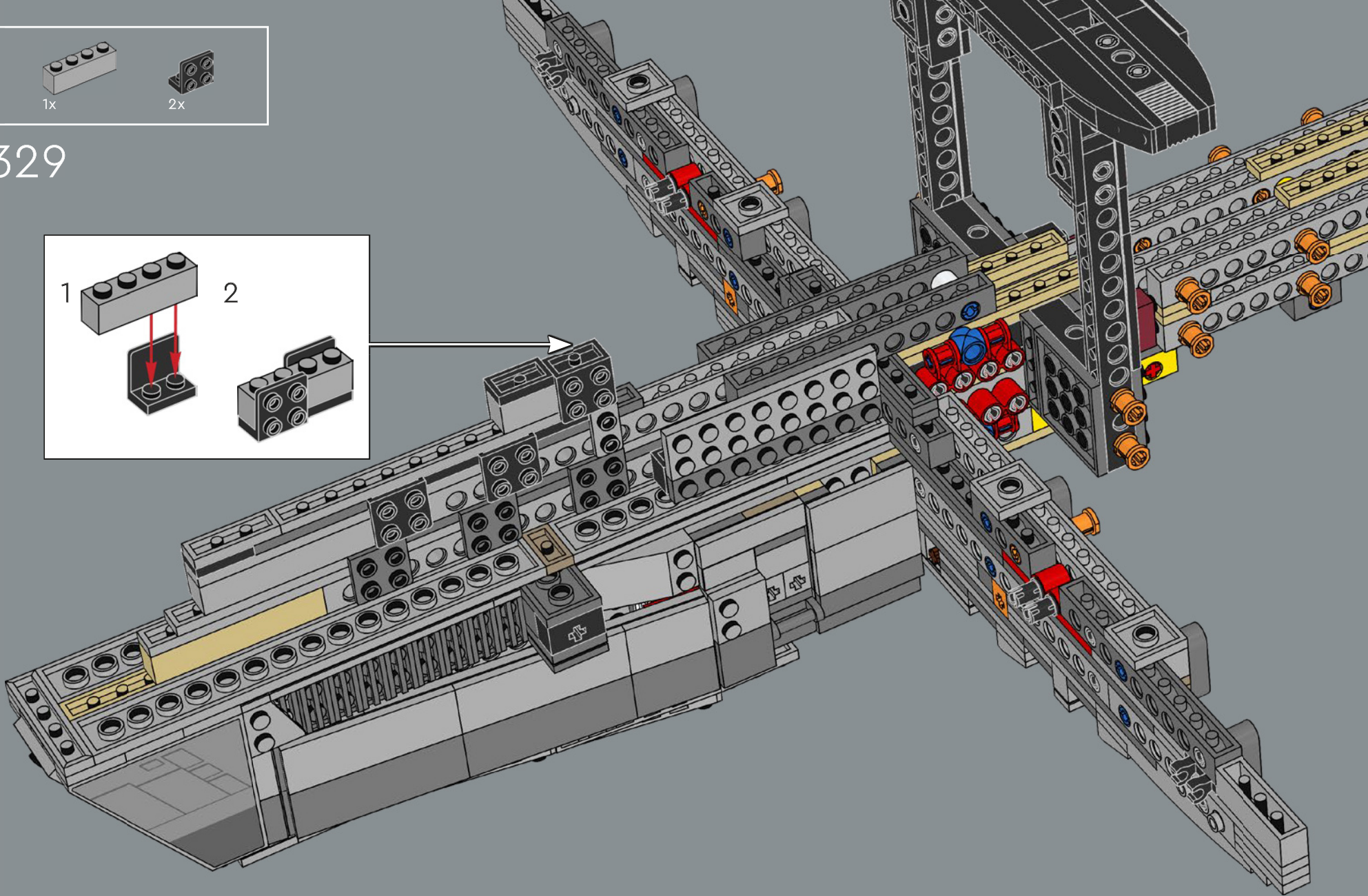
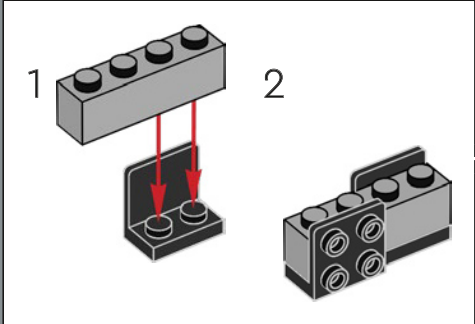



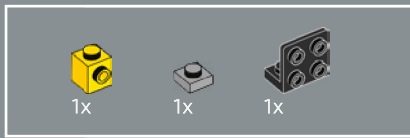

330

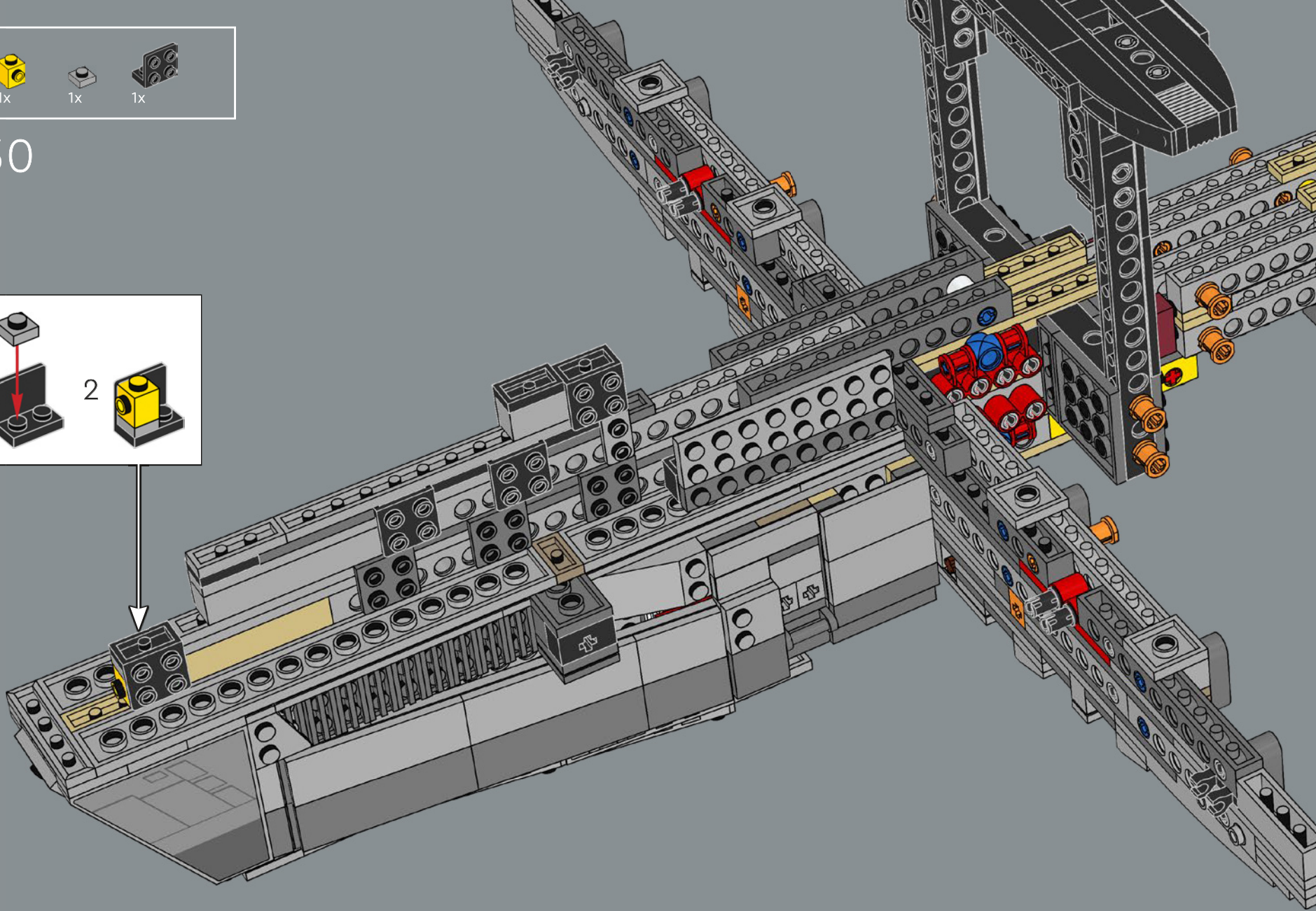
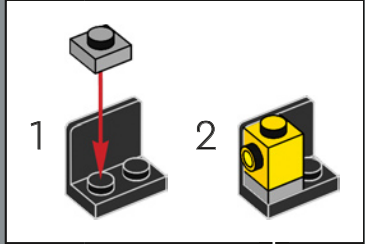

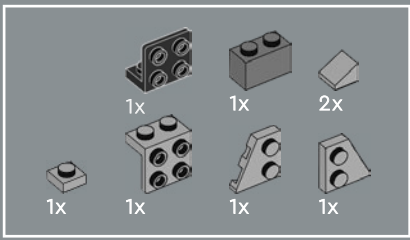

# 331

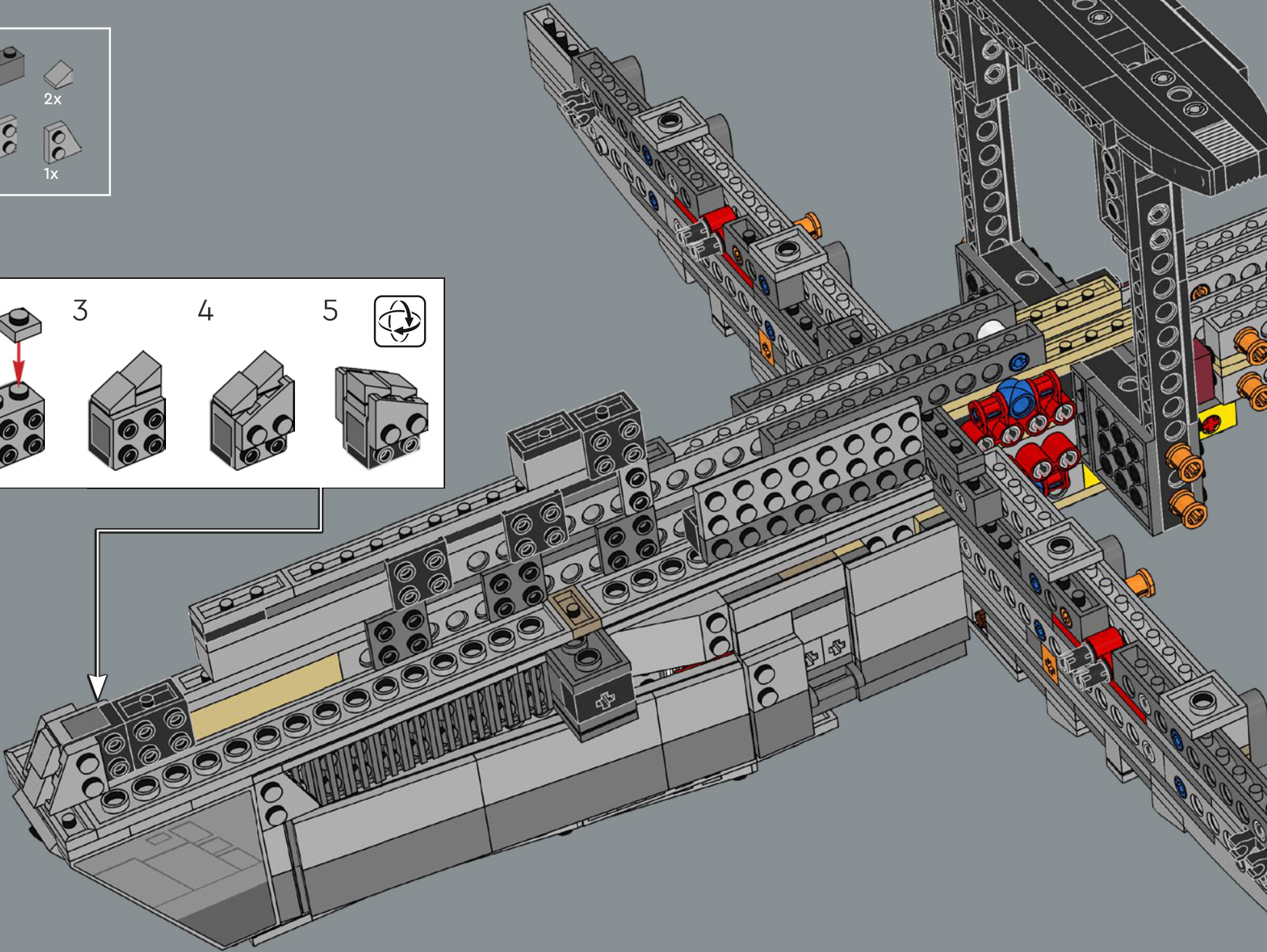
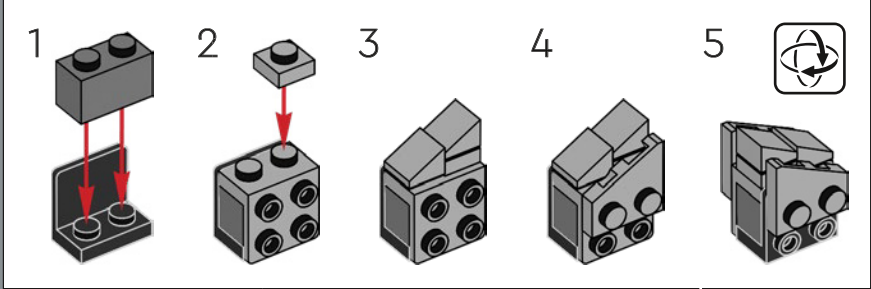



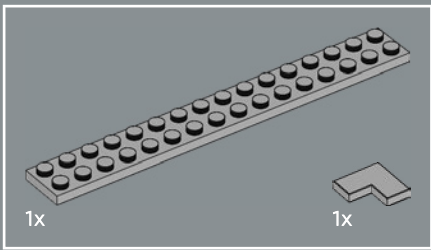

333

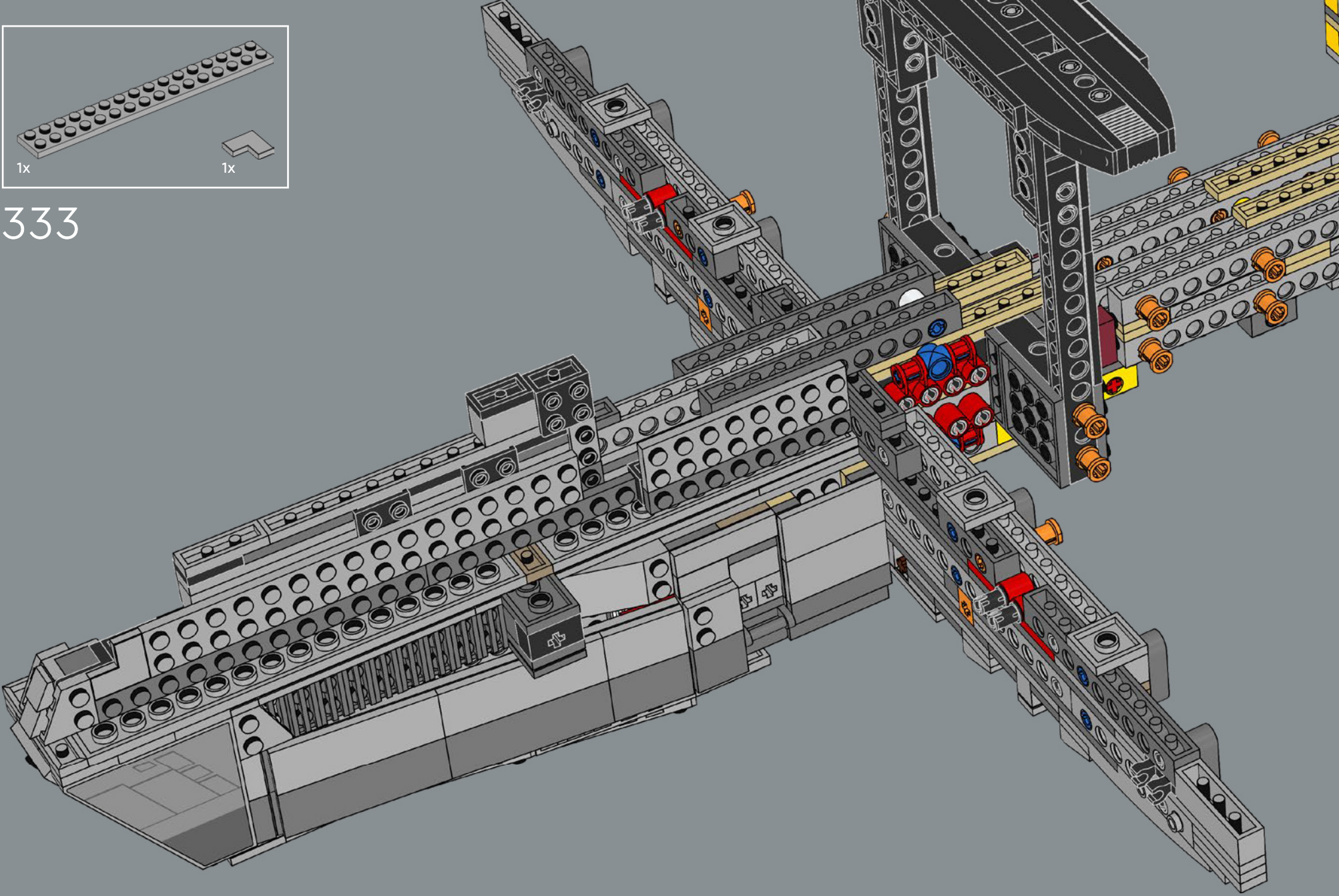

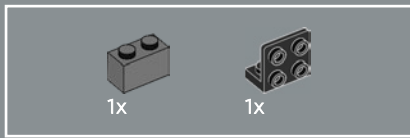

334

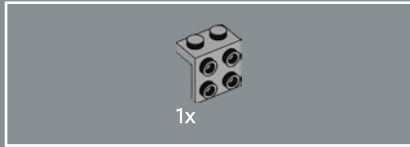
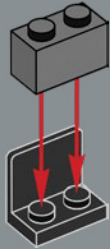

335

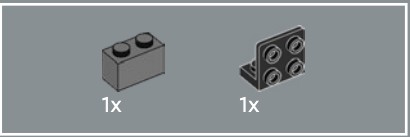
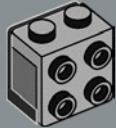

336

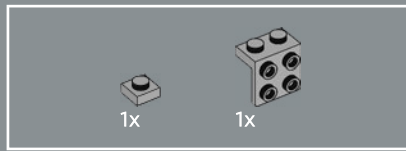
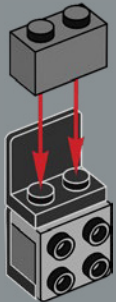

337

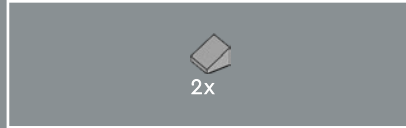

338

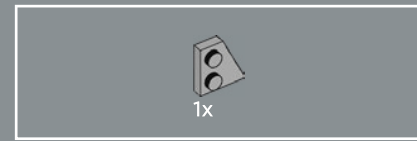
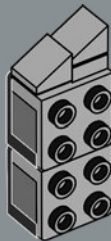

339

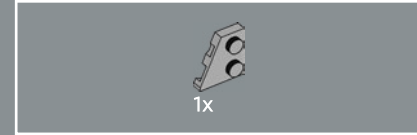
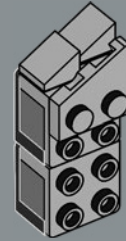

340



341

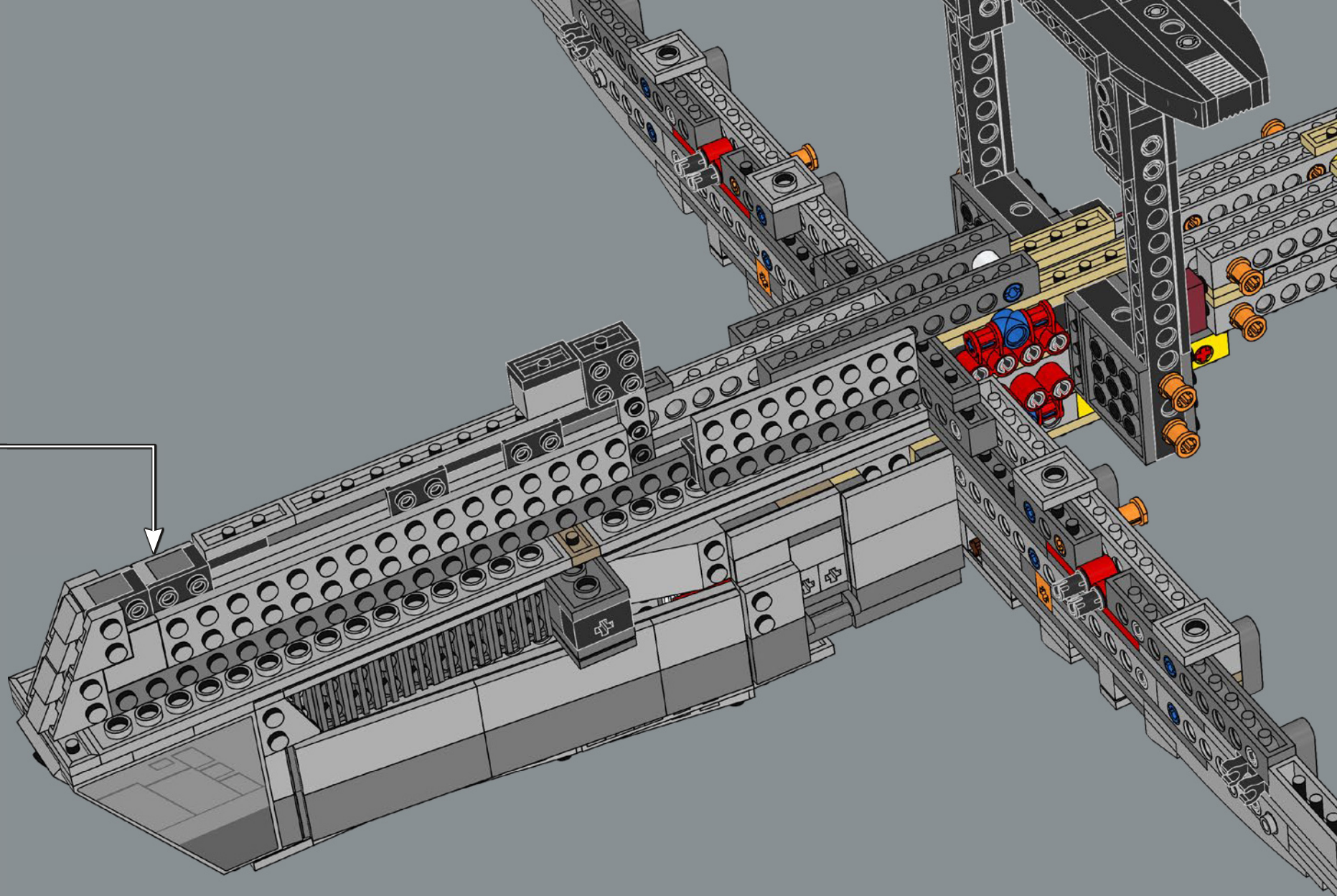

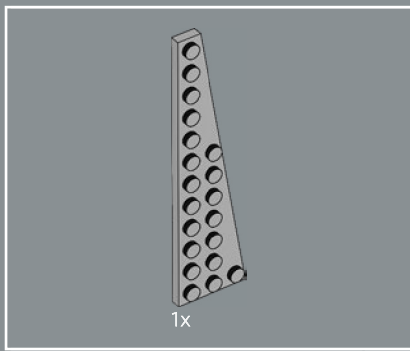

342

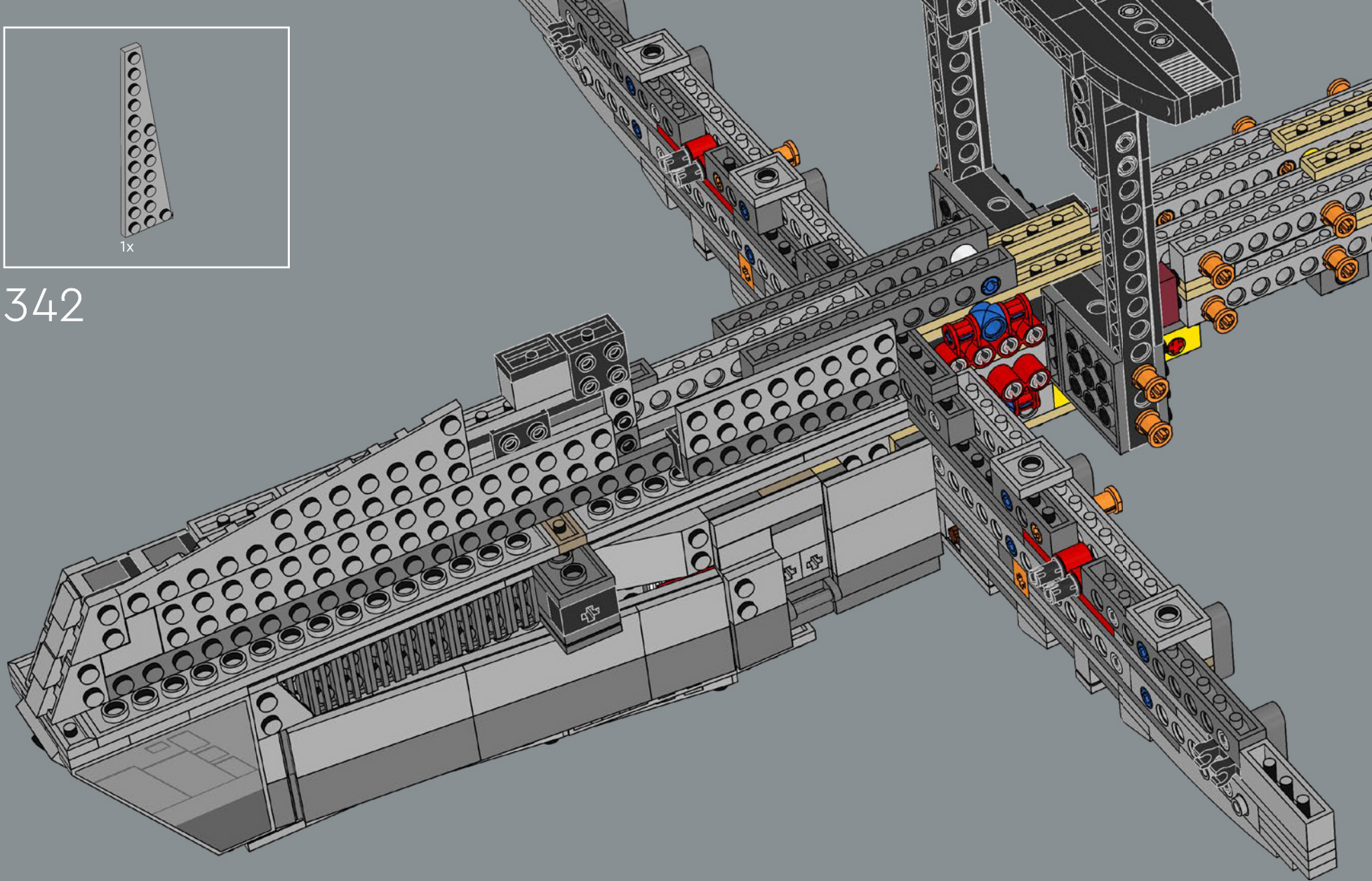

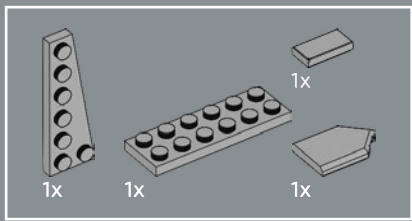

343

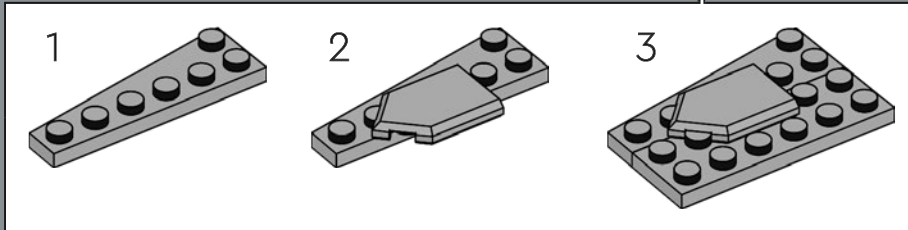
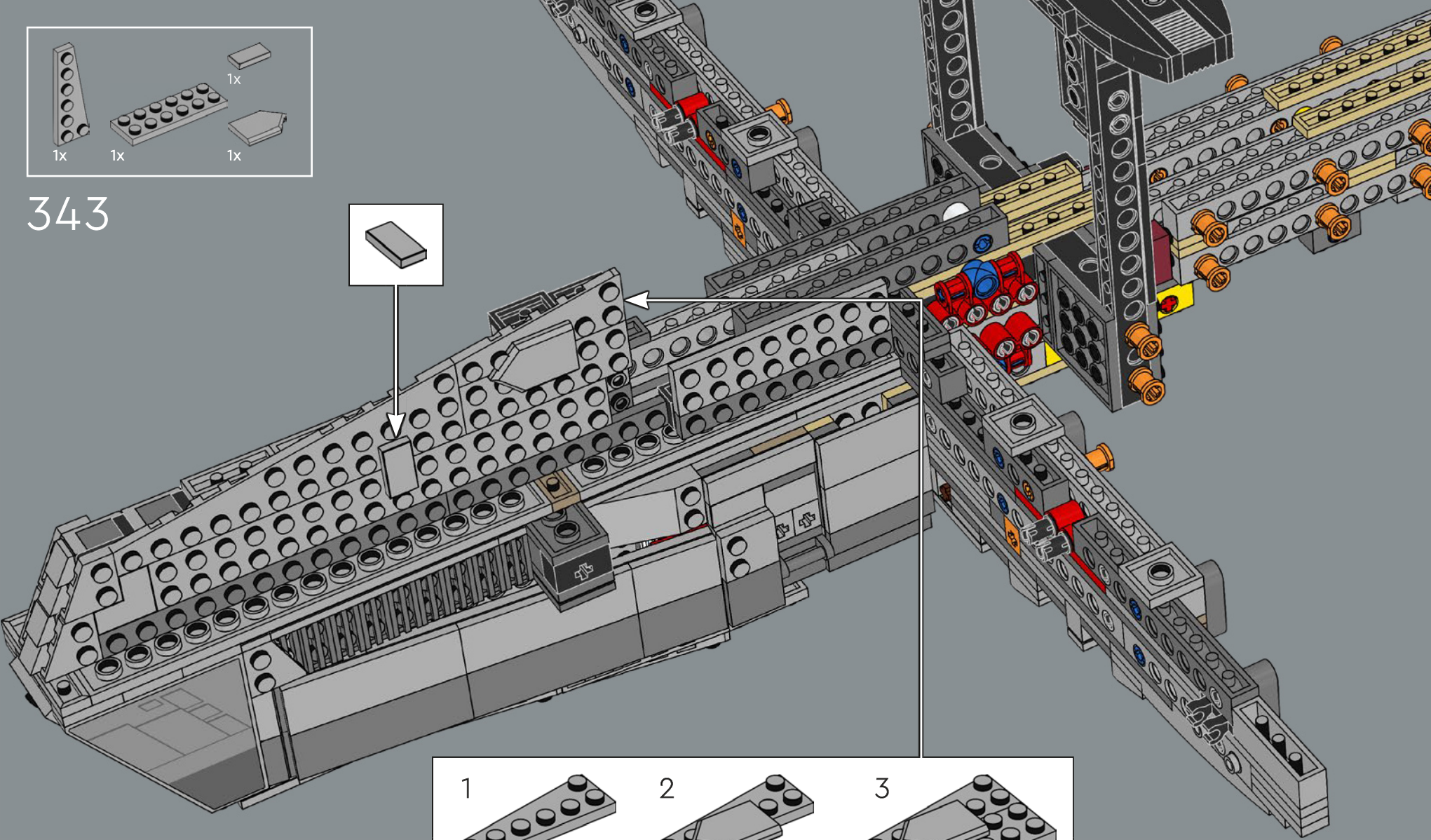



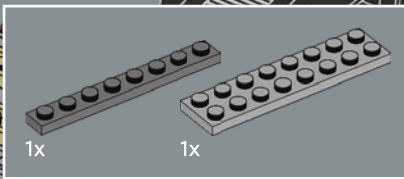

344

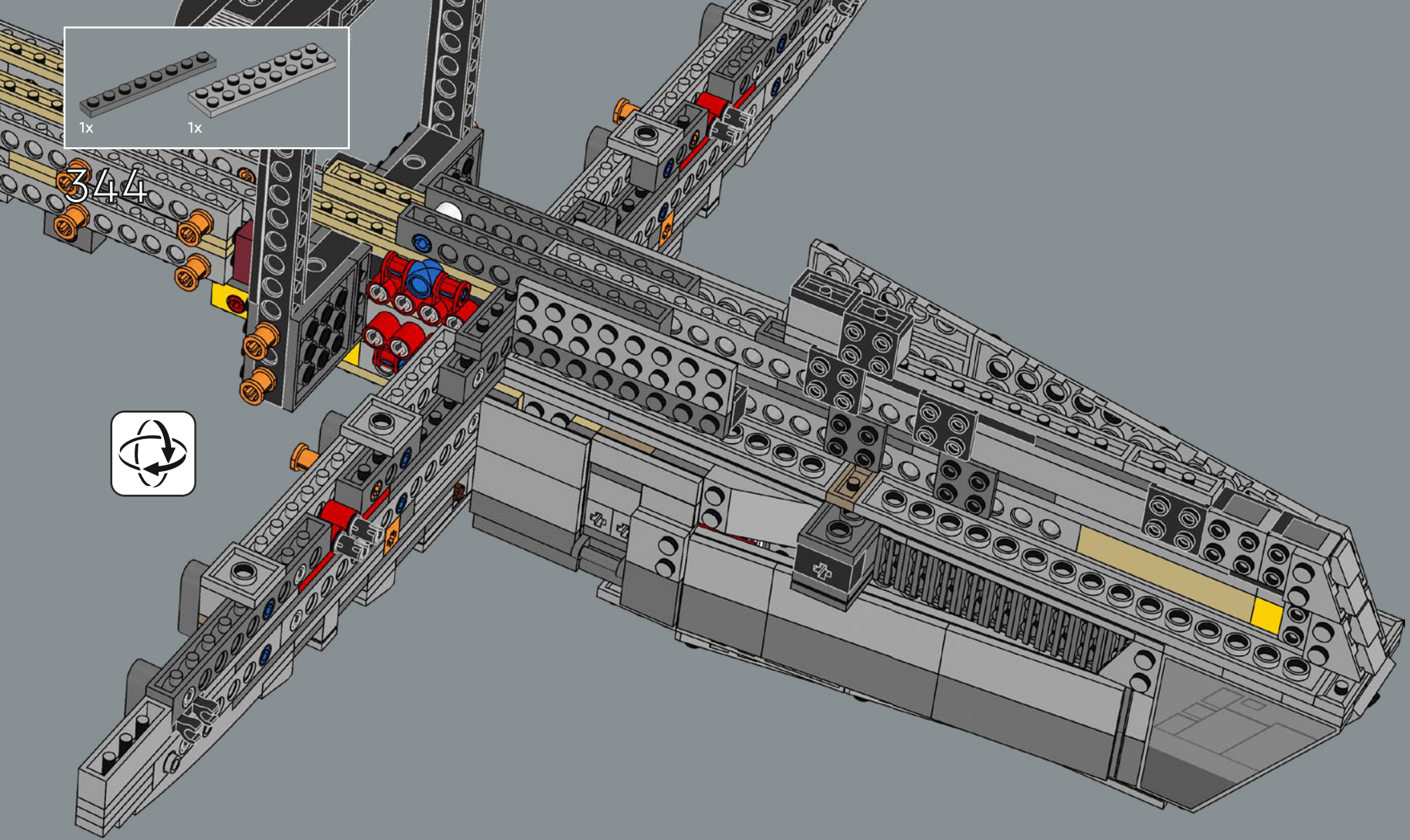

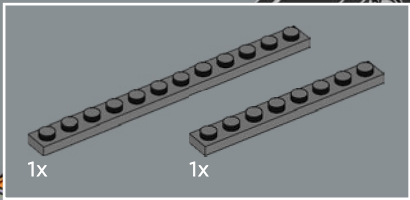

345

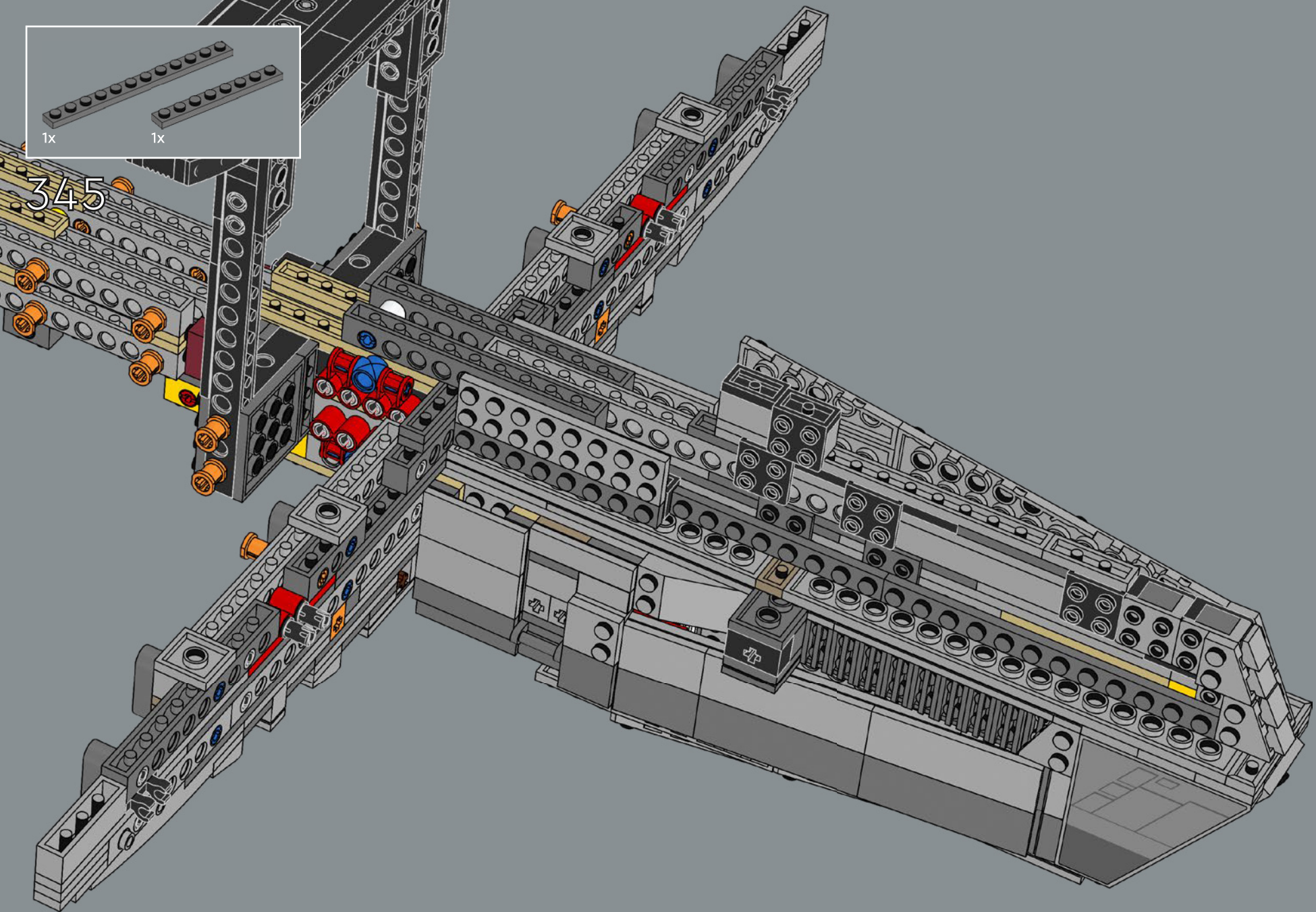

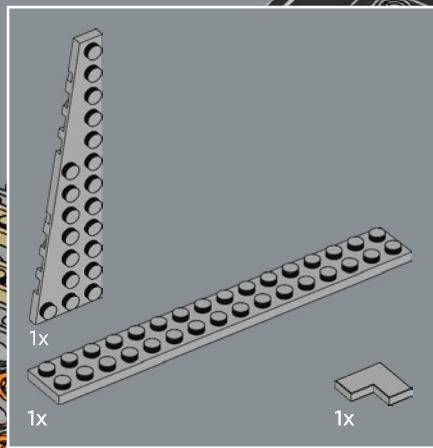

346

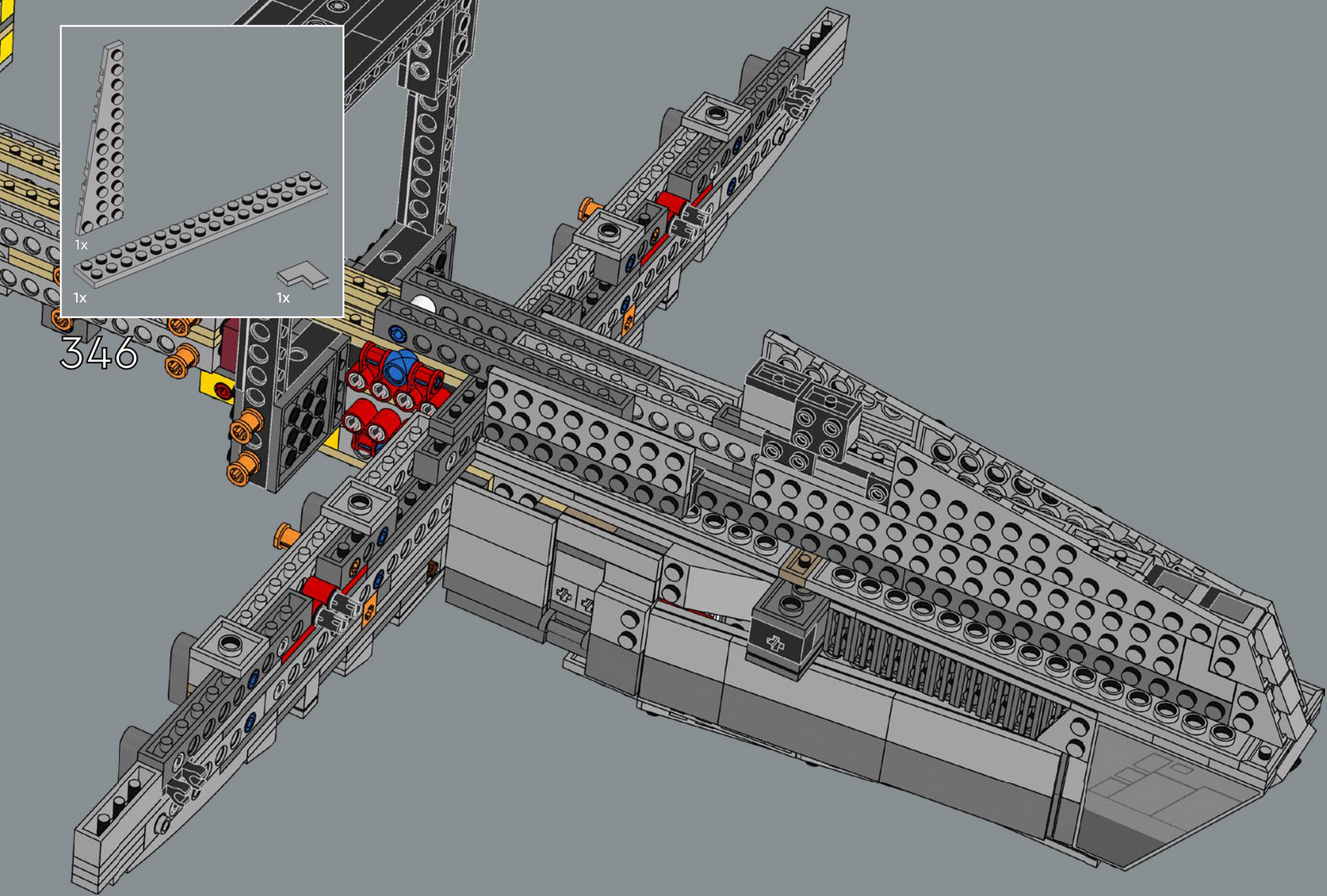

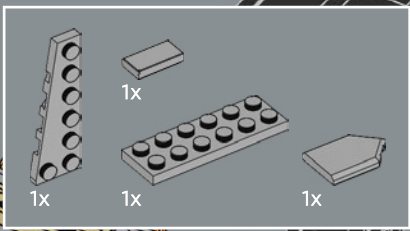

347

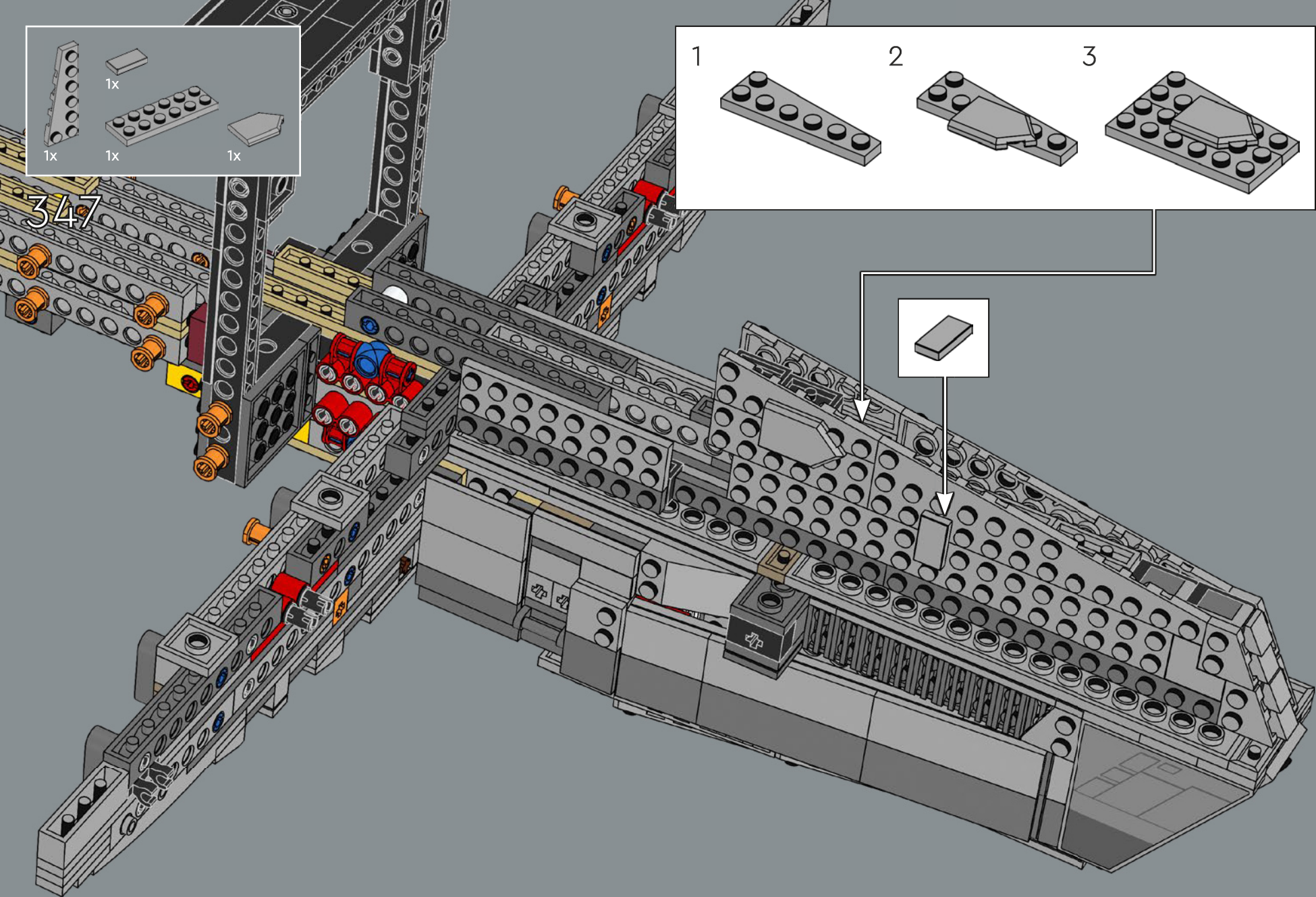
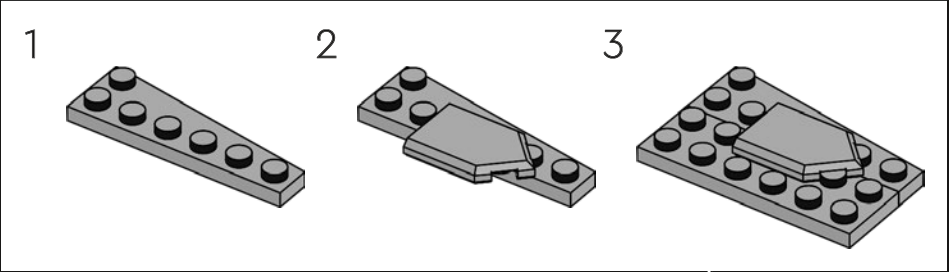

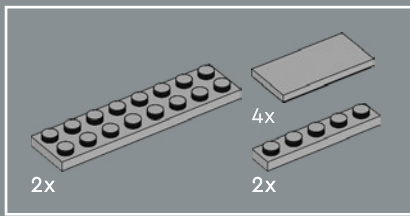

348

1

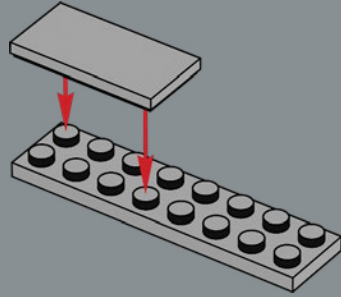

2

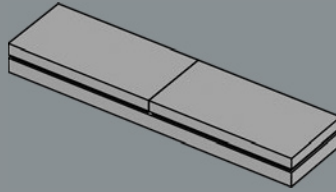

3

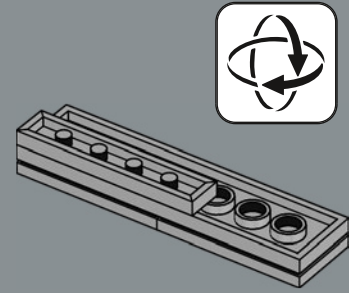

1

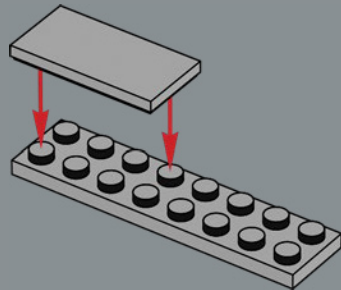

2

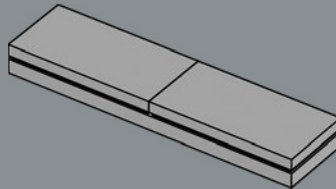

3

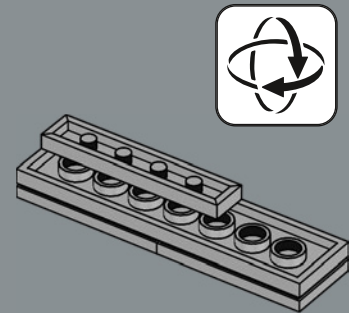

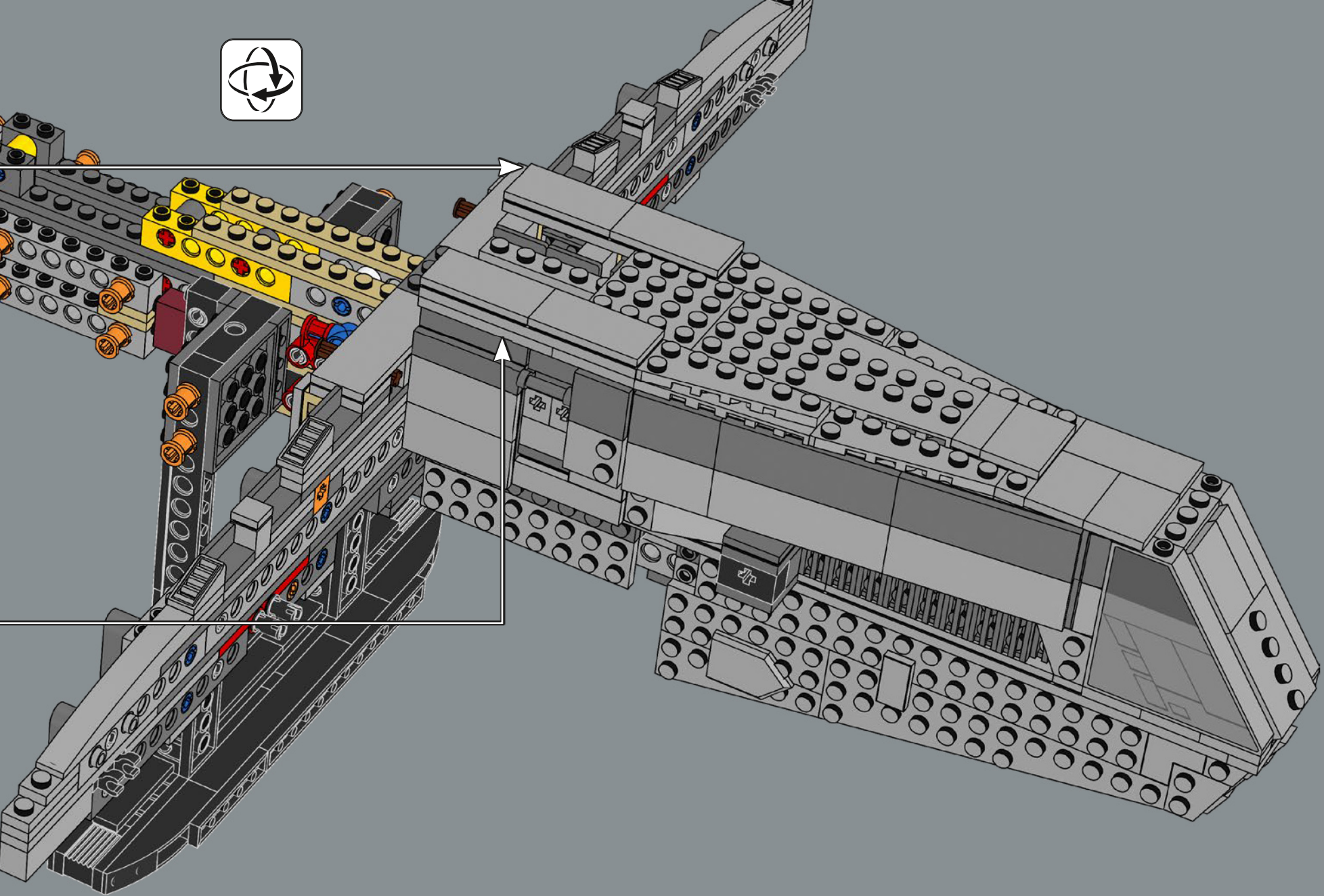

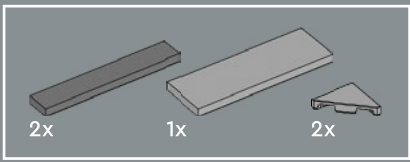

349

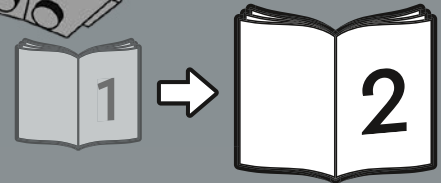
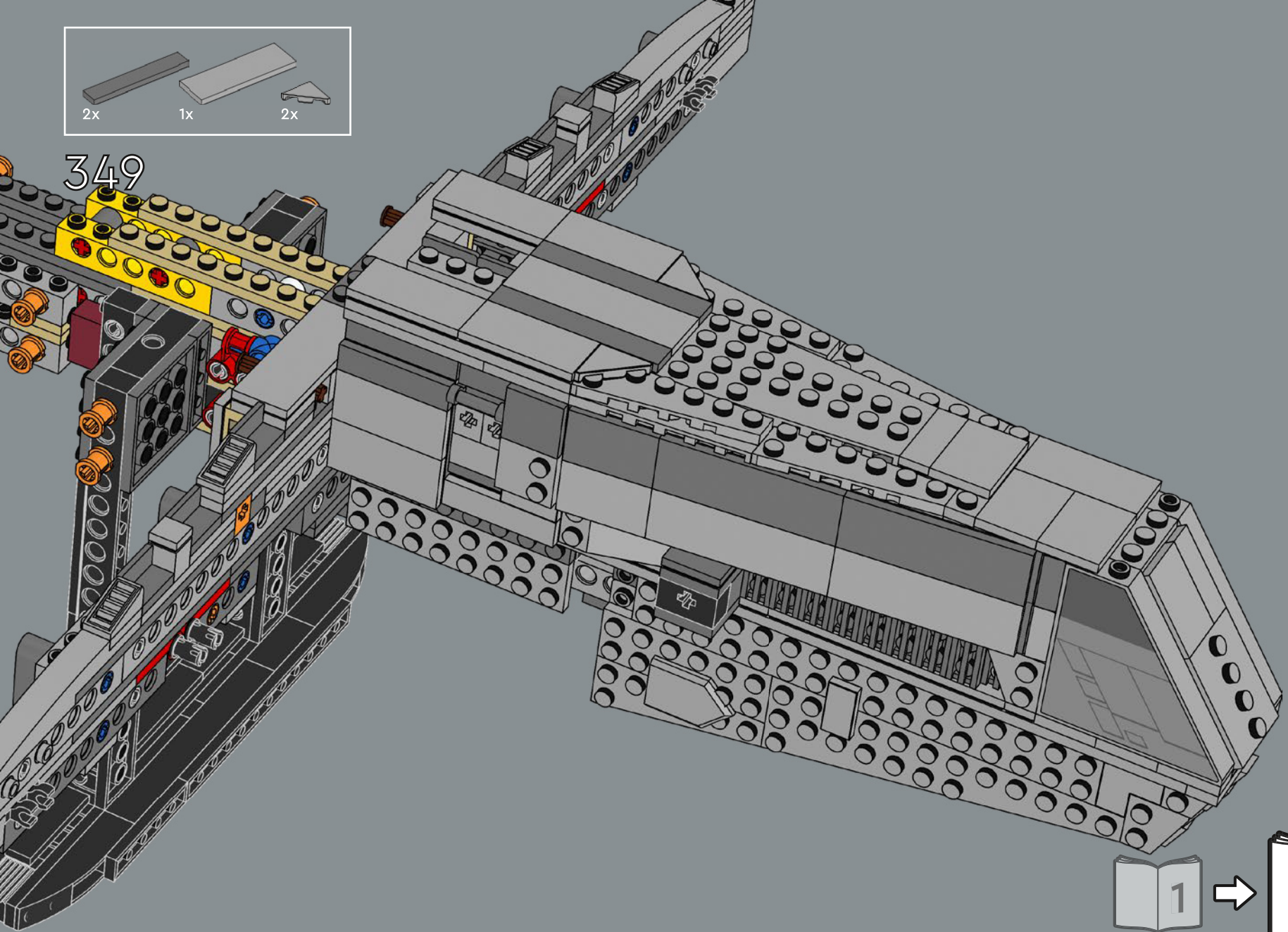

**STAR  
WARS™**